



2 CM FLAK 38



WARNING: CHOKING HAZARD-

Toy contains small parts.

Not for children under 3 years.

Printed in EU



1

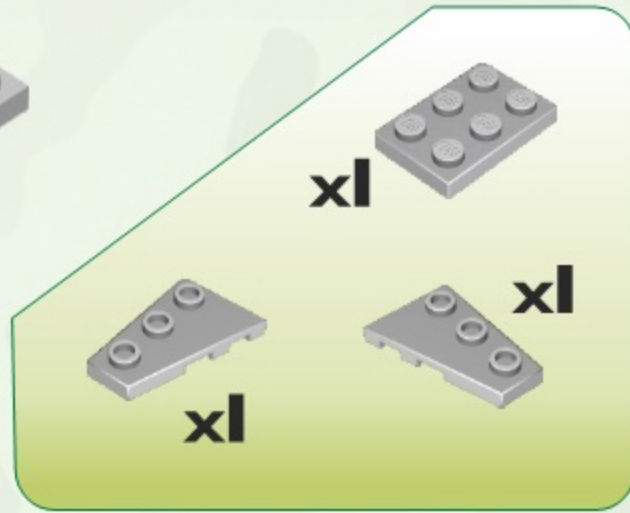

2

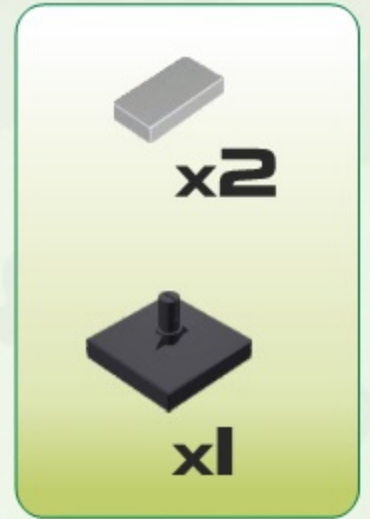

3

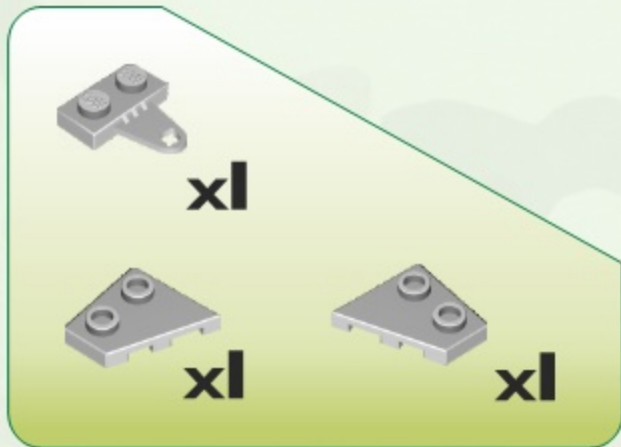
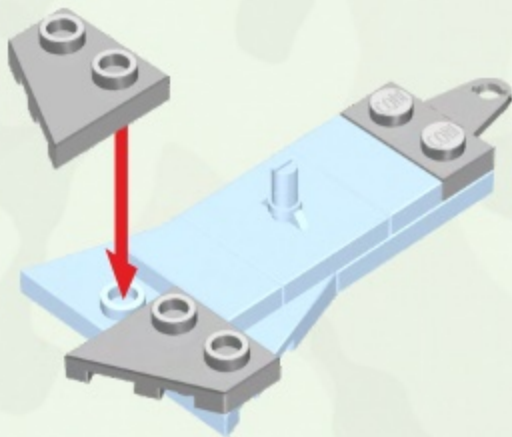

4

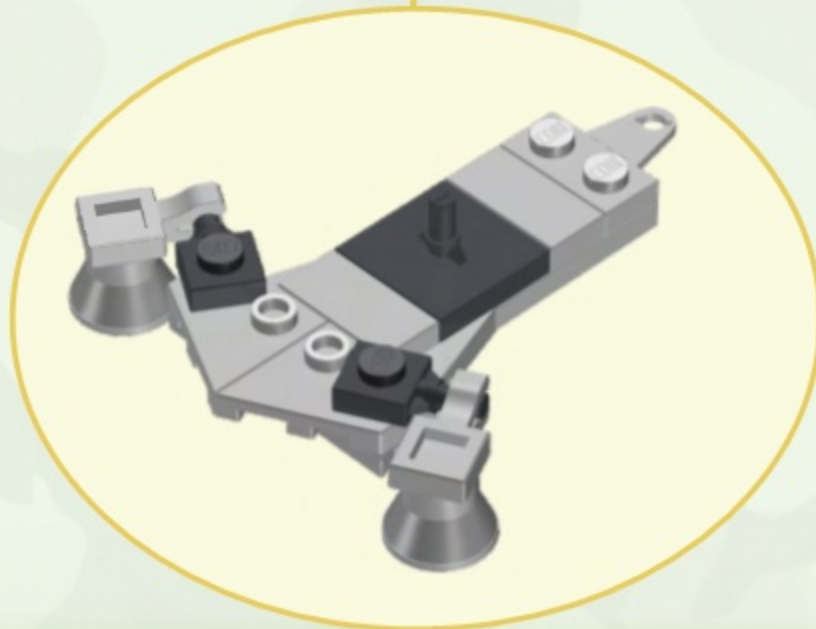
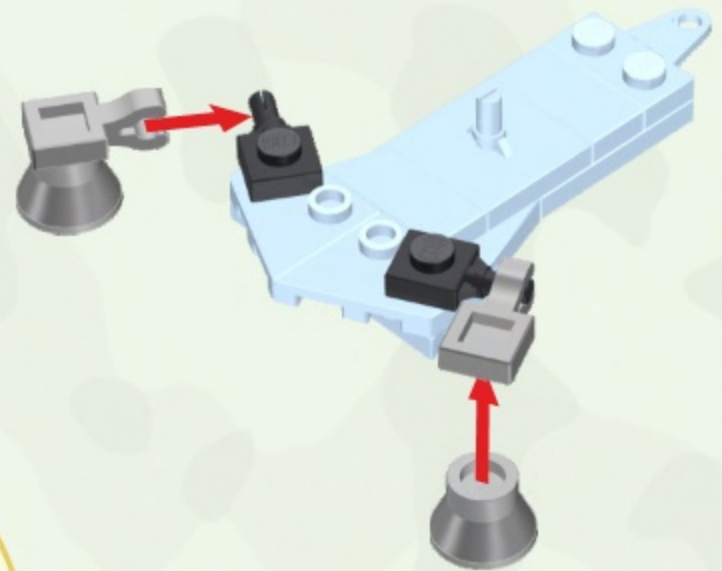

5

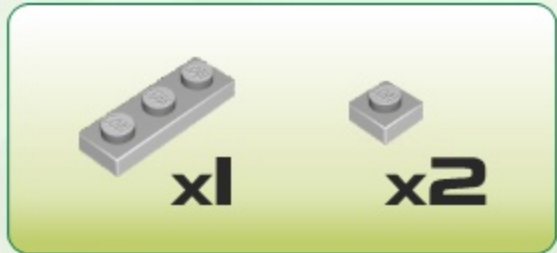

6

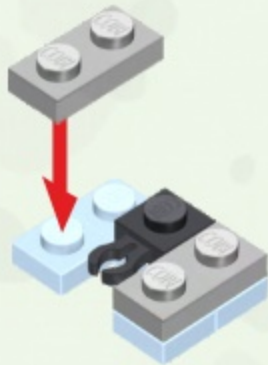

7

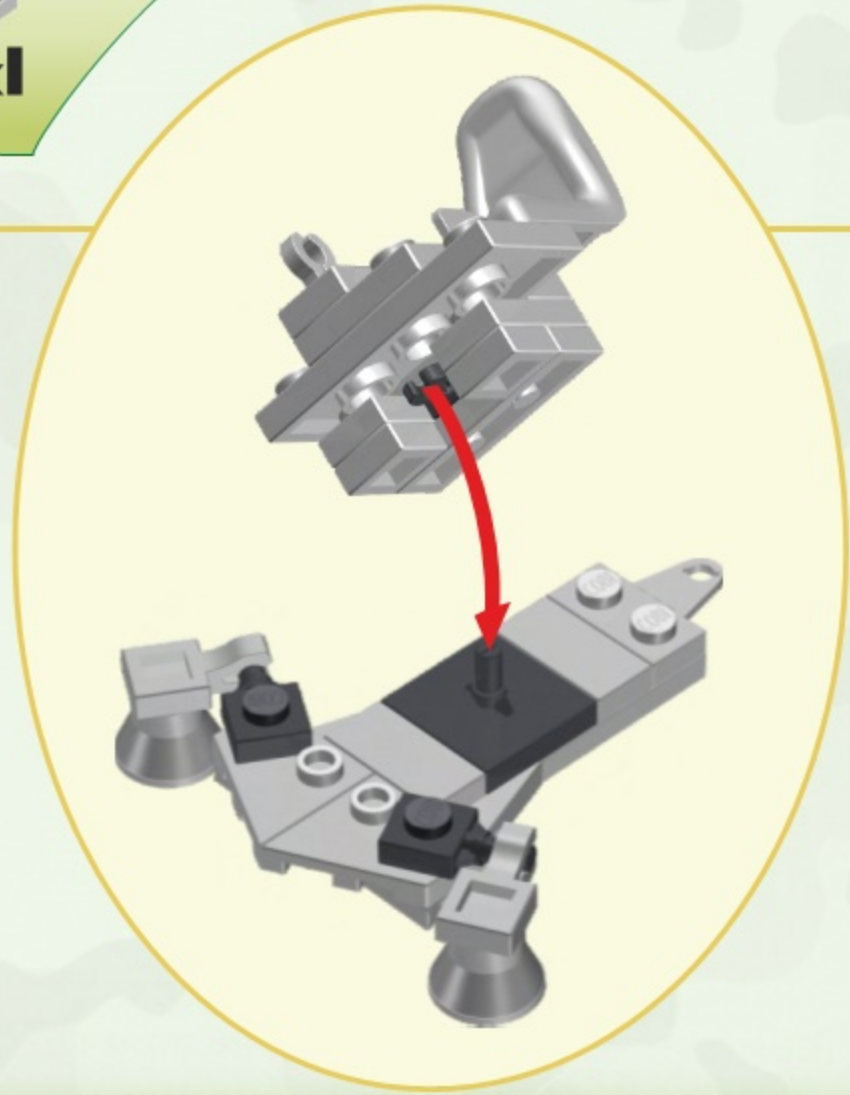
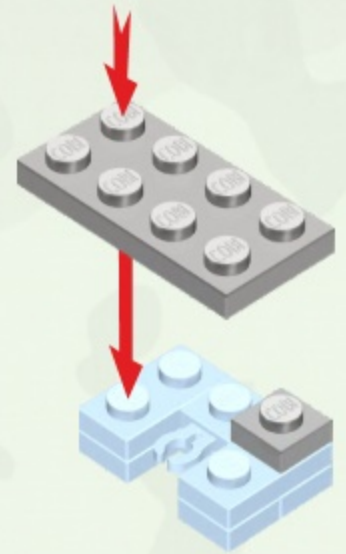
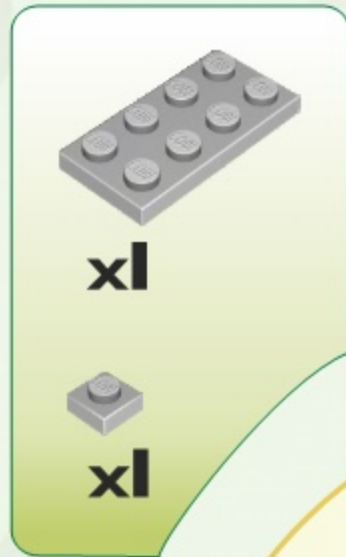

8

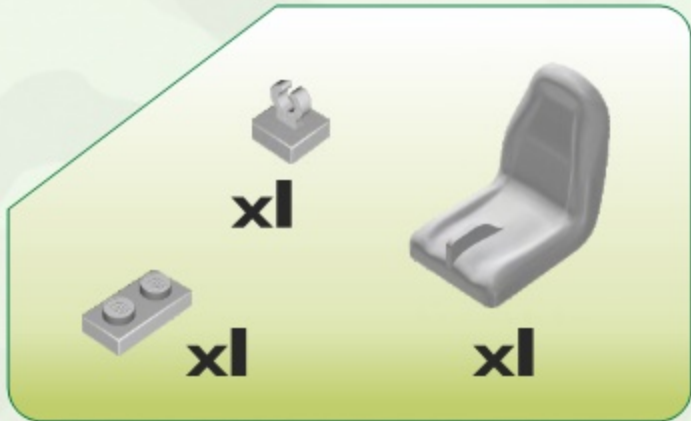

9

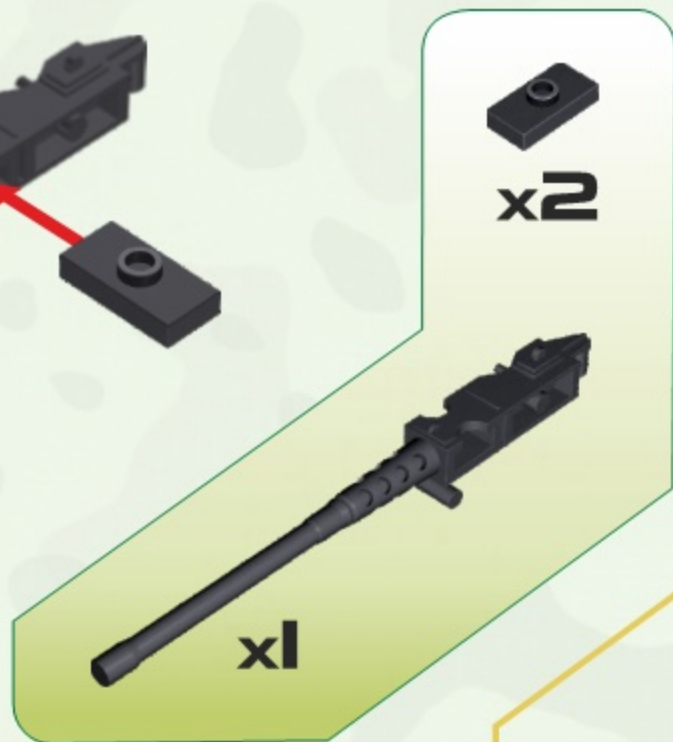
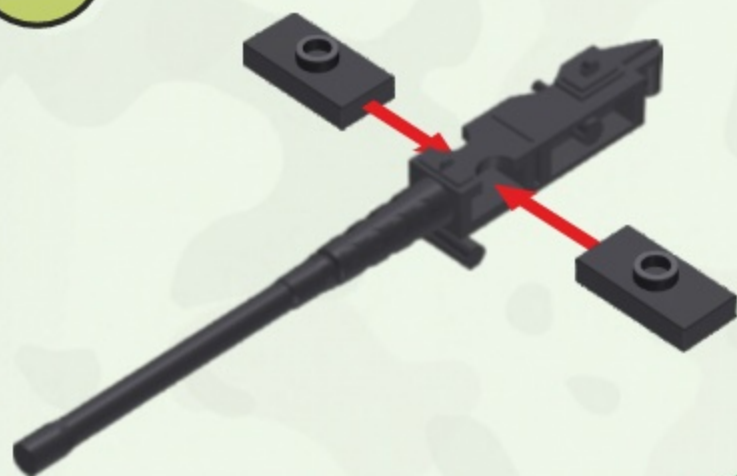

10

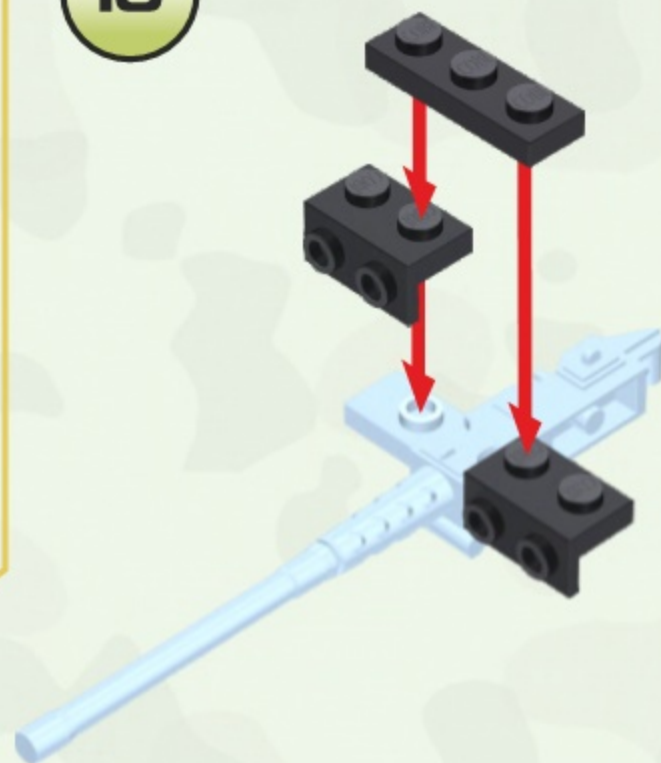

11

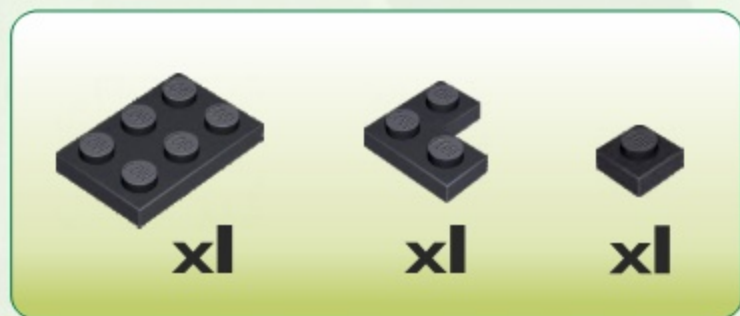

12

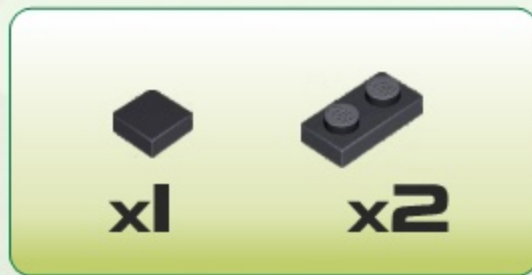
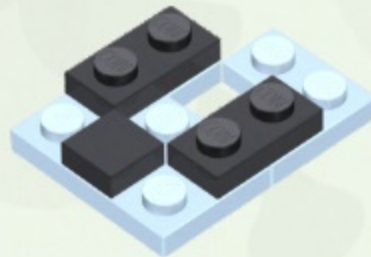

13

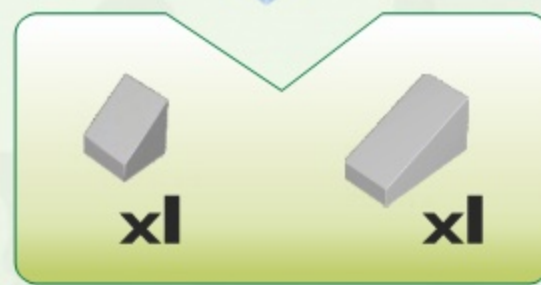
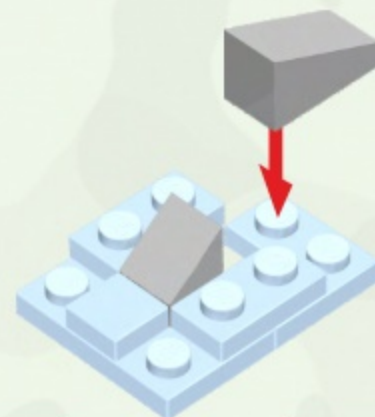

14



16

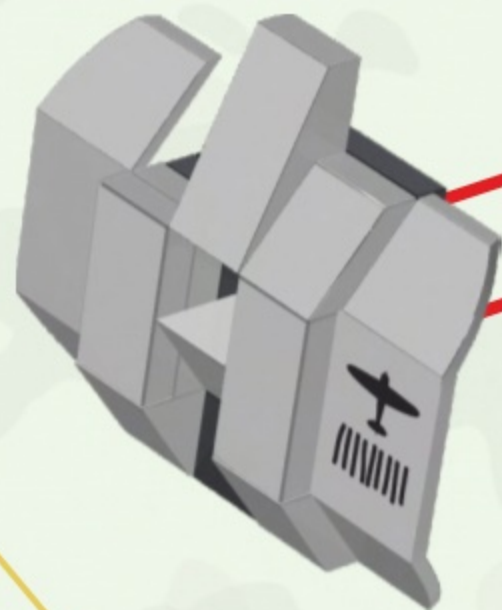

15

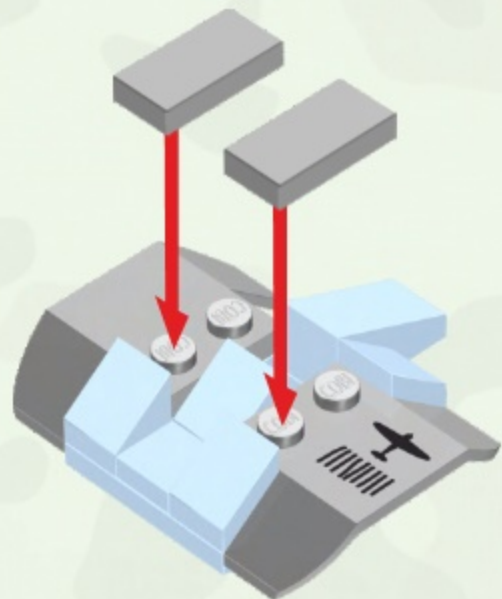

17

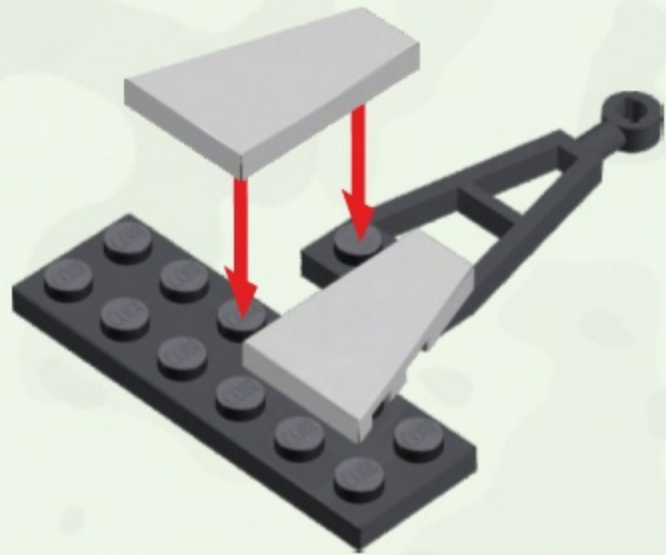

18

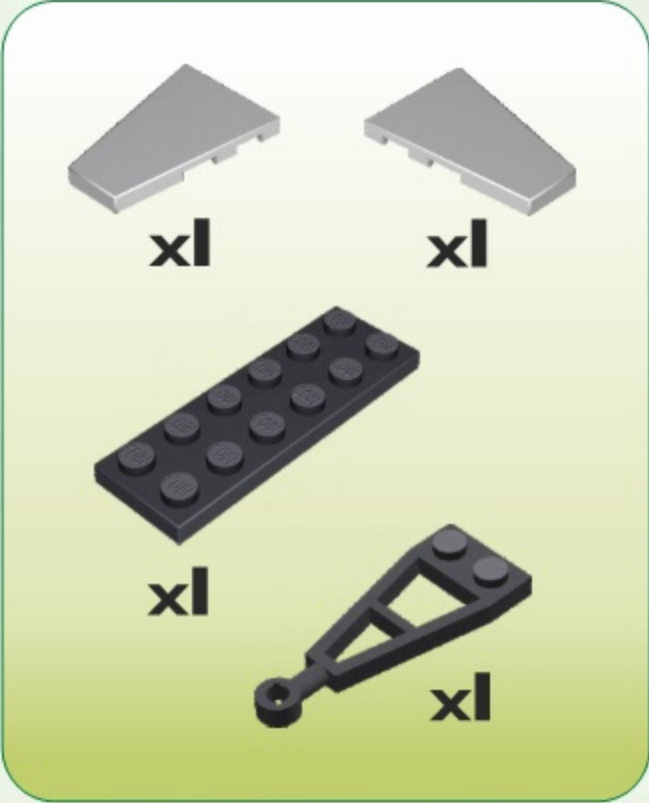
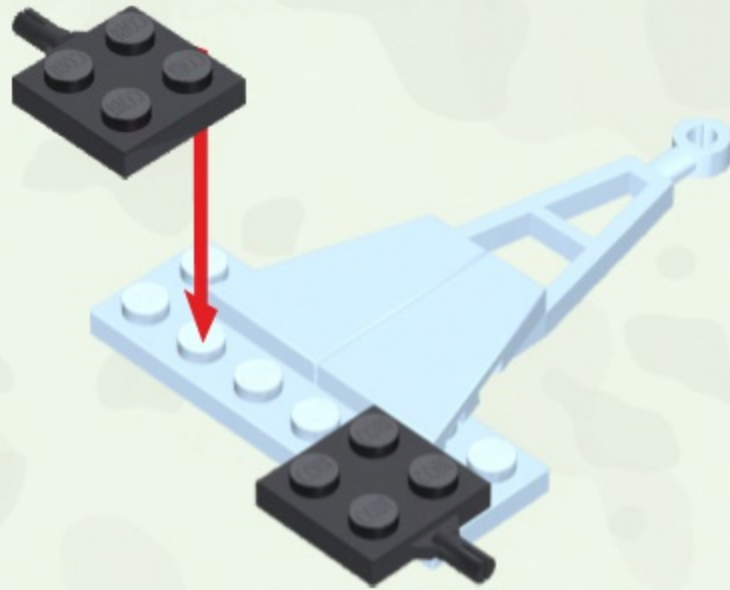

19

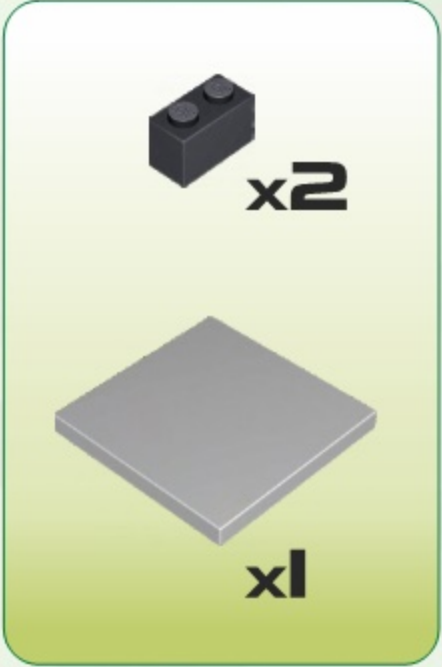
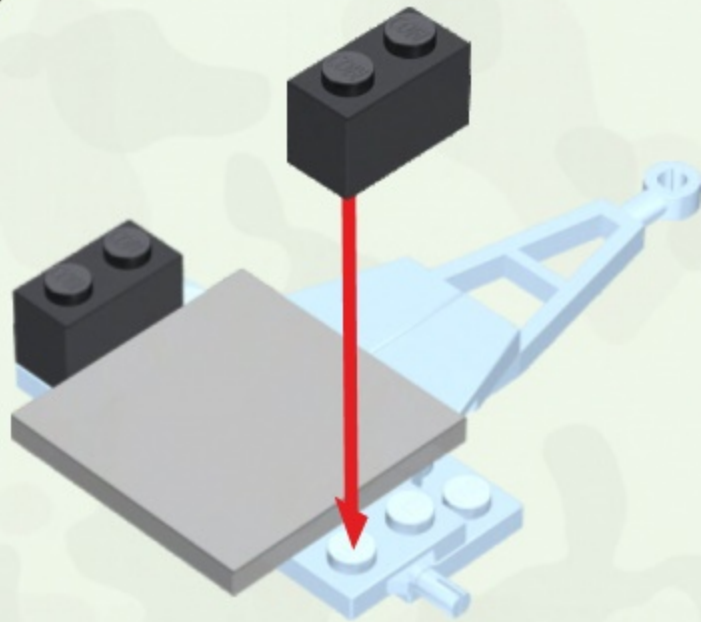

20

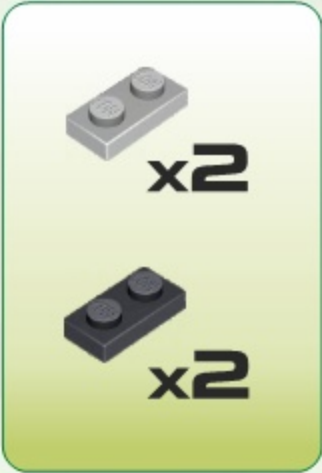
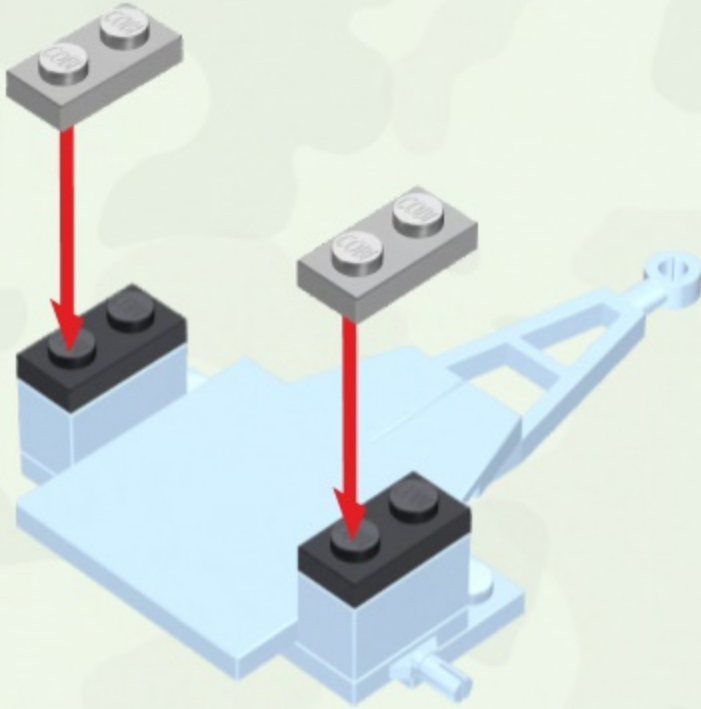

21

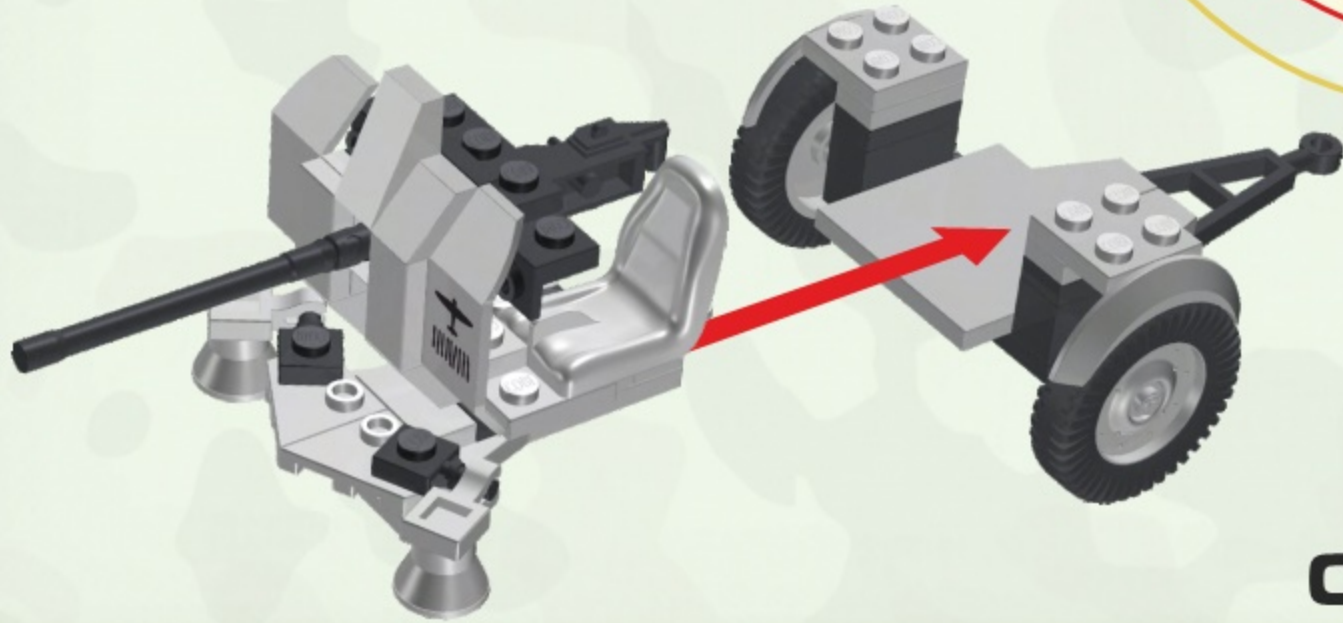
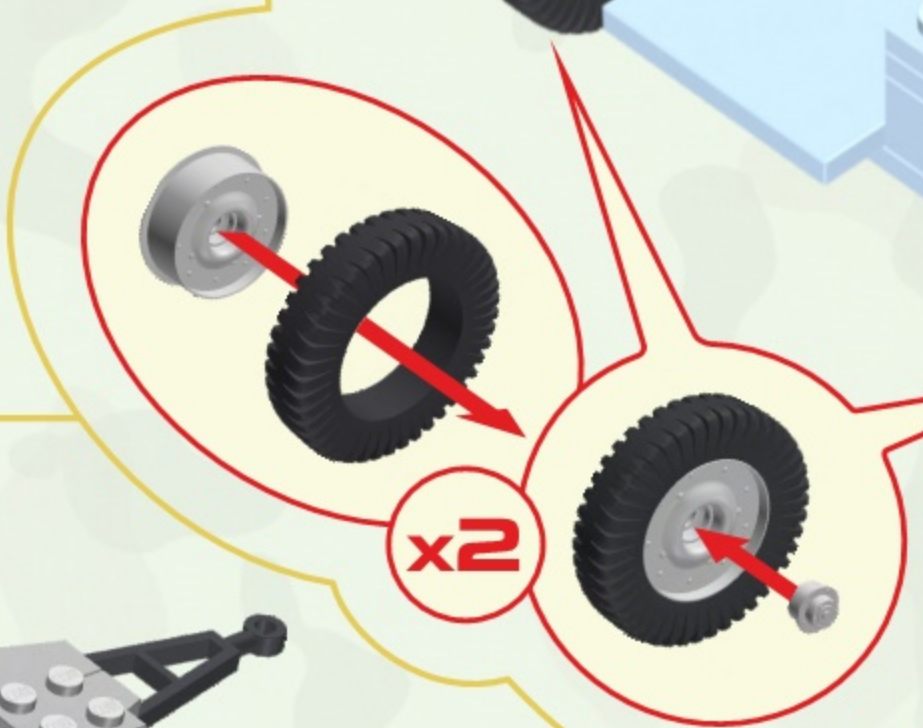
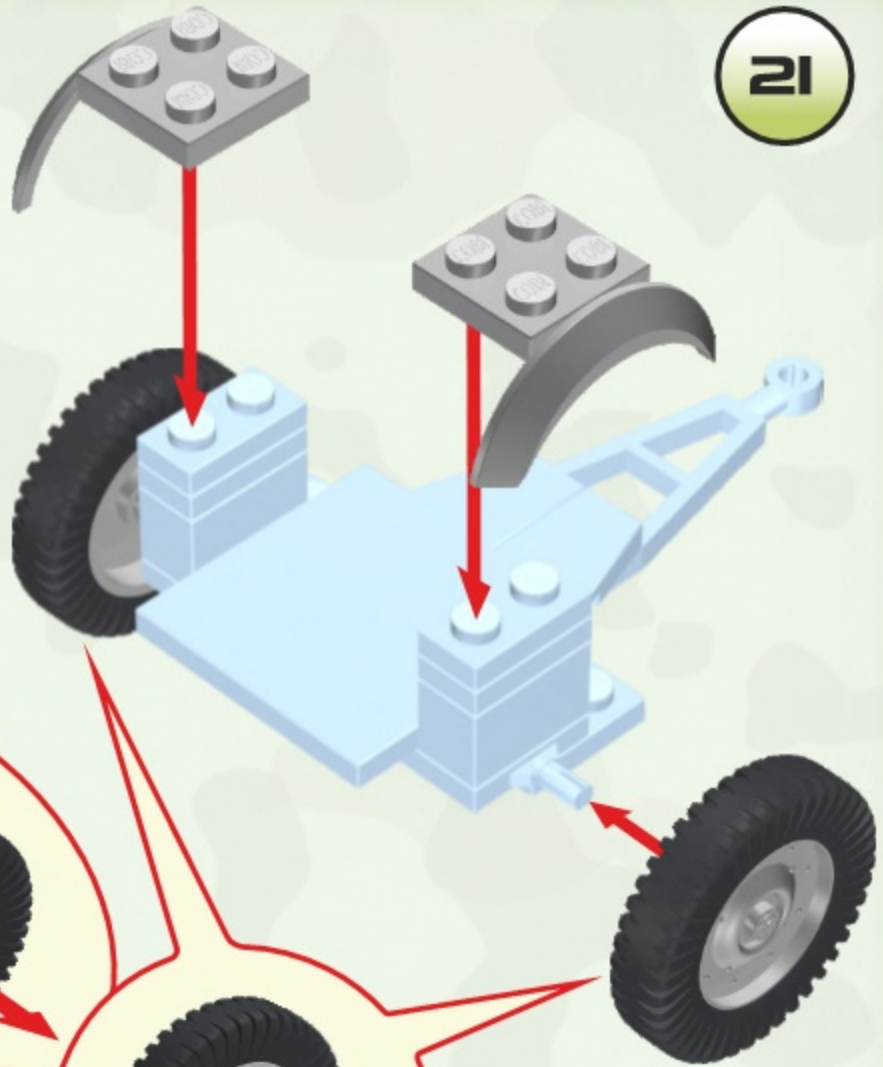

03-02181-68



KATYUSKA BM-13N
2448



OPEL BLITZ 3+ (4X2)
2449



3,7 CM PAK 36
2180



PANZER III TANK AUSF.J
2451



KING TIGER TANK
2460



PzKpFw VI TIGER AUSF.E
2462