



Jeep®

Jeep, the Jeep grille and related logos, vehicle model names and trade dress are trademarks of Chrysler Group LLC and used under license by Cobi.
©2014 Chrysler Group LLC.



Printed in EU



WARNING: CHOKING HAZARD.
Toy contains small parts.
Not for children under 3 years.

1

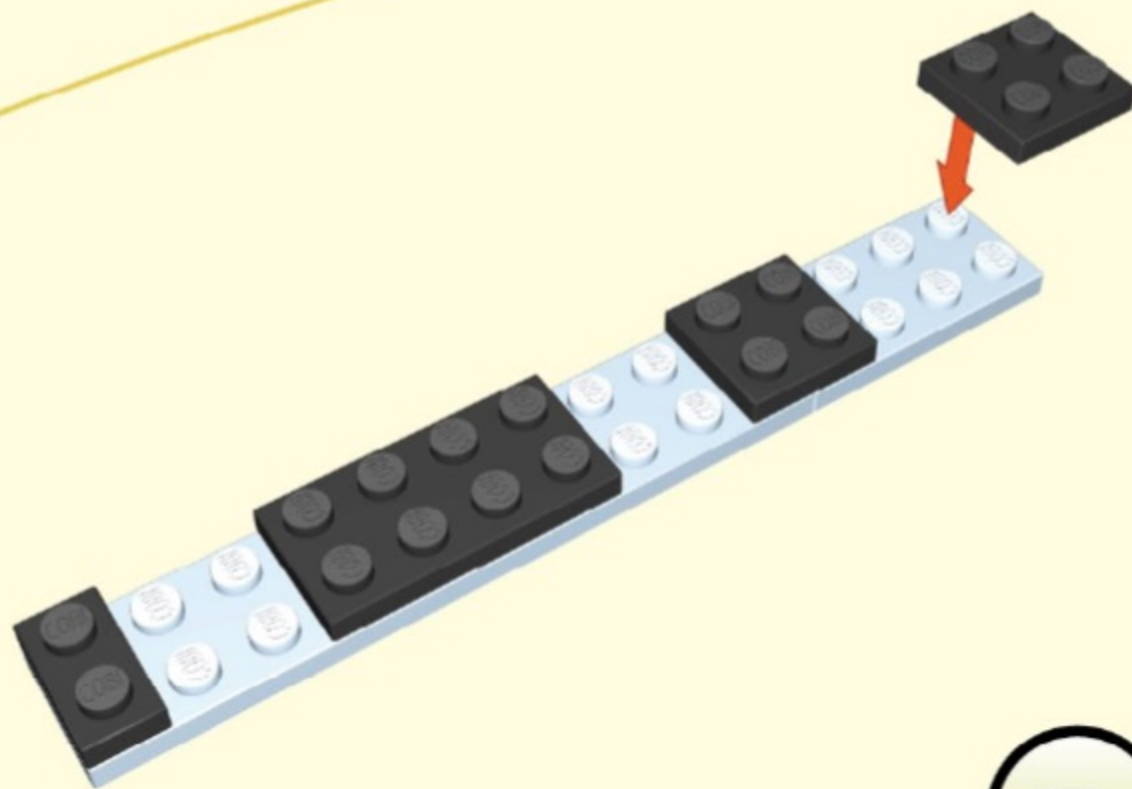
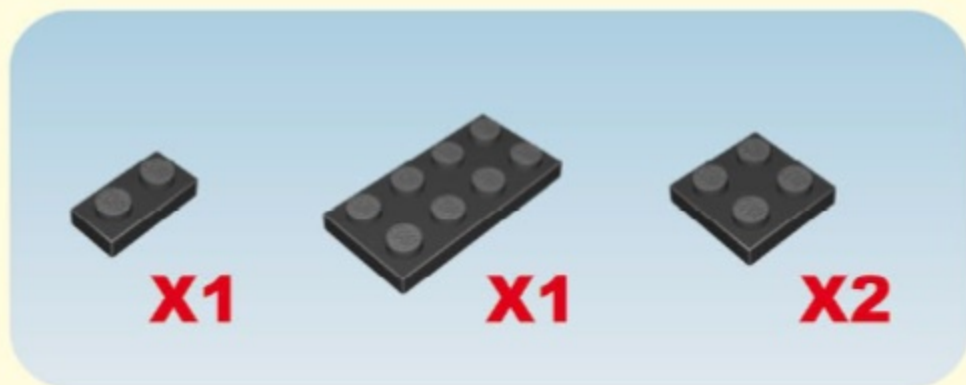
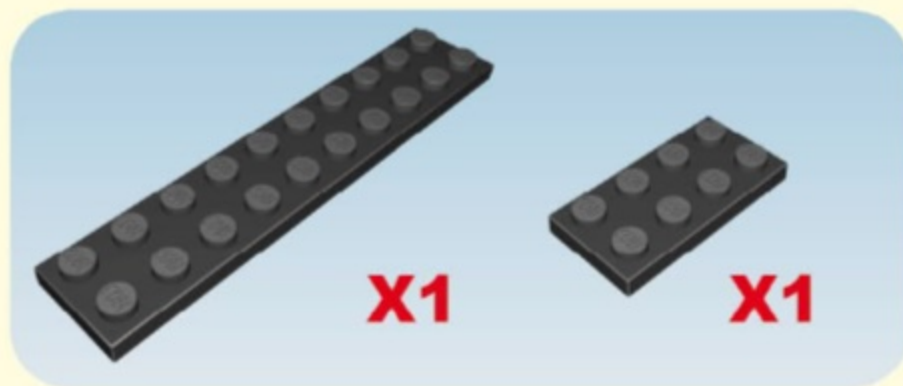
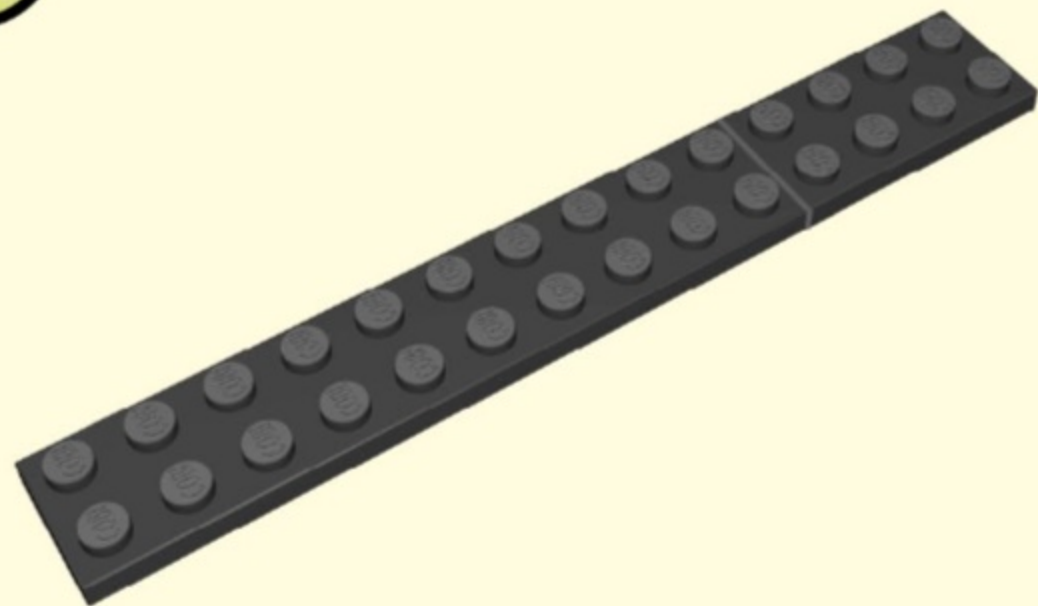

2

3

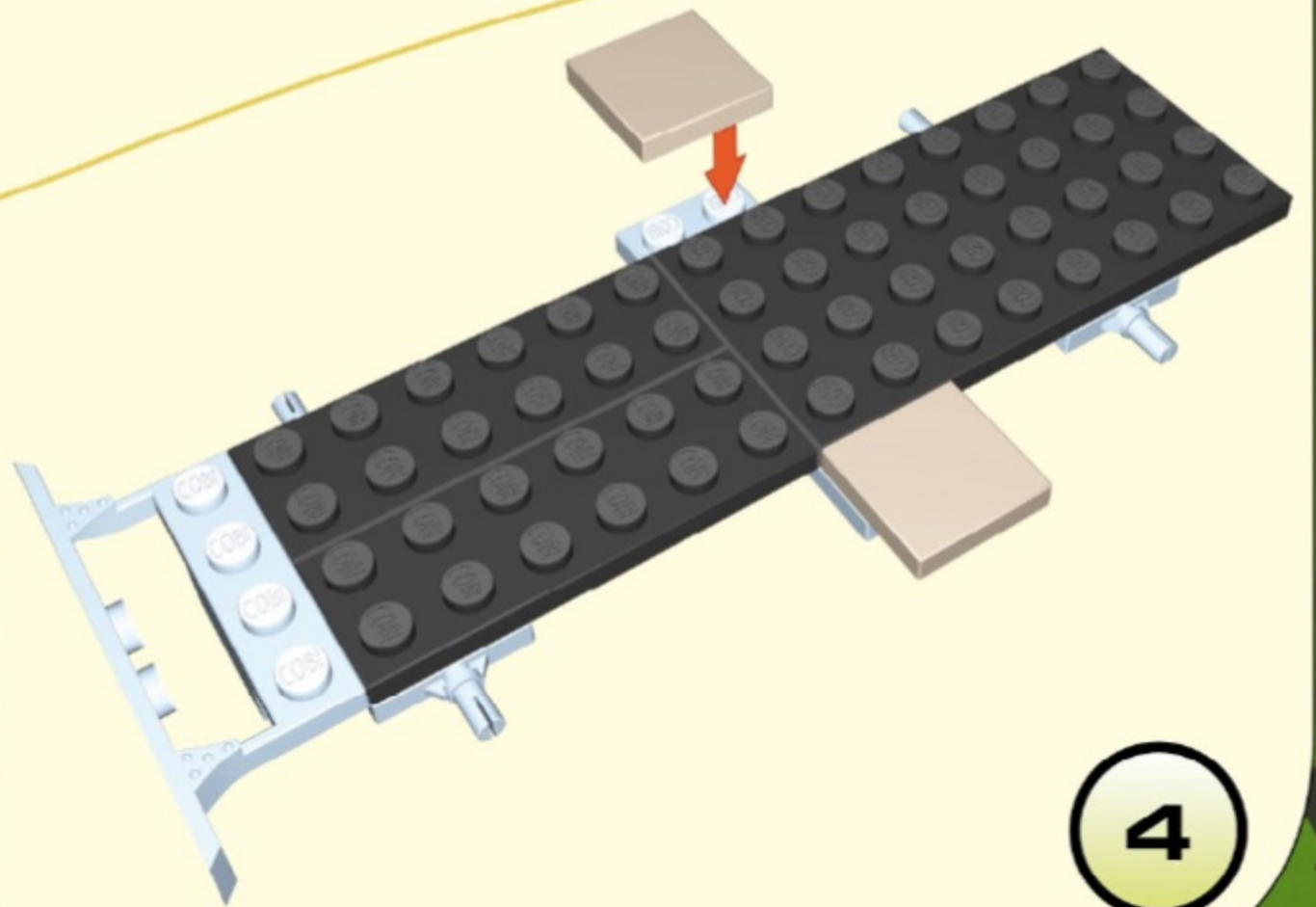
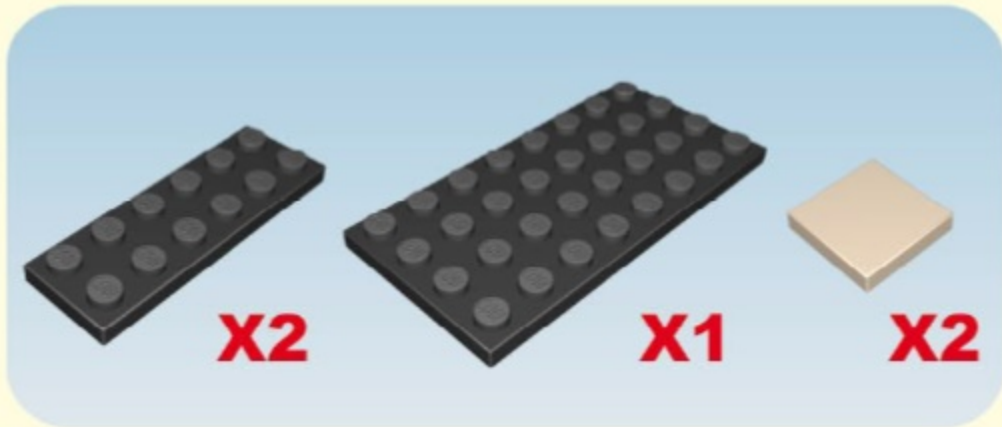
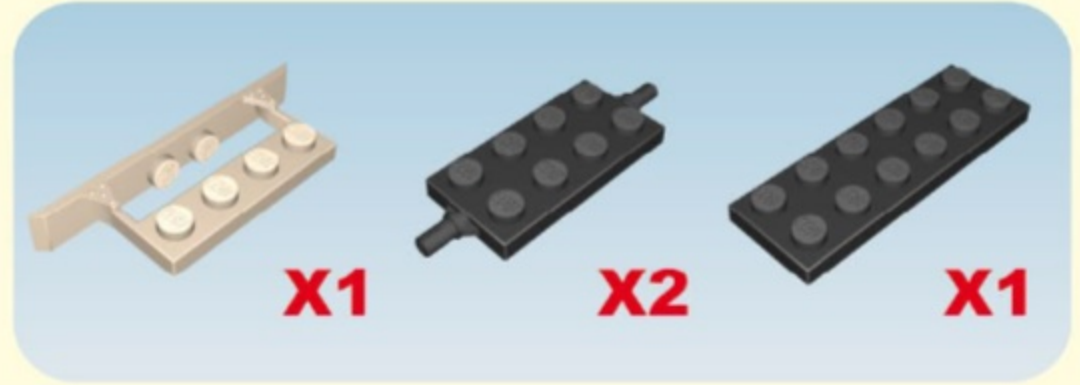
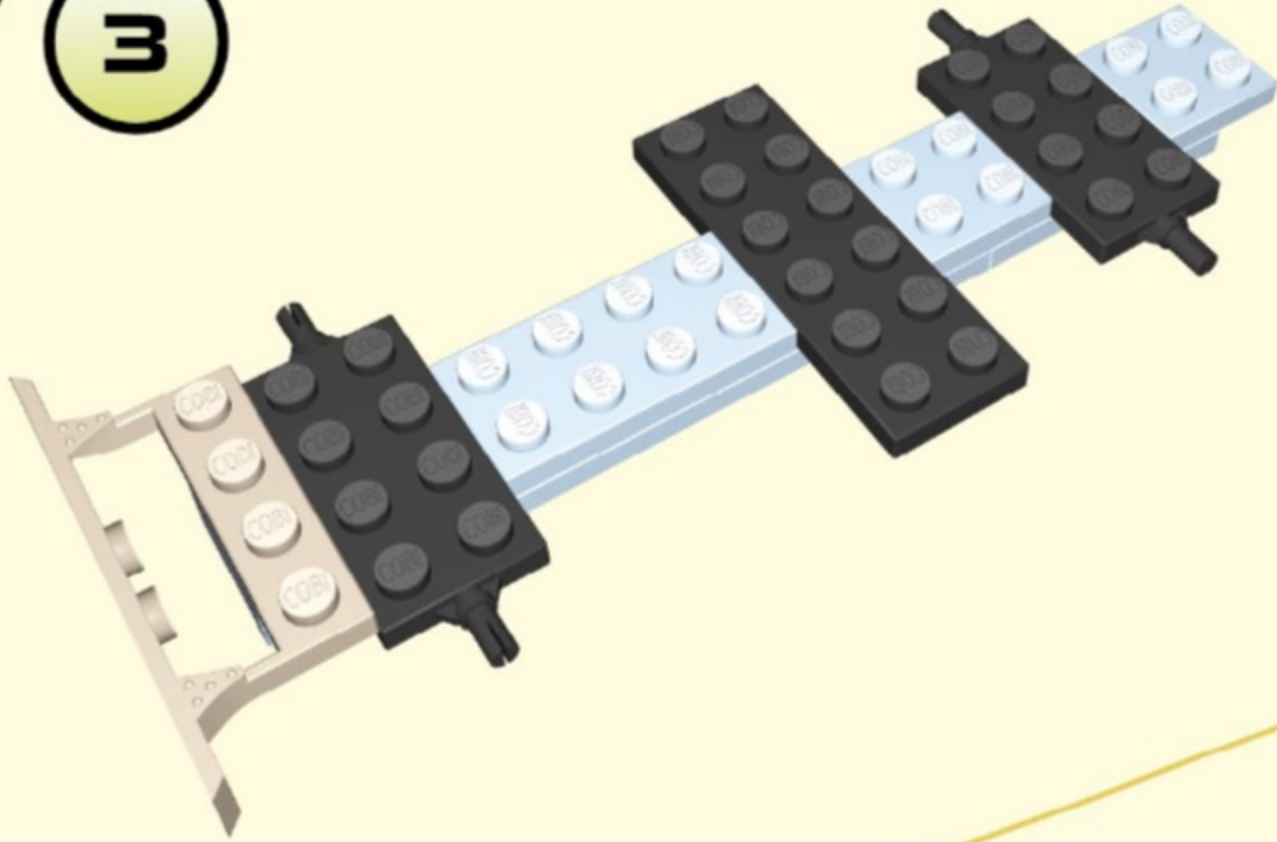

4

5

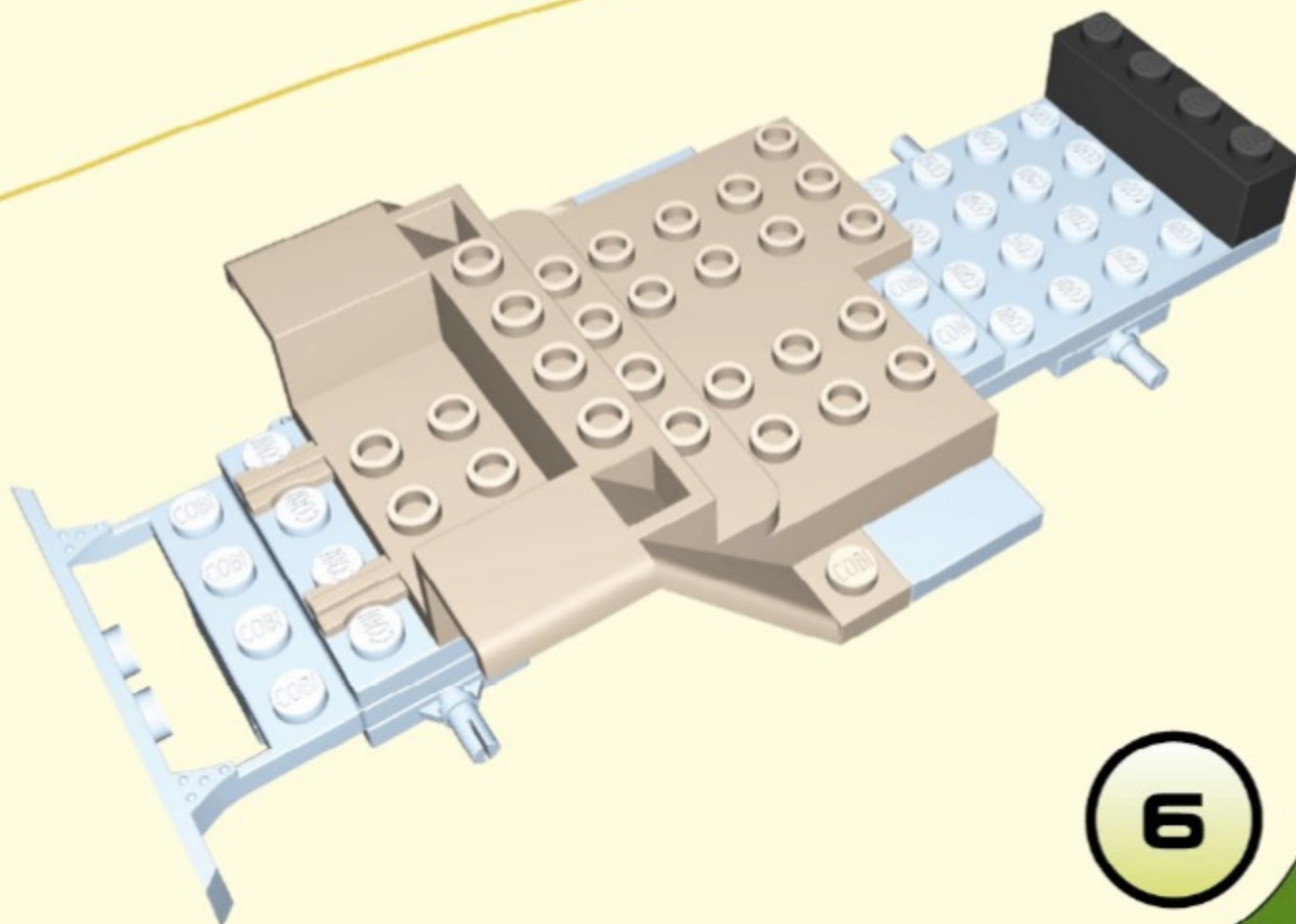
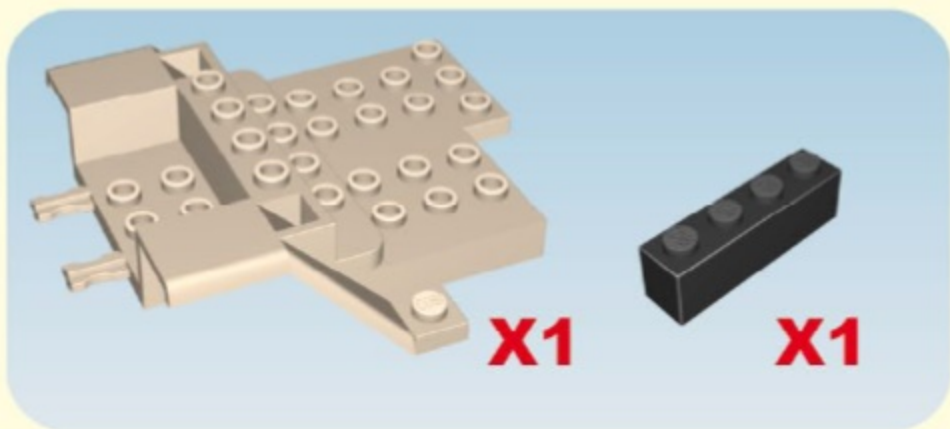
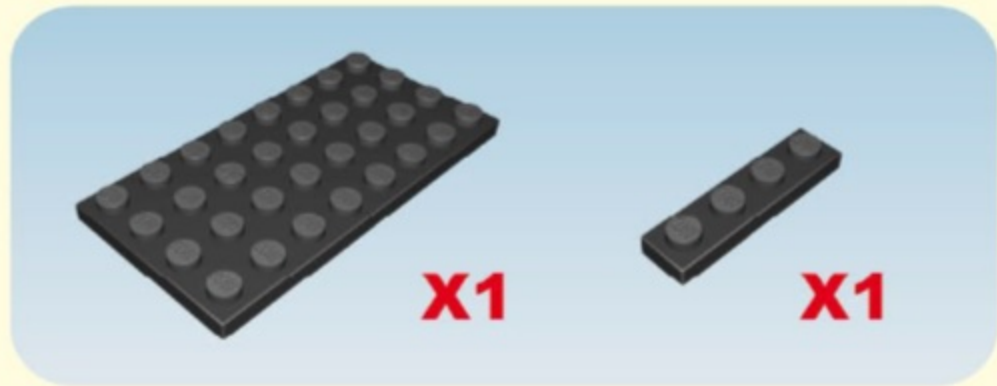
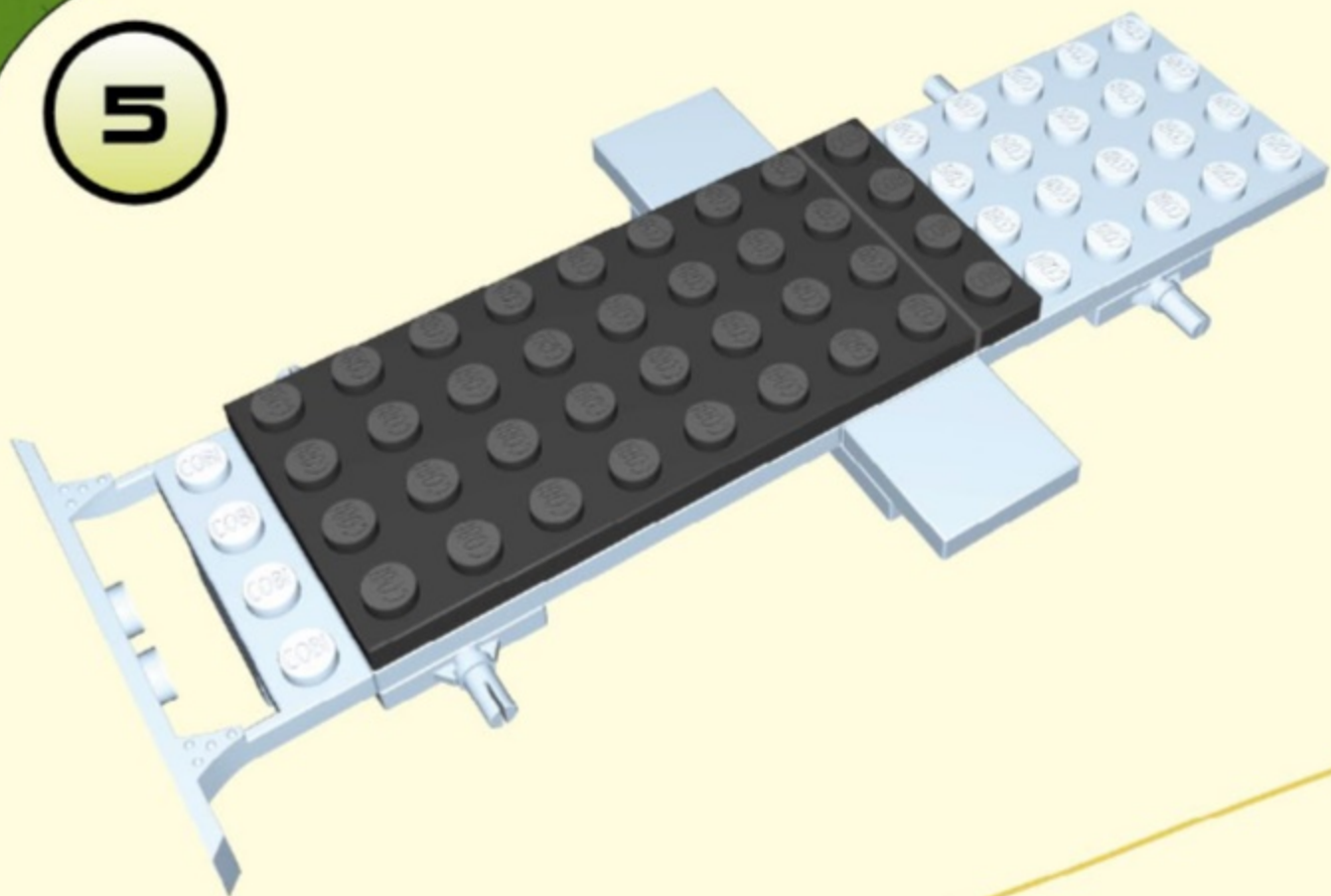

6

7

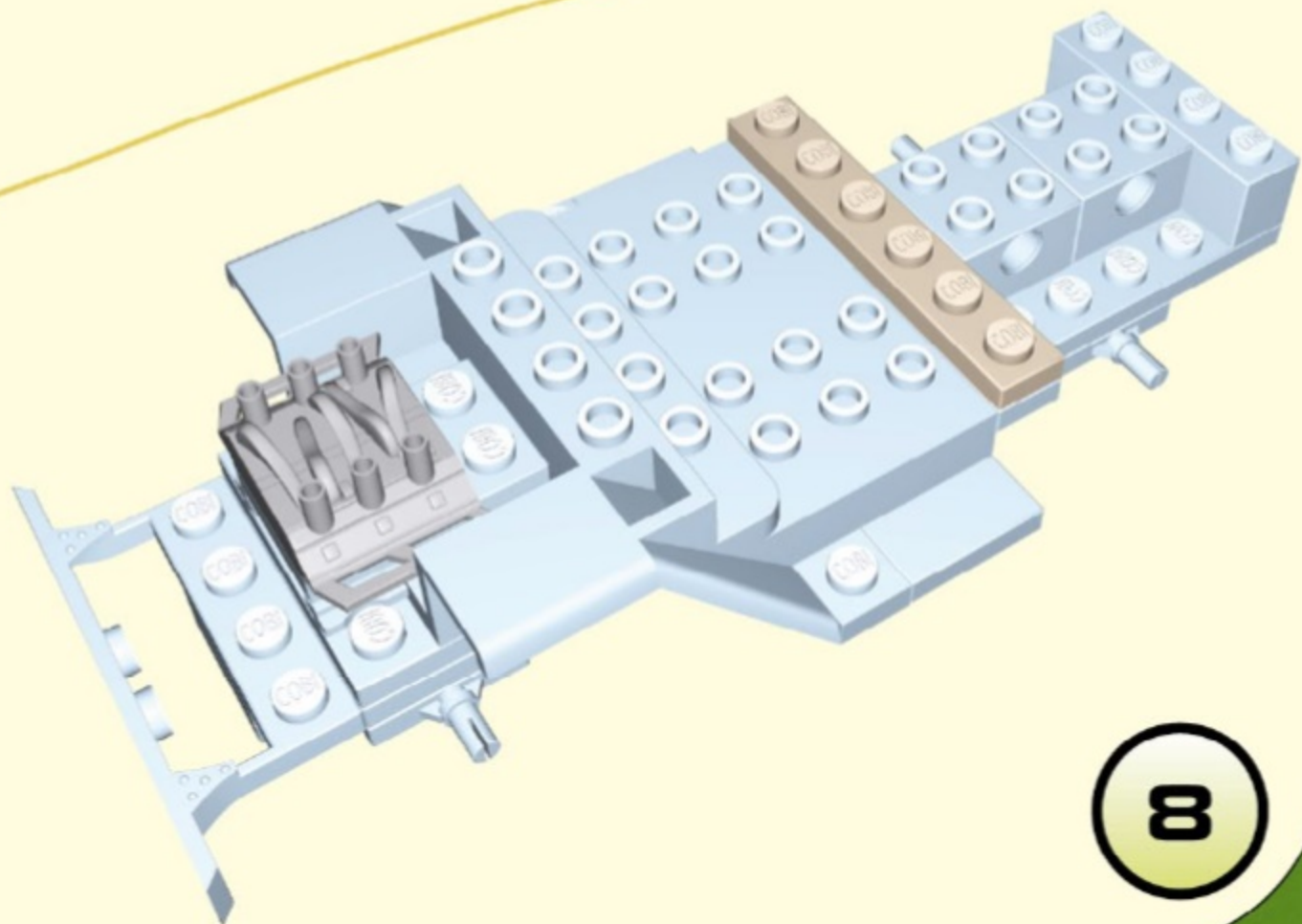
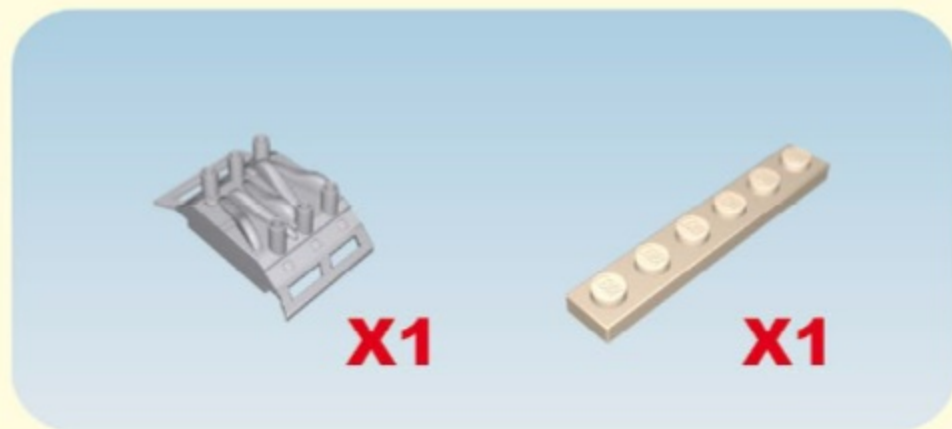
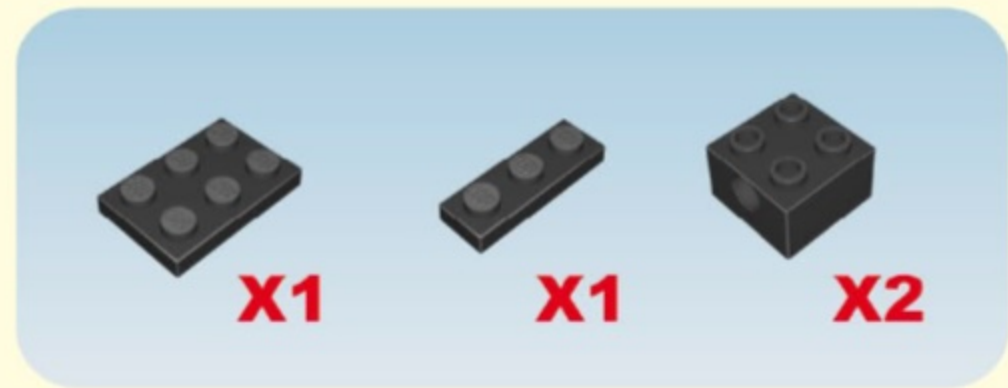
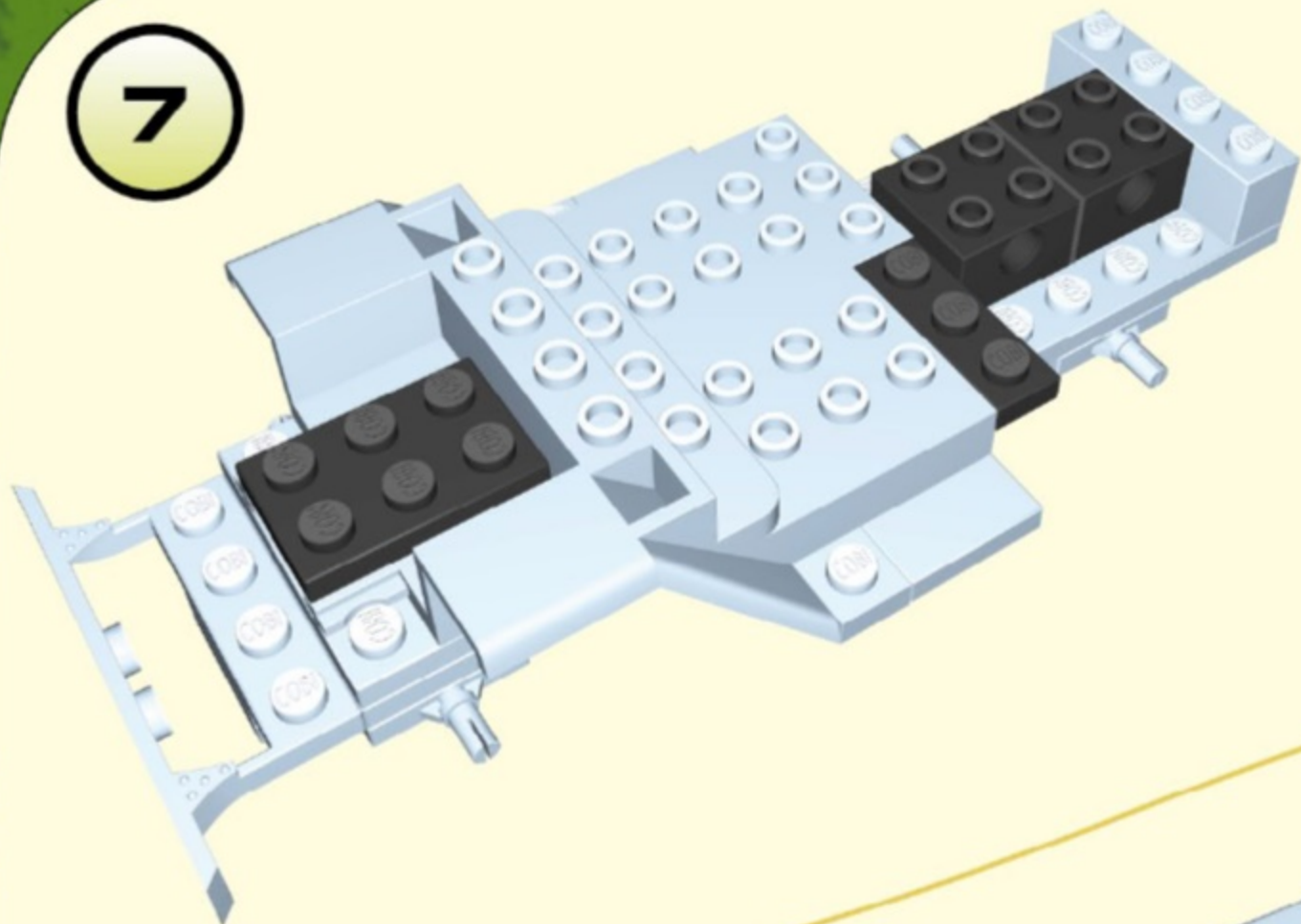

8

9

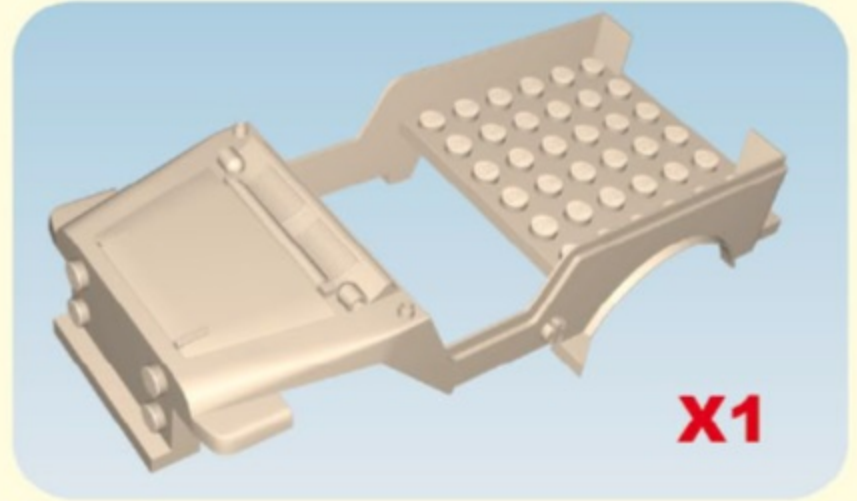
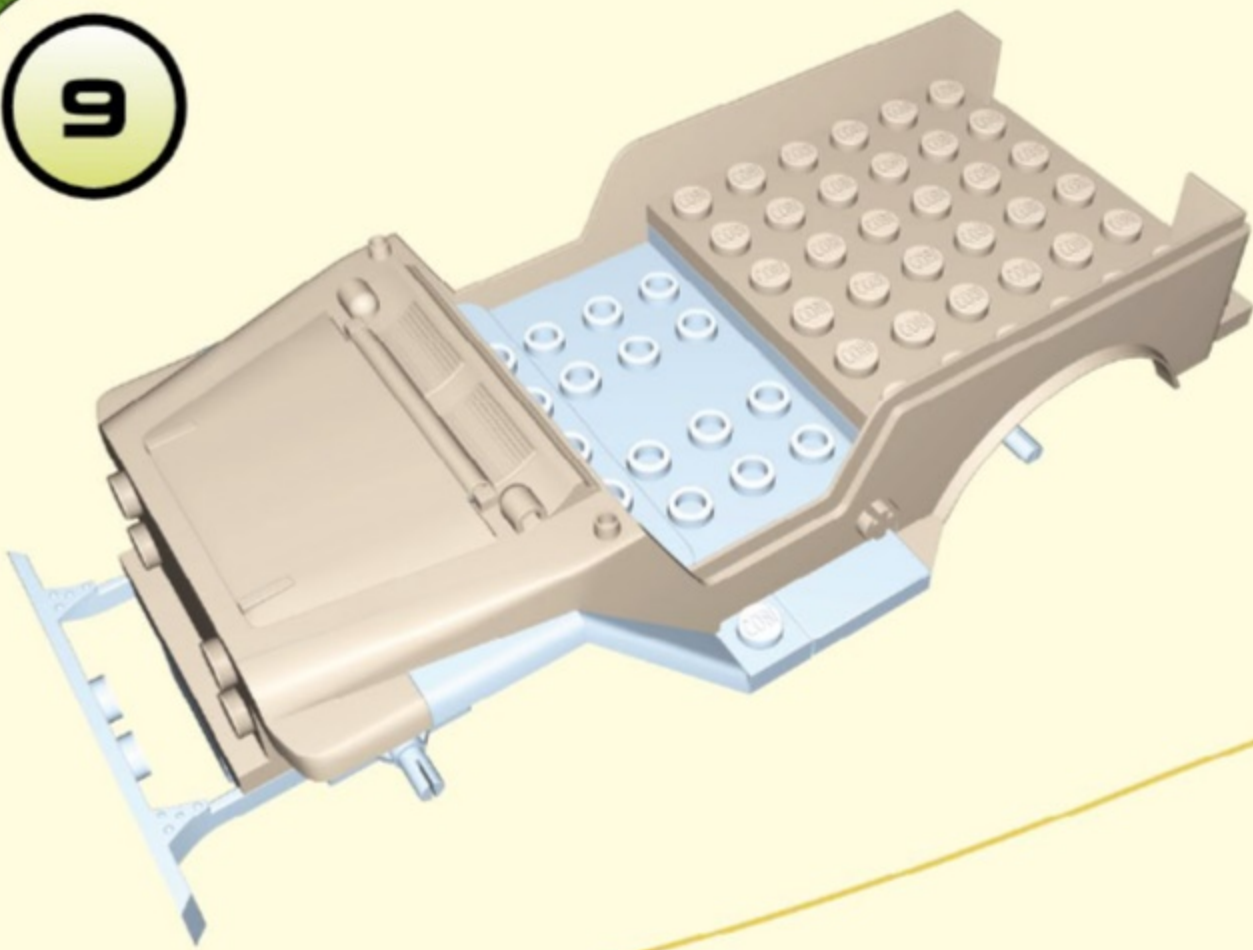

X1

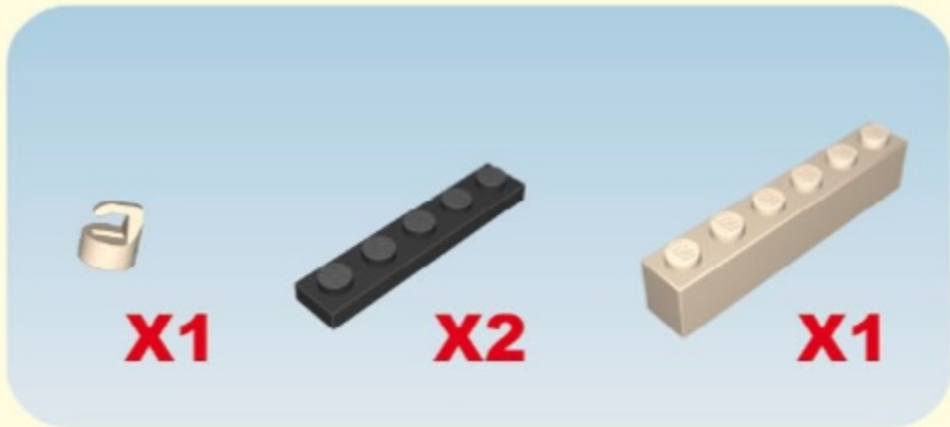

X1

X2

X1

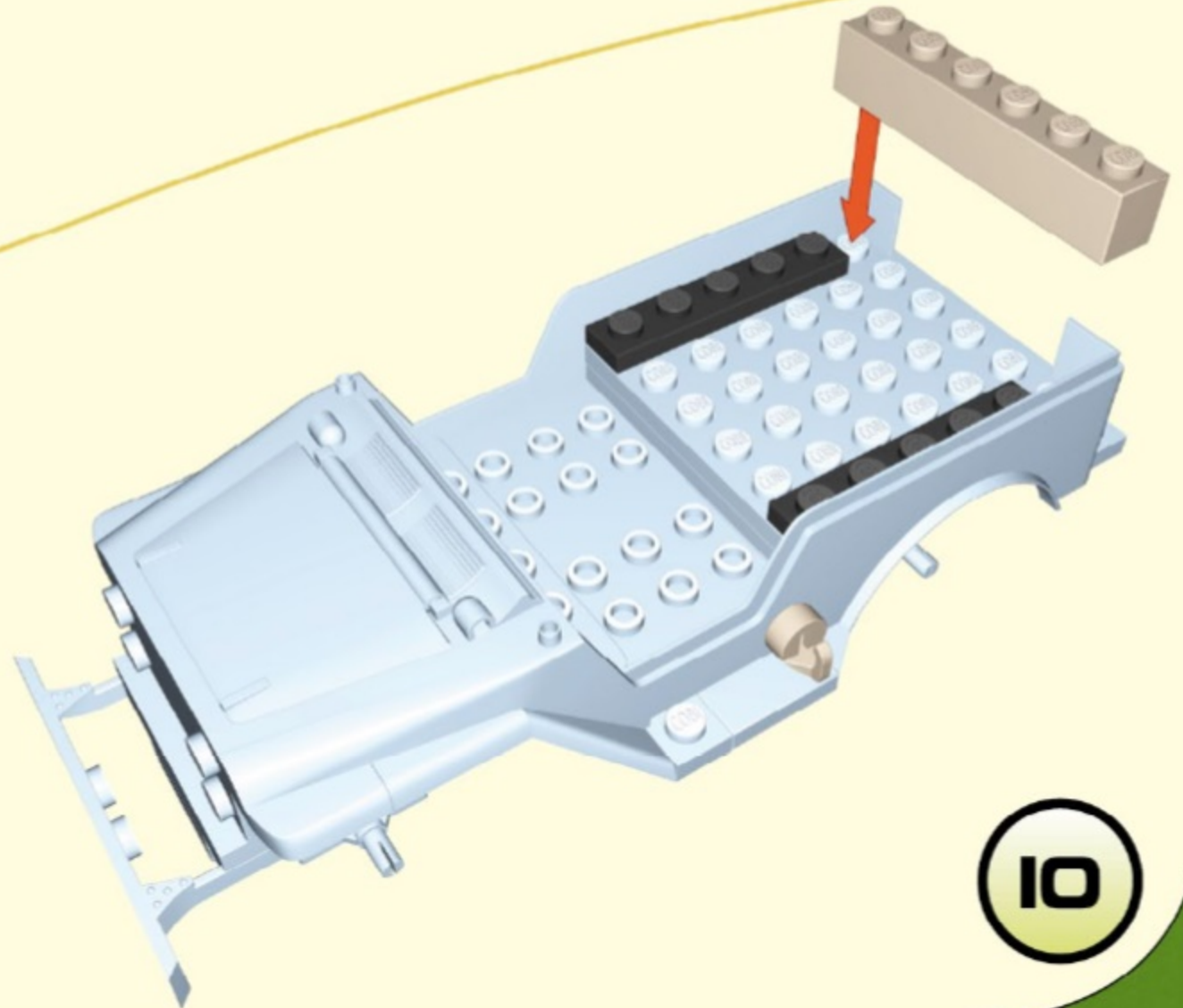

10

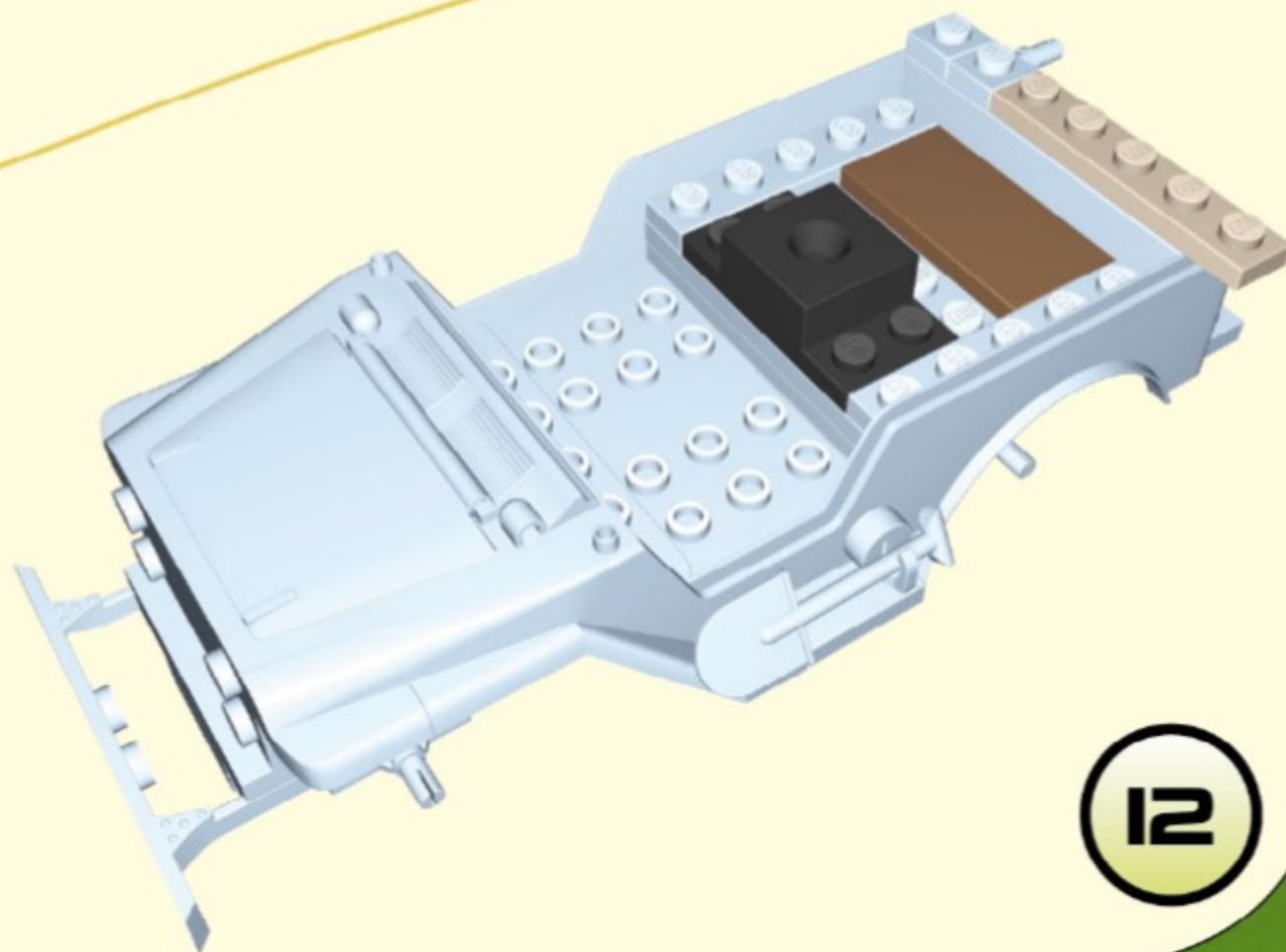
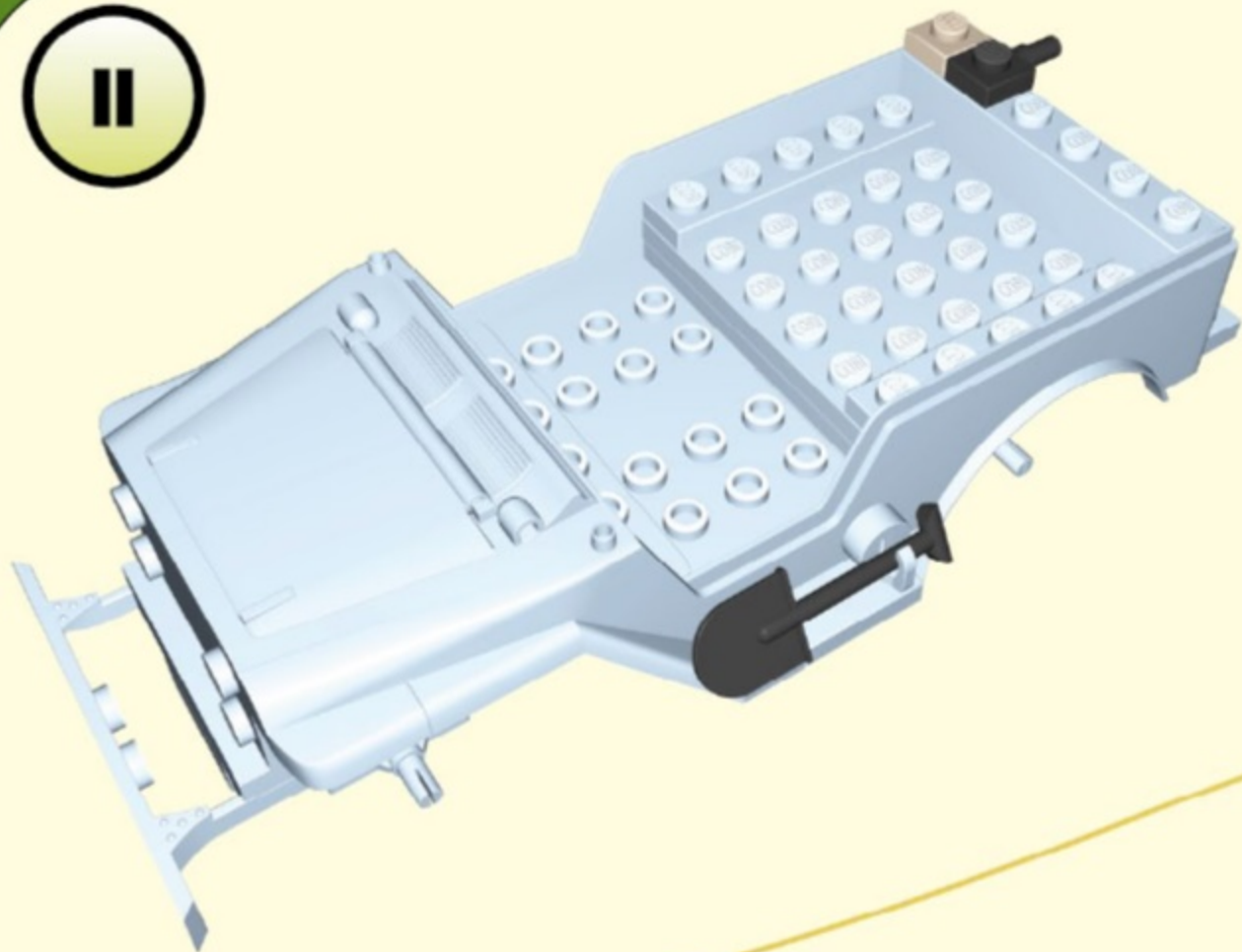

13

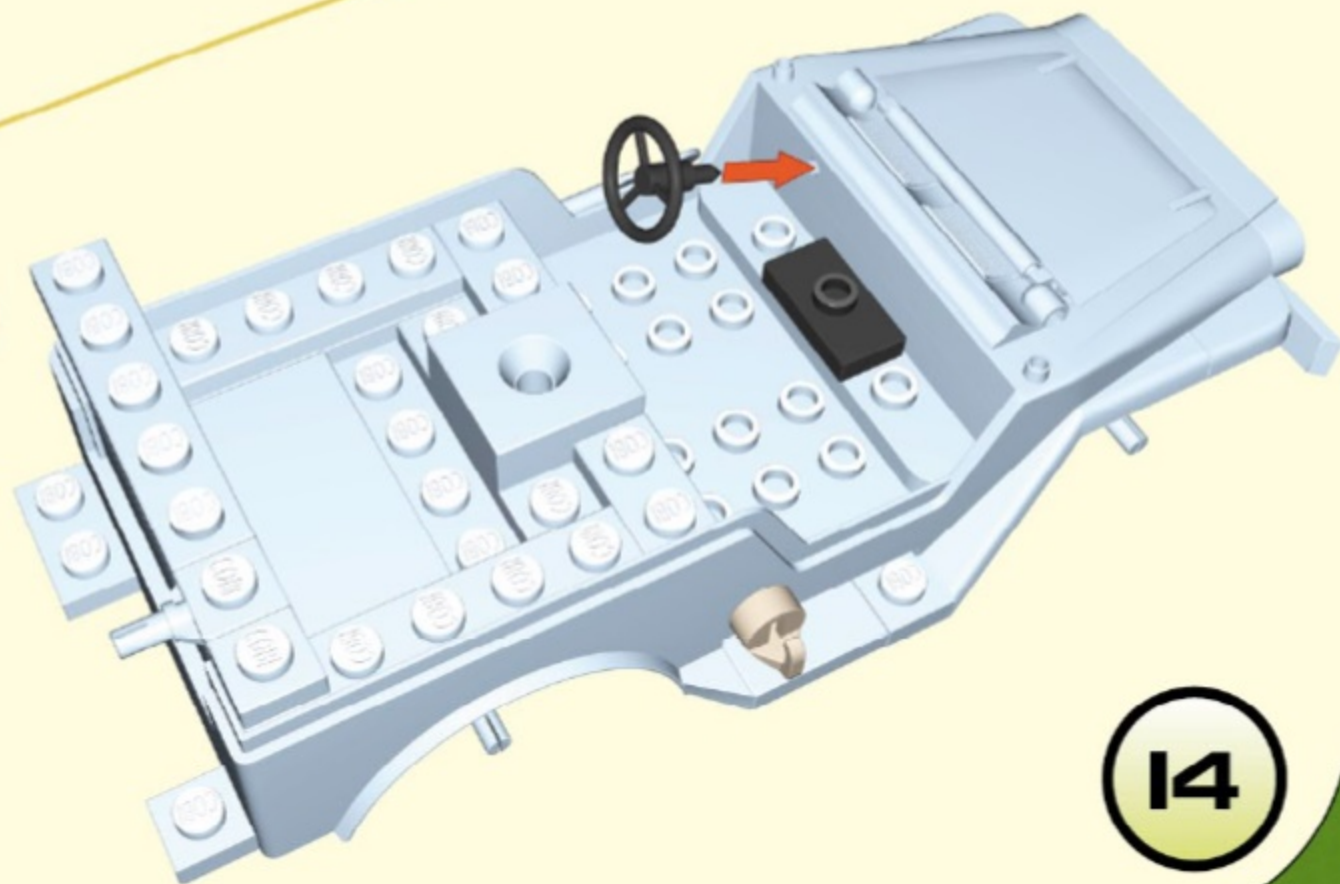
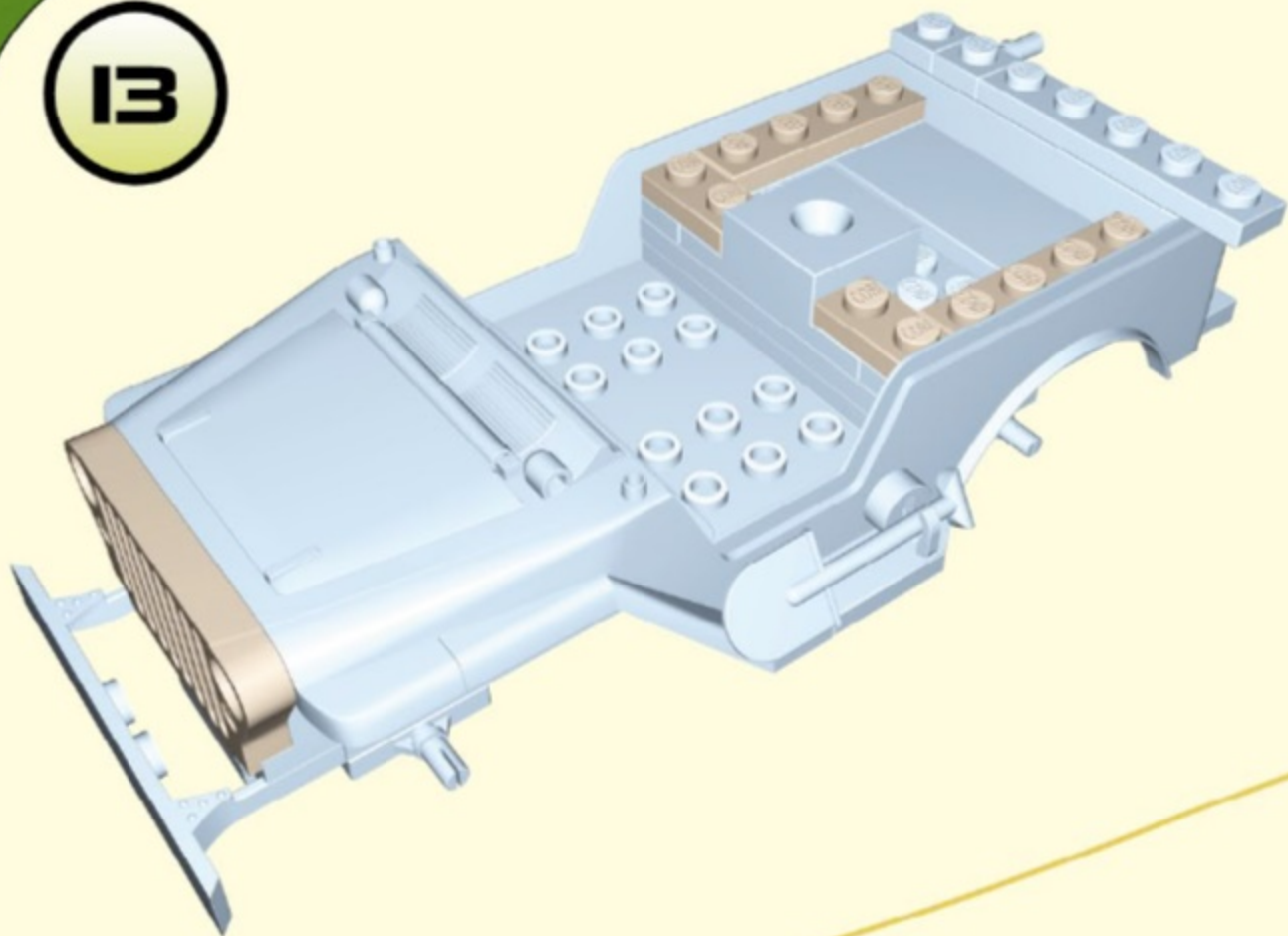

14

15

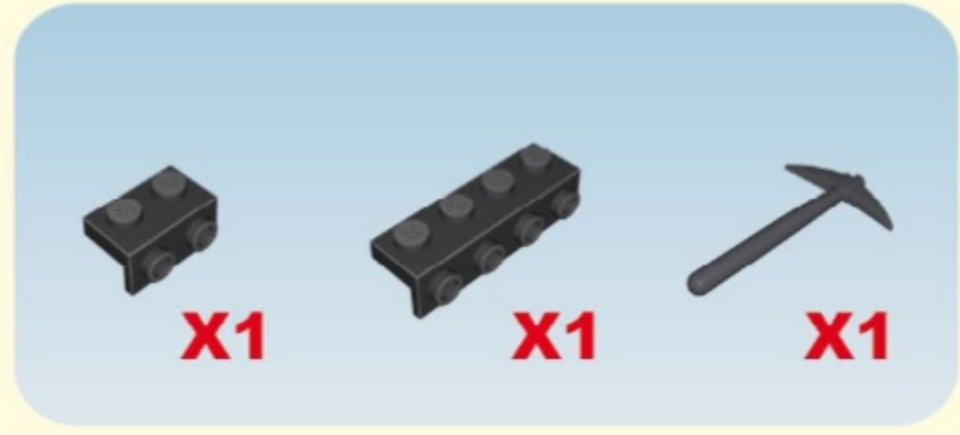
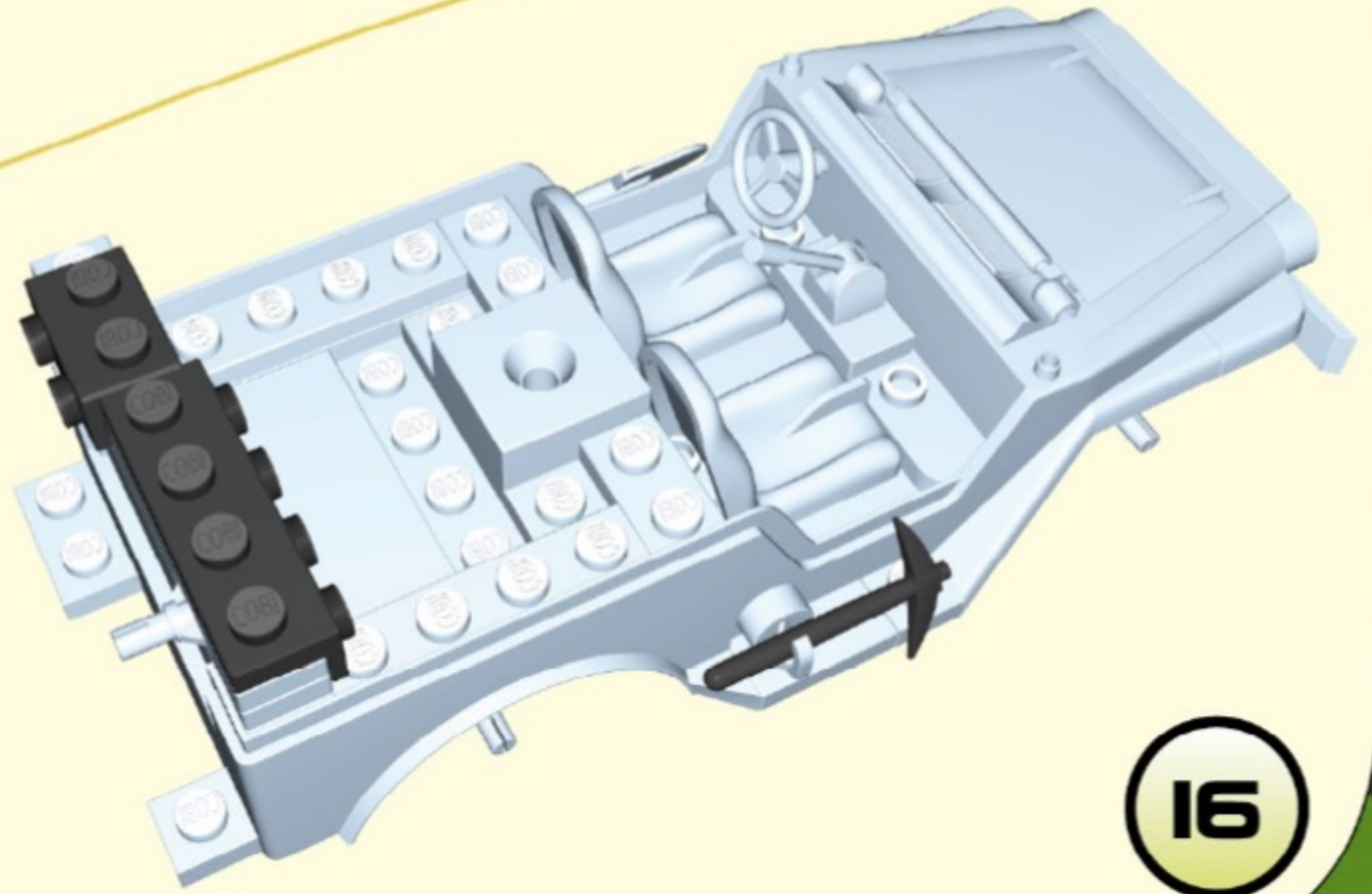
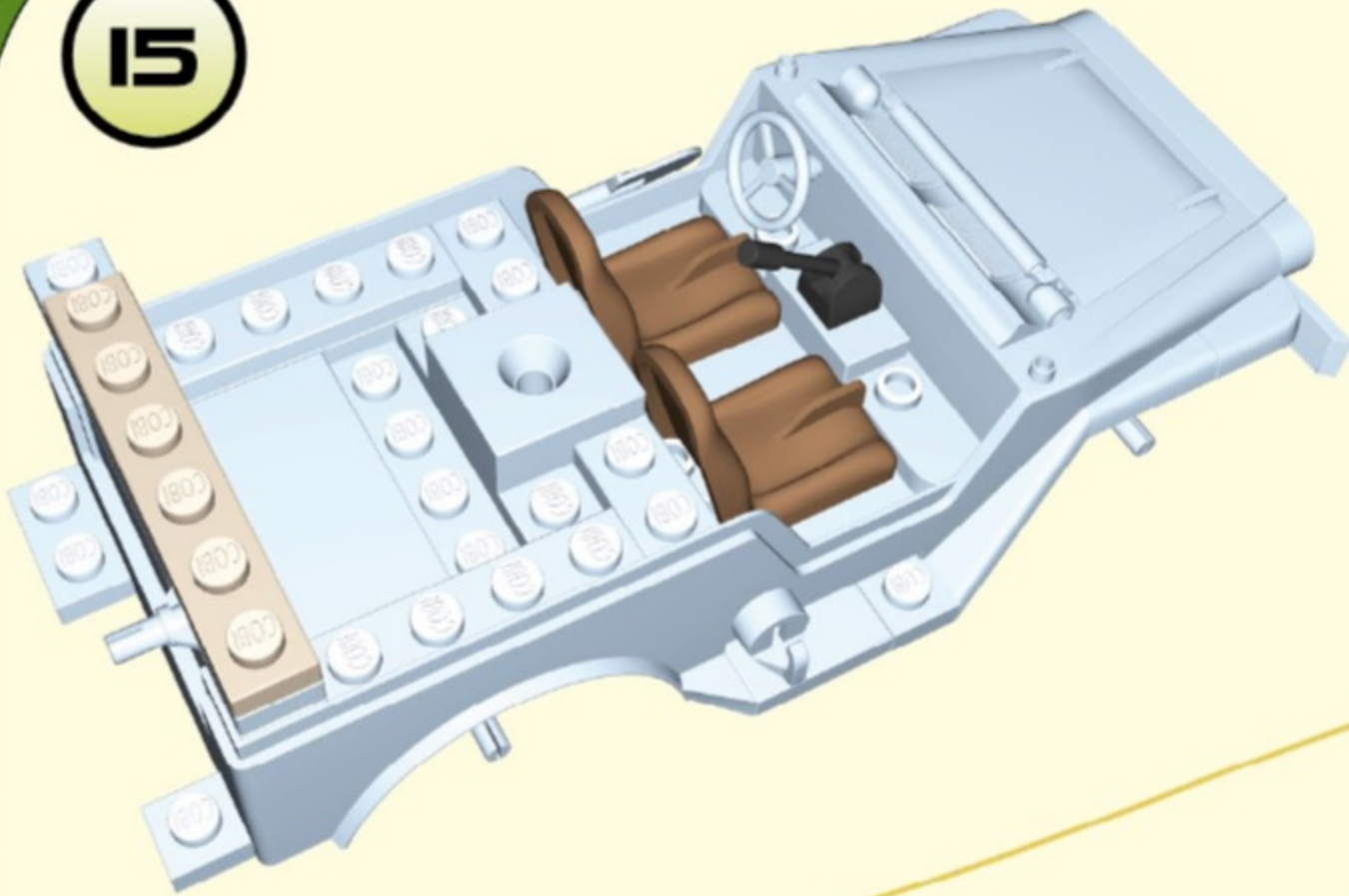

16

17

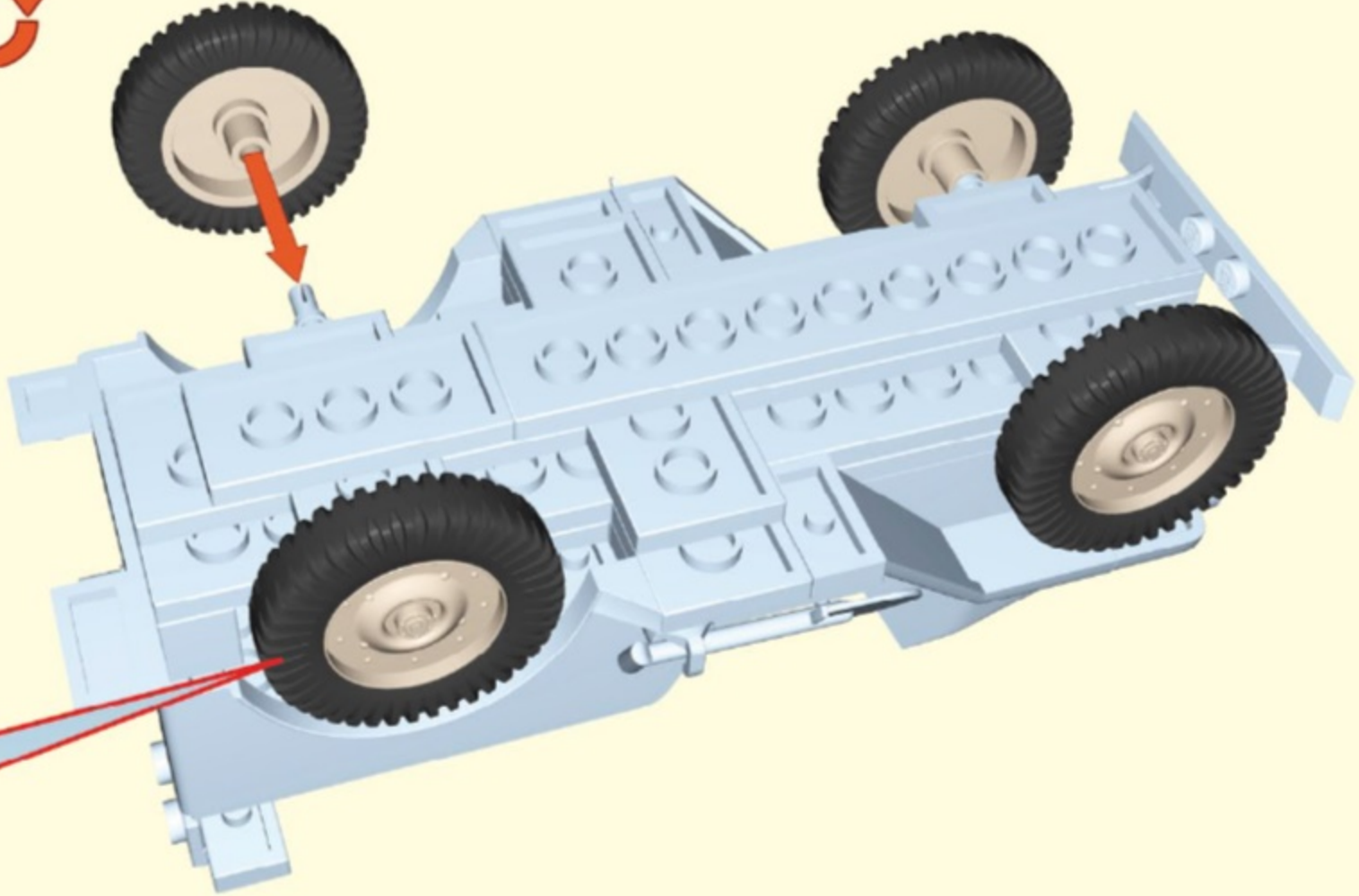

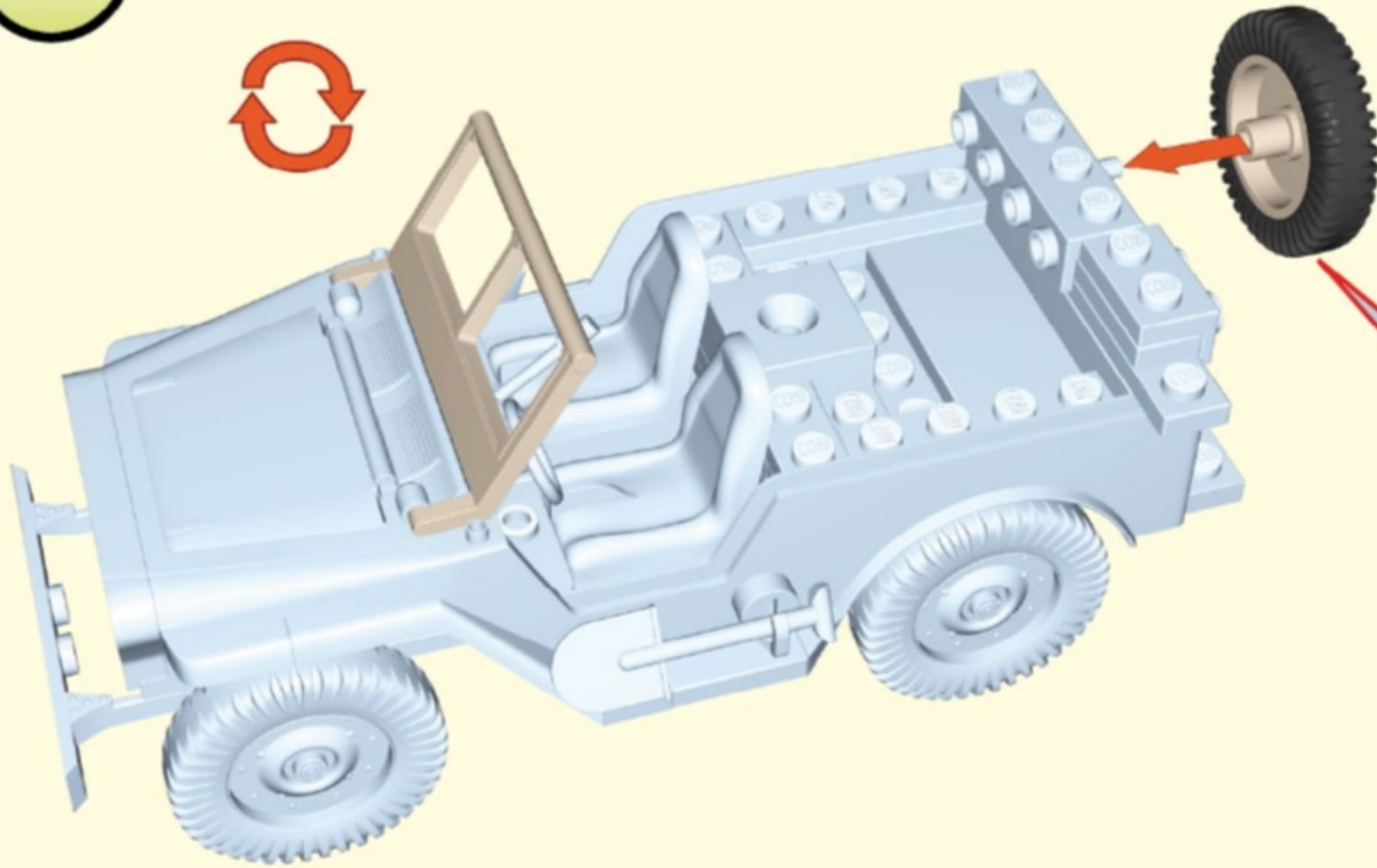

-  **X1**
-  **X1**
-  **X1**
-  **X1**

19

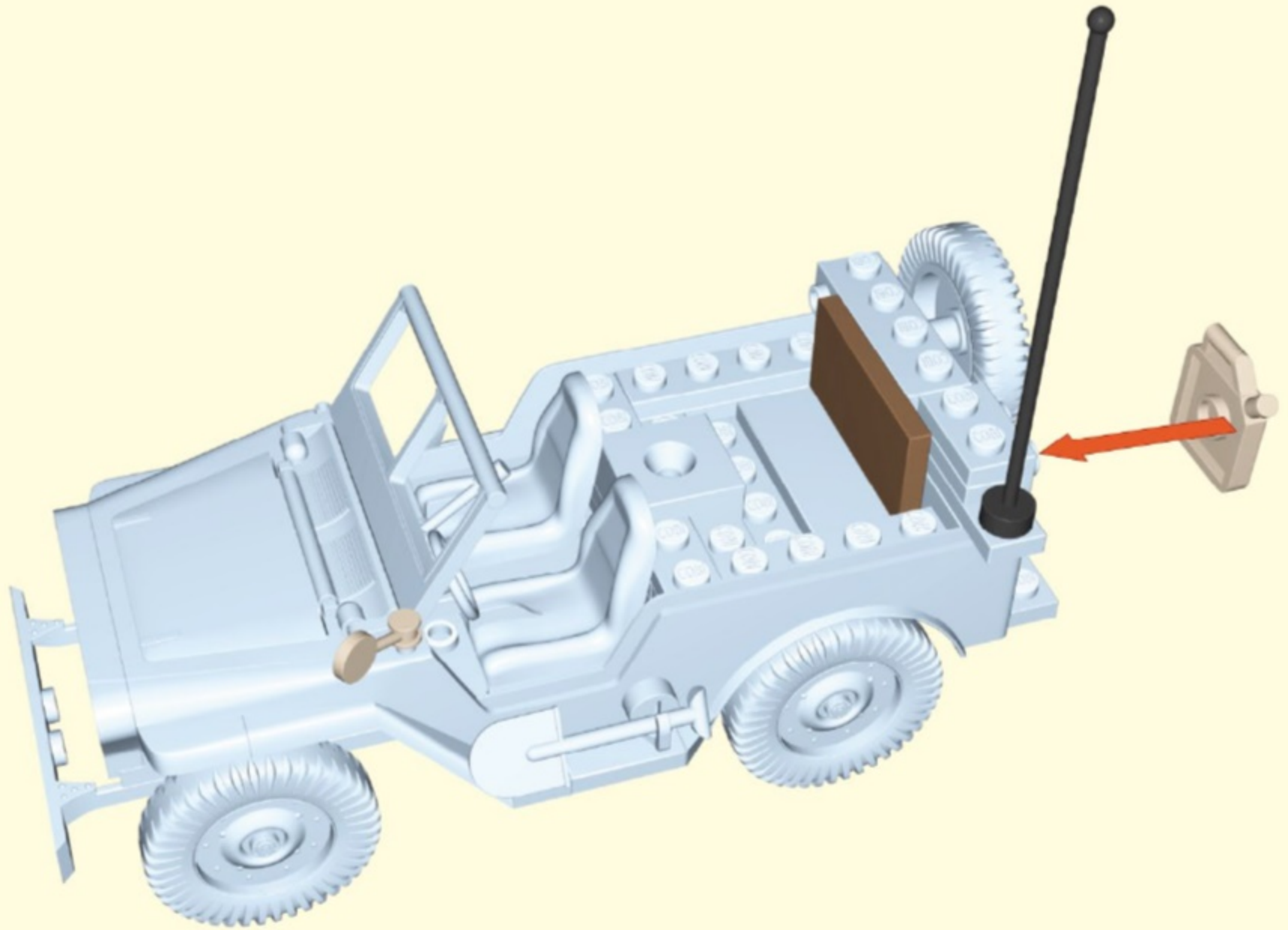

-  **X1**
-  **X1**
-  **X1**
-  **X1**

20



21

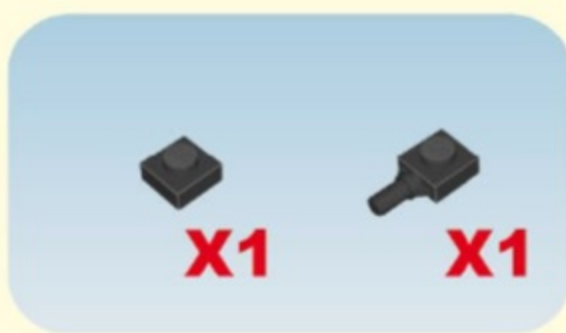
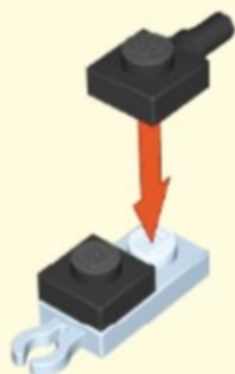

22



23



24



25



27

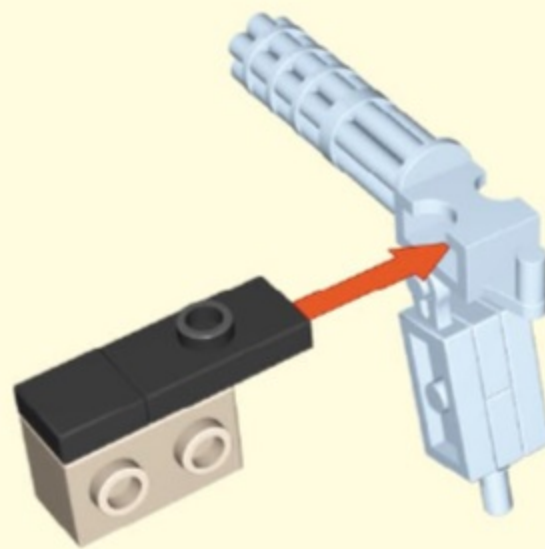

26



28

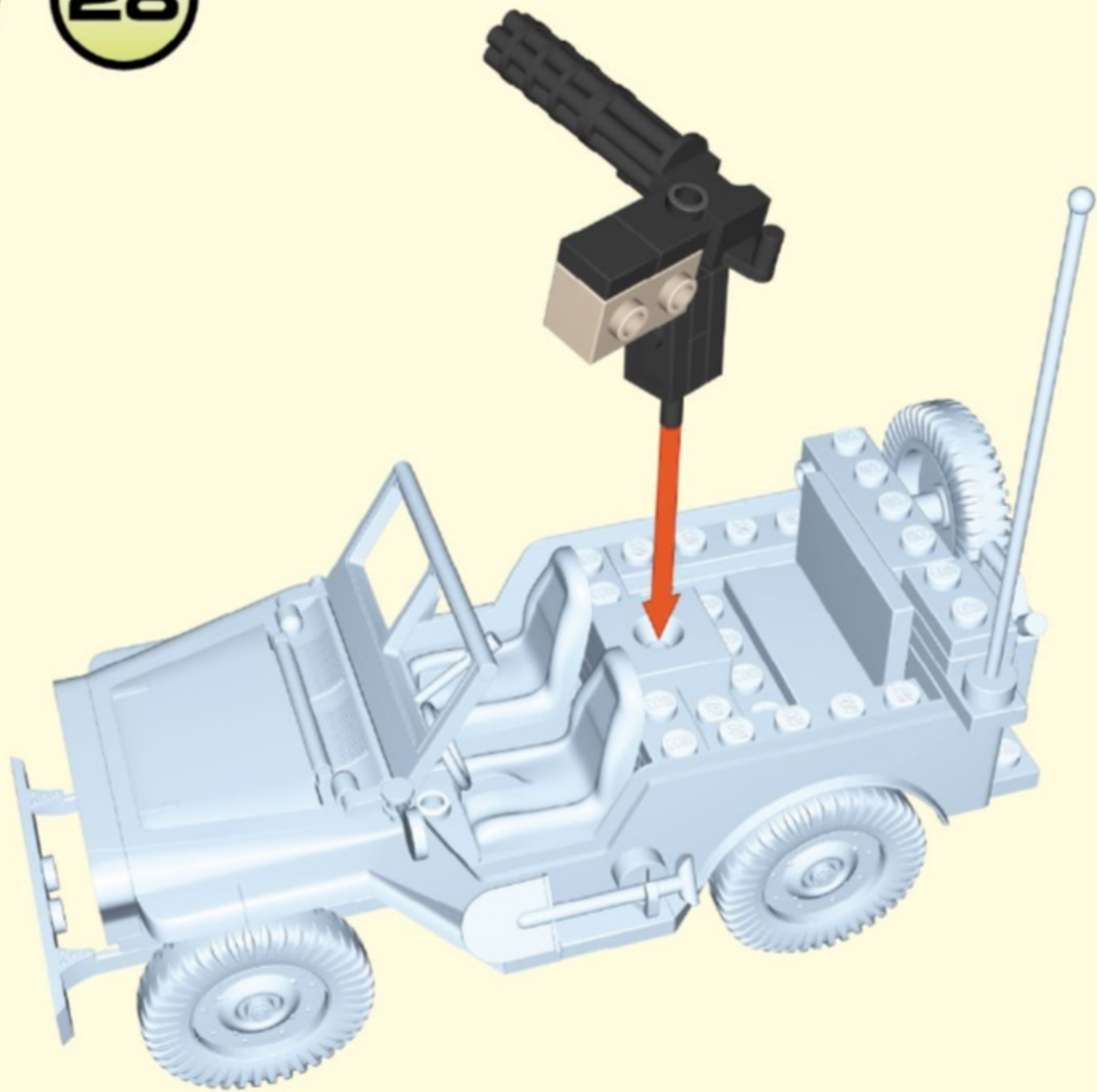

29

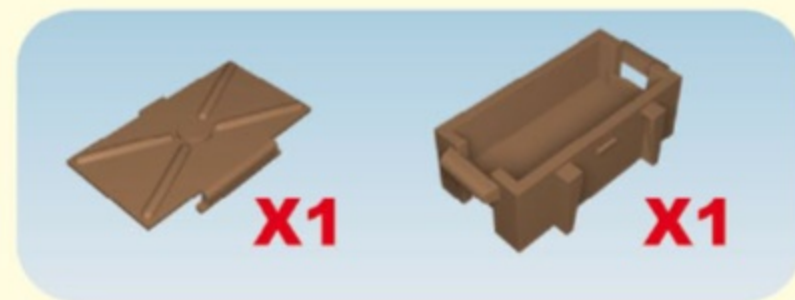
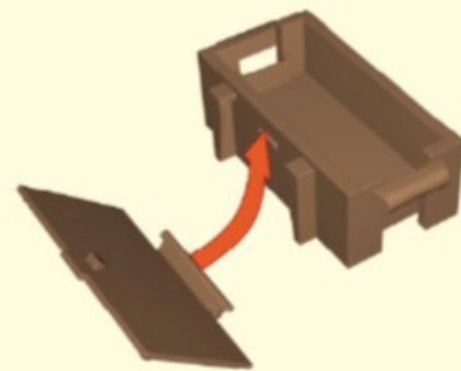

30

