

DREAMWORKS® **The PENGUINS**
of **MADAGASCAR**
nickelodeon.



Printed in EU



WARNING: CHOKING HAZARD.
Toy contains small parts.
Not for children under 3 years.

1

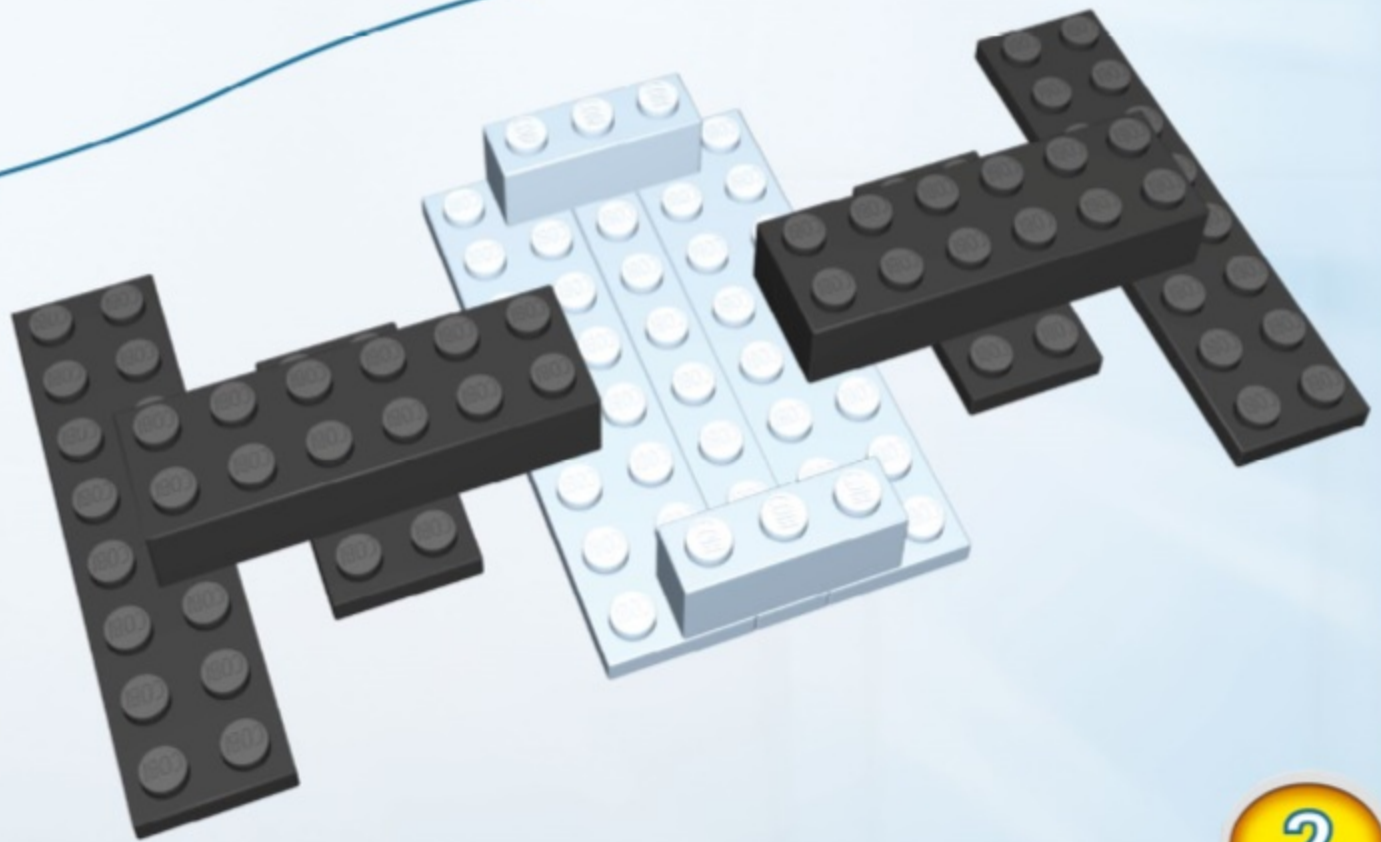
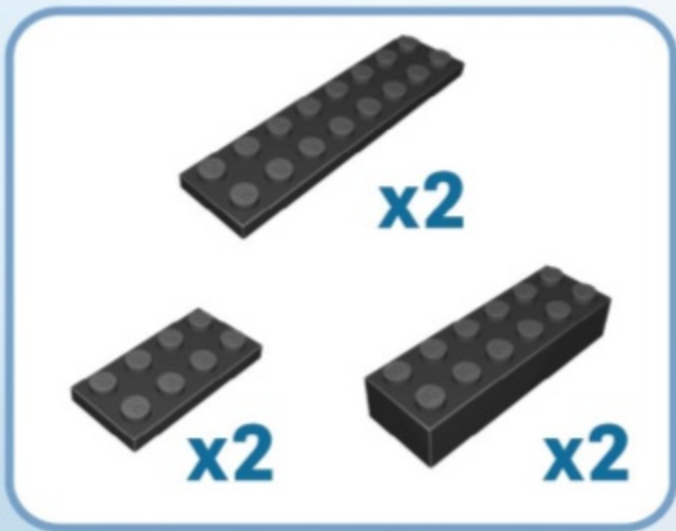

2

3

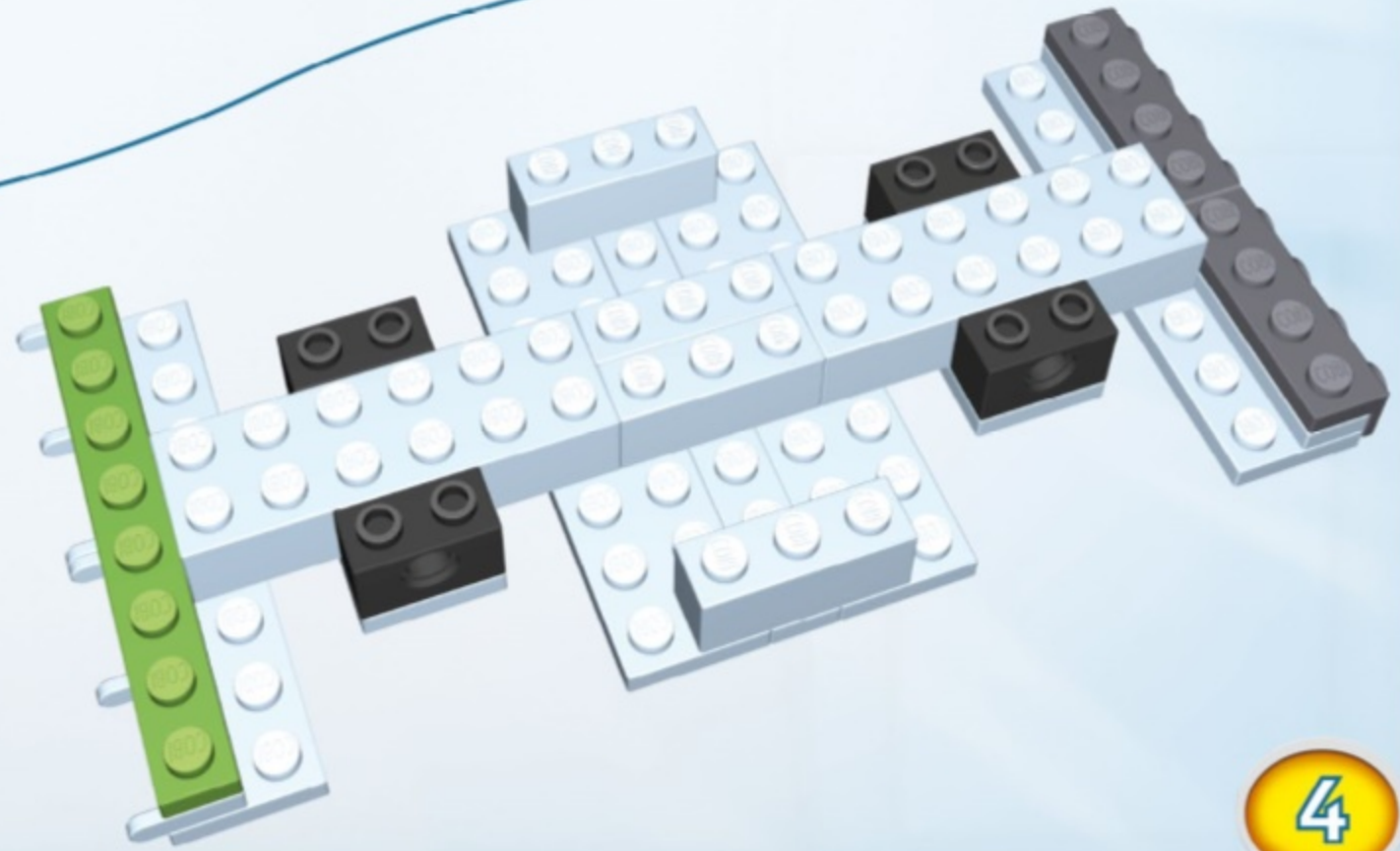
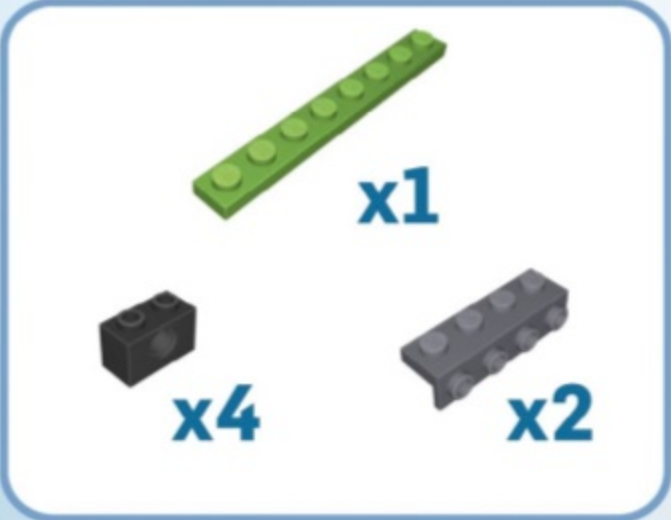
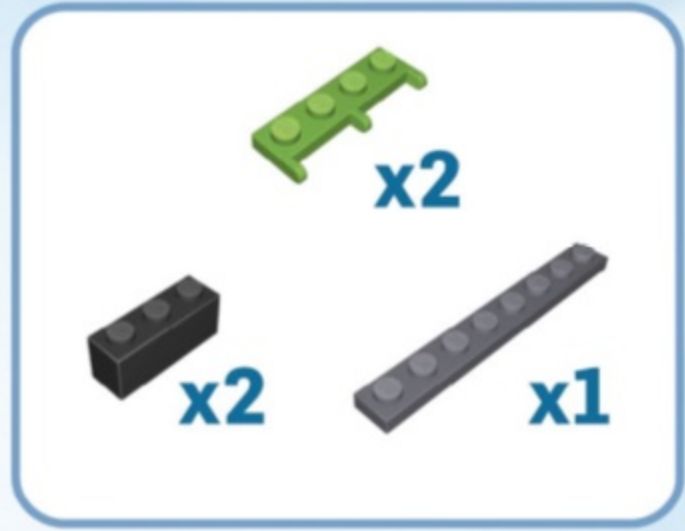
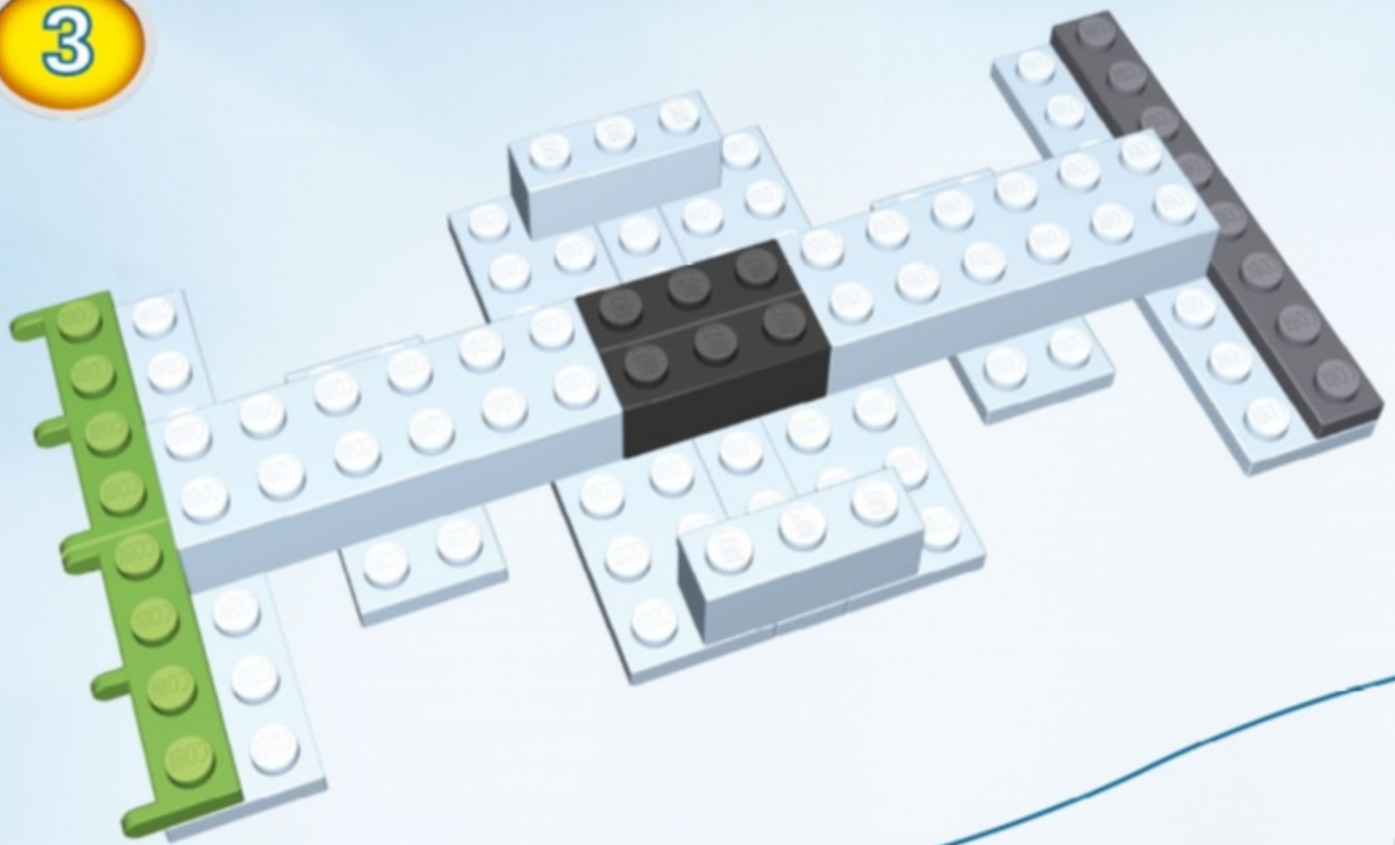

4

5

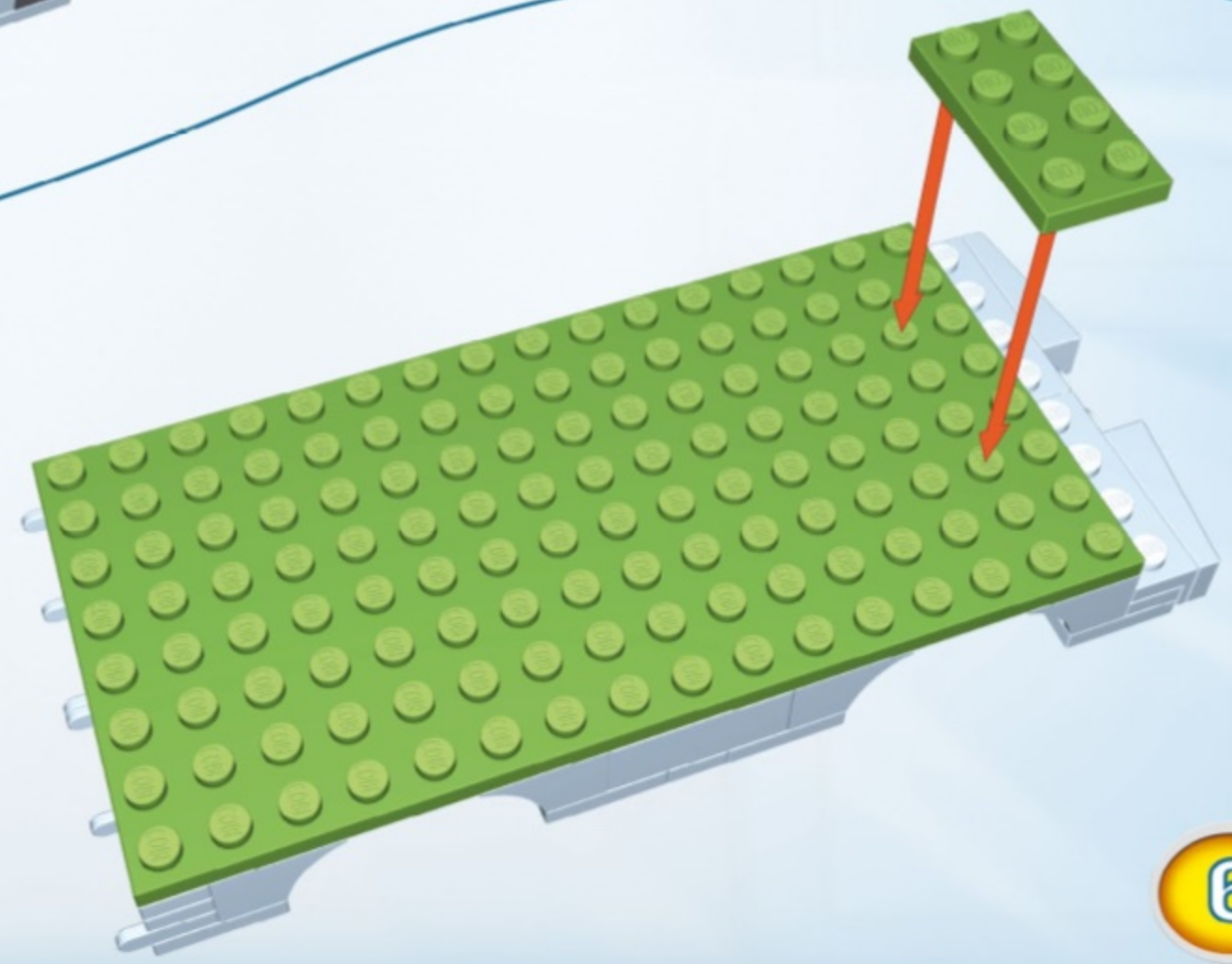
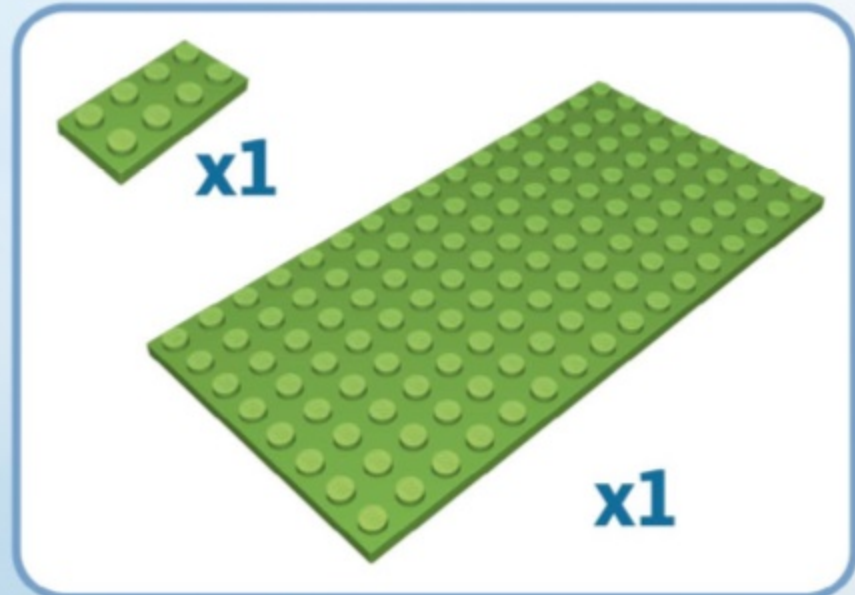
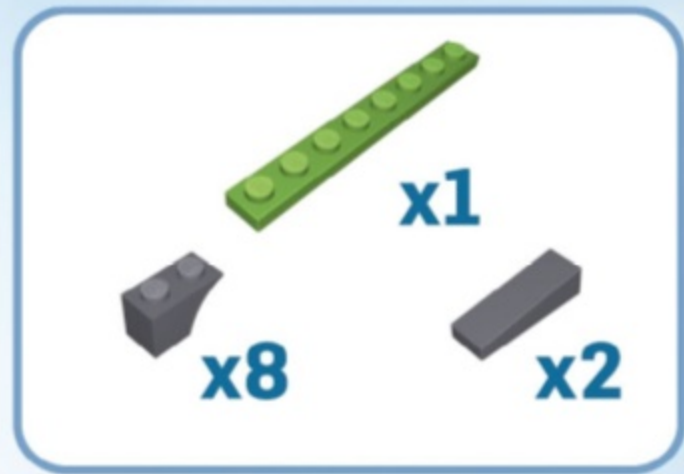
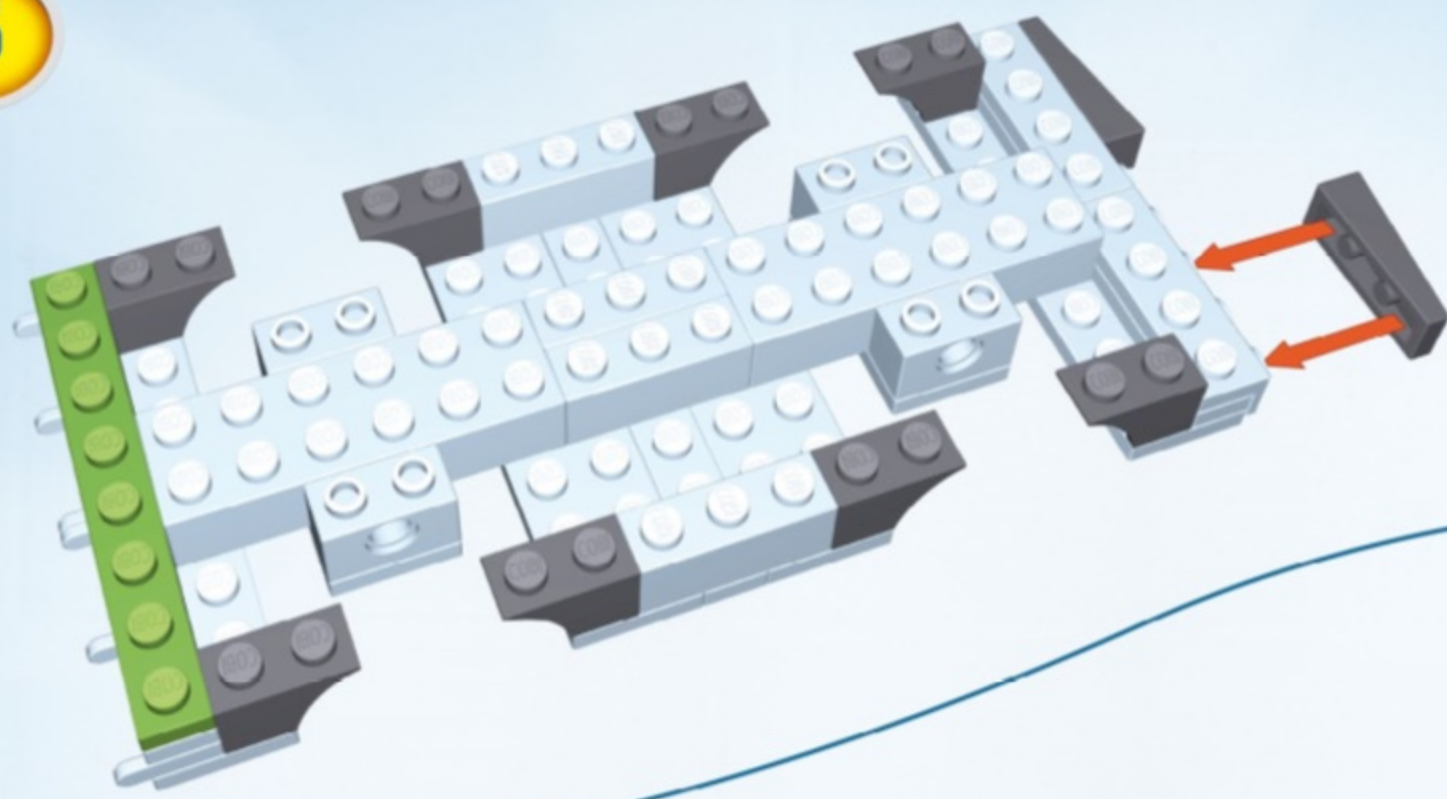

6

7

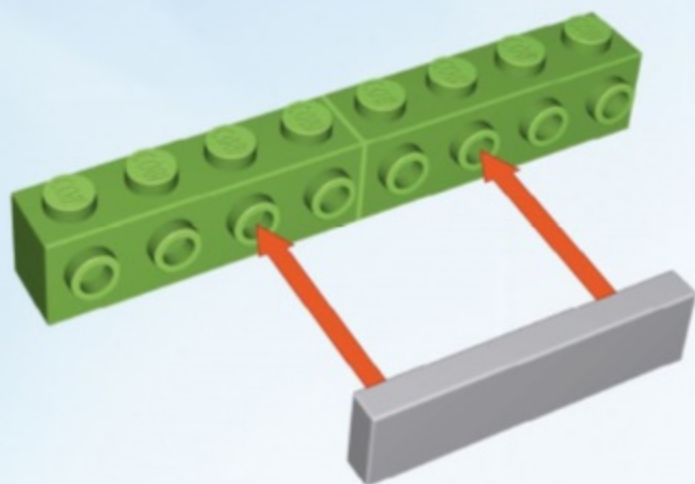

8

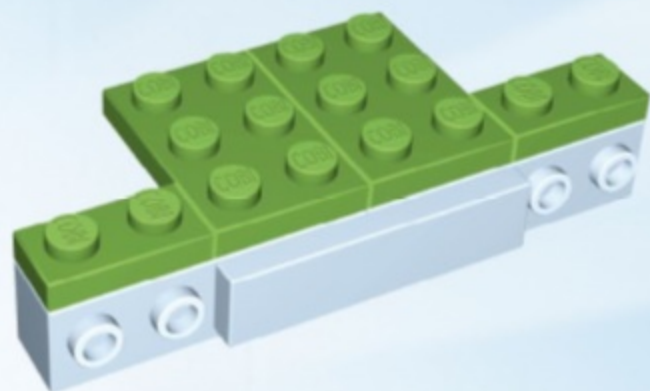

9

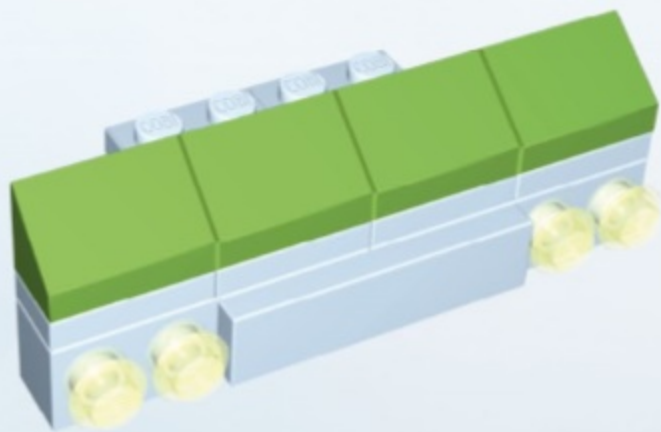

10

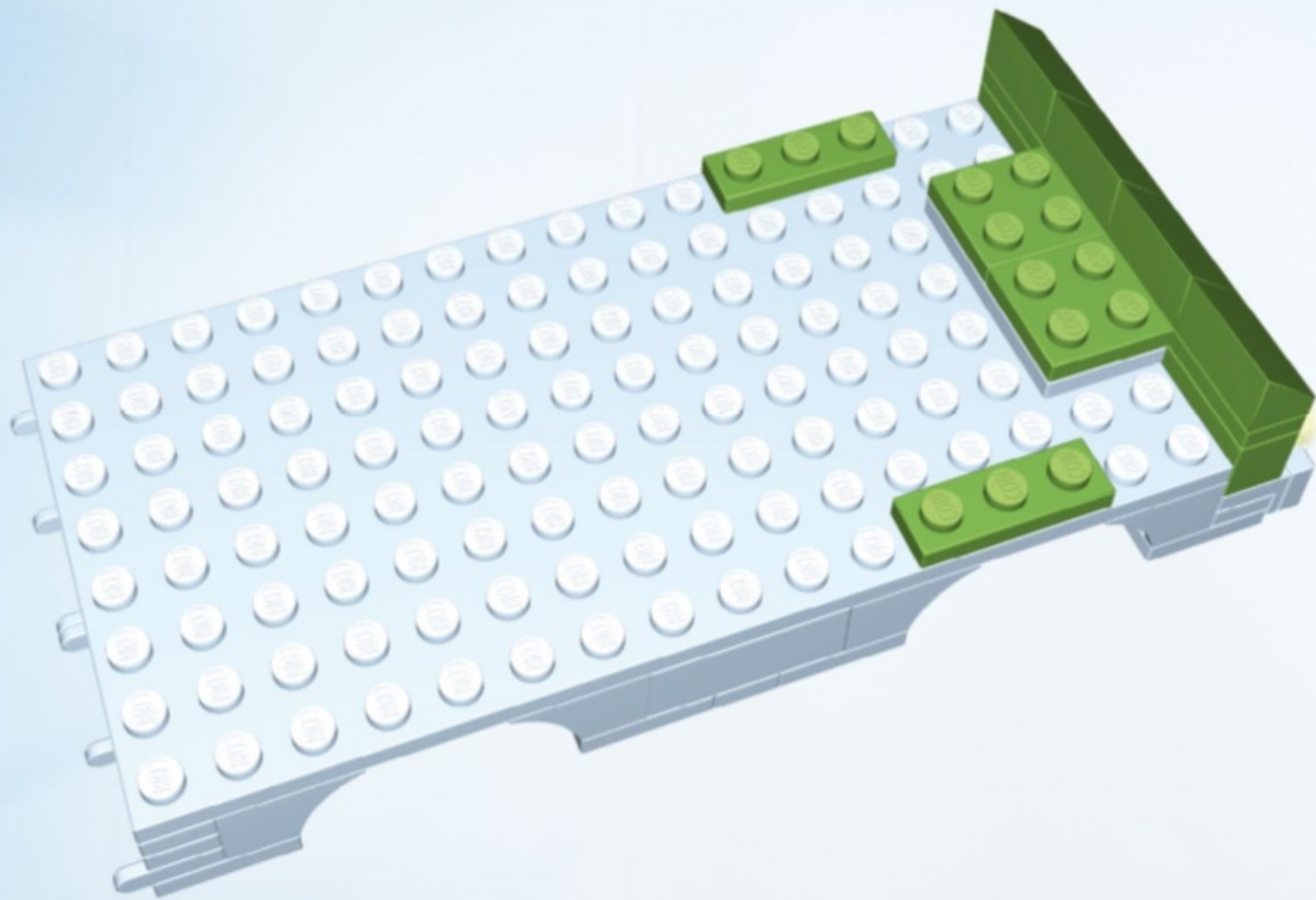

11

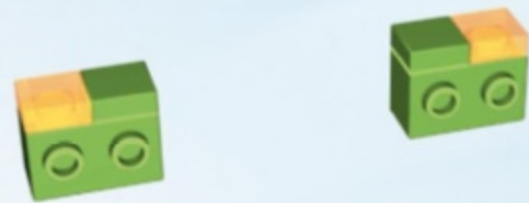

12



13

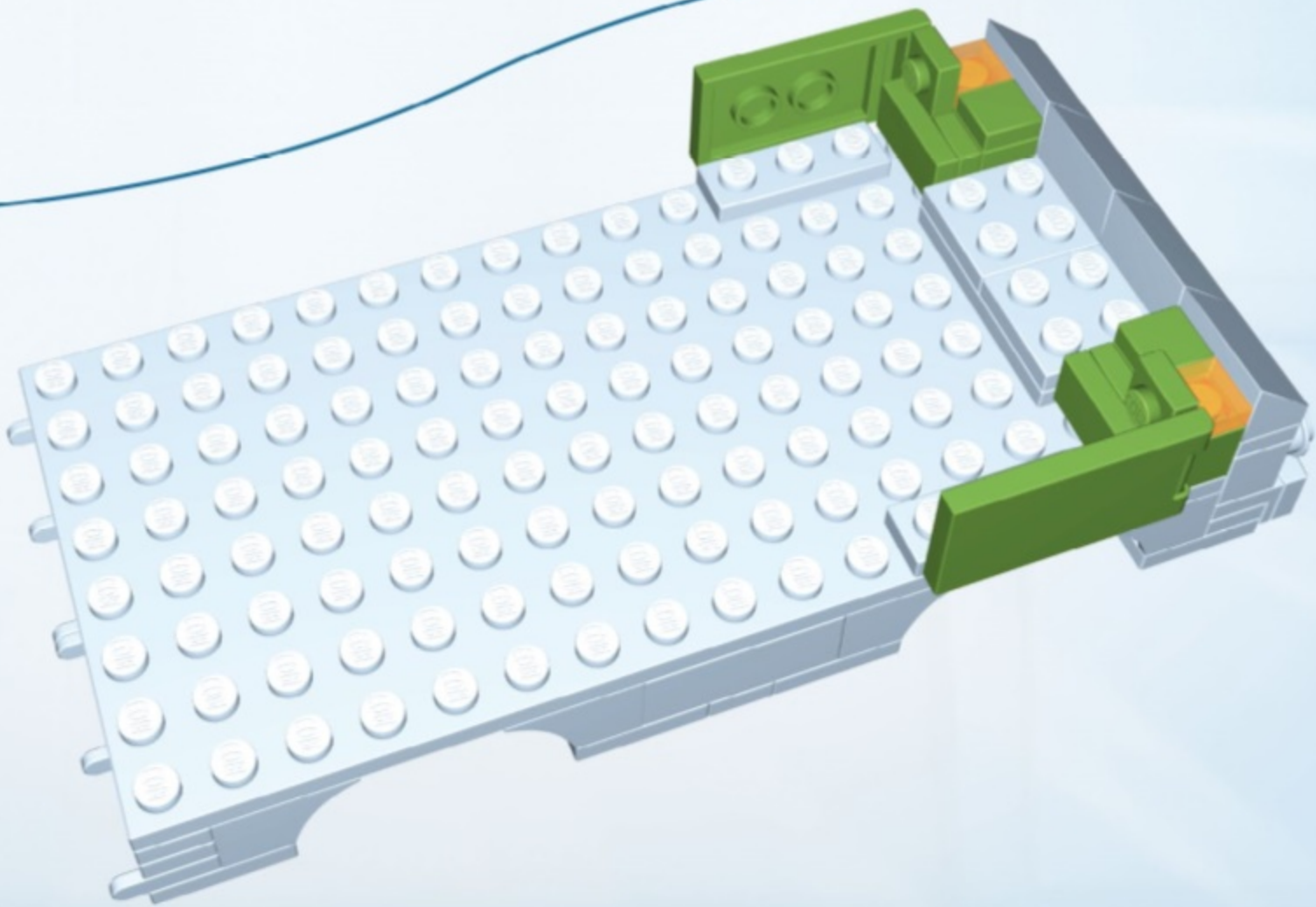

14

15

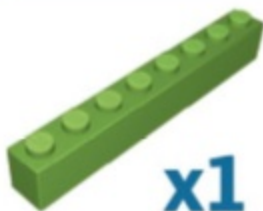
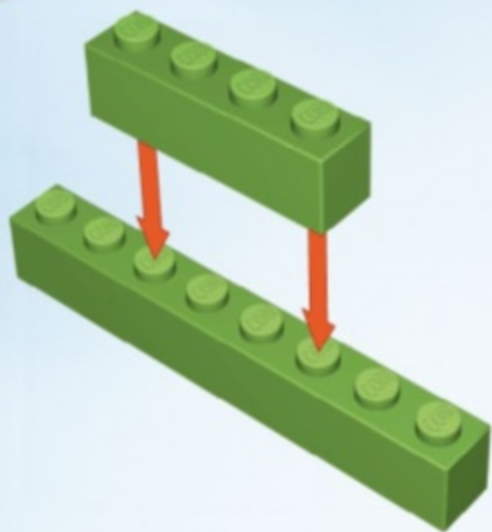

x1



x1

16

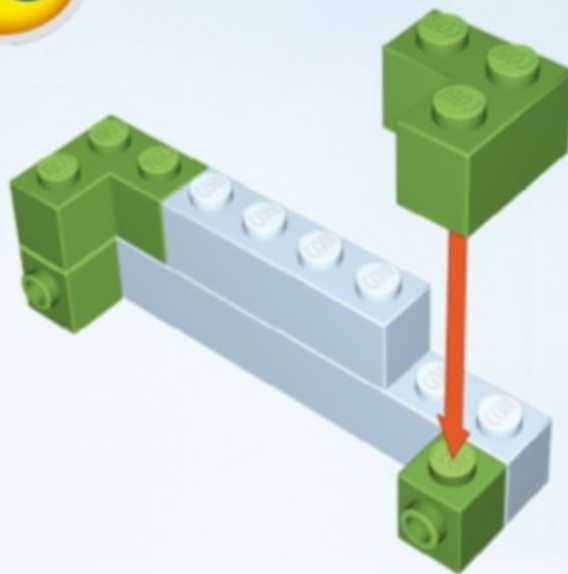

x2



x2

17

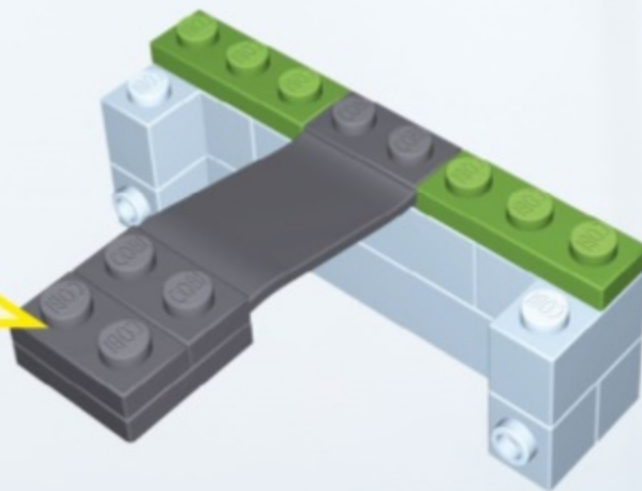
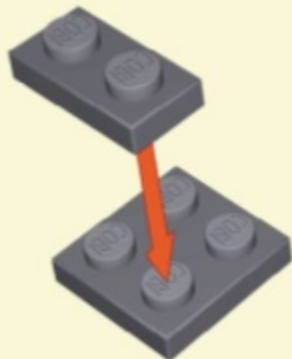

x1



x1



x1



x2

18

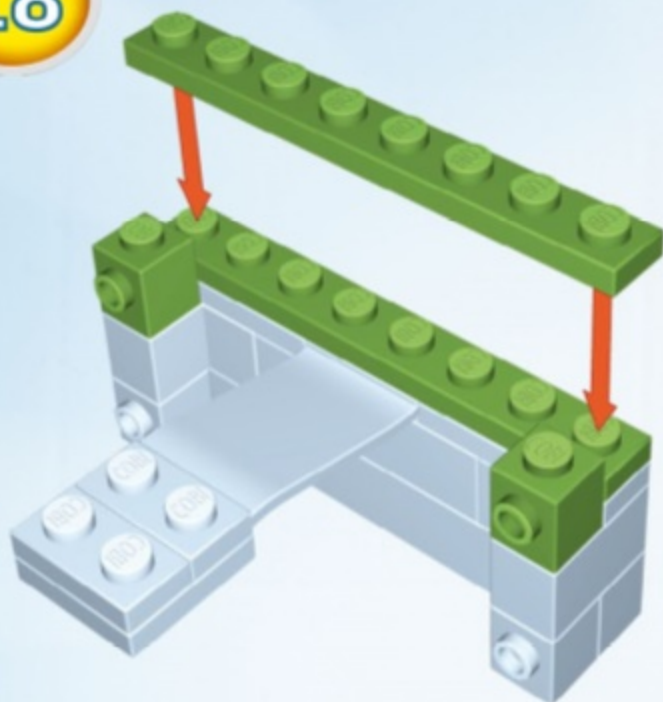

x2



x2

19

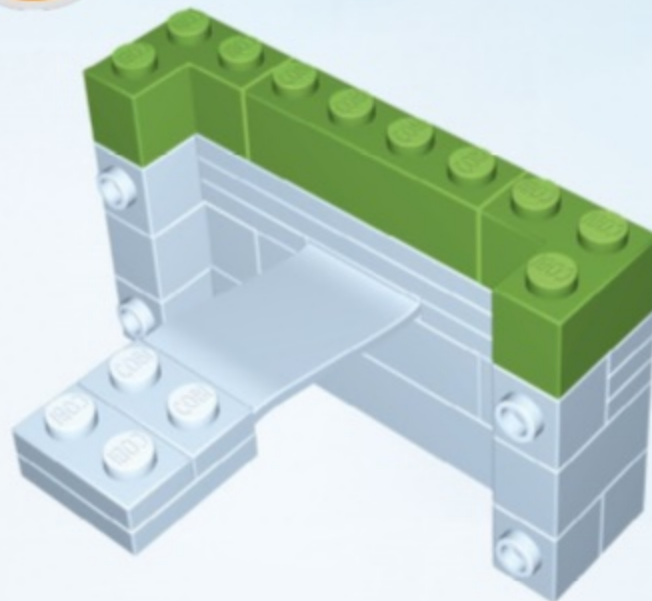

x2



x1

20

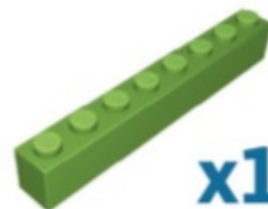
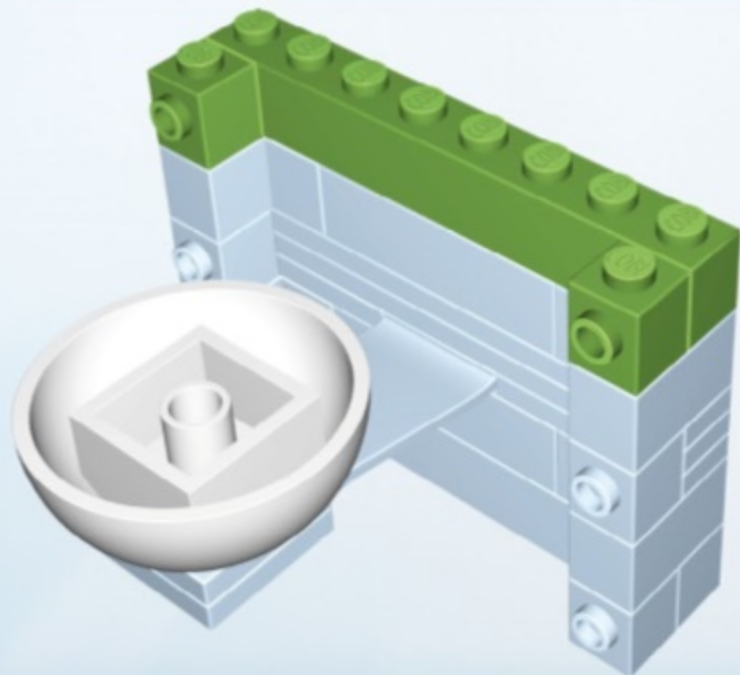

x1



x2



x1

21





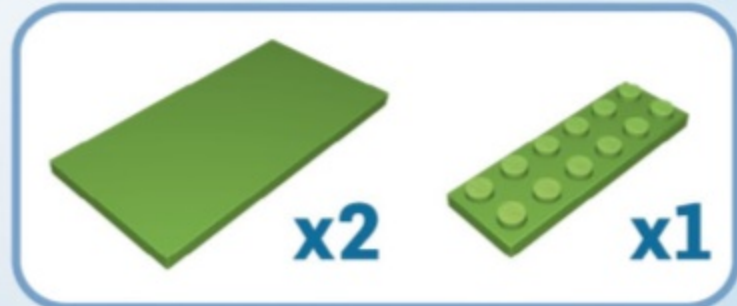
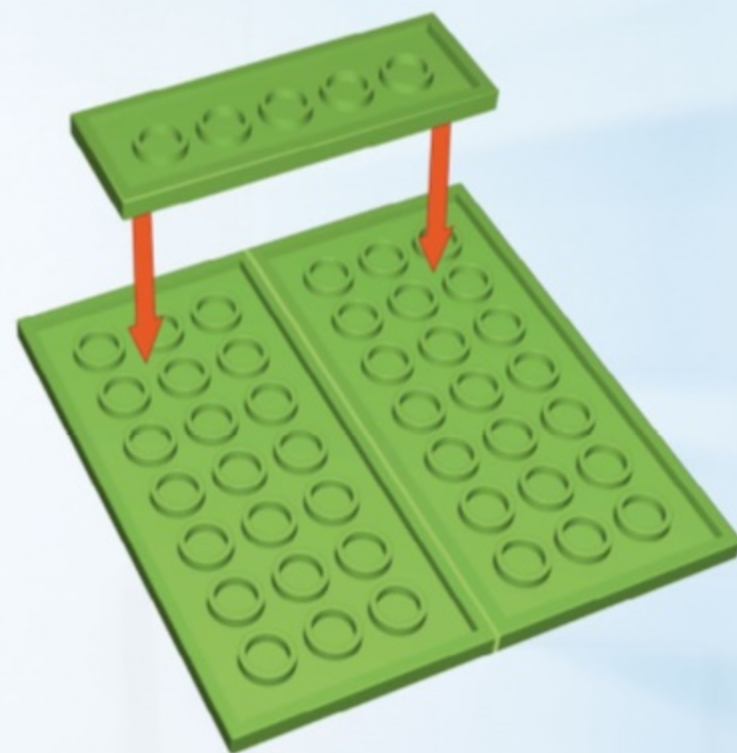

22

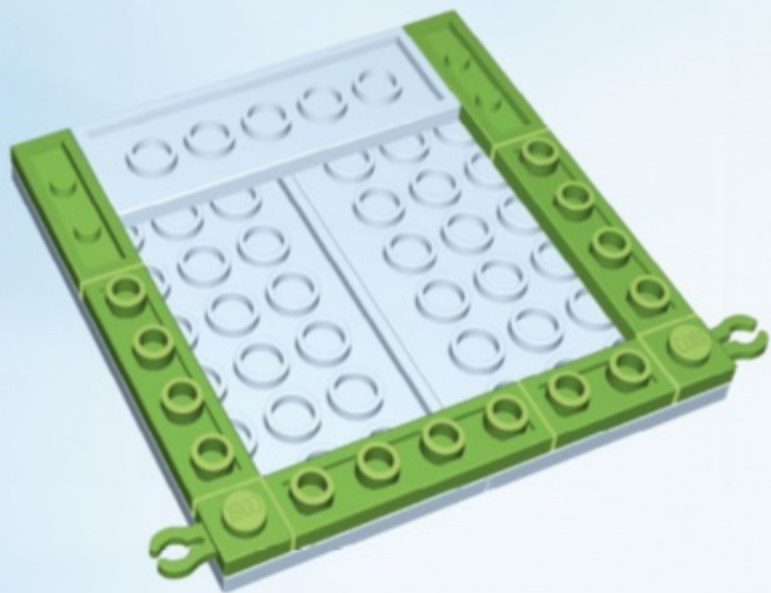

23



-  x2
-  x3
-  x1
-  x2

24

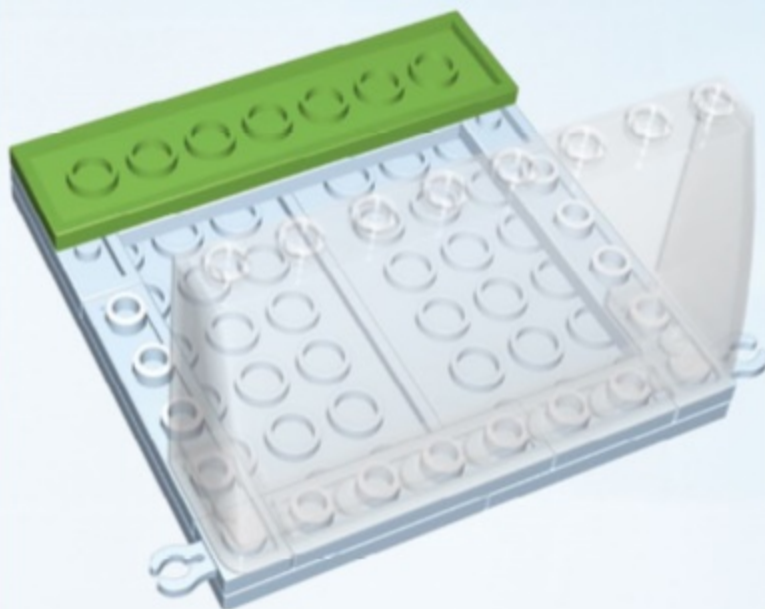

-  x1
-  x1

25

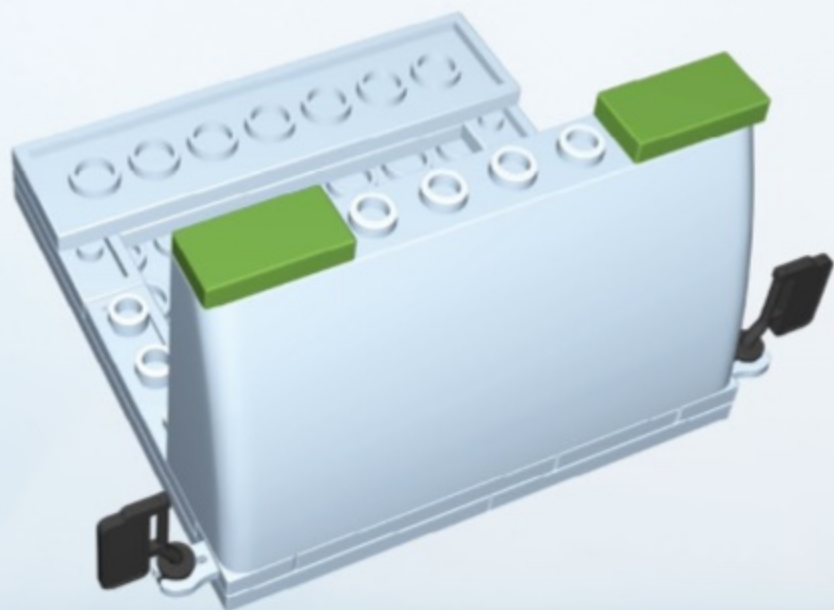

-  x2
-  x2

26

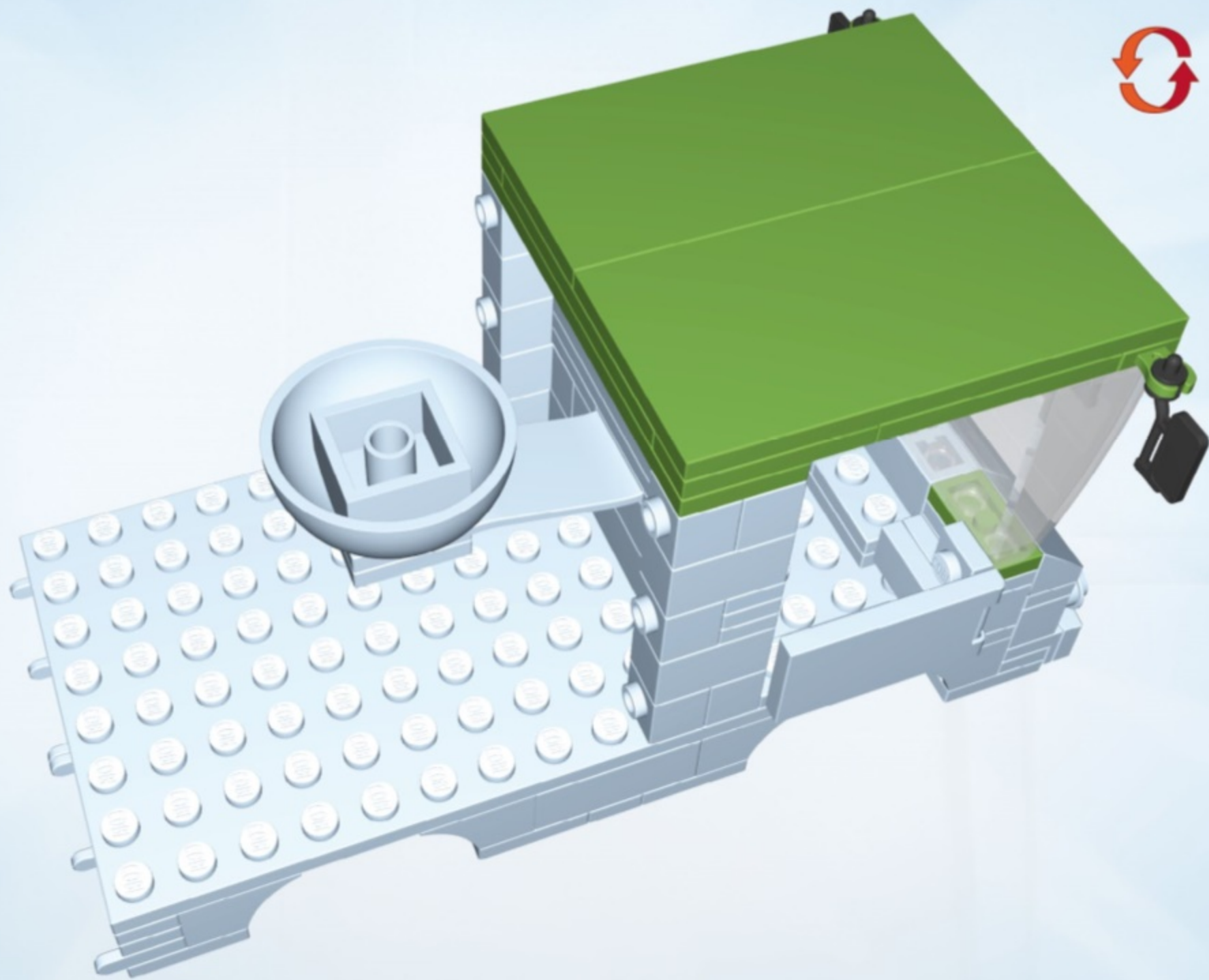

27

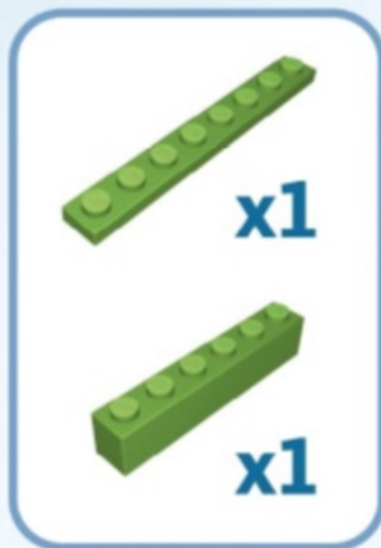
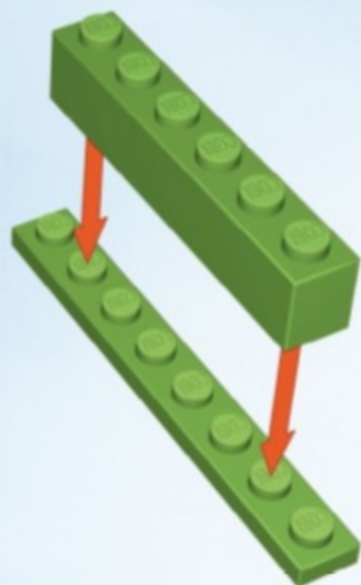

28

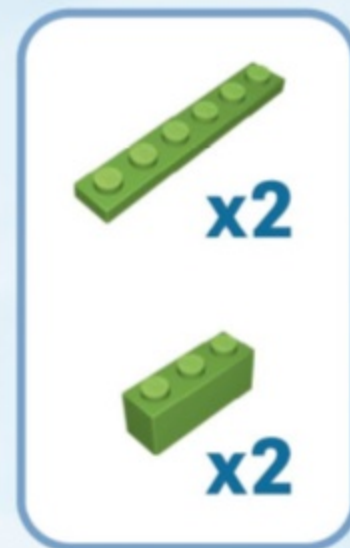
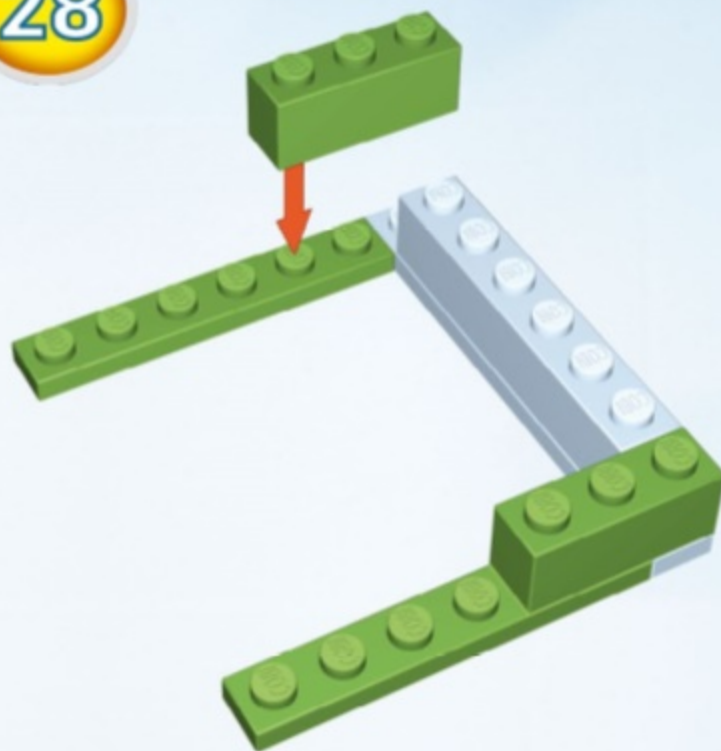

29

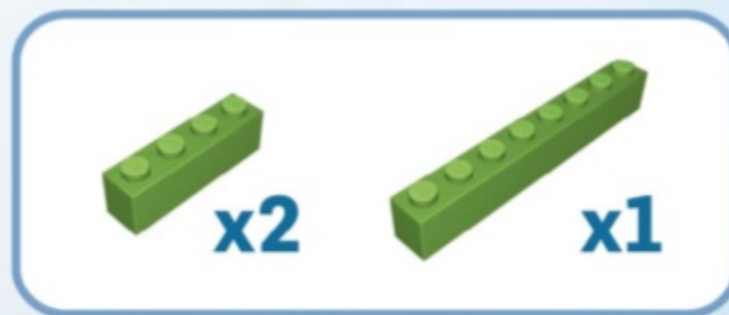
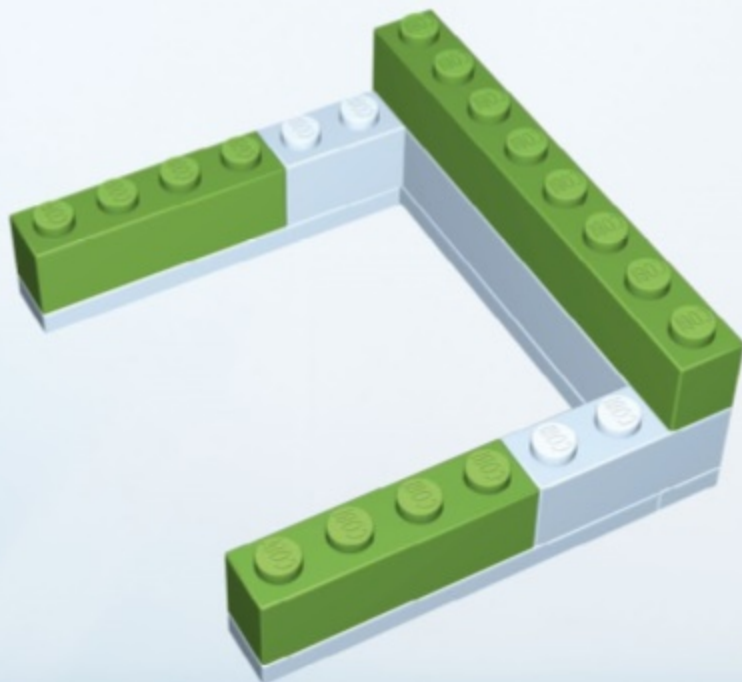

30

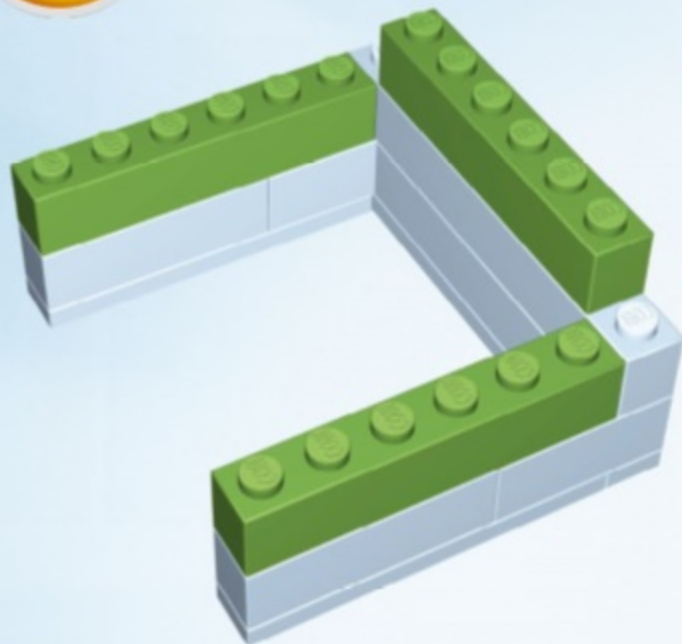

31

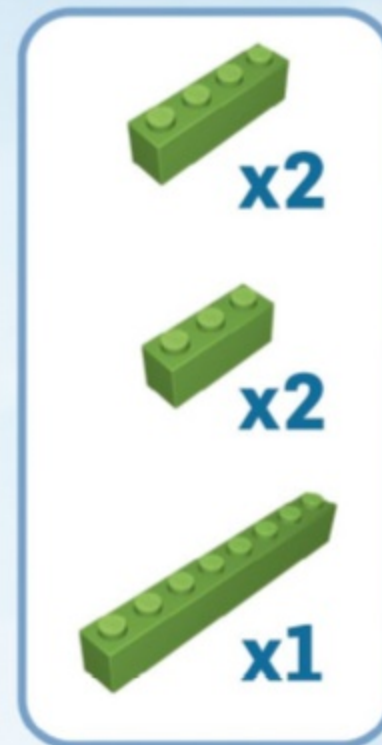
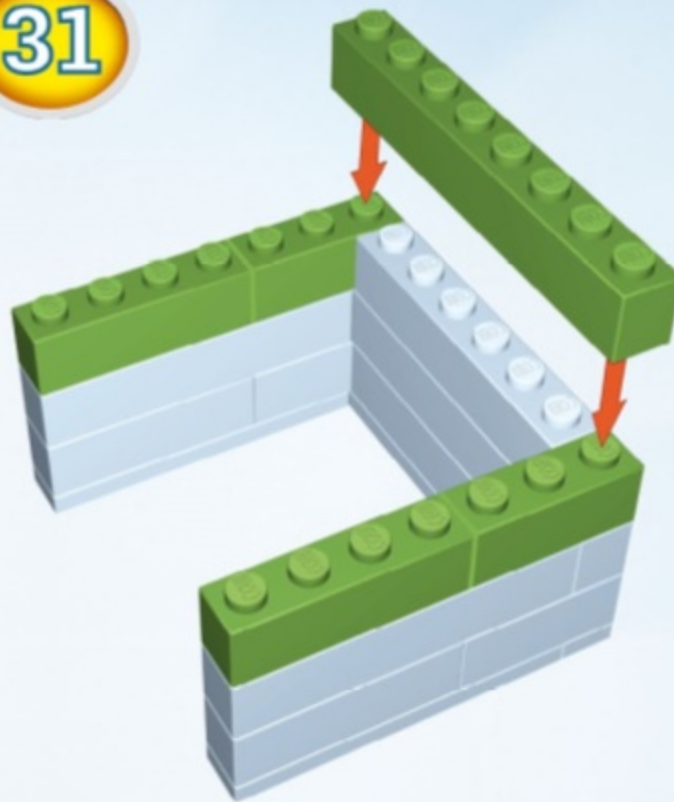

32

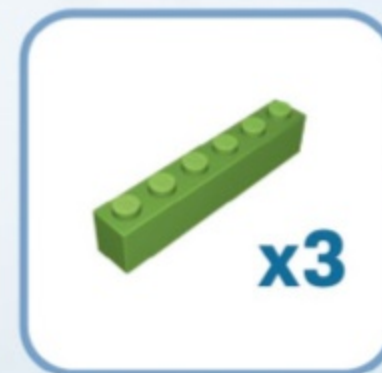
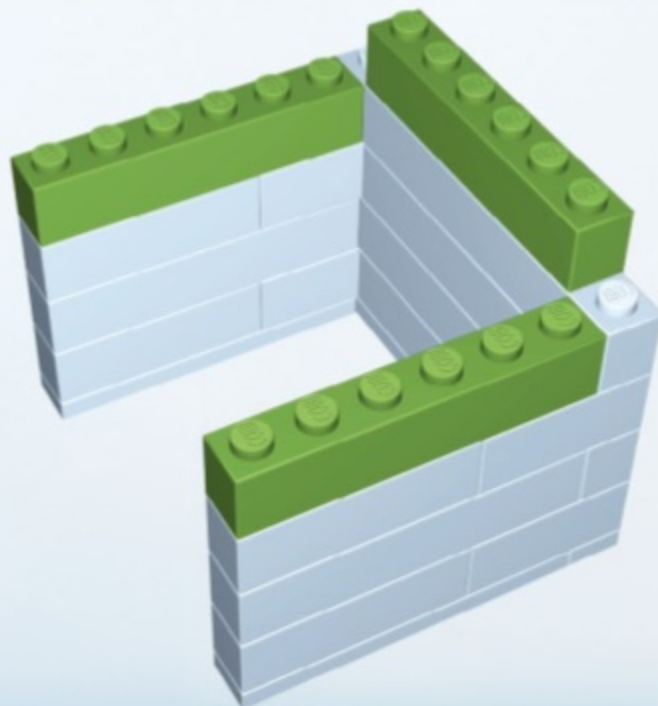

33

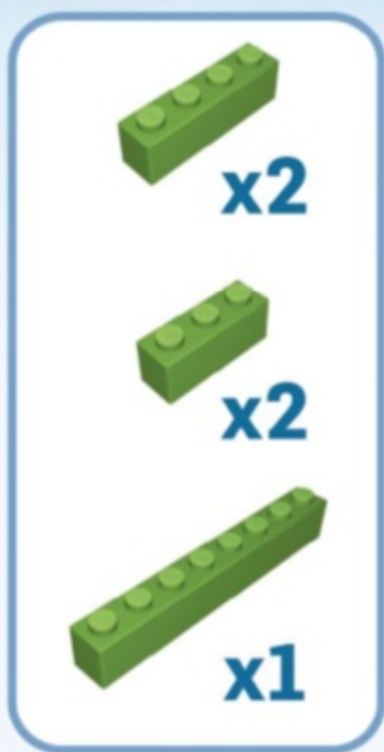
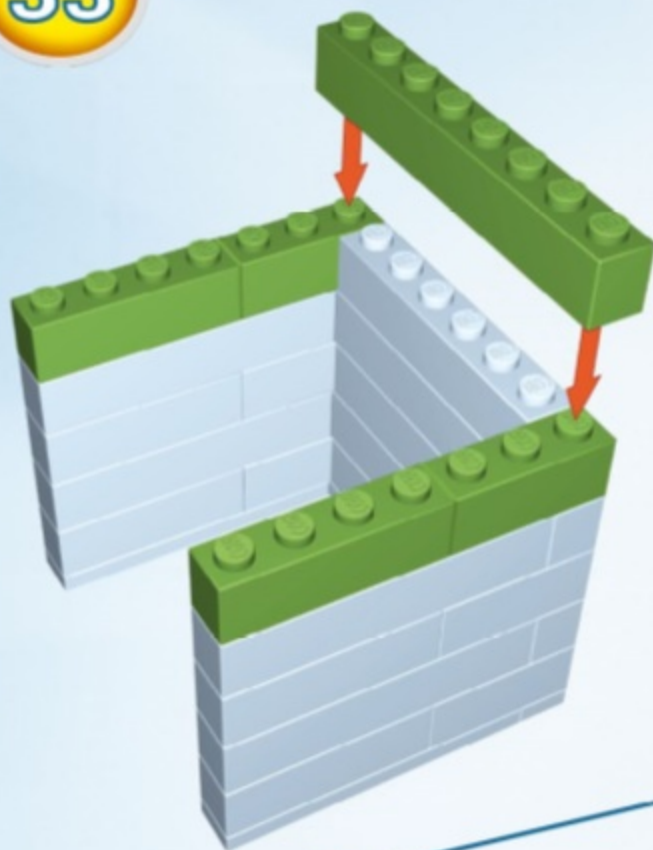

34

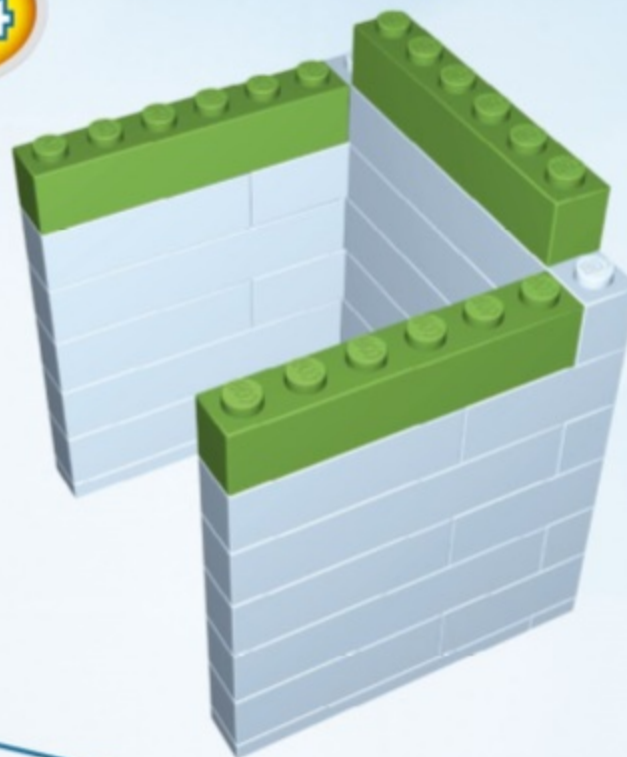

35

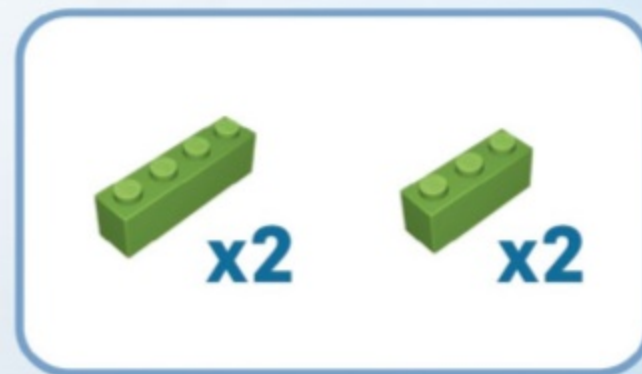
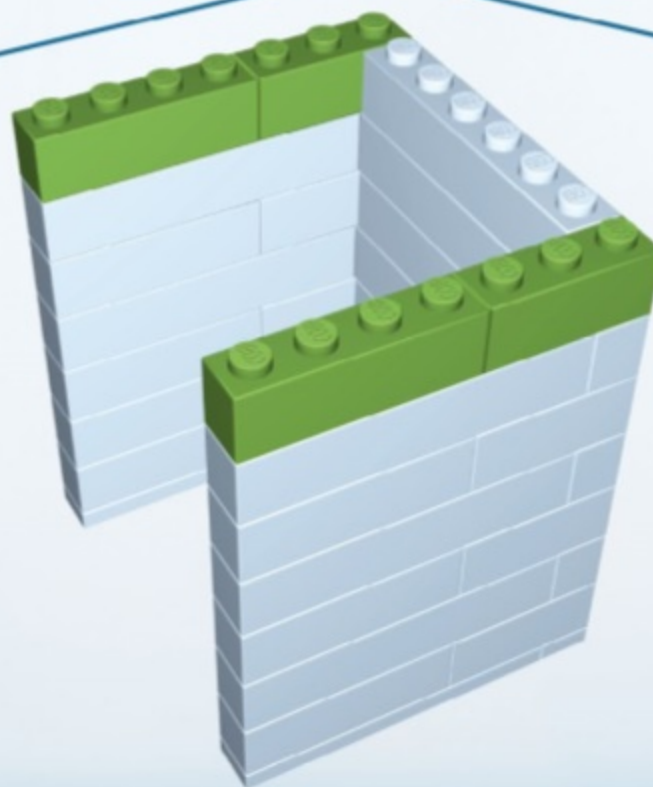

36

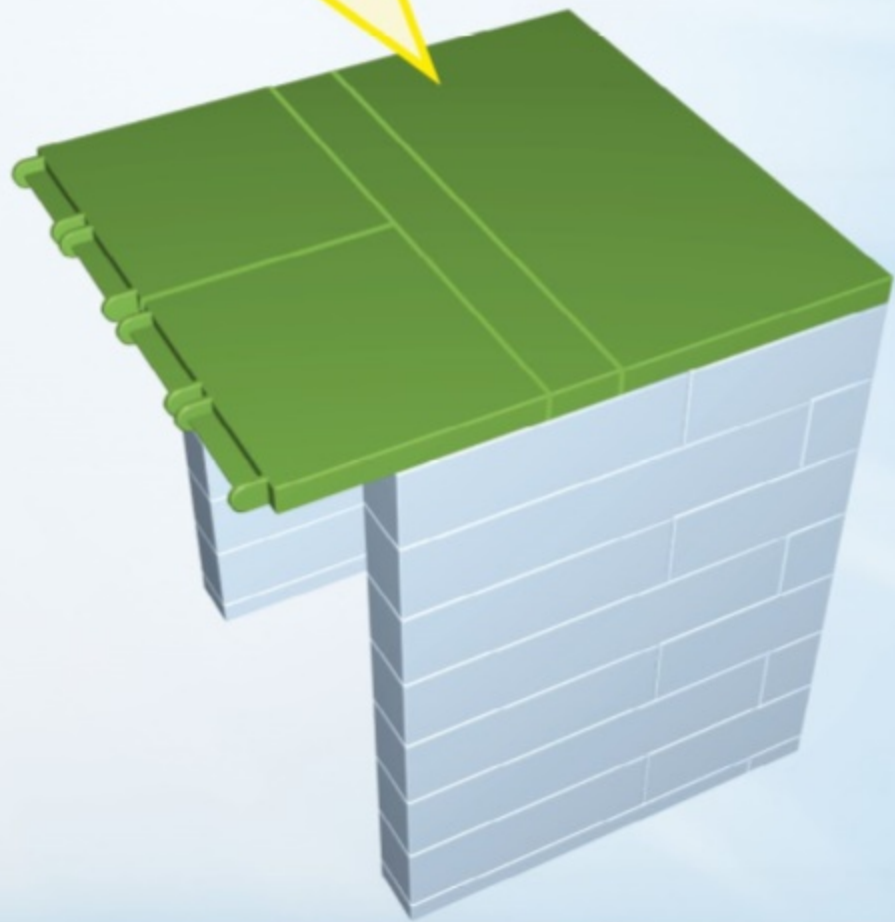
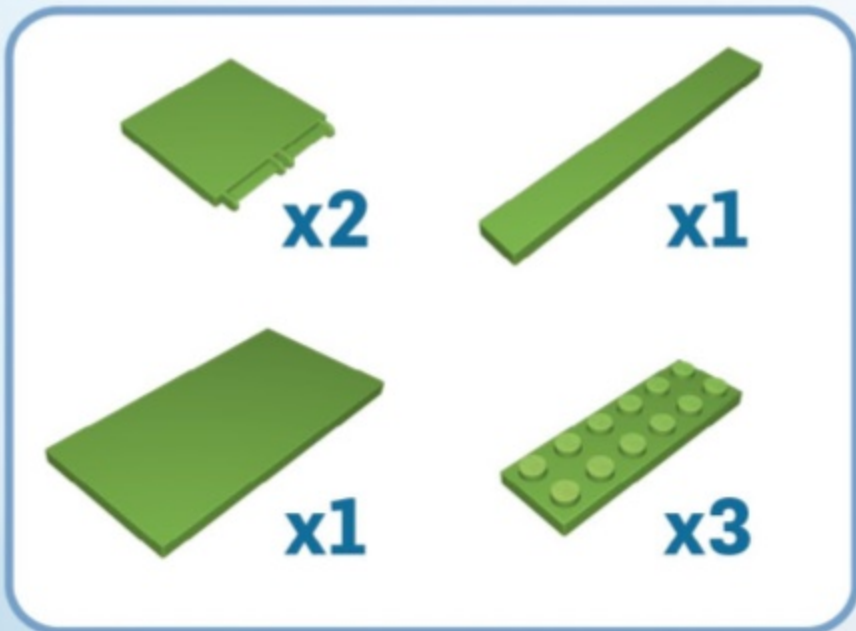
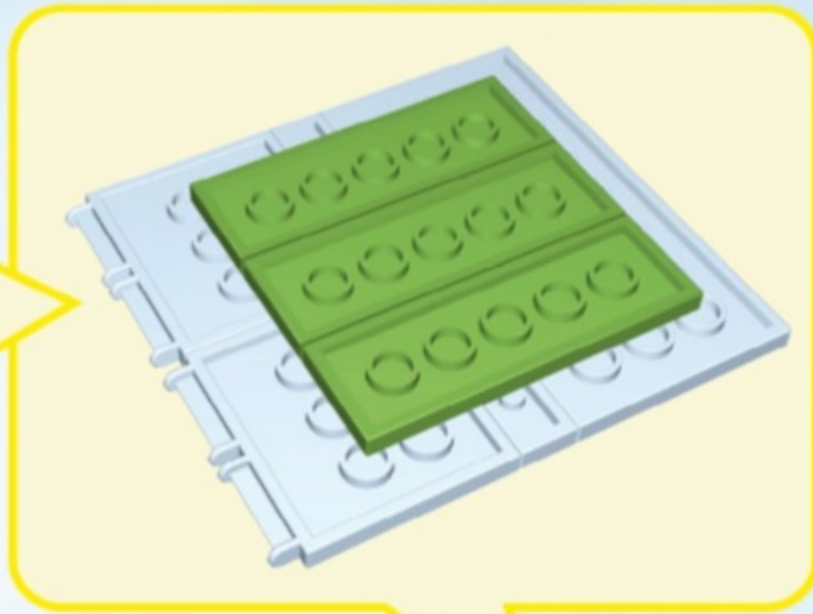
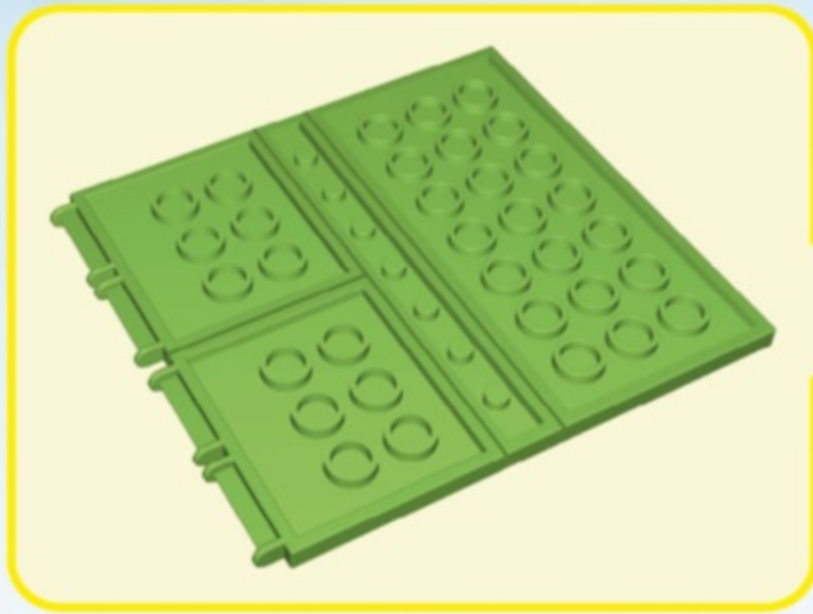

37

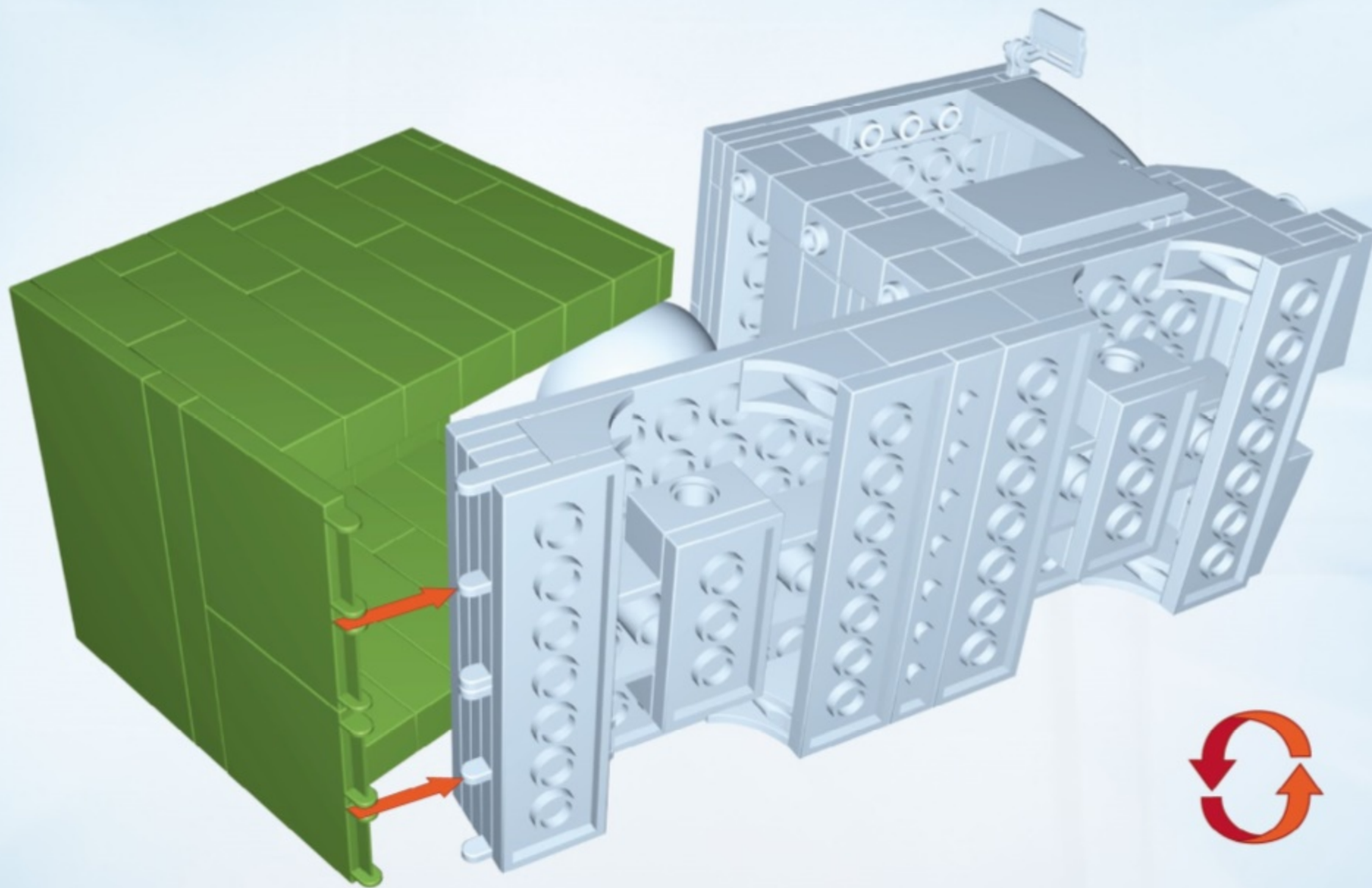

38

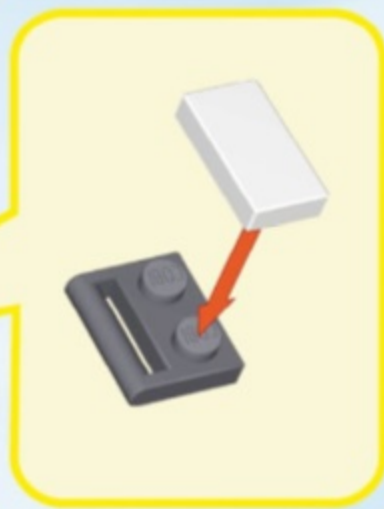

39

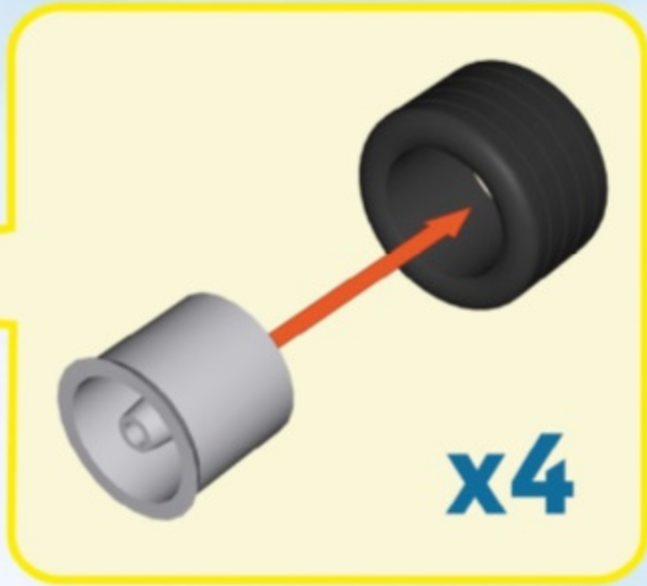
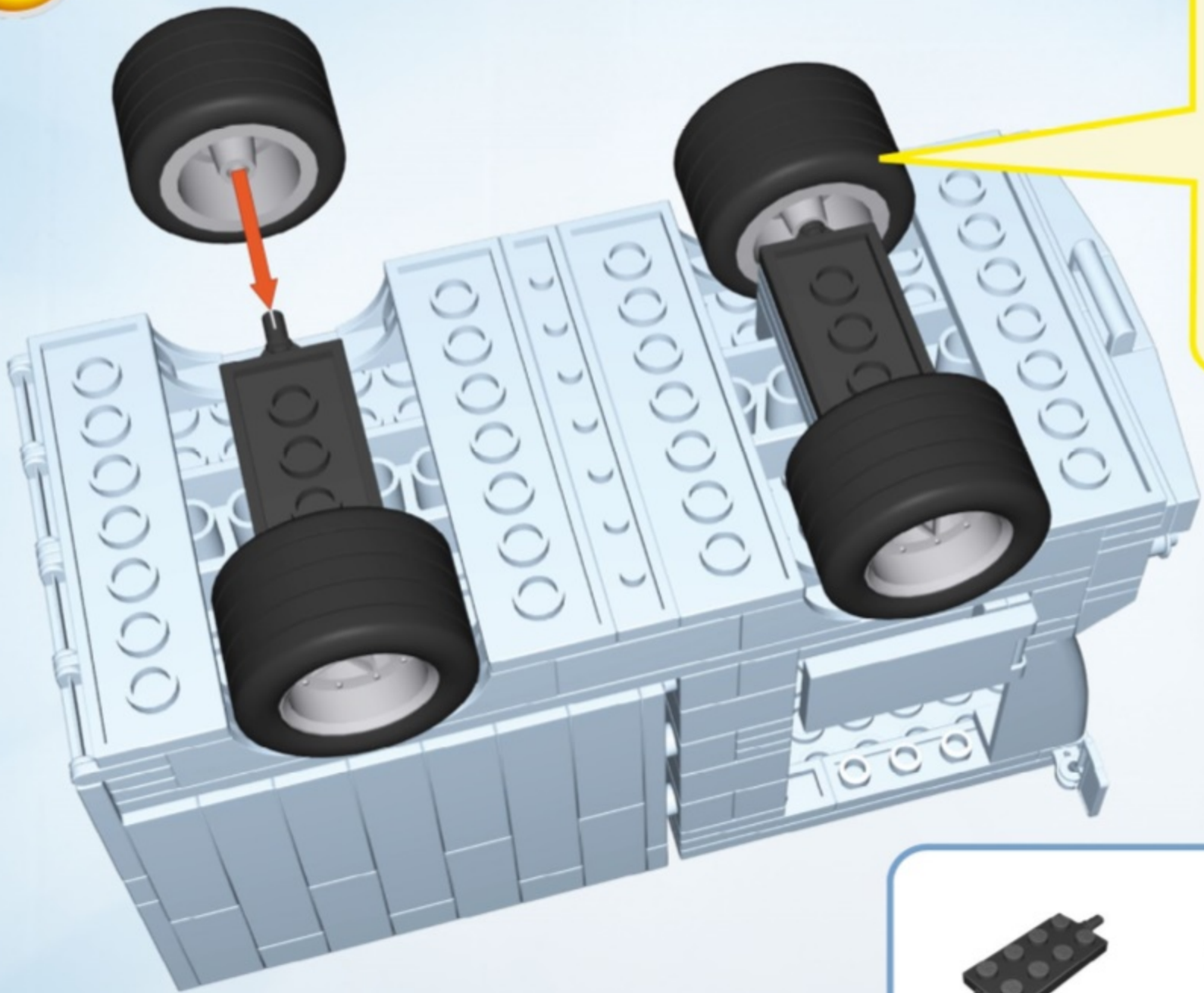



26150

Bi-Plane Bomber



26153

Swing & Smash Crane



TV 1 Helicopter



26171

Fish-E Delivery Truck



26280

The S.T.A.N.K. Mobile



26080

Golf Cart Madness



26081

Grab-A-Fish-Factory



26400

King Julien's ZOO Adventure



26231

Speed Boat Attack



26050

The Dematerializer



26051

Rat King's Revenge



26480

Penguin's Secret Mission HQ

08-26171-162

