



10222





1:1  
2X LR 41 1.5V

## EN

### Important information about batteries

Never use different types of batteries together, or a combination of old and new batteries. Always remove the batteries if the product is not to be used for a long time or if the batteries have run down. Never use damaged batteries. Only use batteries of the type recommended, or a corresponding type. Insert the batteries so that the poles are correctly positioned. Rechargeable batteries must be recharged using the correct battery charger under the supervision of an adult. You cannot recharge batteries while they are still in the product, and you must never try to do so. Never attempt to recharge non-rechargeable batteries. Never short-circuit the battery holder.

## DE

### Wichtige Information zu Batterien

Benutzen Sie niemals unterschiedliche Arten von Batterien oder alte und neue gleichzeitig. Nehmen Sie stets die Batterien heraus, wenn mit dem Modell längere Zeit nicht gespielt wird oder wenn die Batterien leer sind. Verwenden Sie niemals beschädigte Batterien. Verwenden Sie ausschließlich empfohlene bzw. geeignete Batterien. Achten Sie beim Einsetzen der Batterien auf die richtige Polung. Wiederaufladbare Batterien sollten mit einem geeigneten Ladegerät aufgeladen werden – unter der Aufsicht eines Erwachsenen. Batterien können und sollten niemals aufgeladen werden, während sie sich im Modell befinden. Versuchen Sie unter keinen Umständen, „normale“ Batterien wieder aufzuladen. Schließen Sie das Batteriefach niemals kurz.

## FR

### Informations importantes concernant les piles

Ne jamais utiliser un mélange de différents types de piles, ou de piles neuves et de piles anciennes ou déjà utilisées. Toujours retirer les piles si le produit n'est pas utilisé durant une période prolongée ou si les piles sont vides. Ne jamais utiliser de piles endommagées. Utiliser uniquement des piles du type recommandé ou d'un type équivalent. En insérant les piles, respecter scrupuleusement le sens d'orientation des pôles (+/-). Les piles rechargeables doivent être rechargées en utilisant un chargeur de piles adéquat et sous la surveillance d'un adulte. Il est impossible de recharger les piles quand elles sont installées dans le produit. Ne jamais tenter de le faire. Ne jamais essayer de recharger des piles non-rechargeables. Ne jamais court-circuiter le compartiment des piles.

## IT

### Importanti informazioni sulle batterie

Non usare mai contemporaneamente batterie di tipo diverso o batterie nuove e usate insieme. Rimuovere sempre le batterie qualora il prodotto non venga utilizzato per periodi prolungati, oppure se le batterie sono esauste. Non utilizzare mai batterie danneggiate. Usare esclusivamente batterie del tipo raccomandato o un equivalente. Inserire le batterie avendo cura che la loro polarità sia corretta. Le batterie ricaricabili vanno ricaricate in un caricabatterie di tipo idoneo e con la supervisione di un adulto. Non è possibile e non bisogna mai tentare di ricaricare le batterie mentre queste sono inserite nel prodotto. Non tentare mai di ricaricare le batterie non ricaricabili. Non cortocircuitare mai il portabatterie.

## NL

### Belangrijke informatie over batterijen

Gebruik nooit verschillende soorten of nieuwe en oude batterijen tegelijkertijd. Verwijder de batterijen altijd als je het product lange tijd niet wilt gebruiken of als de batterijen leeg zijn. Nooit beschadigde batterijen gebruiken. Uitsluitend batterijen van het aanbevolen of overeenkomstige type gebruiken. Leg de batterijen met de polen in de juiste richting. Opladbare batterijen moeten in een voor dit doel bestemde oplader en onder toezicht van een volwassene opnieuw worden opgeladen. Opladbare batterijen kunnen niet in het product worden opgeladen en je mag dit ook niet proberen te doen. Probeer nooit niet-oplaadbare batterijen op te laden. Nooit de batterijhouder kortsluiten.

## ES

### Importante información sobre las baterías

No mezclar nunca diferentes tipos de baterías, ni utilizar baterías antiguas y nuevas a la vez. Sacar siempre las baterías, si el producto no se utiliza por un largo período de tiempo o si las baterías están desgastadas. No utilizar nunca baterías dañadas. Utilizar solo el tipo de baterías recomendado o uno correspondiente. Colocar las baterías de manera que los polos estén en su posición correcta. Las baterías recargables deben cargarse con un cargador adecuado bajo la supervisión de un adulto. Las baterías no pueden, ni deben recargarse mientras permanecen en el producto. No intentar nunca recargar baterías no recargables. Asegurarse que no se produzca un cortocircuito en el porta baterías.



## RO

### Informații importante cu privire la baterii

Nu folosiți niciodată împreună tipuri diferite de baterii și nici combinații de baterii noi și vechi. Îndepărtați întotdeauna bateriile dacă produsul nu este folosit timp îndelungat sau dacă bateriile s-au epuizat. Nu folosiți niciodată baterii deteriorate. Folosiți numai baterii de tipul recomandat, sau de un tip corespunzător. Introduceți bateriile astfel ca poliul să fie în poziție corectă. Bateriile reîncărcabile trebuie reîncărcate utilizând un dispozitiv de încărcare adecvat, sub supravegherea unui adult. Bateriile nu pot fi reîncărcate cât timp sunt încă în produs, și nu încercați niciodată să le încărcați astfel. Nu încercați niciodată să reîncărcați baterii care nu sunt reîncărcabile. Nu scurtcircuitați niciodată bornele suportului bateriei.

## BG

Важна информация за батериите  
Не използвайте различни типове батерии едновременно, нито комбинация от стари и нови батерии. Винаги изваждайте батериите, ако изделието няма да се използва продължително време или ако батериите са се изтозили. Не използвайте повредени батерии. Използвайте само батерии от препоръчания тип или съответстващ на него тип. Поставайте батериите така, че полюсите да са разположени правилно. Аккумуляторните батерии трябва да се зареждат с подходящо зареждащо устройство под надзора на възрастни. Батериите не могат да се зареждат, докато са поставени в изделието, така че не трябва да се опитвате да правите това. Не се опитвайте да зареждате батерии, които не са аккумуляторни. Не свързвайте в късо съединение клемите на батериите.

## LV

### Svarīga informācija par barošanas elementiem

Nekad vienlaikus nelietojiet dažādu tipu, kā arī jaunus un vecus barošanas elementus. Arvien izņemiet barošanas elementus, ja tie izlādējušies vai to darbinātais izstrādājums ilgāku laiku netiek lietots. Nekad nelietojiet bojātus barošanas elementus. Lietojiet tikai ieteicamā tipa barošanas elementus vai tiem atbilstošus analogus. Ievietojot barošanas elementus, jāievēro pareiza to pievienojuma polaritāte (+/-). Uzlādējumu barošanas elementu lādēšanai jāizmanto atbilstošs barošanas elementu lādētājs, uzlādēšana jāveic pieaugušo uzraudzībā. Izstrādājumā ievietotus barošanas elementus uzlādēt nav iespējams, mēģinājumi to darīt nav pieļaujami. Nekad nemēģiniet uzlādēt neuzlādējamus barošanas elementus. Nekad nepieļaujiet īsslēgumu starp barošanas elementu tilpnes kontaktiem.

## ET

### Oluline teave patareide kohta

Mitte kunagi ära pane mänguasja sisse koos erinevat tüüpi patareisid, samuti vanu ja uusi patareisid. Kui mänguasja ei kasutata pika aja jooksul, võta patareid sellest välja. Ka tühjakssaanud patareid tuleb mänguasjast välja võtta. Ära kasuta kahjustatud patareisid. Kasuta ainult ettenähtud tüüpi või neile samaväärseid patareisid. Pane patareid mänguasja sisse nii, et pluss- ja miinuskllemi asend oleks õige. Akusid tuleb laadida ainult nendele ettenähtud akulaadija abil täiskasvanu järelevalve all. Akusid ei saa laadida sel ajal, kui need on mänguasja sees. Ära kunagi püüa nii teha. Ära mitte kunagi proovi akulaadijaga laadida tavalisi patareisid. Patareipesa klemmide vahel ei tohi tekkida lühisid.

## LT

### Svarbi informacija apie elementus

Nesinaudokite vienu metu skirtingų tipų elementais, taip pat su naujais elementais nenaudokite senų elementų. Išimkite elementus iš įdėklo, jeigu nesinaudosite gaminiu ilgą laiką arba jeigu elementai išsiseikvojo. Nesinaudokite sugadintais elementais. Naudokitės tik rekomenduojamo arba atitinkamo tipo elementais. Įdėkite elementus taip, kad atitiktų teigiami ir neigiami poliai. Akumuliatorinius elementus galima įkrauti tik tinkamu elementų krovikliu, prižiūrint suaugusiųsiems. Elementų negalima įkrauti, neišėmus jų iš įdėklo, ir nebandykite to daryti. Nebandykite įkrauti neakumuliatorinio tipo elementų. Nedarykite trumpo jungimo elementų įdėklo.

## TR

### Piller hakkında önemli bilgiler

Hiçbir zaman değişik tipte pilleri ya da eski pillerle yeni pilleri bir arada kullanmayın. Pili ürün uzun süre kullanılmayacaksa ya da piller bitmişse, pilleri çıkarın. Hiçbir zaman zedelenmiş piller kullanmayın. Yalnız önerilen tipte piller ya da bunların dengi olan piller kullanın. Pilleri kutupları doğru konumda olacak şekilde yerleştirin. Bitince yeniden doldurulabilen piller doğru pil doldurucuyu kullanarak, bir yetiskinin denetiminde alında doldurulmalıdır. Doldurulabilen pilleri ürününcin deneyken dolduramazsınız; hiçbir zaman bunu yapmaya çalışmayın. Hiçbir zaman, bitince doldurulamayan tip pilleri yeniden doldurmaya çalışmayın. Hiçbir zaman pil kutusunda kısa devre yapılmayın.



EN	Protect the environment by not disposing of this product with your household waste (2002/96/EC). Check with your local authority for recycling advice and facilities.
DE	Schützen Sie die Umwelt und entsorgen Sie dieses Produkt nicht mit Ihrem Hausmüll (2002/96/EC). Informationen zu Recycling-Möglichkeiten erhalten Sie bei den örtlichen Behörden.
FR	Protégez l'environnement : ne jetez pas ce produit avec vos autres déchets ménagers (Directive européenne 2002/96/EC). Contactez les autorités locales pour obtenir des informations sur le recyclage et connaître les points de collecte.
IT	Proteggi l'ambiente! Non smaltire questo prodotto con i rifiuti domestici (2002/96/EC). Per consulenza sul riciclaggio dei rifiuti e le strutture di riciclaggio, rivolgersi alle proprie autorità locali.
NL	Bescherm het milieu: gooi dit product niet samen met het andere huisvuil weg (2002/96/EC). Raadpleeg de plaatselijke instanties voor locaties van milieustation en advies over hergebruik.
ES	Proteja el medio ambiente no deshaciéndose de este producto junto con sus residuos domésticos (2002/96/EC). Solicite a su autoridad local consejos e información sobre instalaciones de reciclado.
DA	Beskyt miljøet! Smid ikke dette produkt ud sammen med husholdningsaffaldet (2002/96/EF). Få vejledning om genbrug og genbrugsstationer hos din kommune.
FI	Tämä tuote on hävitettävä ympäristönsuojelun vuoksi asianmukaisesti talousjätteistä erillään (2002/96/EC). Tietoja kierrätyspisteiden sijainnista saa kunnan tai kaupungin teknisestä virastosta.
SV	Skydda miljön genom att inte kasta denna produkt bland ditt hushållsavfall (2002/96/EC). Kontakta ditt kommun för frågor om återvinning och miljöstationer.
PT	Proteja o ambiente não eliminando este produto com o seu lixo doméstico (2002/96/CE). Consulte as autoridades locais para informação sobre reciclagem e sistemas de recolha.



EL	Προστατέψτε το περιβάλλον. Μην πετάτε αυτό το προϊόν μαζί με τα συνηθισμένα οικιακά απορρίμματα (2002/96/EC). Επικοινωνήστε με τις τοπικές αρχές σχετικά με συμβουλές και εγκαταστάσεις ανακύκλωσης.
PL	Aby chronić środowisko naturalne, nie należy wyrzucać tego produktu wraz z odpadkami z gospodarstwa domowego (2002/96/WE). W celu uzyskania wskazówek dotyczących recyklingu oraz adresów zakładów należy skontaktować się z lokalnym urzędem.
CZ	Nevyhazujte tento produkt do domácího odpadu, chraňte životní prostředí (2002/96/EC). Zjistěte si prosím u místních úřadů možnosti recyklace a dostupná zařízení.
SK	Nevyhádzajte tento produkt do domáceho odpadu, chráňte životné prostredie (2002/96/EC). Zistite si prosím na miestnych úradoch možnosti recyklácie a dostupné zariadenia.
HU	Környezetét óvja, ha ettől a terméktől nem a háztartási hulladékkal együtt válik meg (2002/96/EC). Érdeklődjék a lakóhelyéhez közel eső hatóságnál az újrahasznosítás módjáról és lehetőségeiről.
SL	Zaščitite okolje! Okolje varujte tako, da tega izdelka ne zavržete skupaj z gospodinjstskimi odpadki (v skladu z direktivo 2002/96/ES). Pri krajevni upravi preverite, kakšne možnosti in kateri obrati za recikliranje obstajajo v vaši okolici.
LV	Lai saudzētu vidi, neizmetiet šo izstrādājumu kopā ar sadzīves atkritumiem (2002/96/EC). Vērsieties vietējās varas iestādēs, lai noskaidrotu, kur un kā tas nododams pārstrādei.
ET	Keskkonda saate kaitsa nii, et ei kõrvalda seda toodet koos olmejäätmetega (2002/96/EÜ). Nõuandeid toote taaskasutusse võtmise ja ümbertöötlemispunktide kohta saate asjaomaset kohalikult asutuselt.
LT	Saugokite aplinką – nemeskite šio produkto kartu su buitiniemis atliekomis (2002/96/EB). Atsižvelkite į savo vietos valdžios rekomendacijas dėl pakartotinio panaudojimo ir sąlygas.

1

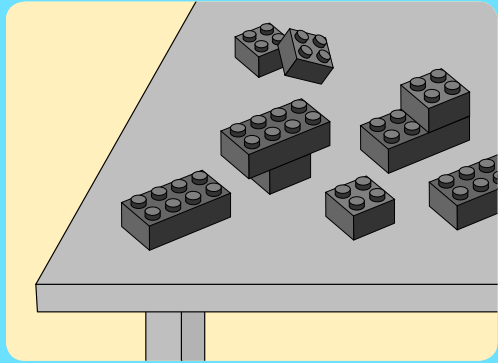
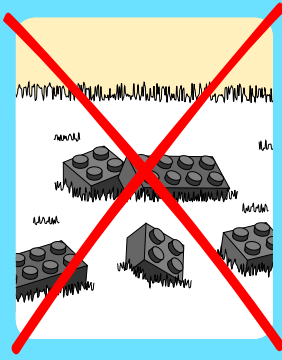

2

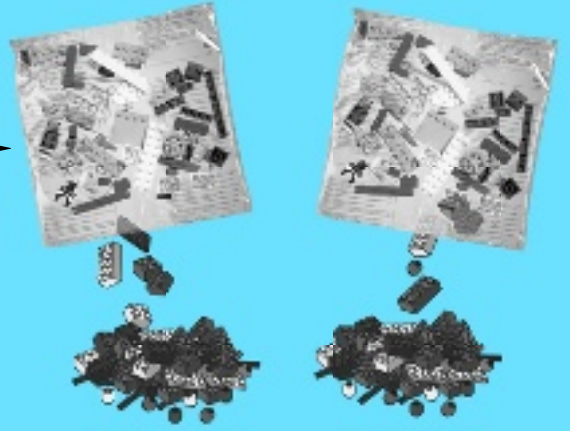



1

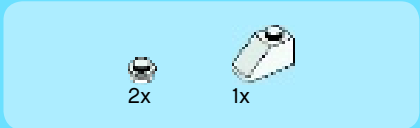
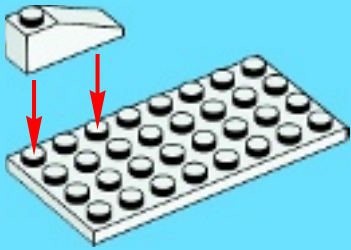

2

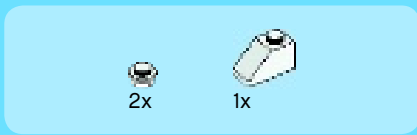

3

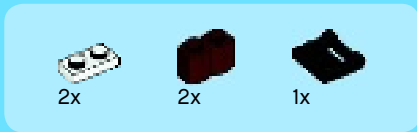

4

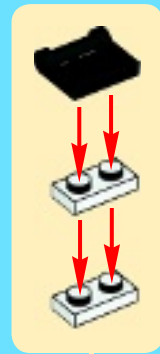



5

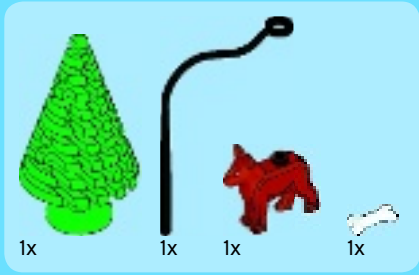
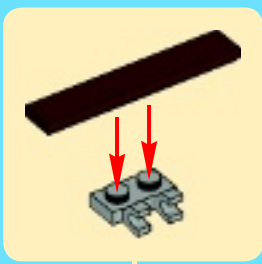

6



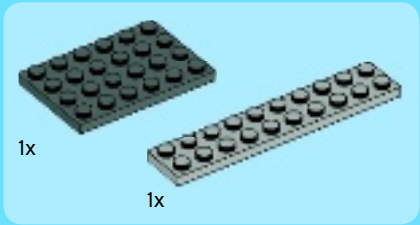

1

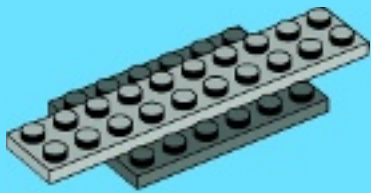

2

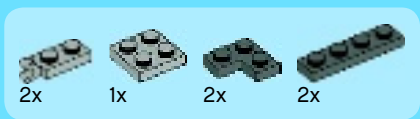
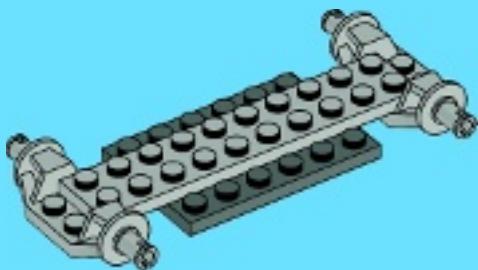

3

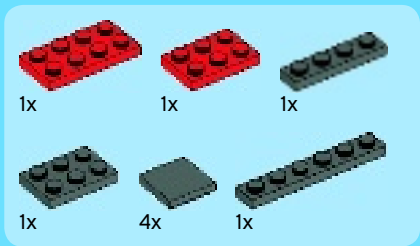
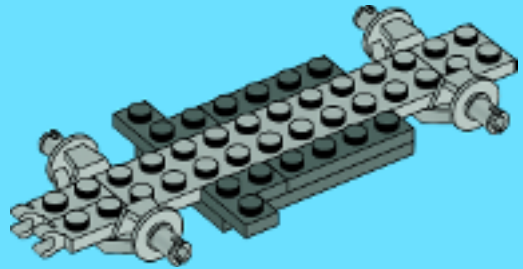

4

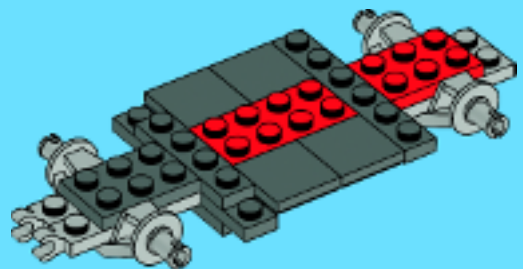



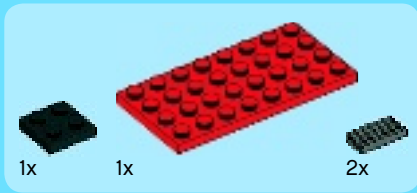

5

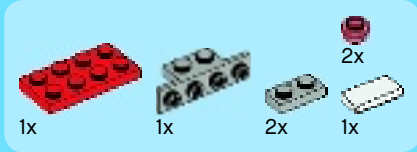
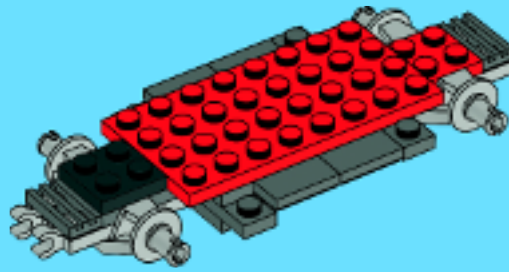

6

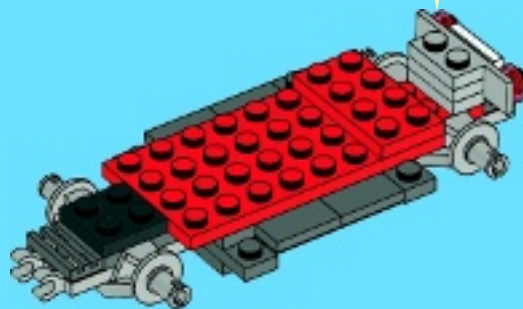
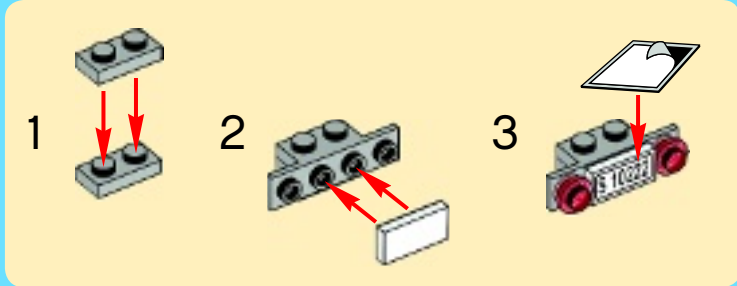

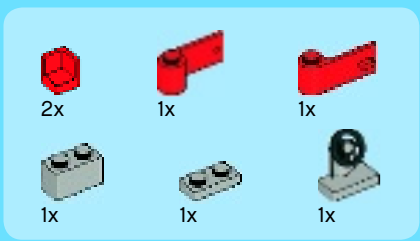

7

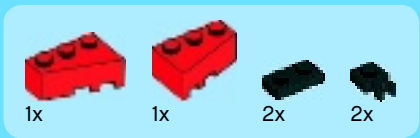
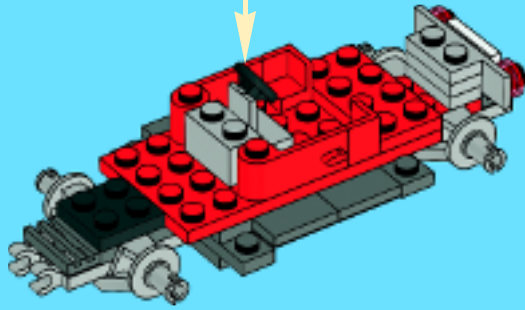
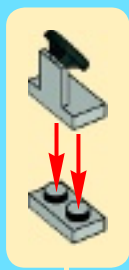

8

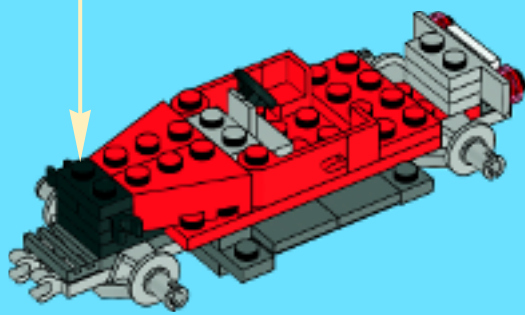
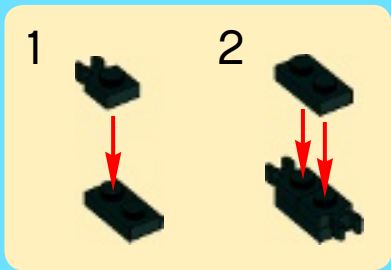

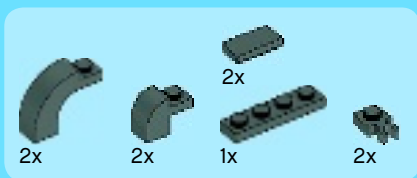

9

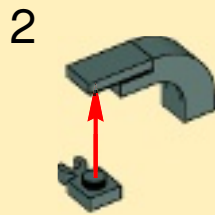
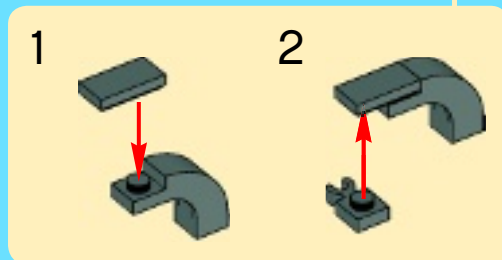
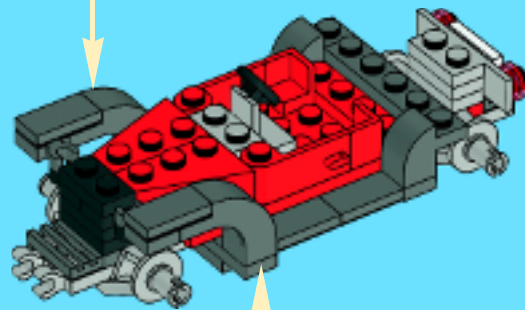
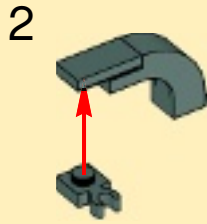
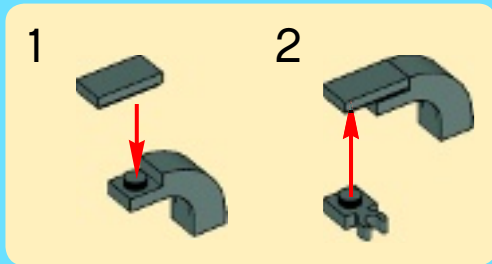



2x



1x



2x

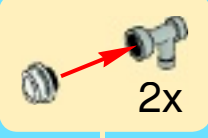

2x

# 10

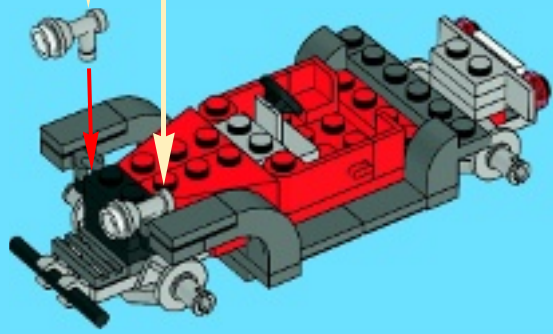

1x



1x



1x



1x



1x

# 11

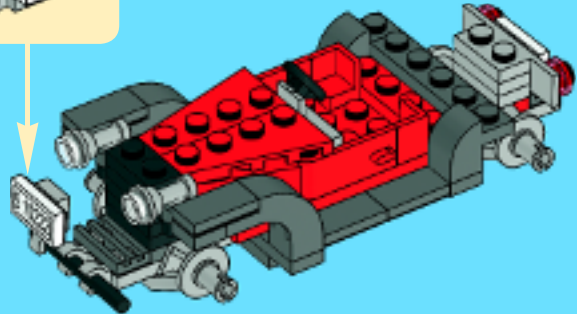
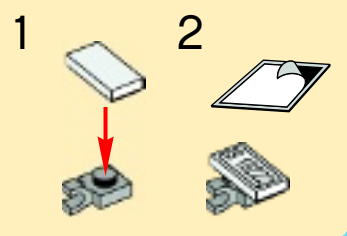

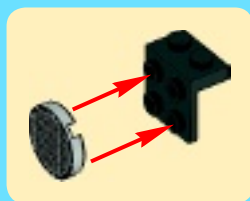
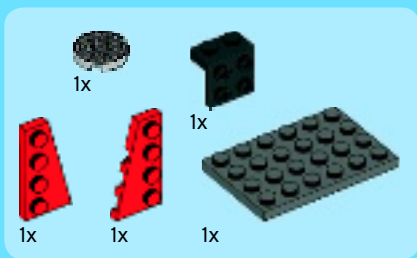

12

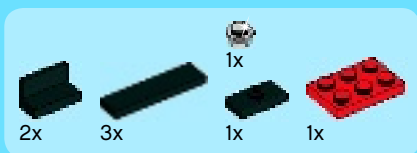
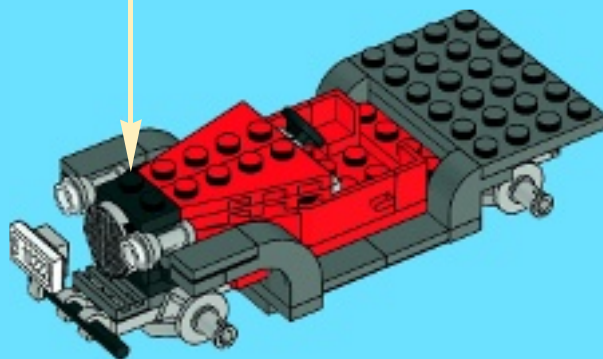

13

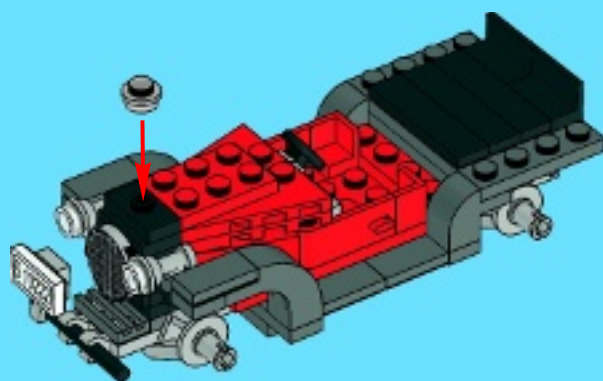



1x



1x

1

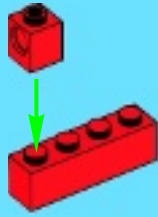

1x



1x

2

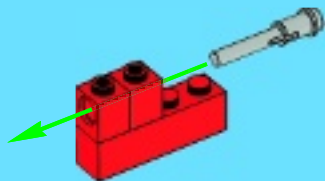

2x



1x

3

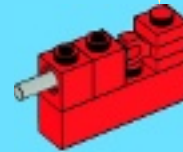
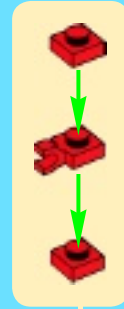

1x



1x

4

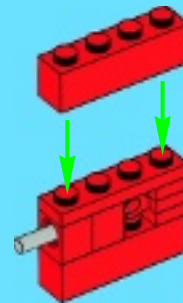



2x



1x

5

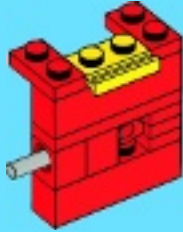

2x



2x

6

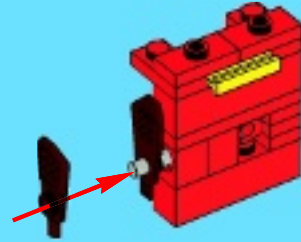

14

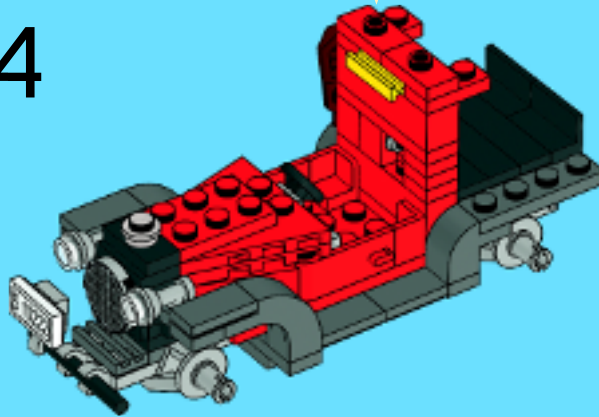



2x

# 15

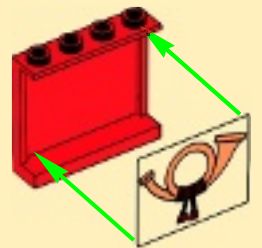
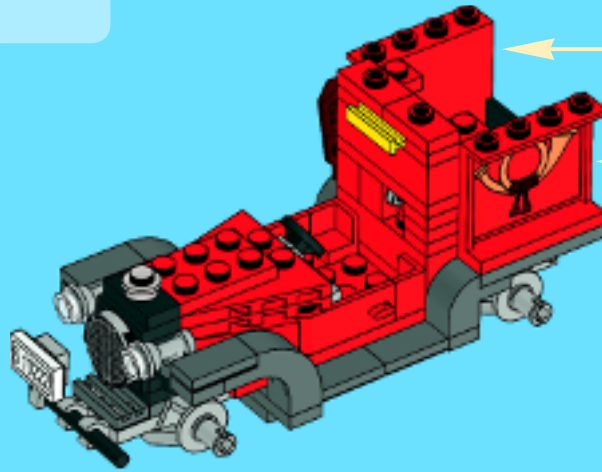

2x



# 16

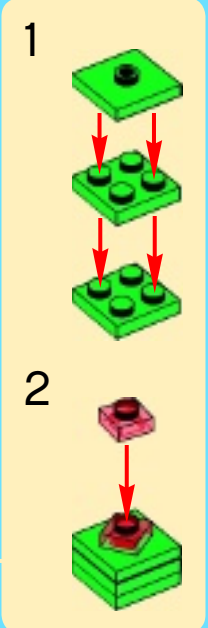
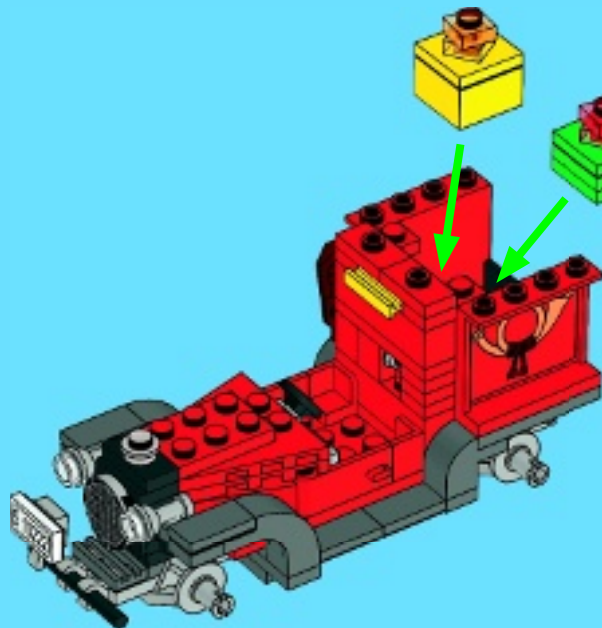
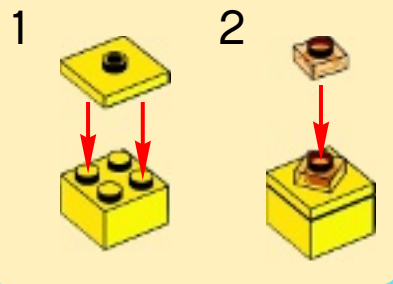





1x

# 17

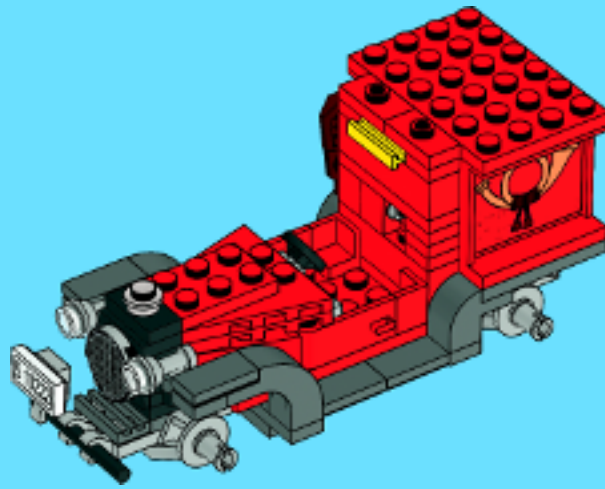

8x



1x

# 18

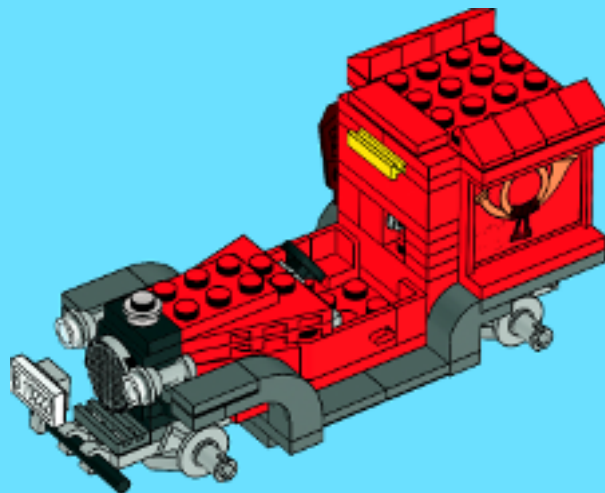



2x



2x



1x

# 19

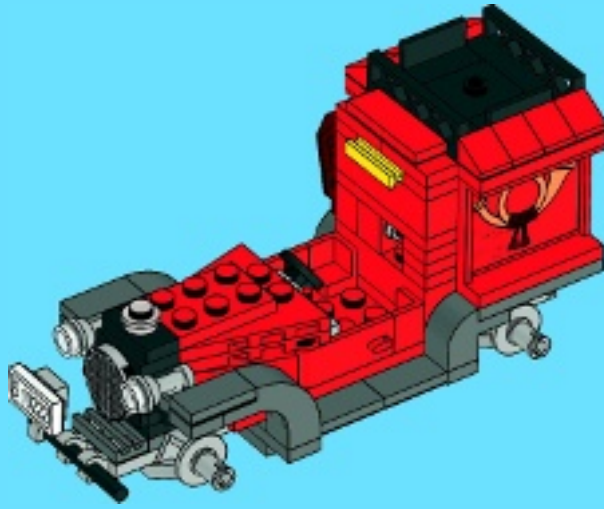

2x

# 20

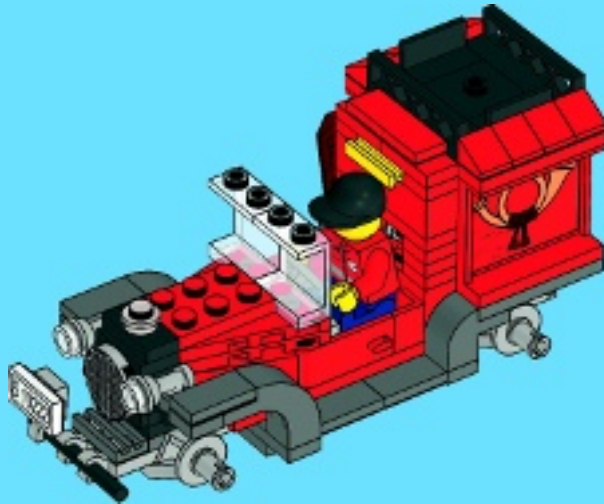



1x



1x

# 21

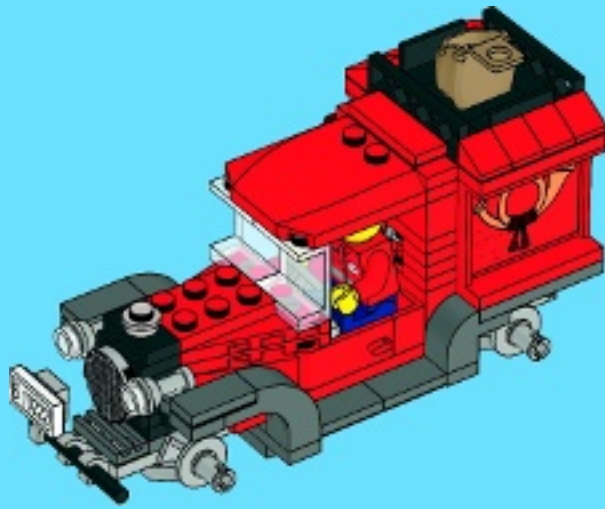

4x



4x

# 22



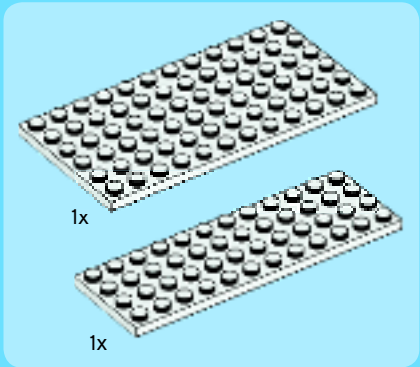

1

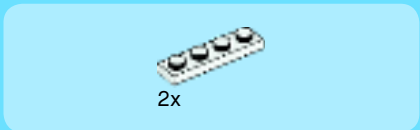
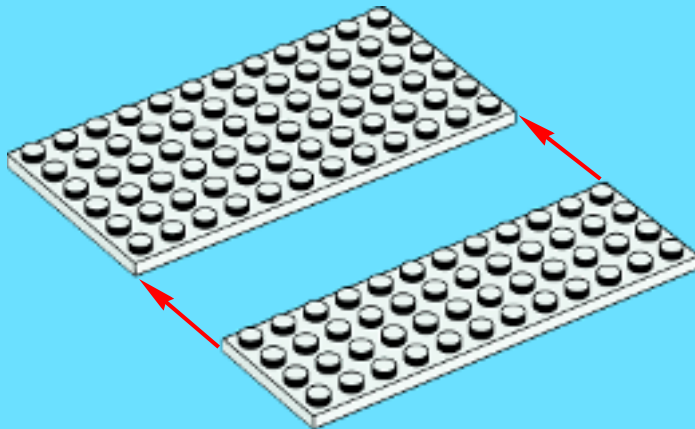

2

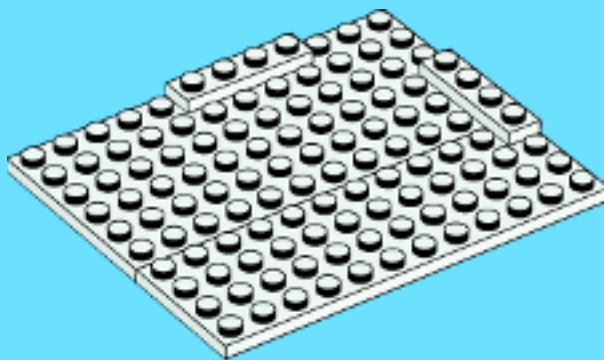



3x

# 3

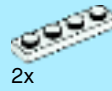
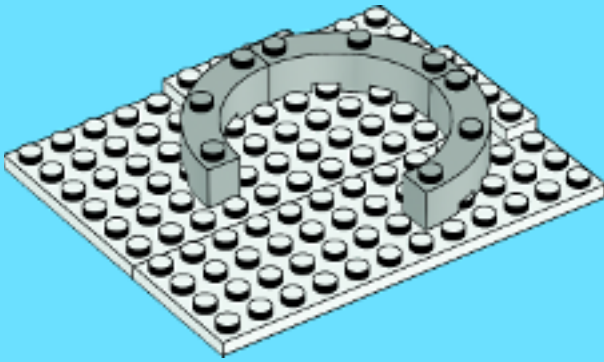

2x



1x



1x

# 5

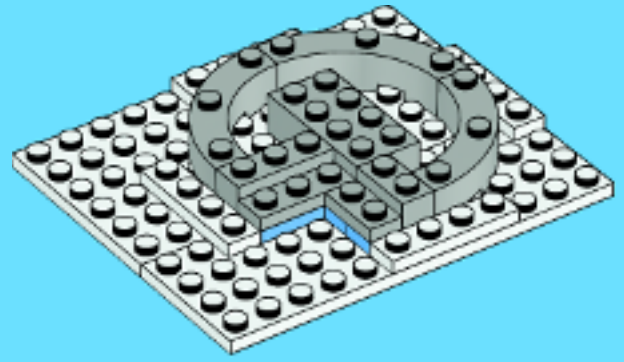

2x



1x



1x

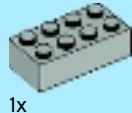

1x



1x

# 4

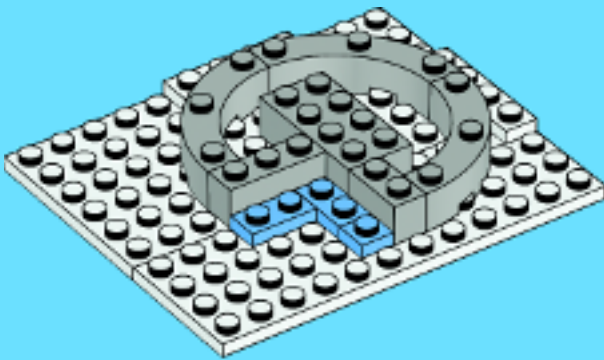

4x



1x



2x



1x

# 6

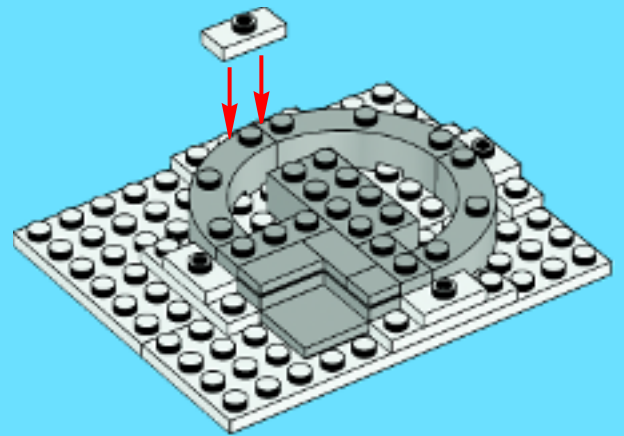



3x



1x



3x

# 7

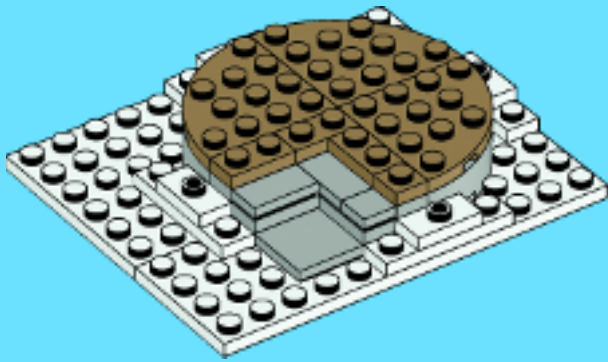

4x



3x

# 9

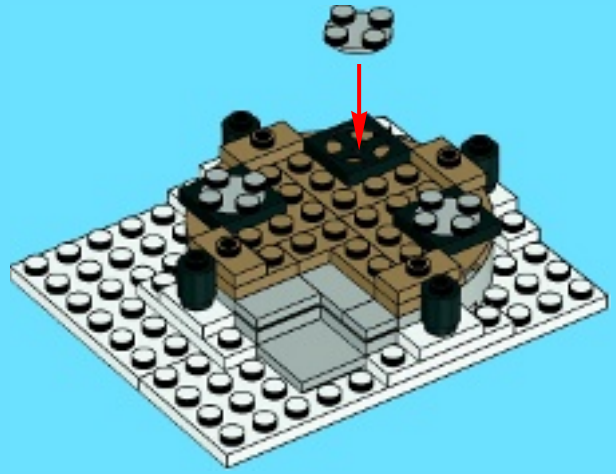

3x



4x

# 8

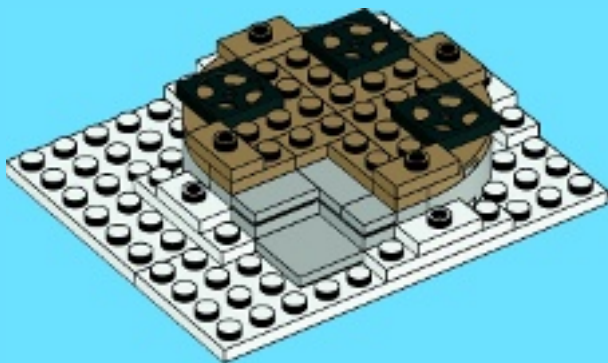

3x

# 10

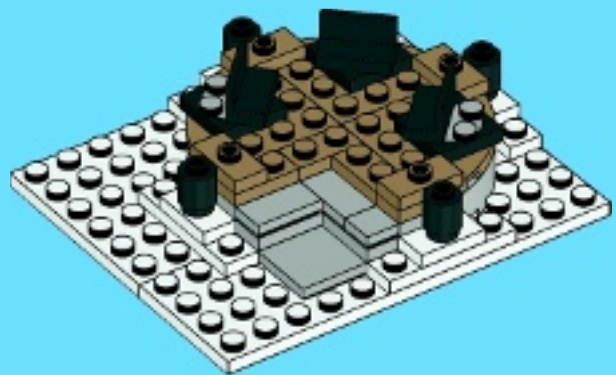



# 11

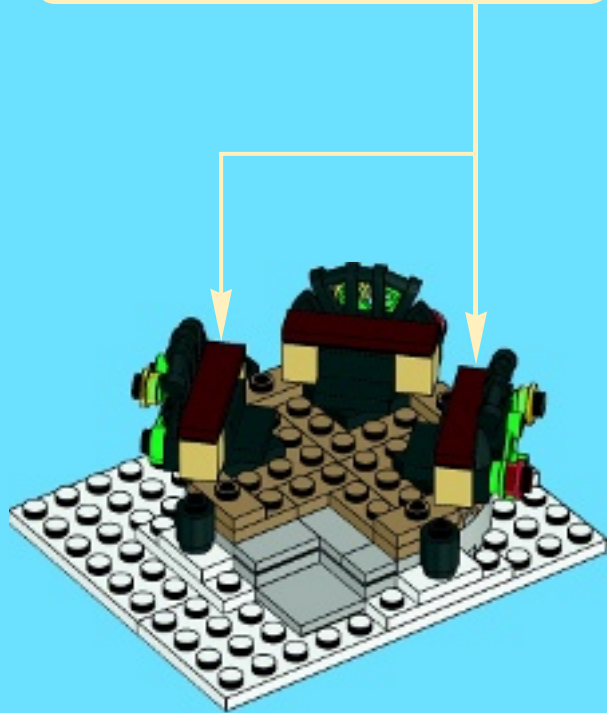
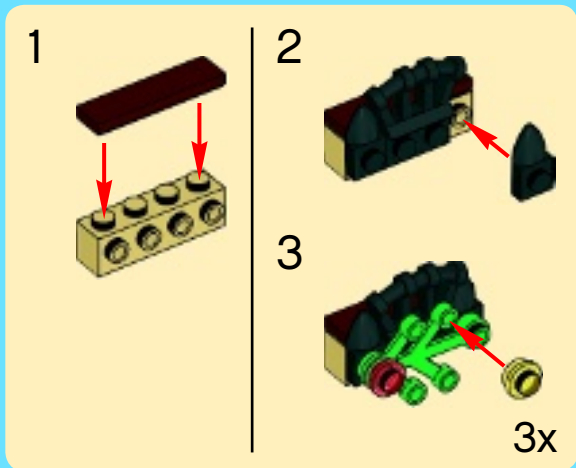

# 12

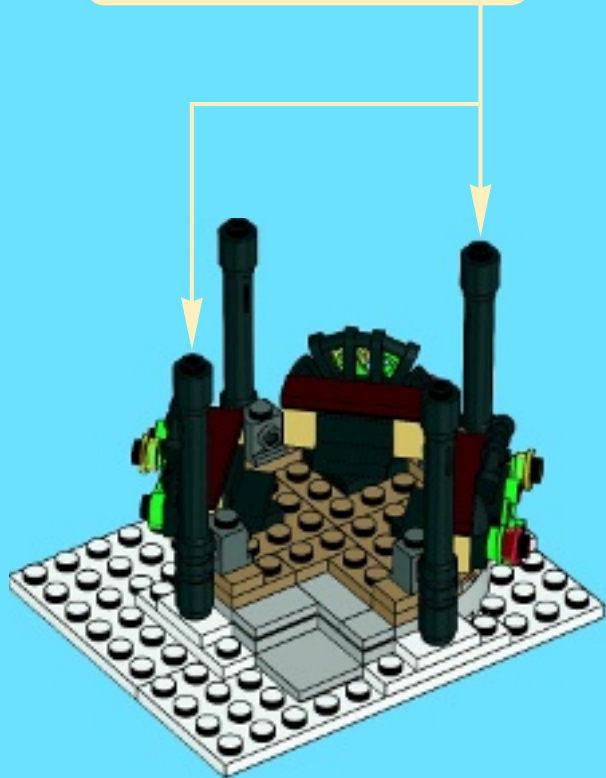
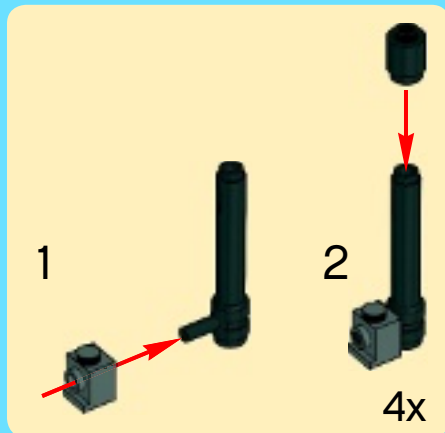



1

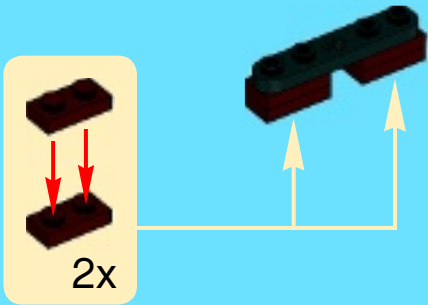

2

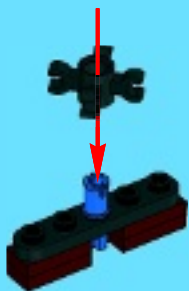

3

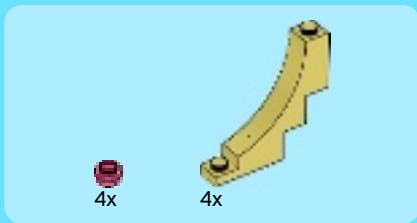
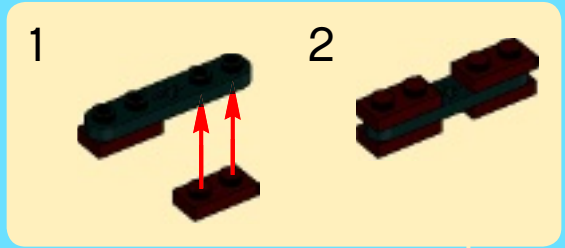

4

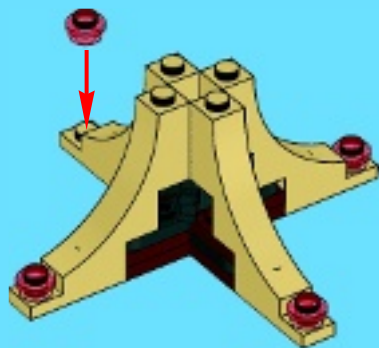



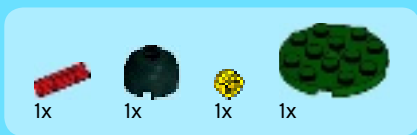

5



13



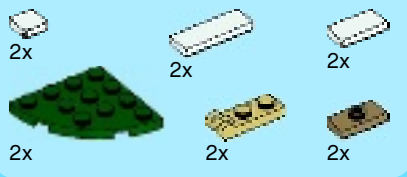

# 14

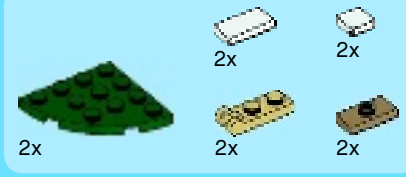
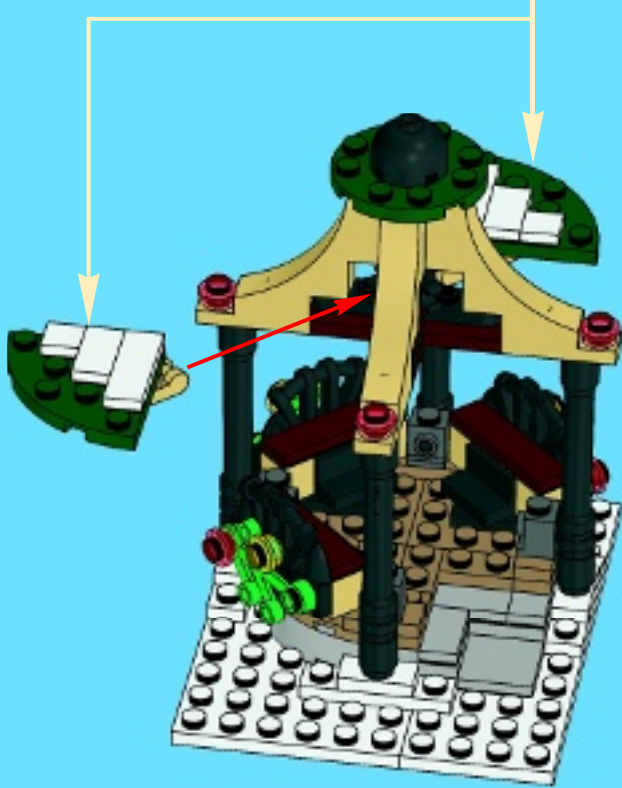
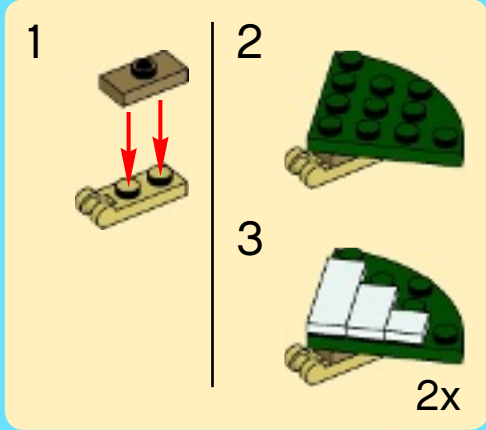

# 15

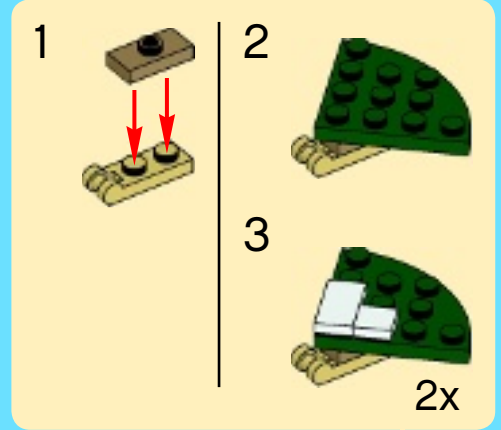



2x



1x

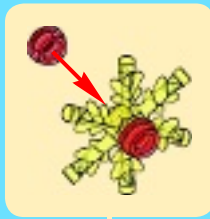

# 16



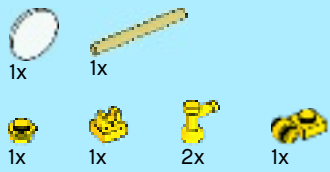

# 17

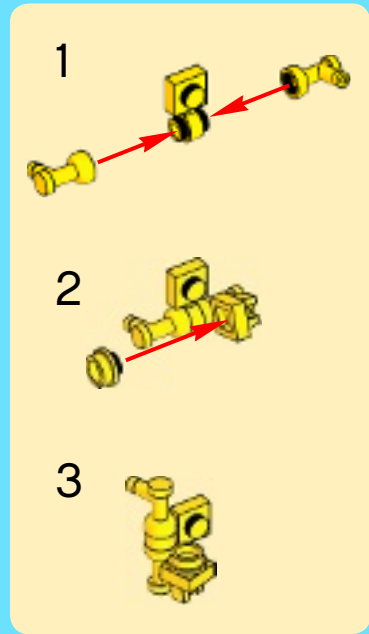
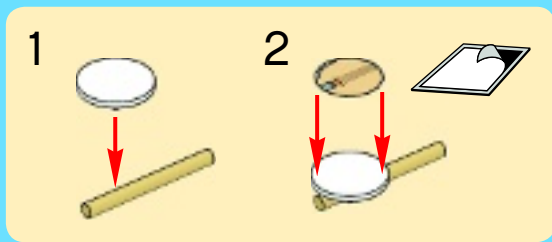

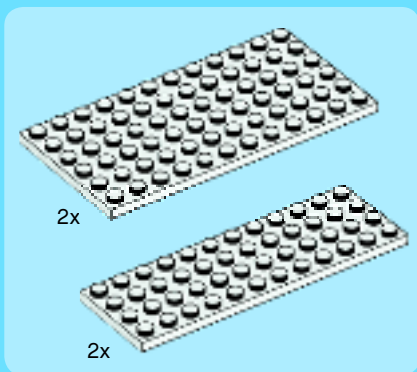

1

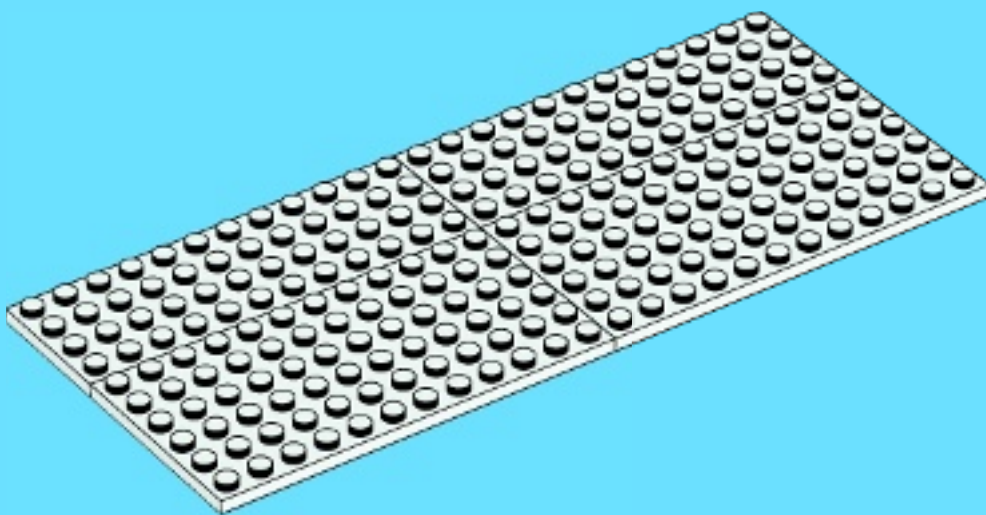



1x



1x

# 2

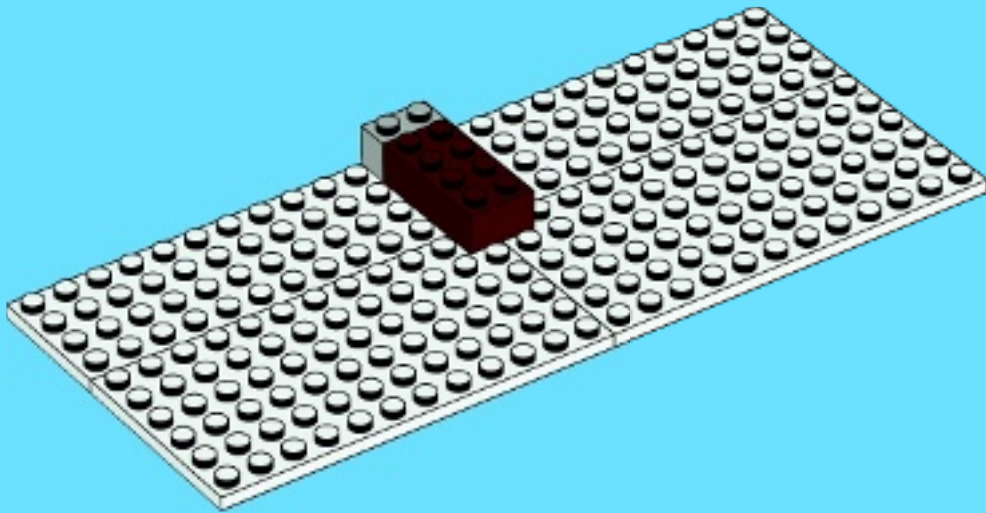

5x



5x



5x



6x

# 3

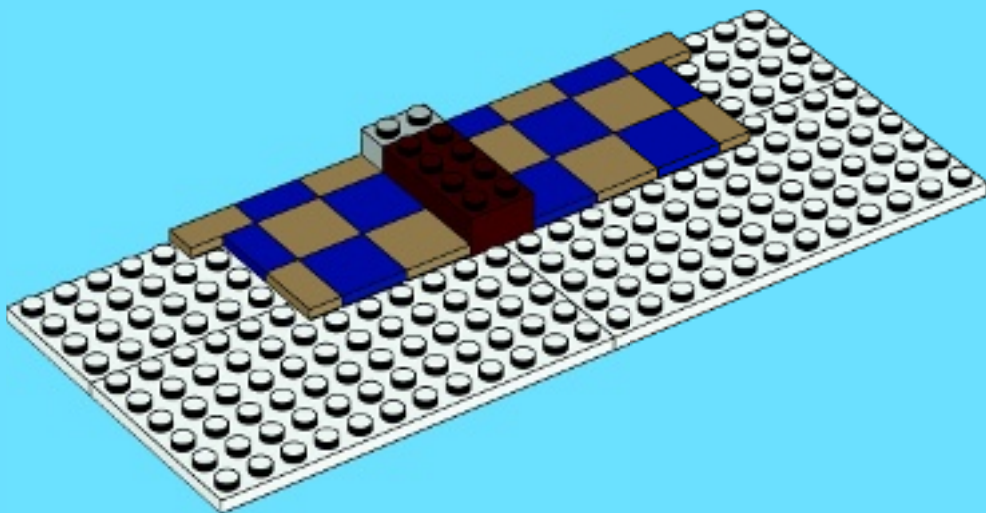

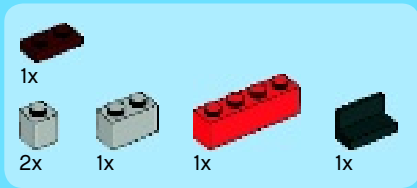

4

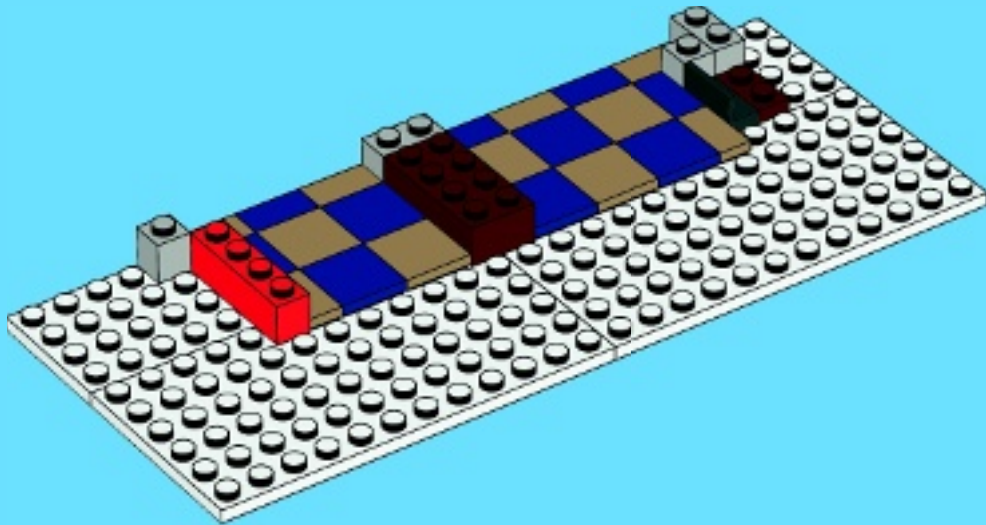

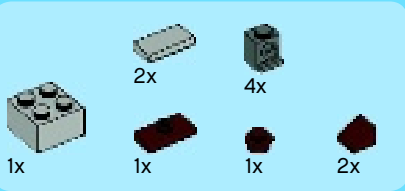

# 5

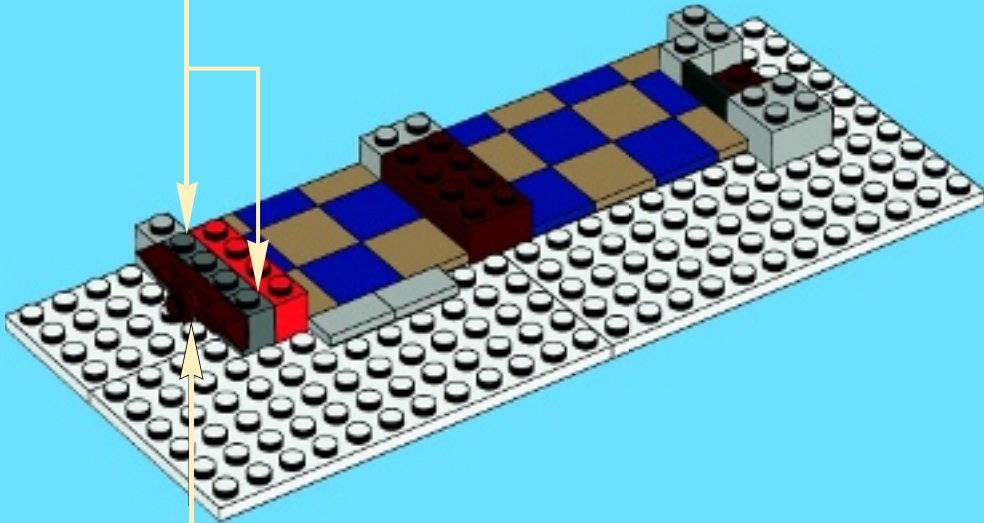
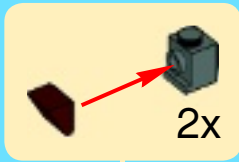



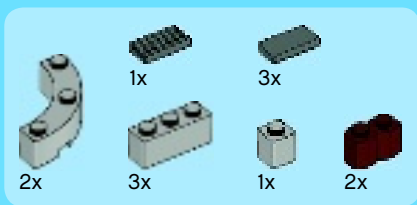

6

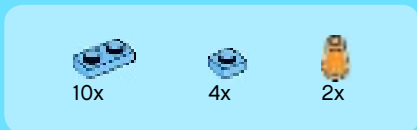
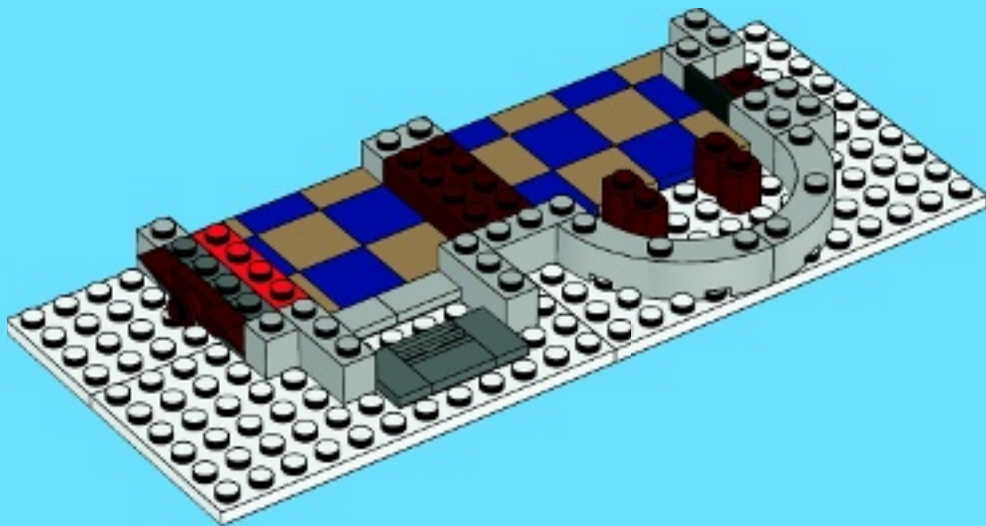

7

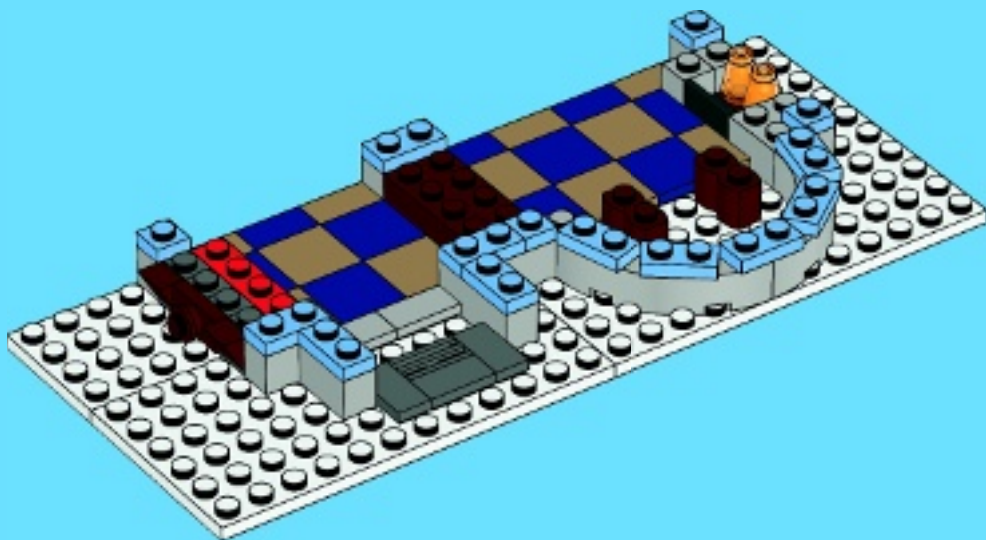



1x



2x



1x

# 8

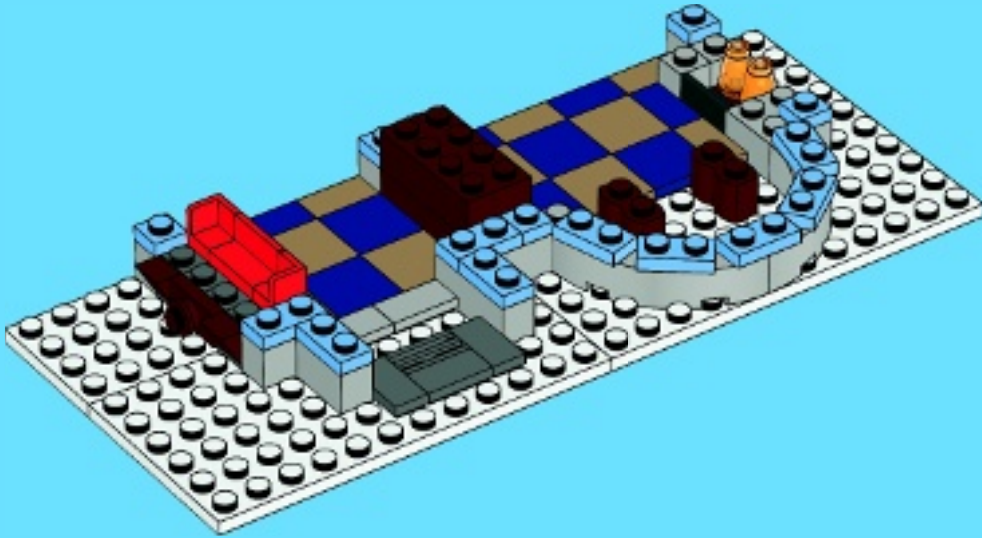

2x



3x



2x



1x



1x



# 9

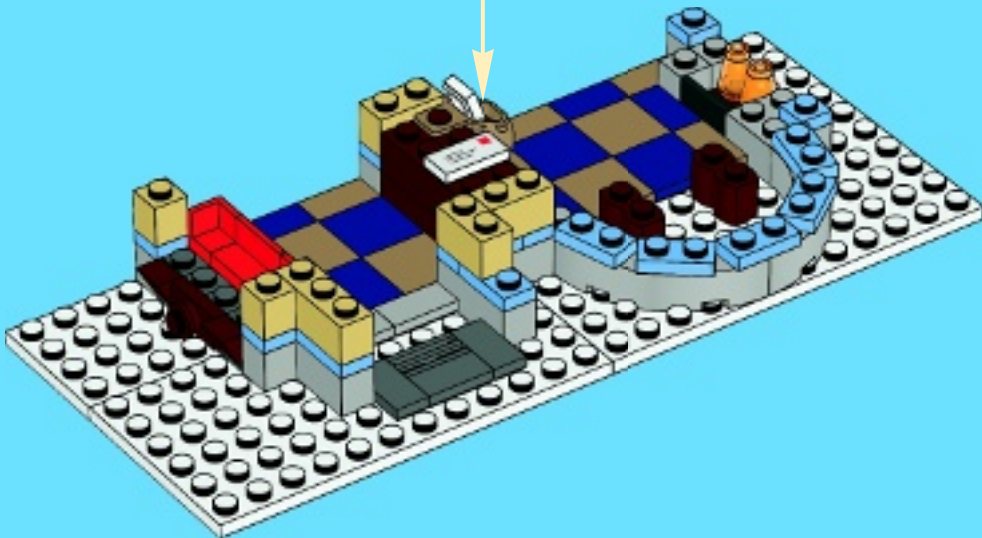

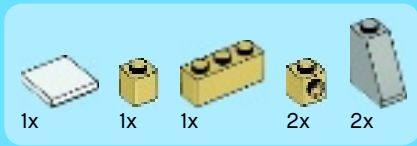

10

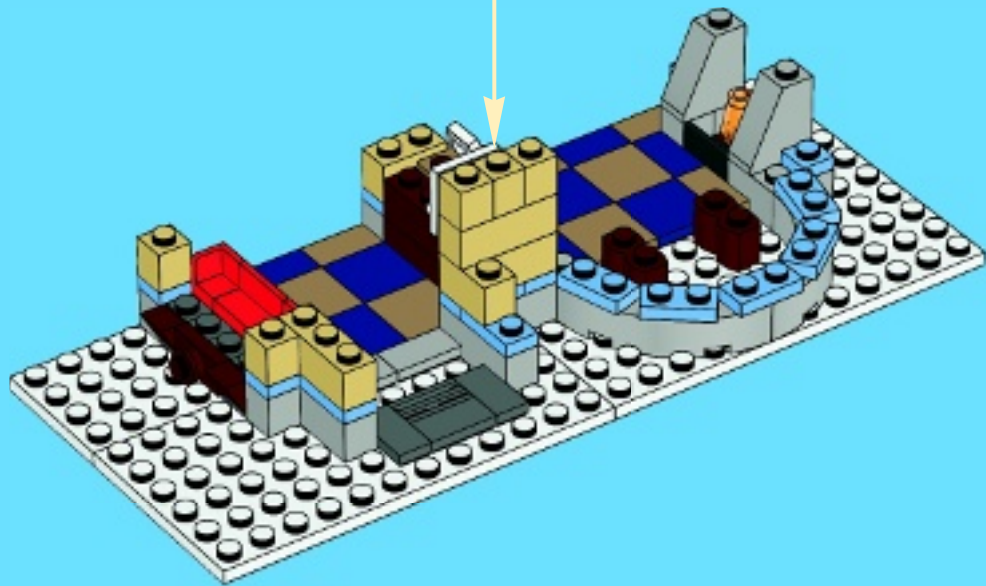
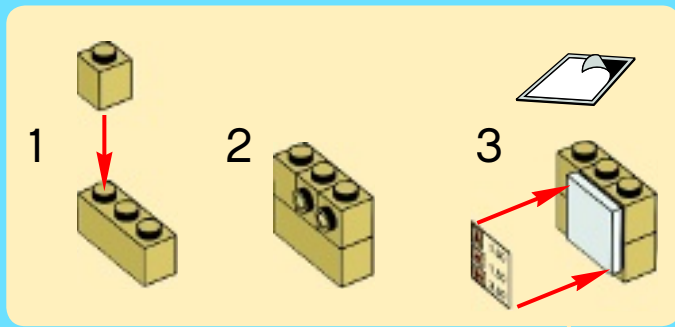

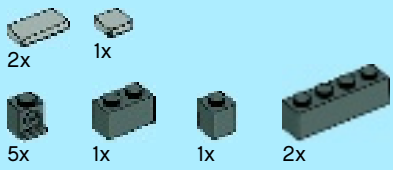

# 11

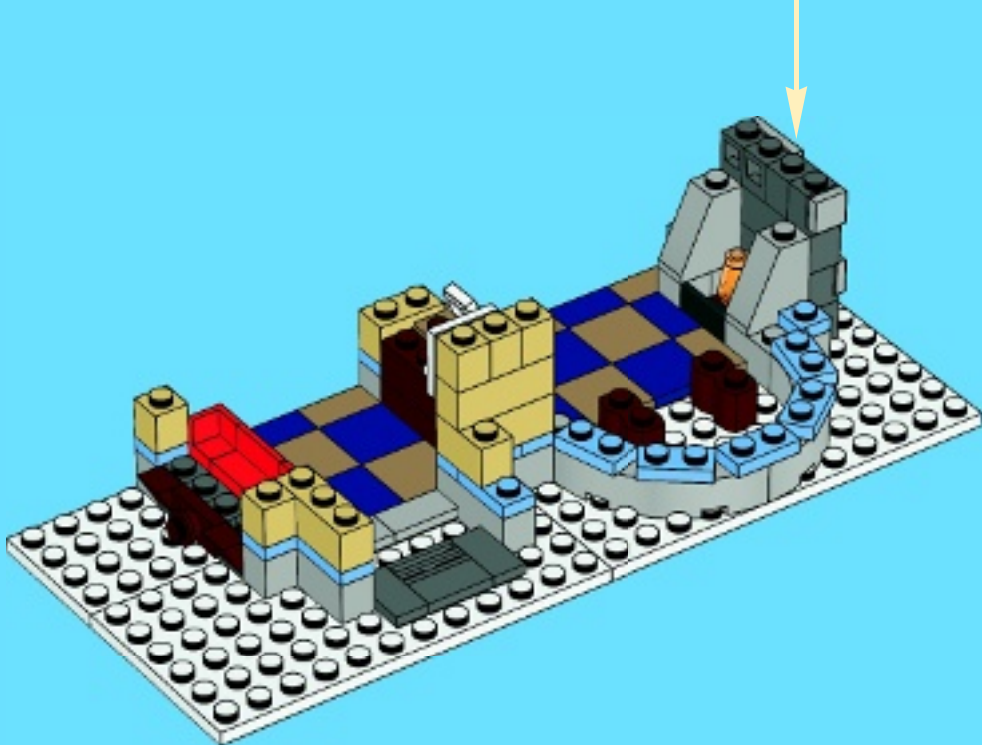
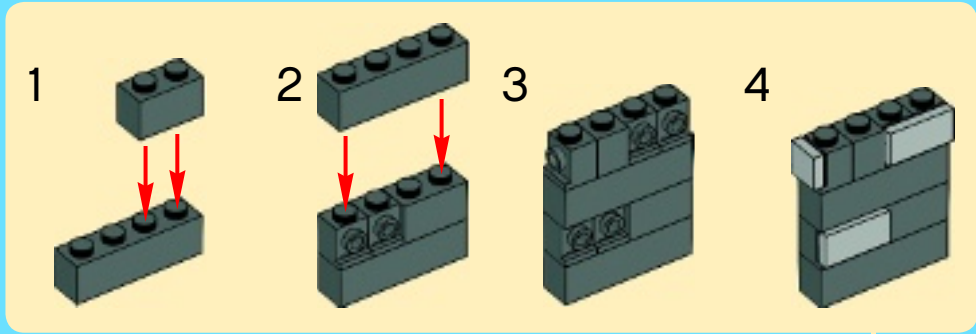

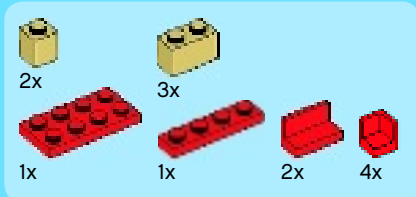

12

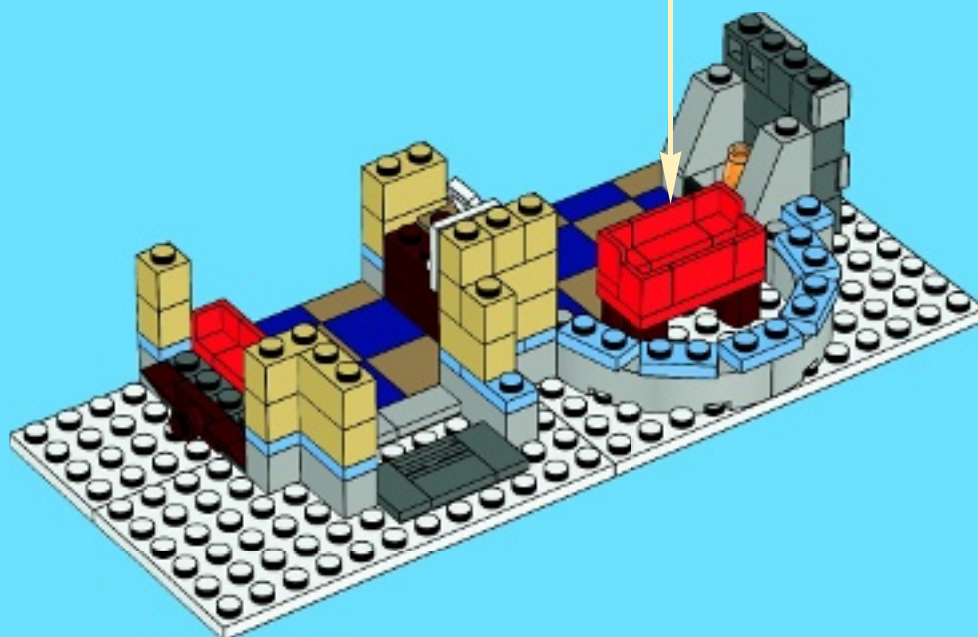
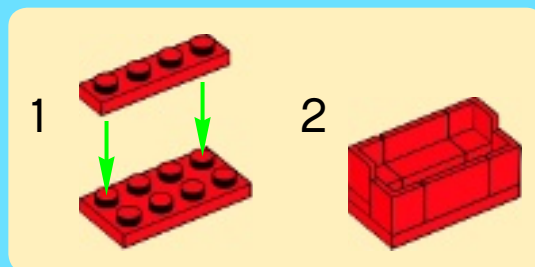

# 13

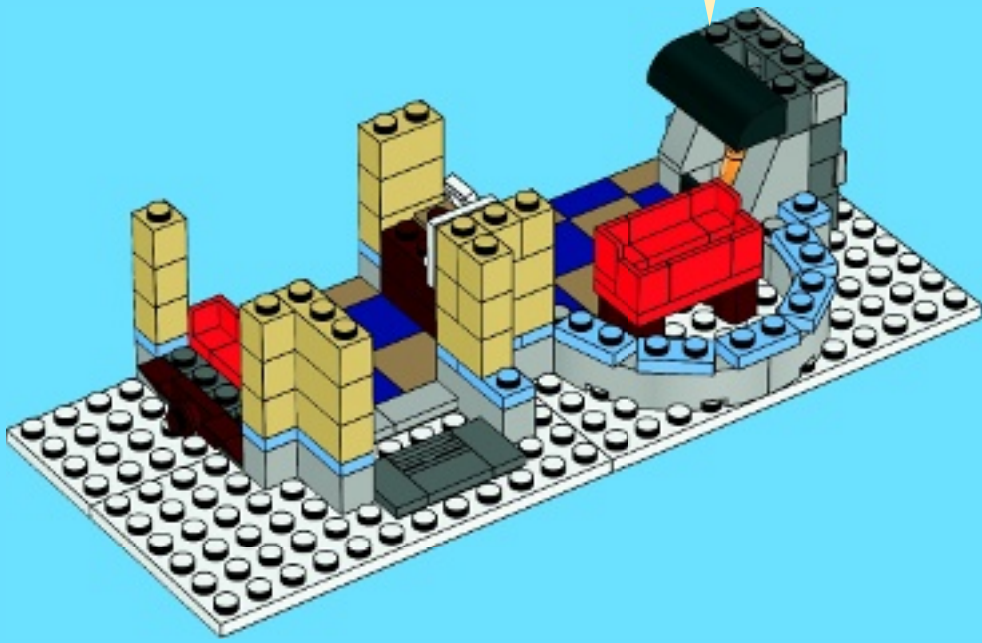
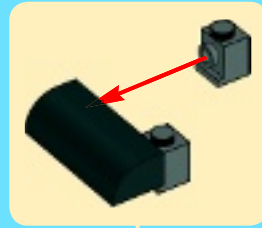
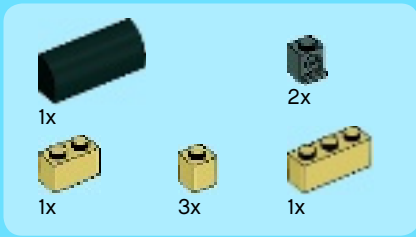



14

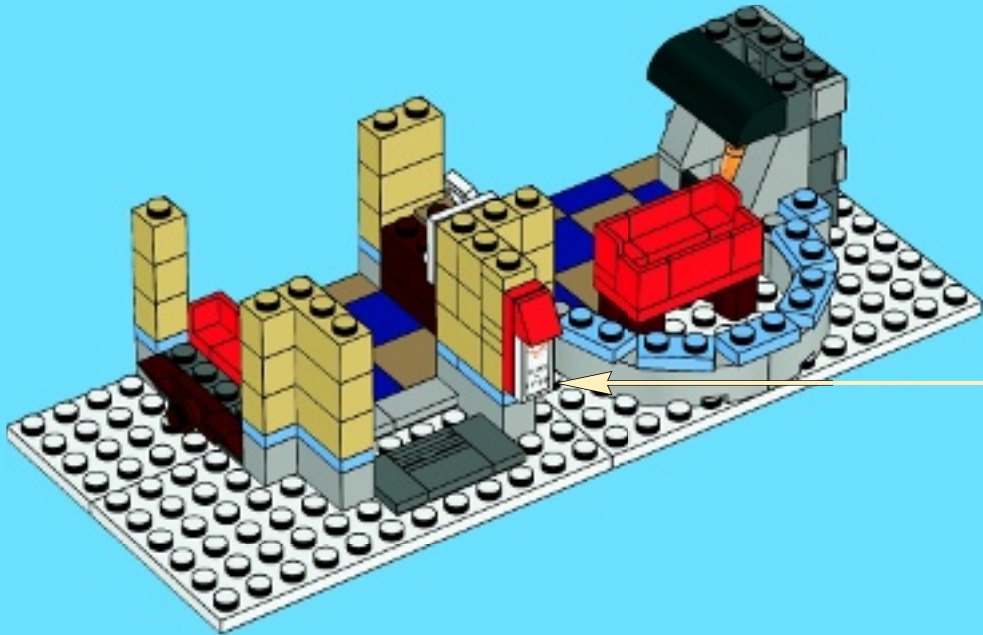
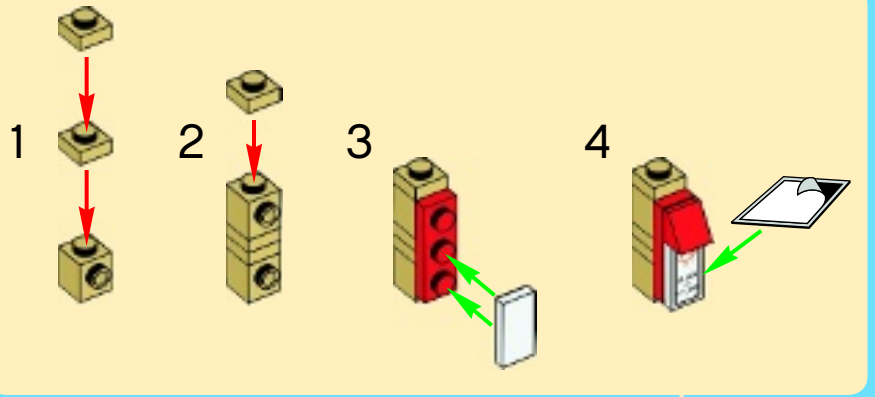



6x



1x

# 15



2x

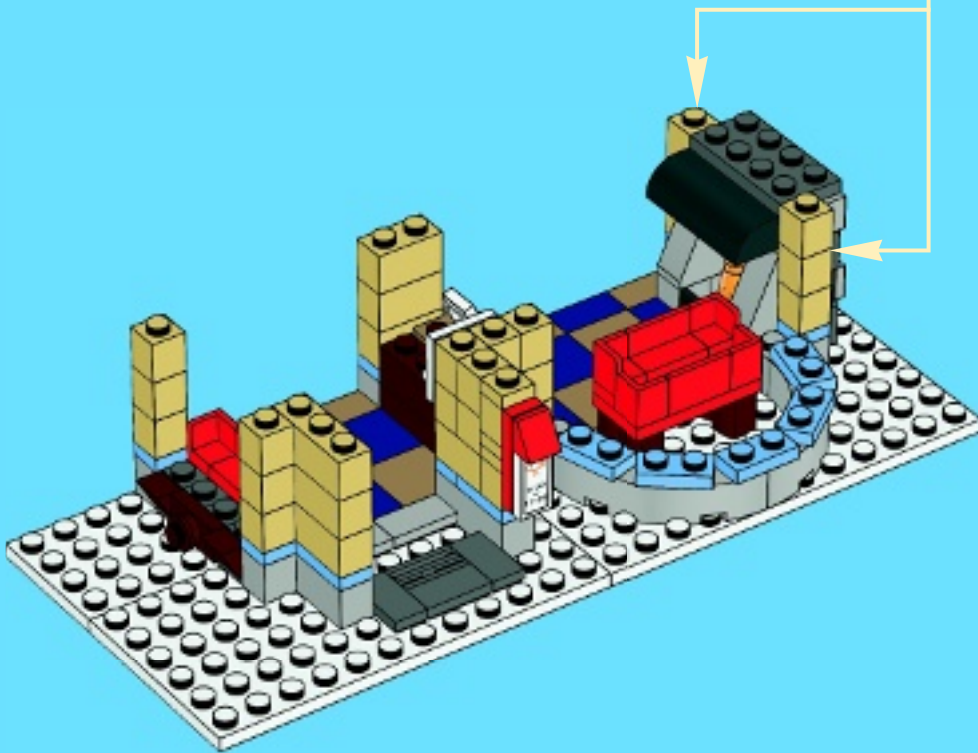





1x



2x



2x

# 16

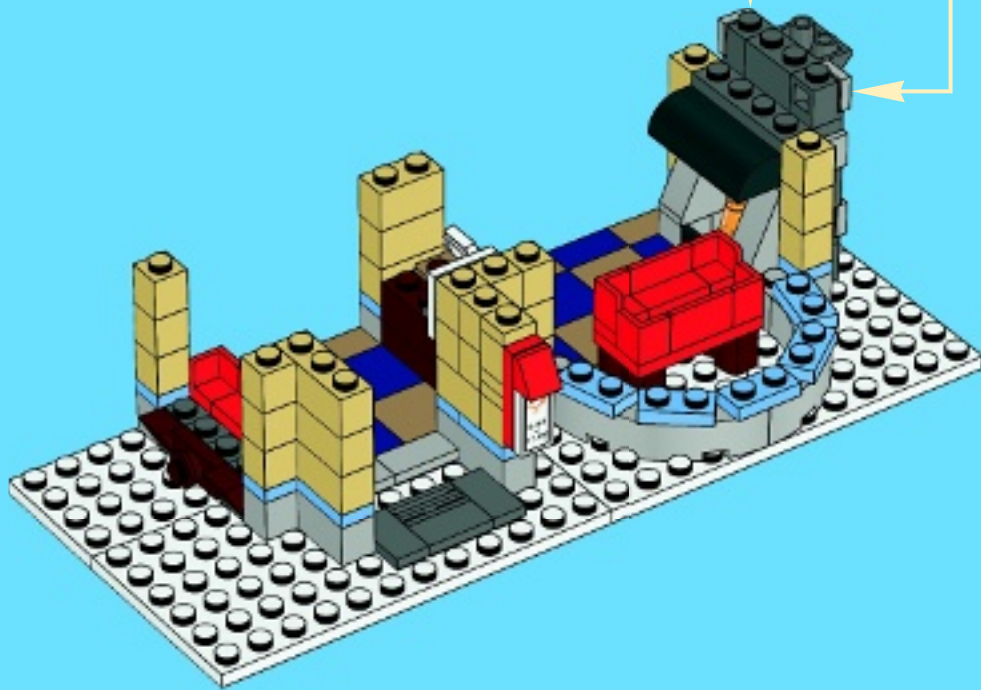
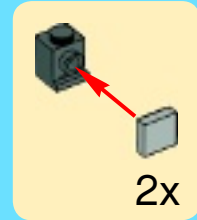

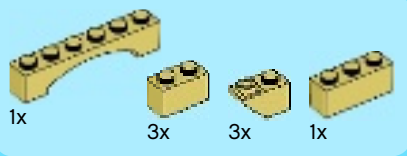

17

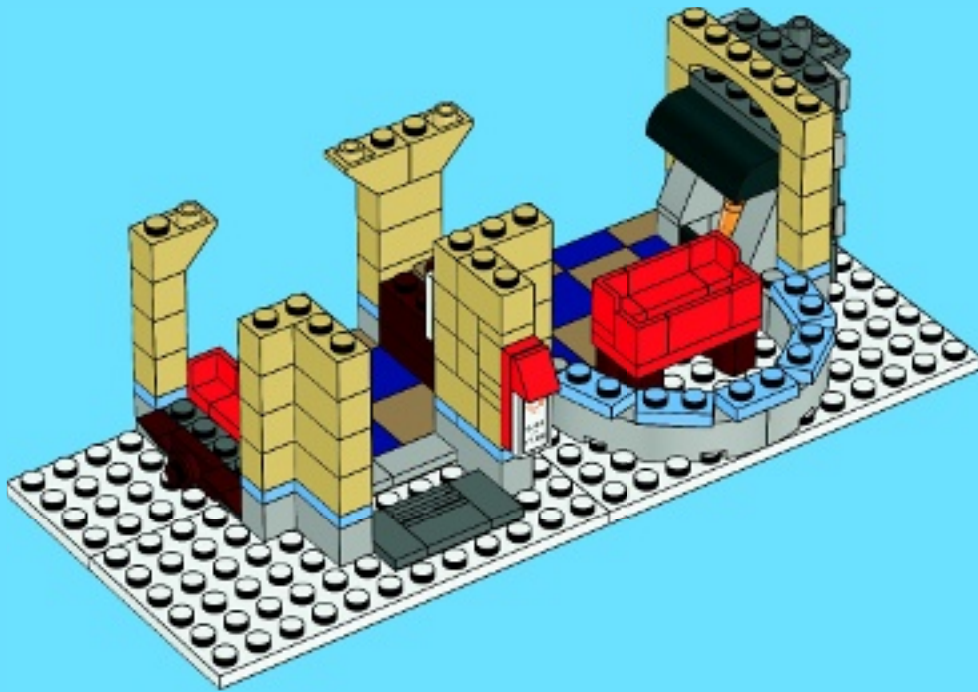



14x



14x

# 18

1



2



7x

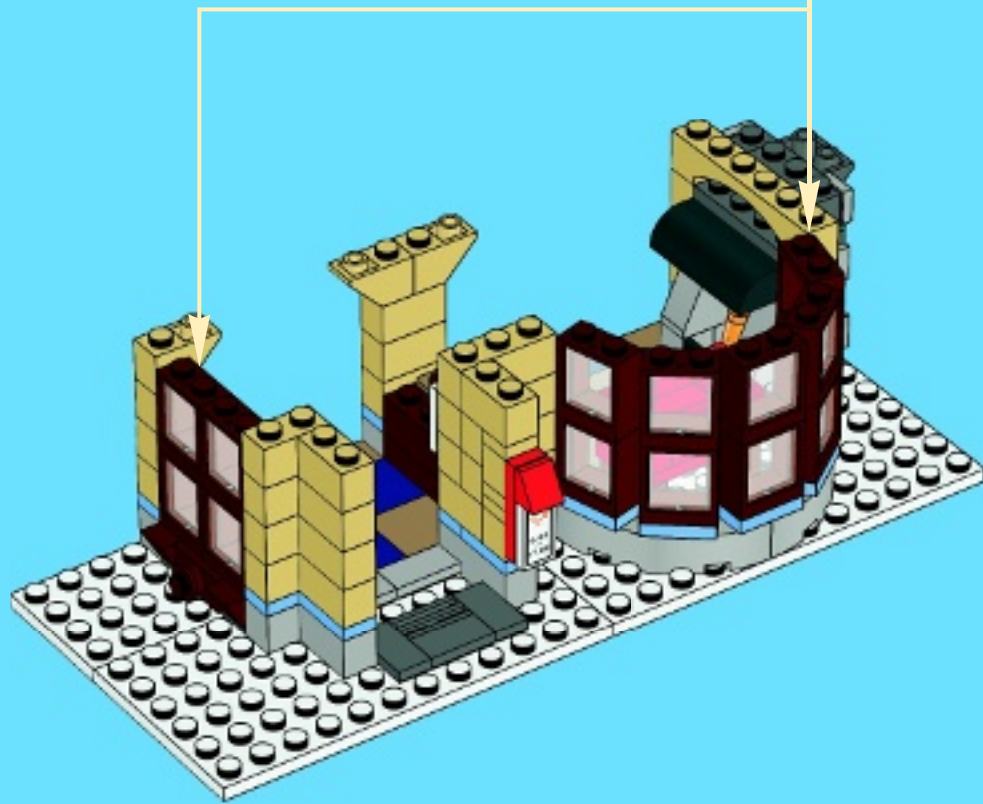

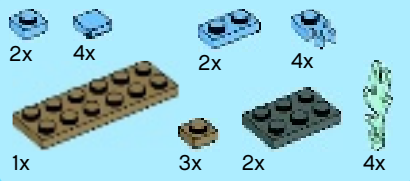

19

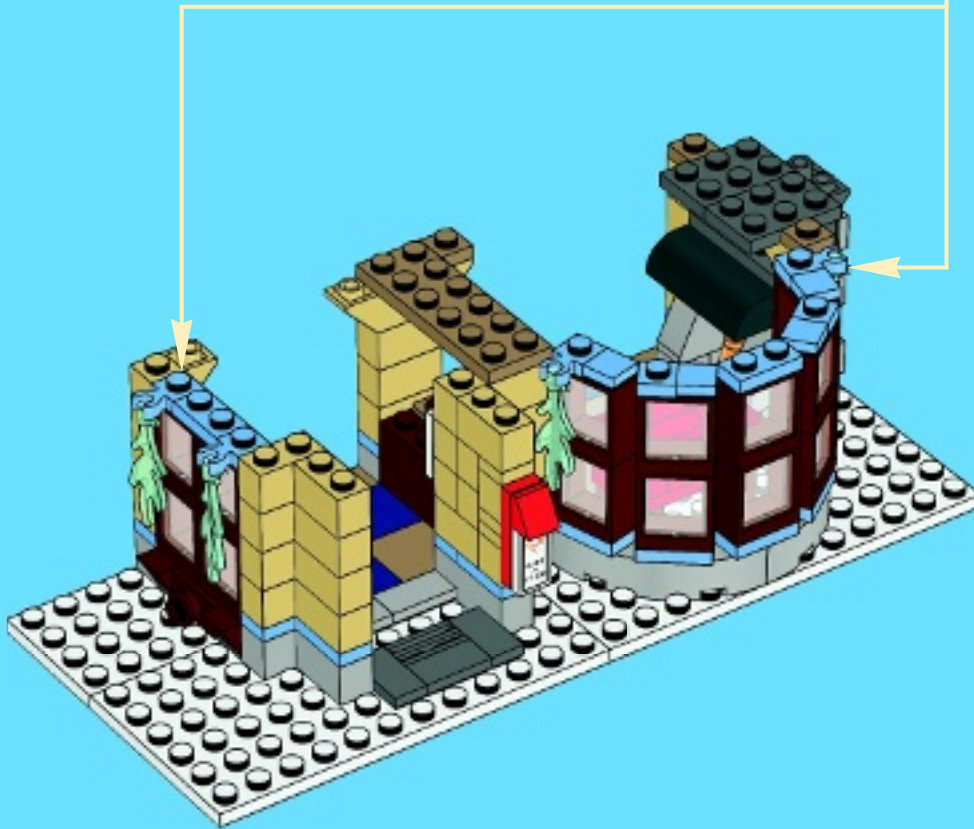
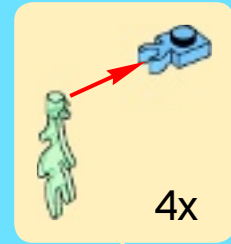



20

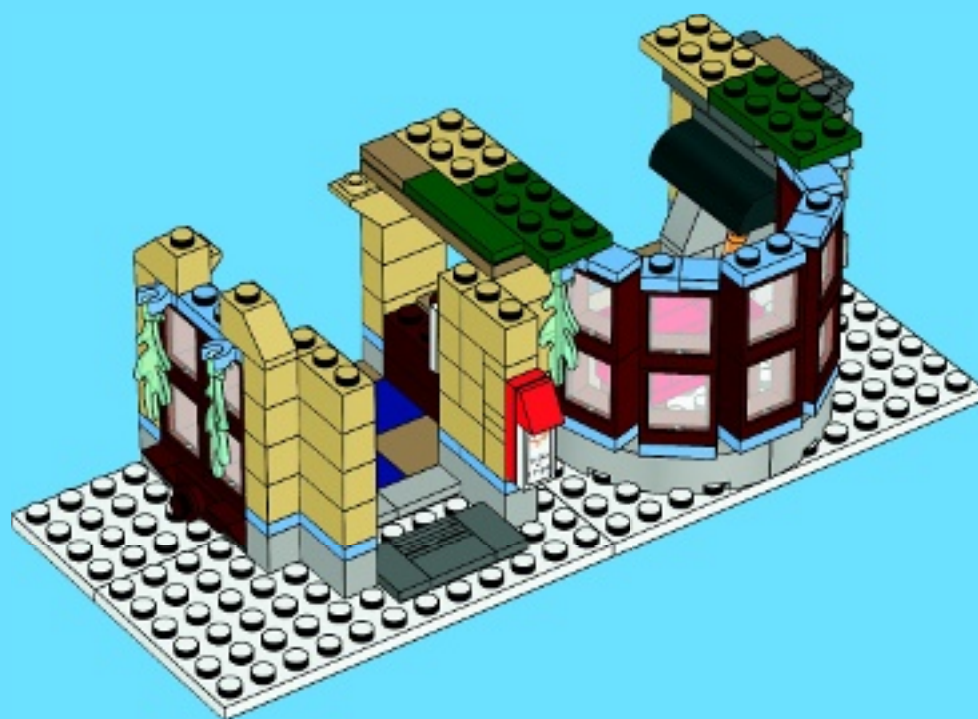

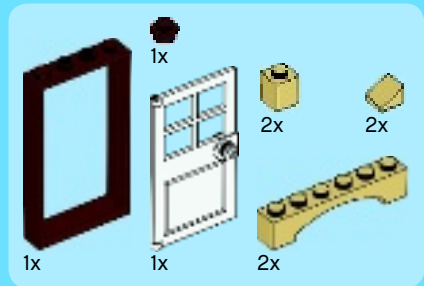

21

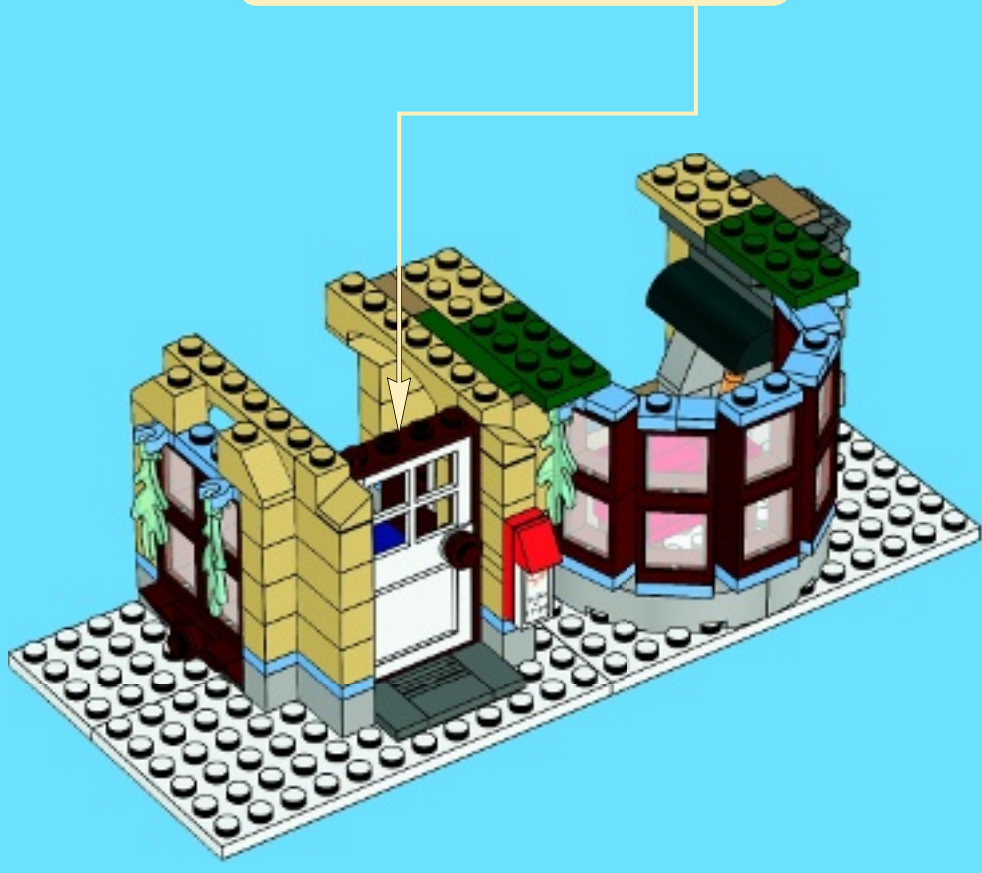
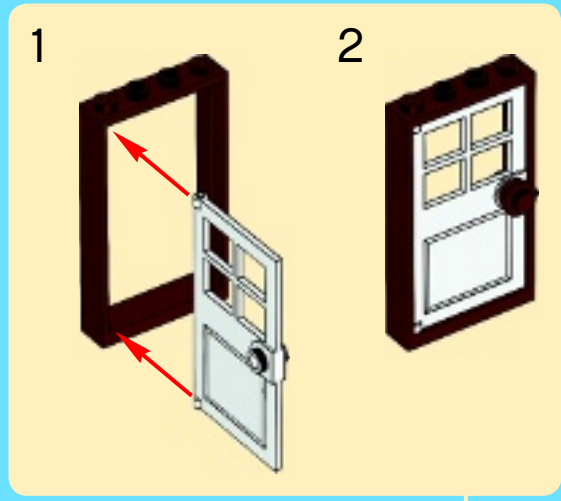

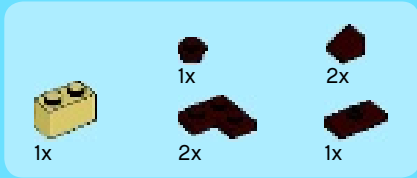

22

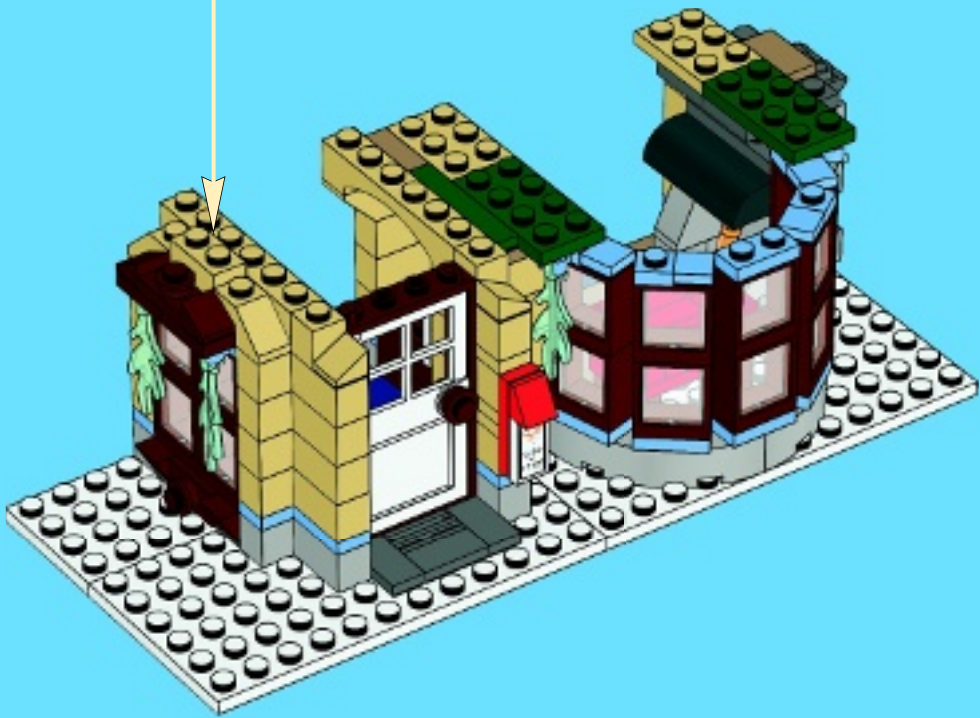
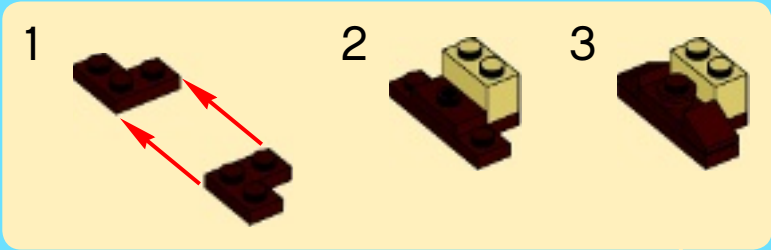



# 23

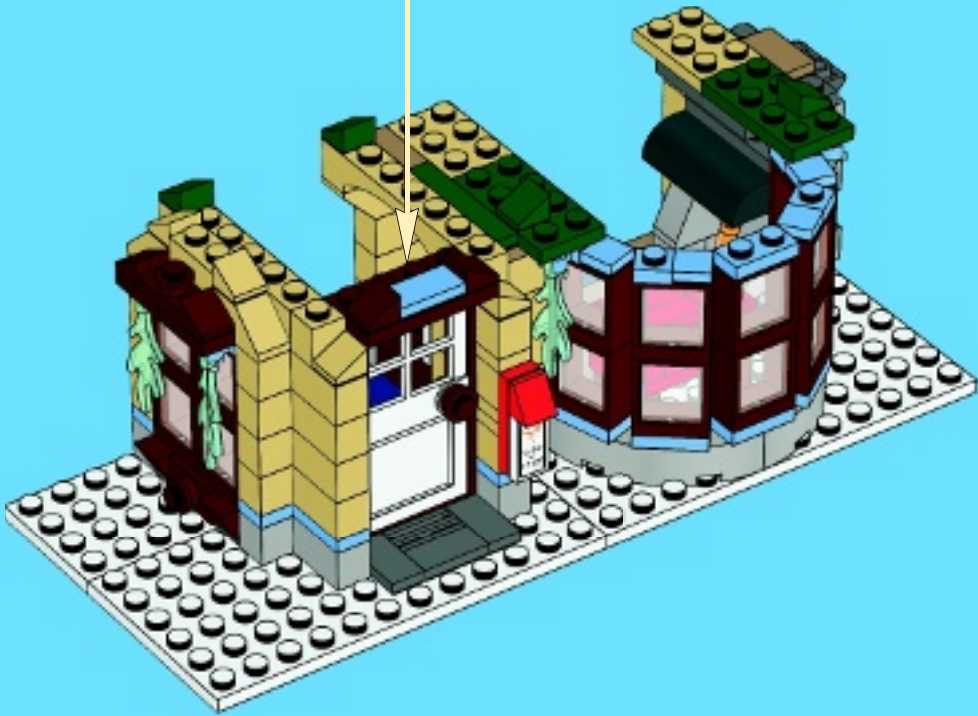
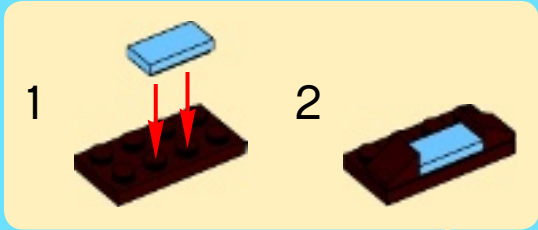



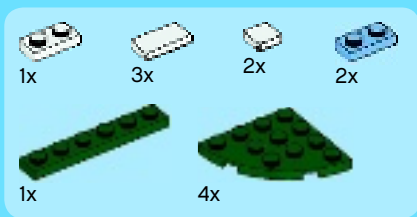

24

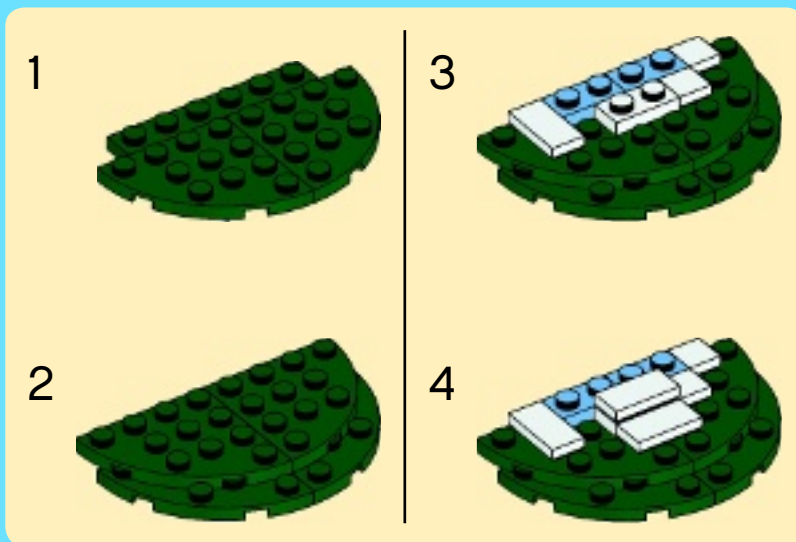



2x



1x

# 25

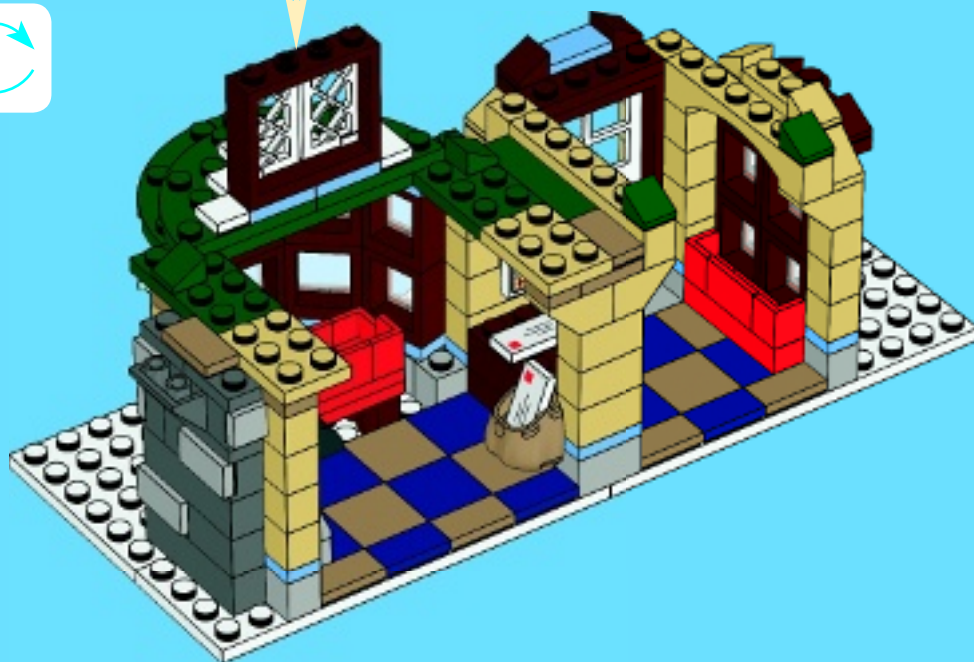
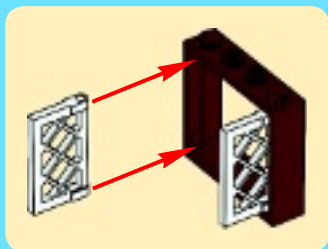

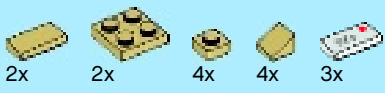

26

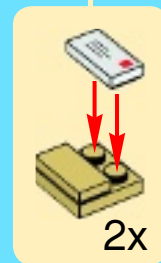
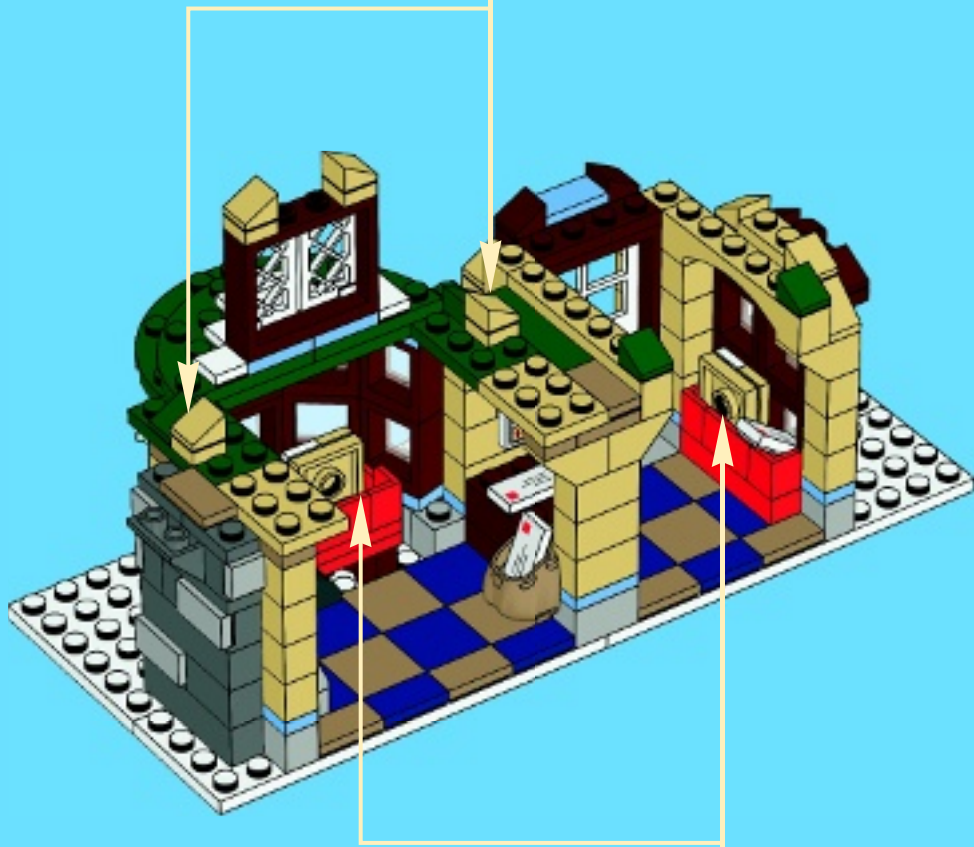
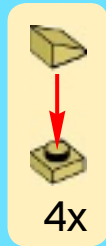

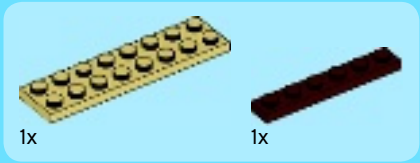

1

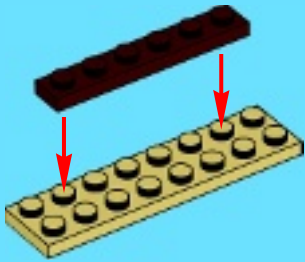

2

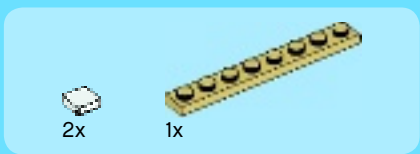
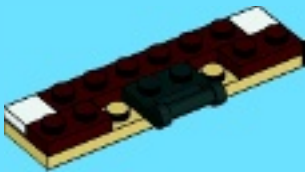

3

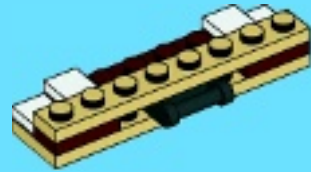

4

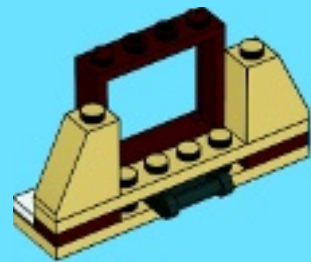



1x



2x

# 5

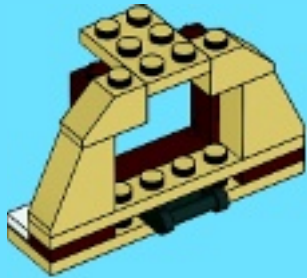

1x



2x

# 6

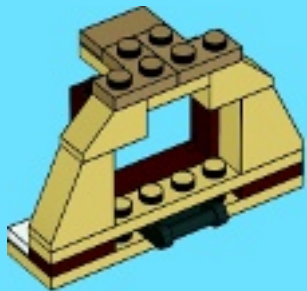

1x



2x



2x



1x



2x



1x

# 7

1

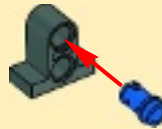

3



2

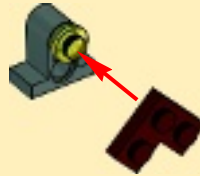

4





2x



1x

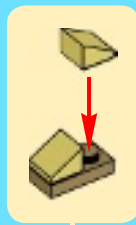

8



27

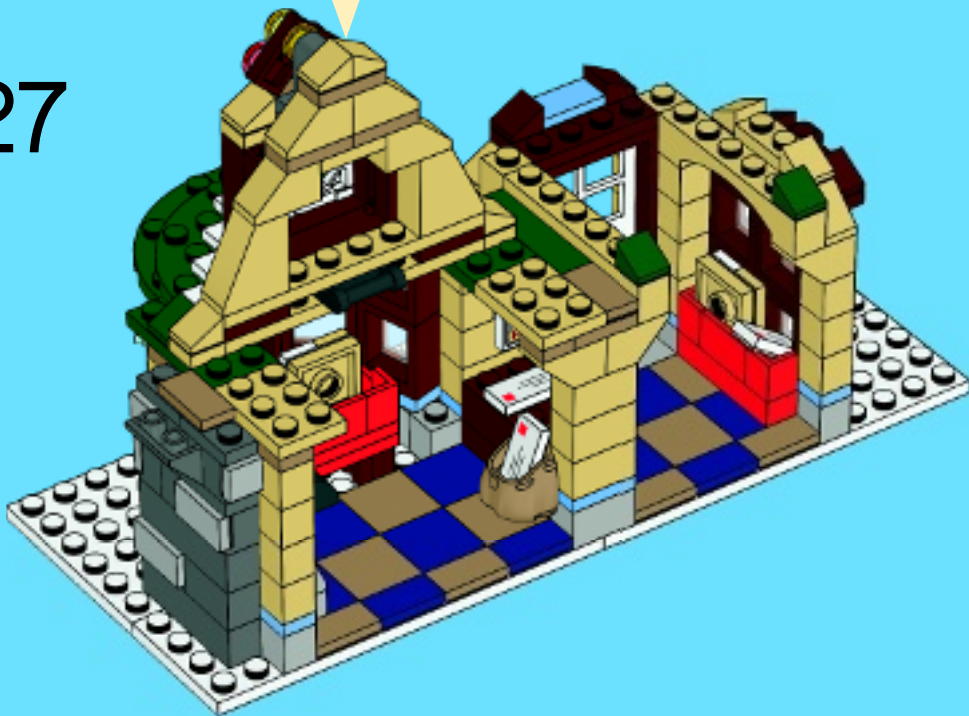

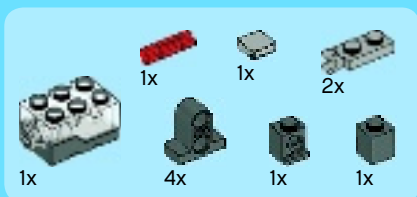

28

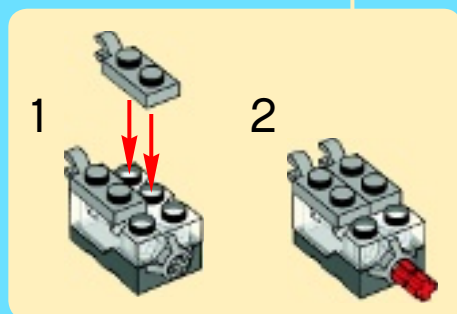
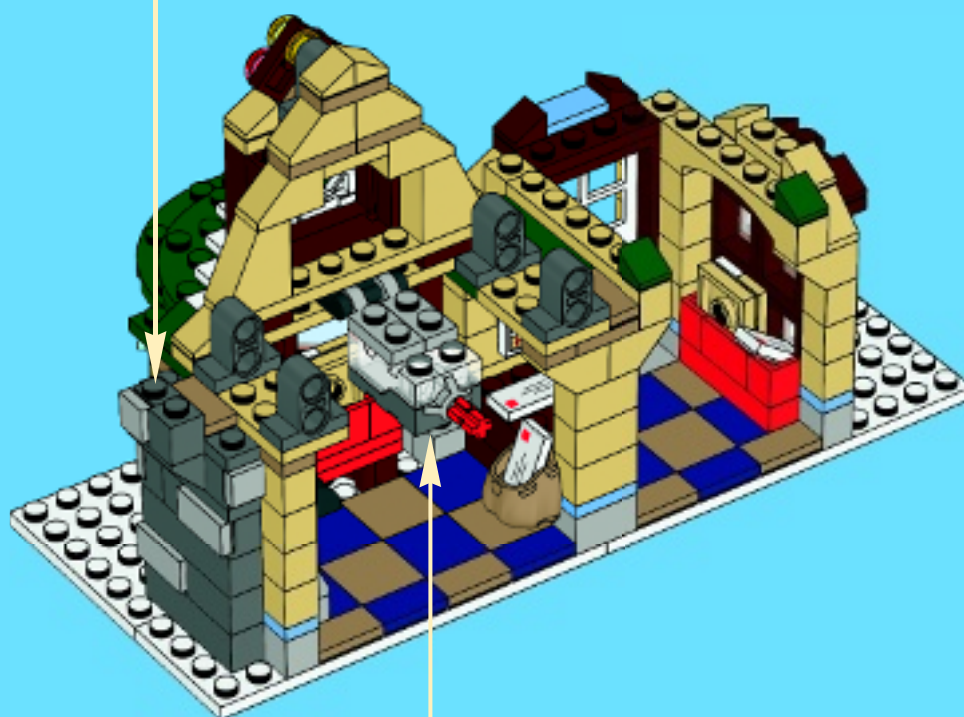
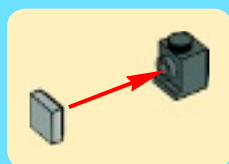
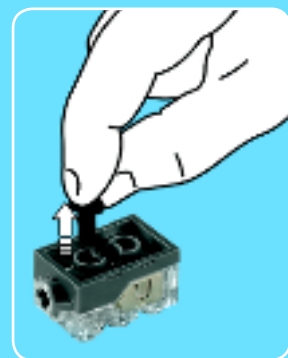

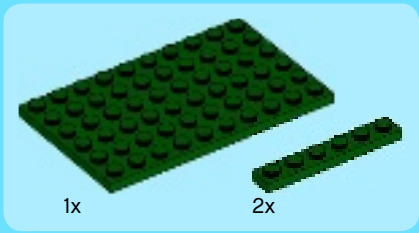

1

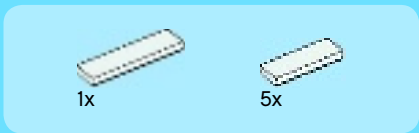
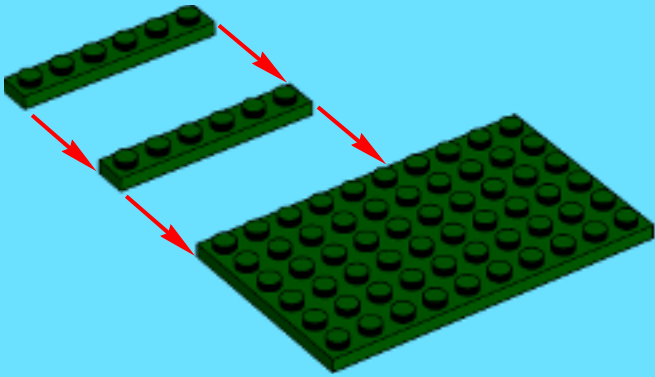

2

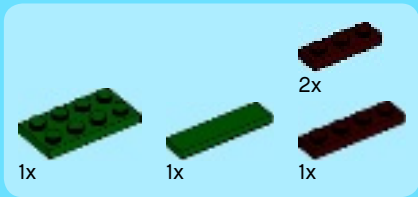
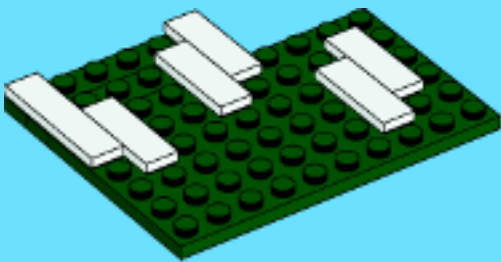

3

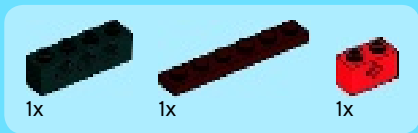
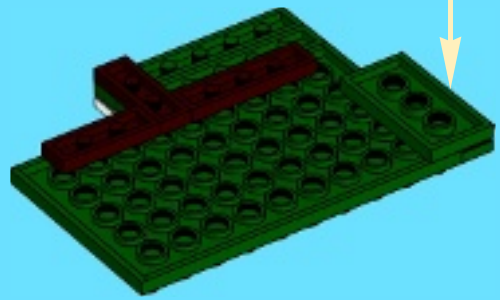
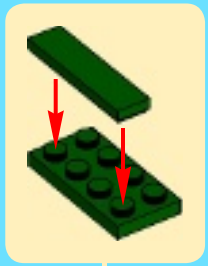

4

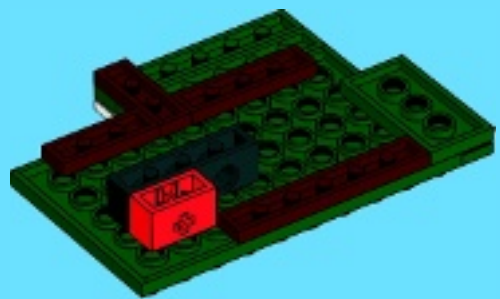





1x

# 29

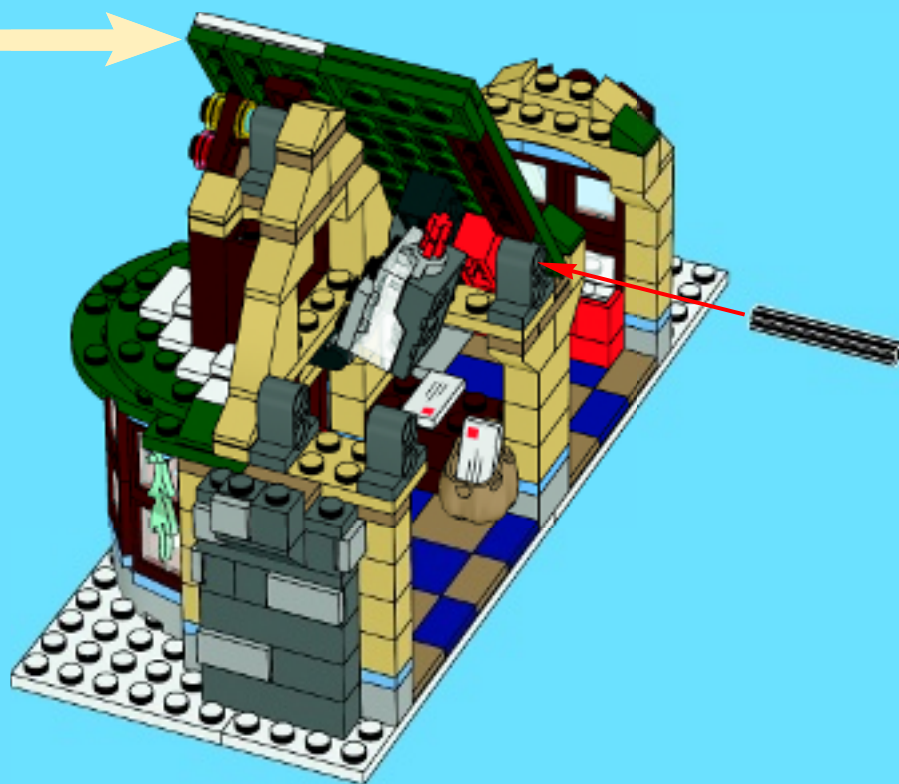

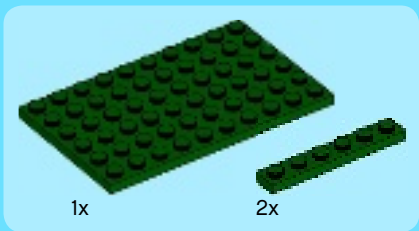

1

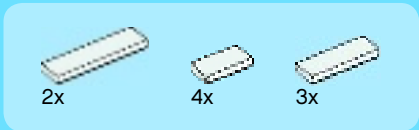
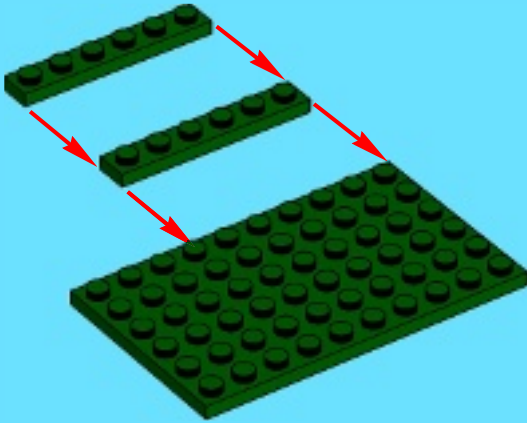

2

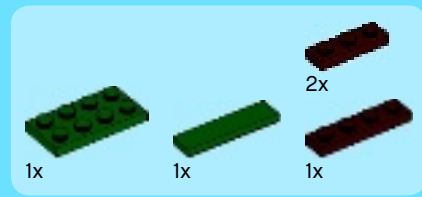
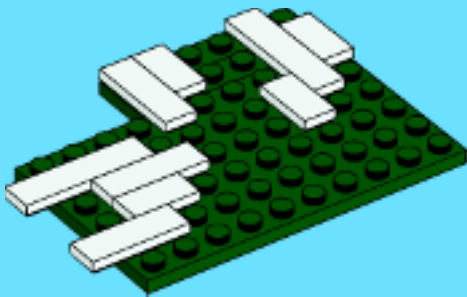

3

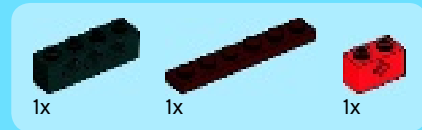
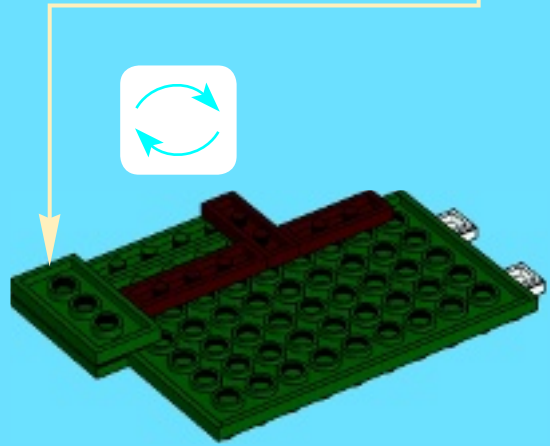
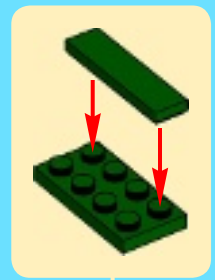

4

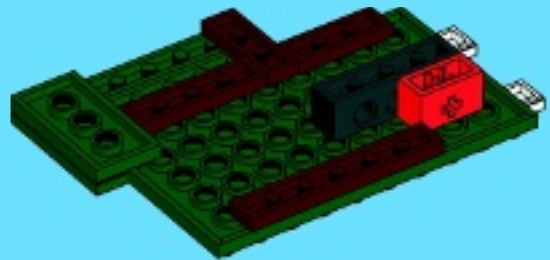



30

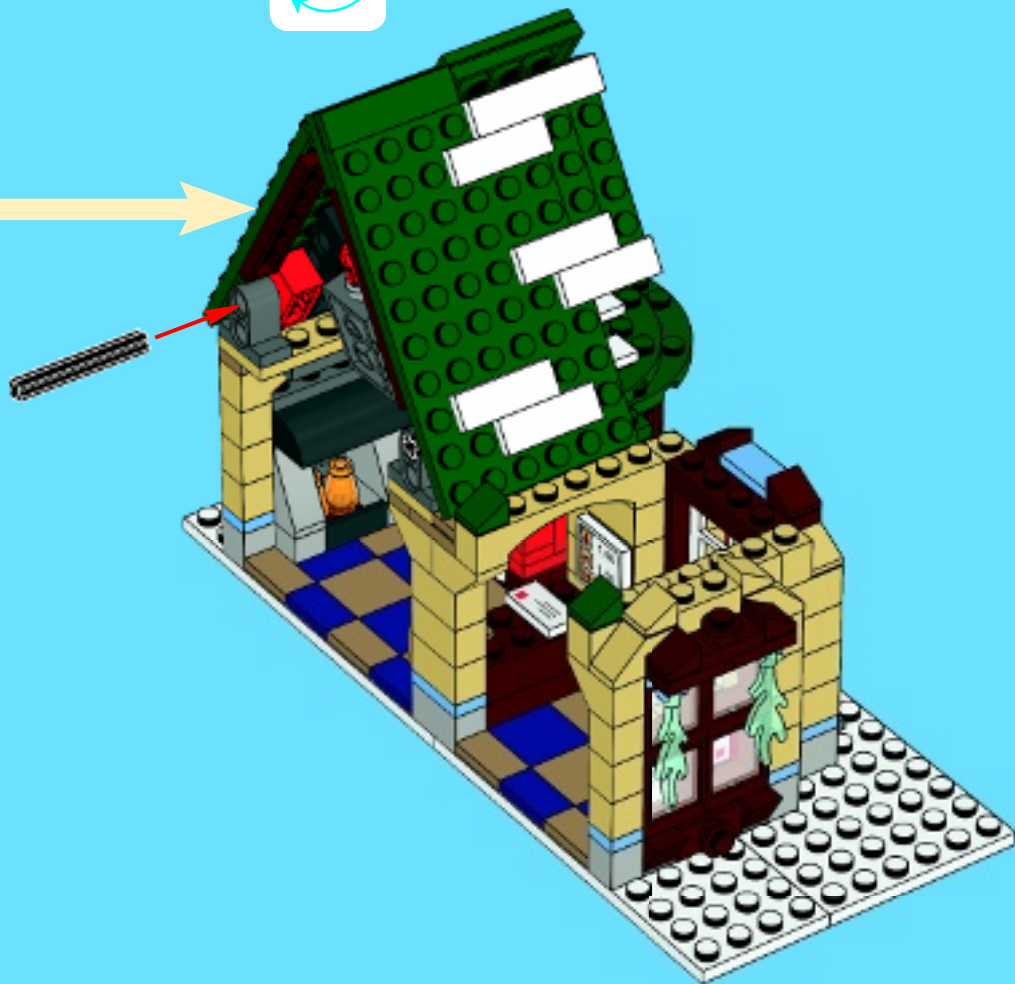



3x

# 31

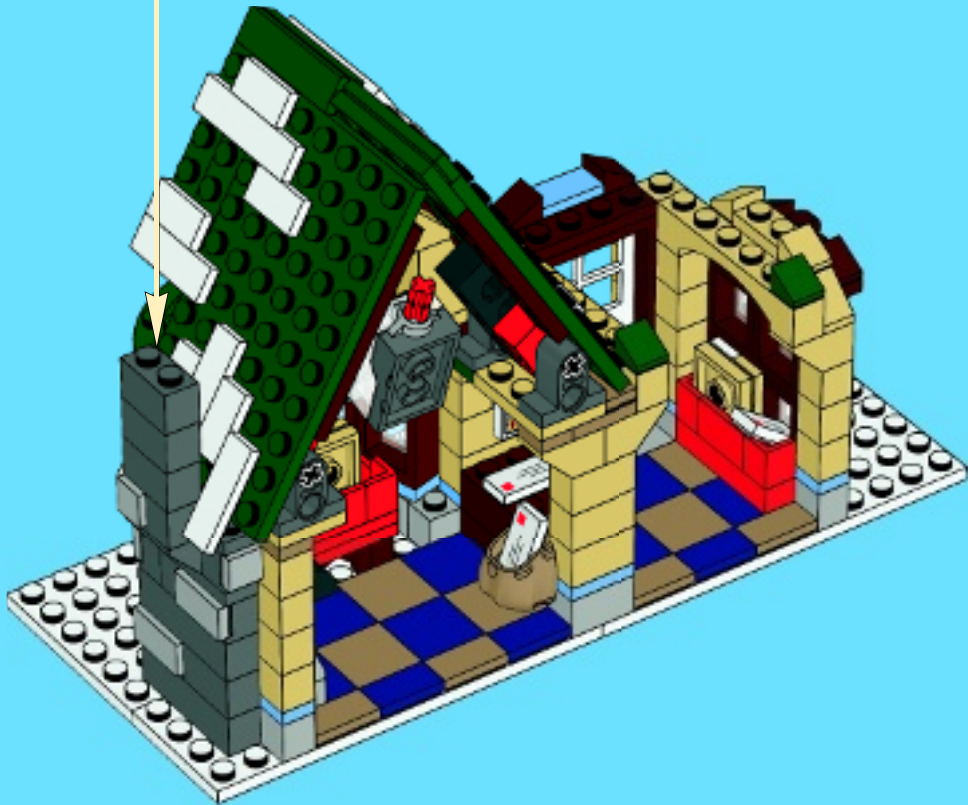
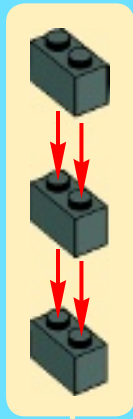

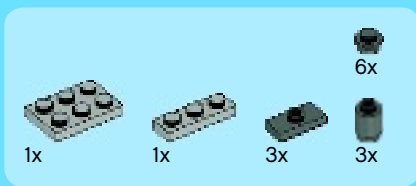

# 32

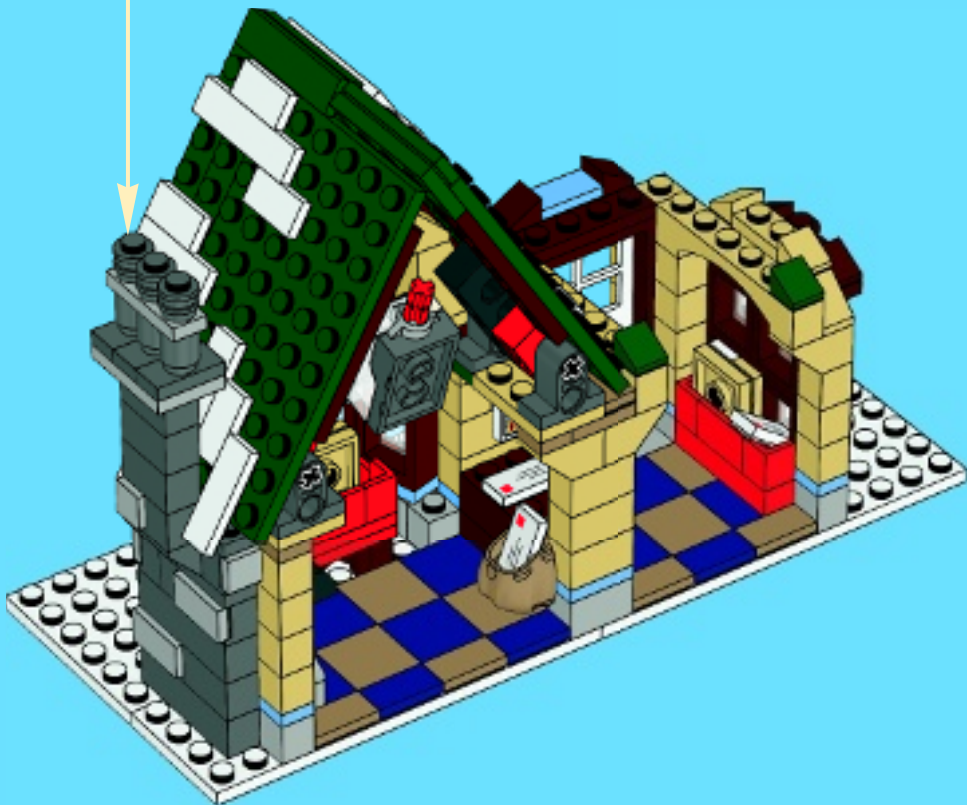
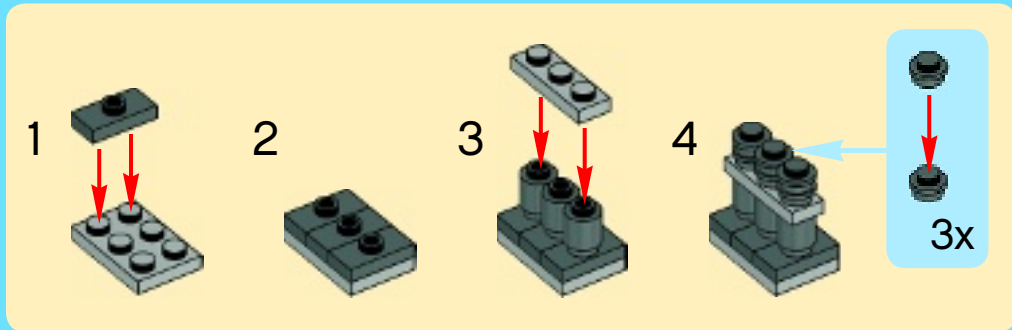



1x



1x

1

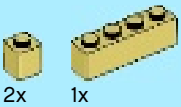

2x

1x

2x

2x

2

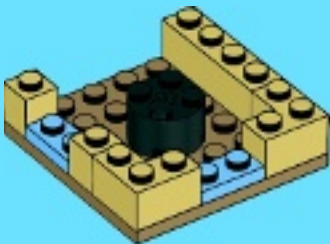

2x



2x



2x

3

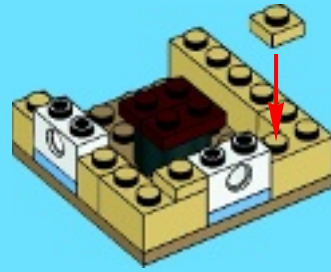

1x



4x



2x



2x



3x

4

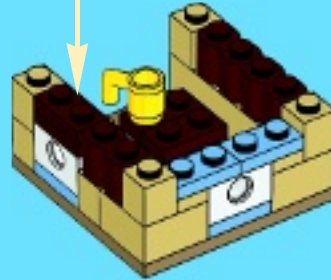
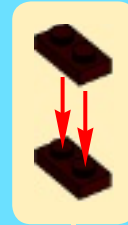

2x



2x

5





2x



4x

6

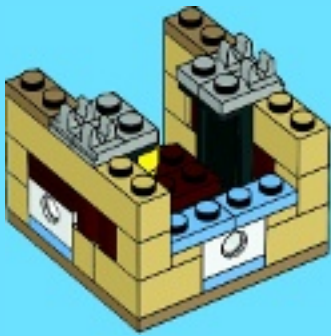

2x



2x

8

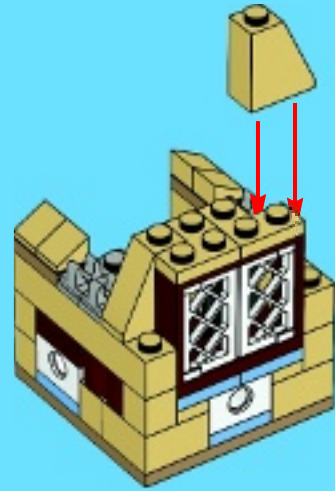

4x



2x



1x

7

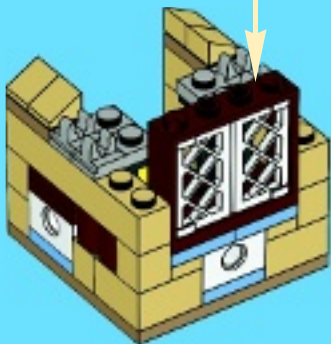
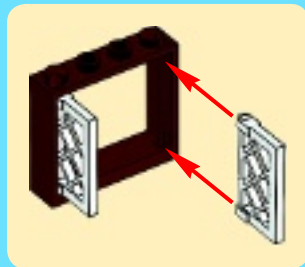

2x



4x



2x

9



2x

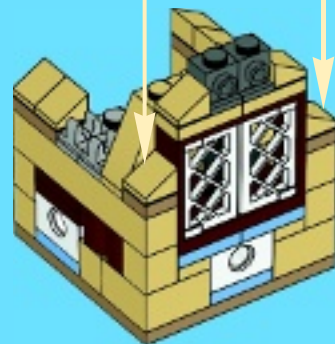



2x



1x

10

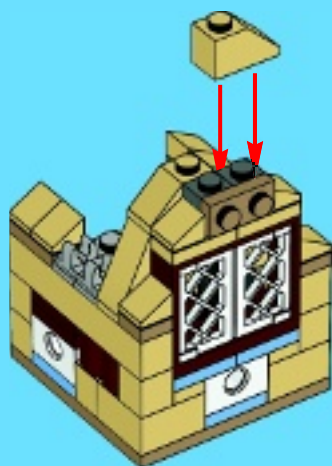

33





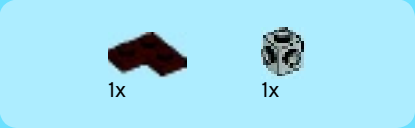

1

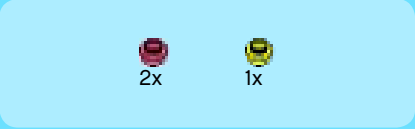

2

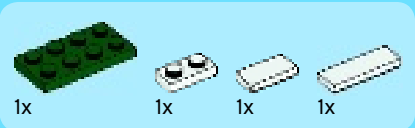

3

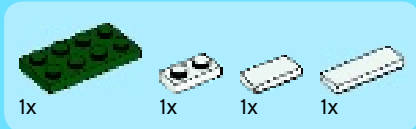
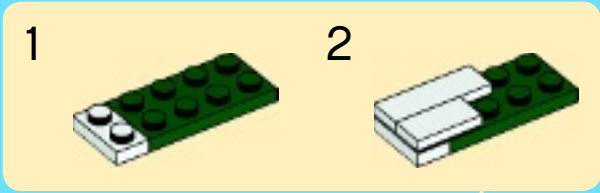

4

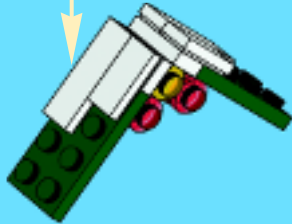

2x

34





2x



1x



1x

# 35

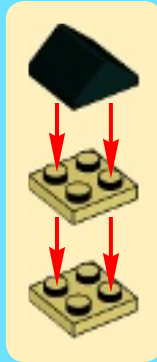

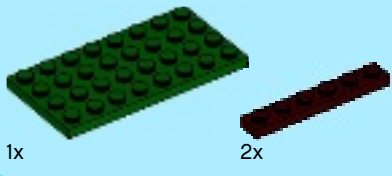

1

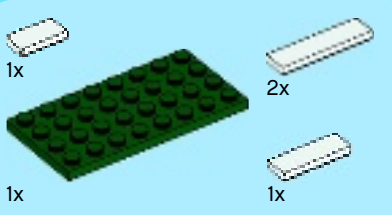
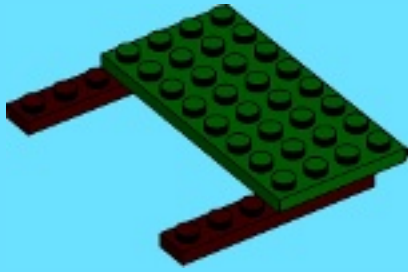

2

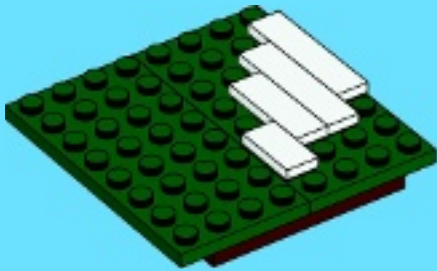

3

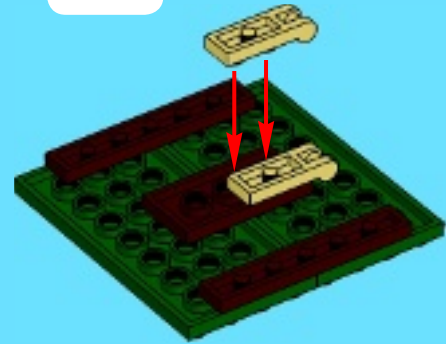

4

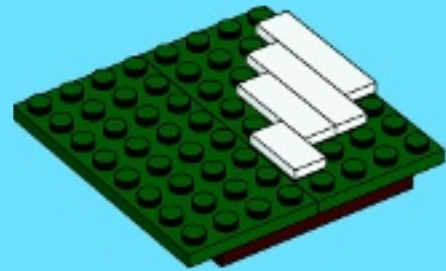

36



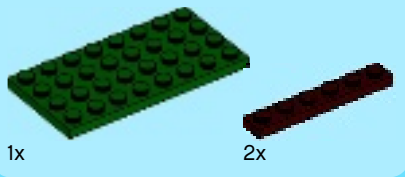

1

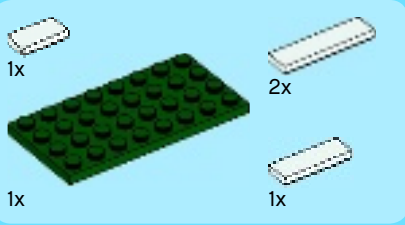
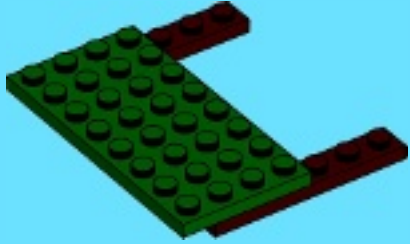

2



3

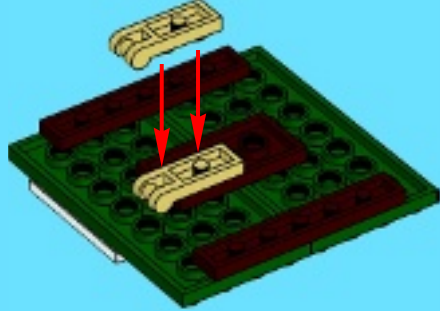

4



37





1x



2x



2x



2x



2x



2x

# 38

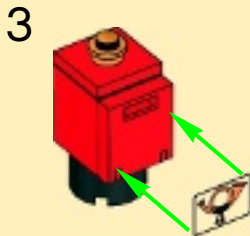
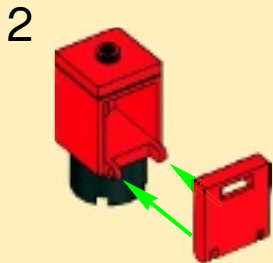

2x





1

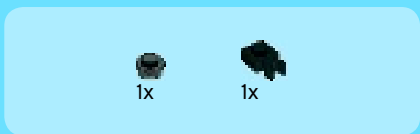

2



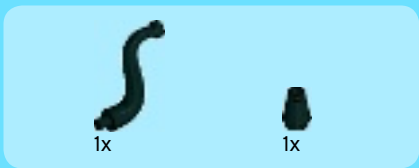

3



4



39





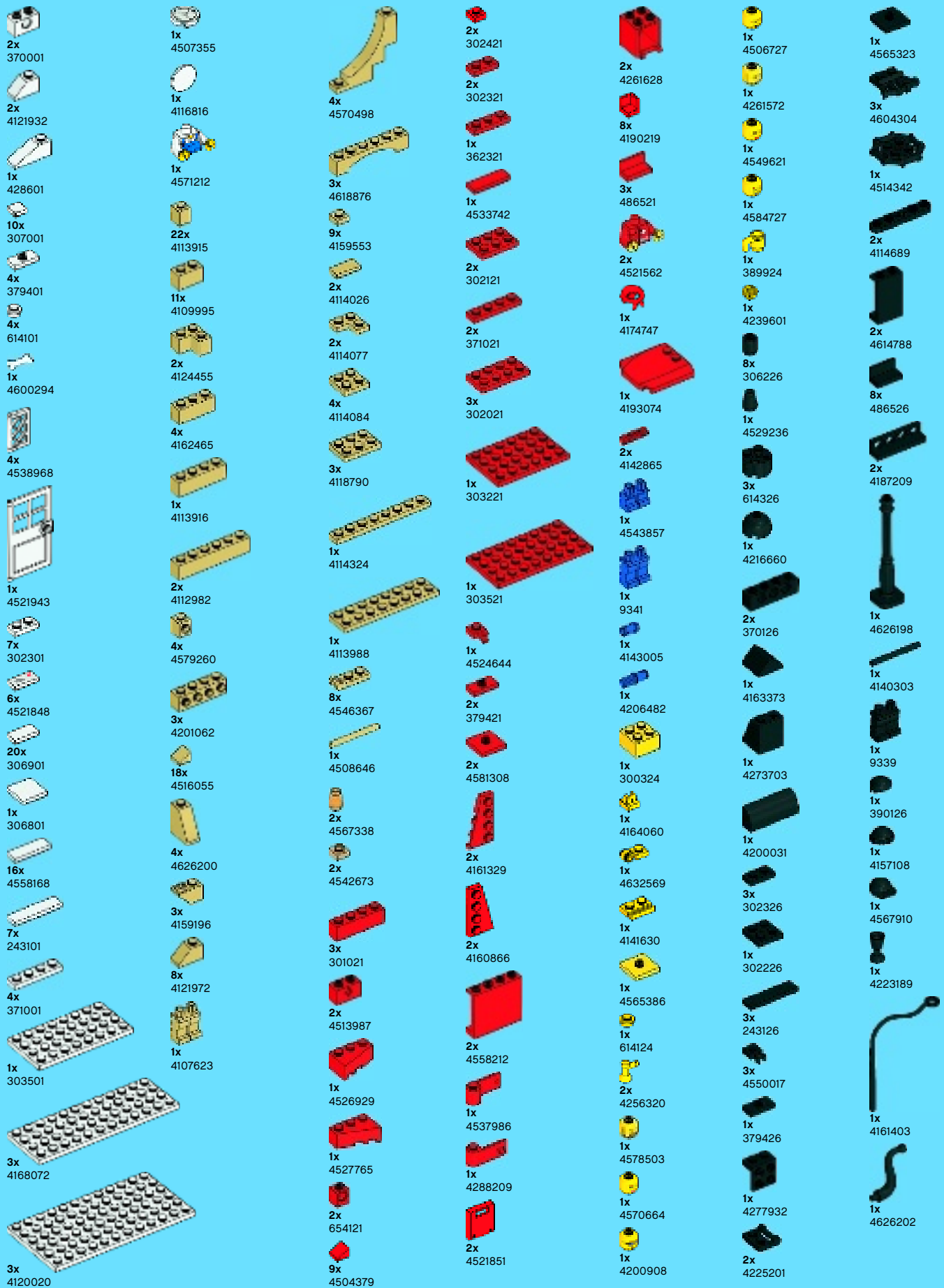

2x 370001  
 2x 4121932  
 1x 428601  
 10x 307001  
 4x 379401  
 4x 614101  
 1x 4600294  
 4x 4538968  
 1x 4521943  
 7x 302301  
 6x 4521848  
 20x 306901  
 1x 306801  
 16x 4558168  
 7x 243101  
 4x 371001  
 1x 303501  
 3x 4168072  
 3x 4120020

1x 4507355  
 1x 4116816  
 1x 4571212  
 22x 4113915  
 11x 4109995  
 2x 4124455  
 4x 4162465  
 1x 4113916  
 2x 4112982  
 4x 4579260  
 3x 4201062  
 18x 4516055  
 4x 4626200  
 3x 4159196  
 8x 4121972  
 1x 4107623

4x 4570498  
 3x 4618876  
 9x 4159553  
 2x 4114026  
 2x 4114077  
 4x 4114084  
 3x 4118790  
 1x 4114324  
 1x 4113988  
 8x 4546367  
 1x 4508646  
 2x 4567338  
 2x 4542673  
 3x 301021  
 2x 4513987  
 1x 4526929  
 1x 4527765  
 2x 654121  
 9x 4504379

2x 302421  
 2x 302321  
 1x 362321  
 1x 4533742  
 2x 302121  
 2x 371021  
 3x 302021  
 1x 303221  
 1x 303521  
 1x 4524644  
 2x 379421  
 2x 4581308  
 2x 4161329  
 2x 4160866  
 2x 4558212  
 1x 4537986  
 1x 4288209  
 2x 4521851

2x 4261628  
 8x 4190219  
 3x 486521  
 2x 4521562  
 1x 4174747  
 1x 4193074  
 2x 4142865  
 1x 4543857  
 1x 9341  
 1x 4143005  
 1x 4206482  
 1x 300324  
 1x 4164060  
 1x 4632569  
 1x 4141630  
 1x 4565386  
 1x 614124  
 2x 4256320  
 1x 4578503  
 1x 4570664  
 1x 4200908

1x 4565323  
 3x 4604304  
 1x 4514342  
 2x 4114689  
 2x 4614788  
 8x 486526  
 2x 4187209  
 1x 4626198  
 1x 4140303  
 1x 9339  
 1x 390126  
 1x 4157108  
 1x 4567910  
 1x 4223189  
 1x 4161403  
 1x 4626202

- 4x 4541455
- 6x 4273590
- 1x 4584126
- 4x 4569407
- 3x 368026
- 2x 370526
- 1x 4614107
- 4x 4504375
- 3x 4543949
- 8x 4586057
- 5x 4245566
- 1x 4612728
- 8x 4629681
- 4x 4505051
- 2x 4549214
- 2x 3000841
- 17x 3005741
- 4x 4155537
- 7x 3005744
- 1x 4549435
- 7x 4179826
- 4x 4527526
- 1x 4168345
- 20x 4179825
- 4x 4529115
- 1x 4629943
- 5x 4528488
- 5x 4205004
- 1x 4162916
- 1x 4275888
- 1x 4275821
- 1x 4541496

- 2x 302228
- 1x 4565321
- 1x 243528
- 3x 242328
- 1x 347128
- 1x 4619699
- 6x 4549436
- 7x 4528604
- 9x 4496699
- 5x 4507045
- 2x 4550168
- 1x 4550329
- 1x 4530712
- 8x 4266902
- 3x 4570451
- 2x 4598955
- 1x 4549990
- 2x 4523159
- 1x 4249039

- 2x 4211201
- 7x 4211180
- 6x 4504376
- 15x 4211150
- 5x 4211257
- 4x 4211152
- 2x 4211190
- 3x 4211194
- 3x 4211186
- 7x 4221590
- 3x 4211204
- 2x 4219726
- 3x 4216581
- 14x 4595814
- 3x 4595889
- 1x 4623513
- 1x 4211158
- 2x 4626199

- 3x 4211389
- 4x 4211388
- 1x 4211387
- 4x 4211428
- 1x 4211385
- 2x 4211511
- 5x 4215472
- 2x 4515374
- 5x 4211415
- 4x 4211398
- 6x 4211414
- 1x 4211397
- 1x 4211413
- 2x 4211429
- 1x 4211396
- 1x 4556157
- 1x 4541978
- 4x 4598526
- 1x 4211462

- 4x 4535738
- 1x 4282740
- 2x 4529120
- 1x 4221881
- 2x 4211503
- 1x 4292298
- 4x 4499259
- 1x 4226995
- 3x 4540203
- 1x 4520320
- 2x 4211098
- 4x 4211088
- 2x 4211103
- 20x 4211044
- 3x 4211090
- 1x 4211000
- 2x 4210797
- 2x 4618881
- 5x 4211052
- 4x 4211055

- 2x 4210635
- 3x 4211043
- 4x 4211001
- 1x 4211065
- 1x 4211056
- 2x 4211115
- 2x 4587212
- 3x 4211119
- 3x 4210631
- 5x 4210763
- 7x 4210633
- 1x 4211006
- 1x 4624374
- 1x 4113949
- 2x 3005740
- 14x 4552035
- 2x 4113028
- 1x 3001140
- 1x 4526177

 **Customer Service**  
**Kundenservice**  
**Service Consommateurs**  
**Servicio Al Consumidor**  
[www.lego.com/service](http://www.lego.com/service) or dial  
 00800 5346 5555 :           
 1-800-422-5346 :  

10216



+



10222



10197

10218

10211







# CREATOR

5770

5771



creator.LEGO.com



10220





FREE! GRATIS! GRATUIT!



www.LEGOclub.com



LEGO® Club Magazine



LEGO® Club Email

SIGN UP ONLINE!

www.LEGOclub.com

VISIT THE WORLD'S BIGGEST LEGO® SHOP!

www.LEGOshop.com



GO TO

www.LEGOclub.com

00800 5346 5555\*



1-866-534-6258 • 1-877-518-5346

US & Canada only

Canada seulement



\* Freephone. Mobile charges may apply. \* Numéro sans frais. Des frais peuvent s'appliquer avec les téléphones cellulaires. \* Gebührenfrei, Kosten für Anrufe aus Mobilfunknetzen können abweichen. \* Gratis telefoonnummer vanaf vaste lijn. \* Det er et gratis nummer, når du ringer fra fasttelefon. \* Det är gratis, när du ringer från en fast telefon. \* Numéro sans frais. Des frais peuvent s'appliquer avec les téléphones portables.



# WIN!

Go to [www.LEGOsurvey.com/product](http://www.LEGOsurvey.com/product) to fill out a survey for a chance to win a cool LEGO® Product.  
No purchase necessary.  
Open to all residents where not prohibited.



[www.LEGO.com](http://www.LEGO.com)



## [www.LEGOsurvey.com/product](http://www.LEGOsurvey.com/product)

### GEWINNE!

Nimm an der Umfrage auf [www.LEGOsurvey.com/product](http://www.LEGOsurvey.com/product) teil und hab die Chance ein cooles LEGO® Produkt zu gewinnen!

Die Teilnahme am Gewinnspiel führt zu keinerlei Kaufverpflichtungen. Teilnahme in allen nicht ausgeschlossenen Ländern möglich.

### WIN!

Ga naar [www.LEGOsurvey.com/product](http://www.LEGOsurvey.com/product), vul een enquêteformulier in en maak kans op een cool LEGO® product.

Geen aankoopverplichting.  
Iedereen mag deelnemen, uitzonderend ingezetenden van landen waar een enquêteverbod geldt.

### GAGNE!

Visite [www.LEGOsurvey.com/product](http://www.LEGOsurvey.com/product) pour répondre à un questionnaire et avoir une chance de gagner un produit LEGO® très cool!

Aucune obligation d'achat.  
Ouvert à tous les résidents des pays autorisés.

### 当てよう!

[www.LEGOsurvey.com/product](http://www.LEGOsurvey.com/product) にアクセスして、アンケートにご記入ください。当選者にはレゴ®製品を差し上げます。

お買い上げの必要はありません。  
禁止されていない限り、すべての皆様にご利用いただけます。

Trademarks, design patents and copyrights are used with the approval of the owner Volkswagen AG./

Les marques déposées, les brevets de conception et les copyrights sont utilisés avec l'autorisation du propriétaire Volkswagen AG./

El uso de las marcas comerciales, patentes de diseño y derechos de autor se realiza con el consentimiento de su propietario, Volkswagen AG.

LEGO and the LEGO logo are trademarks of the/son/ des marques de commerce de/son marcas registradas de LEGO Group. ©2011 The LEGO Group.