



Camaro Z/28
1969





The '69 Z/28. So ominous it goes by its code name. Curbie Leback '302. Standard equipment: mechanical lifters, high-performance cam and an aluminum intake manifold under a massive Holley 4-barrel. Underneath, multi-leaf rear springs and heavy-duty shocks. New '69 are special white lettered tires on 15 x 7-inch wide wheels and a Hurst shifter for the 4-speed.

To complete the setup, just add the new 'Vette-type 4-wheel power disc brakes. By now you know the mean streak isn't just pointed on—it's built in. One more thing. People are bound to ask what the Z stands for. Tell them "Zaps" Chevrolet. Putting you first, keeps us first.

DAS SPORT-COUPÉ

Als die ersten erschwinglichen, sportlichen und stylischen „Pony Cars“ Mitte der 1960er-Jahre herauskamen, stellten sie den Automarkt auf den Kopf. Eine neue, jüngere Generation von Autofahrern fand sofort Gefallen an der schnittigen Karosserie mit langer Motorhaube und den leistungsstarken Motoren. Zwar brachten fast alle Autohersteller eine eigene Version des Pony Cars heraus, doch nur wenige Modelle waren ähnlich erfolgreich wie der legendäre Camaro von Chevrolet.



The skier's skier with the Camaro's Camaro.



There are skiers. And then there are skiers. Jean-Claude Killy is one of the latter.

The Camaro Z/28 is a special breed, too. It comes poised on a beefed-up suspension and special road-grabbing wide oval tires.

Under that striped hood is a tough 302 V8 that inhales through a big Holley 4-barrel and exhales through dual exhausts.

Z/28

Add four-on-the-floor with a Hurst shifter plus 4-wheel power disc brakes and you've got the closest thing to a 'Vette yet. Z/28. In our Sports Department. Almost as much fun as skiing.

Putting you first, keeps us first.

See Olympic Gold Medalist Jean-Claude Killy, Sundays, CBS-TV. Check your local TV listings.

69-CH-43 A
Ski February
Skiing February
1 page-4 colors
A P 7729-11 21 68-5



MIT DRÖHNENDEM MOTOR ZUM ERFOLG

Der Chevrolet Camaro Z28 der zweiten Generation ist noch immer der Inbegriff des Muscle-Cars. Dieses Modell mit der typischen „Cowl Induction“-Motorhaube kam 1969 heraus und bestach mit seiner schnittigen Linienführung, die sich über die Kotflügel und Türen zog. Auf Anleihen bei anderen Automodellen wurde damals bewusst verzichtet. Auch mehr als 50 Jahre später wirkt dieses Auto deshalb immer noch ebenso frisch wie frech.



camaro

Camaro

CAMARO



1967 – 1969

1970 – 1981

1982 – 1992

IKONE DER AUTOWELT

Obwohl seit der Premiere des ersten Chevrolet Camaro bereits 55 Jahre vergangen sind, ist das berühmte Modell immer noch sehr lebendig und relevant. Heute wird bereits die sechste Generation des legendären Autos produziert. Die Marke und der Modellname erreichen noch immer die Fans von Muscle-Cars jeden Alters. Der Camaro ist aus vielen Videospiele, TV-Serien und Kinofilmen nicht mehr wegzudenken und hat längst einen festen Platz in der Popkultur.

CAMARO

CAMARO



1993 - 2002

2010 - 2015

2016 -



ANMERKUNGEN DES DESIGNTEAMS

„Schon als Kind und Jugendlicher hatten es mir Autos angetan und ich blätterte bereits in sehr jungen Jahren durch Hot-Rod-Magazine. Deshalb ist für mich ein Traum wahr geworden, als ich bei diesem LEGO® Modell mit echten Chevrolet-Autodesignern zusammenarbeiten durfte. Wir mussten das Styling und die Ausstrahlung des Autos genau hinbekommen, wollten aber auch unbedingt wichtige Details wie aufklappbare Türen und eine funktionierende Lenkung hinzufügen. Es war toll, dass wir einige Anpassungsoptionen anbieten konnten. Denn schließlich war das damals beim Original-Camaro auch möglich.“

Sven Franic, LEGO® Designer



DEIN MODELL. DEIN DESIGN.

Für den Original-Camaro stand ein breites Spektrum an Konfigurationsoptionen und Hochleistungsmotoren zur Wahl. Vor allem dieser Anpassungsfähigkeit verdankte das Auto seine große Beliebtheit. Und jetzt darfst du deine LEGO® Version des Autos auswählen: Baust du lieber ein Coupé mit festem Dach oder ein cooles Cabrio? Welche Farbe sollen die Streifen bekommen? Klassisches Weiß, elegantes Grau oder markantes Rot? Außerdem gibt es optionale Scheinwerferklappen und zwei Nummernschildsätze.



Die drei Modelle lassen sich nicht gleichzeitig bauen.

Die Bauanleitungen für diese alternativen Modelle findest du auf:
[LEGO.com/buildinginstructions](https://www.lego.com/buildinginstructions)



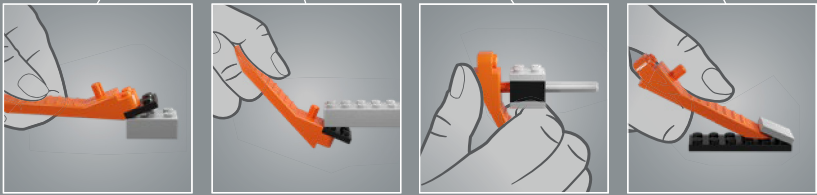
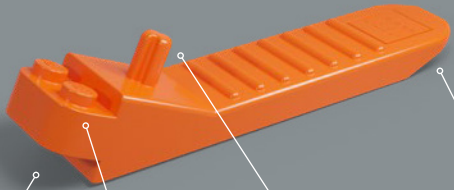
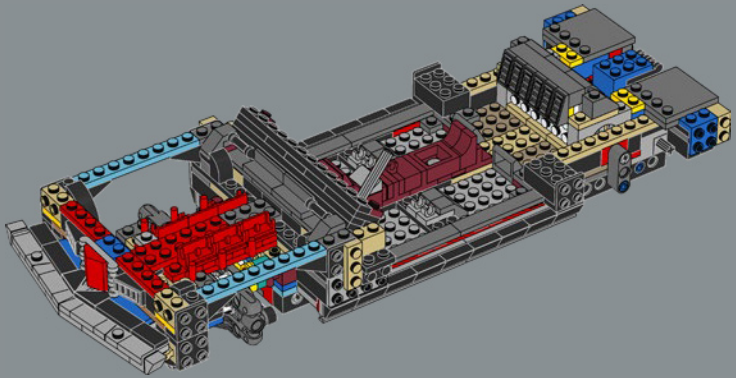
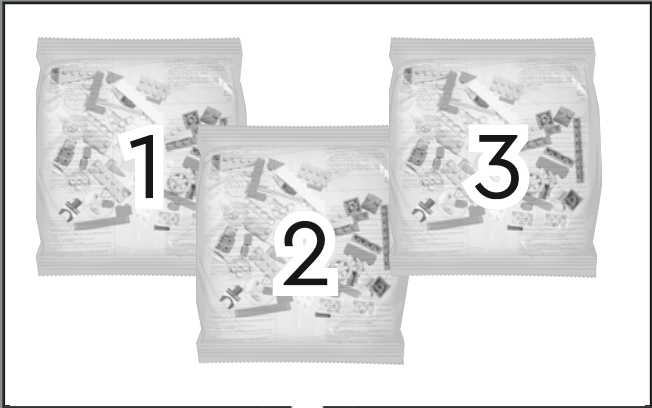

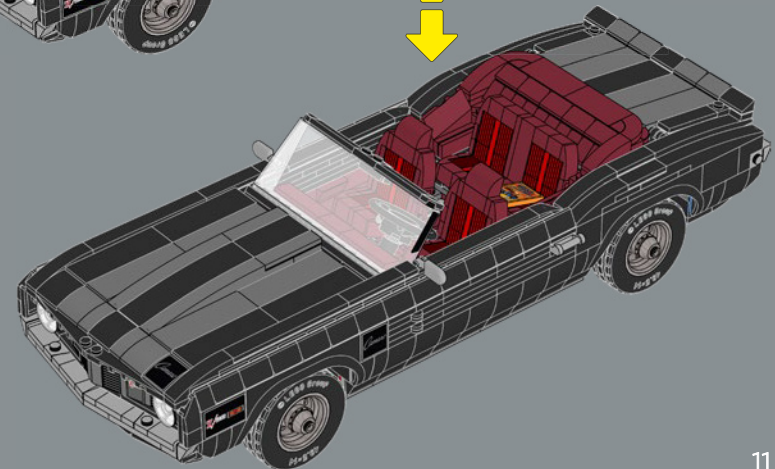
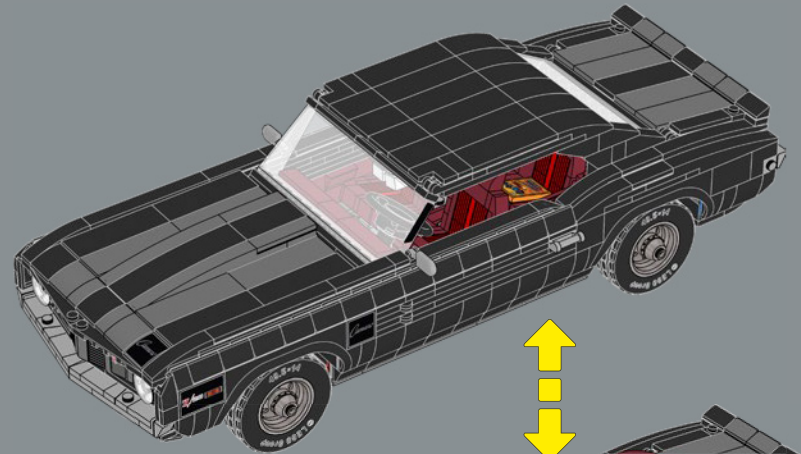
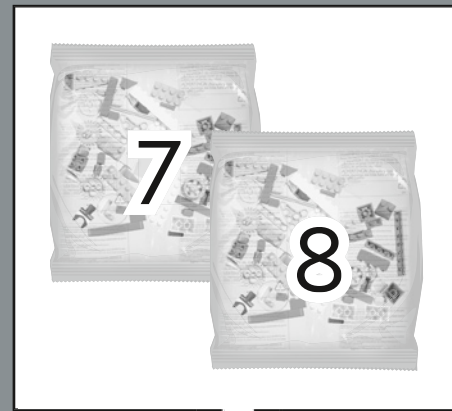
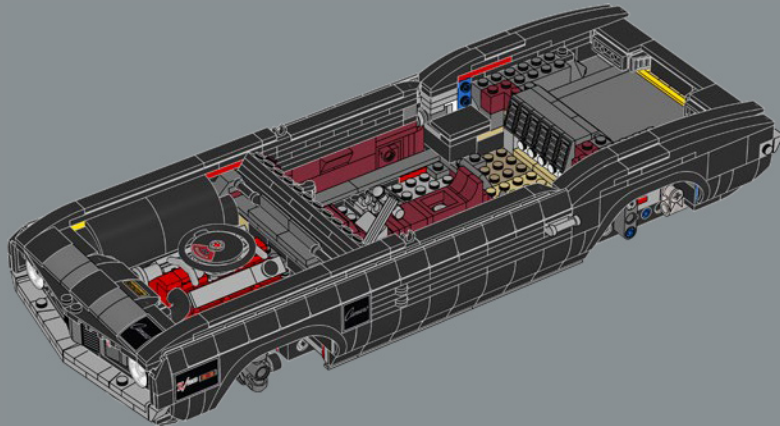
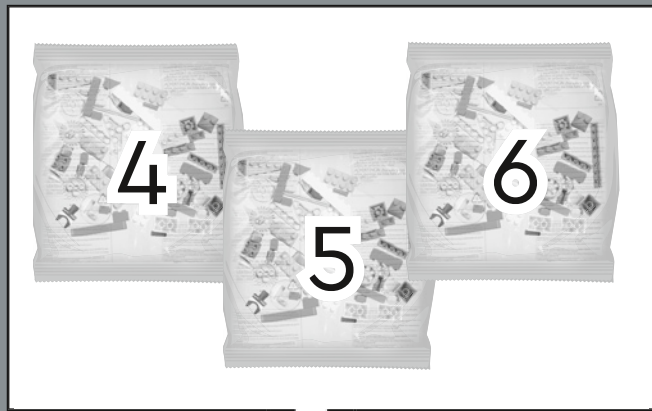

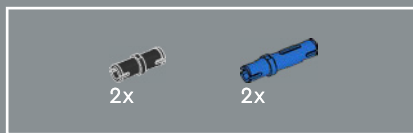
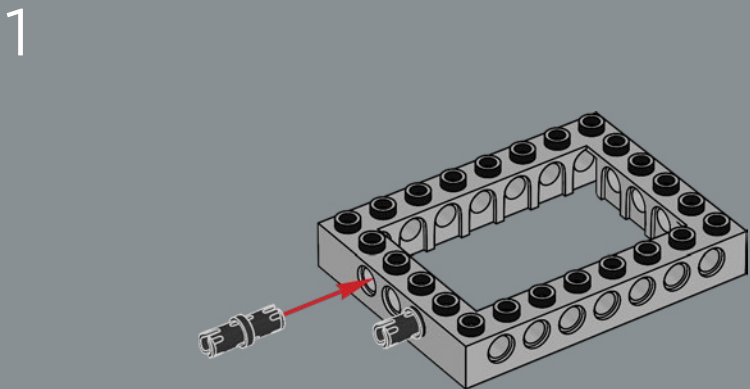
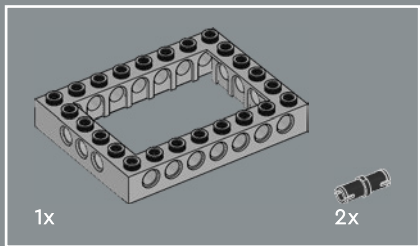

2

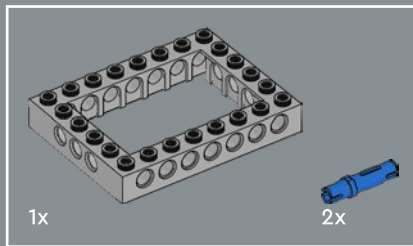
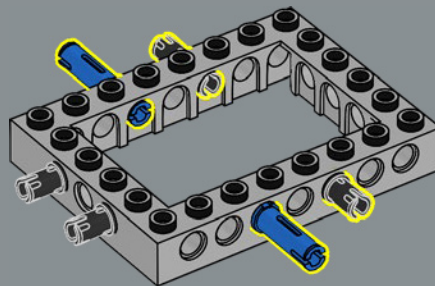

3

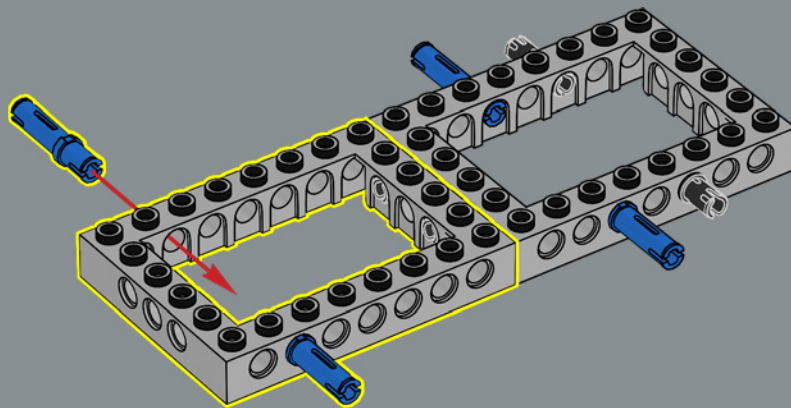

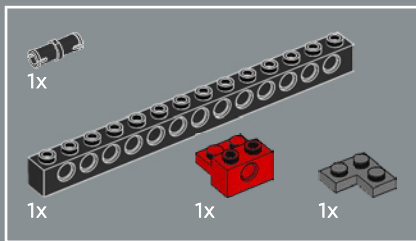

4

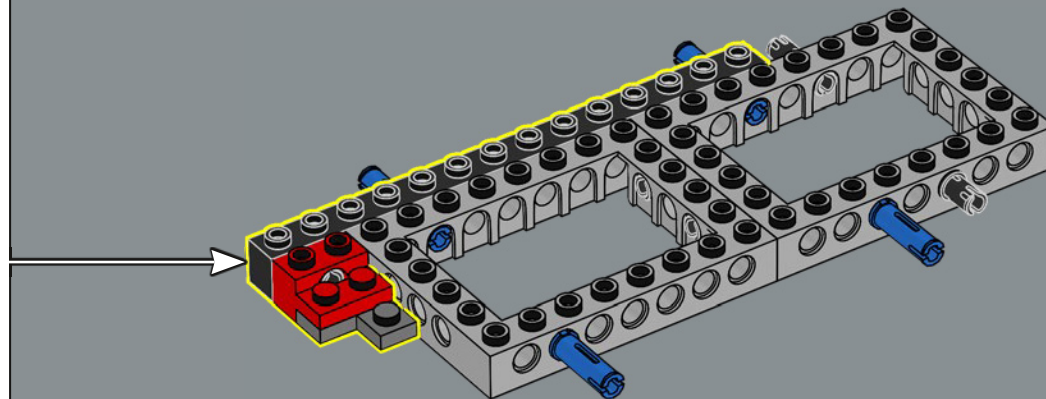
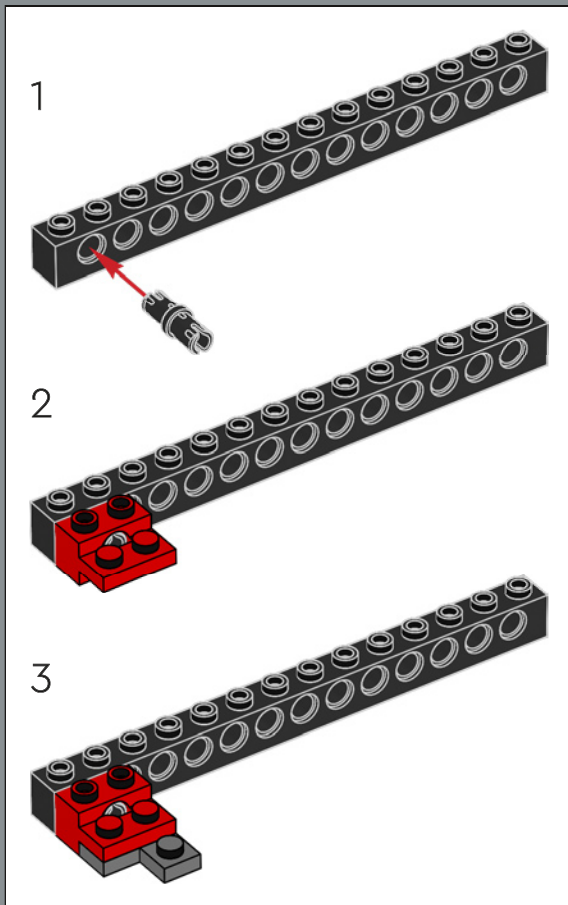

Der Name „Camaro“ setzt eine lange Tradition bei Chevrolet fort, denn die Marke bevorzugt Modellnamen mit dem Anfangsbuchstaben „C“ (Corvaire, Corvette, Chevelle, usw.).

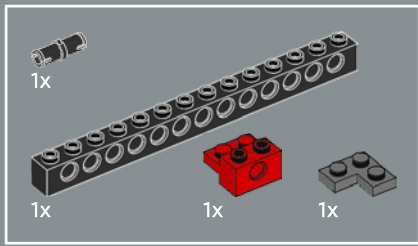

5

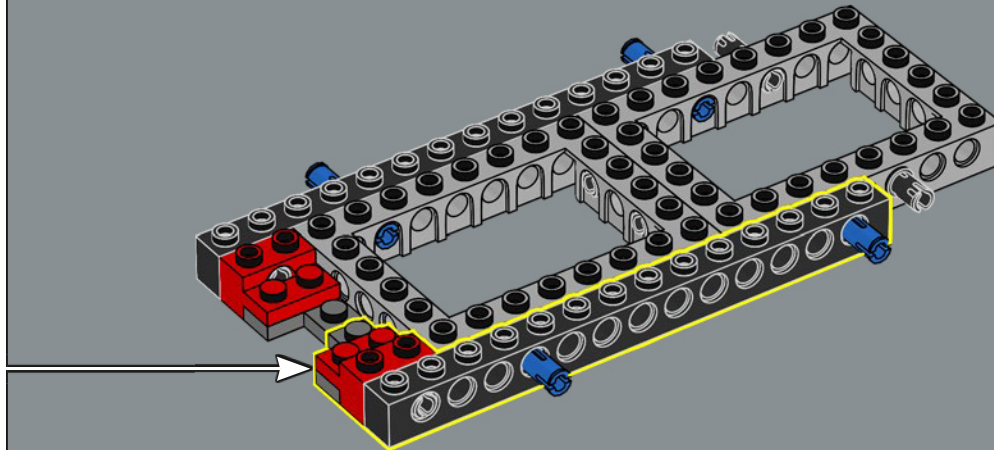
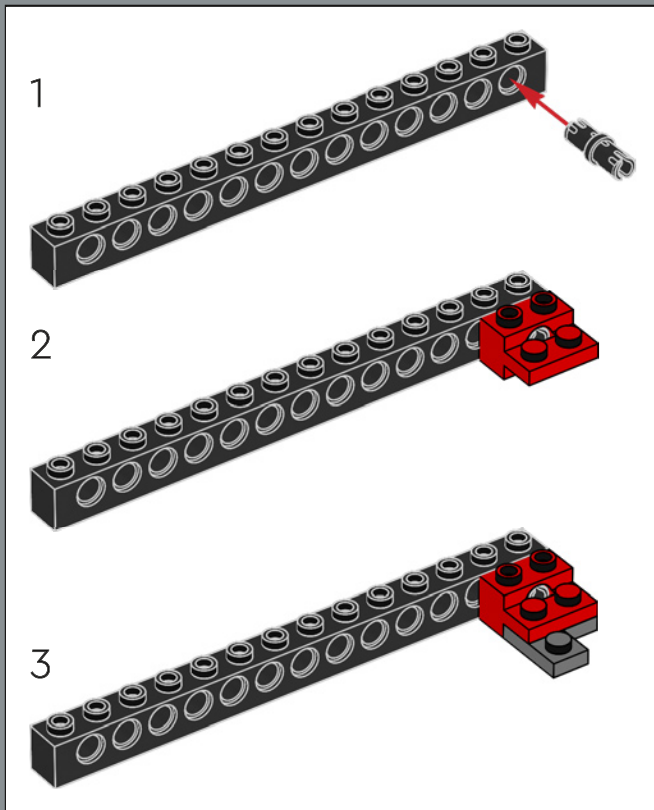

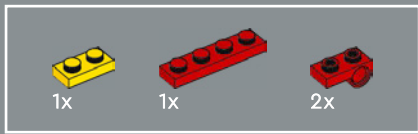

6

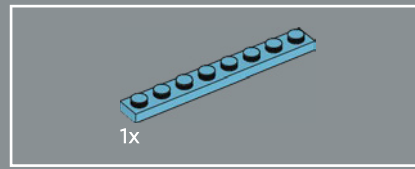
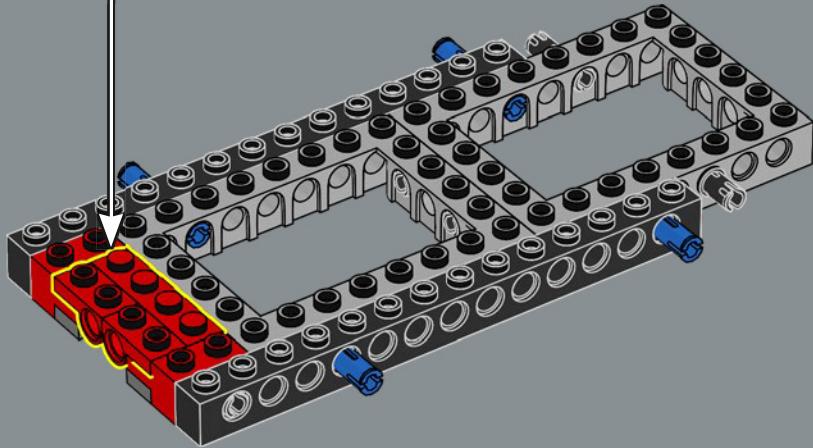
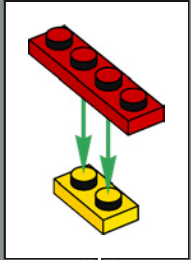

7

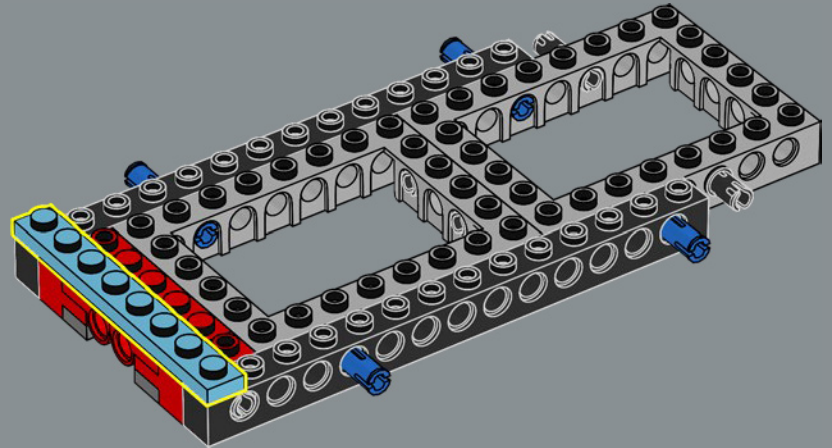

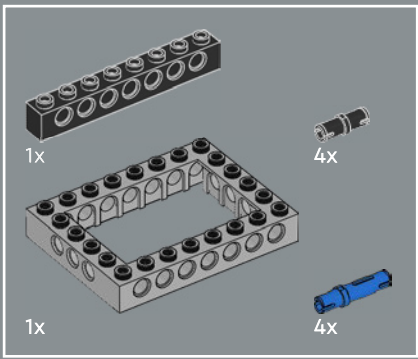

8

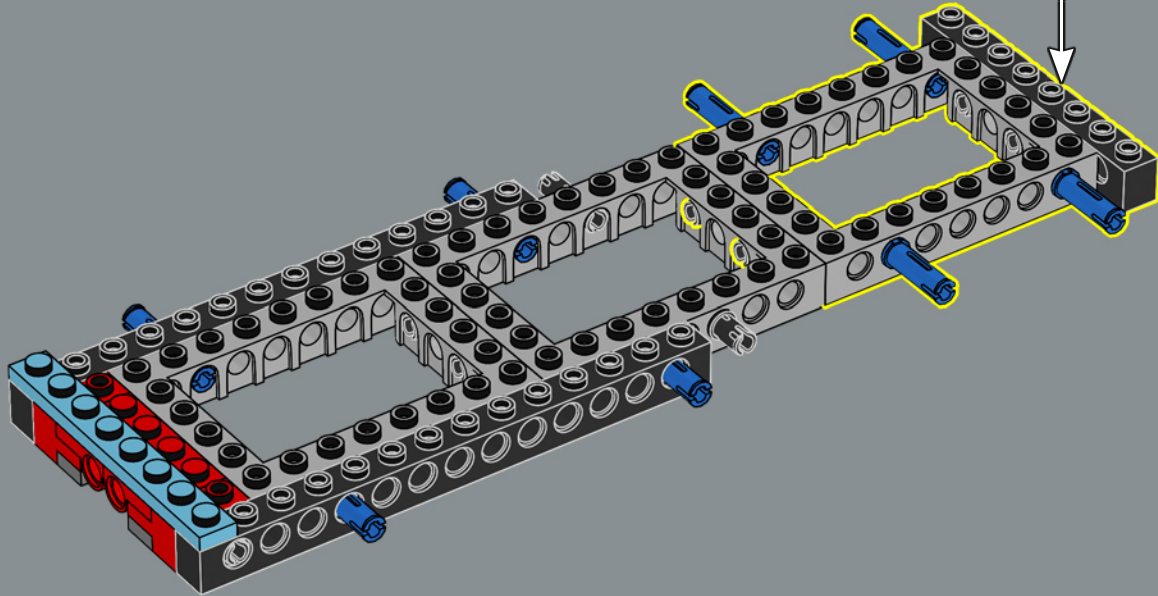
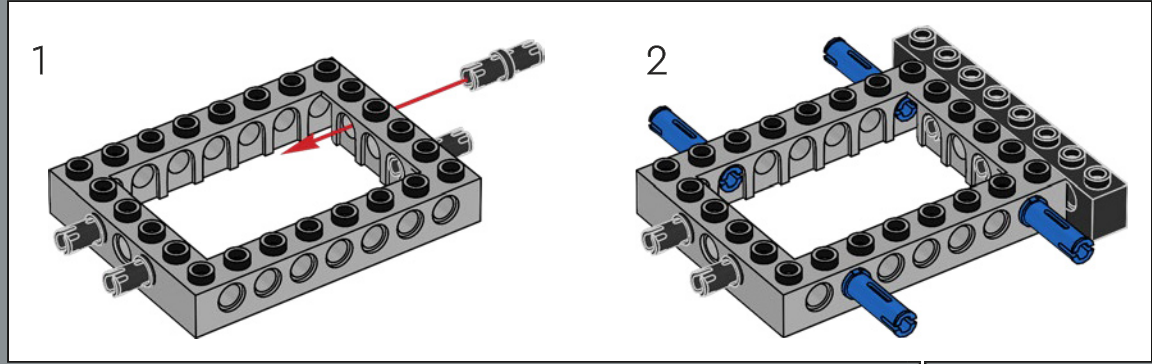

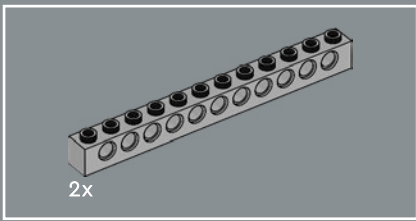

9

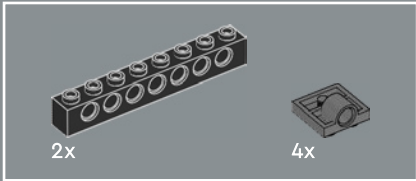
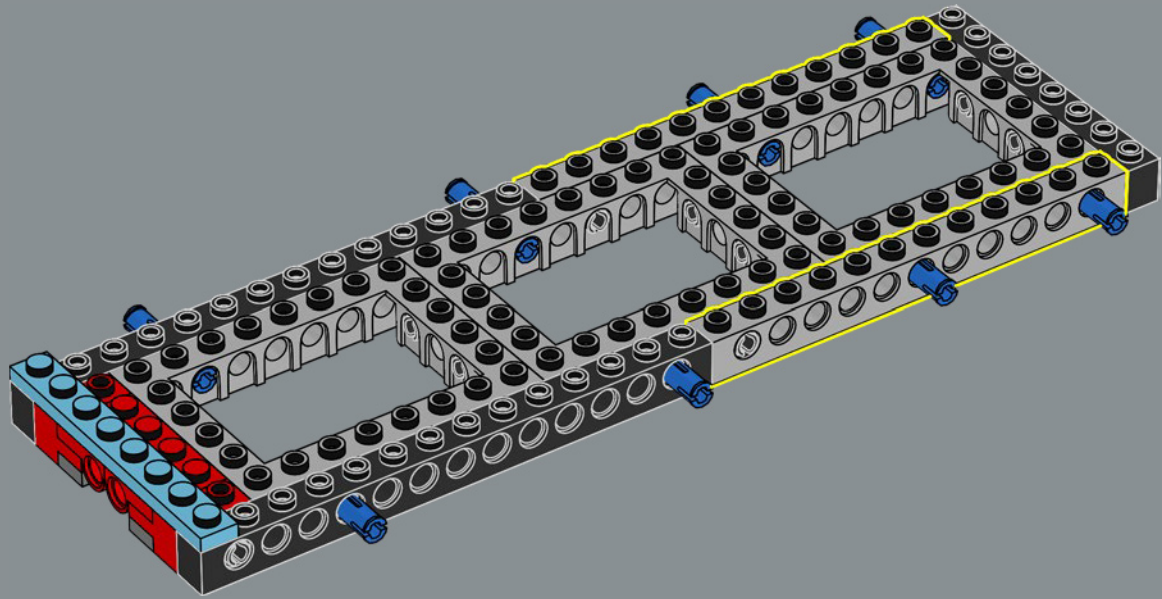

10

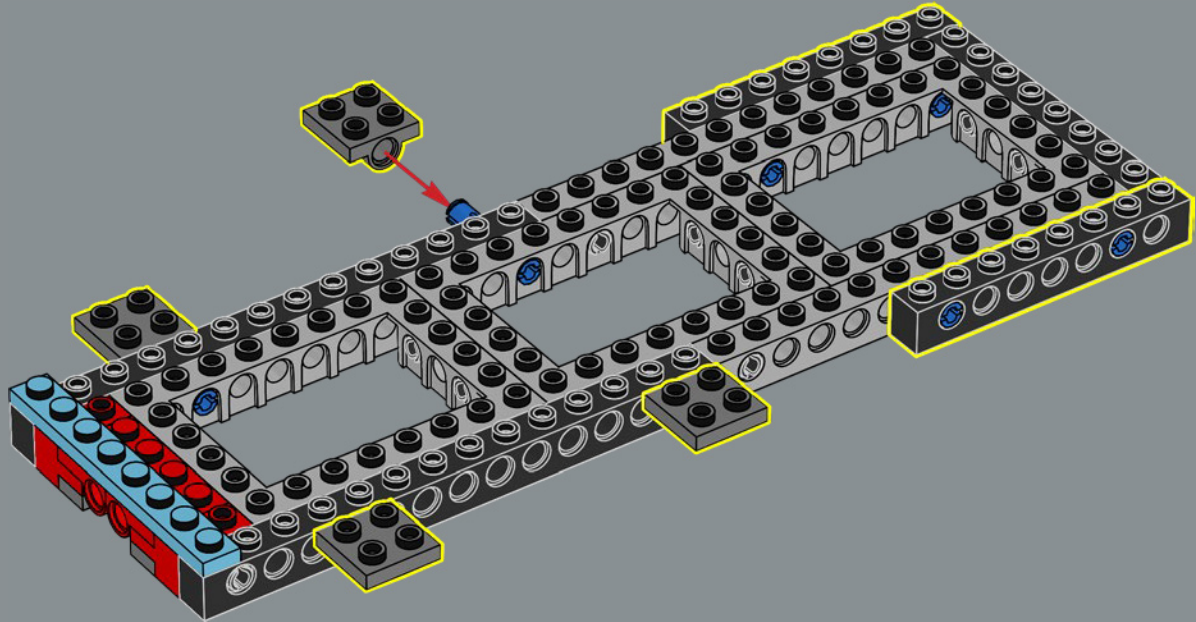

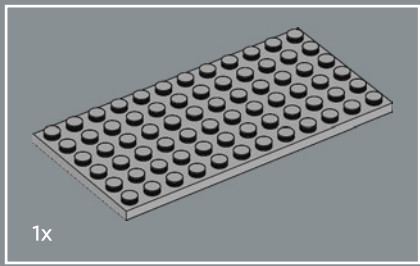

11

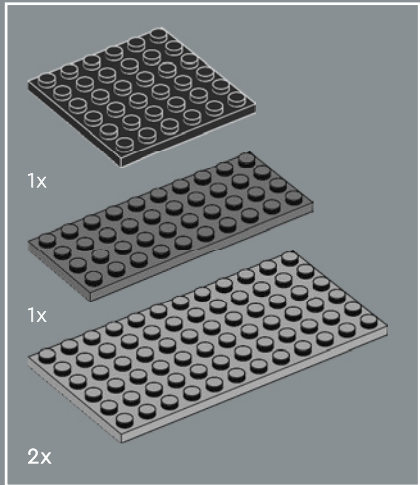
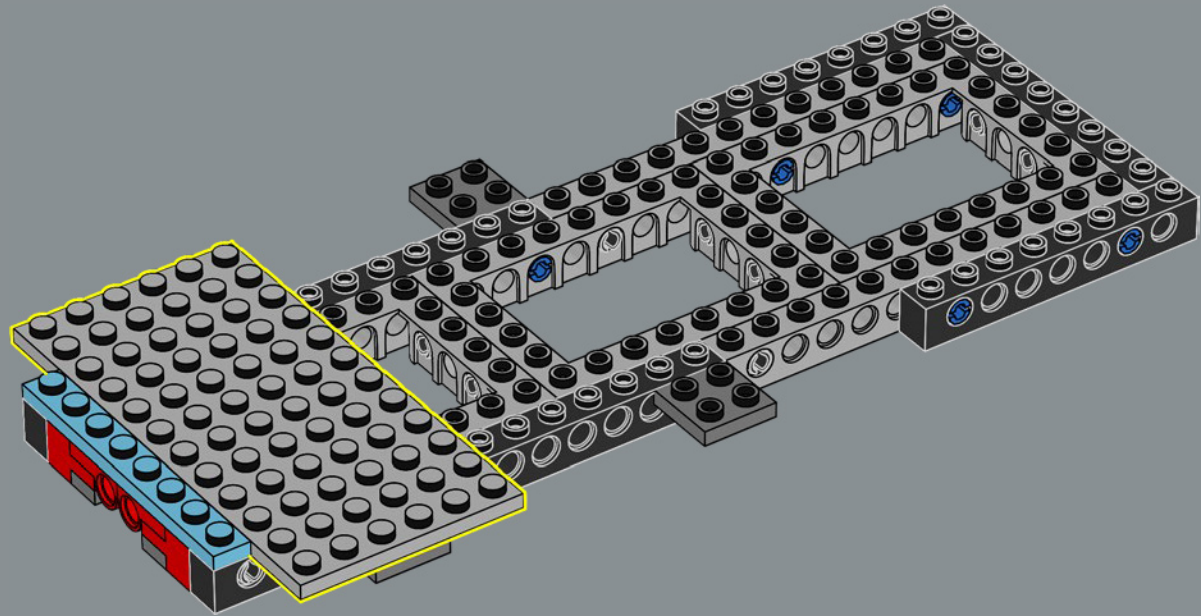

12

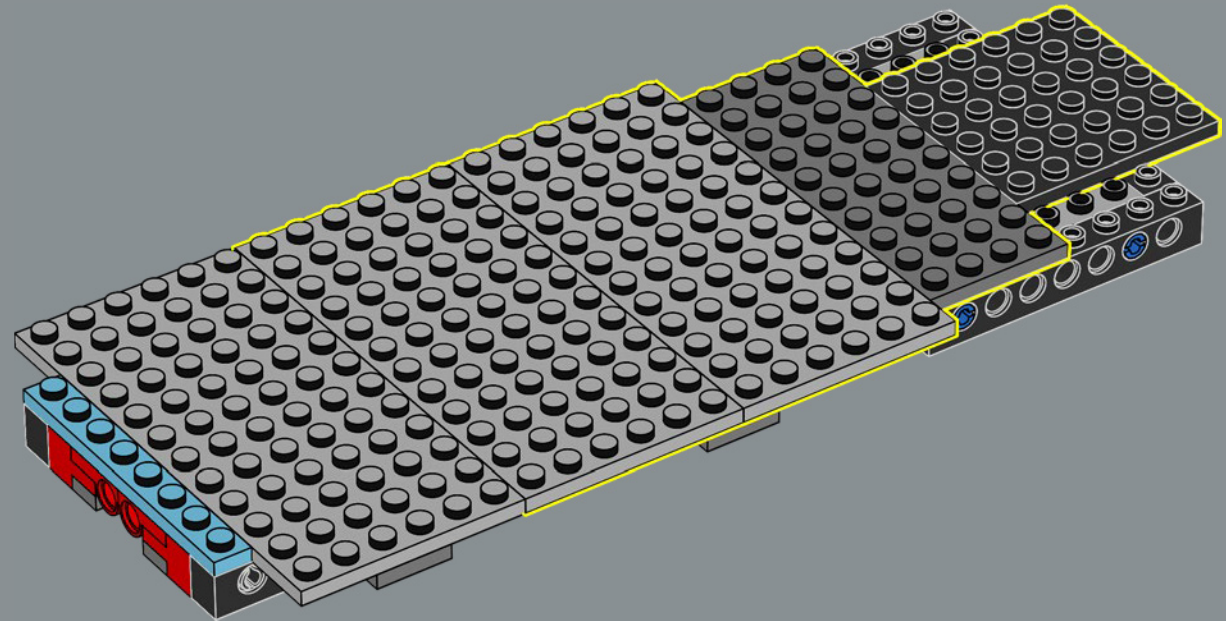



13

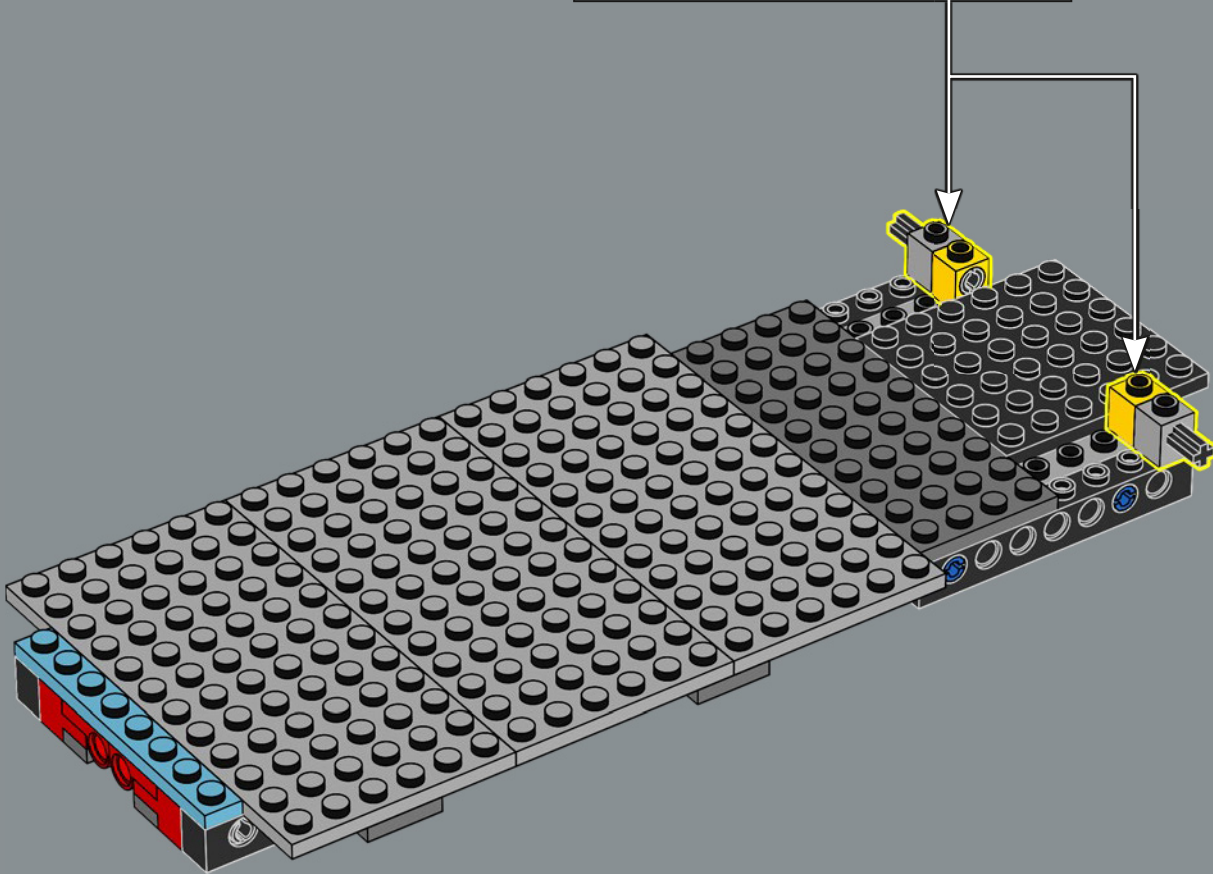
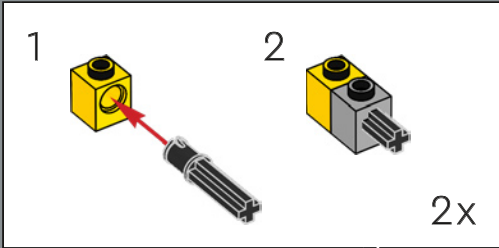

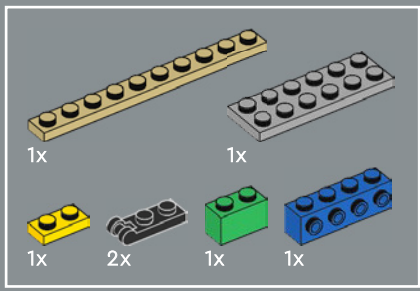

14

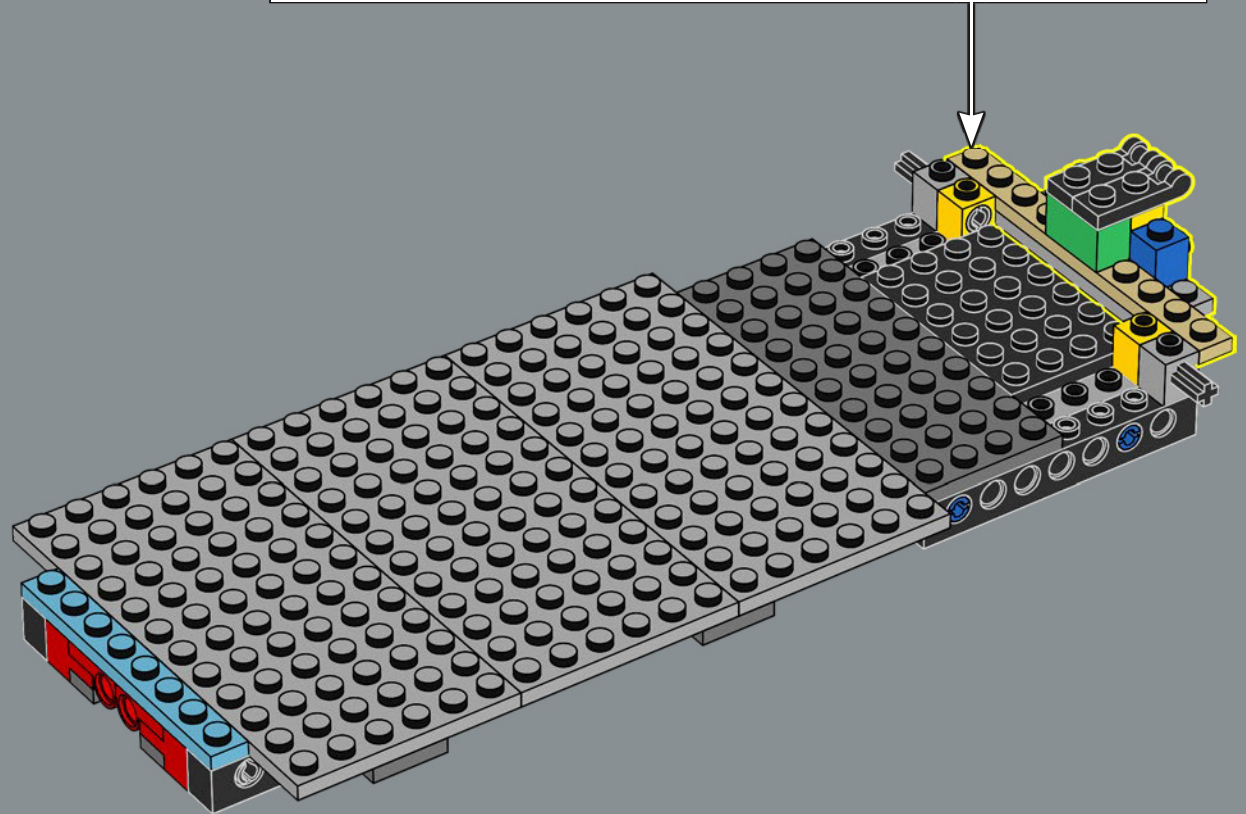
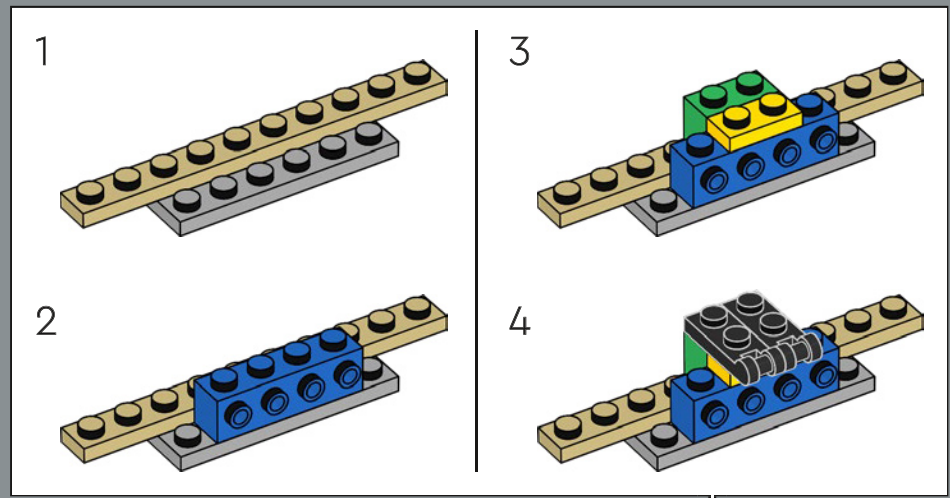

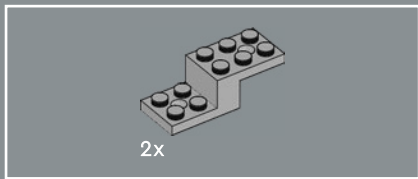

15

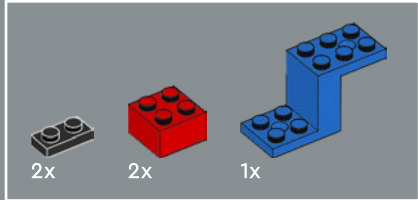
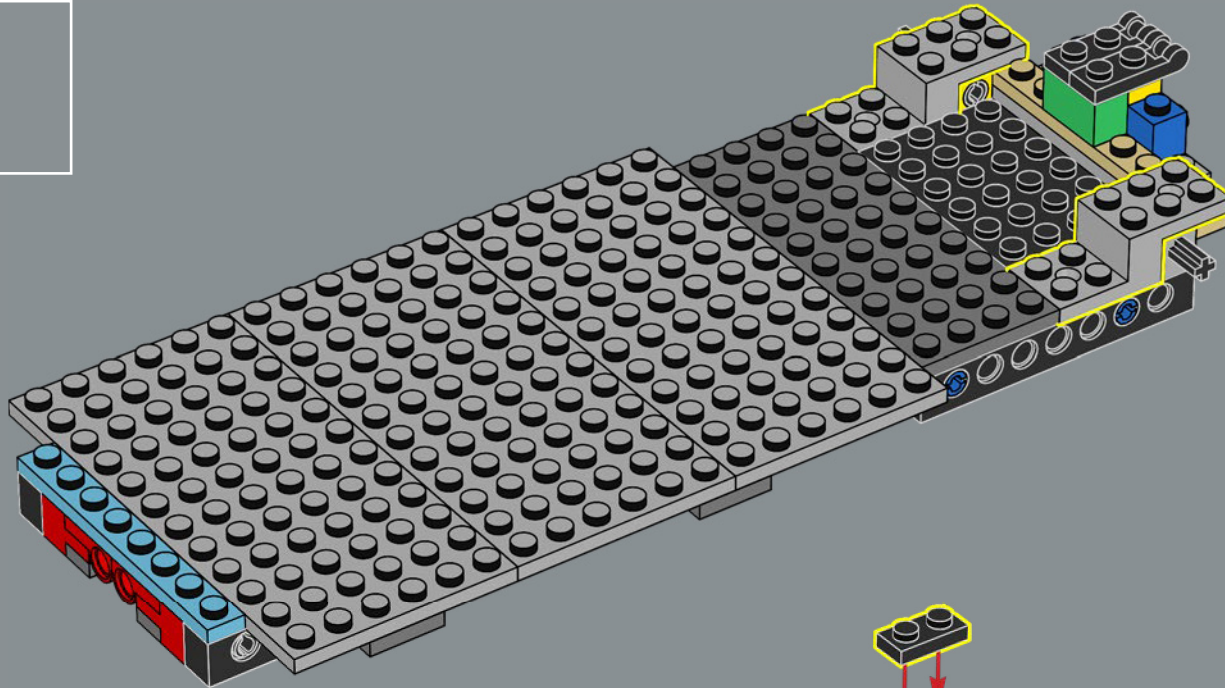

16

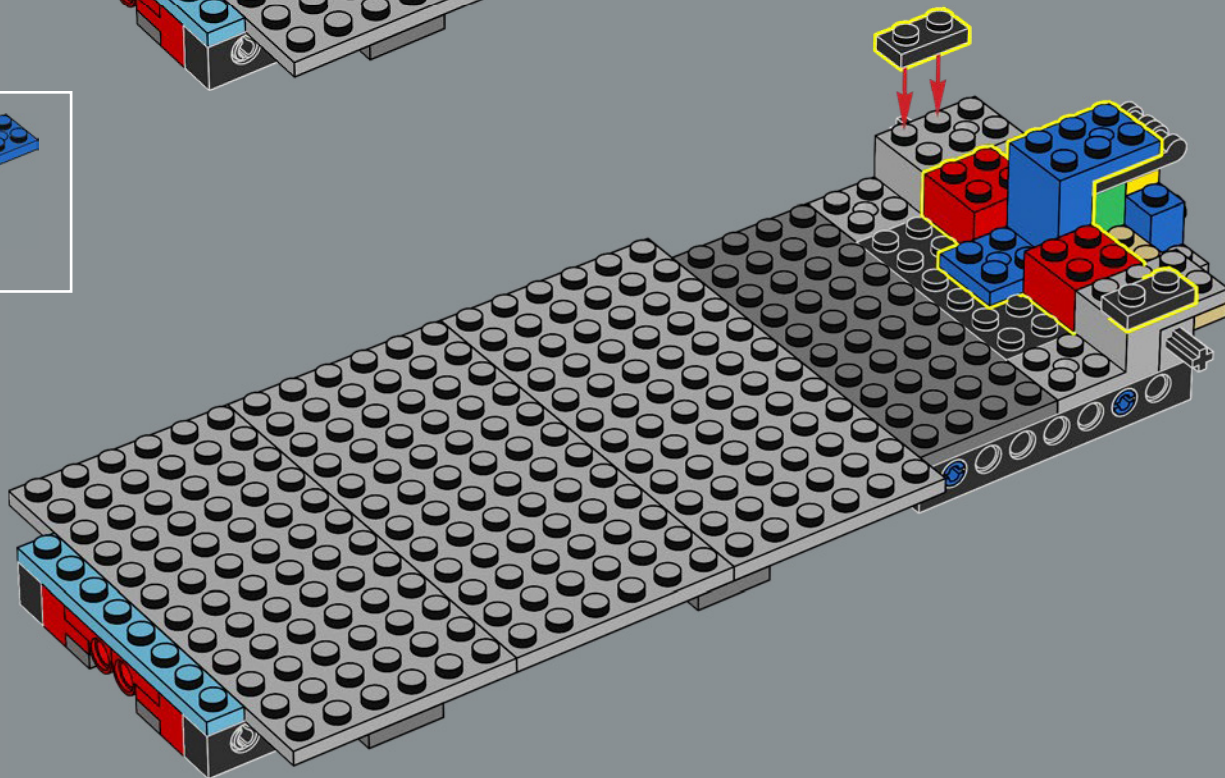

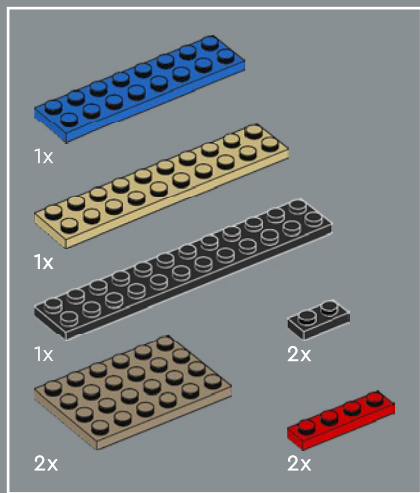

17

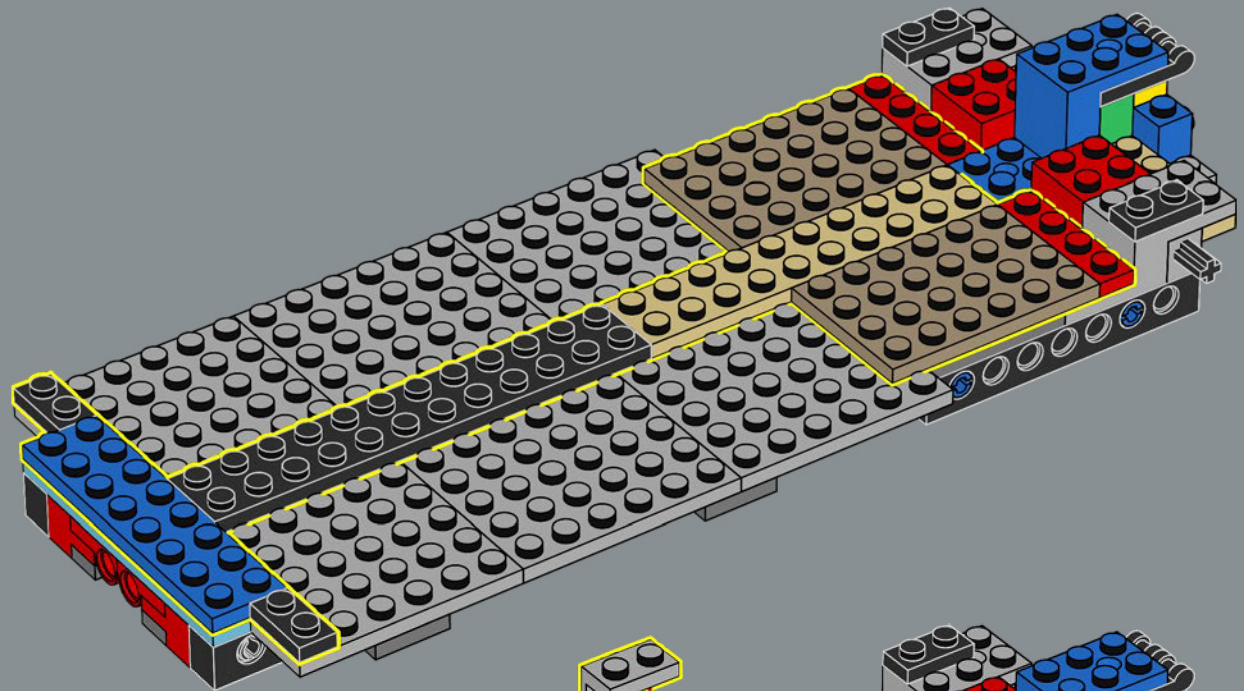

18

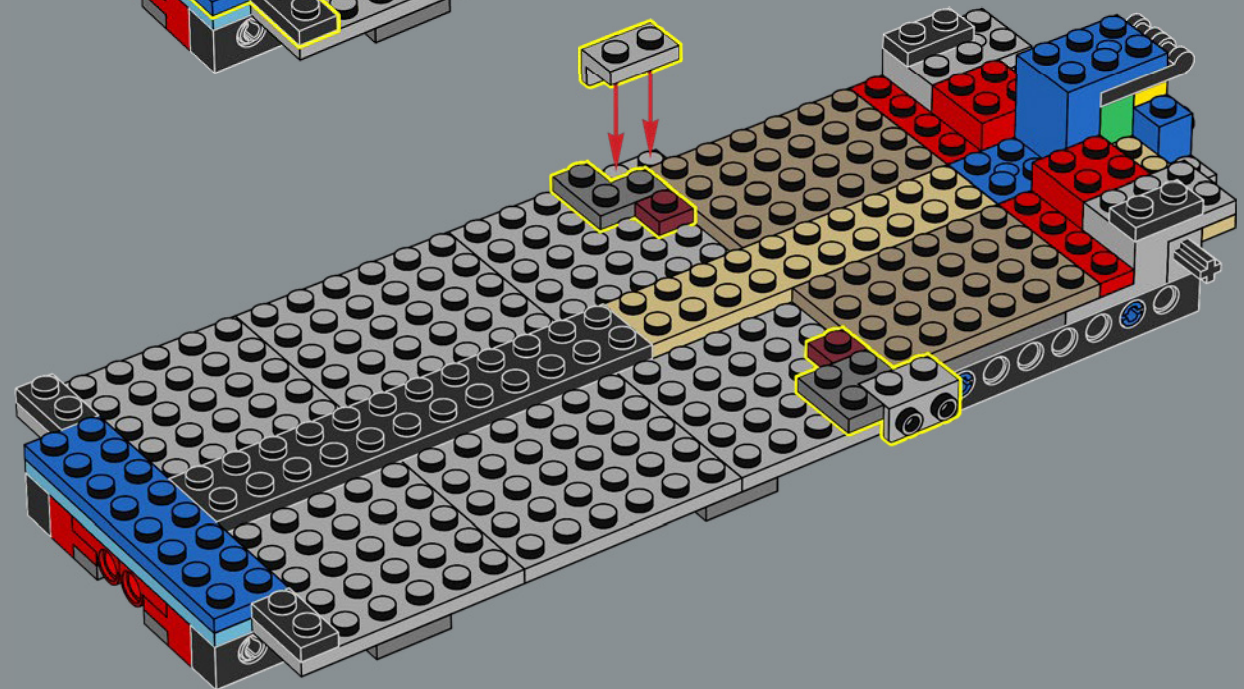

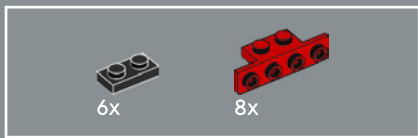

19

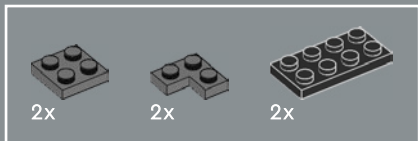
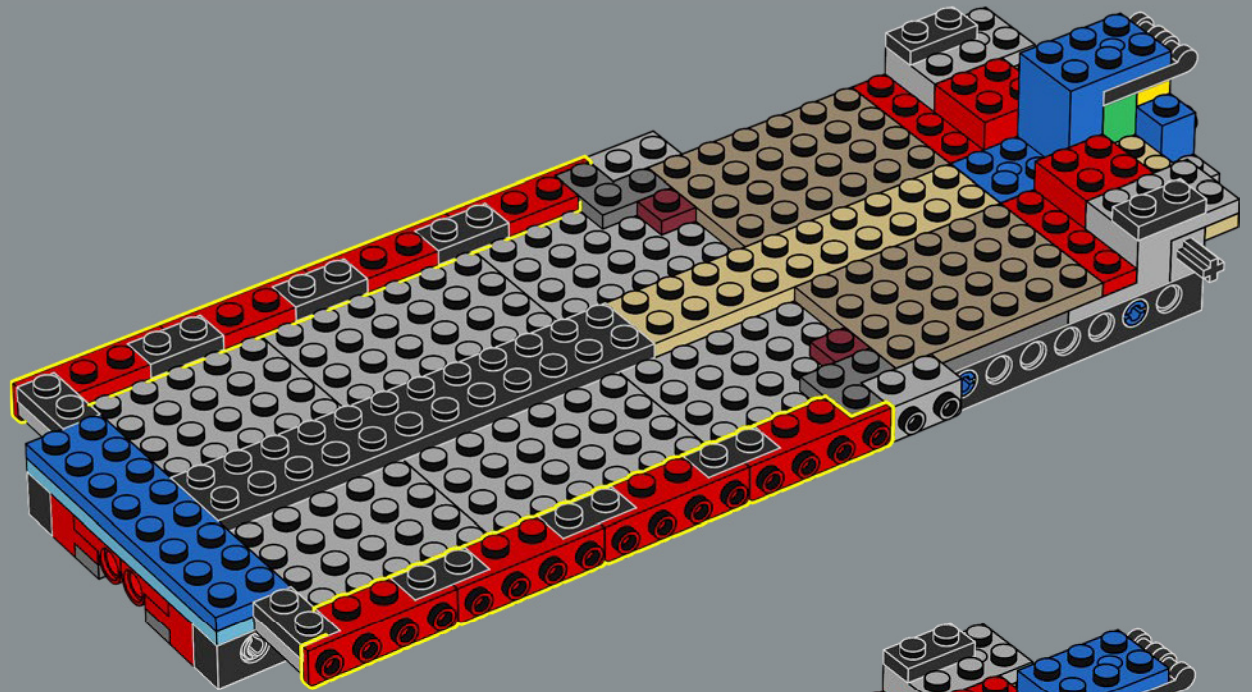

20

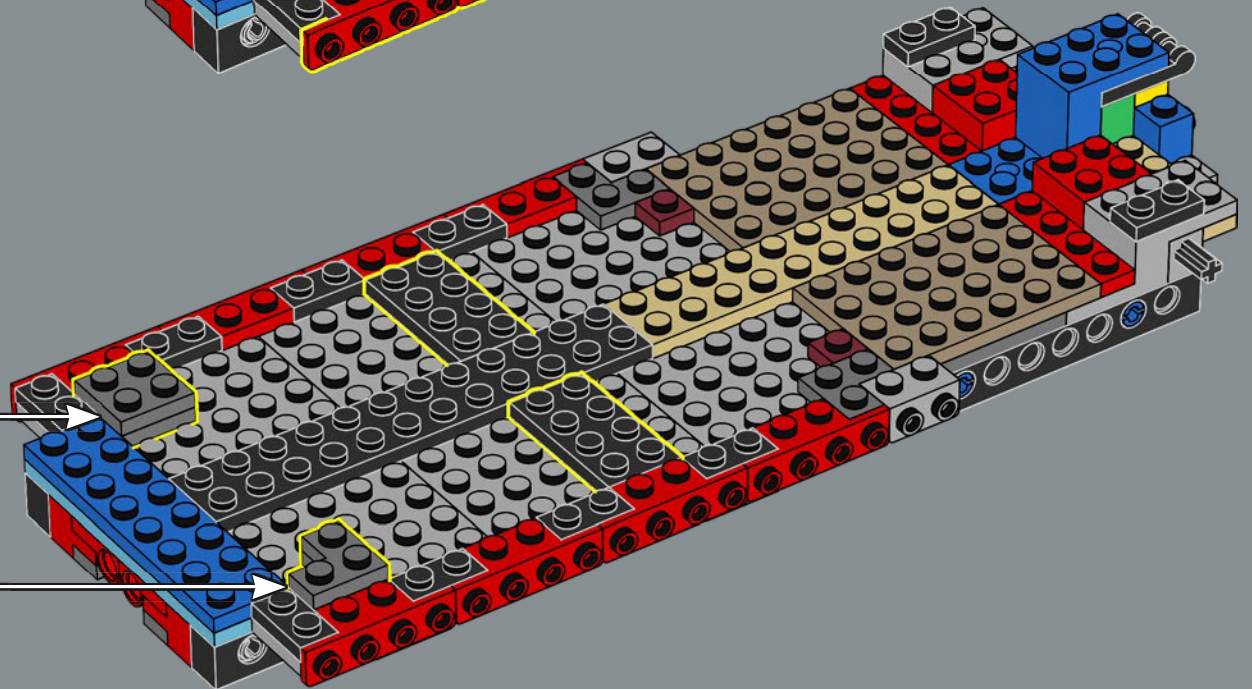
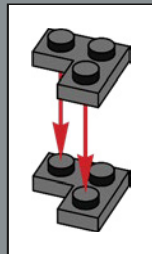
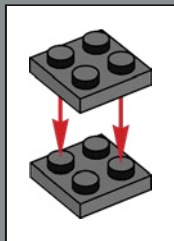

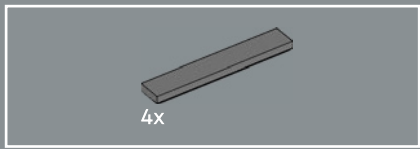

21

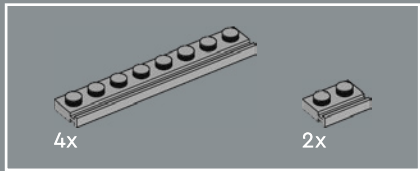
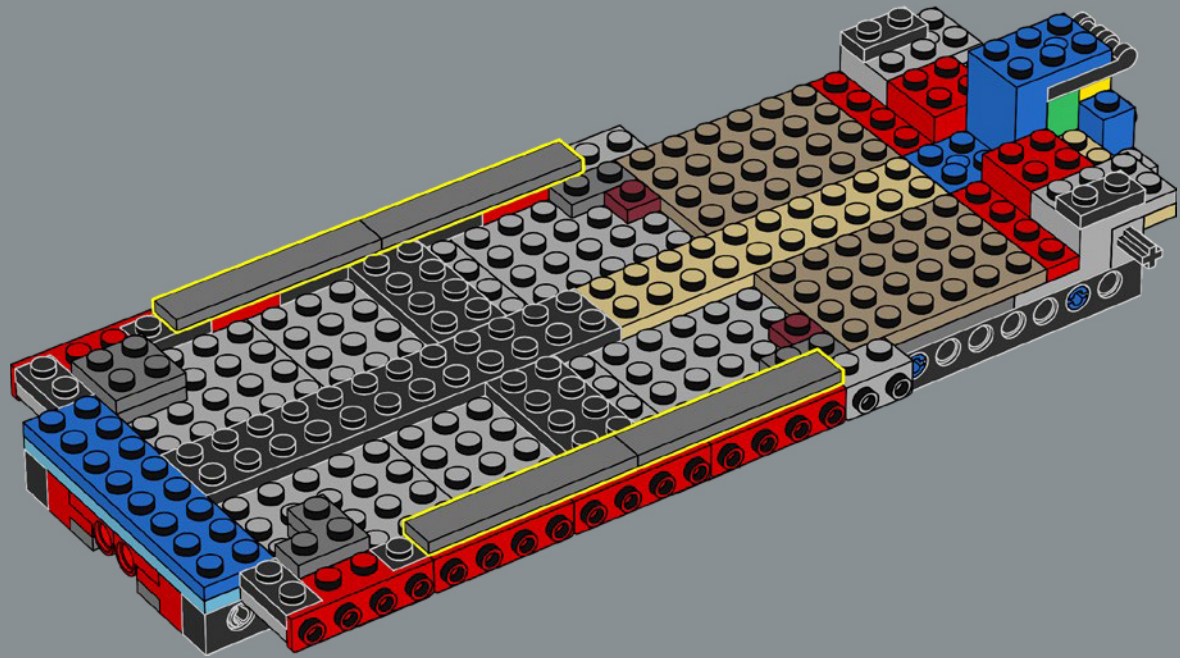

22

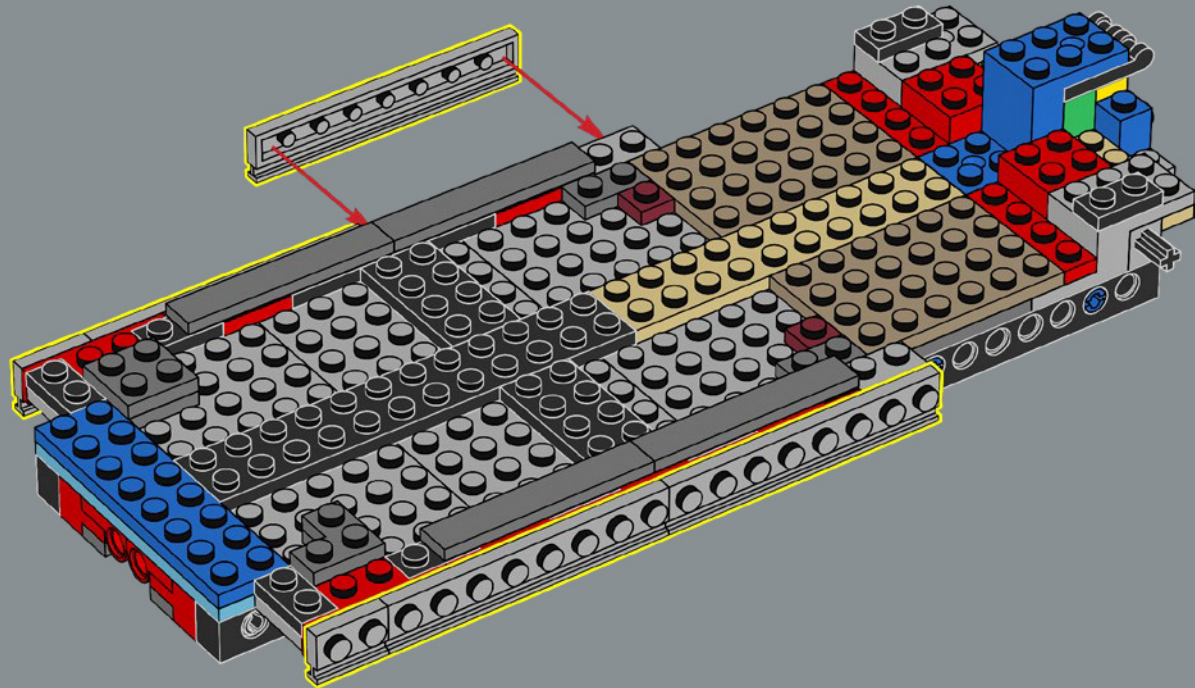



23

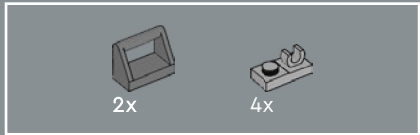
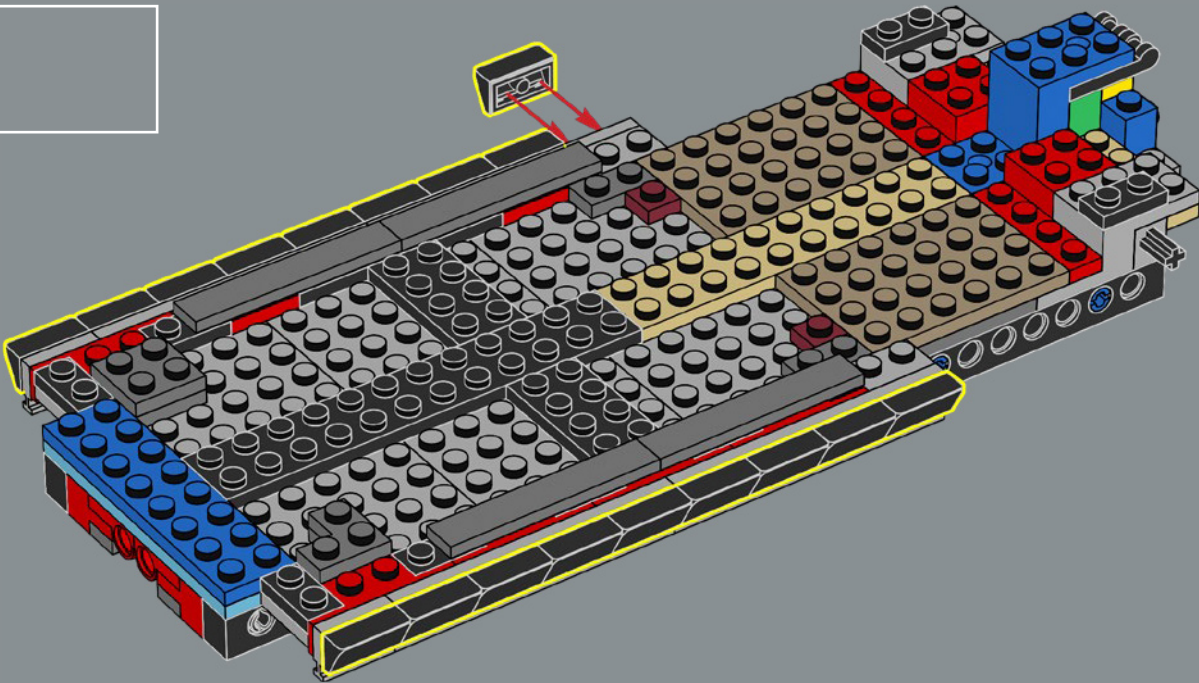

24

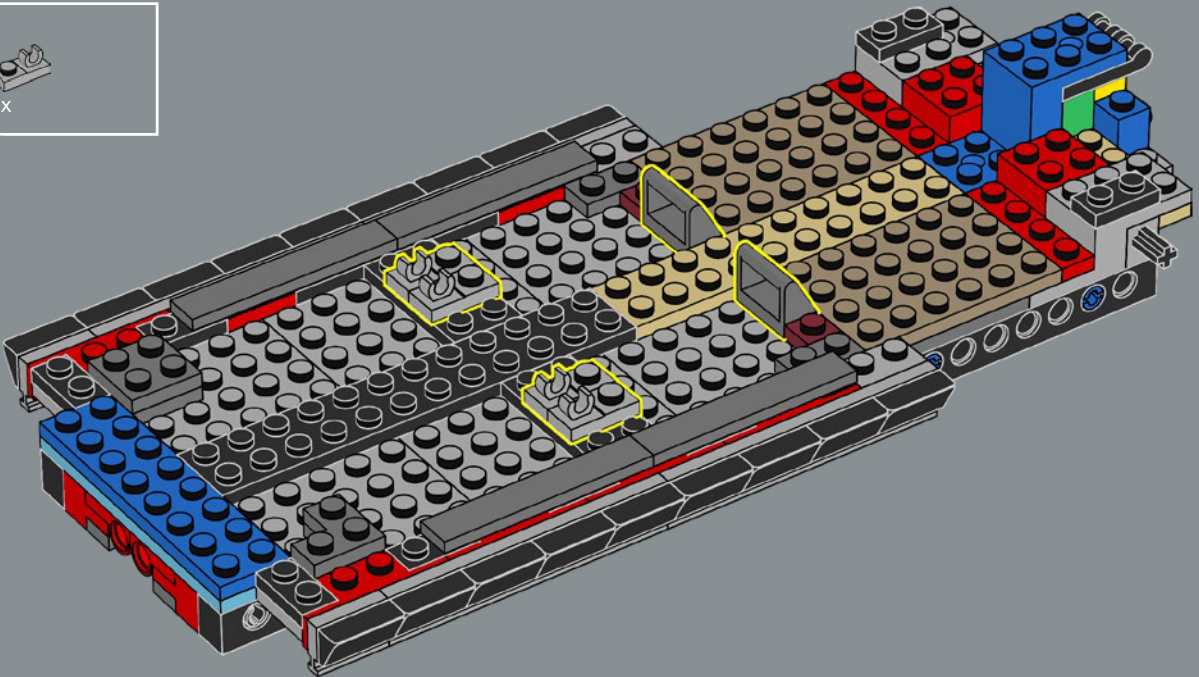



4x

25

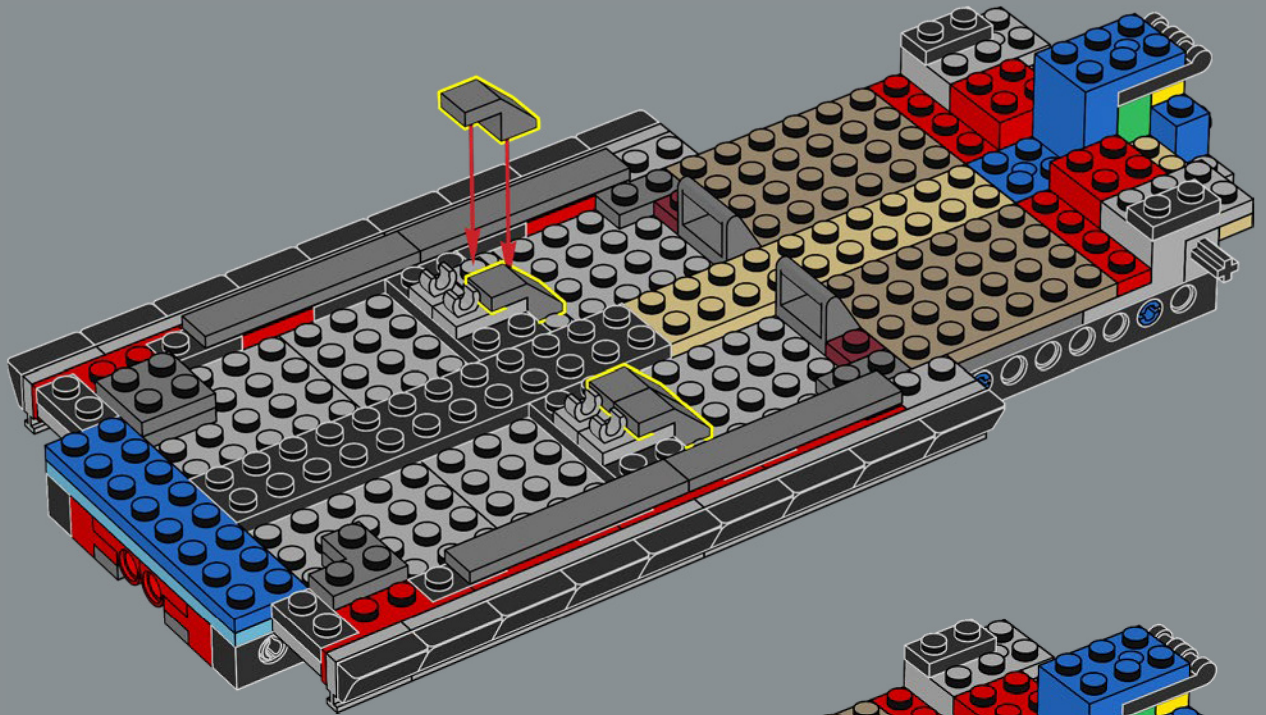

1x



1x



1x

26

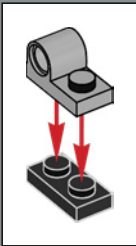
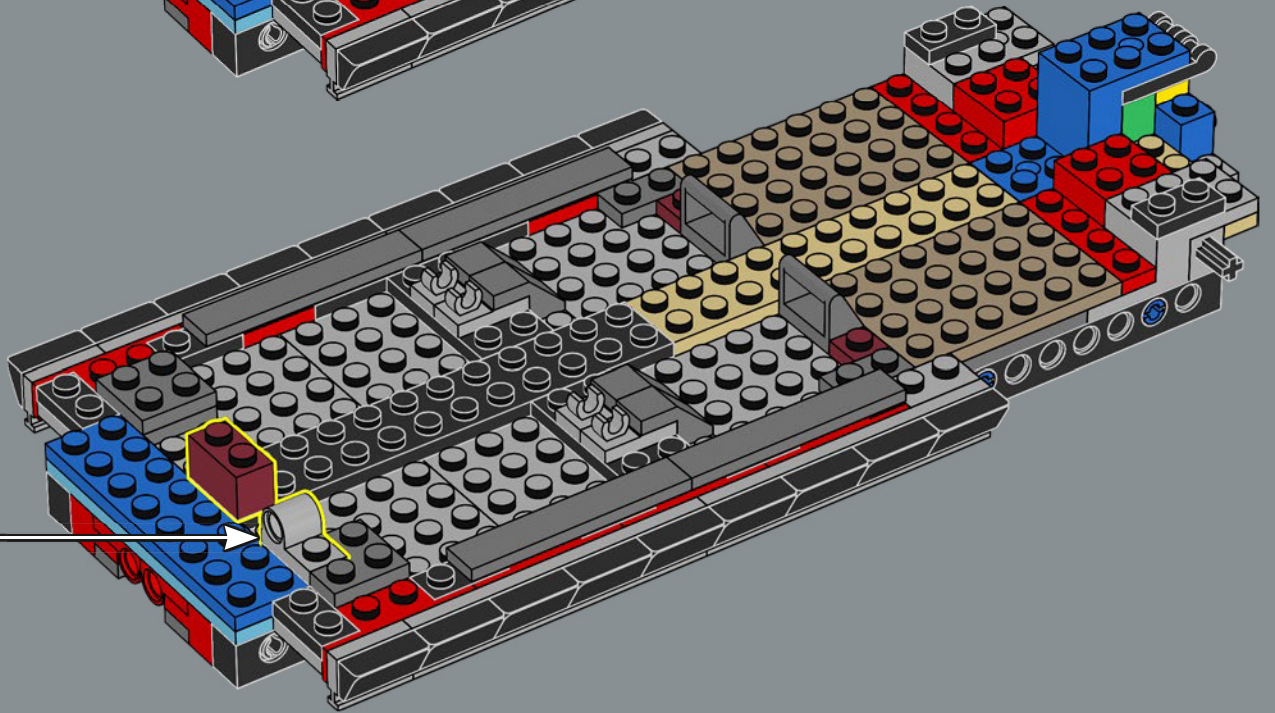

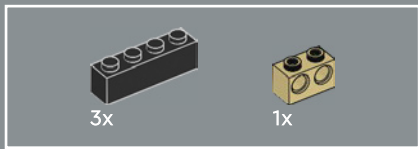

27

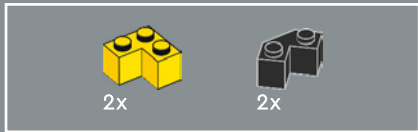
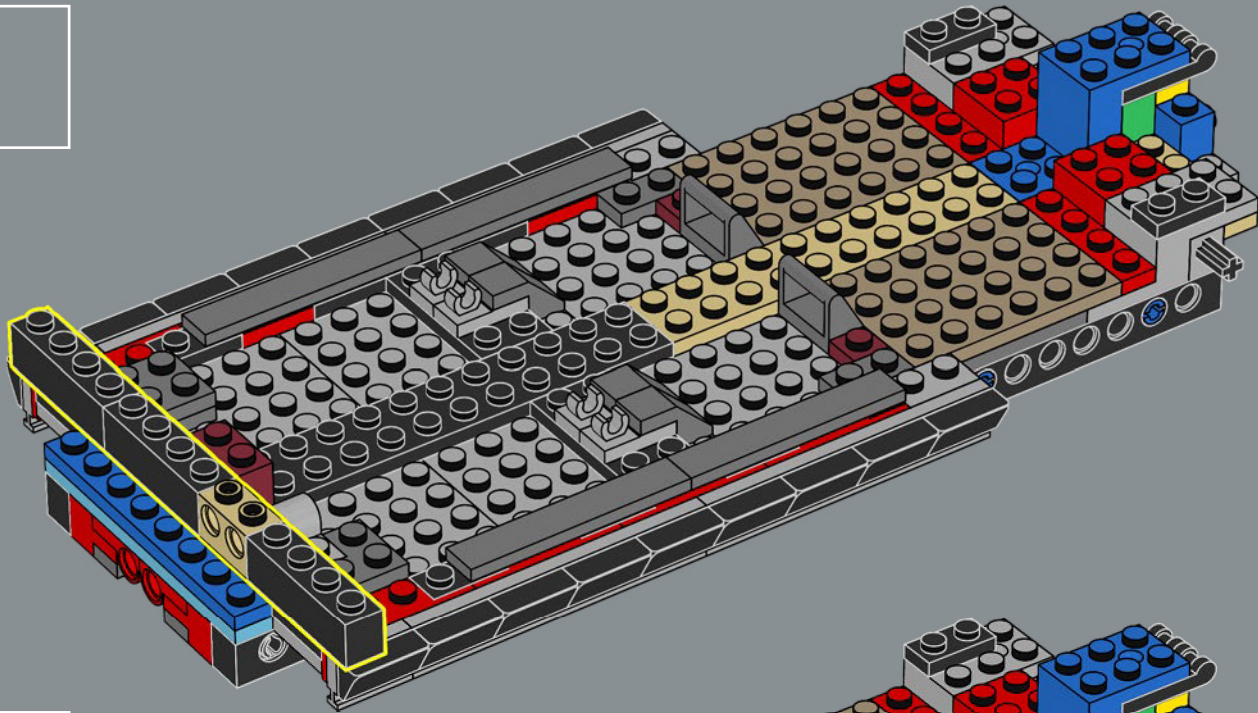

28

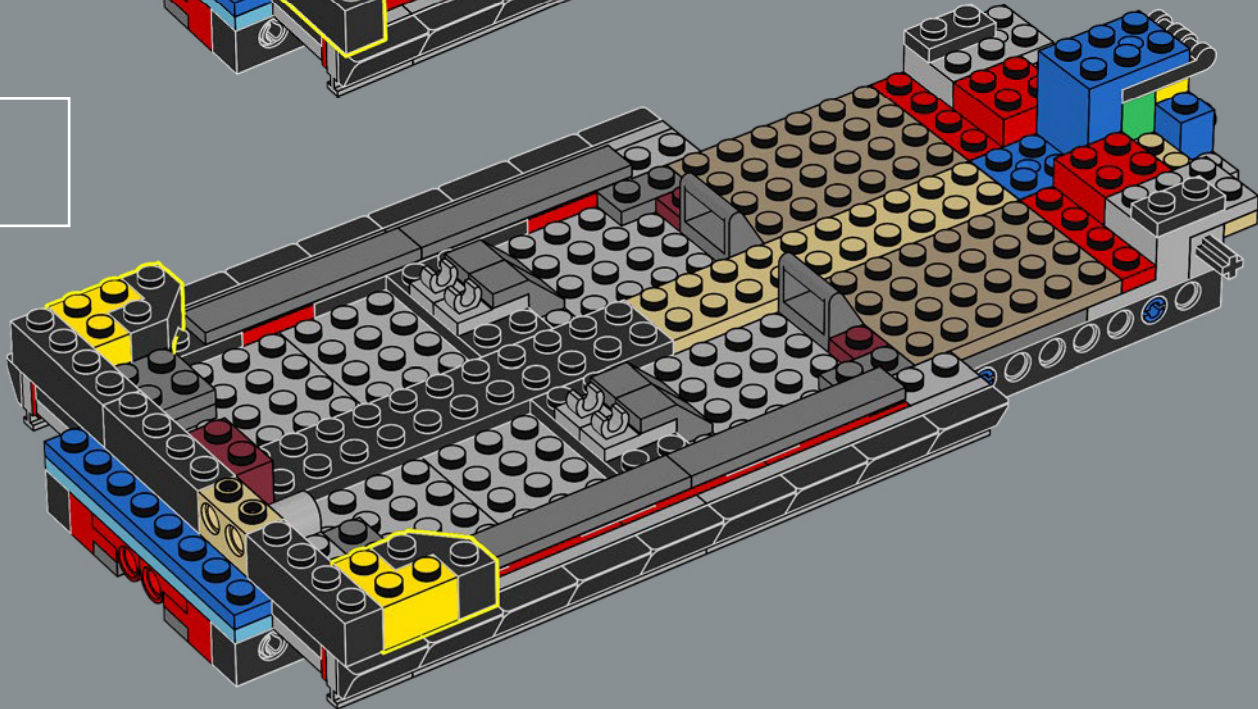



29

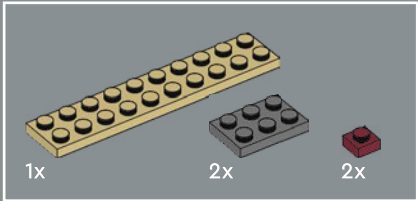
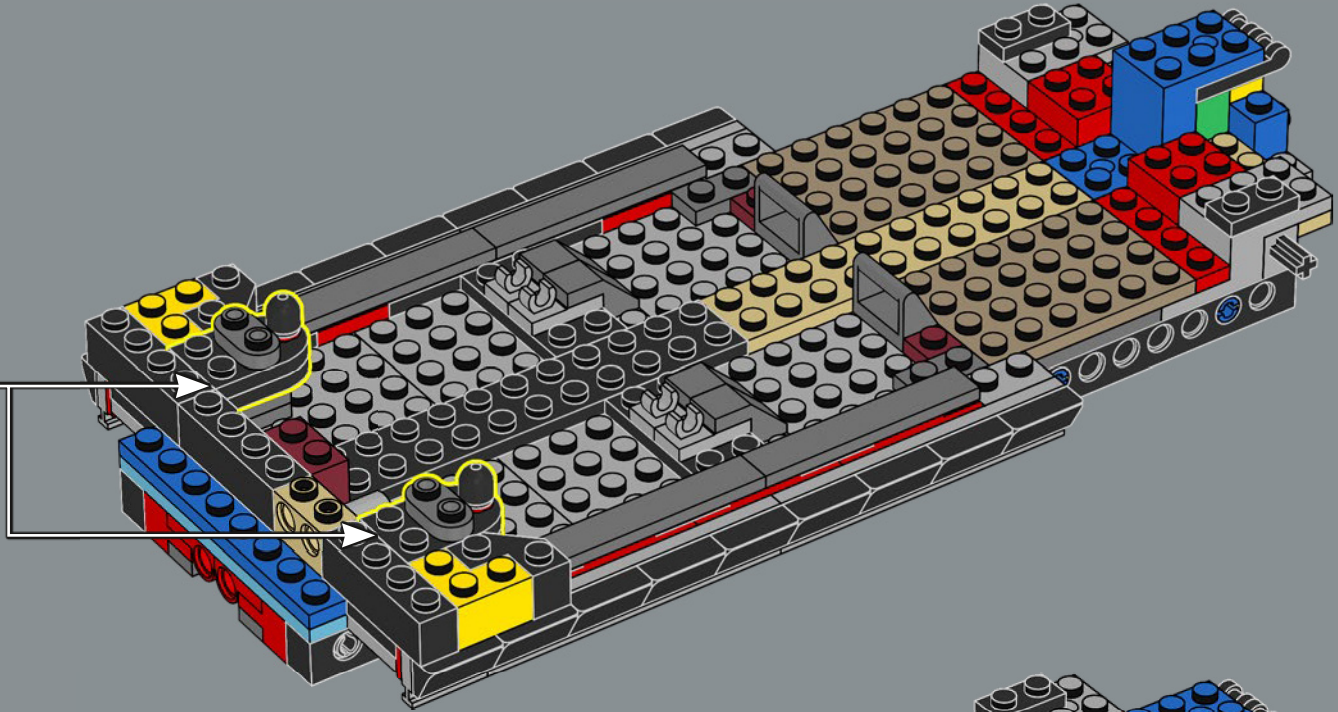
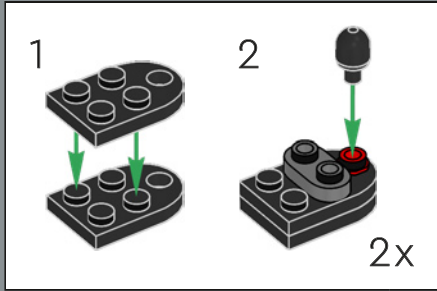

30

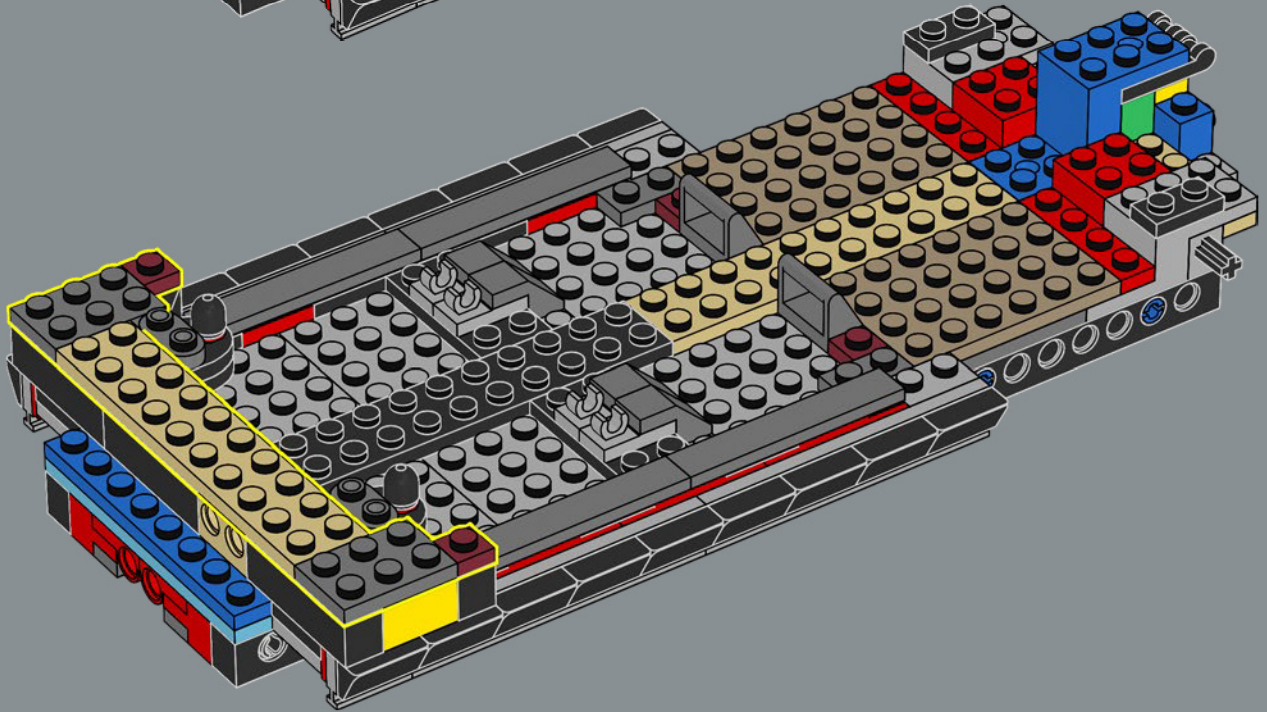

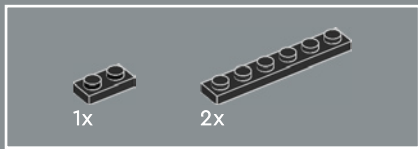

31

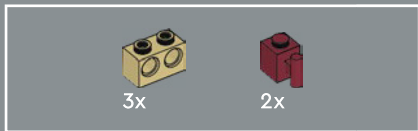
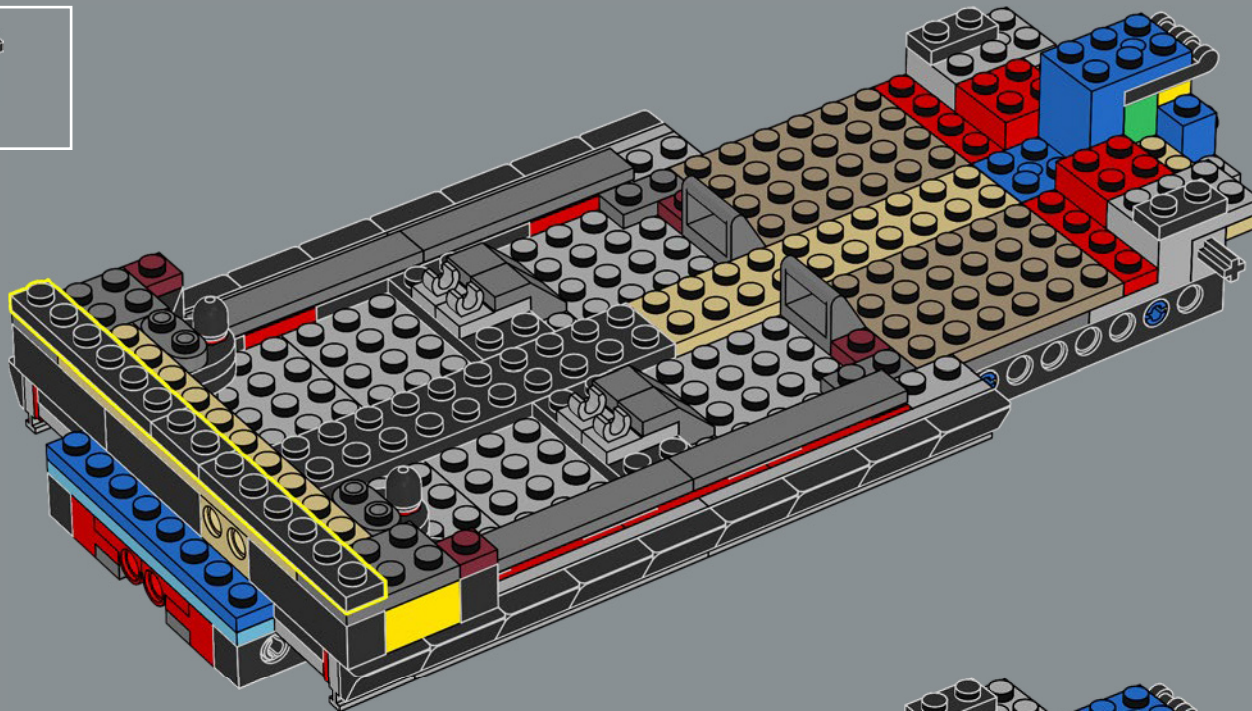

32

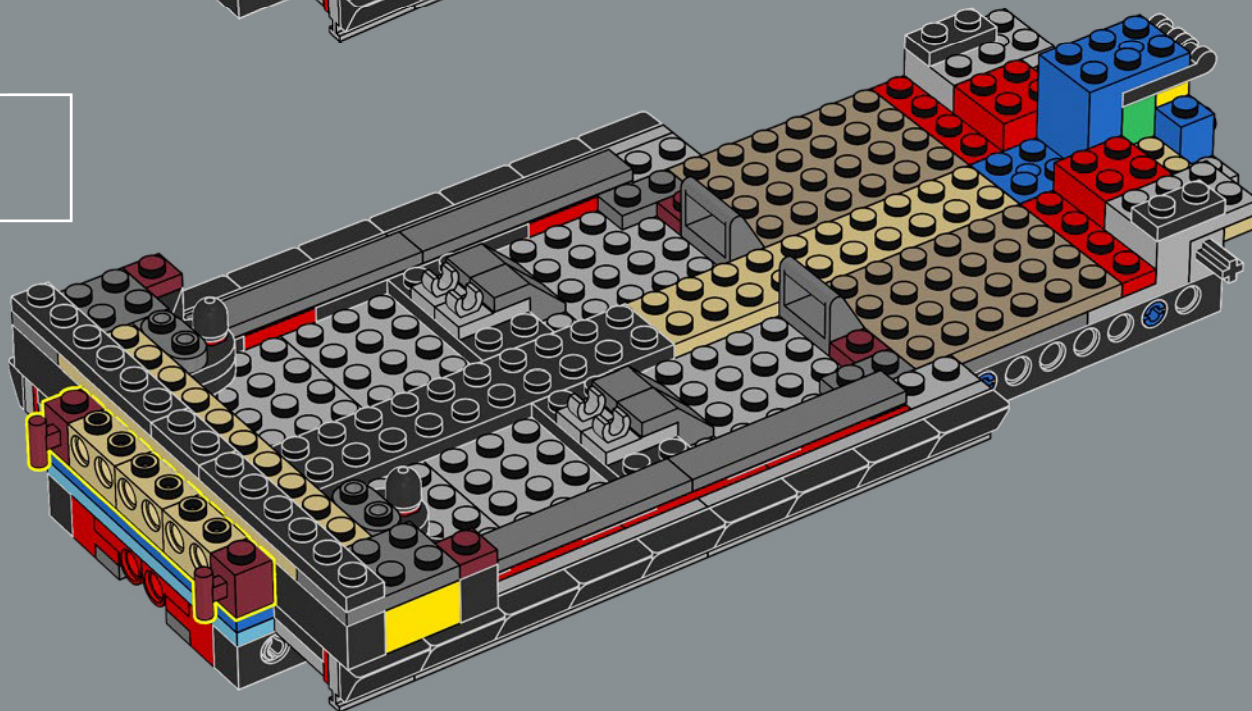

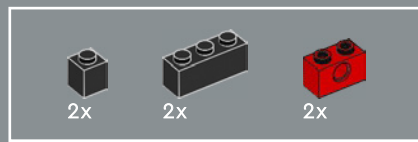

33

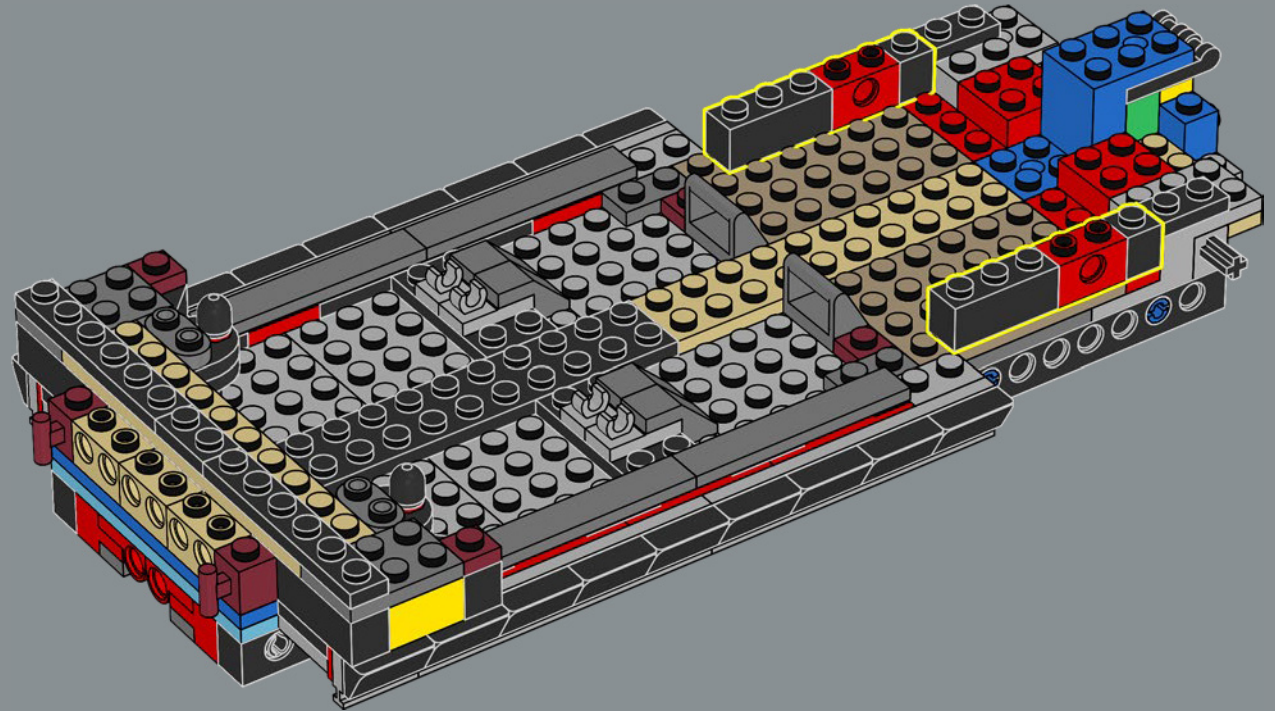

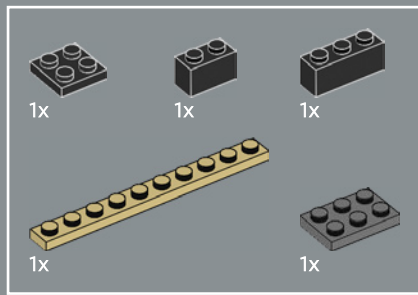

34

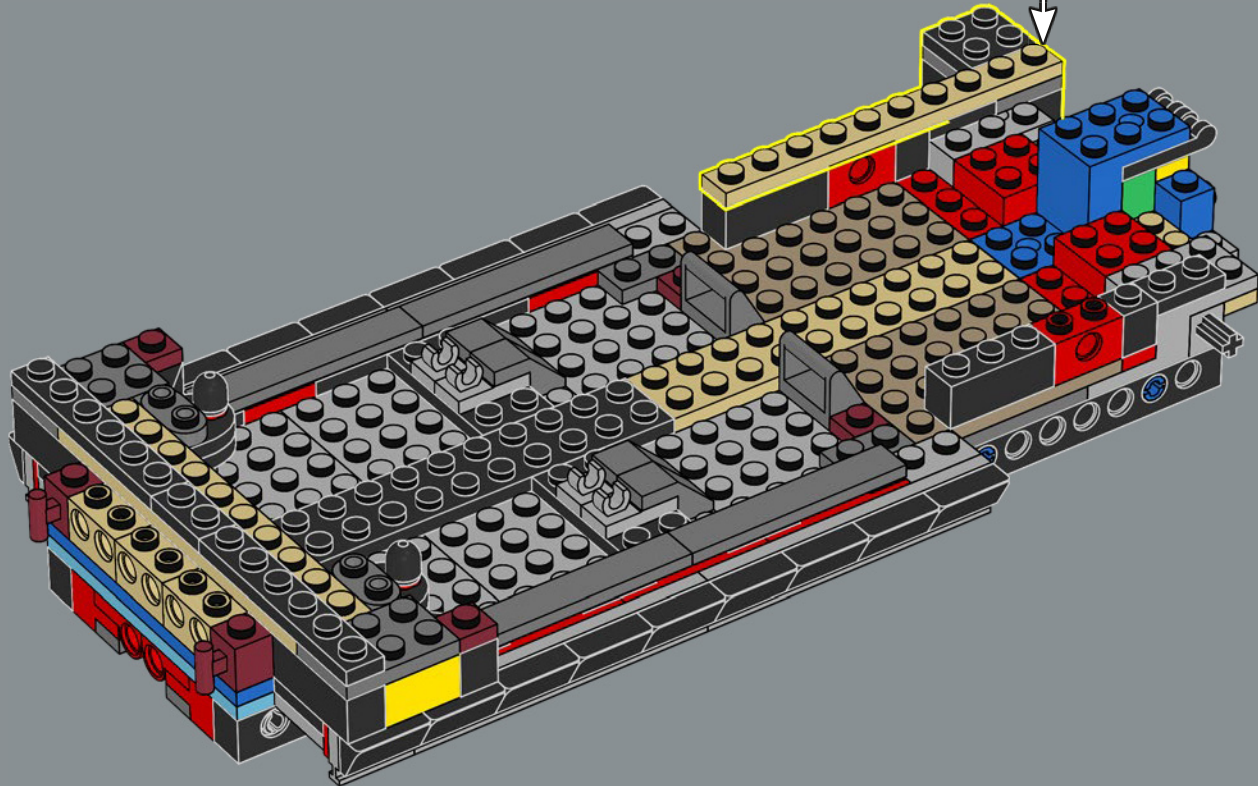
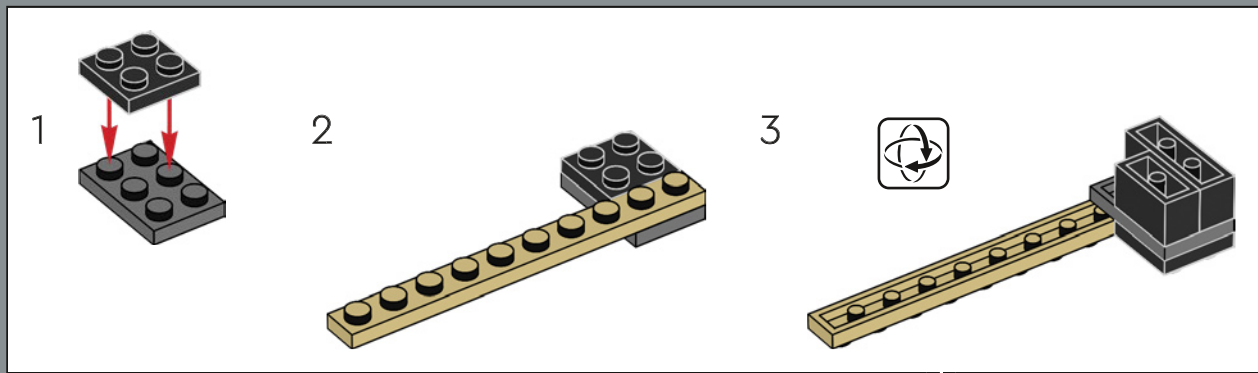

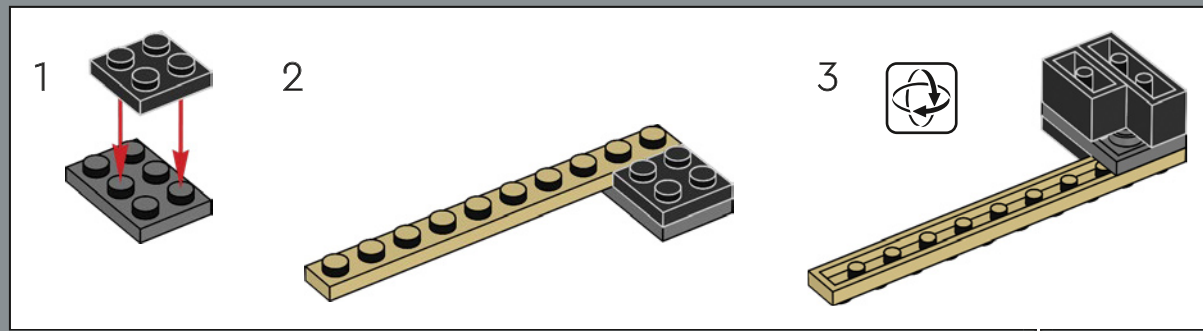
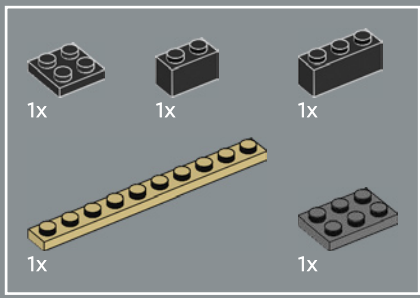

35

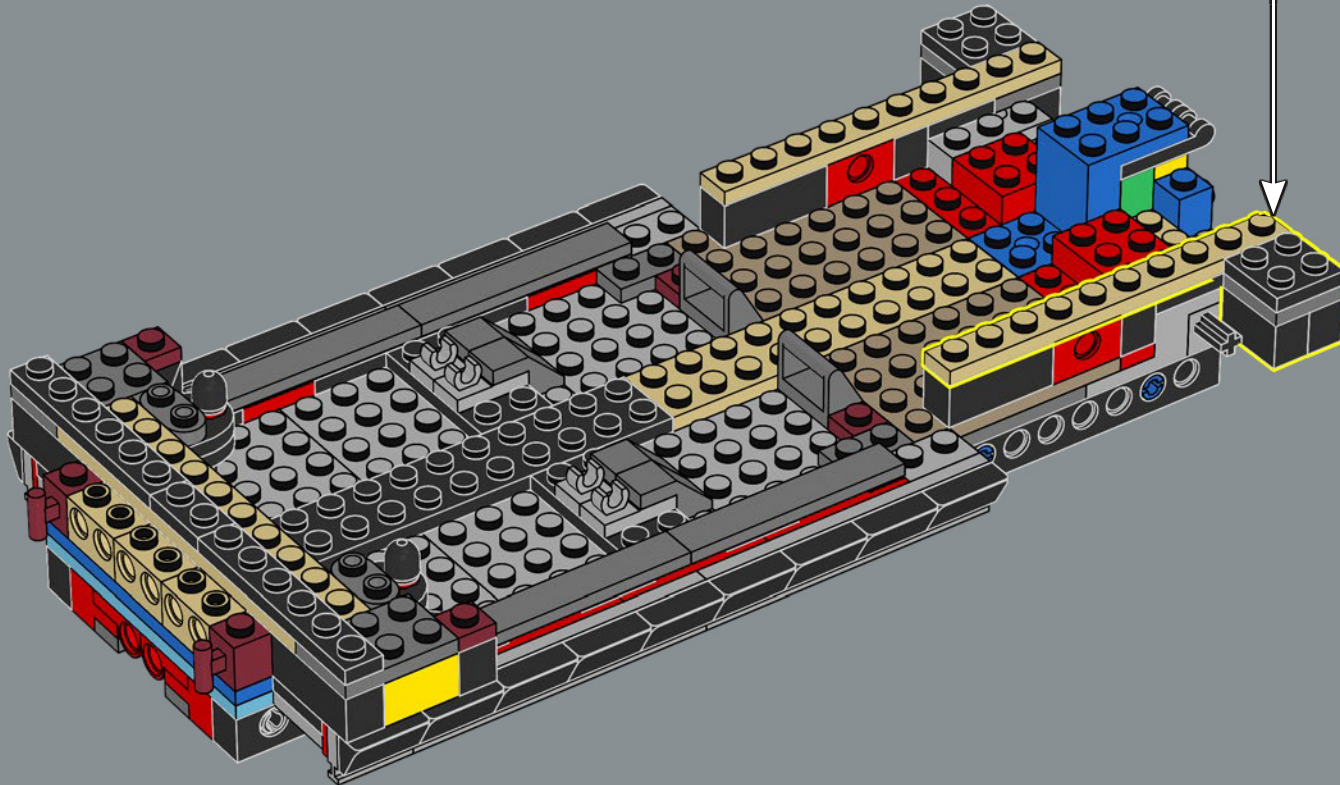

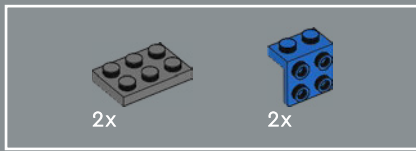

36

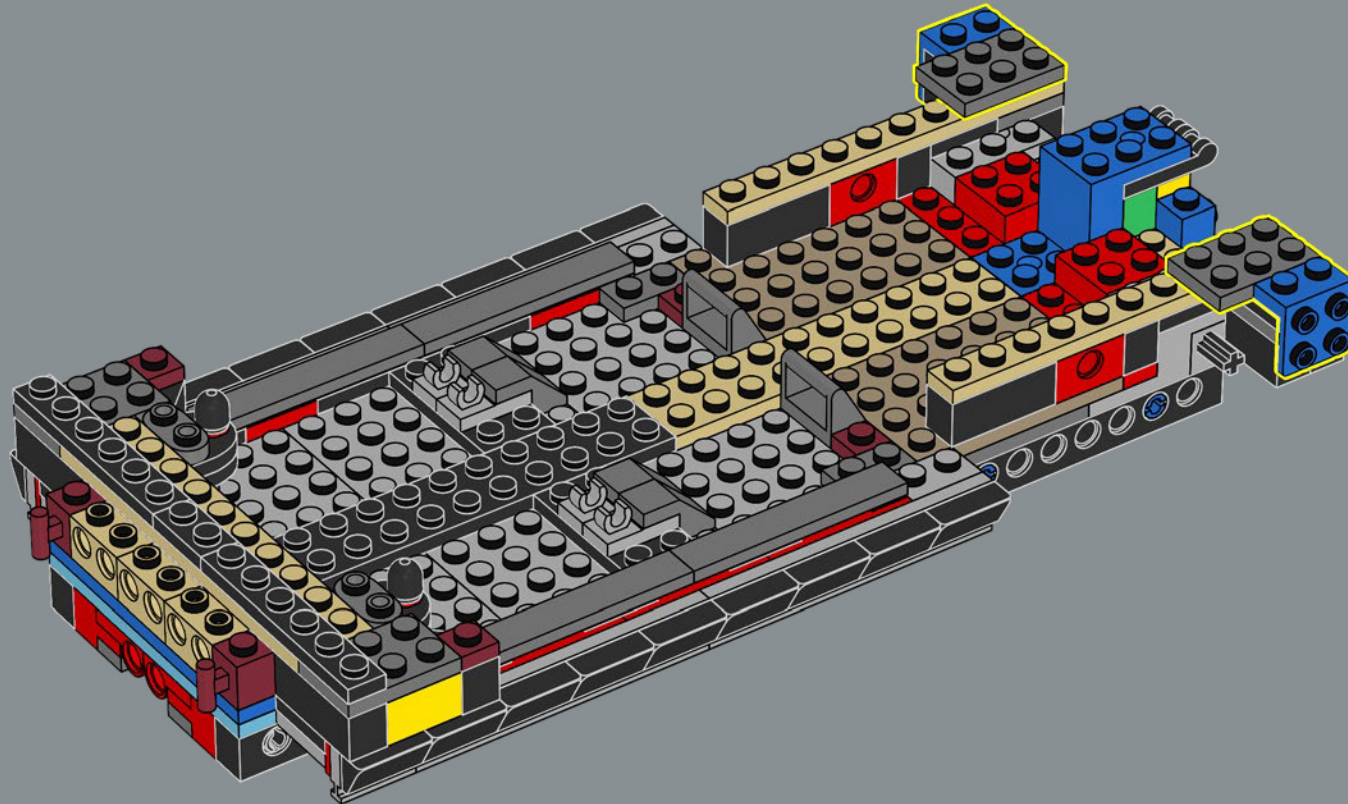

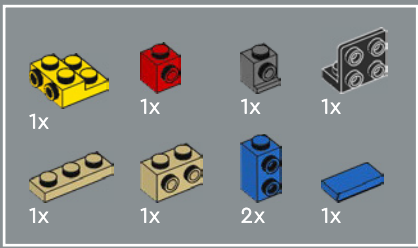

37

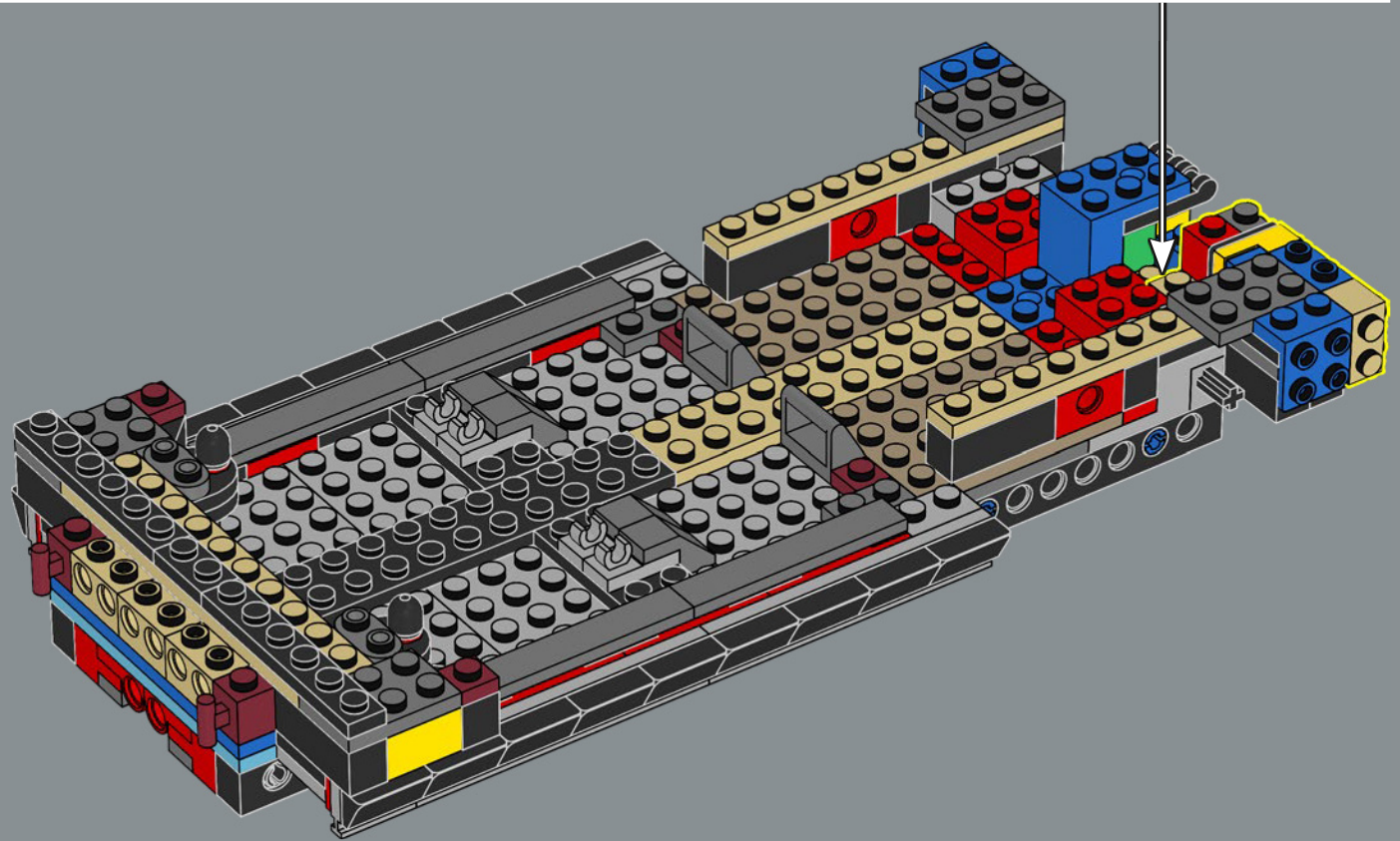
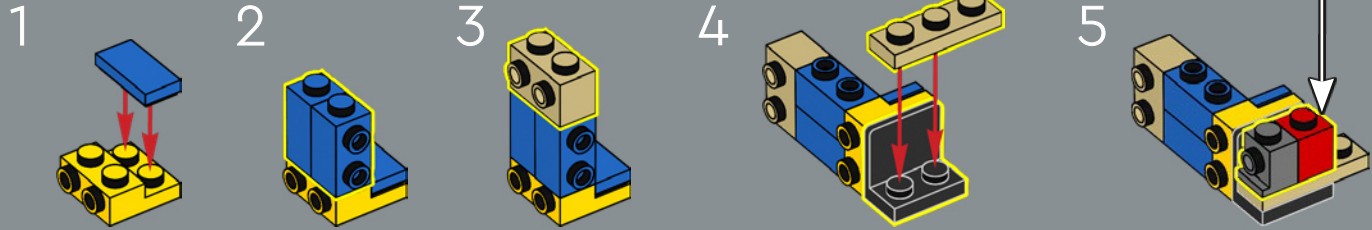

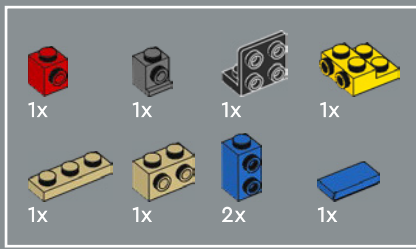

38

1

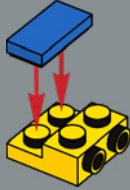

2

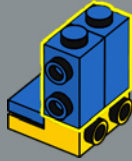

3

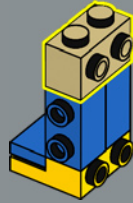

4

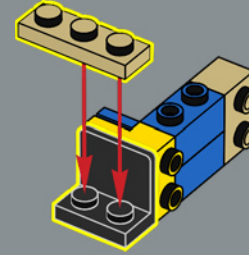

5

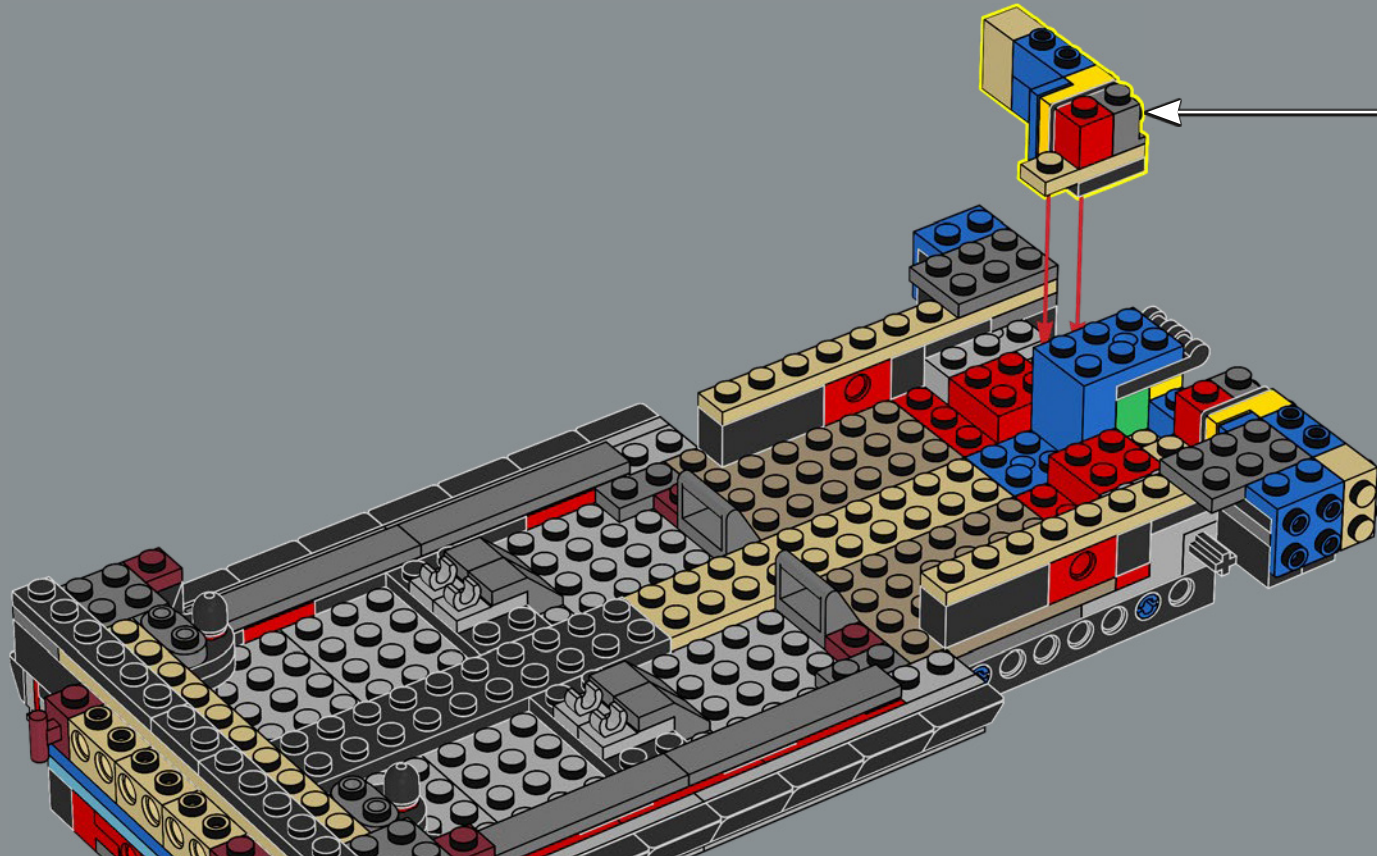
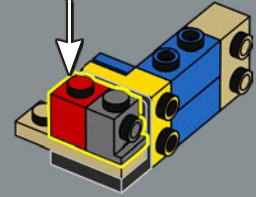
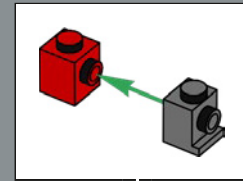

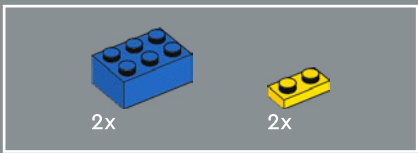

39

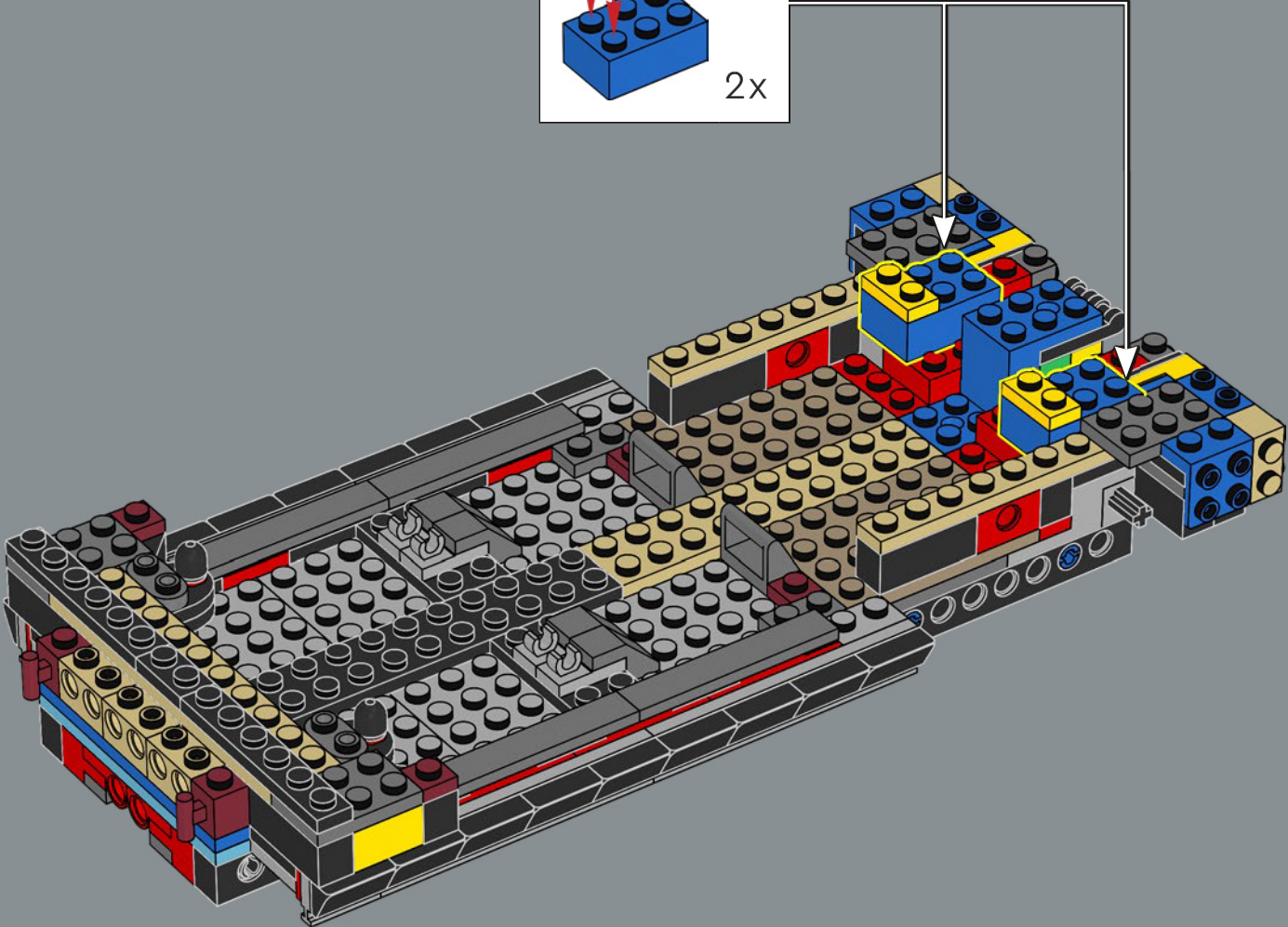
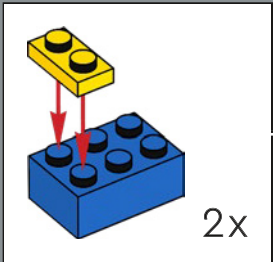

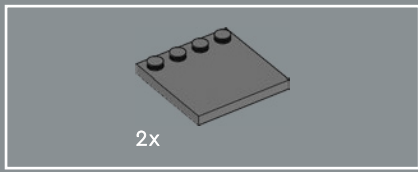

40

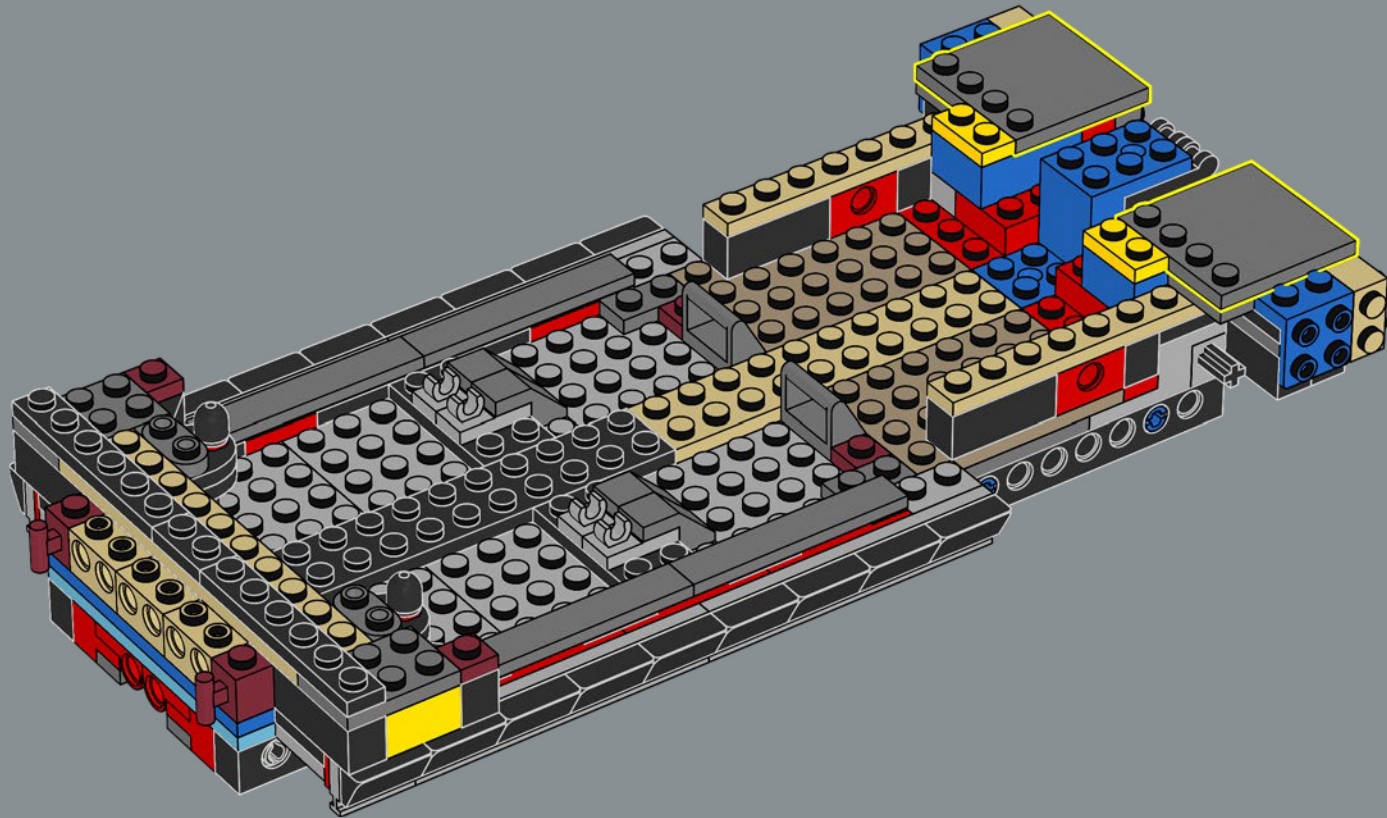



41

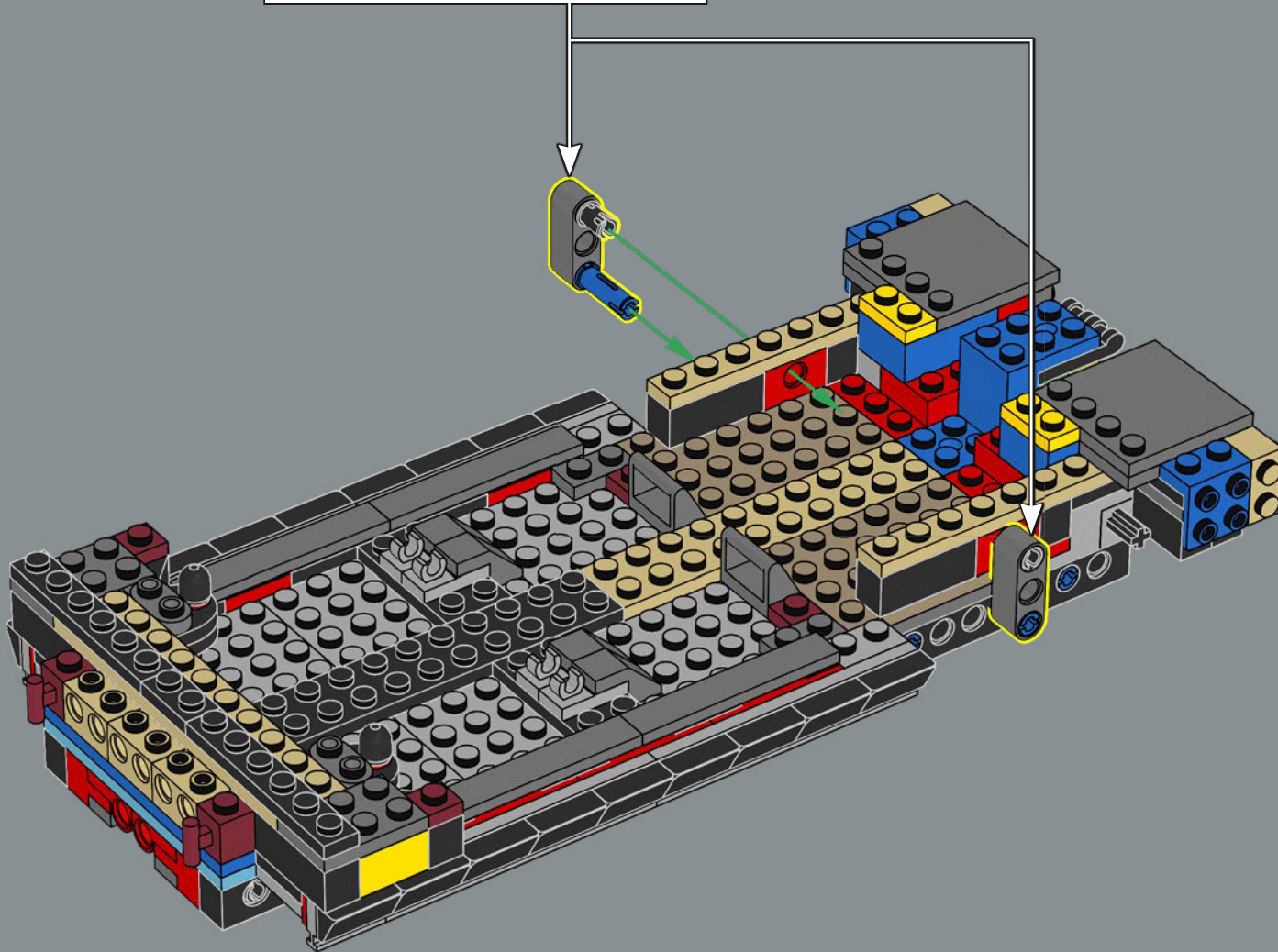
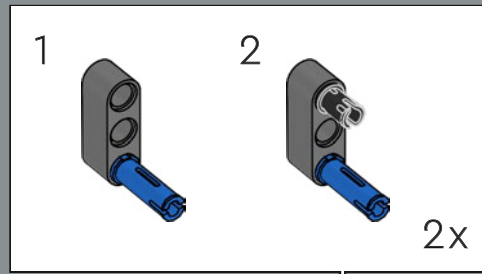

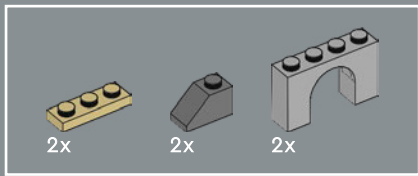

42

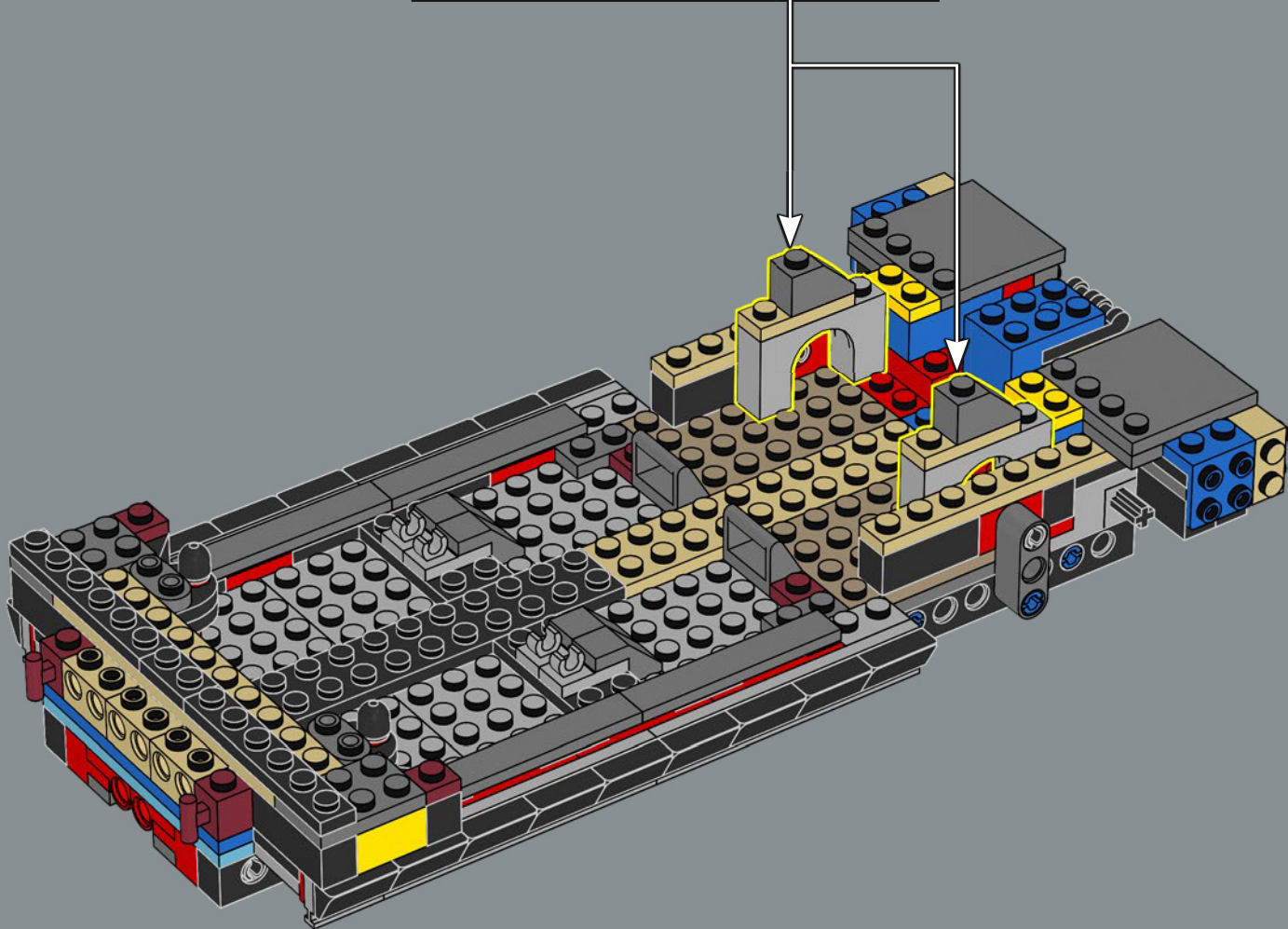
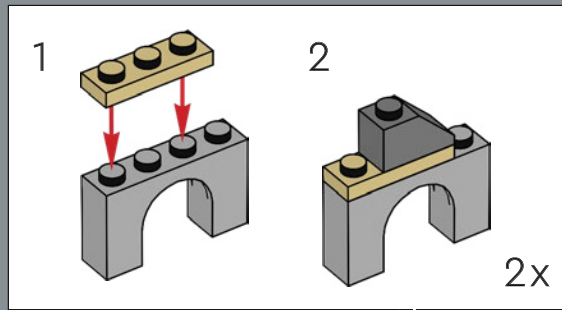

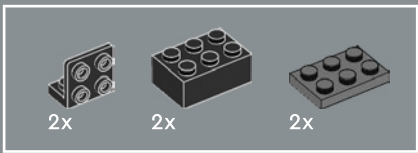

43

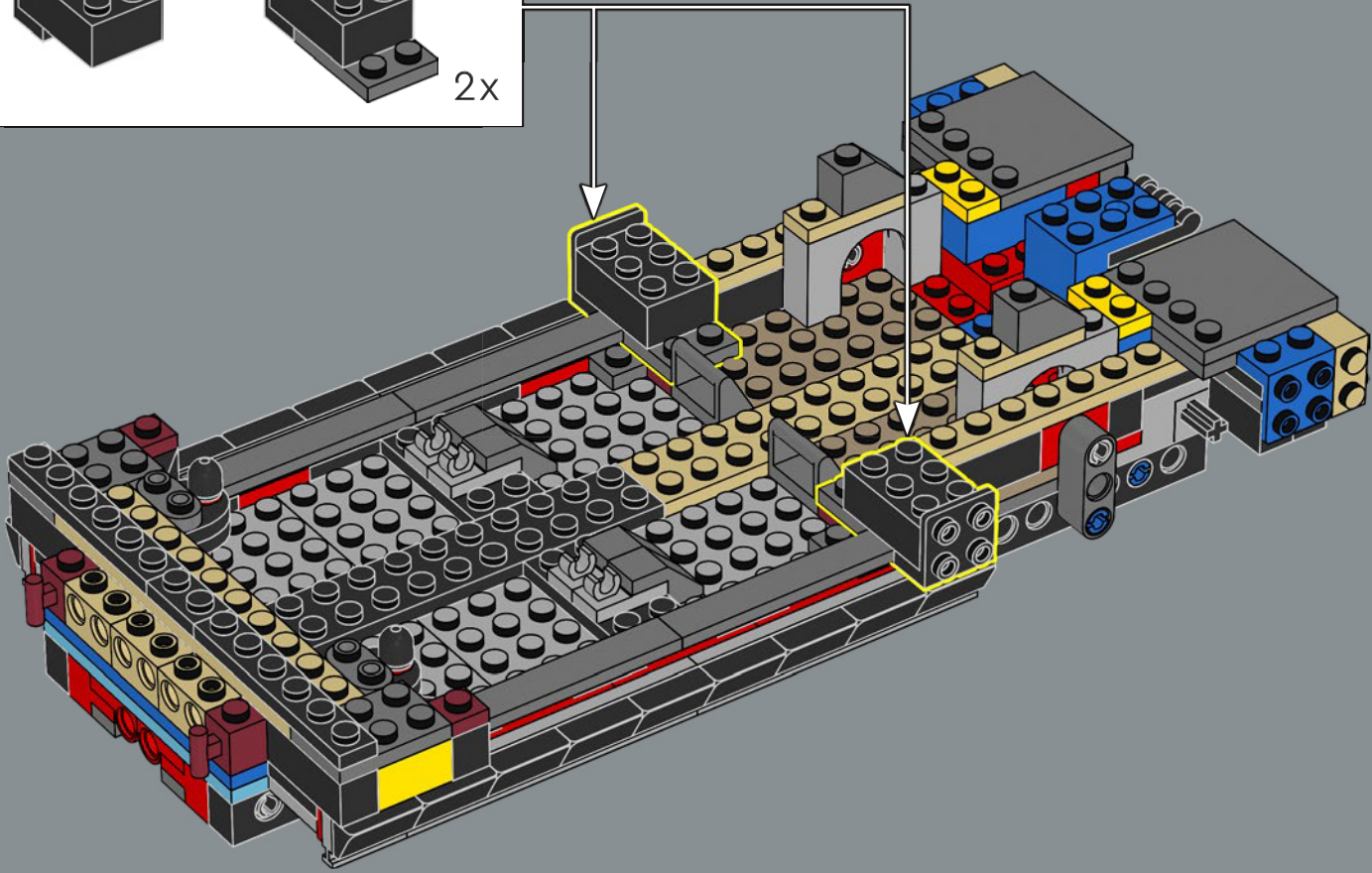
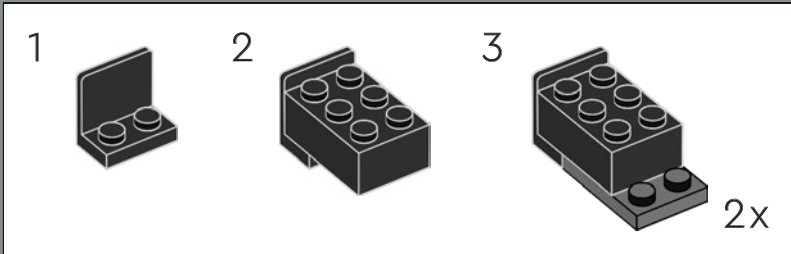

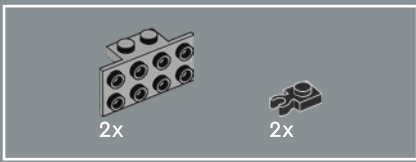

44

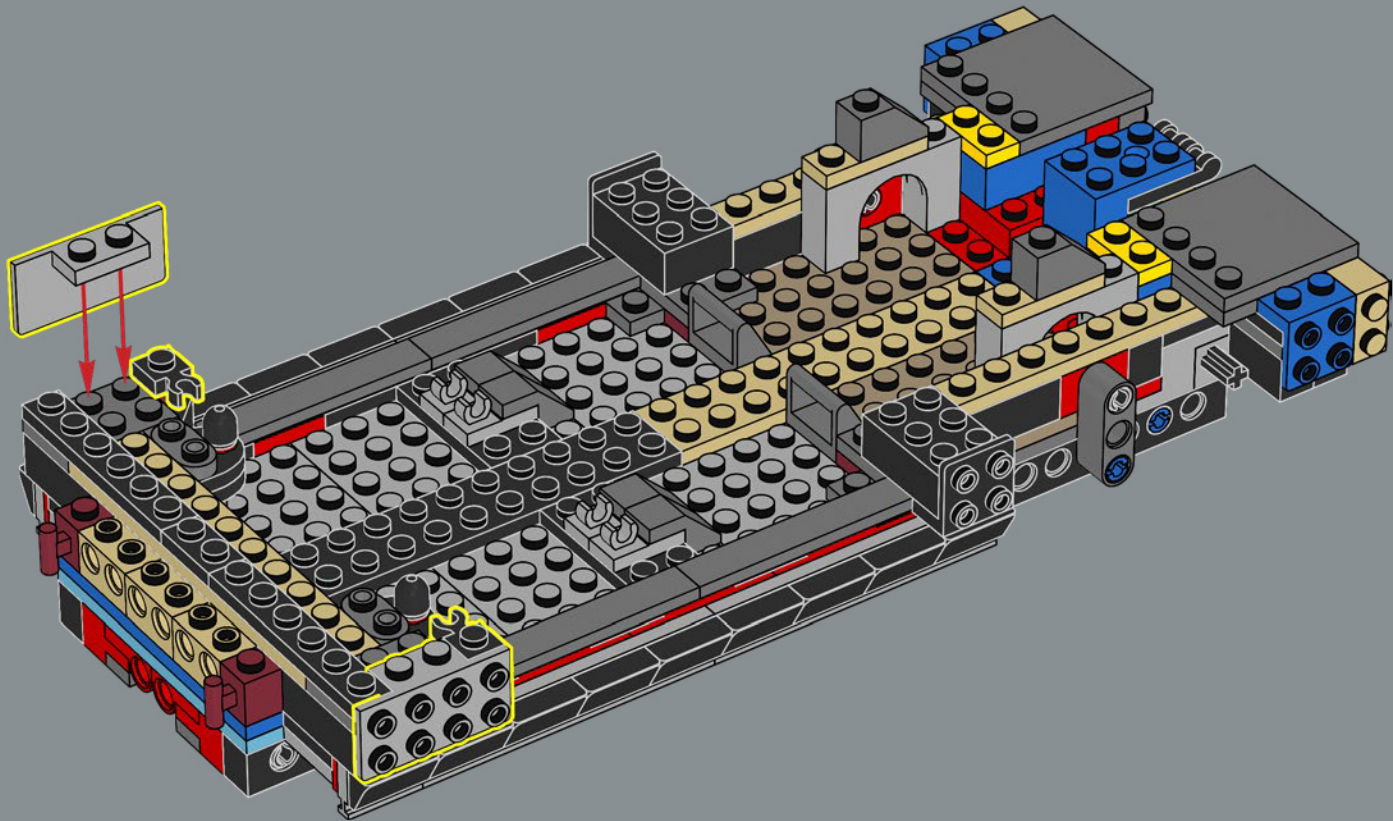

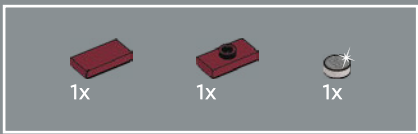

45

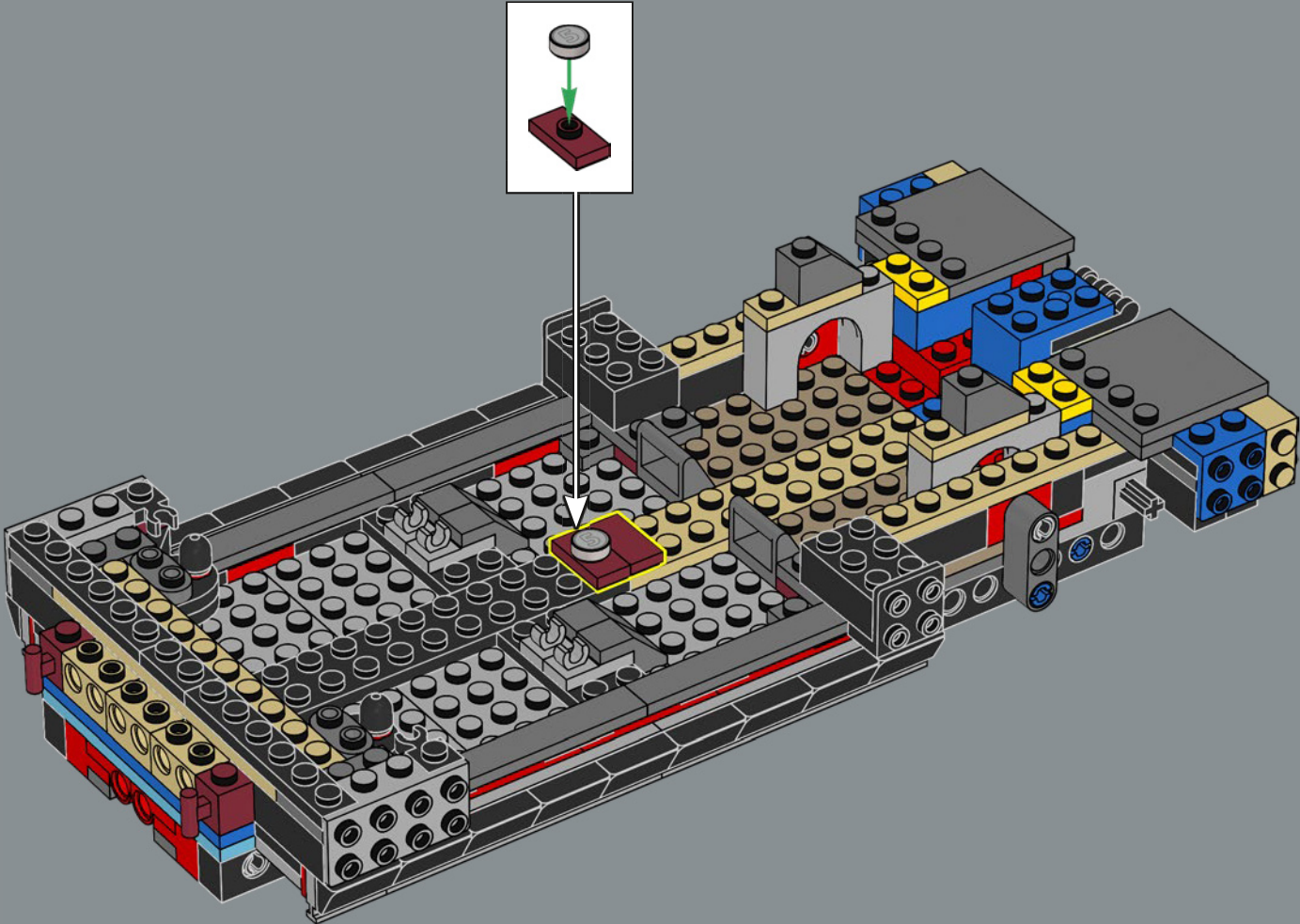

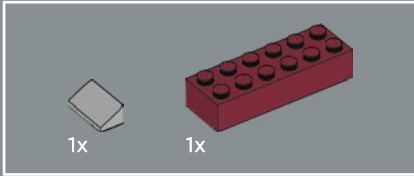
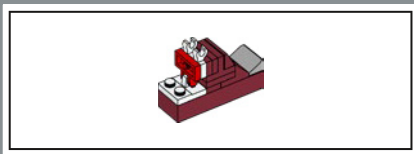

46

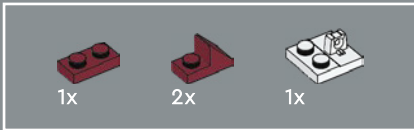
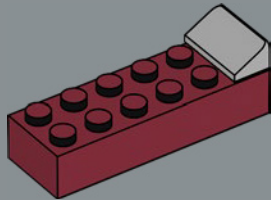

47

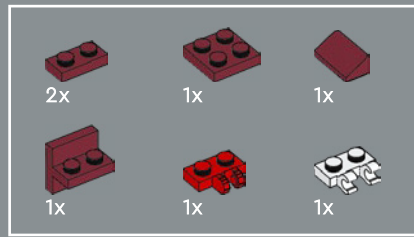
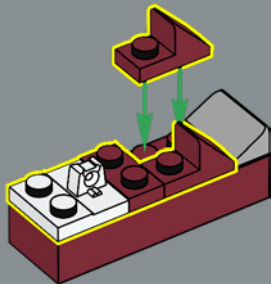

48

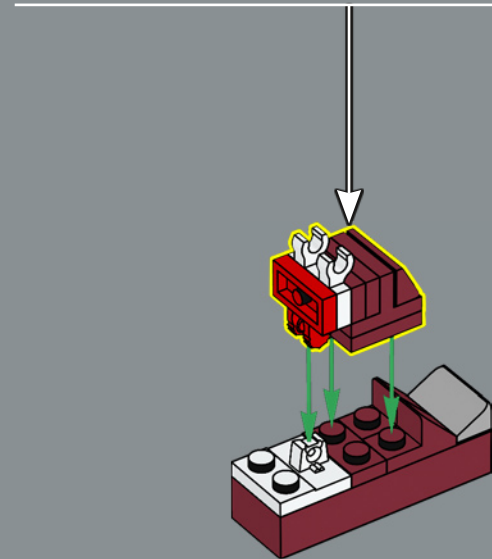
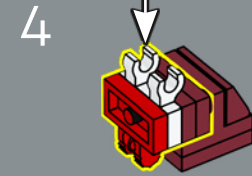
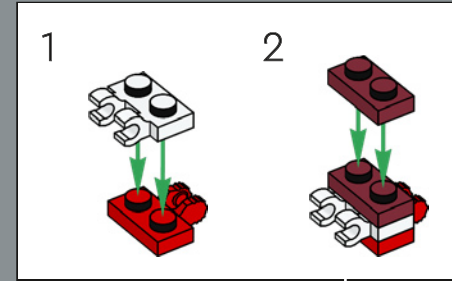
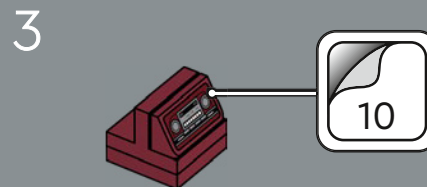
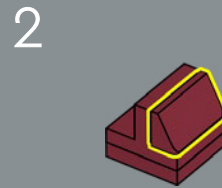
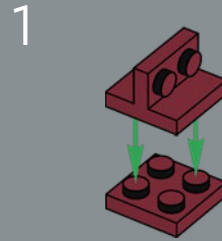

Der erste jemals gebaute Prototyp des Camaro mit der Fahrgestellnummer 10001 existiert noch immer und ist im National Historic Vehicle Register eingetragen.

49

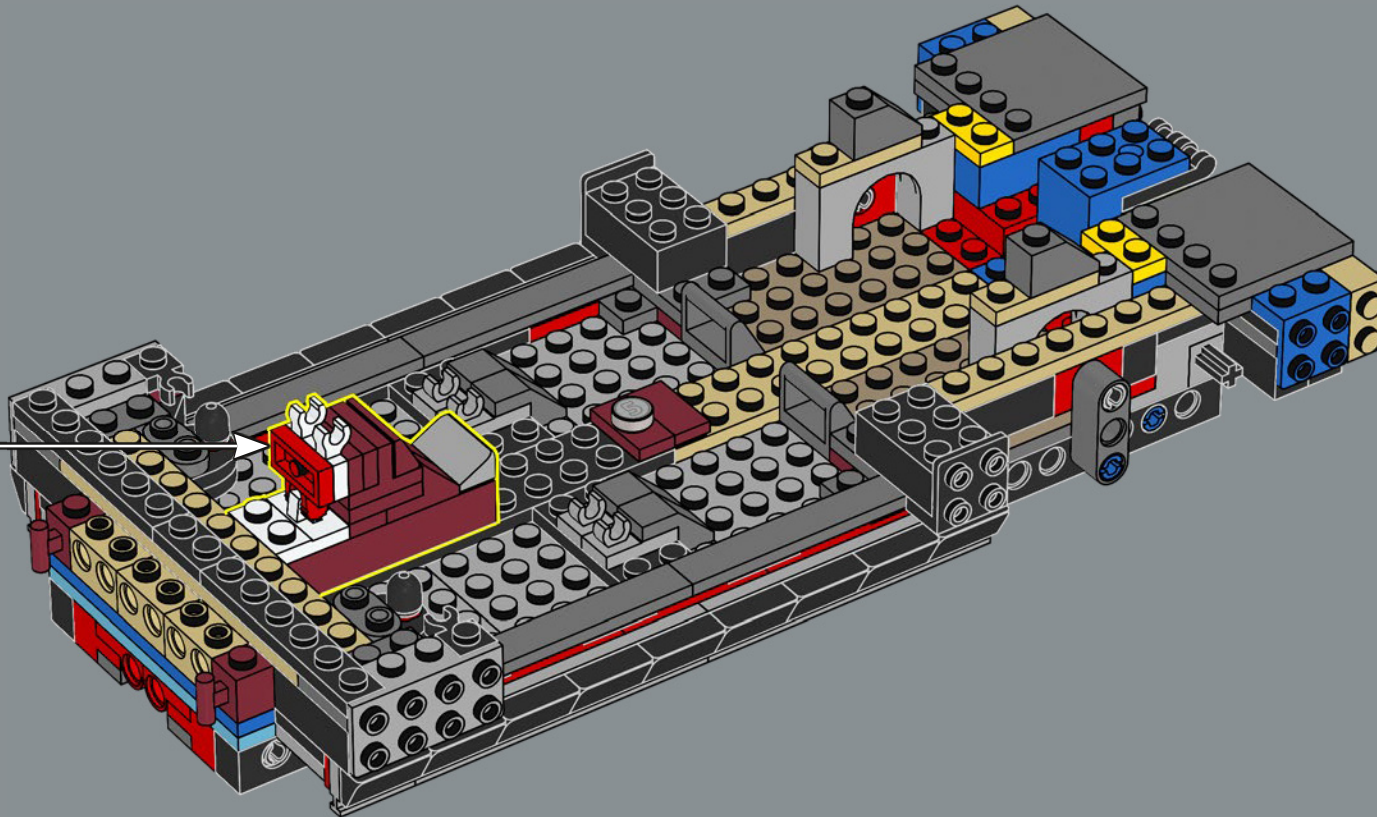

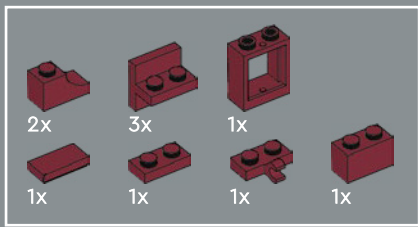

50

1

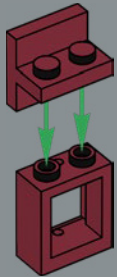

2

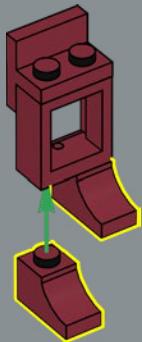

3

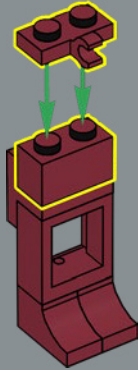

4

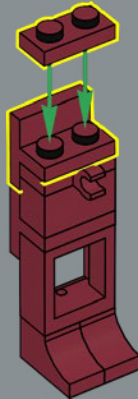

5

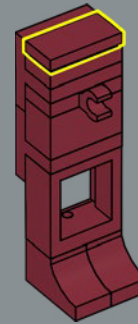

6

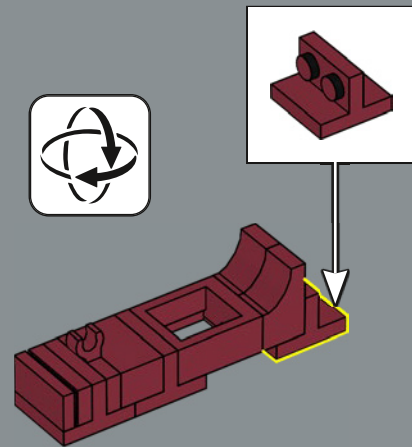

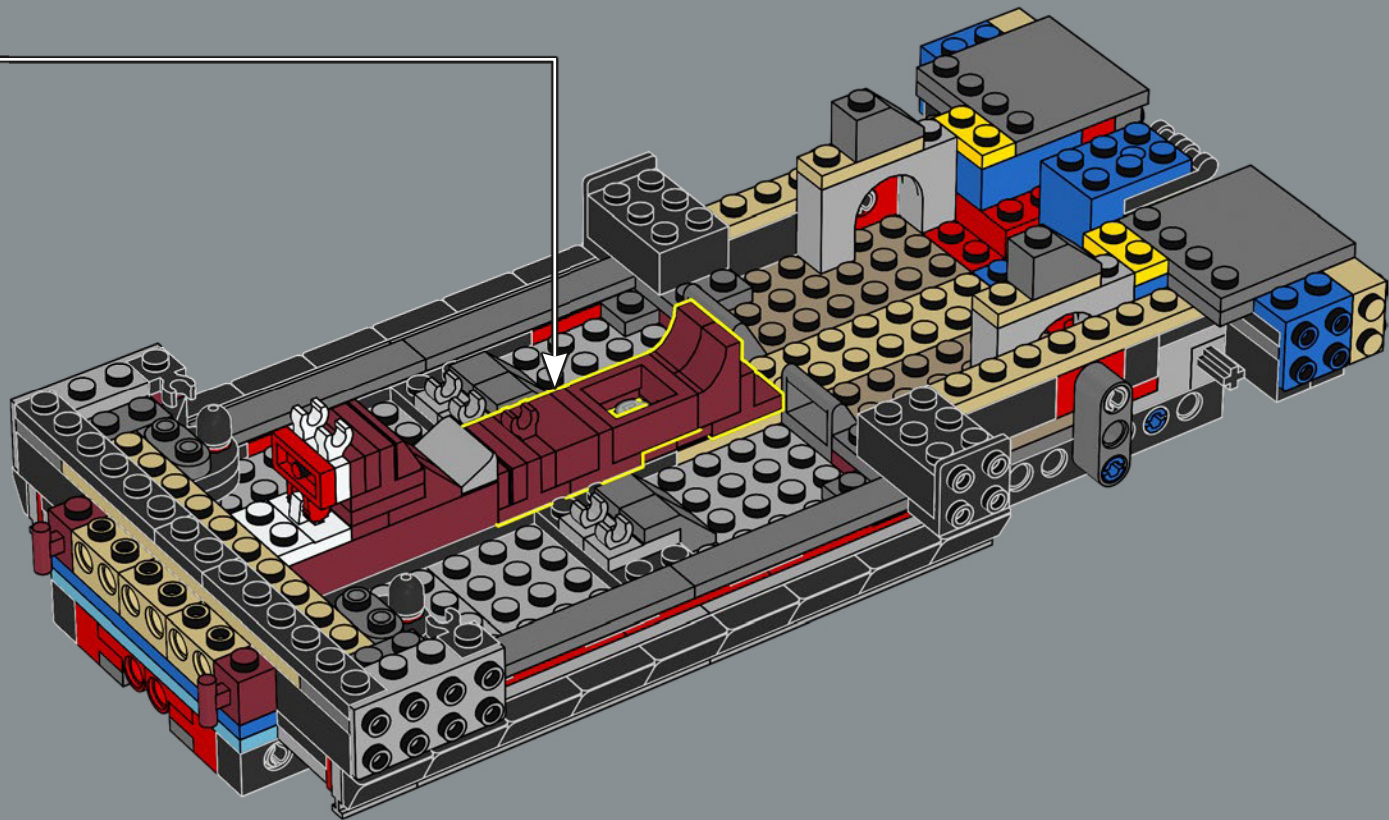

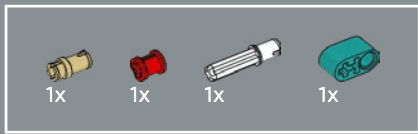

51

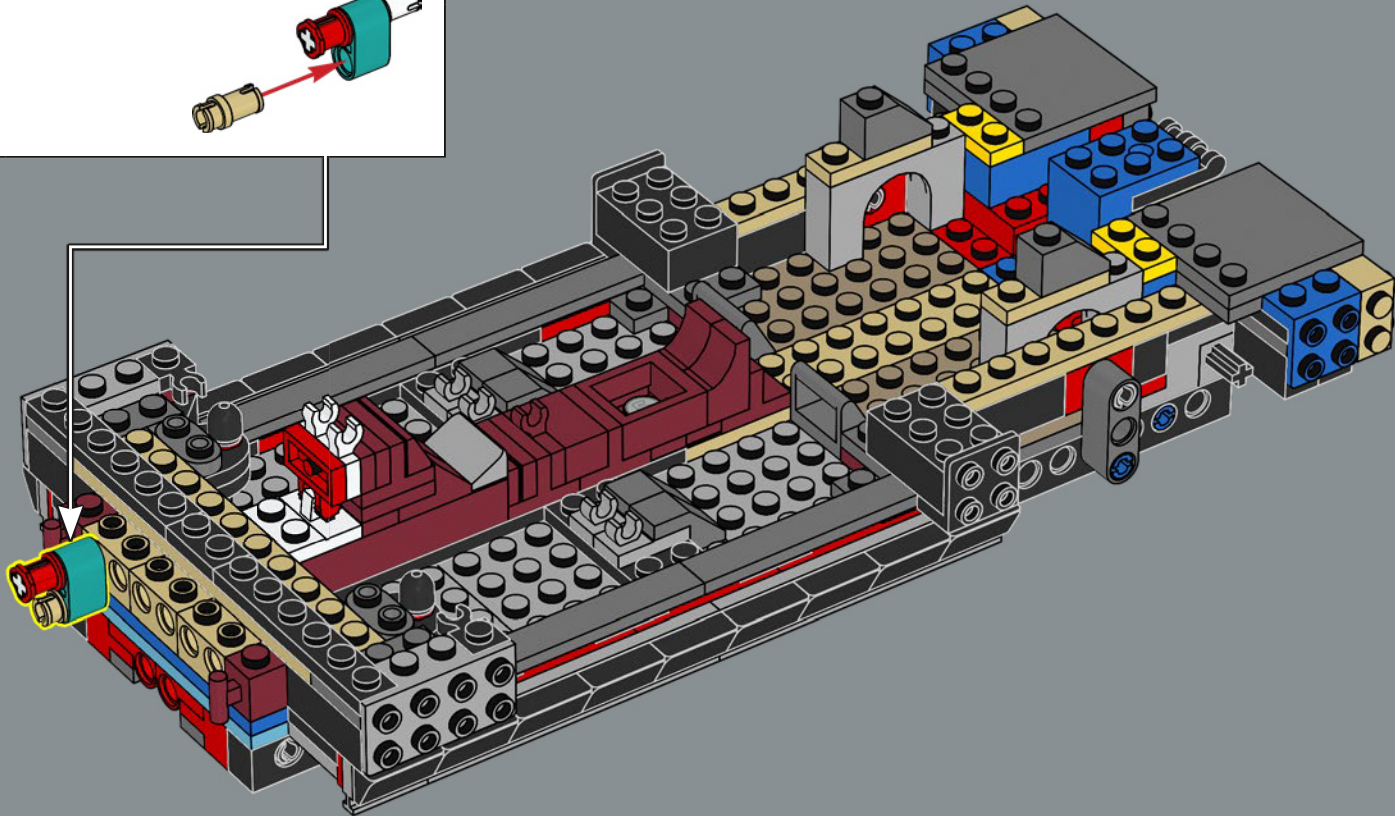
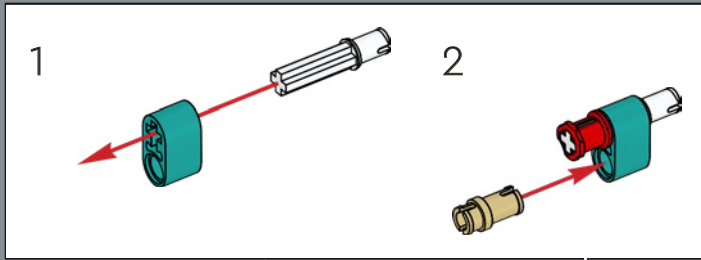

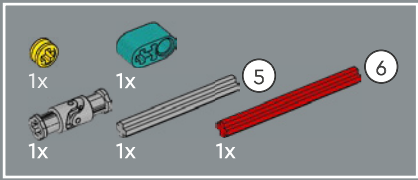

52

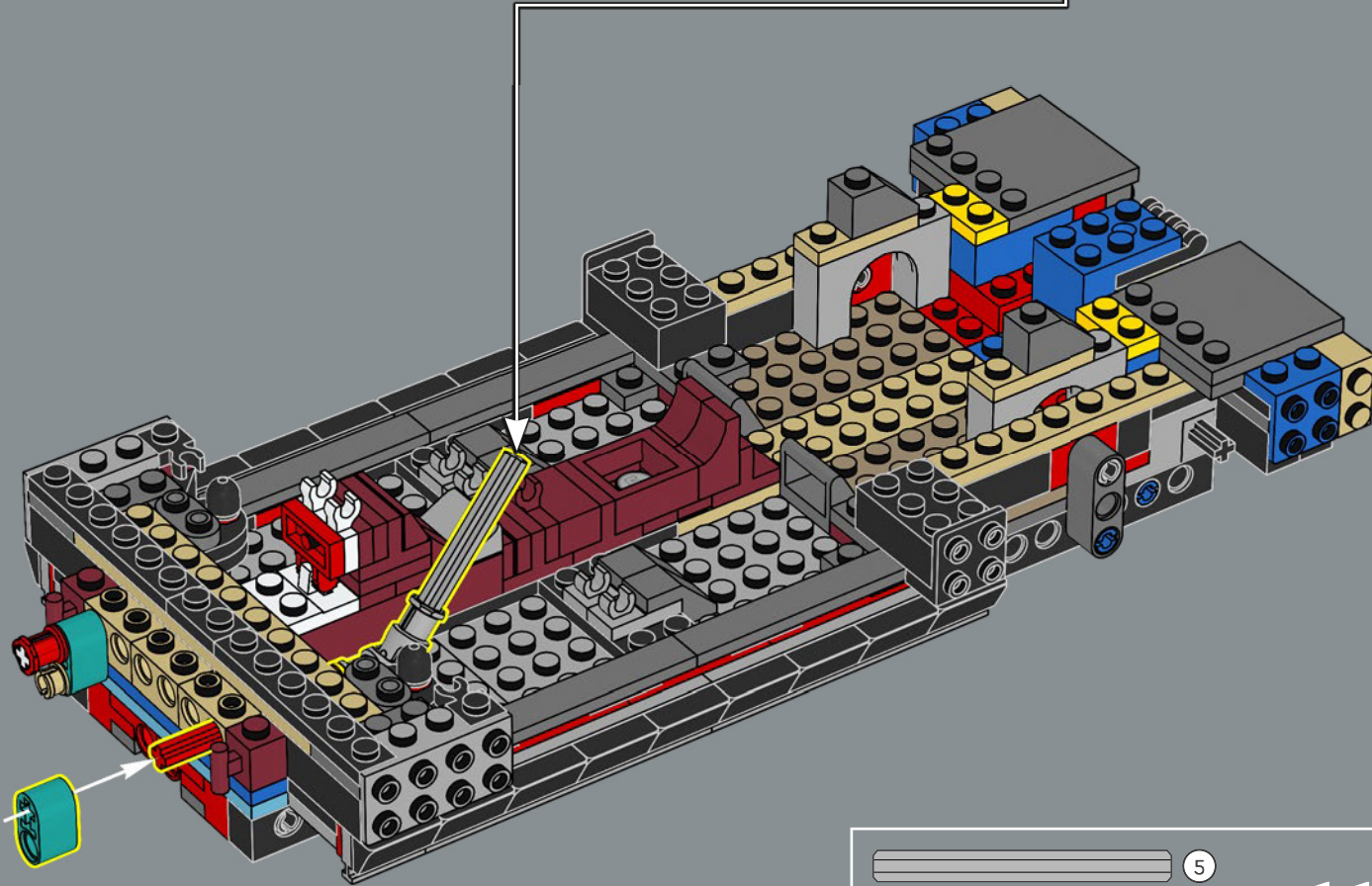
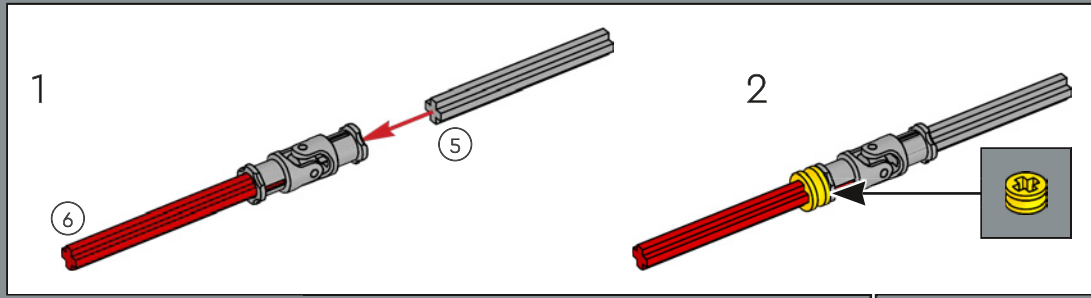



53

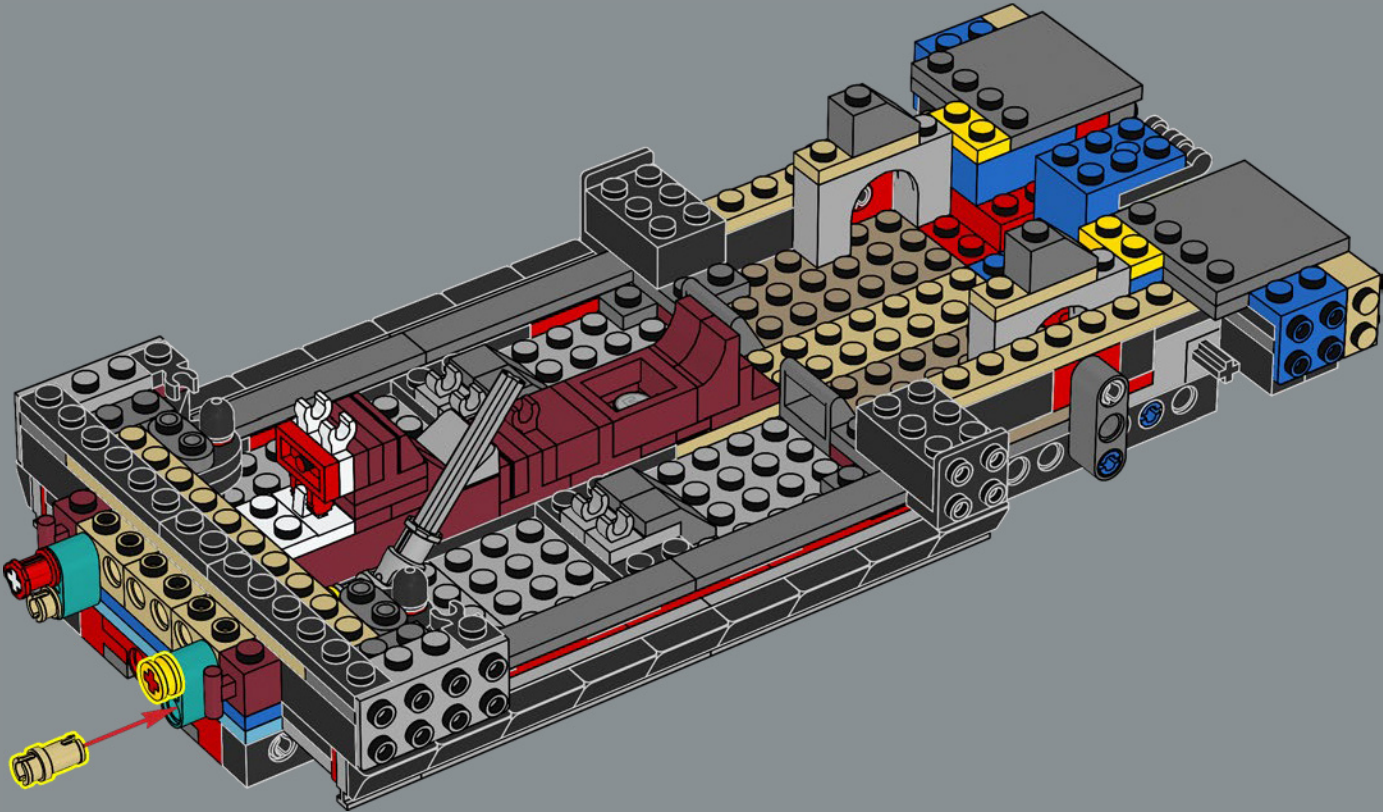

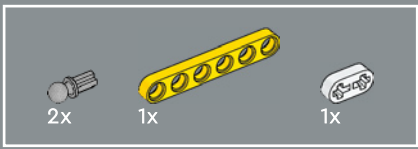

54

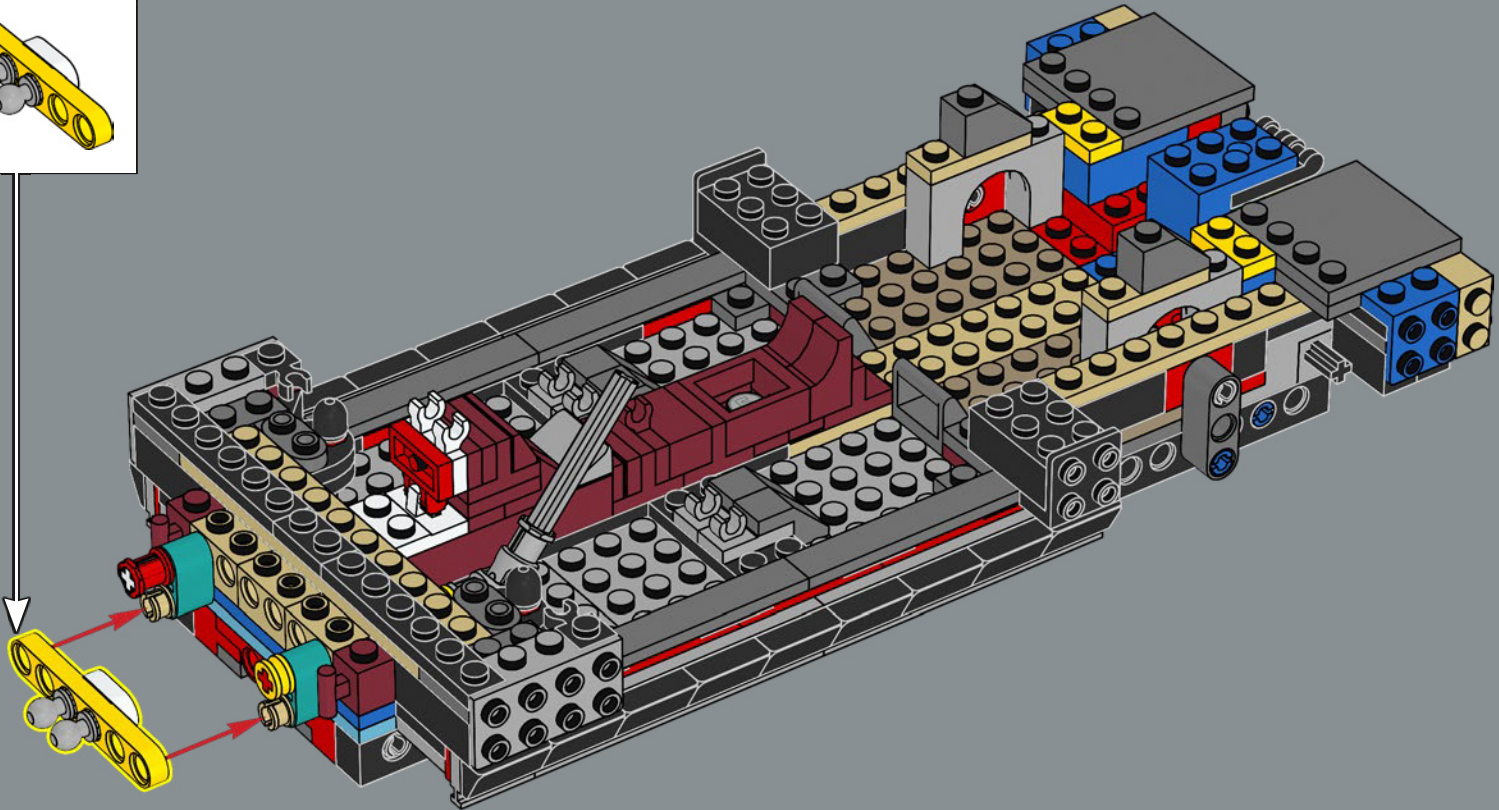
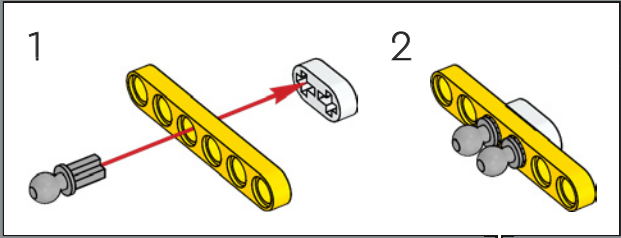

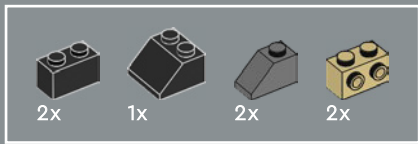

55

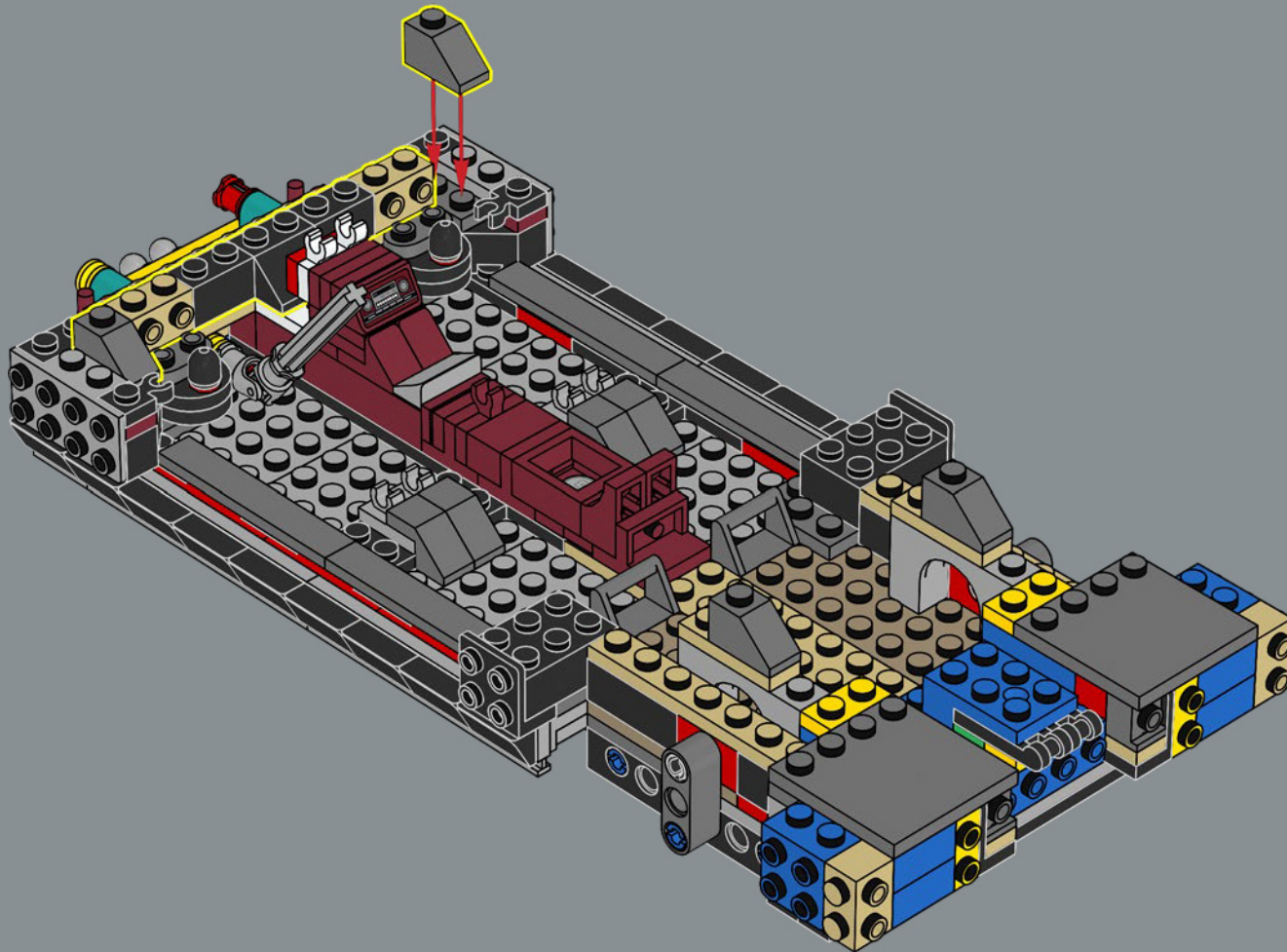

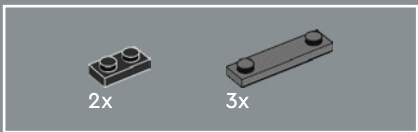

56

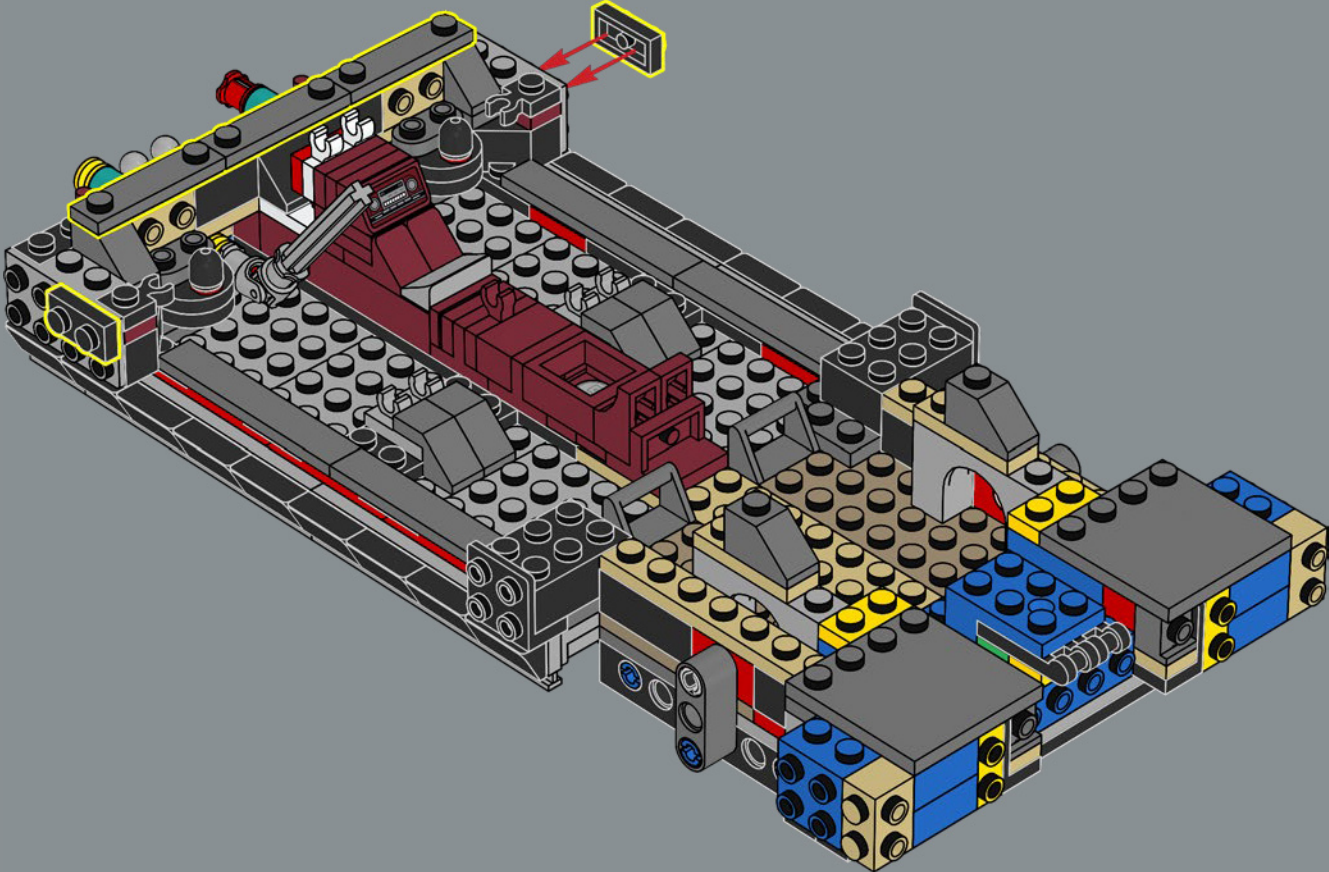

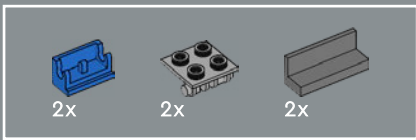

57

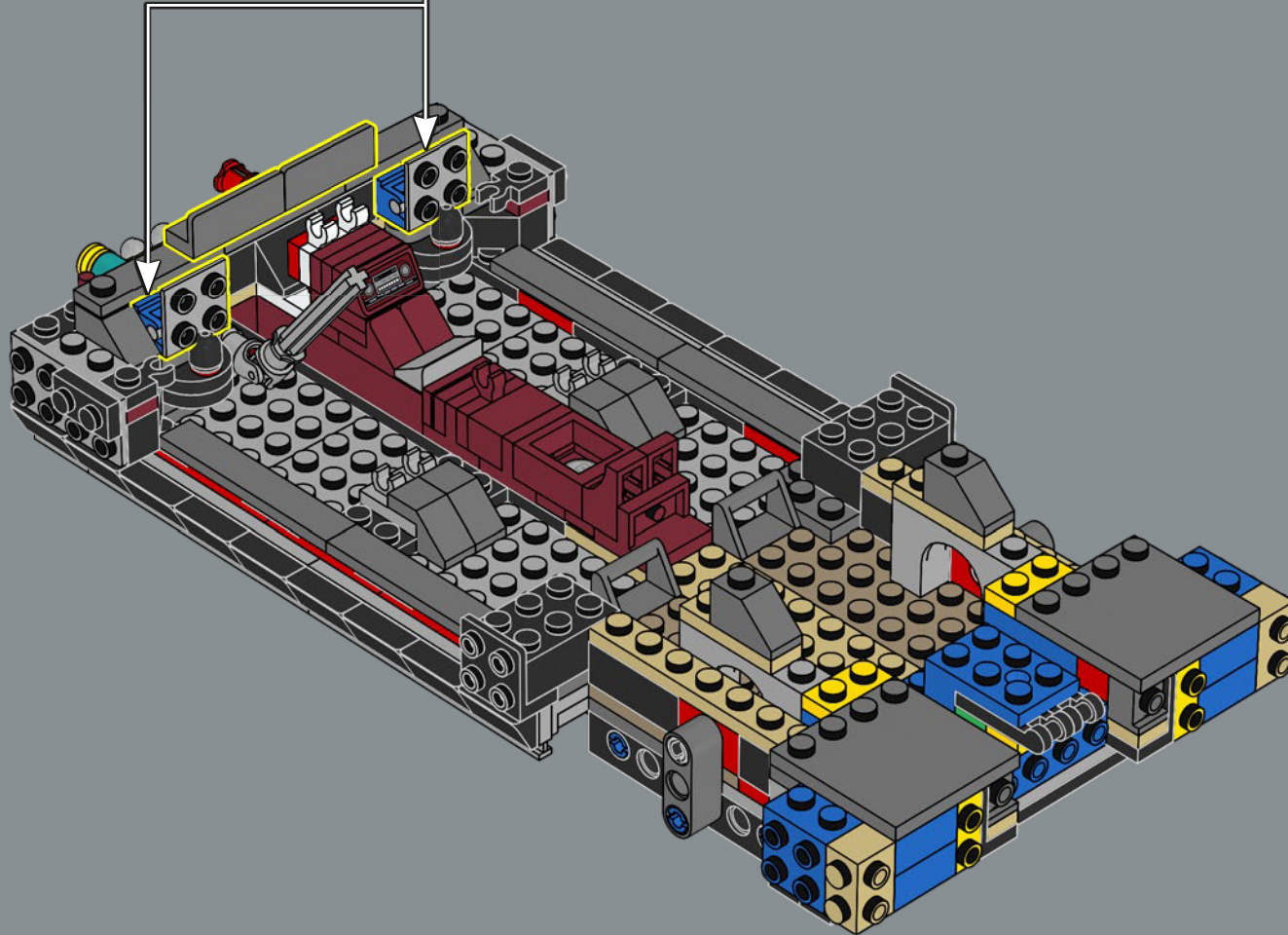
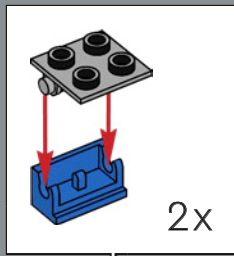

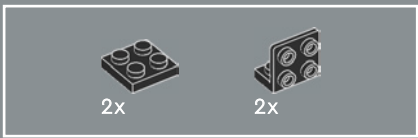

58

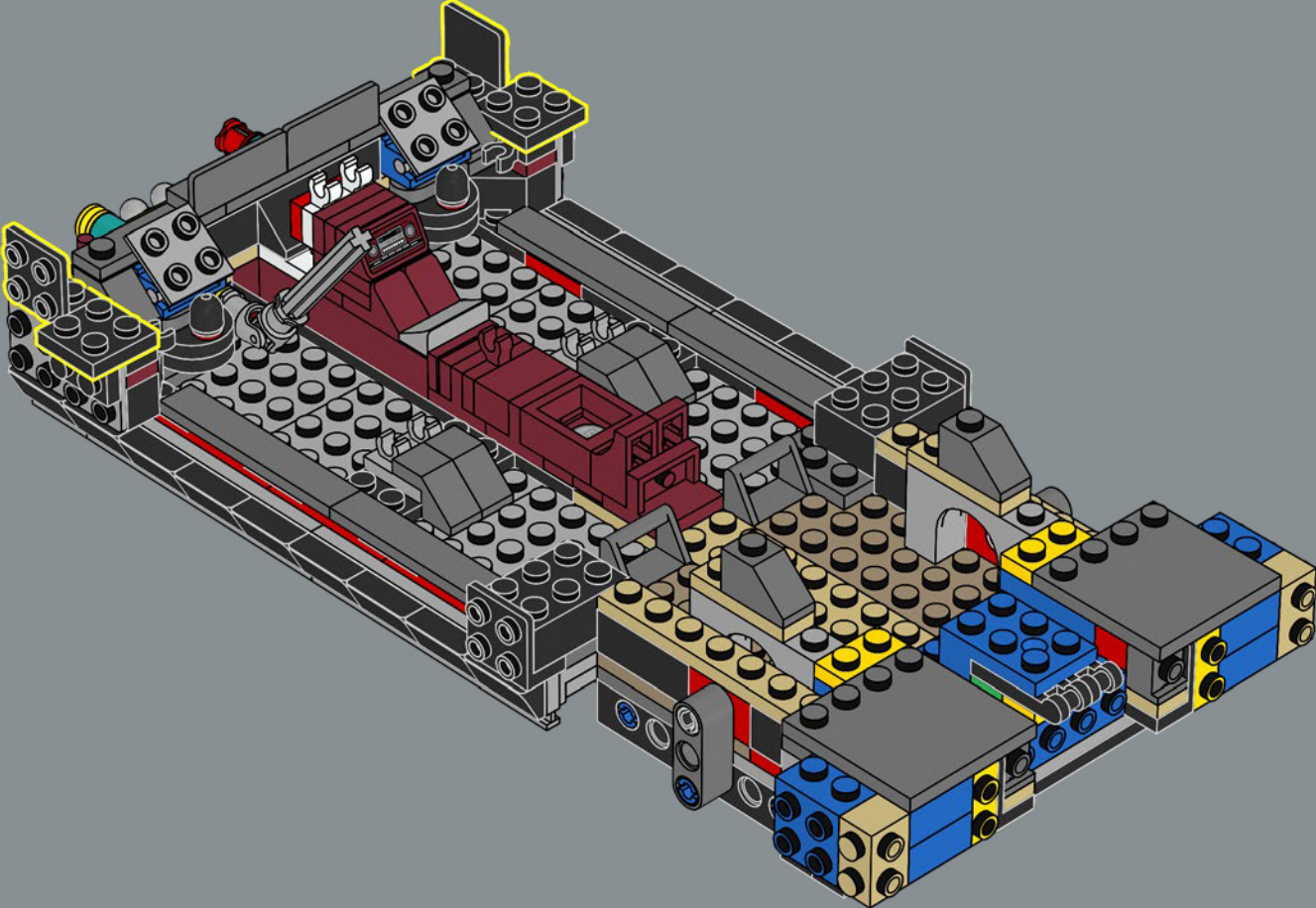

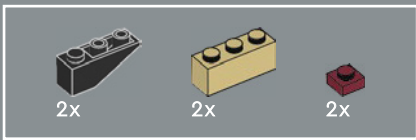

59

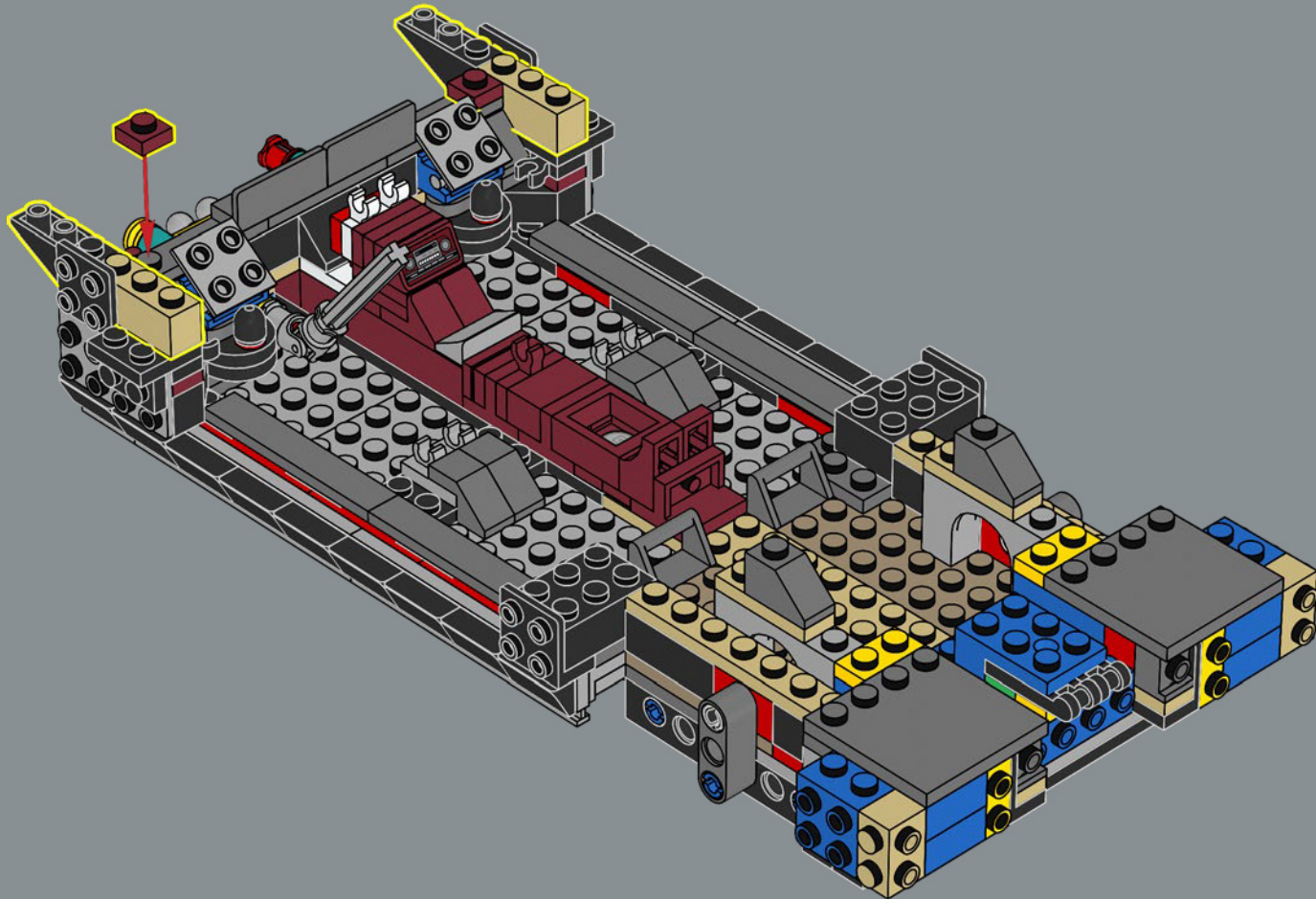



60

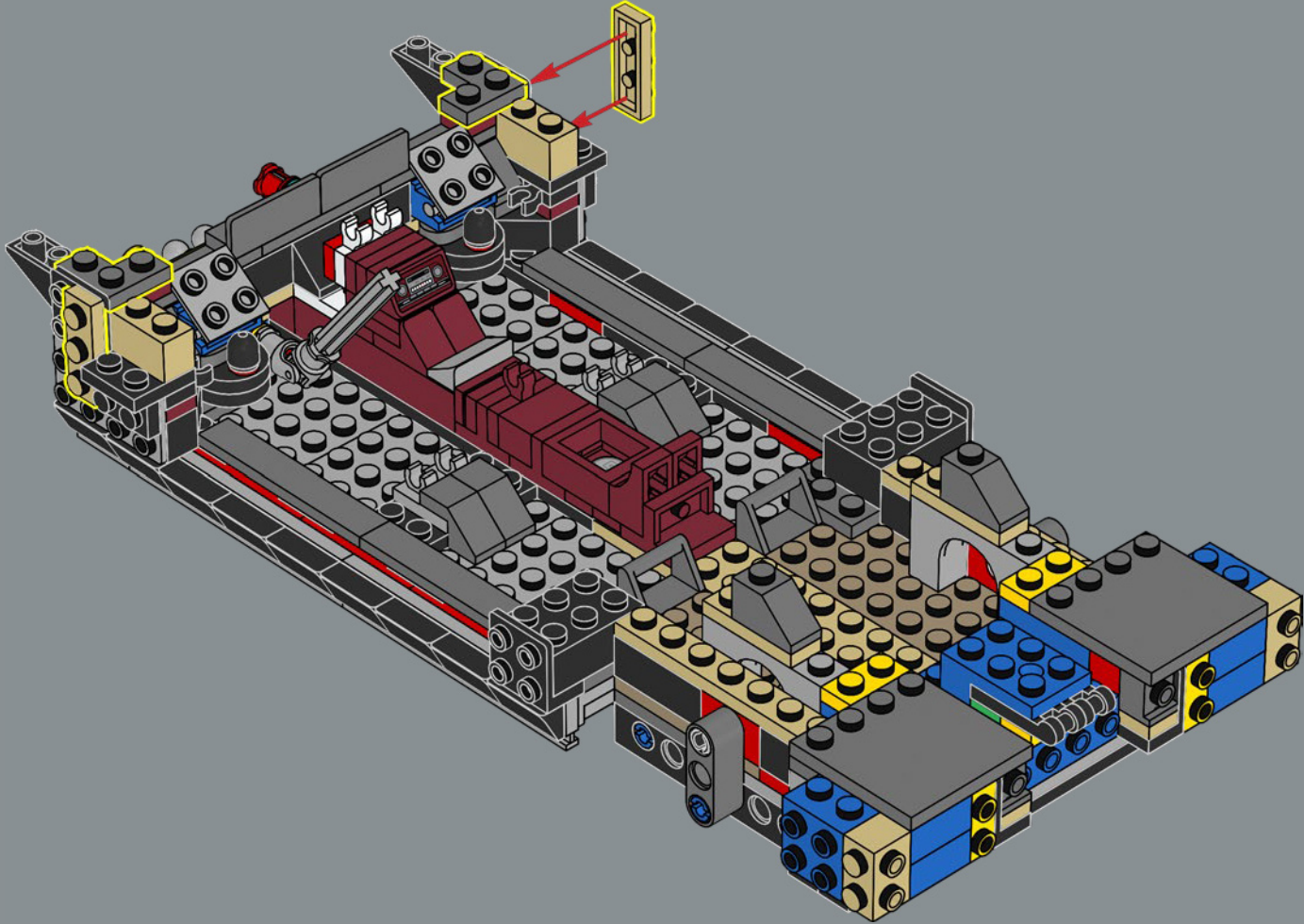

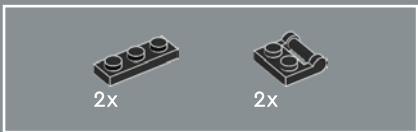

61

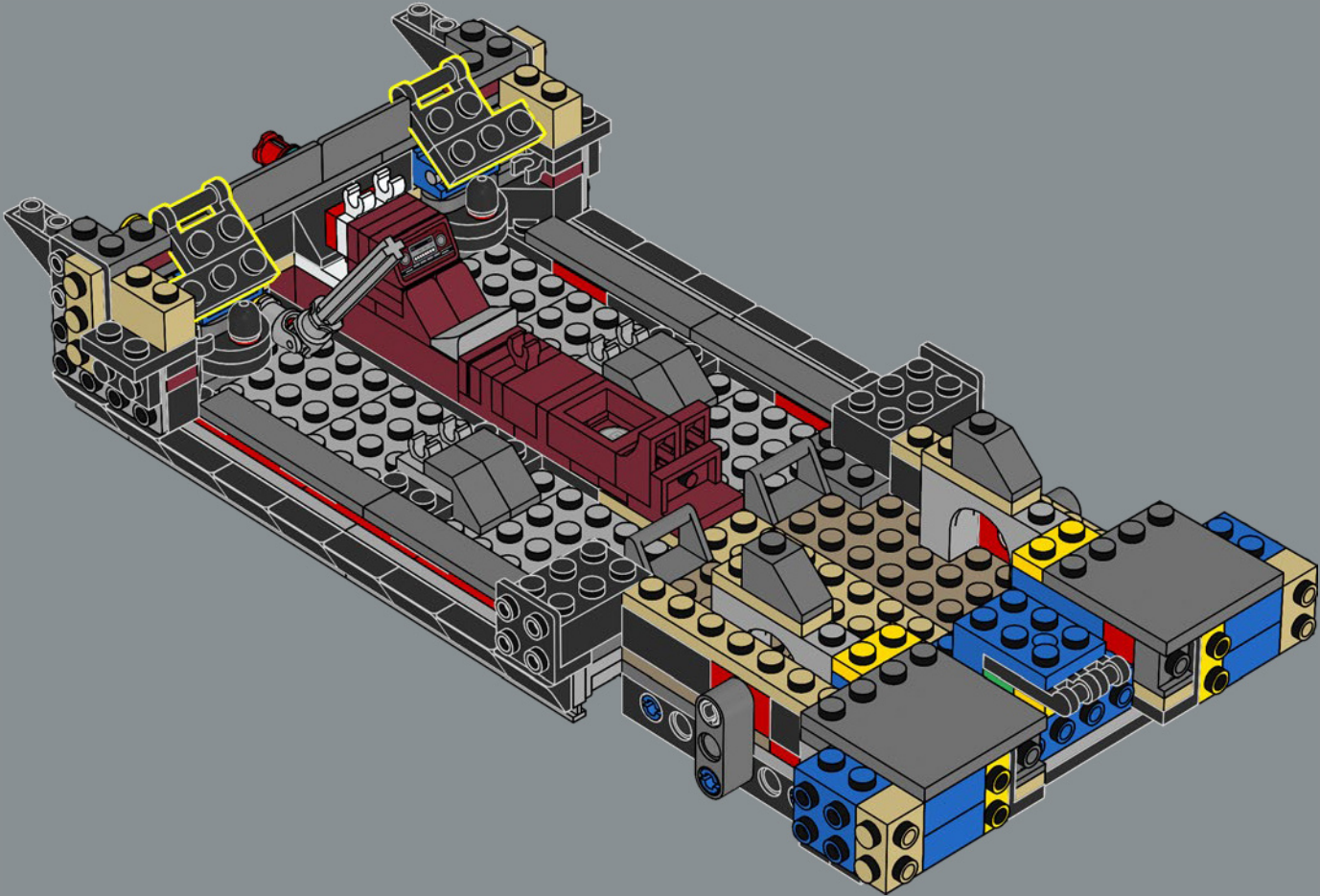

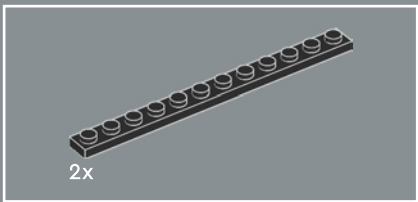

62

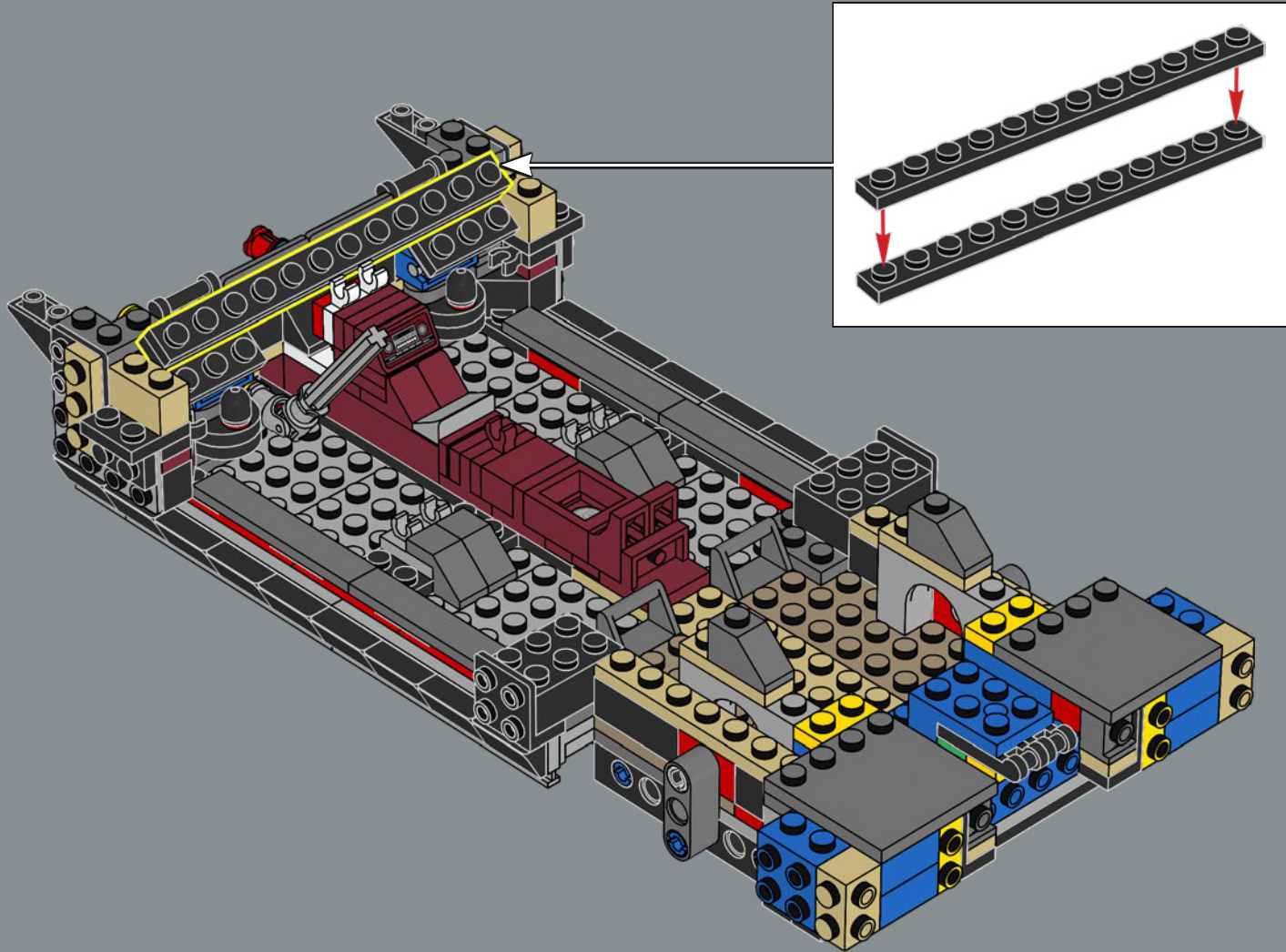

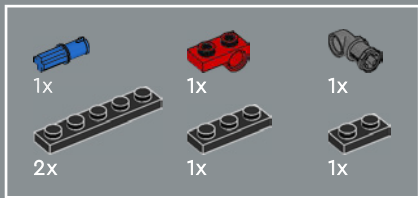

63

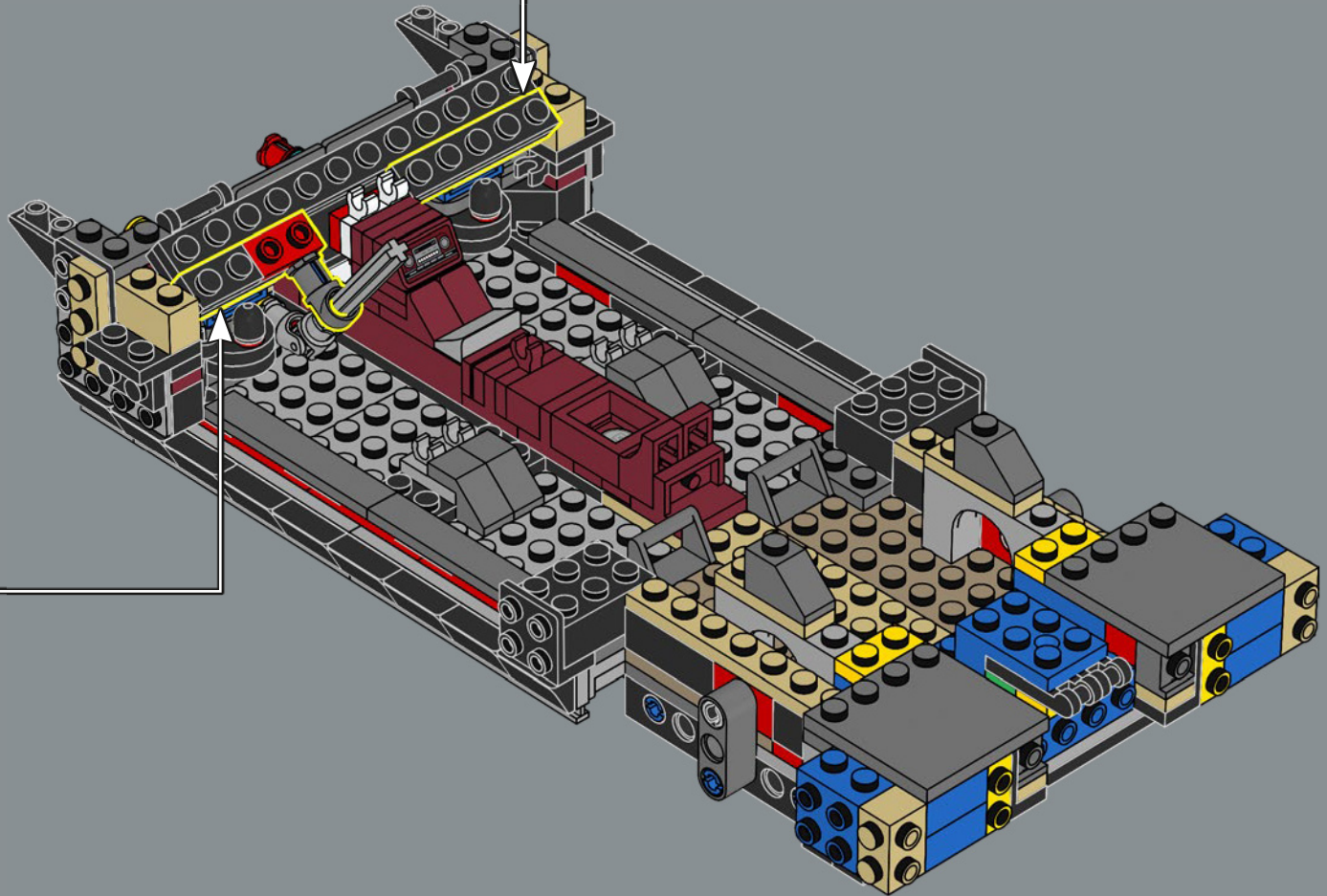
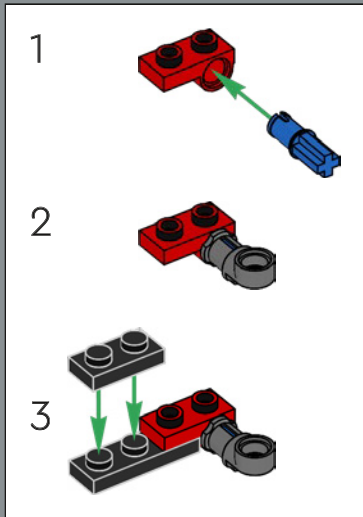
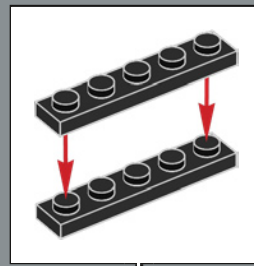

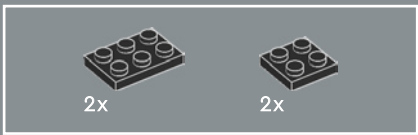

64

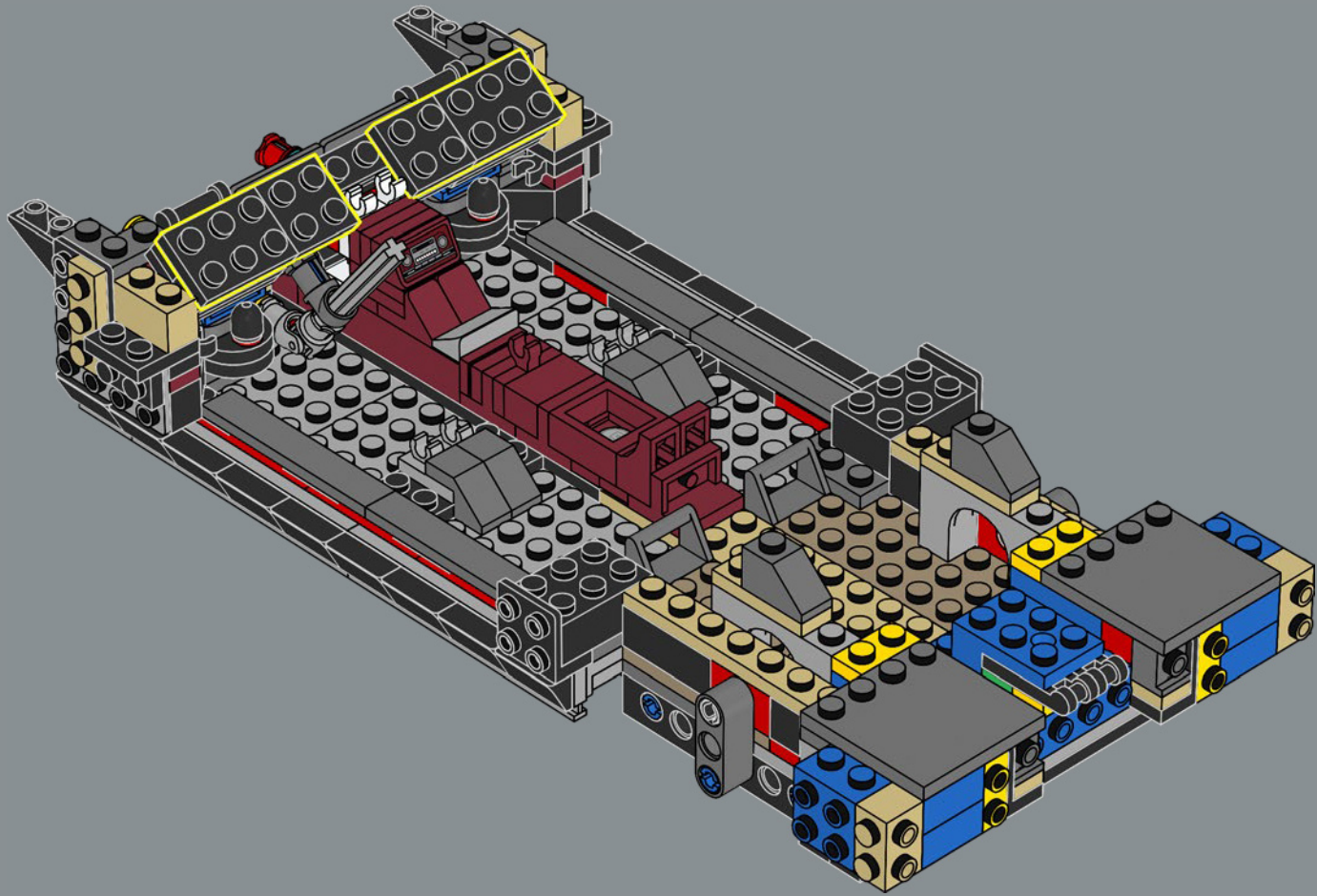



65

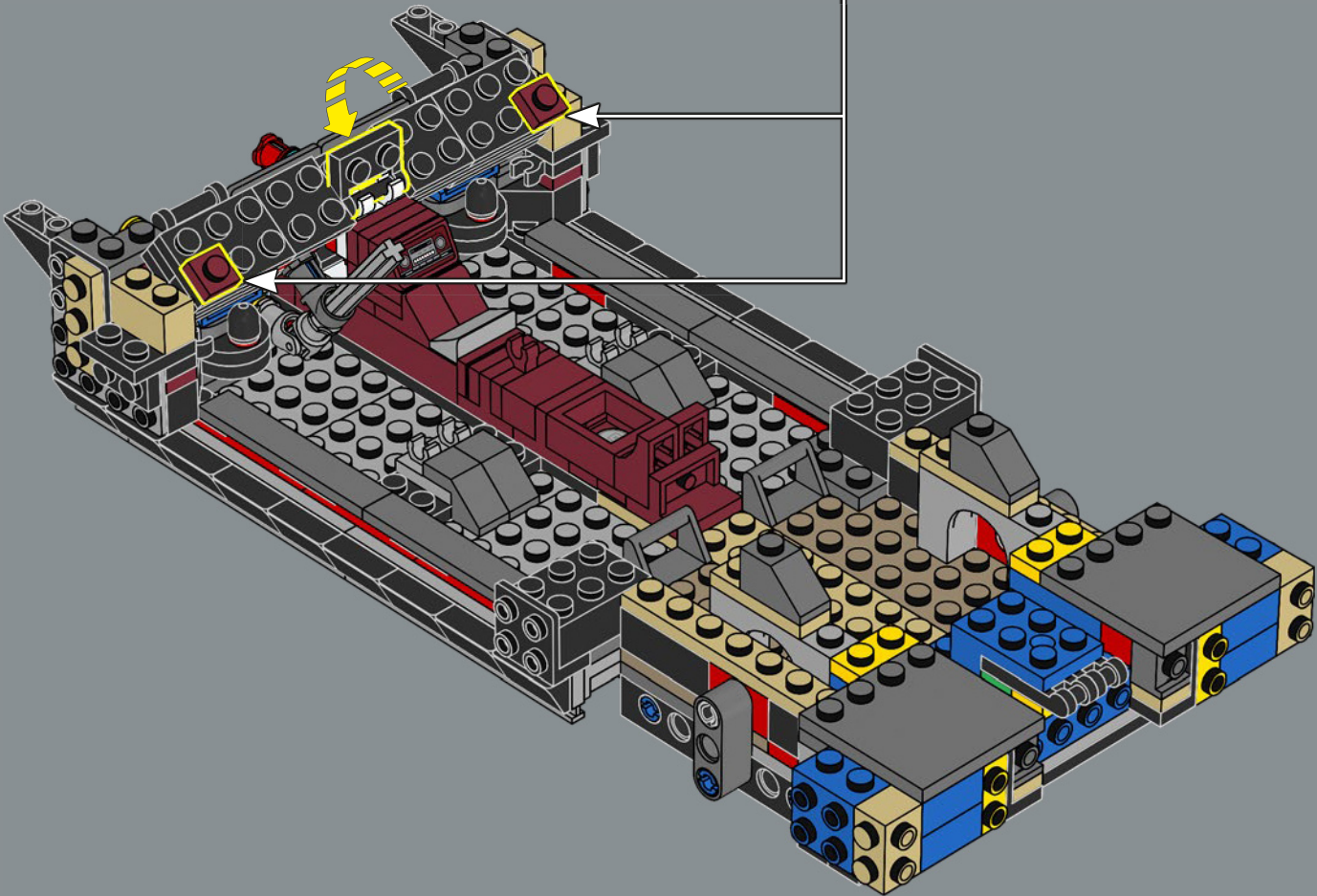
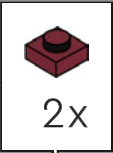

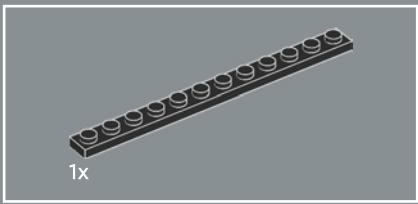

66

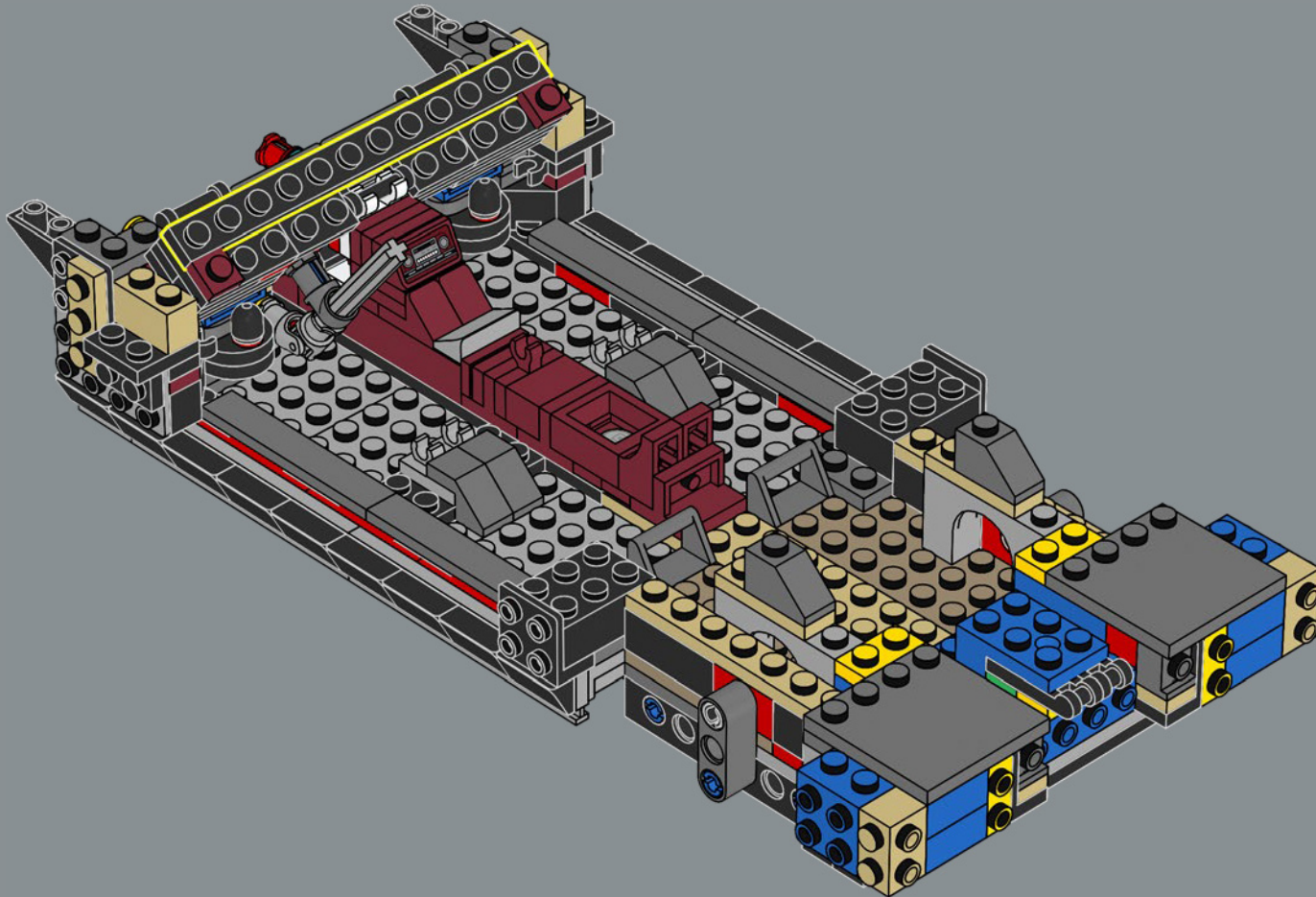

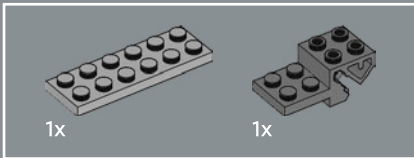
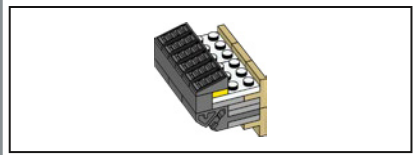

67

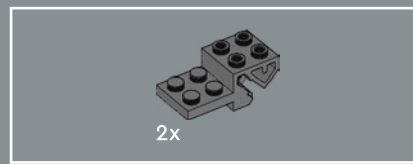
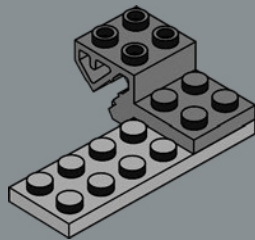

68

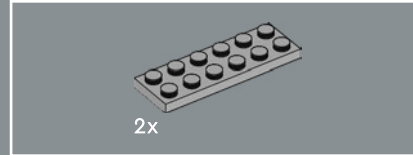
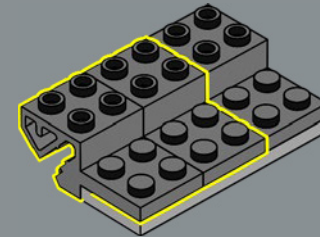

69

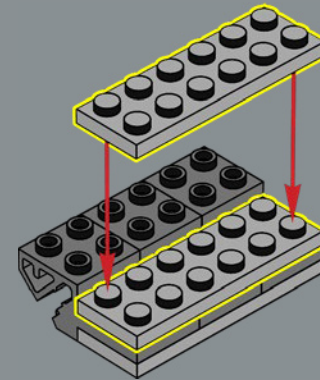

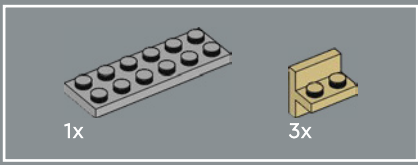

70

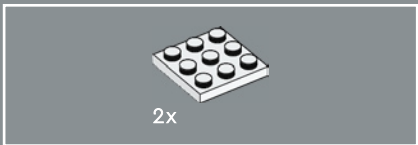
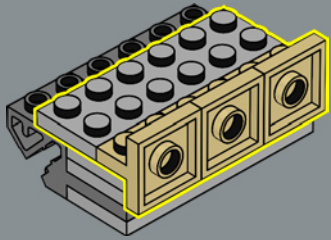

71

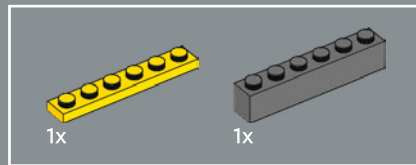
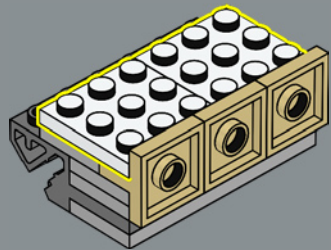

72

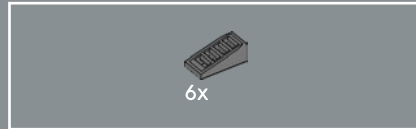
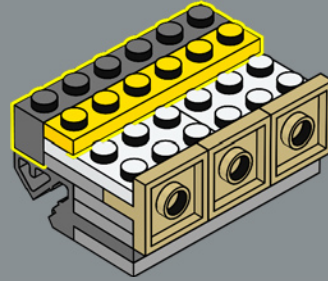

73

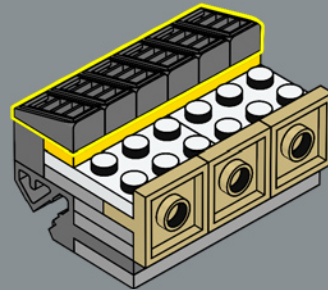

74

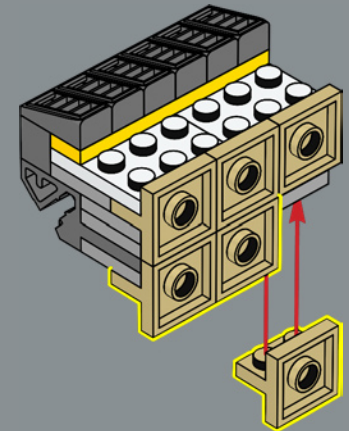

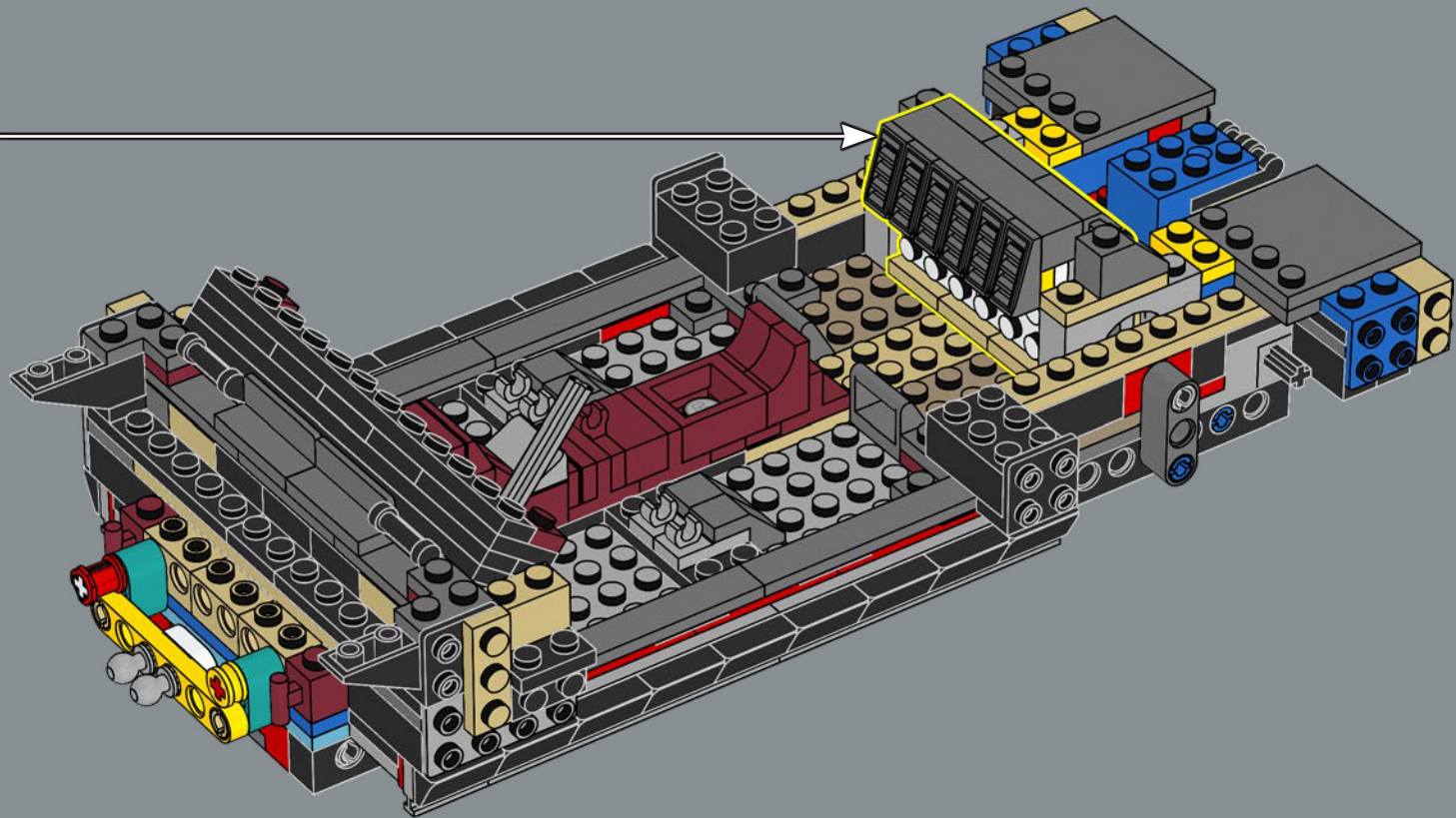

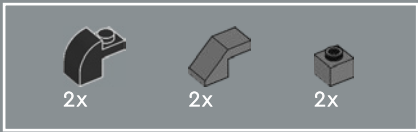

76

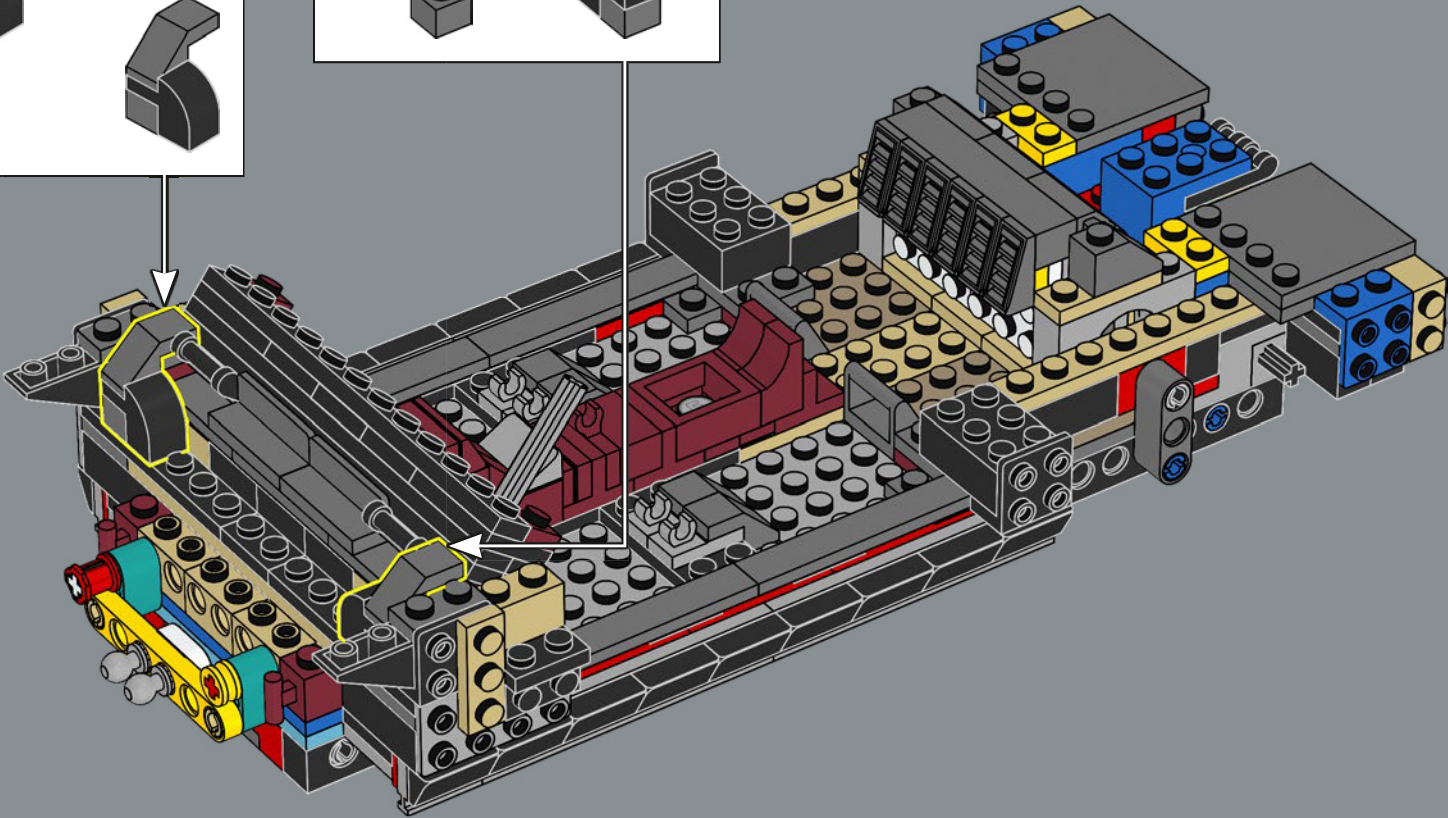
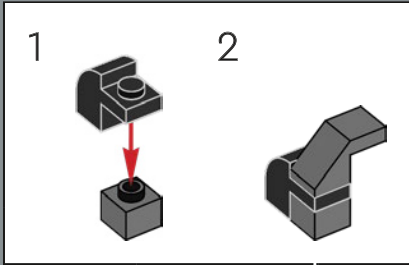
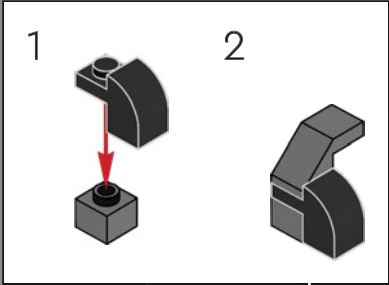

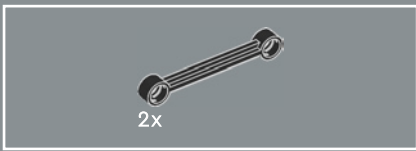

1969 wurde ein besonderes Camaro Z11 Cabrio als offizielles Safety Car beim legendären „Indy 500“ eingesetzt.

77

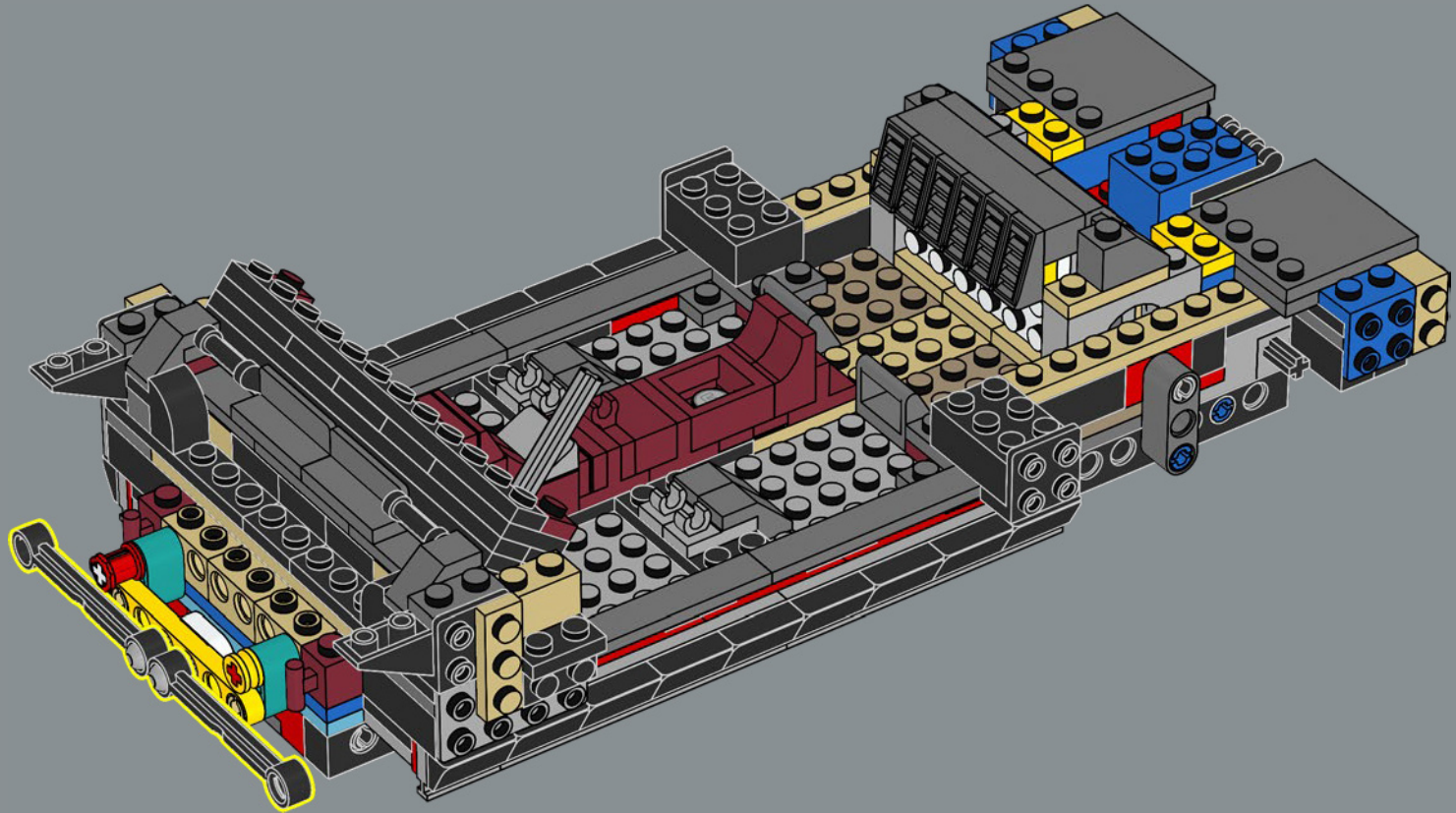

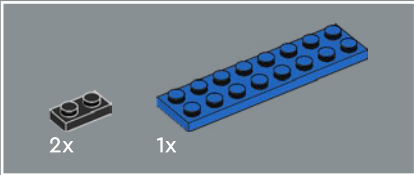
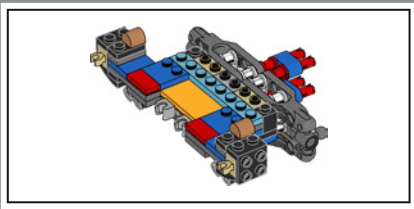

78

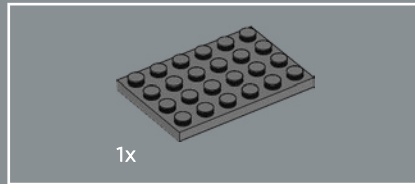
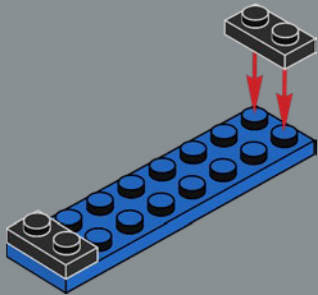

79

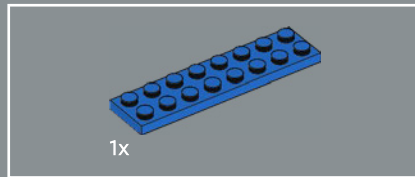
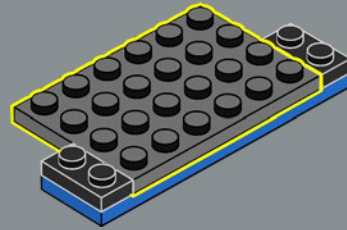

80

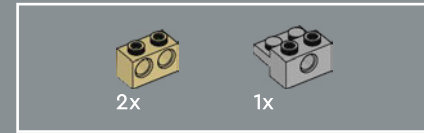
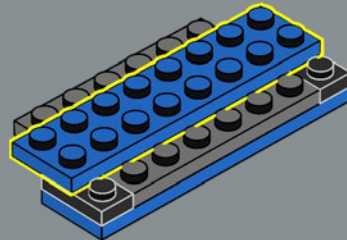

81

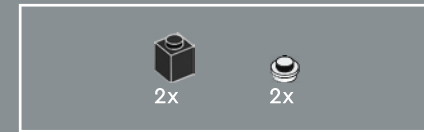
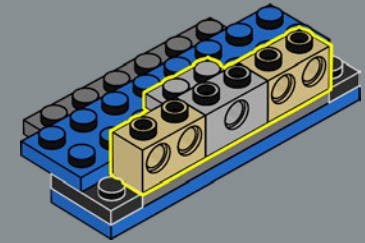

82

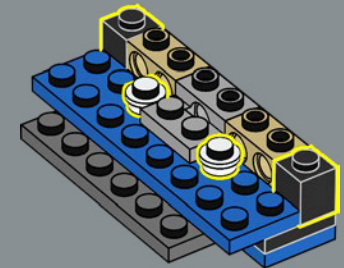



83

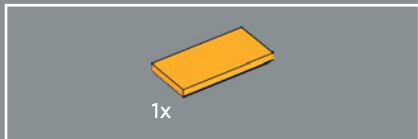
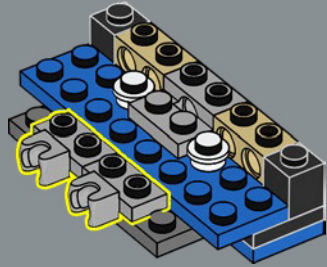

84

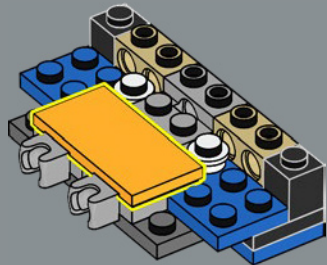

85

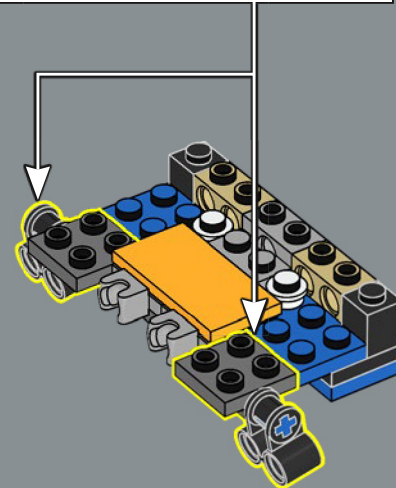
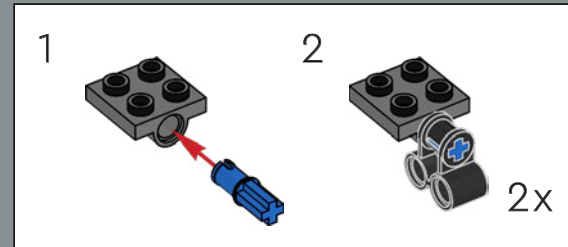

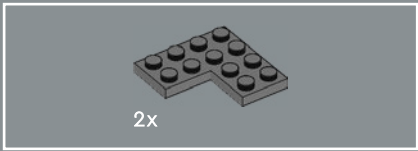

86

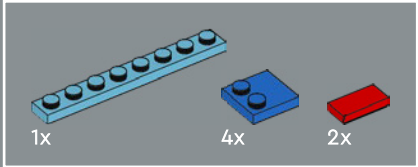
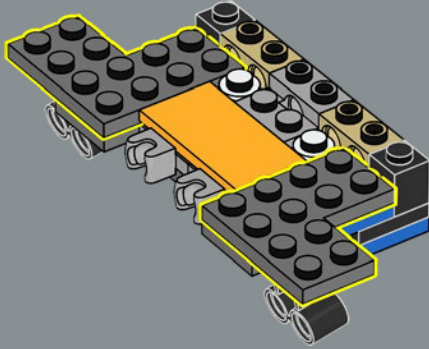

87

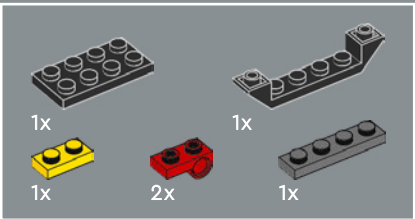
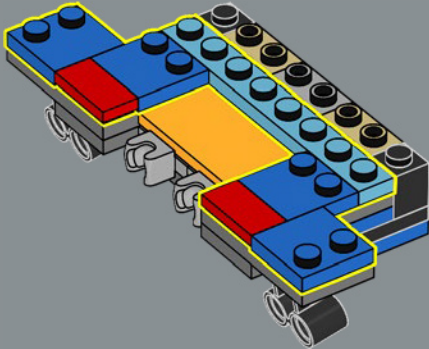

88

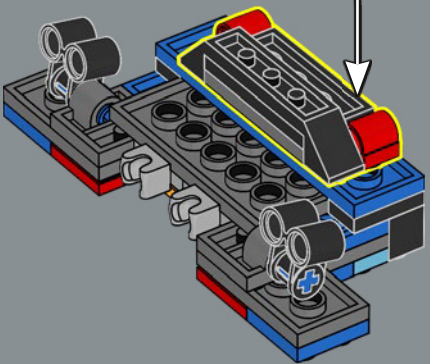
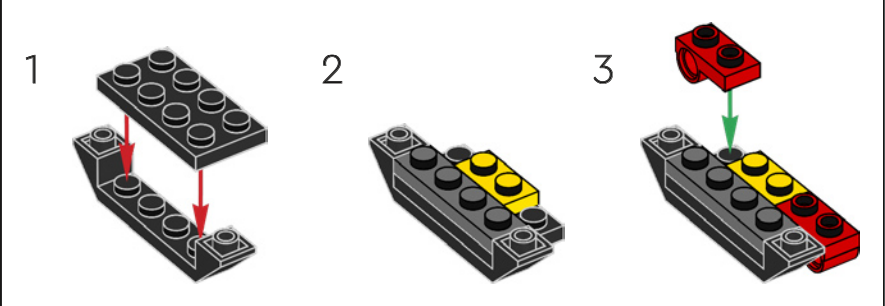

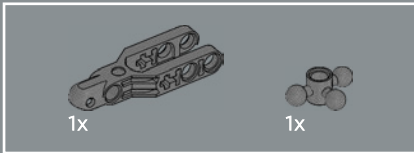
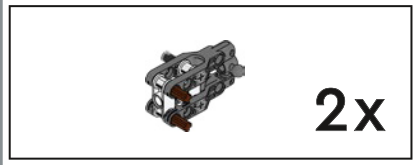
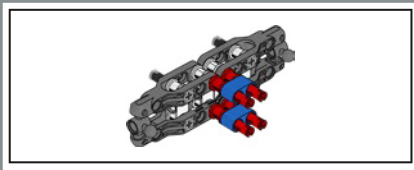

89

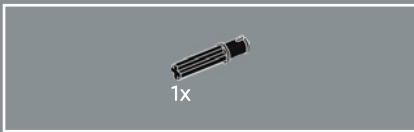
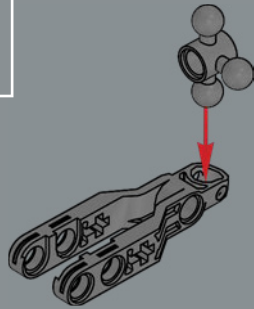

90

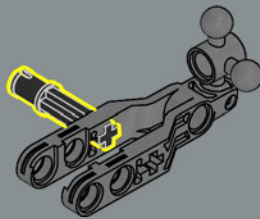

91

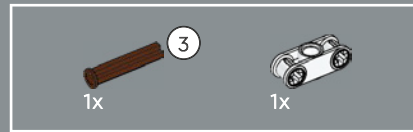
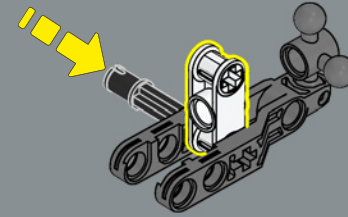

92

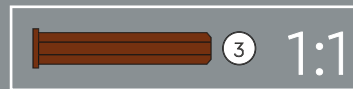
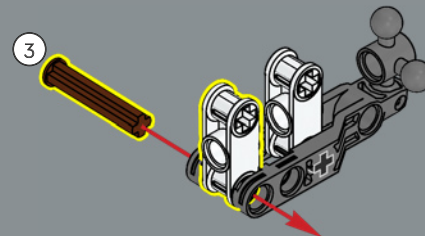



93

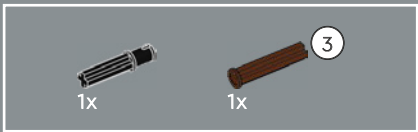
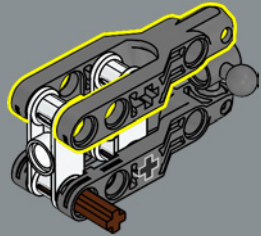

94

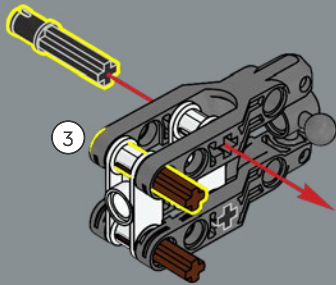

2x

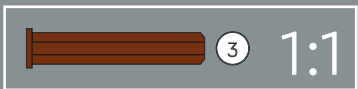

95

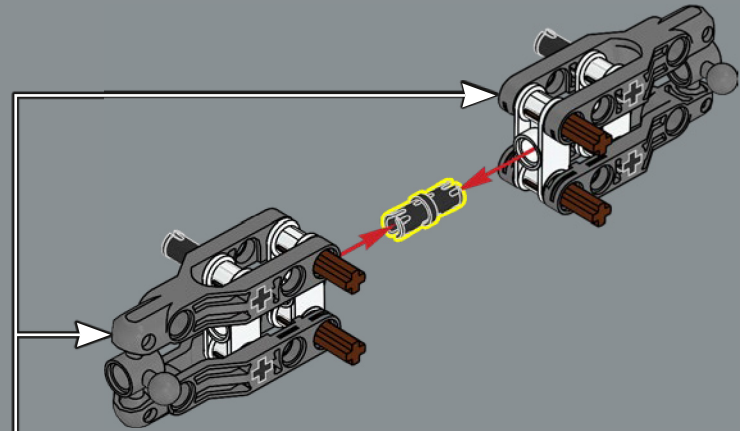



96

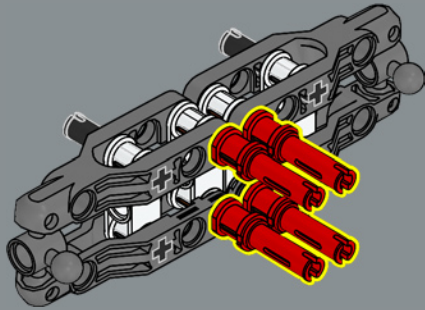

97

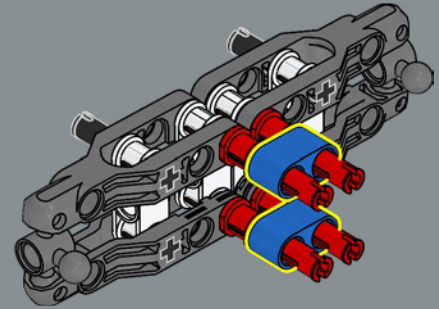

98

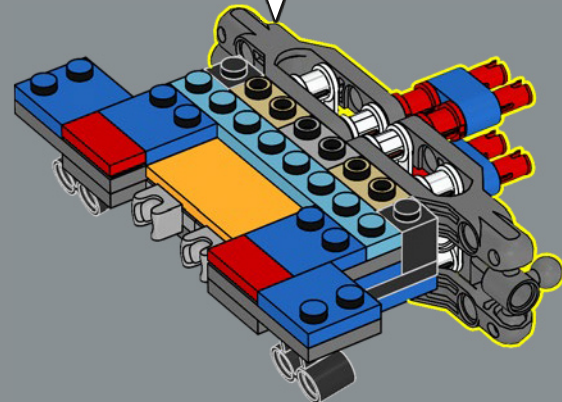

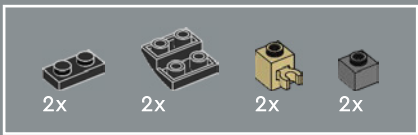

99

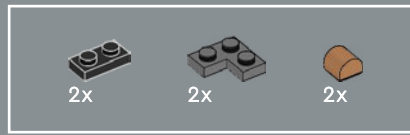
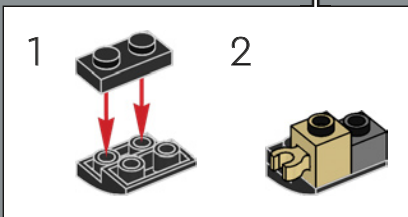
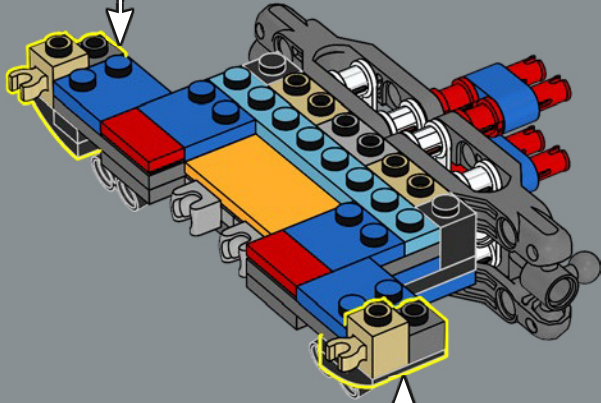
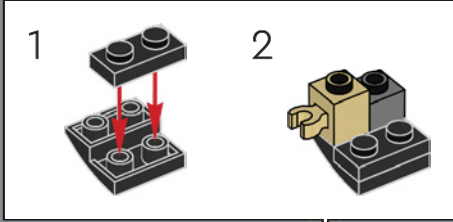

100

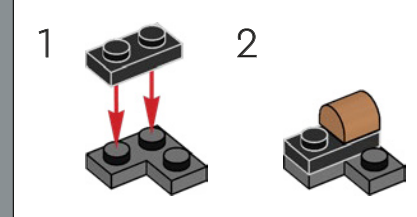
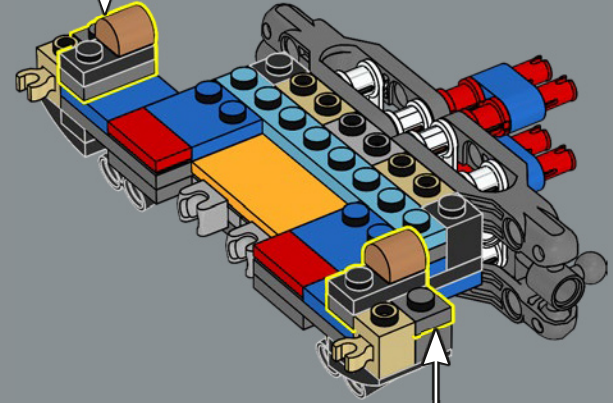
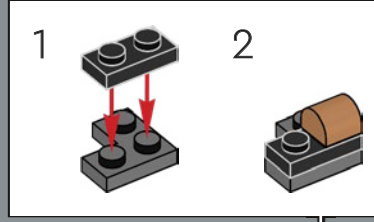



101

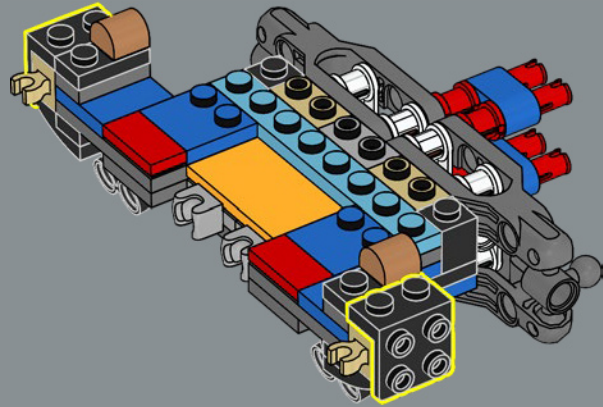

102

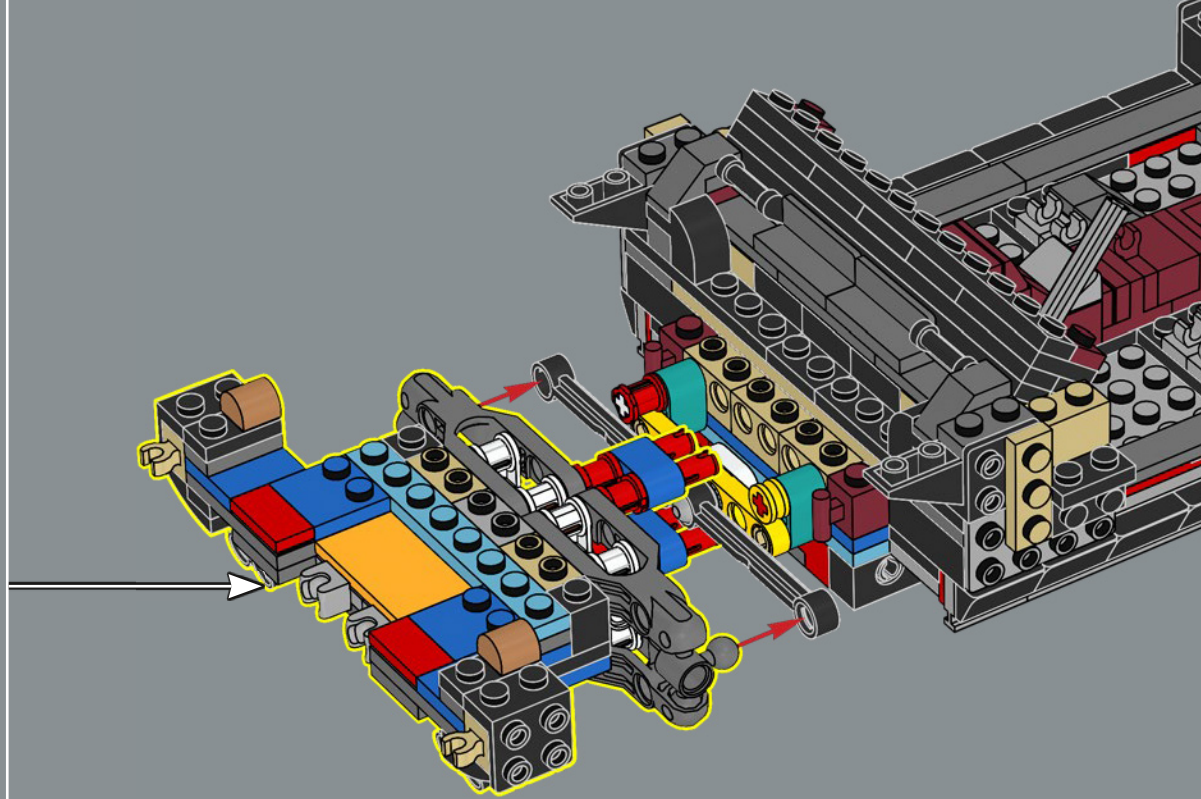

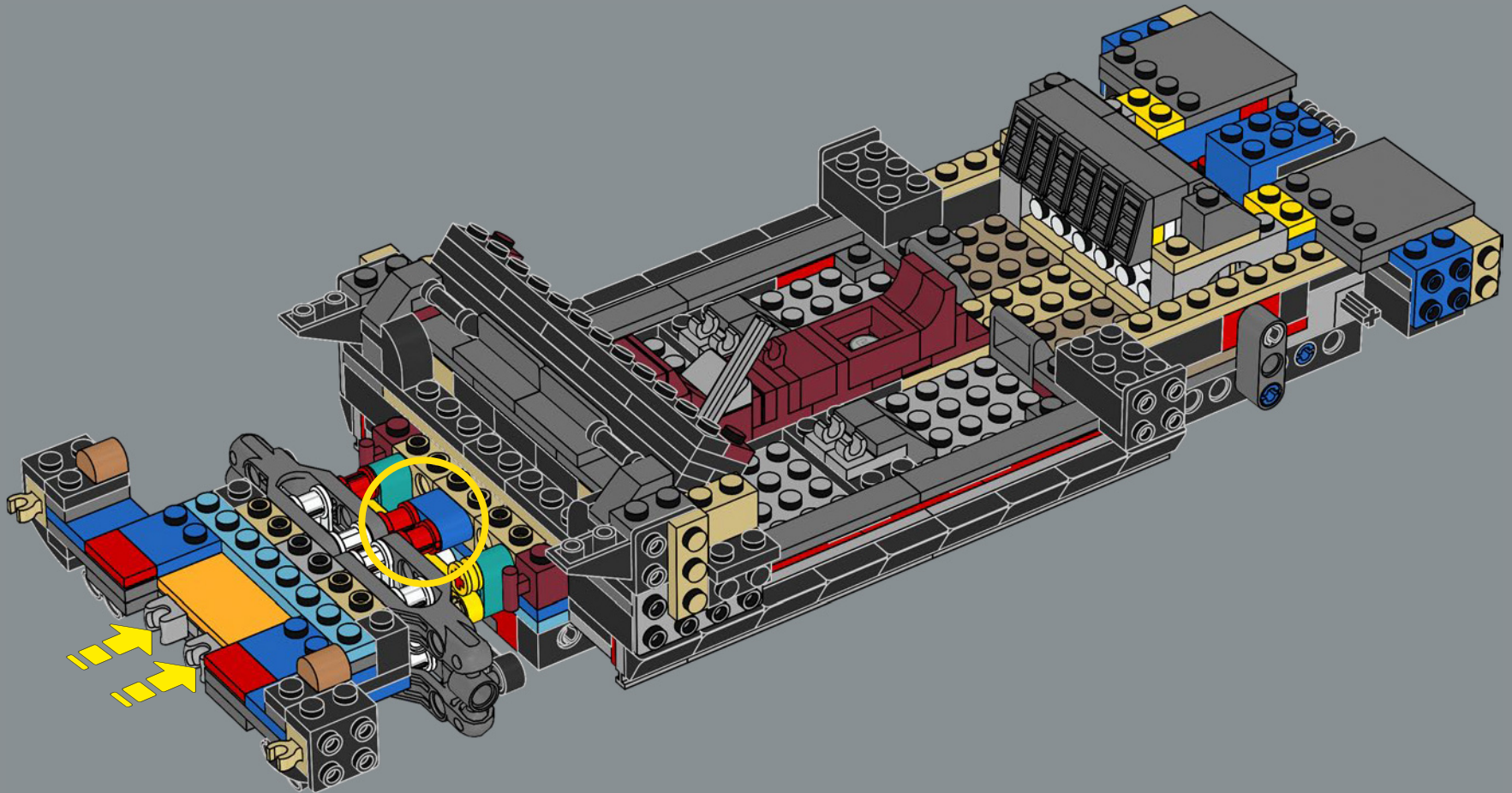

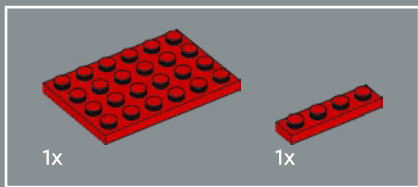

104

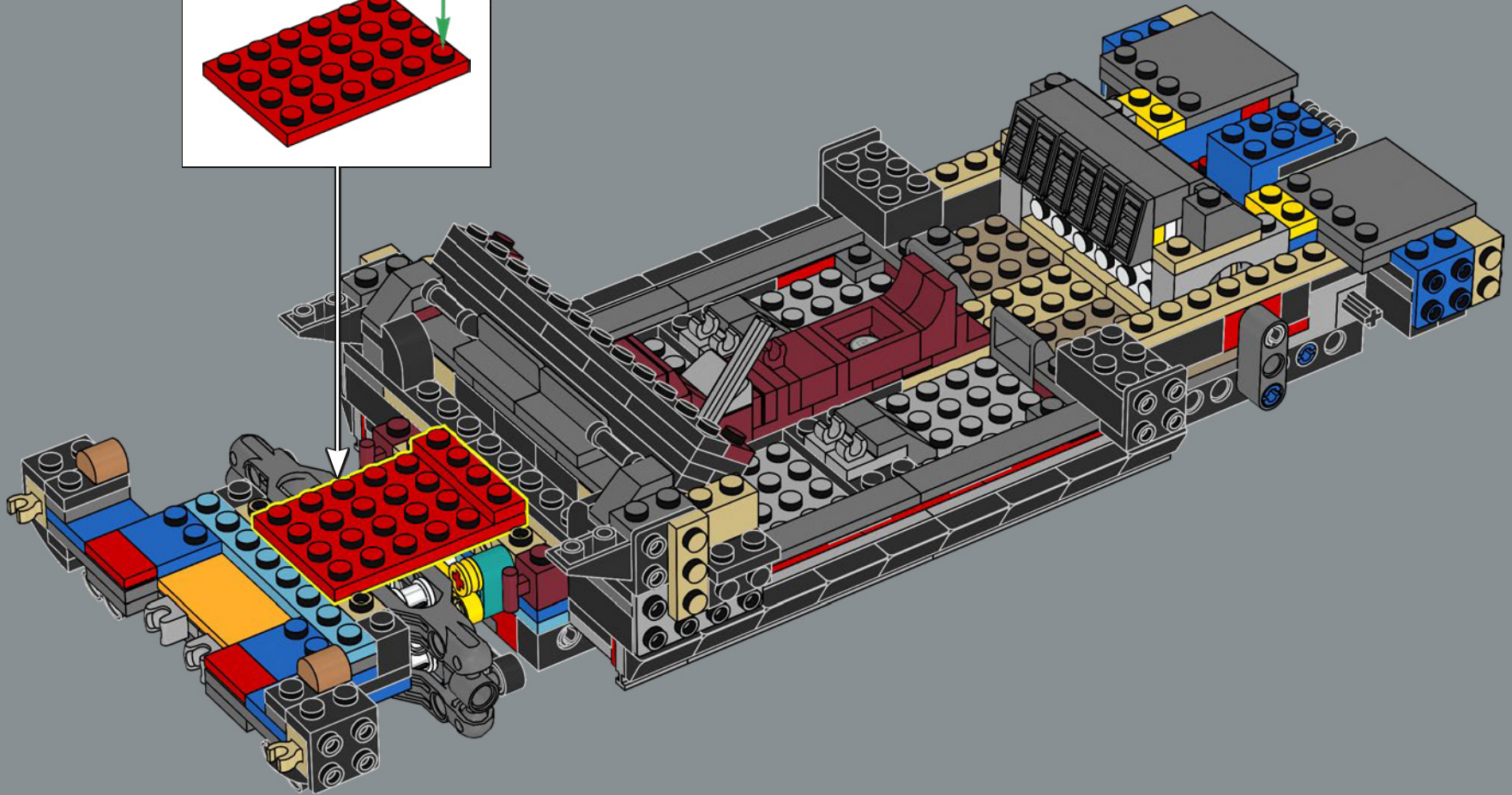
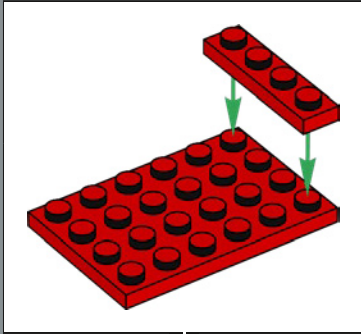

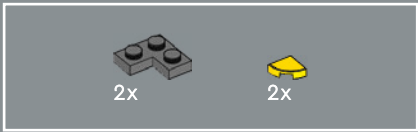

105

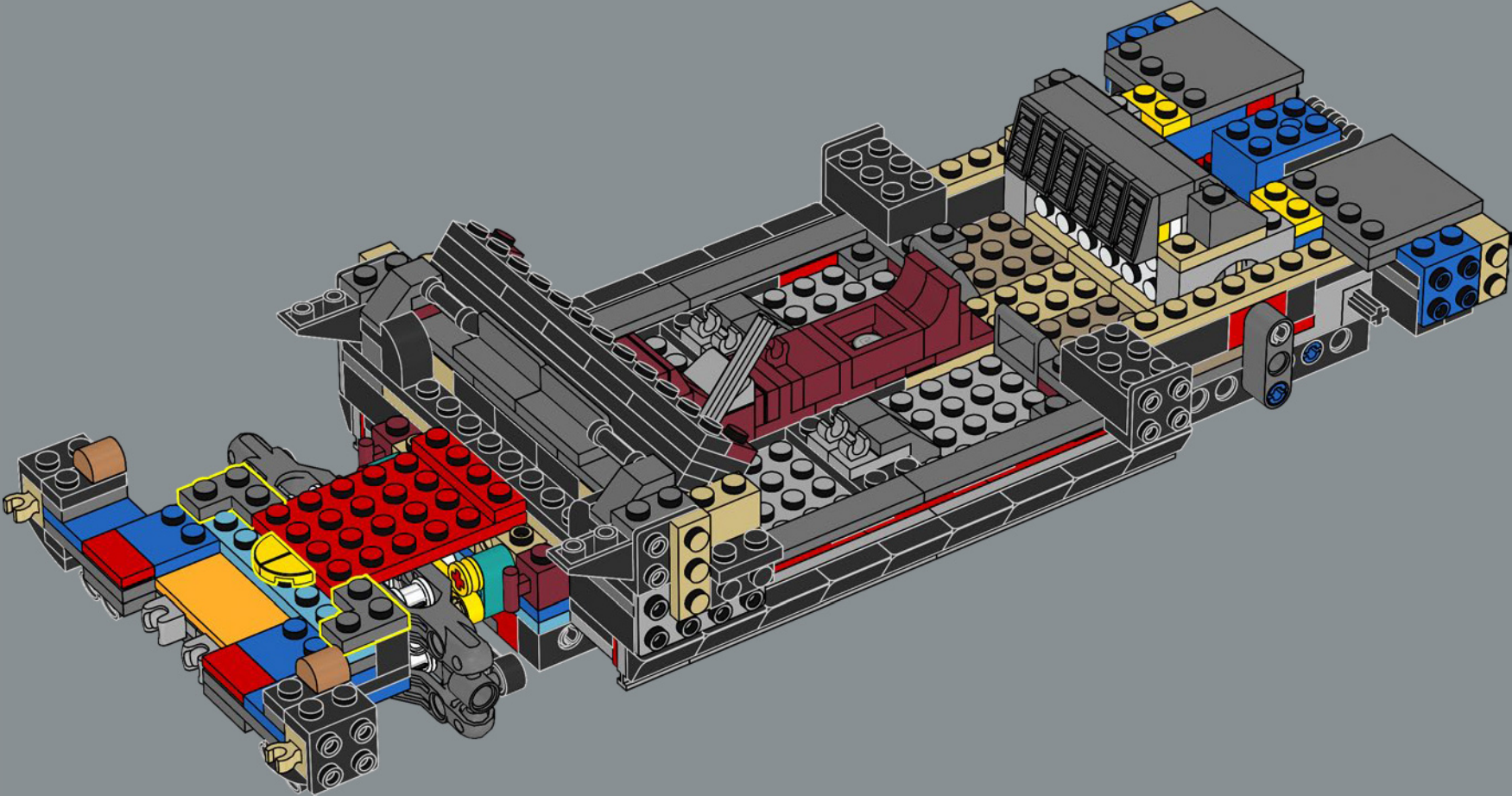

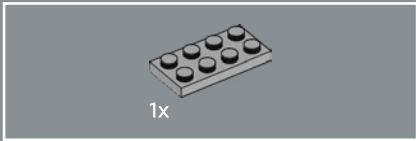
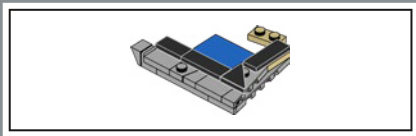

106

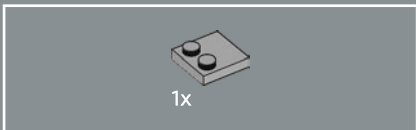

107

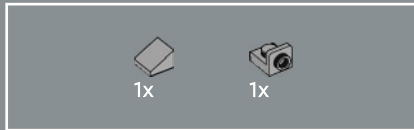
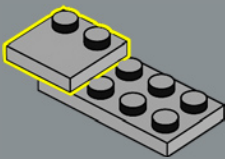

108

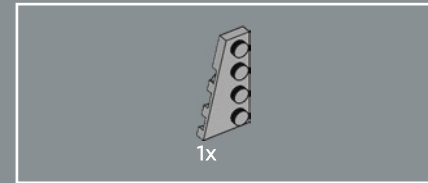
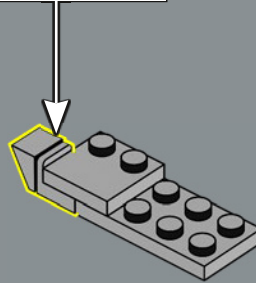
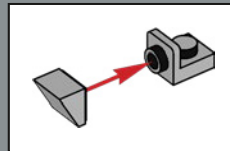

109

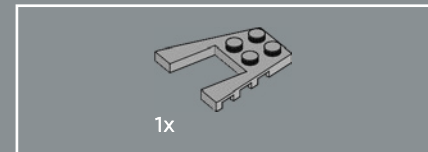
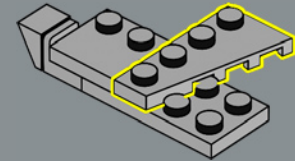

110

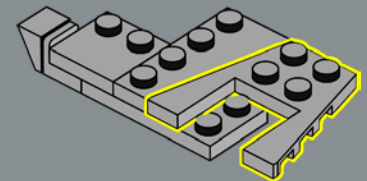

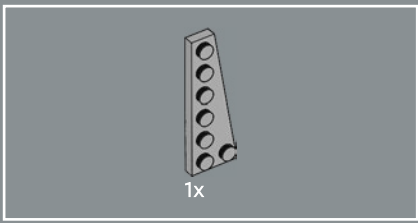

111

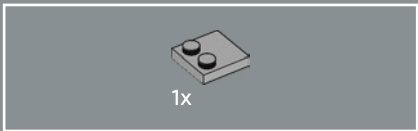
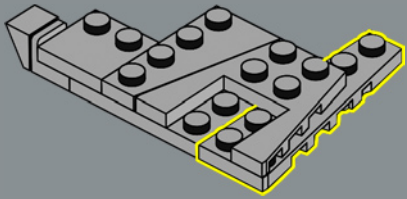

112

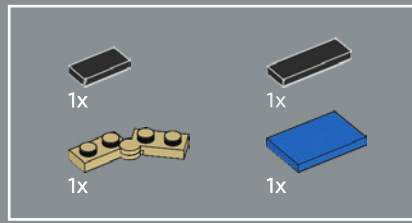
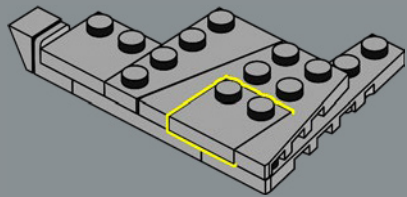

113

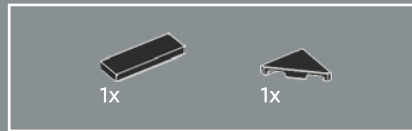
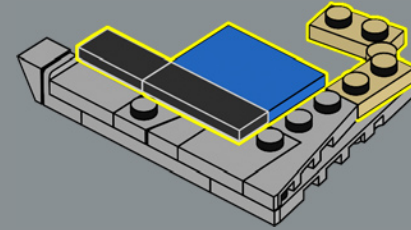

114

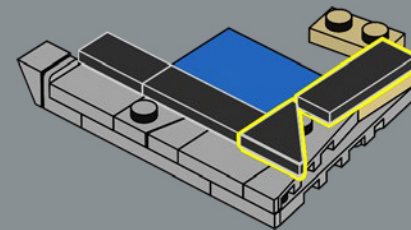

115

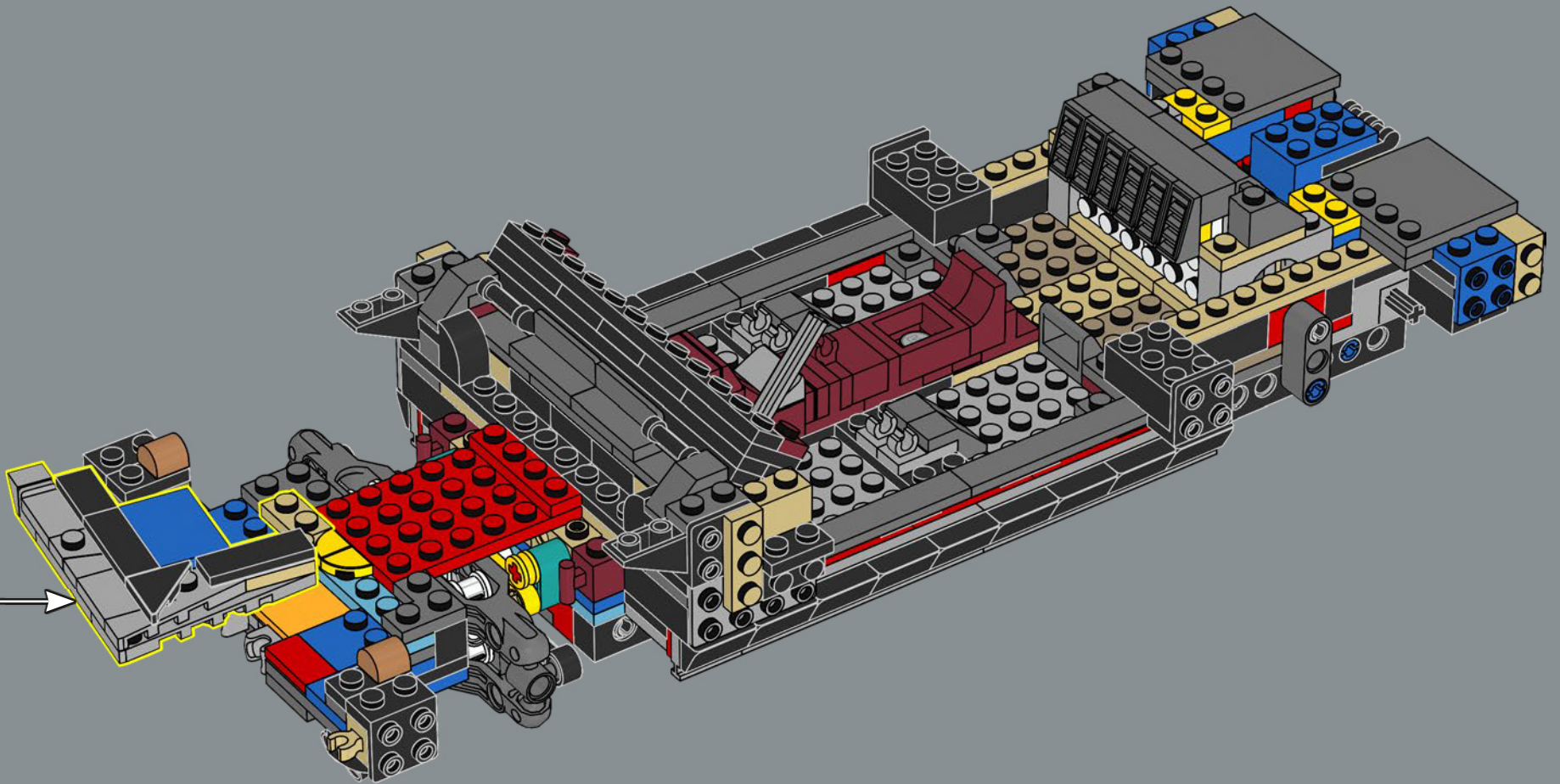

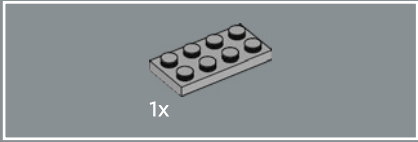
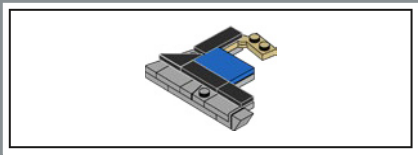

116

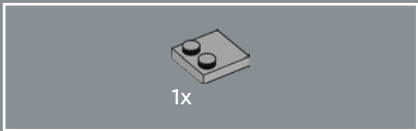
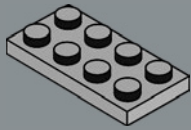

117

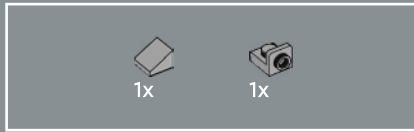
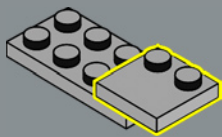

118

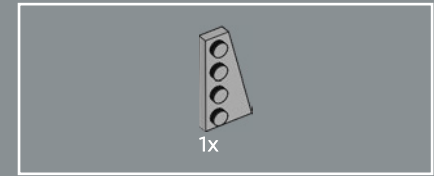
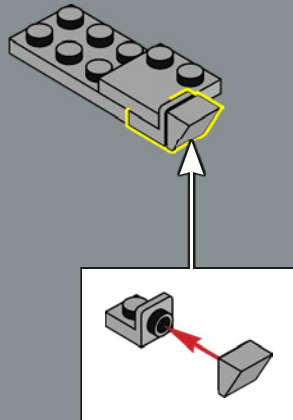

119

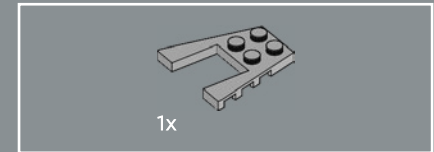
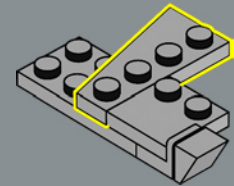

120

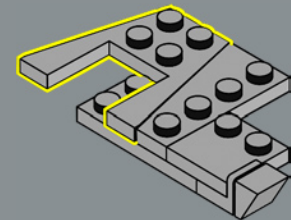

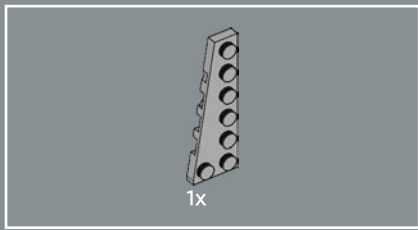

121

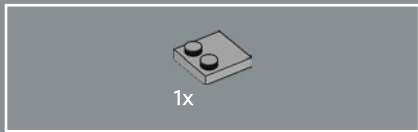
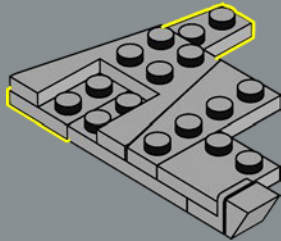

122

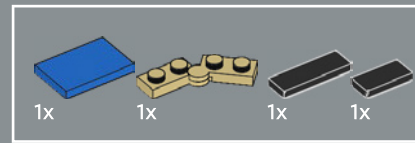
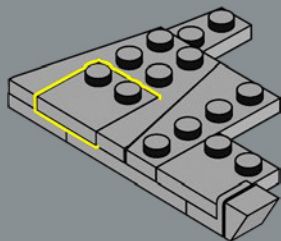

123

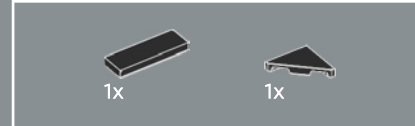
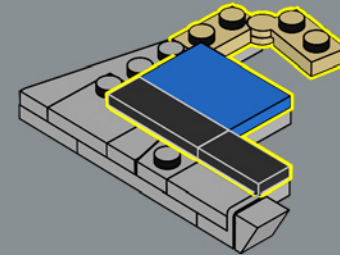

124

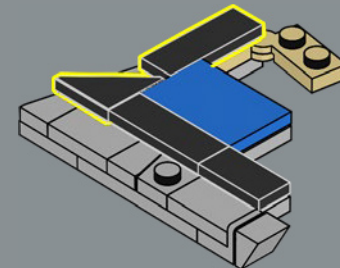

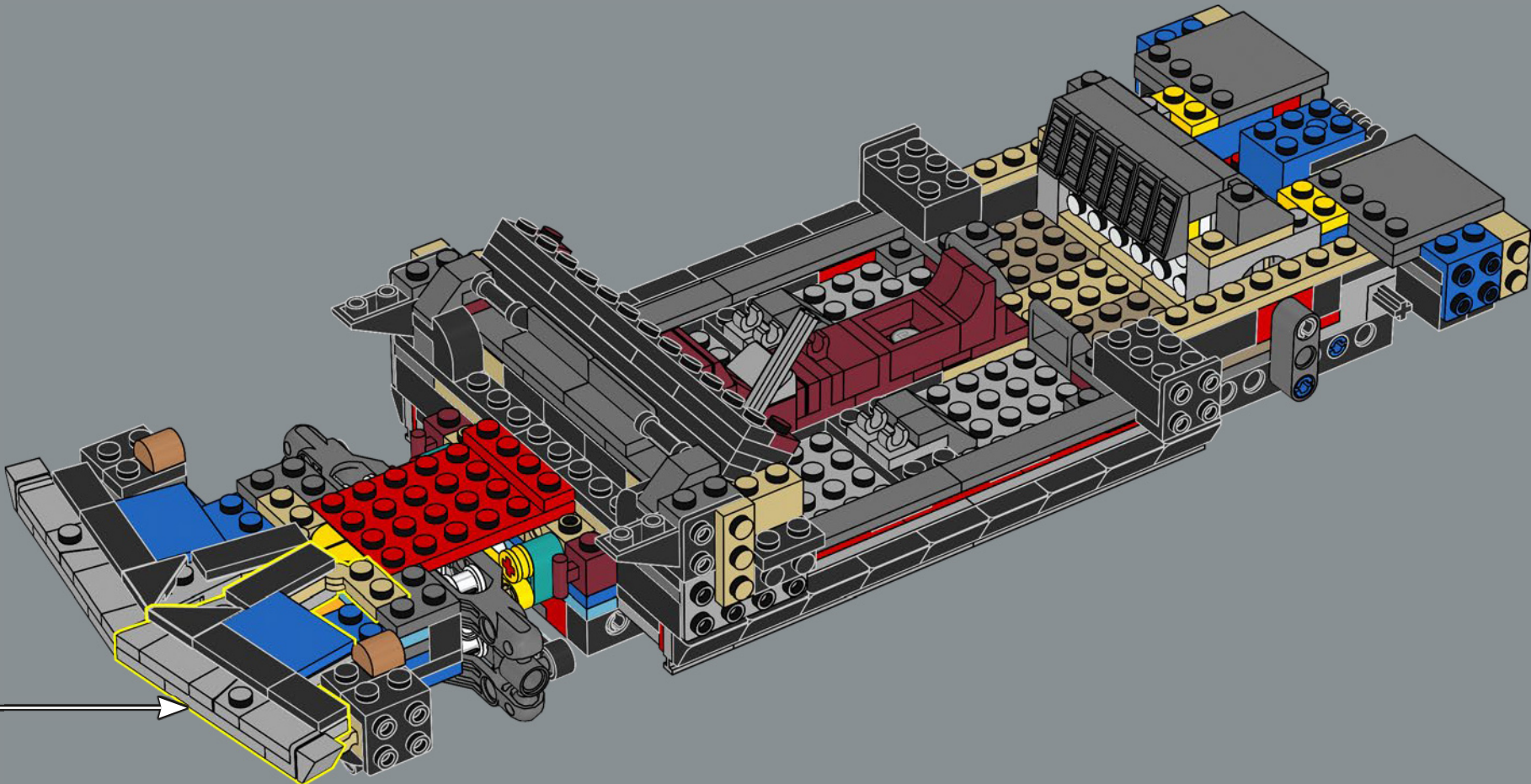

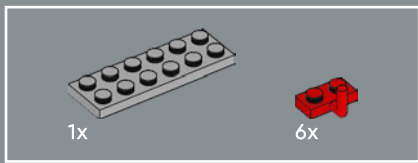

126

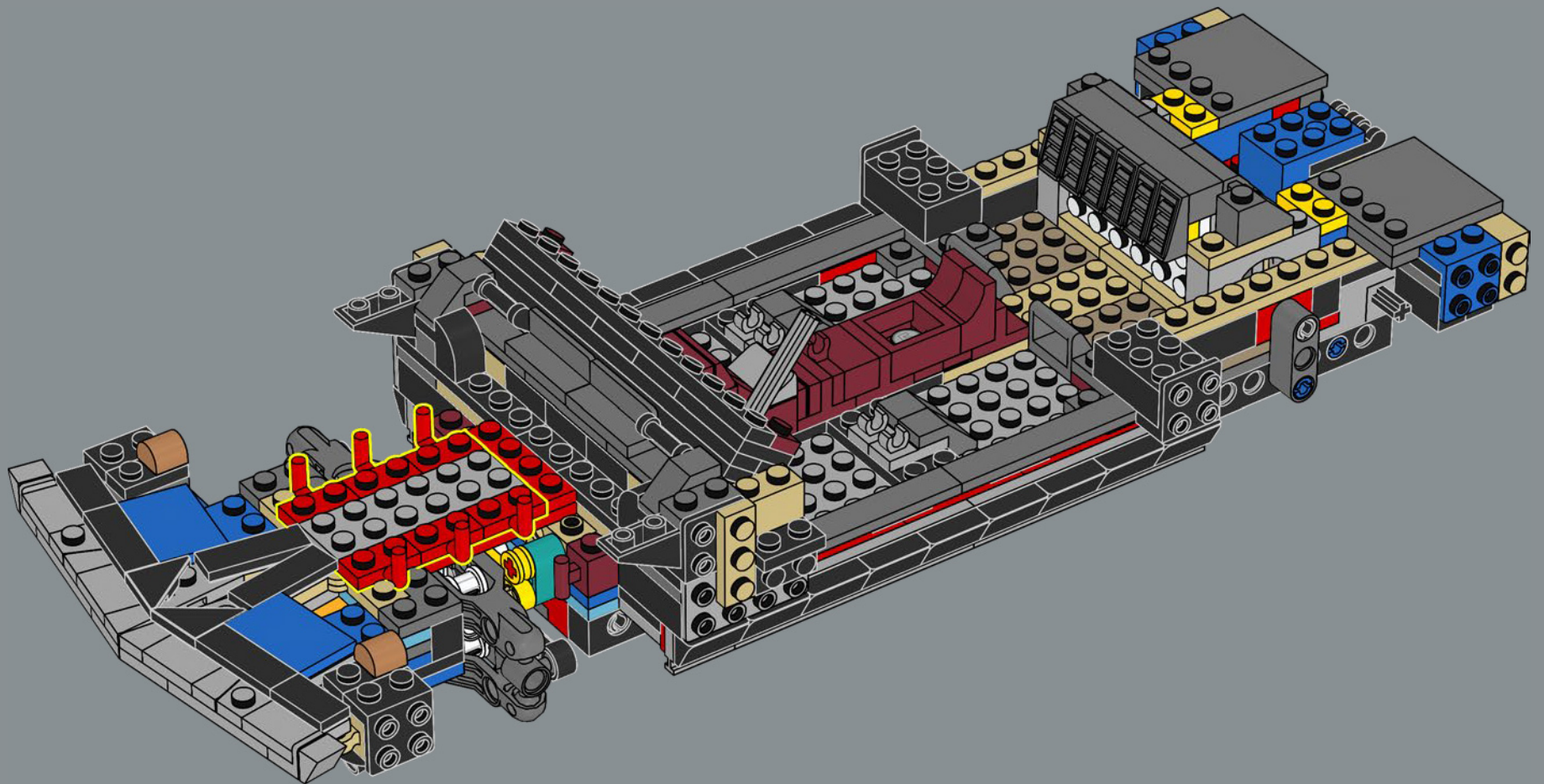

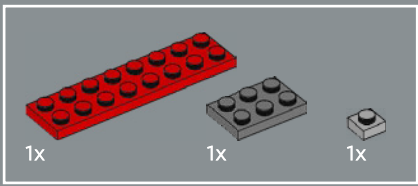

127

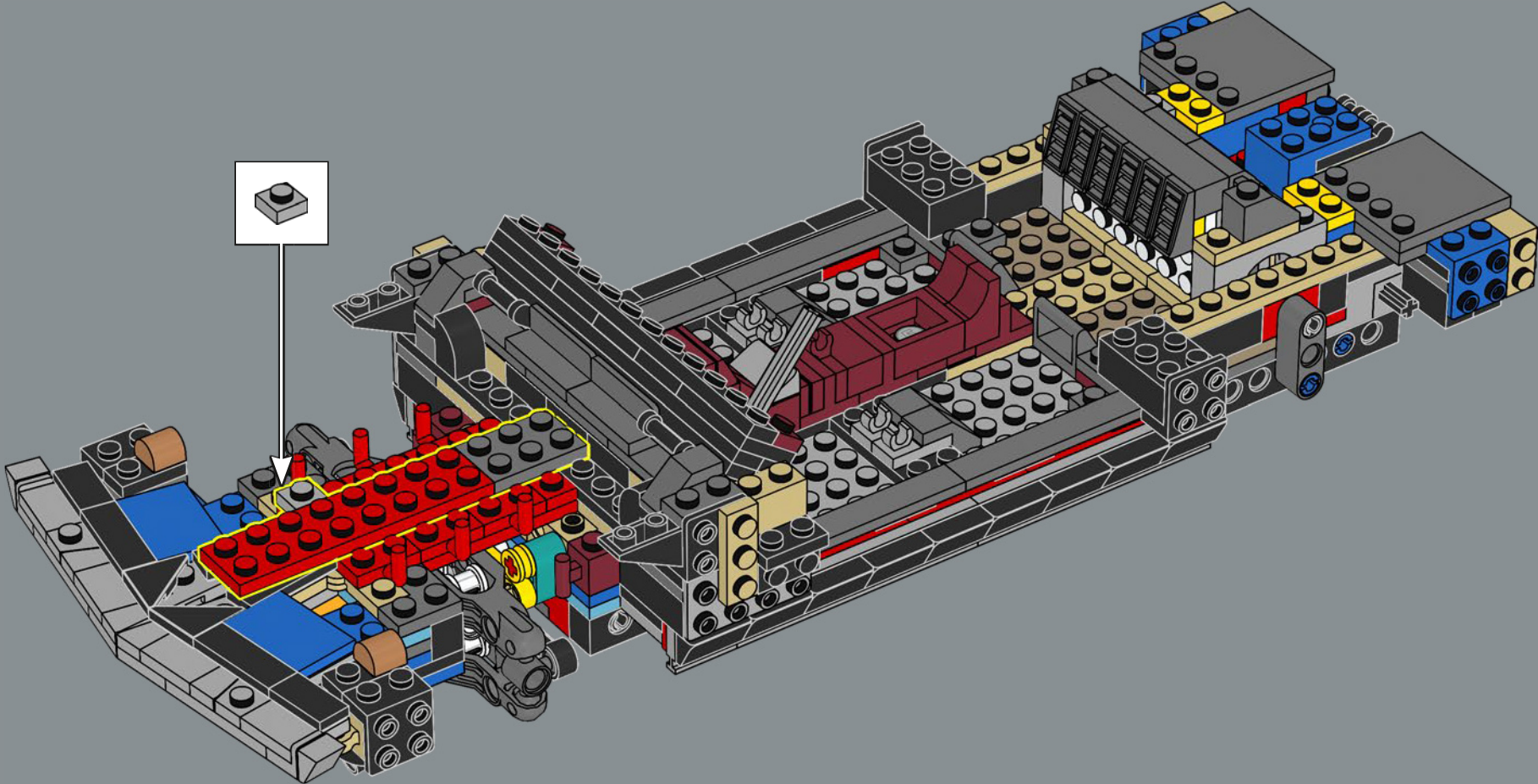

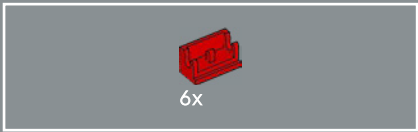

128

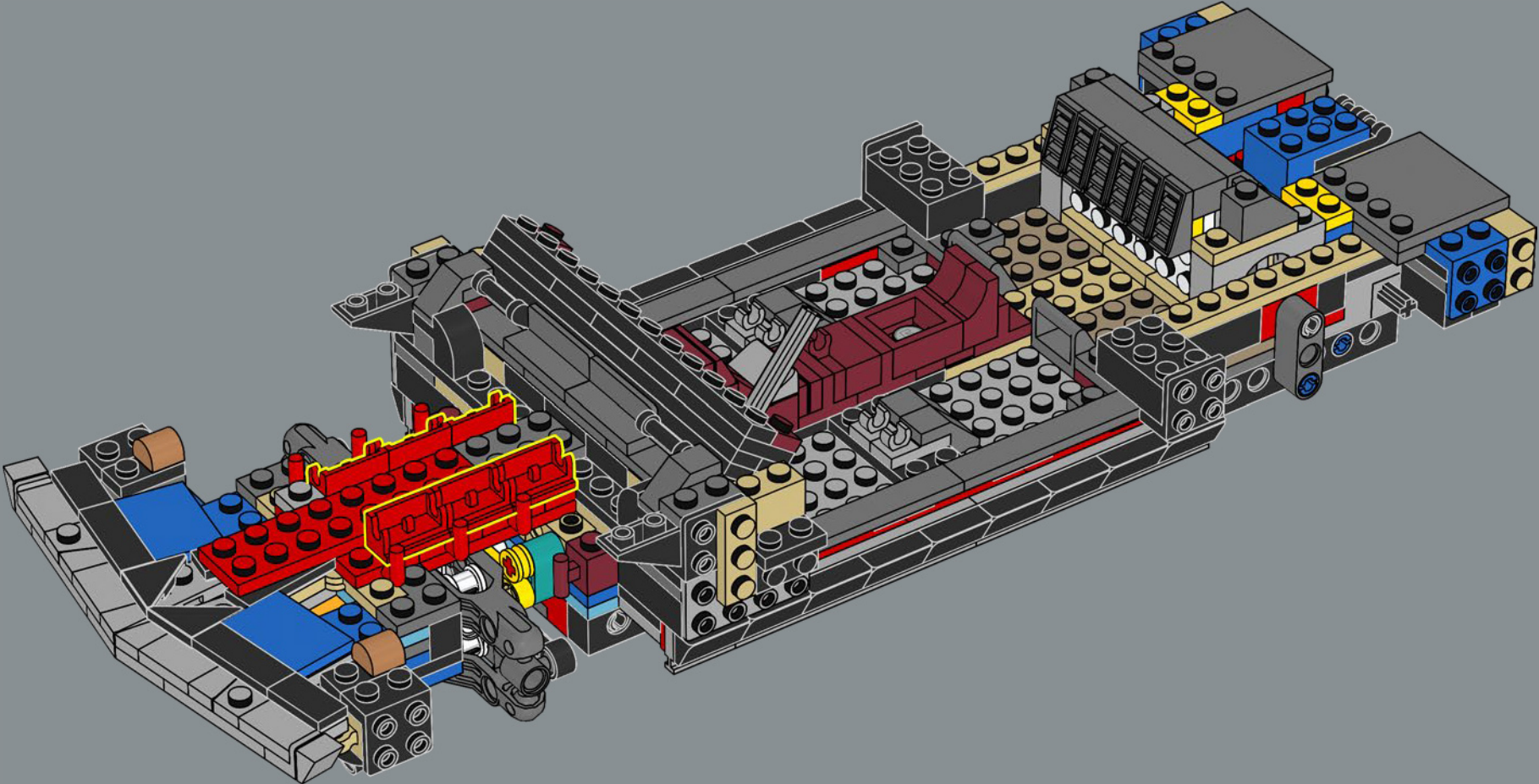

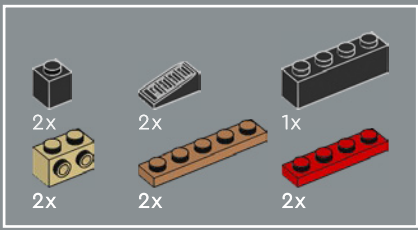

129

1

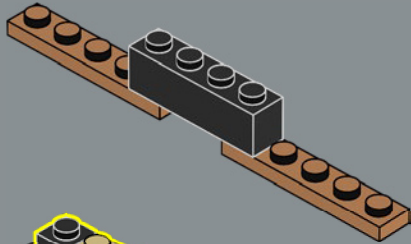

2

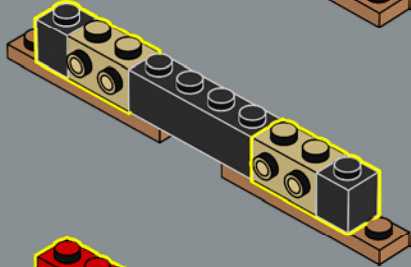

3

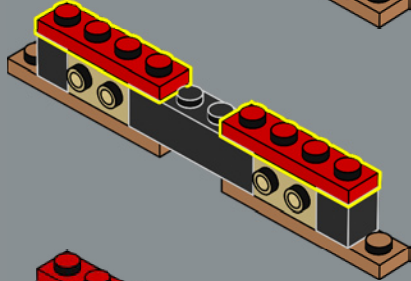

4

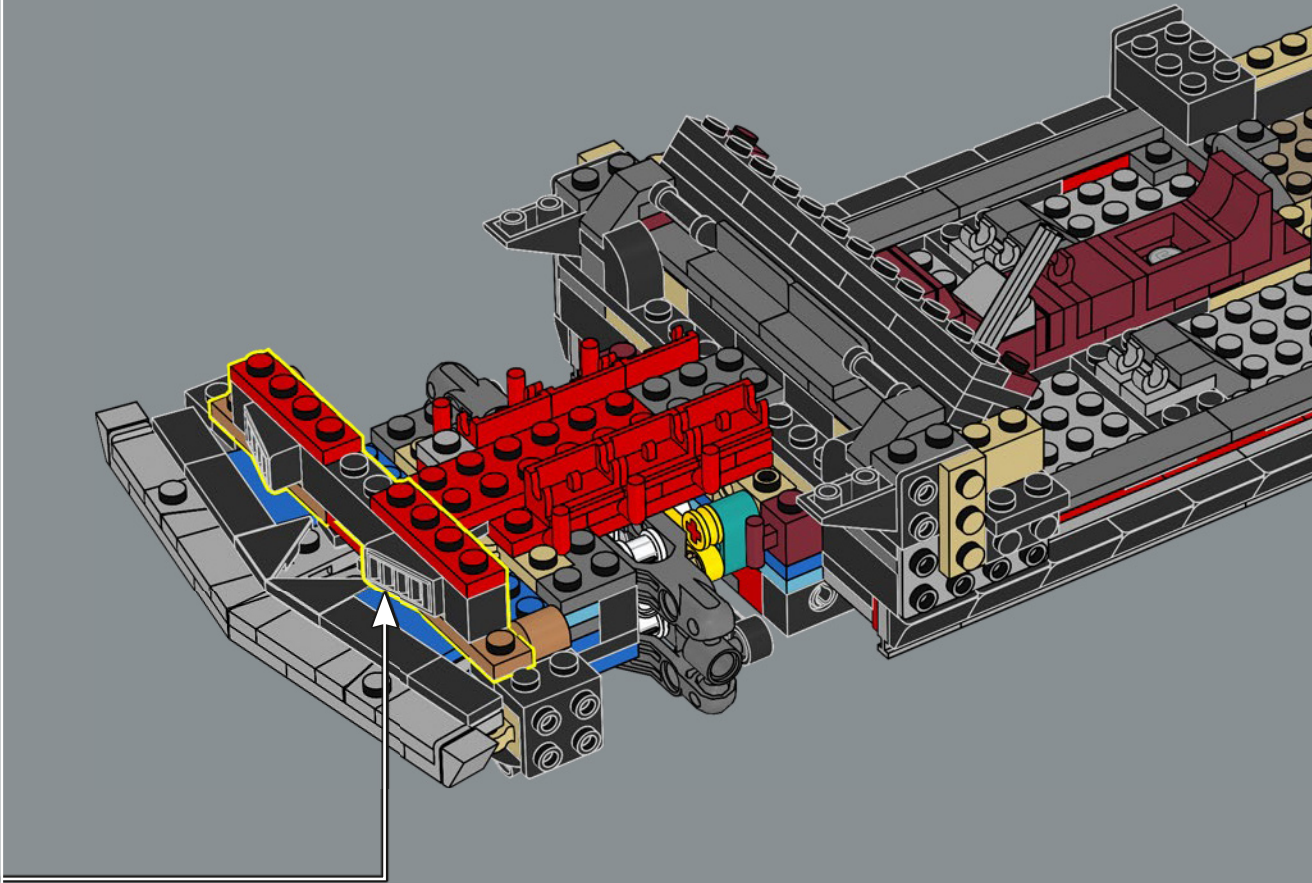
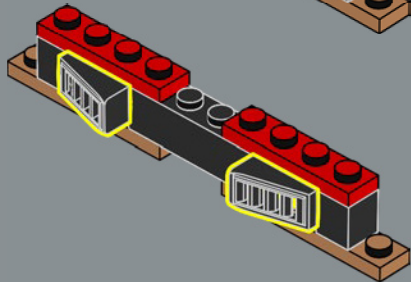

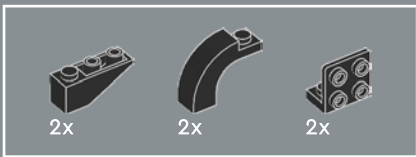

130

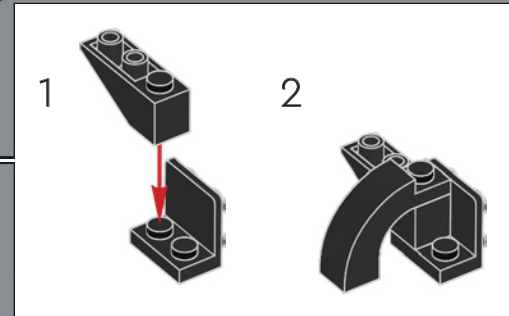
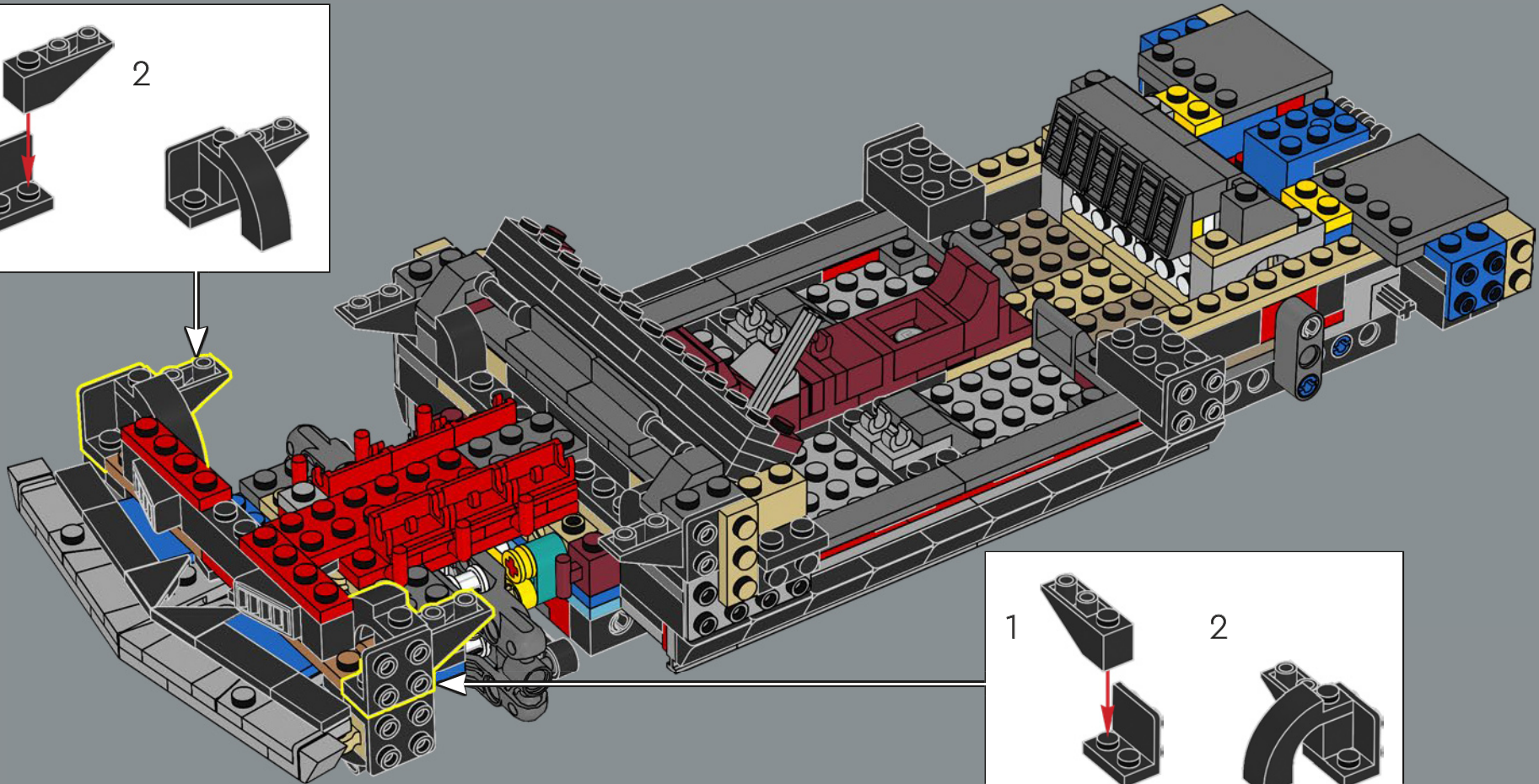
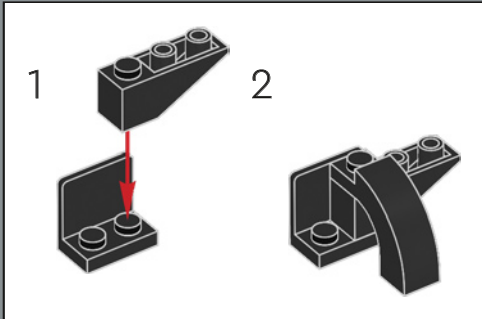

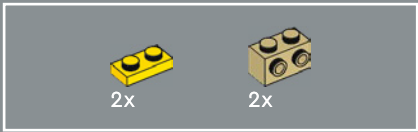

131

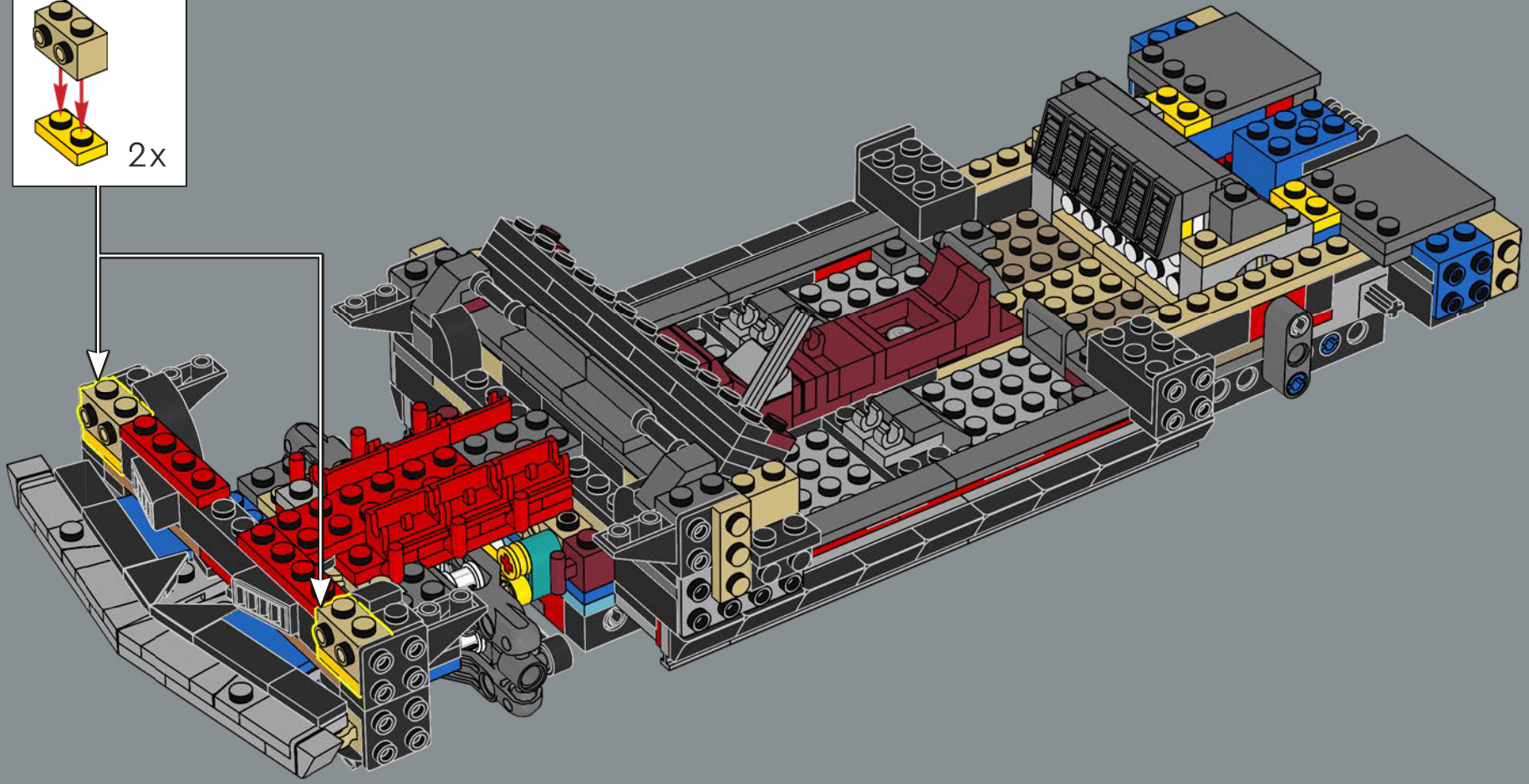
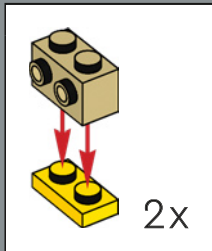

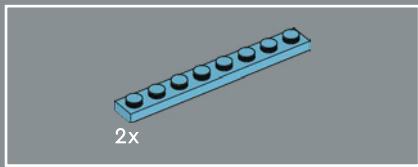

132

Die Enthüllung des Chevrolet Camaro vor
Pressevertretern im Jahr 1966 war die erste große
Telefonkonferenz der Welt, der sich 200 Journalisten
aus 14 Städten in den USA zuschalteten.

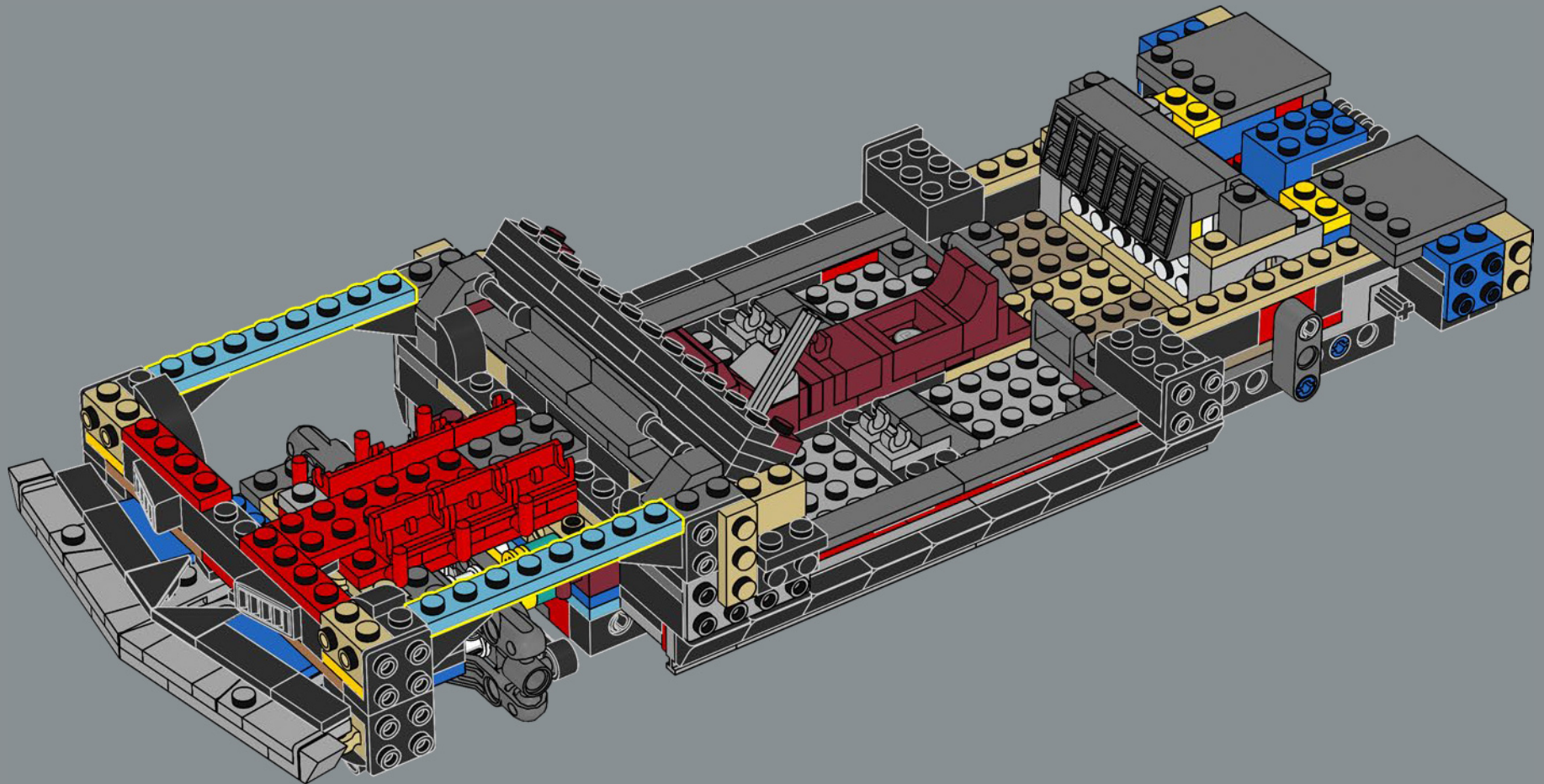



133

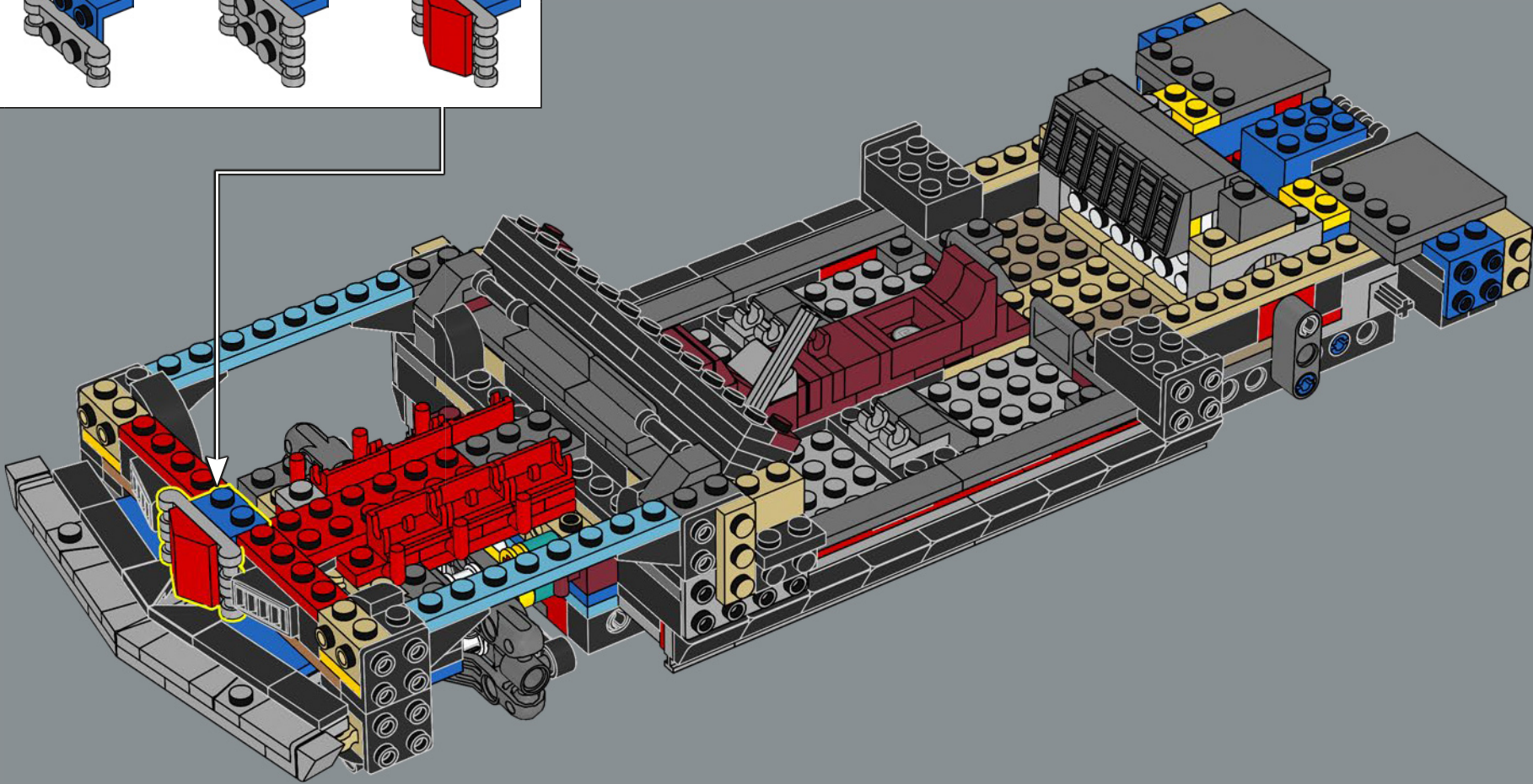
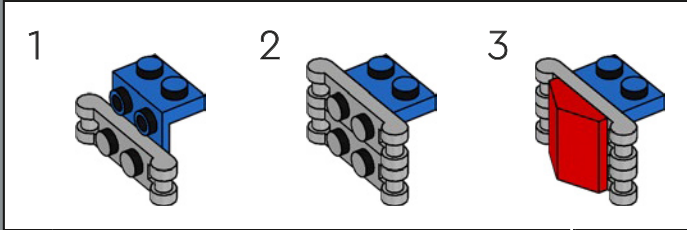



134

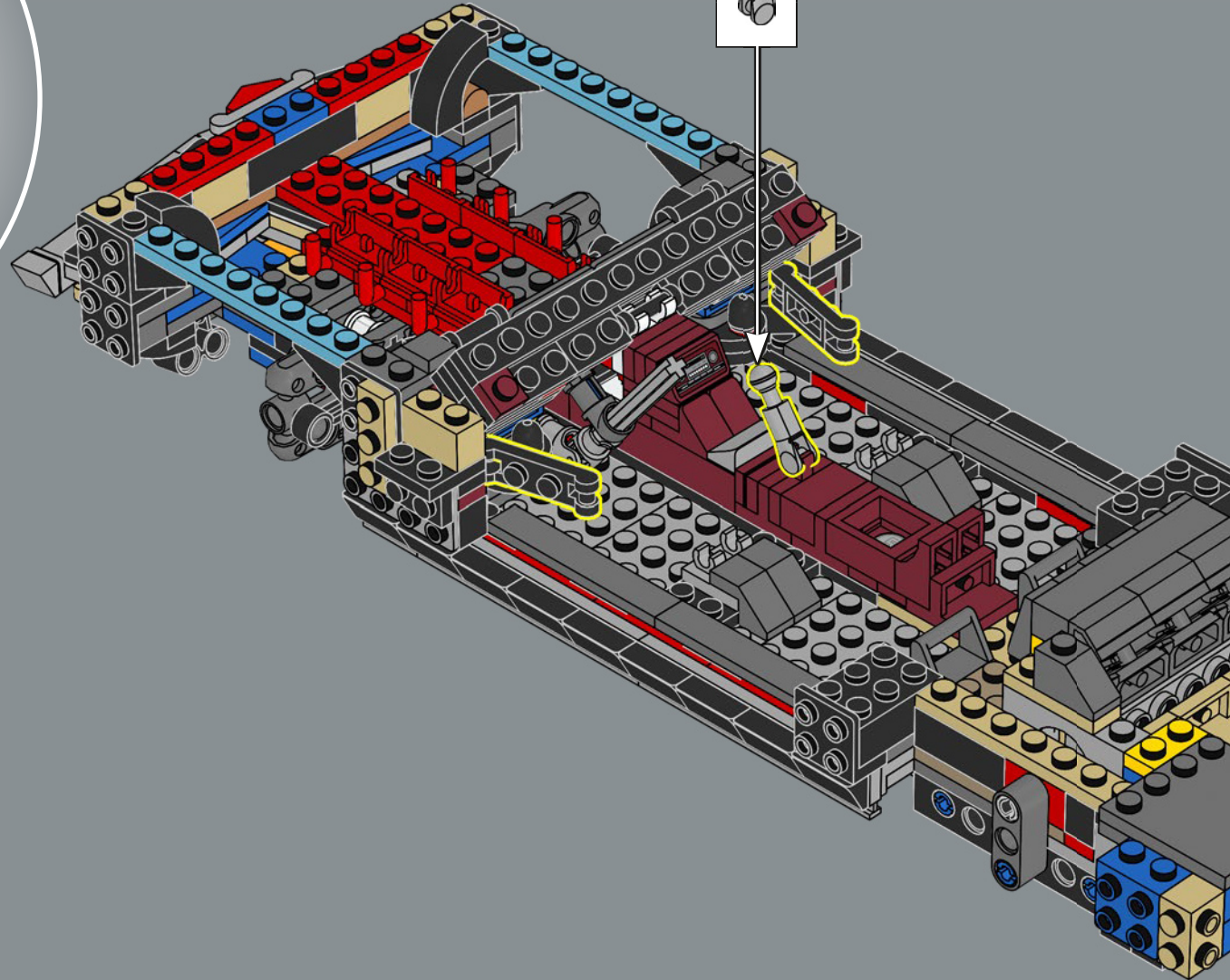
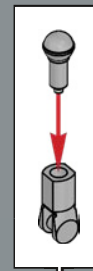

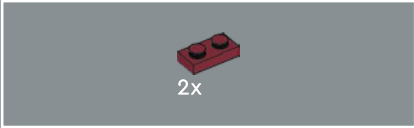
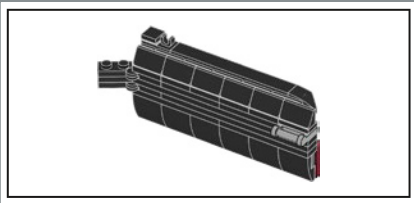

135

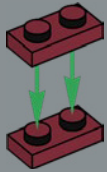

136



137

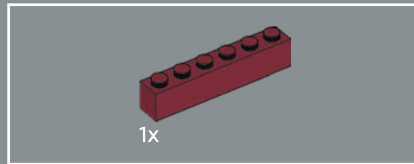
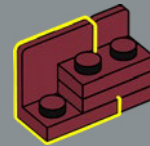

138

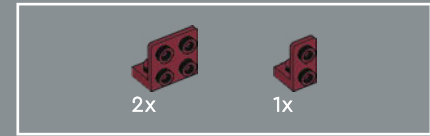
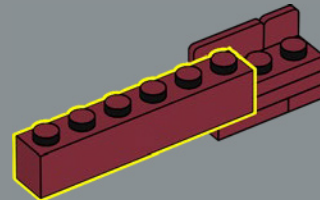

139

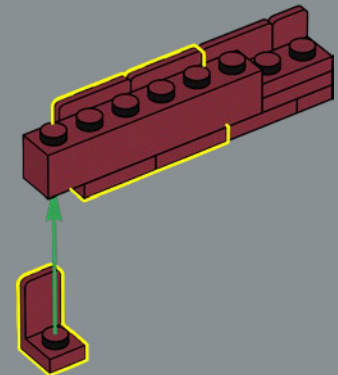



140

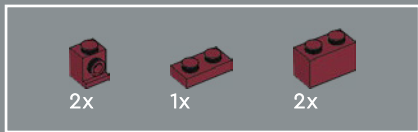
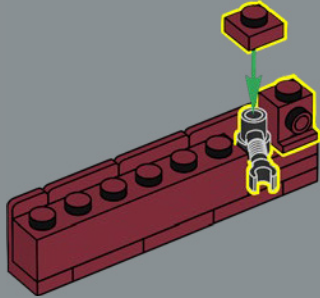

141

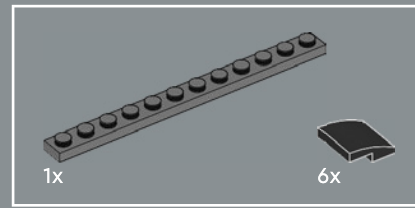
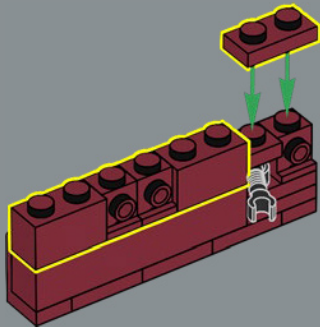

142

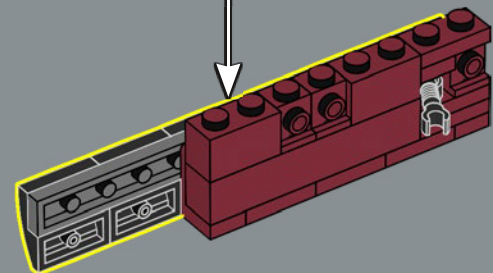
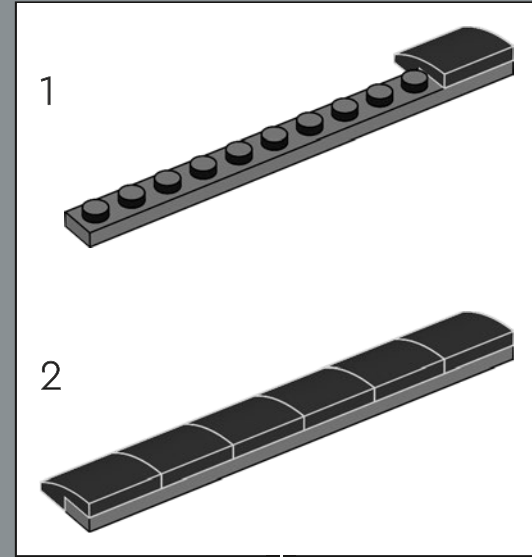

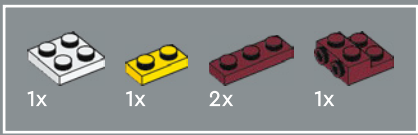

143

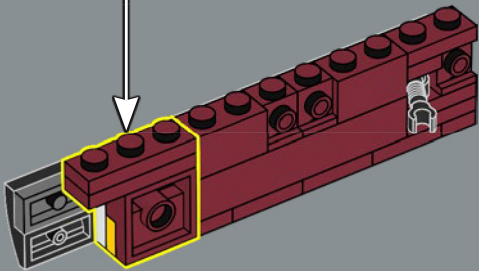
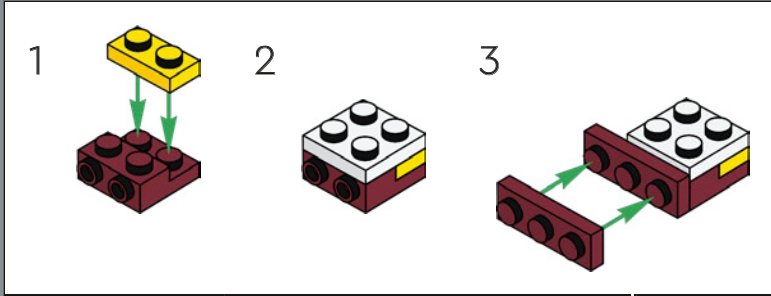

144

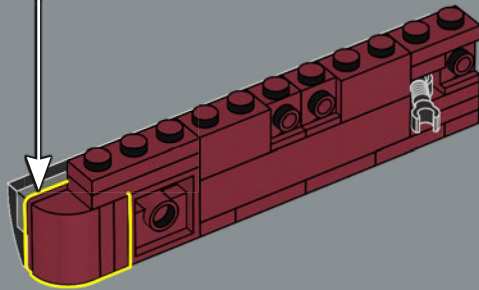
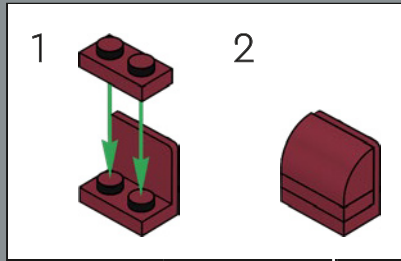

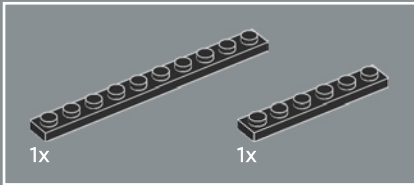
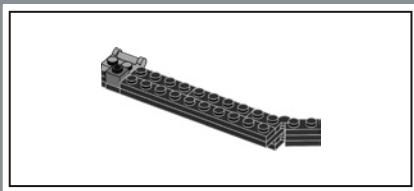

145

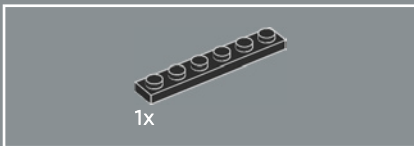
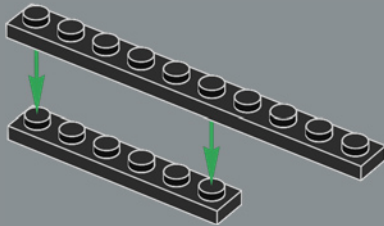

146

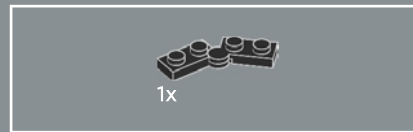
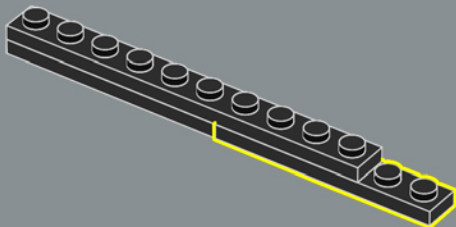

147

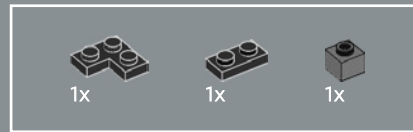
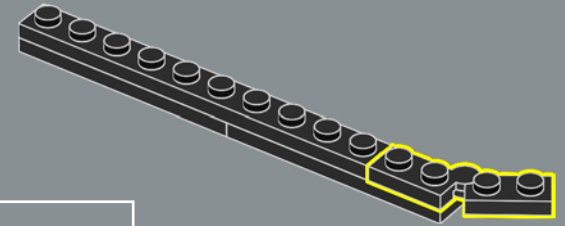

148

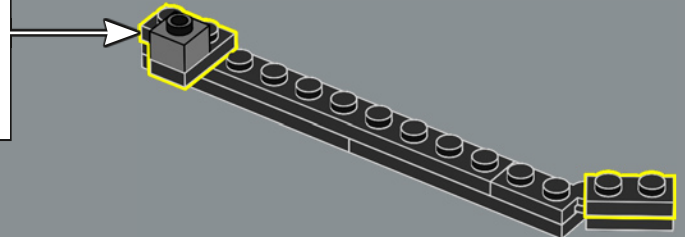
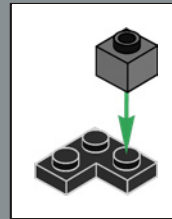

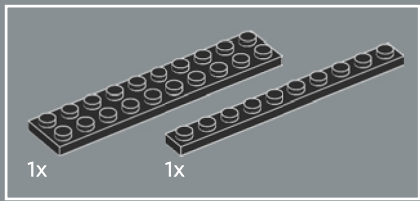

149

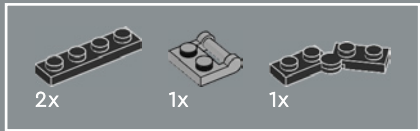
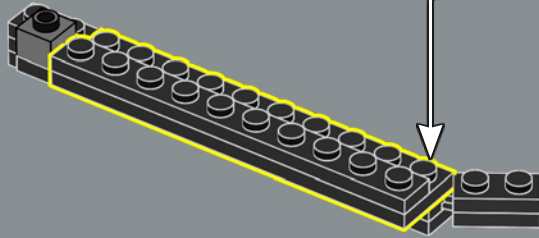
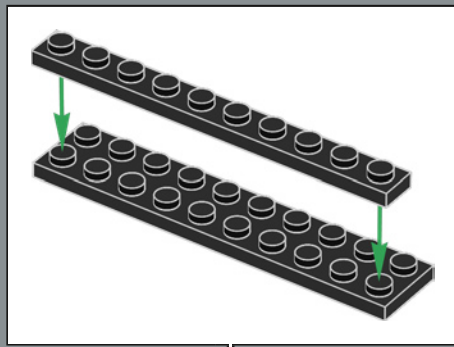

150

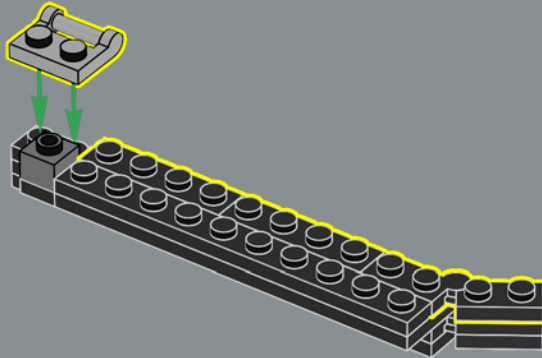

151

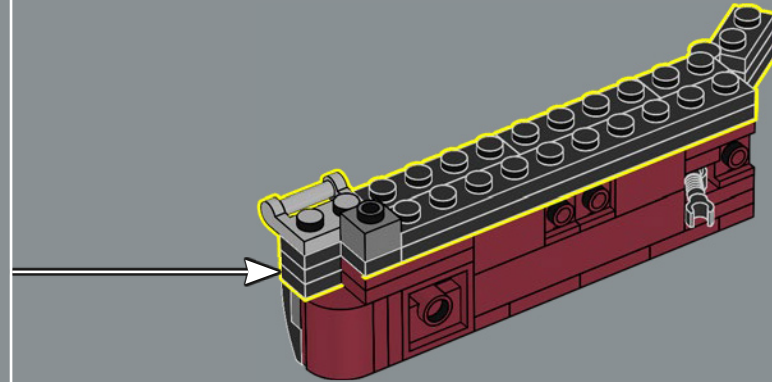



152

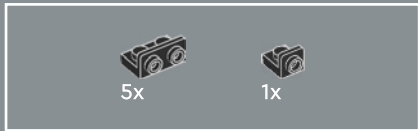
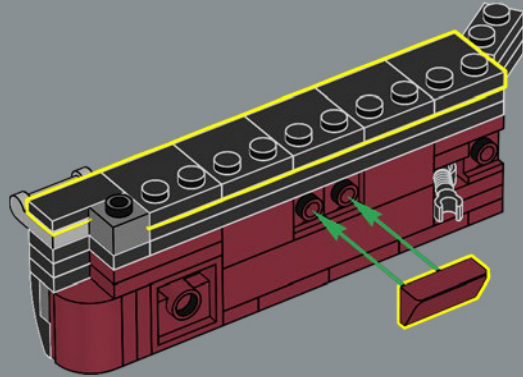

153

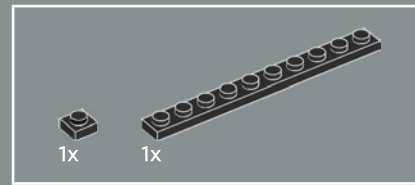
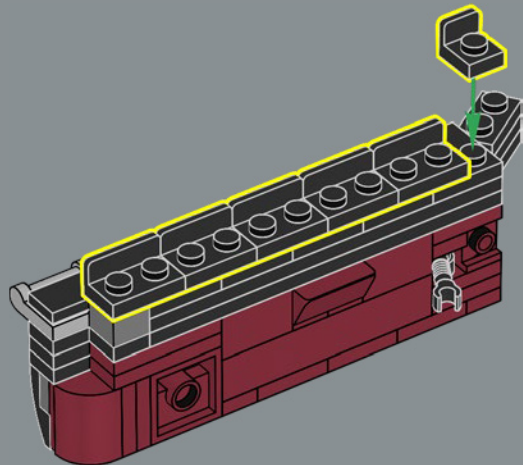

154

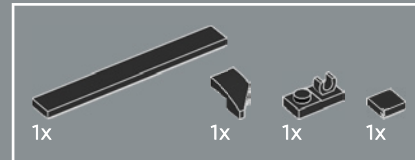
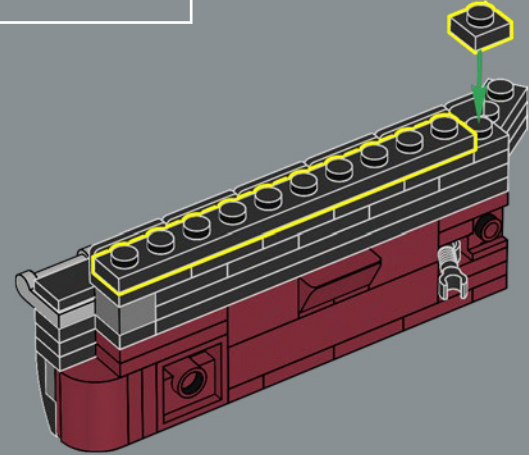

155

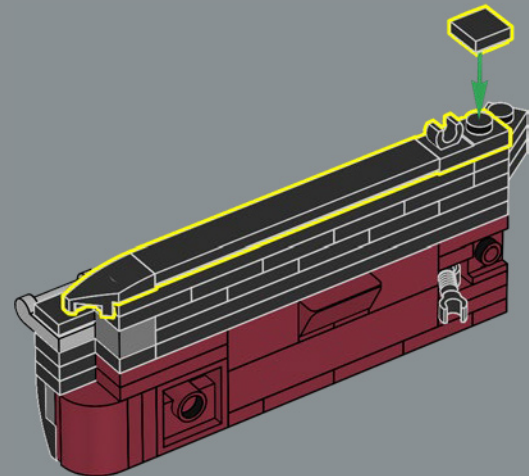



6x

156

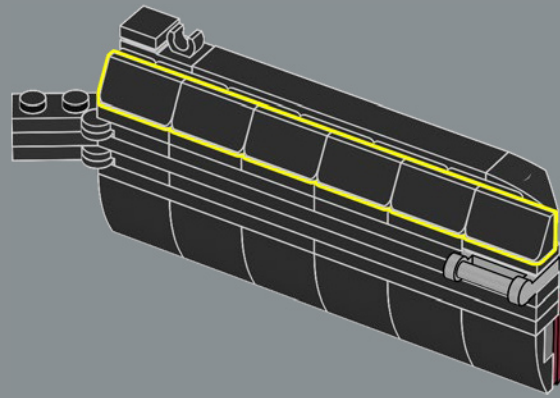

157

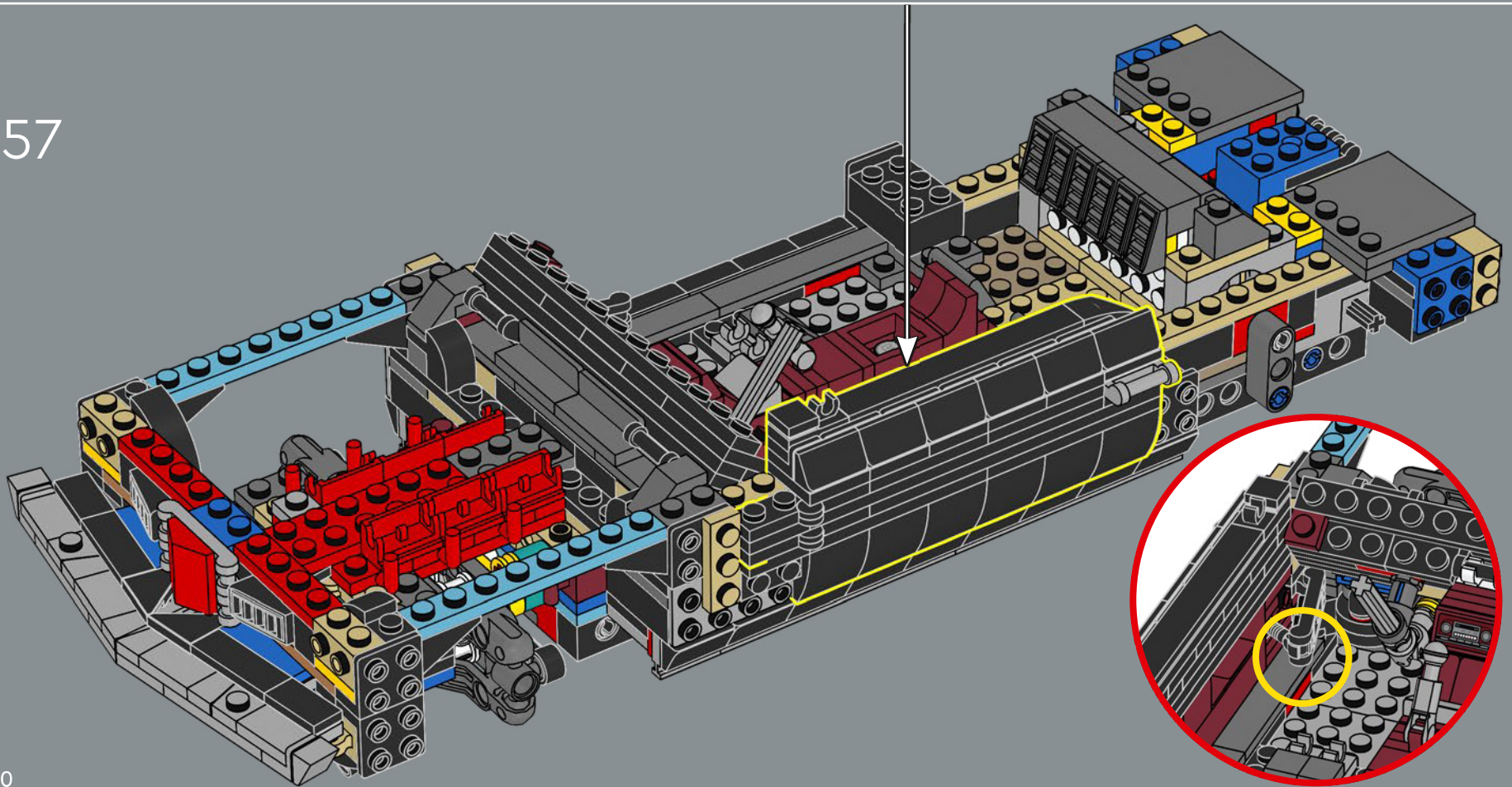



158

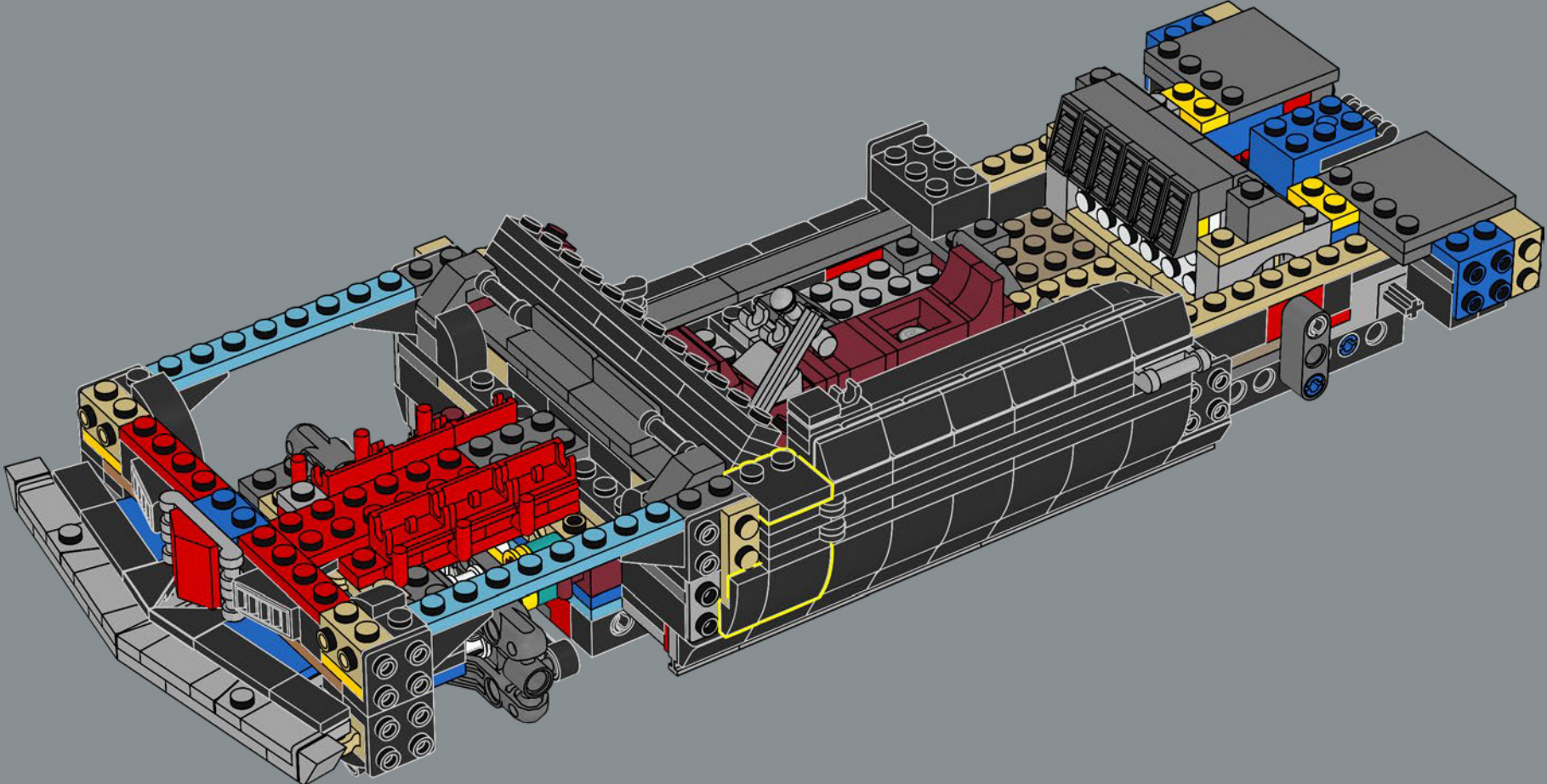

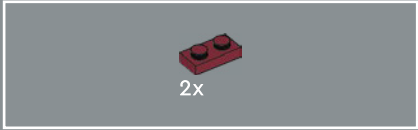
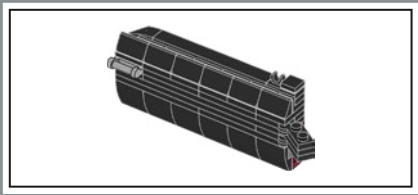

159

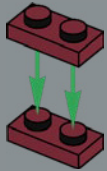

160

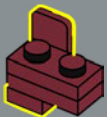

161

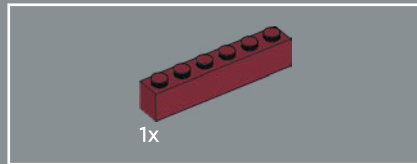
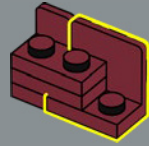

162

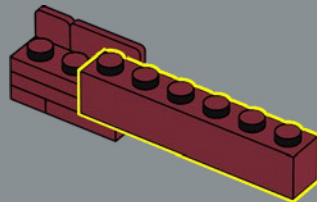

163

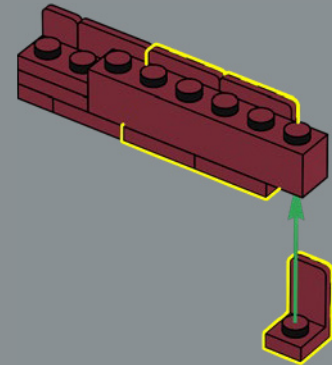



164

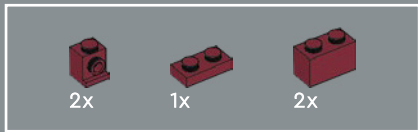
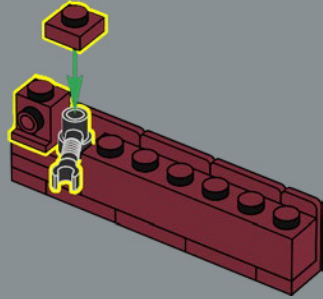

165

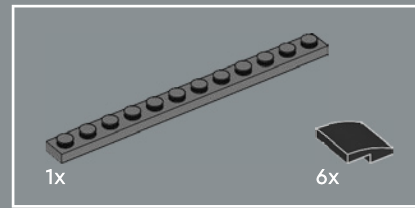
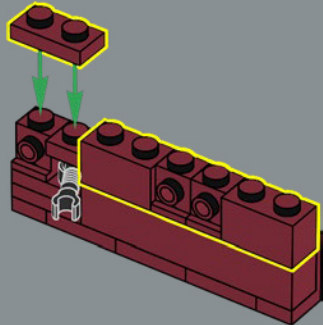

166

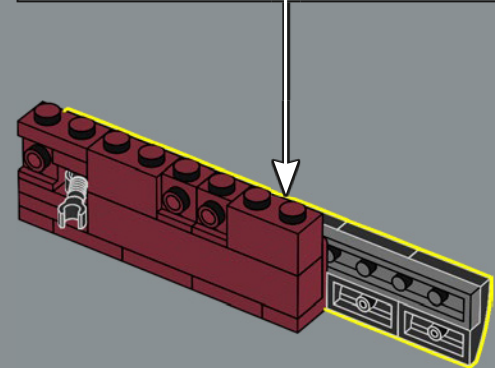
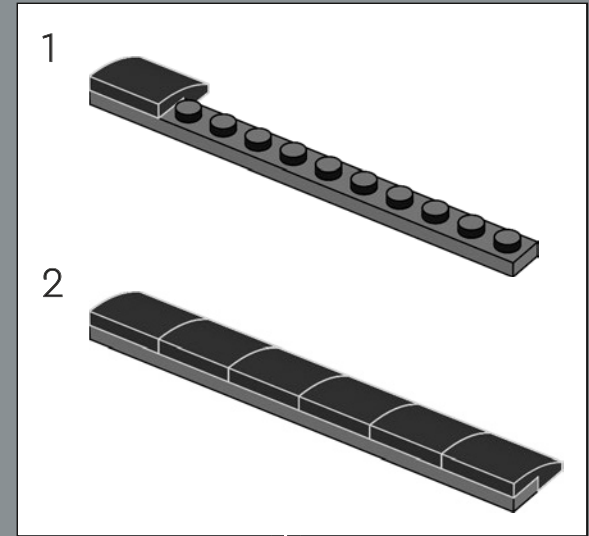

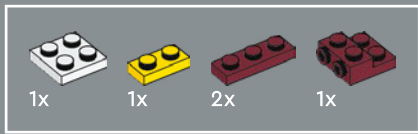

167

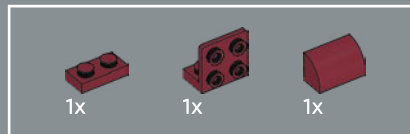
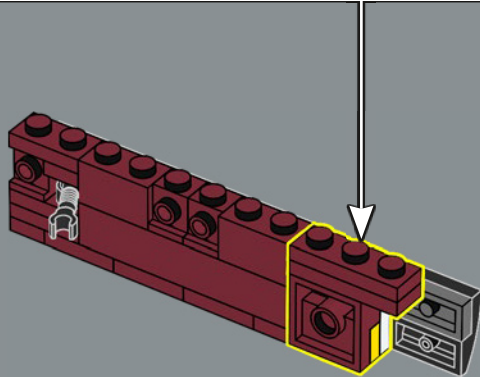
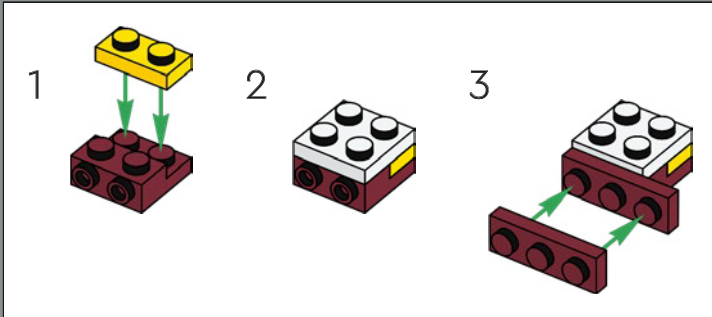

168

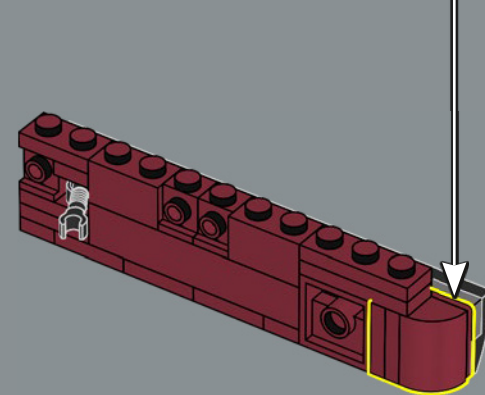
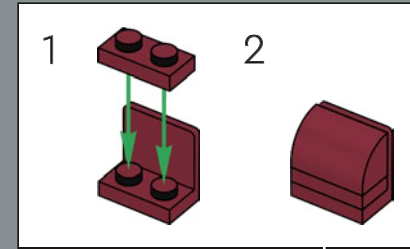

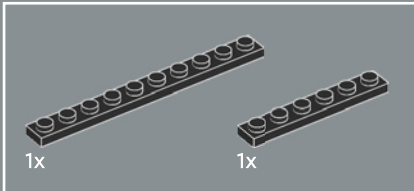
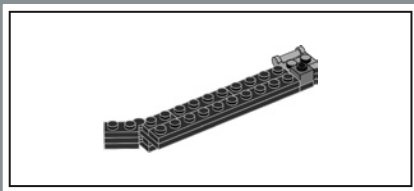

169

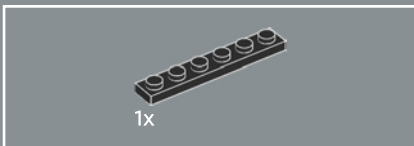
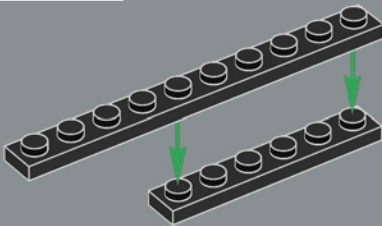

170

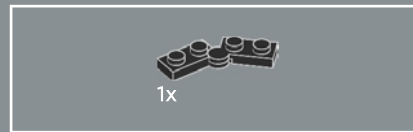
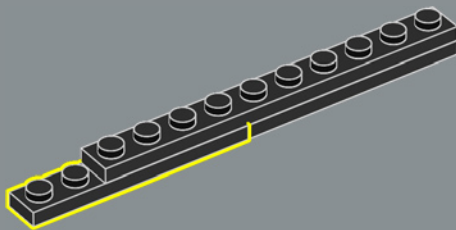

171

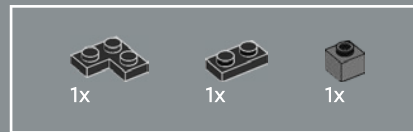
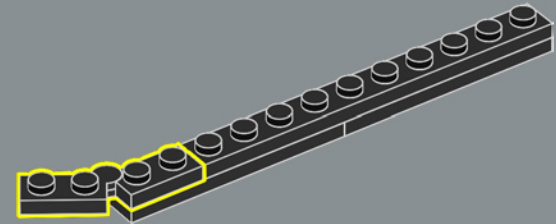

172

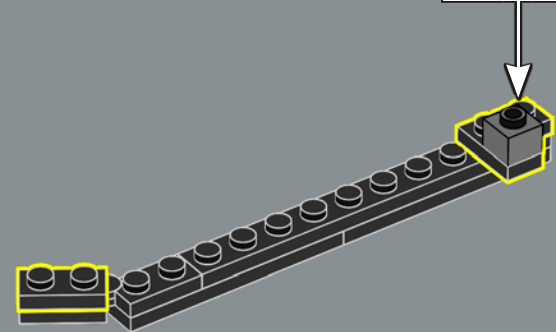
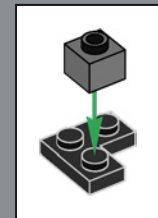

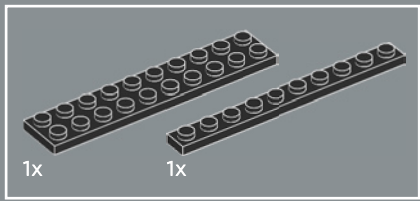

173

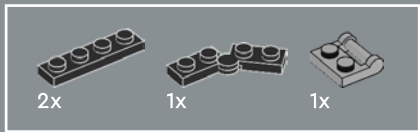
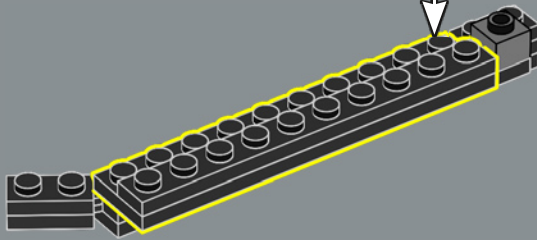
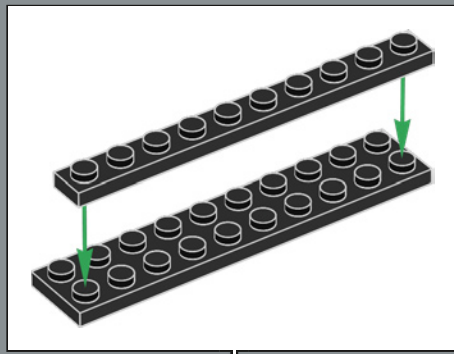

174

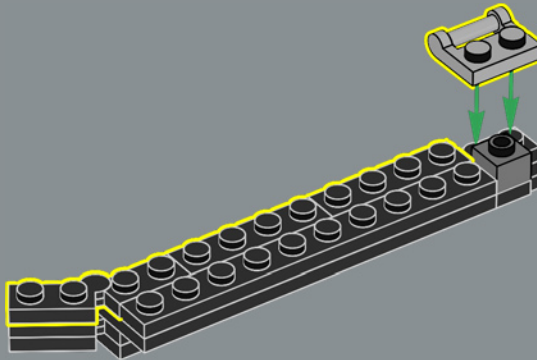

175

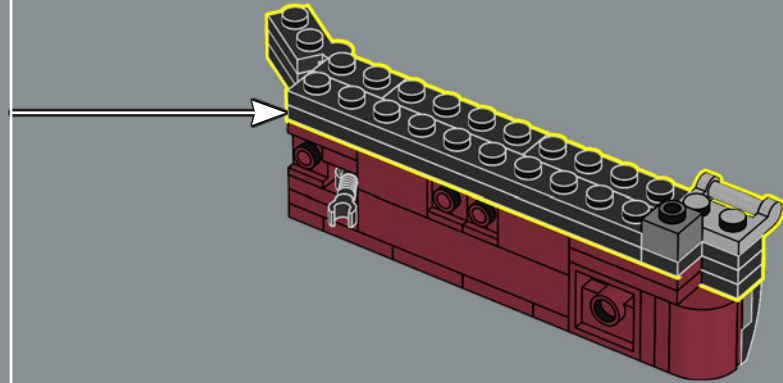

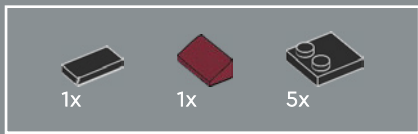

176

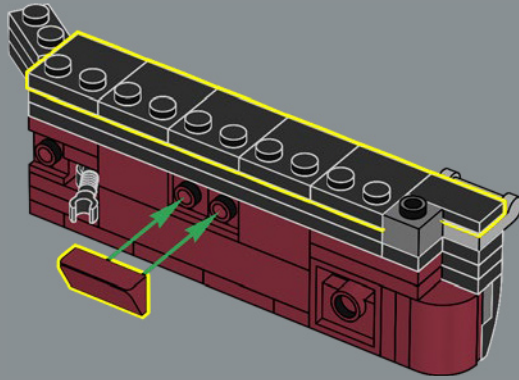

177

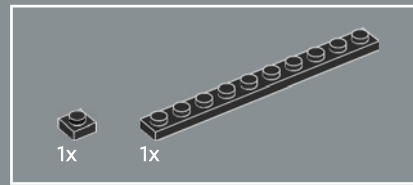
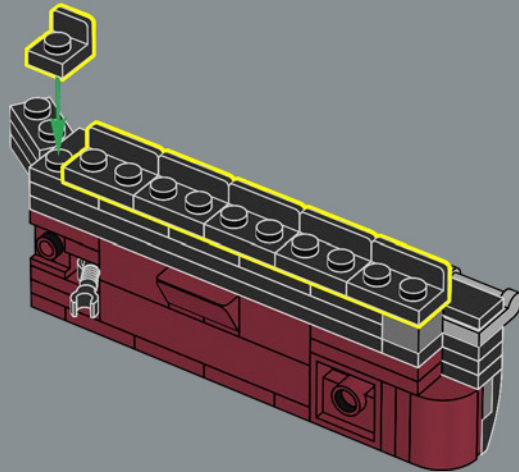

178

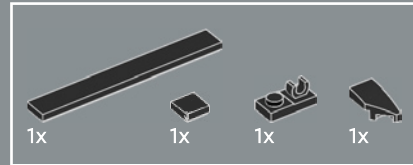
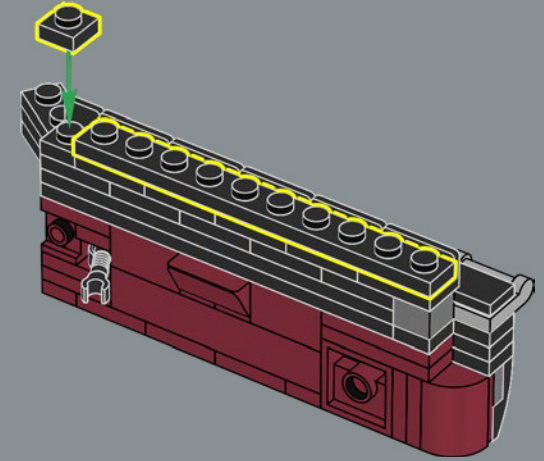

179

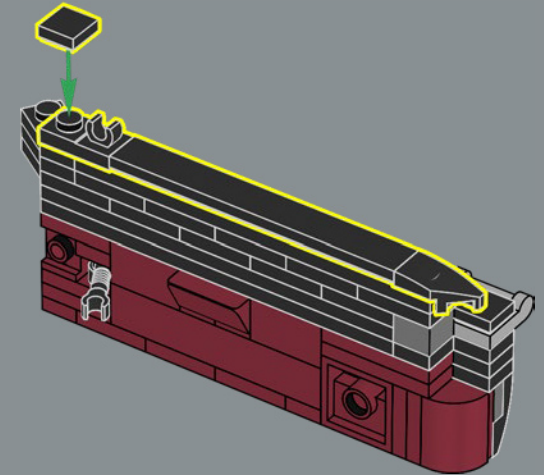



6x

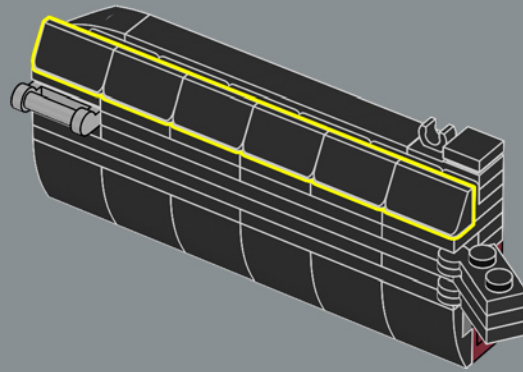

180

181

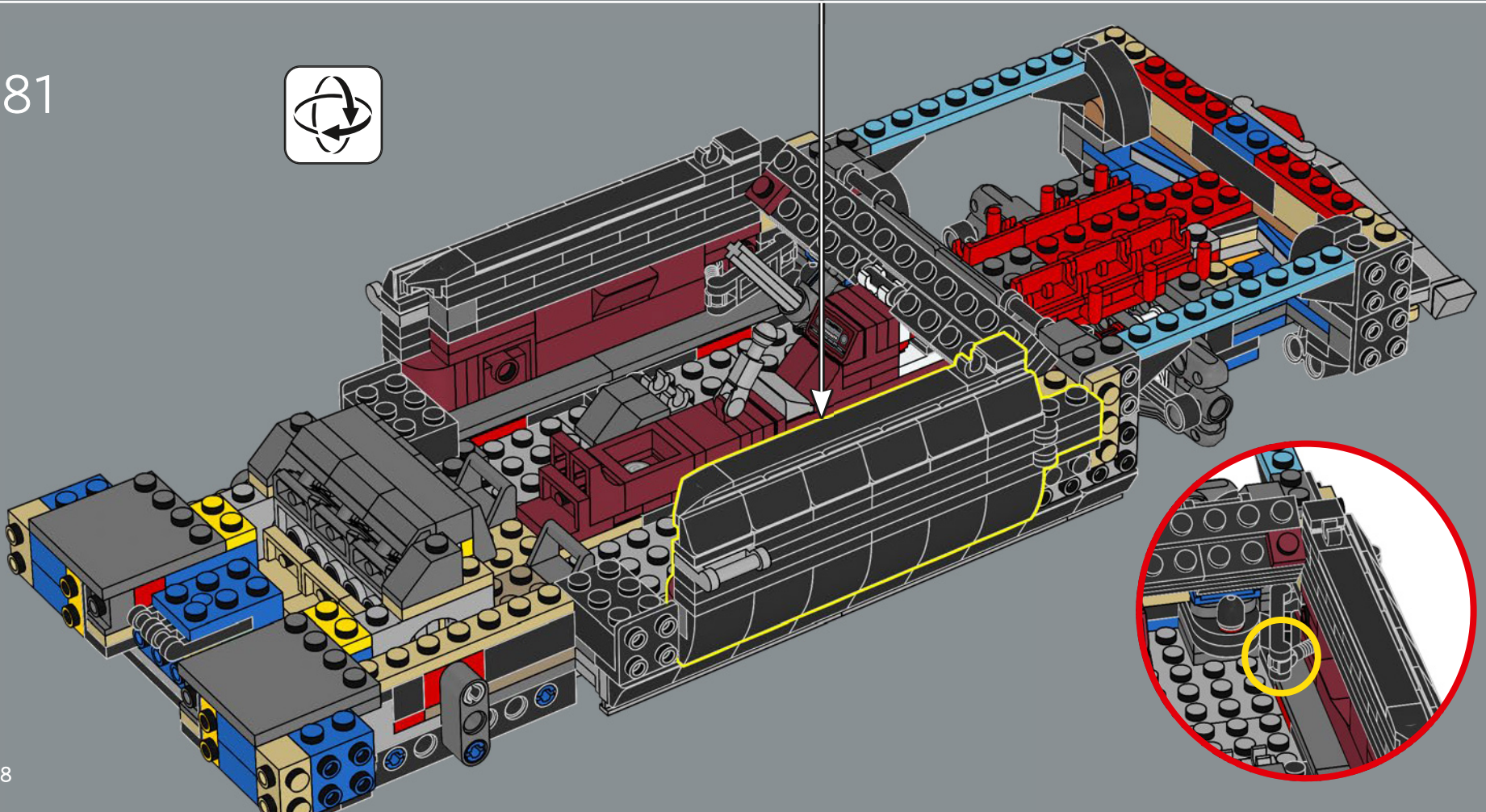



Je nach Modell und Ausstattungspaket konnten die Käufer des Original-Camaro bis zu 80 verschiedene Werksoptionen auswählen.

182

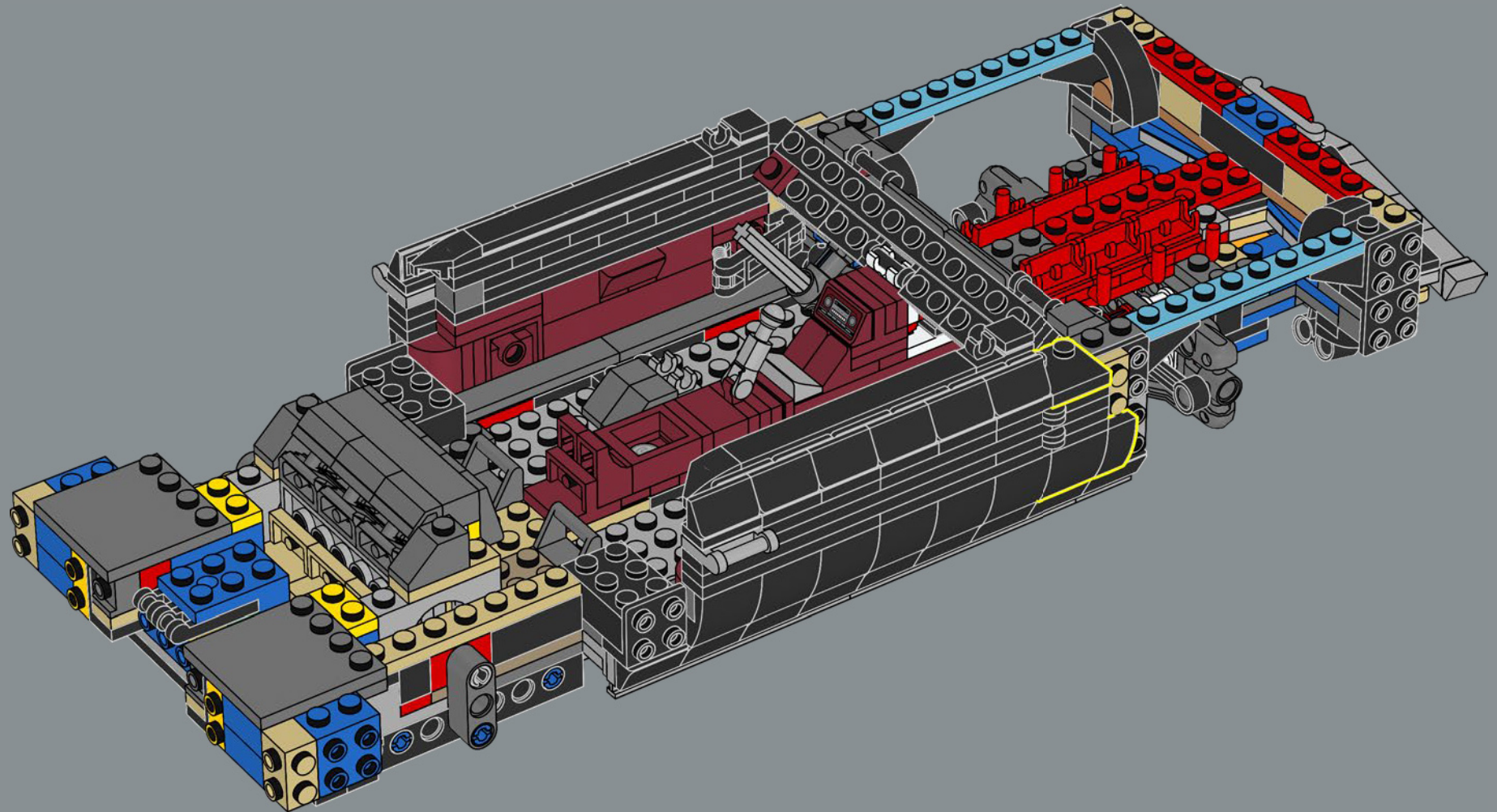

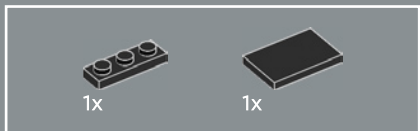

183

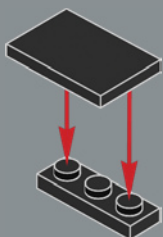

184

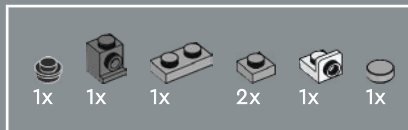
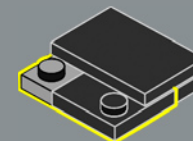

185

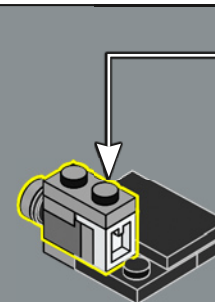
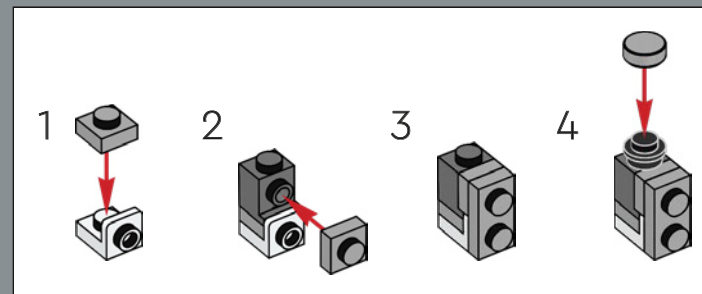

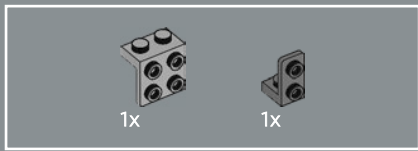

186

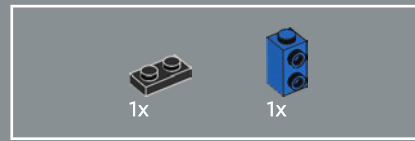
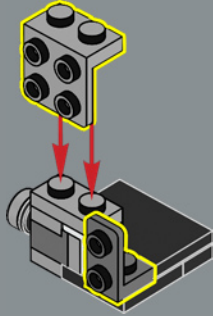

187

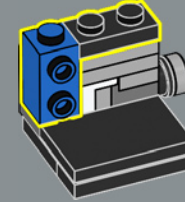

188

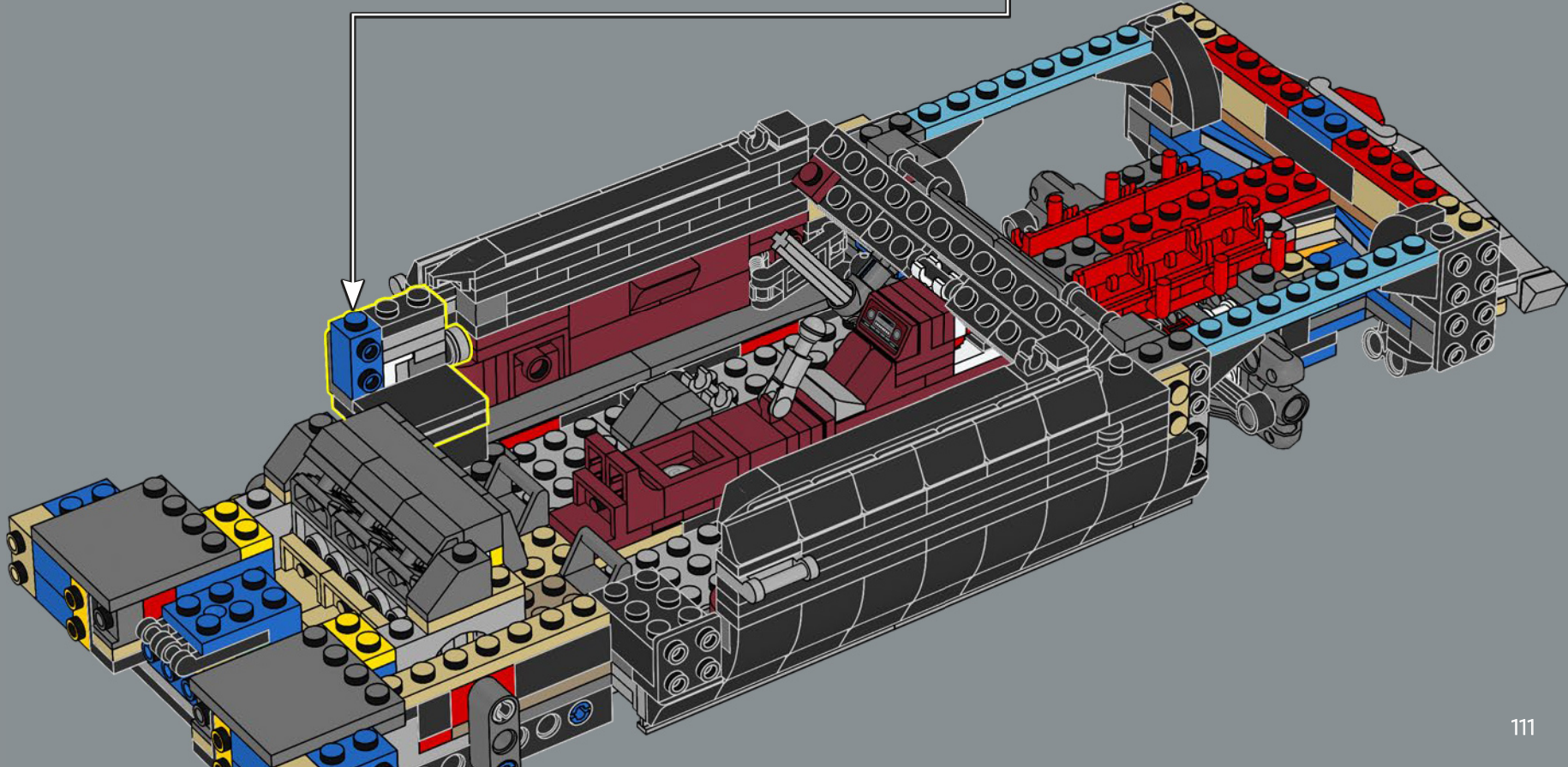

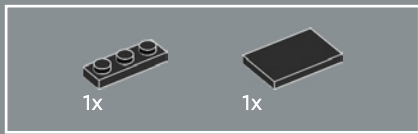

189

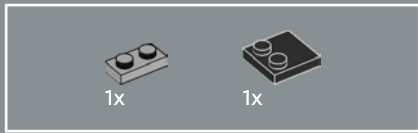
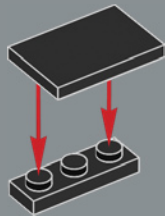

190

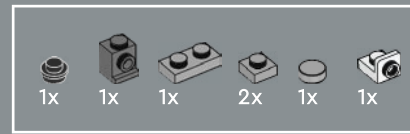
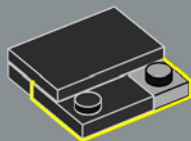

191

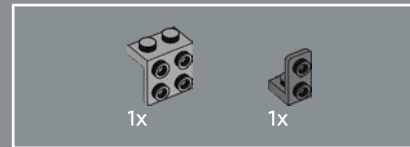
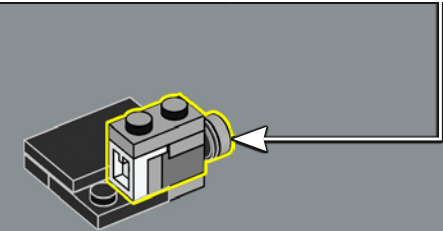
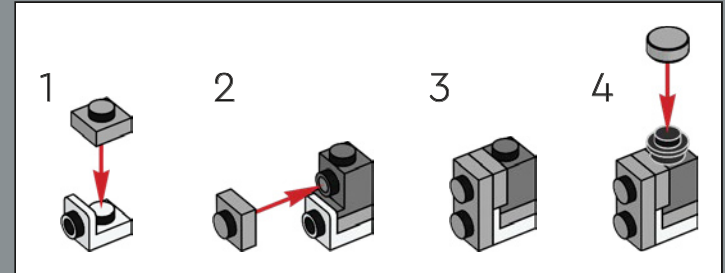

192

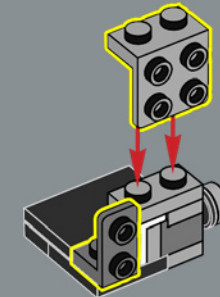

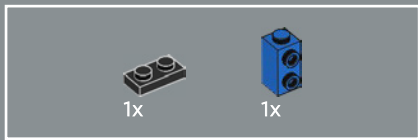

193

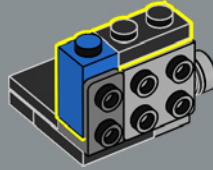

194

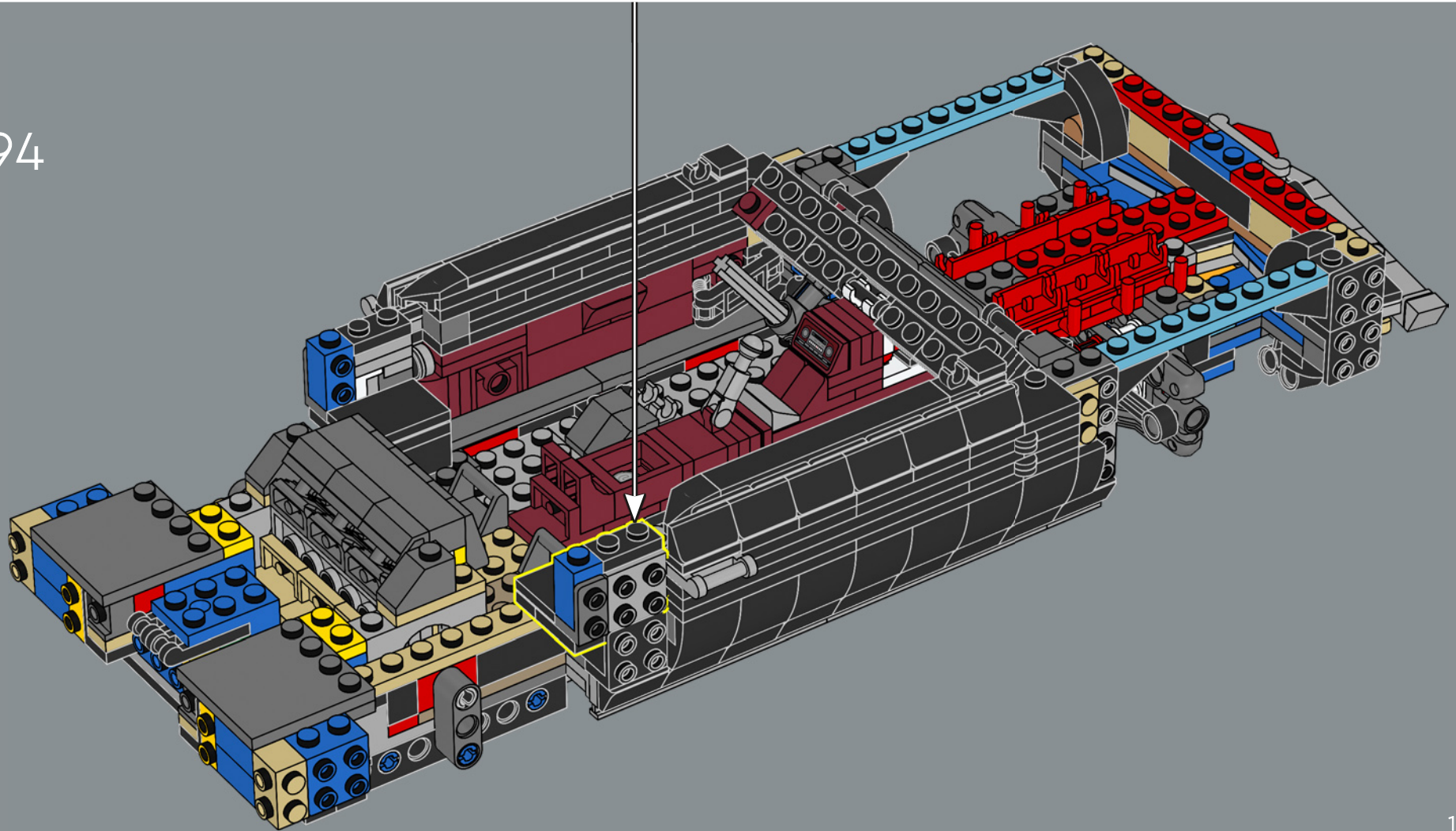

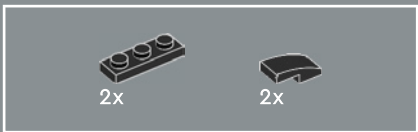

195

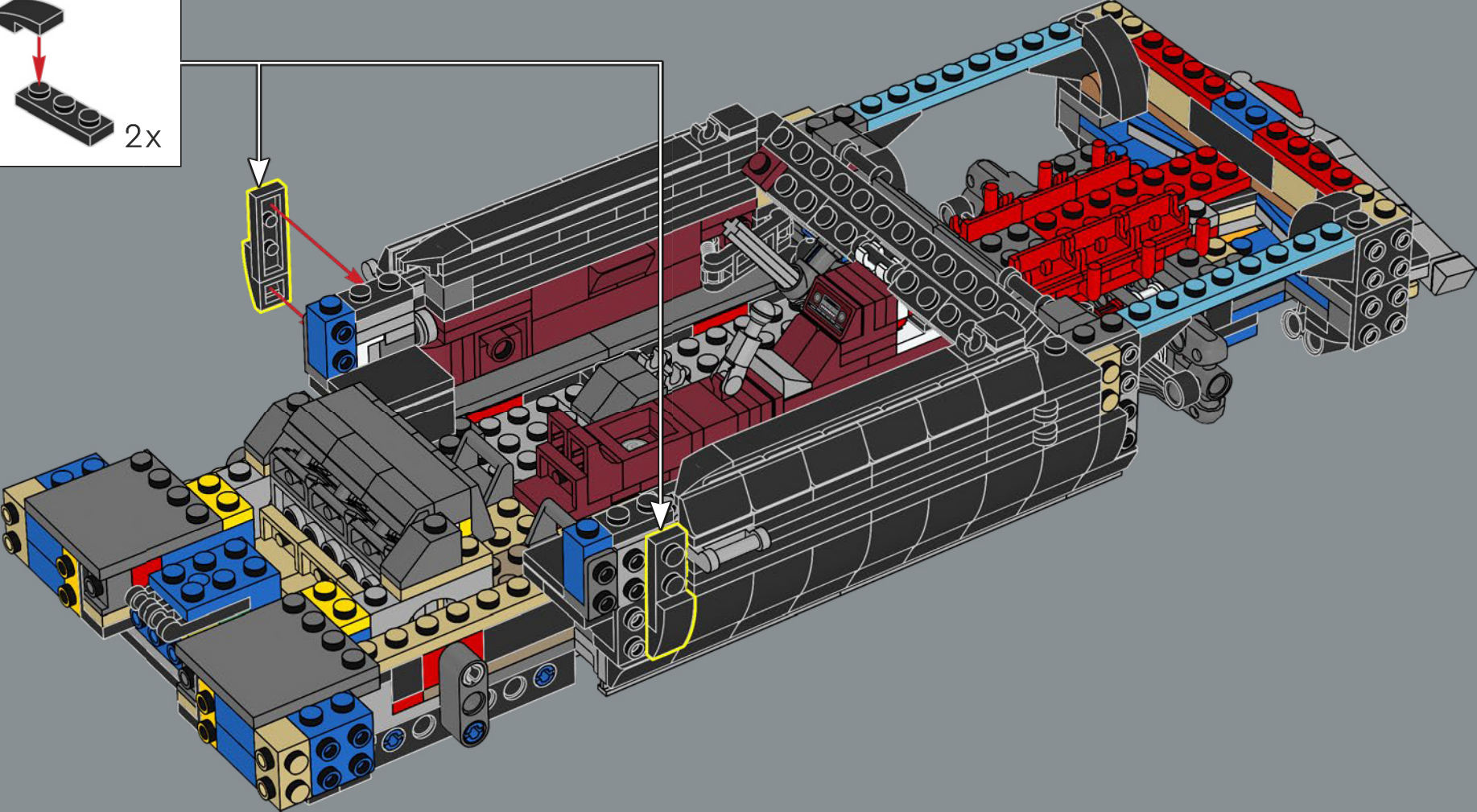
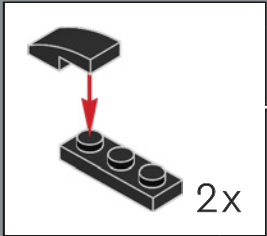

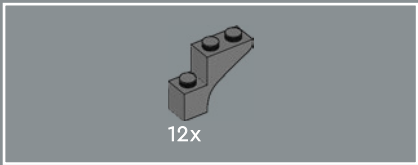

196

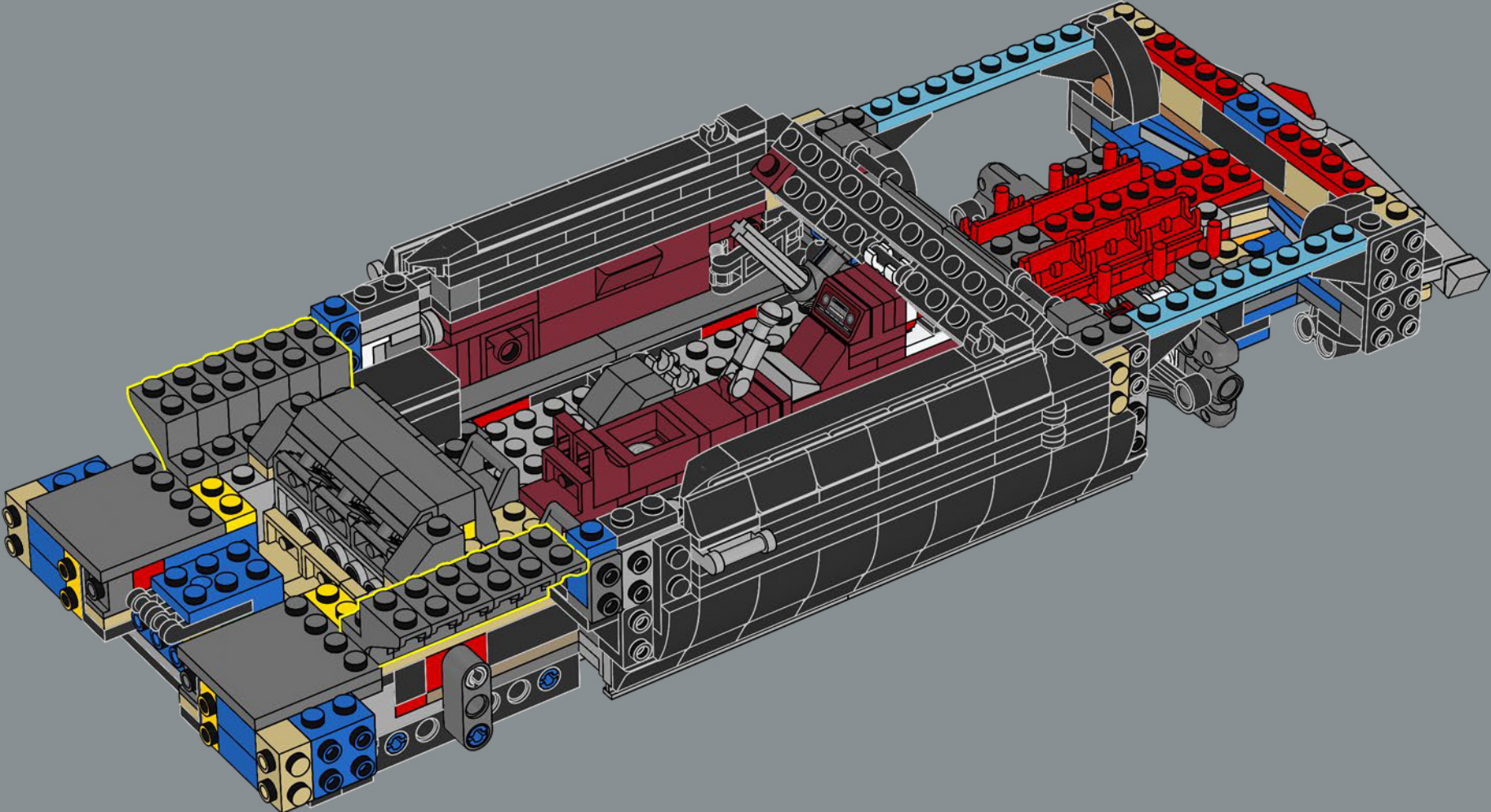

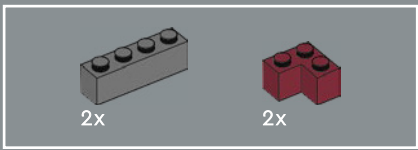

197

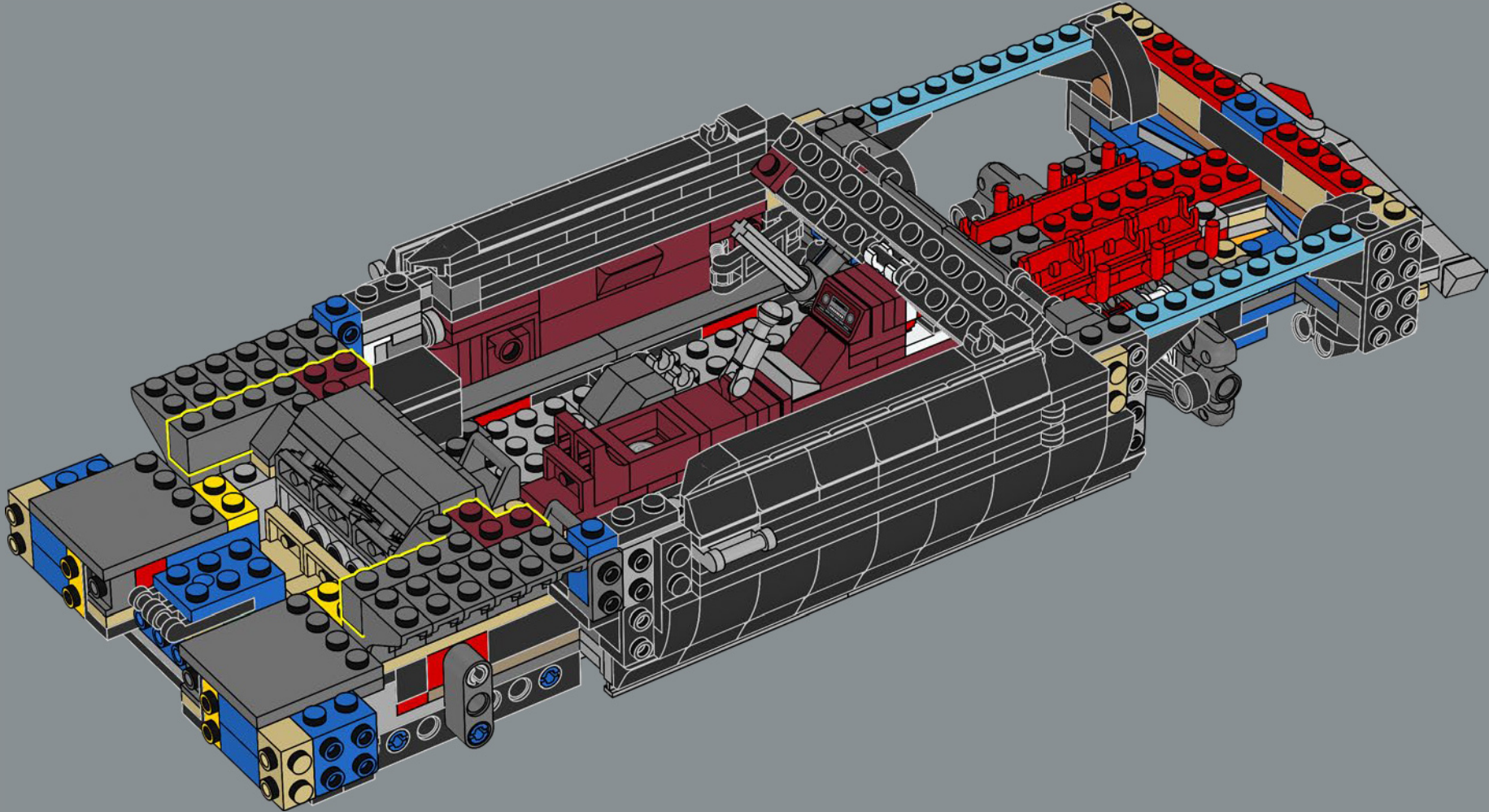

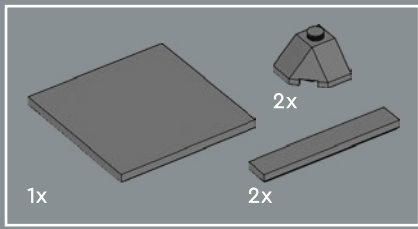

198

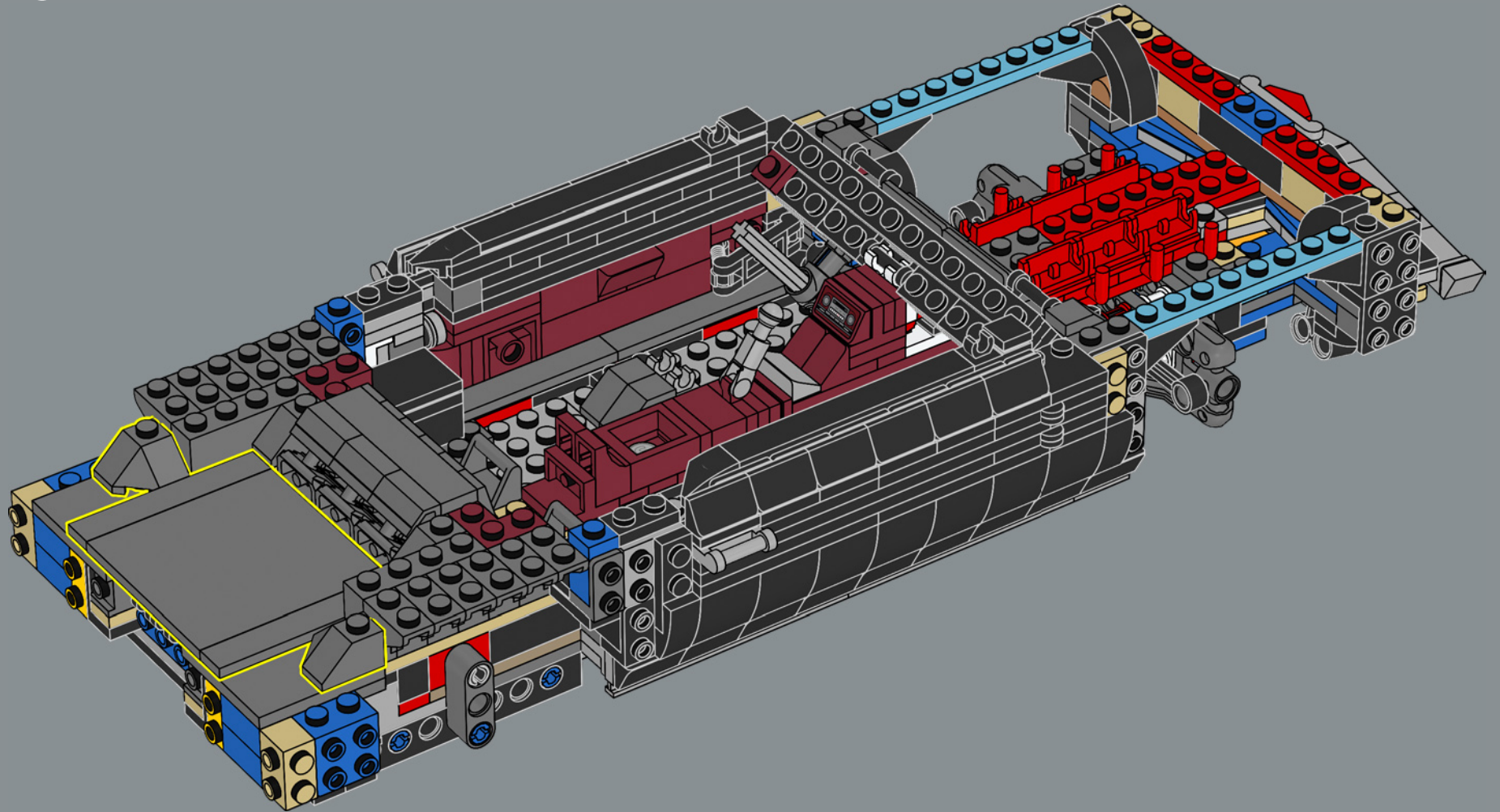

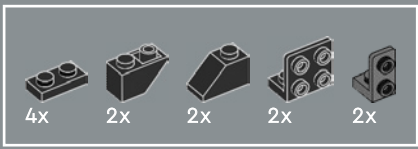

199

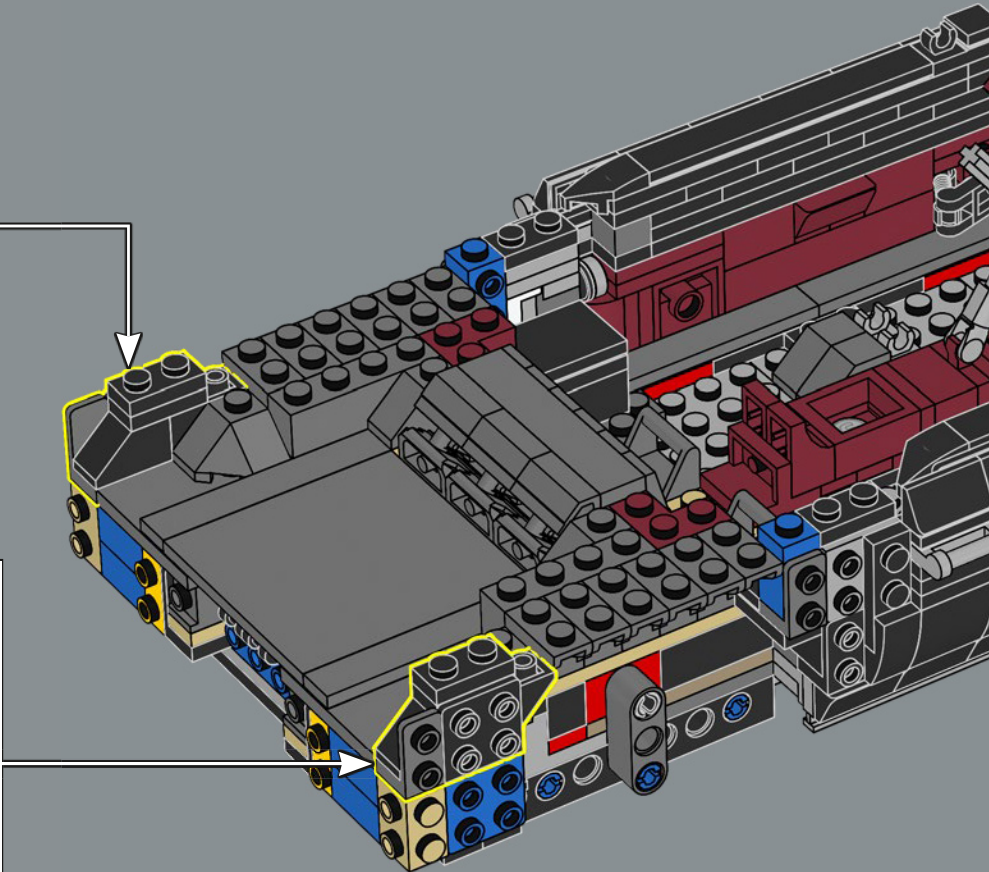
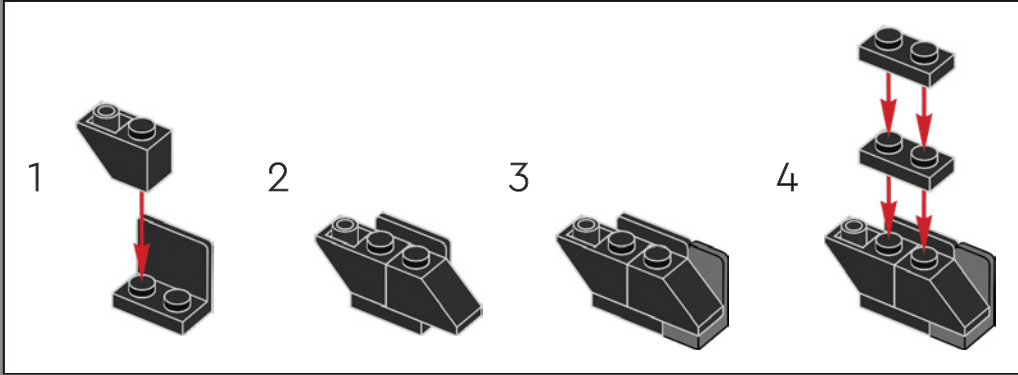
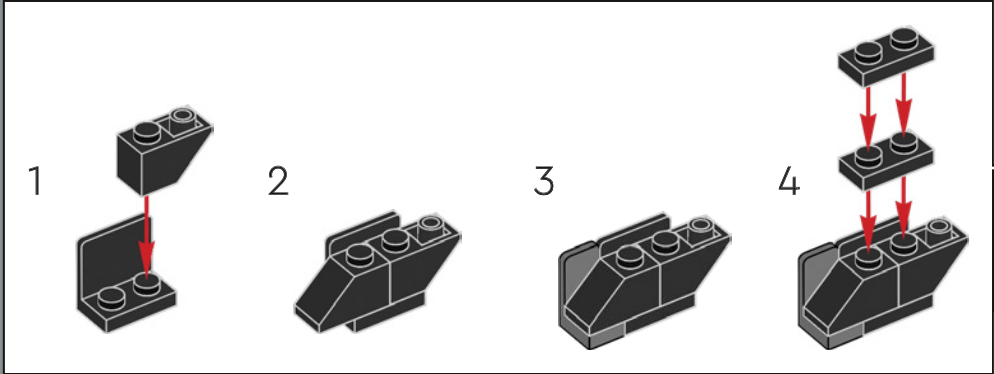



200

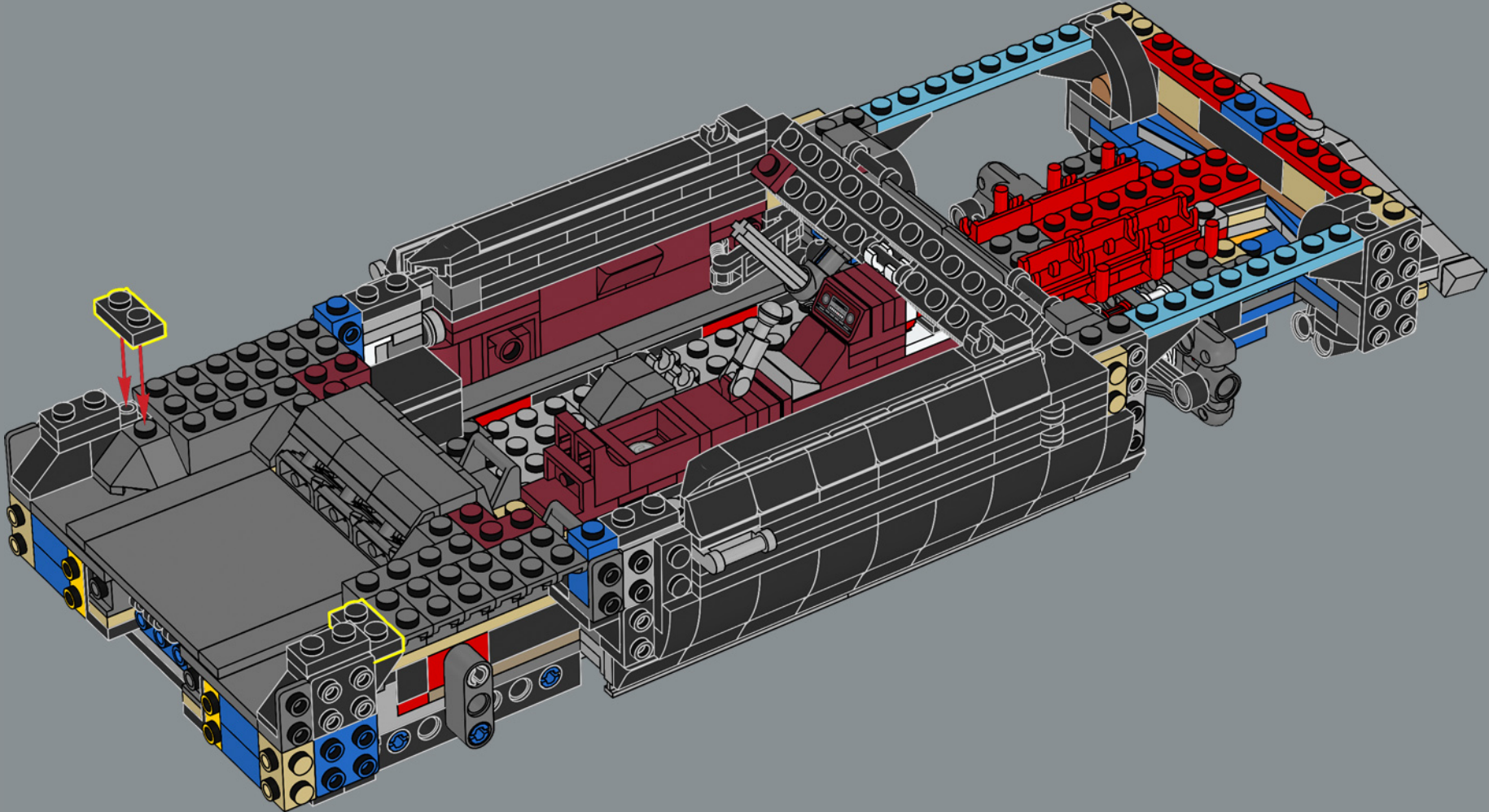



2x

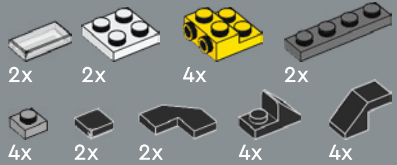

201

1

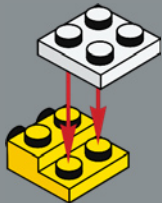

2

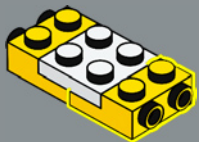

3

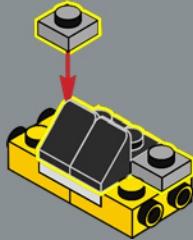

4

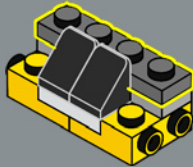

5

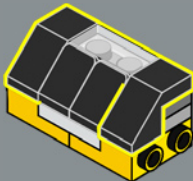

2x

6

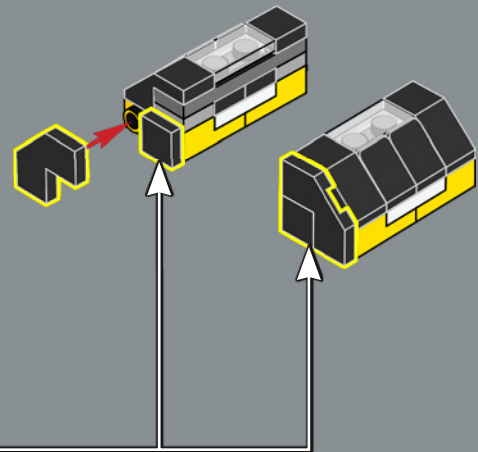

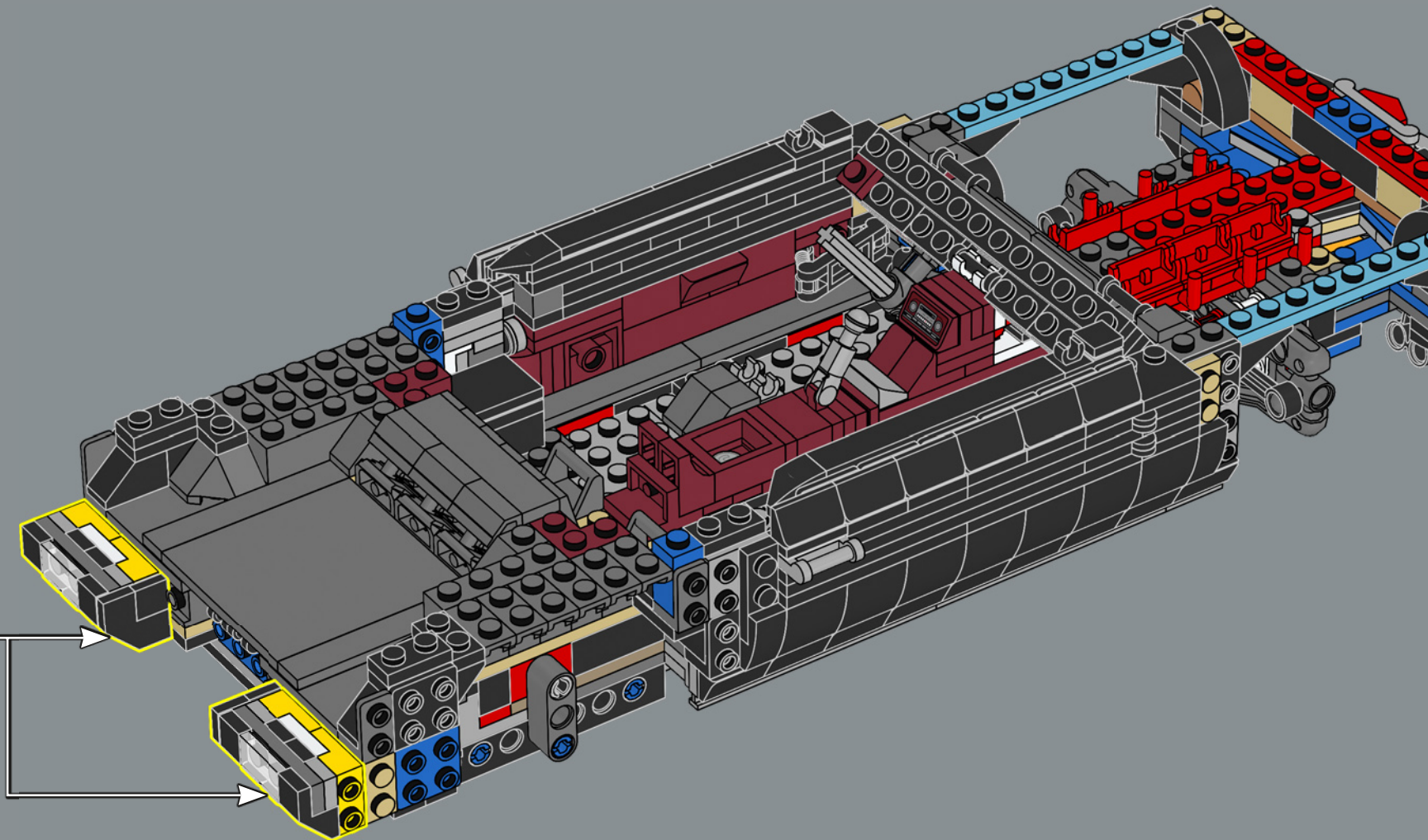



202

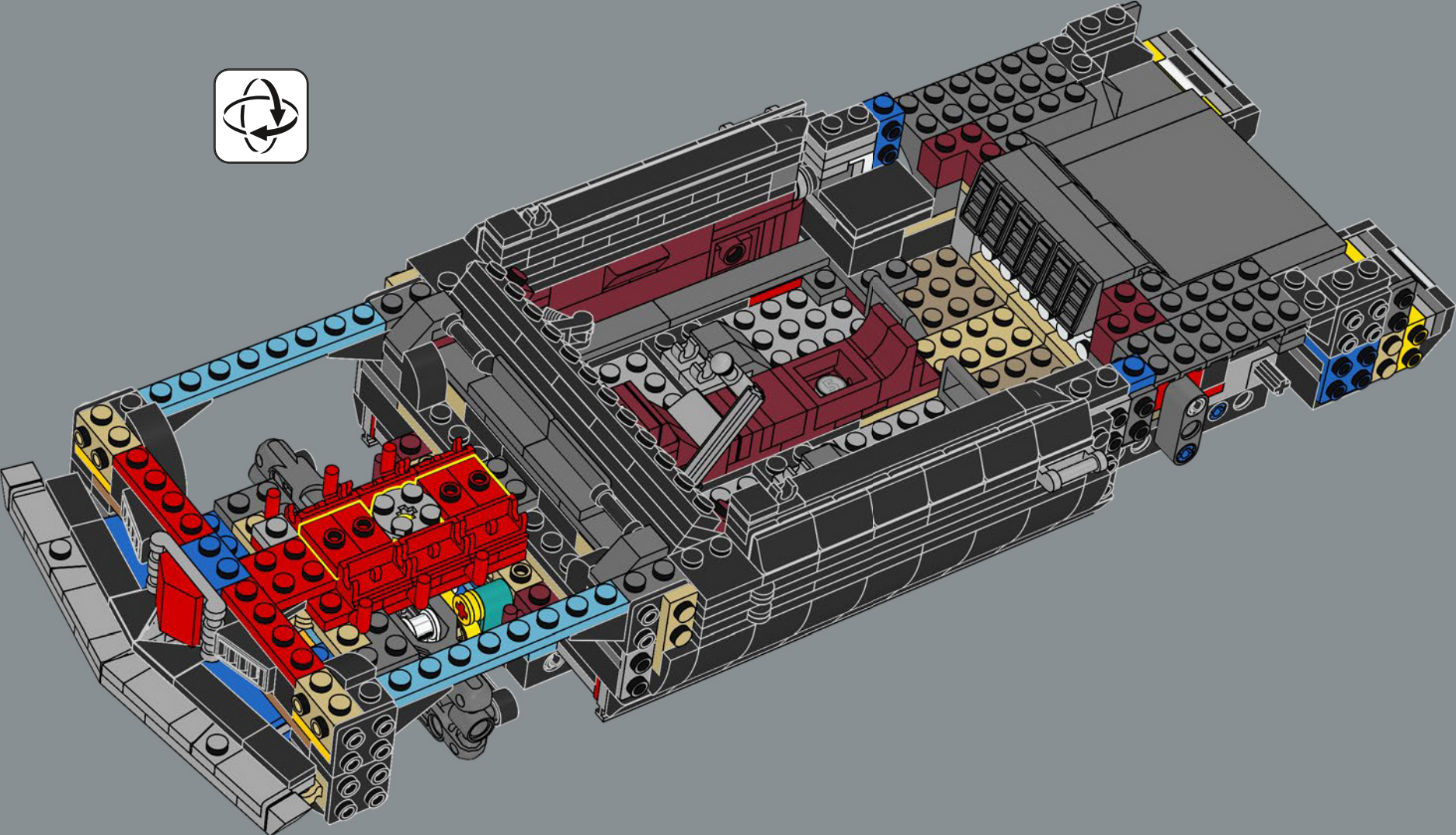

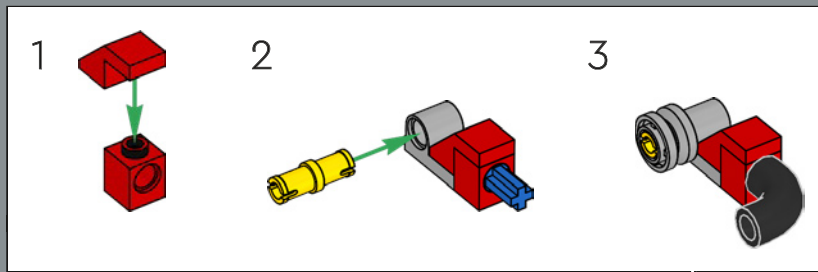
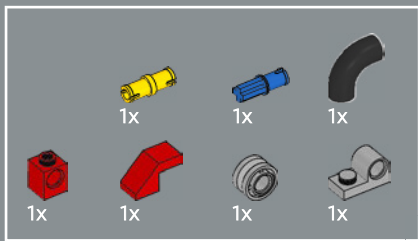

203

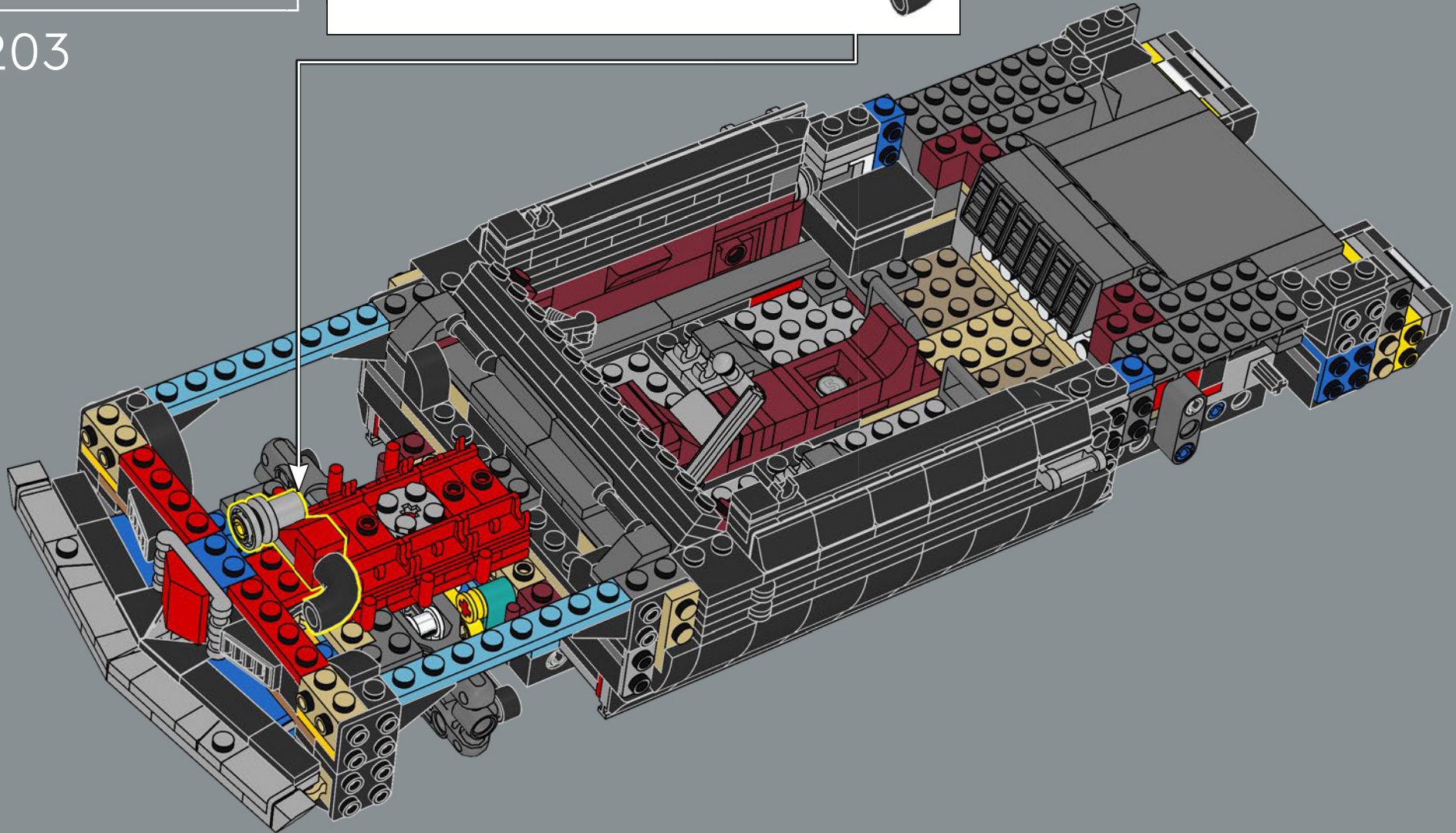

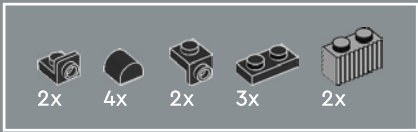

204

1

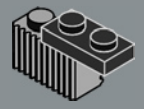

2

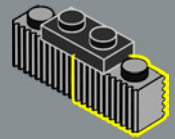

3

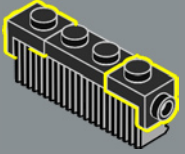

4

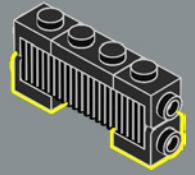

5

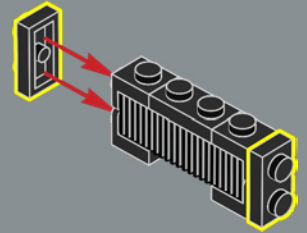

6

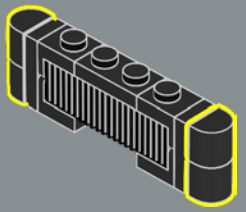

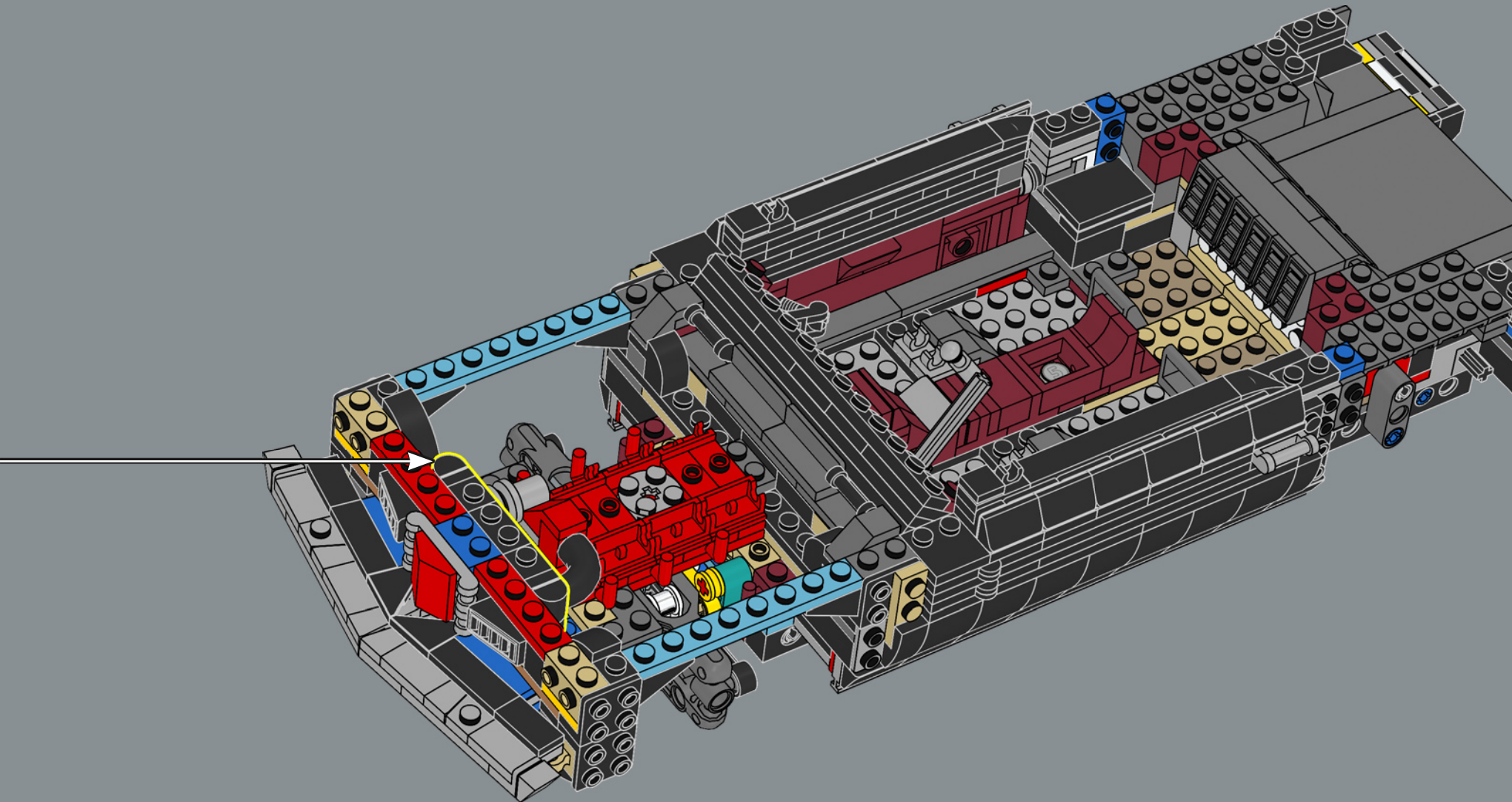

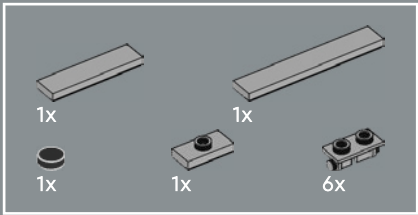

205

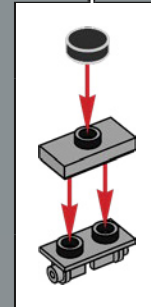
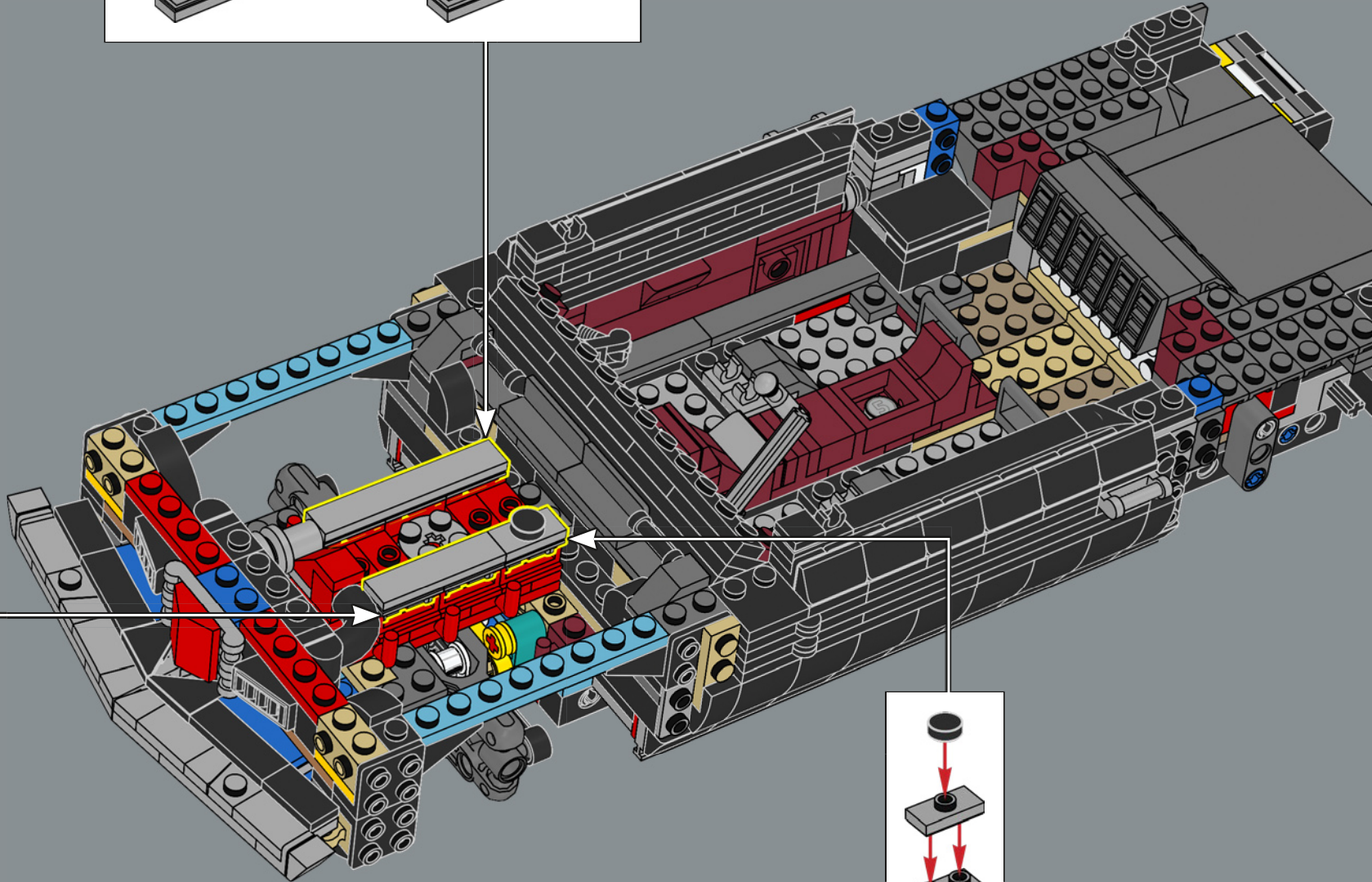
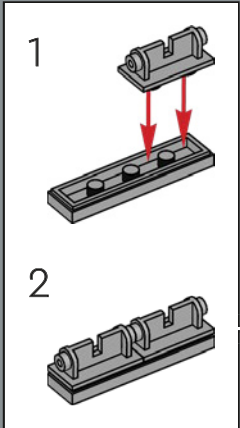
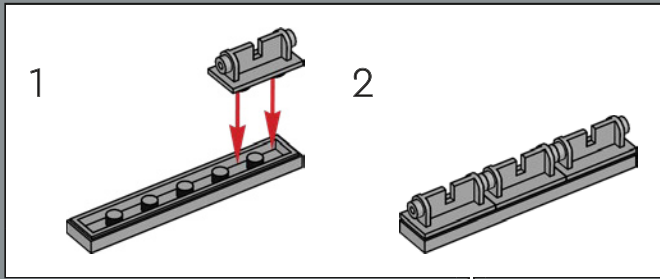

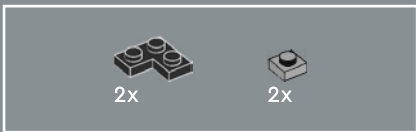

206

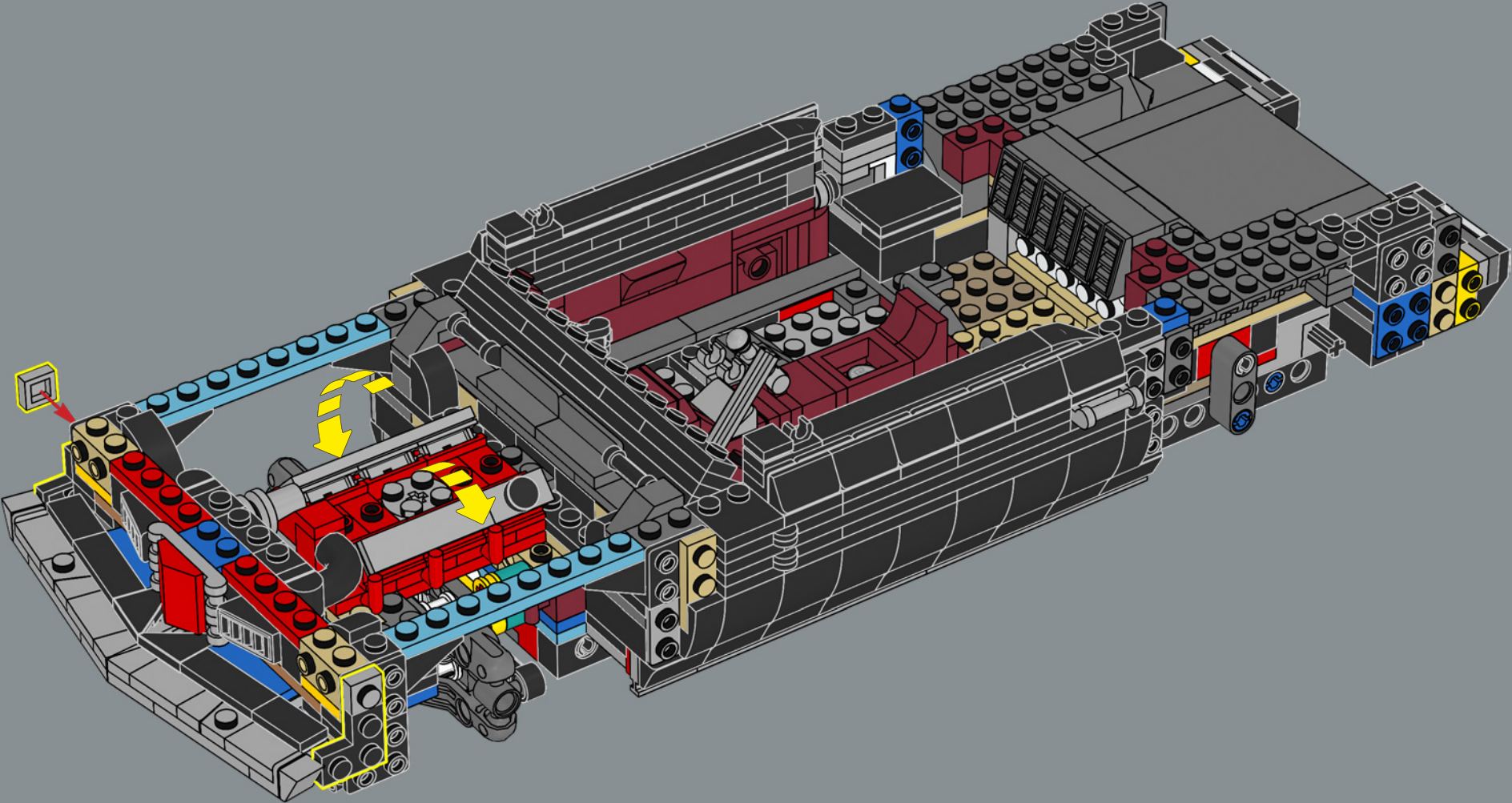



207

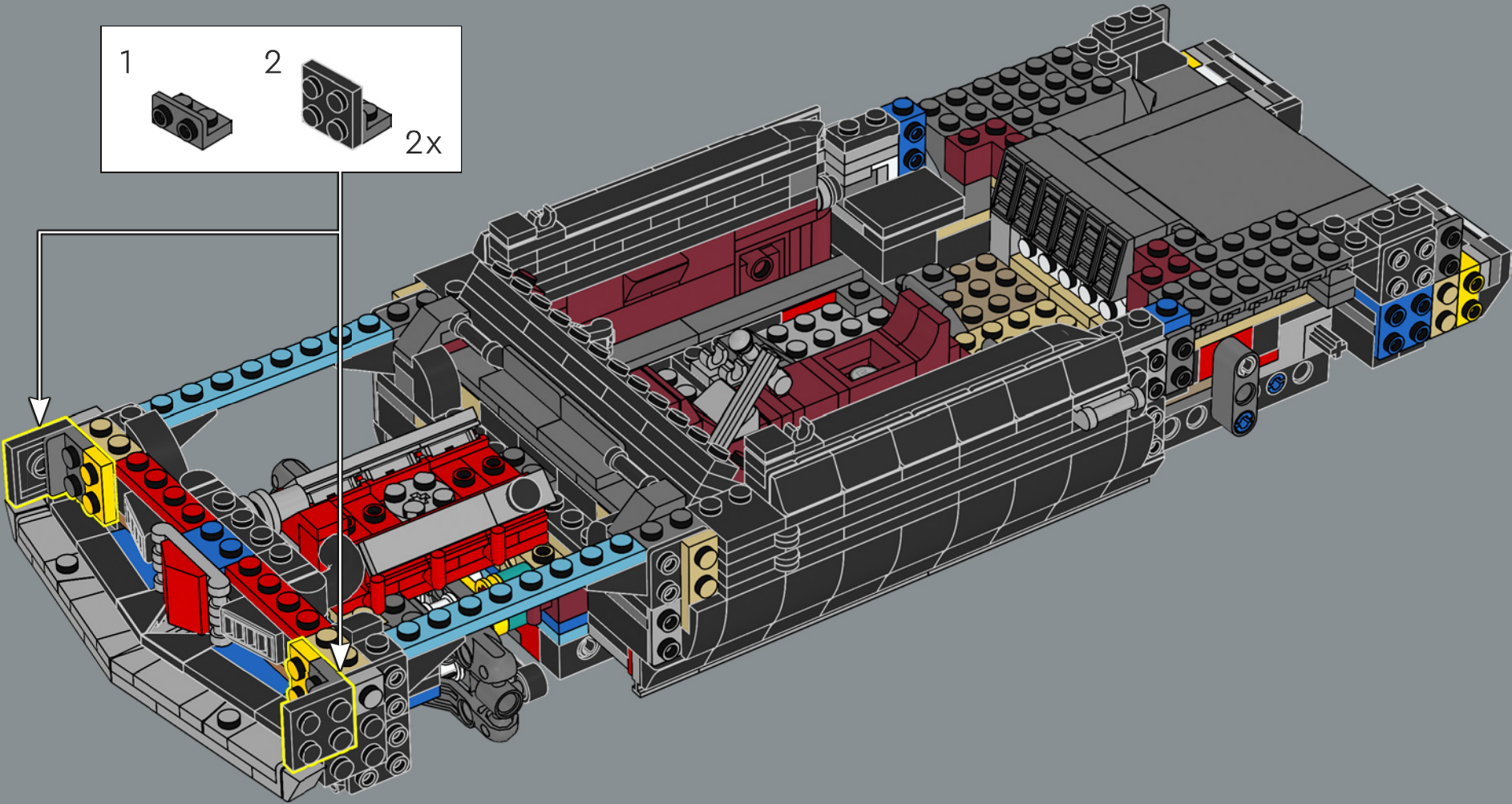
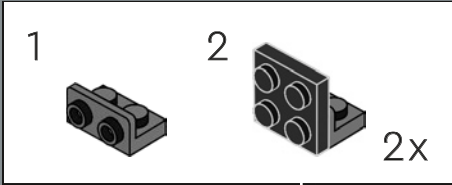

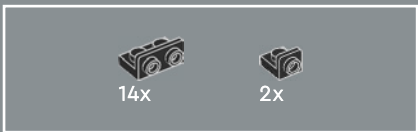

208

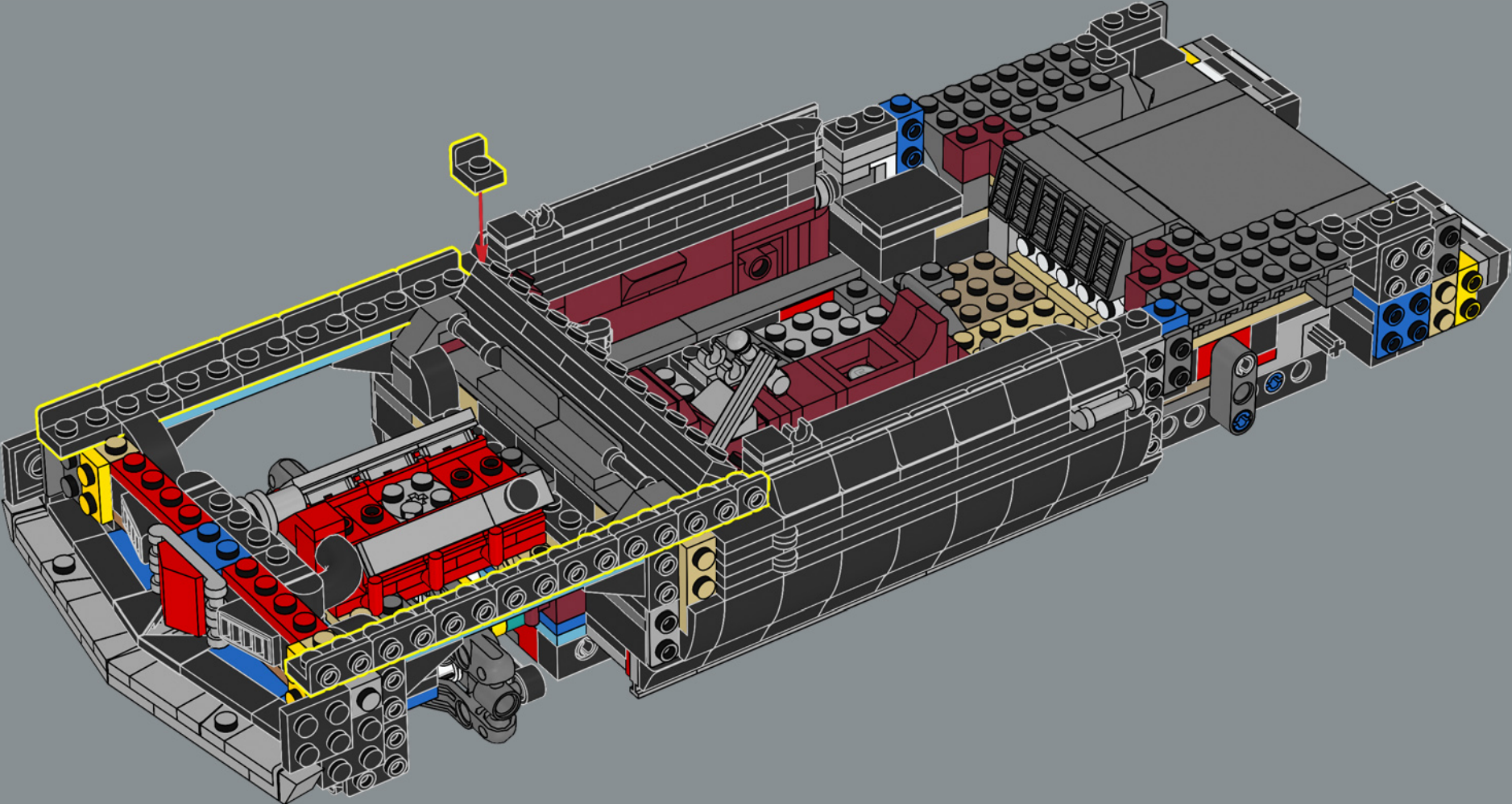

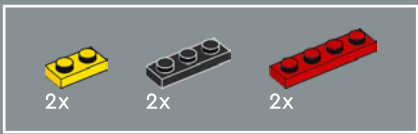

209

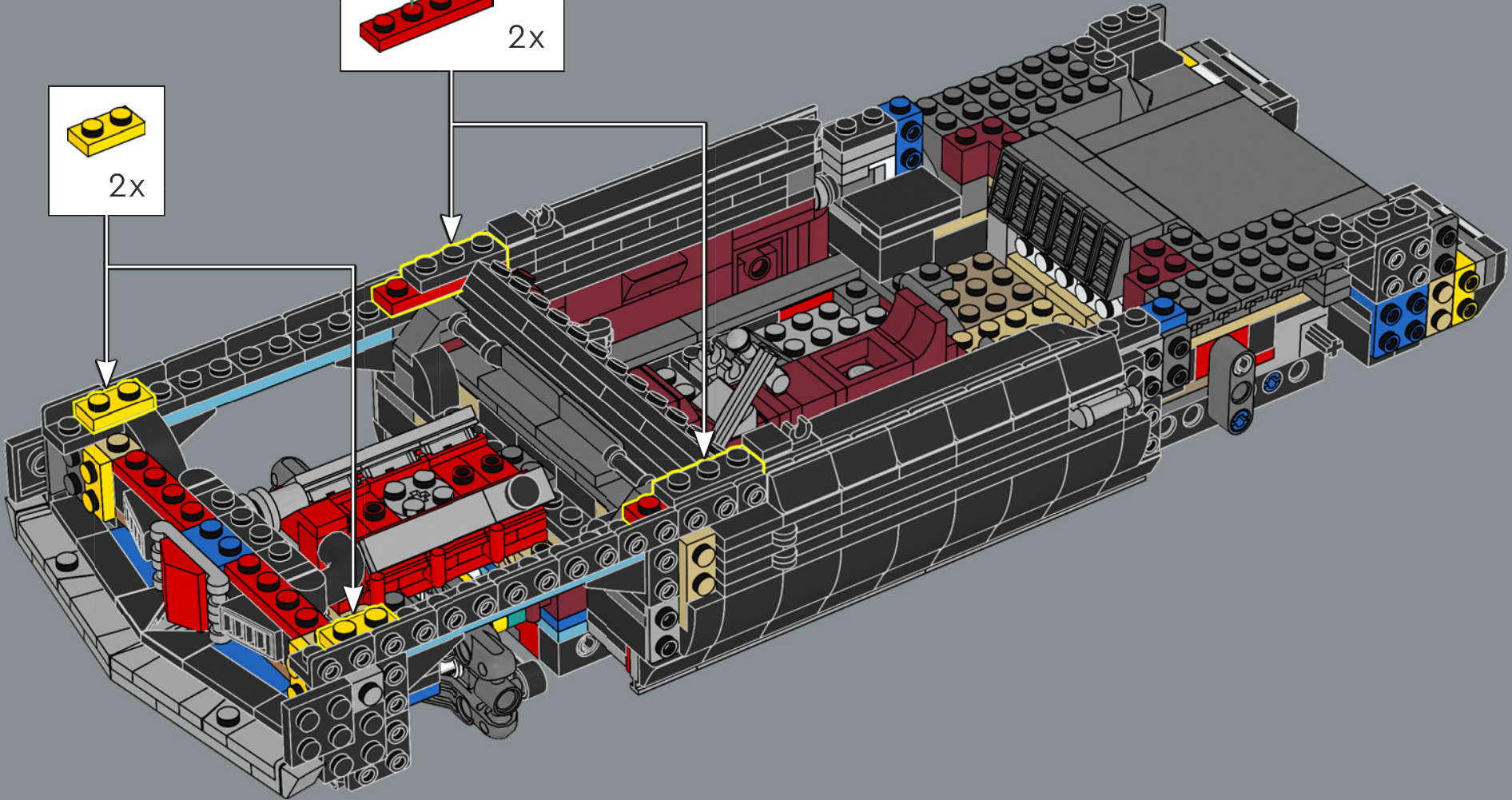
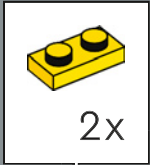
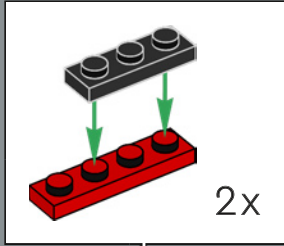

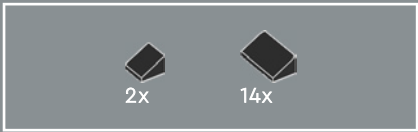

210

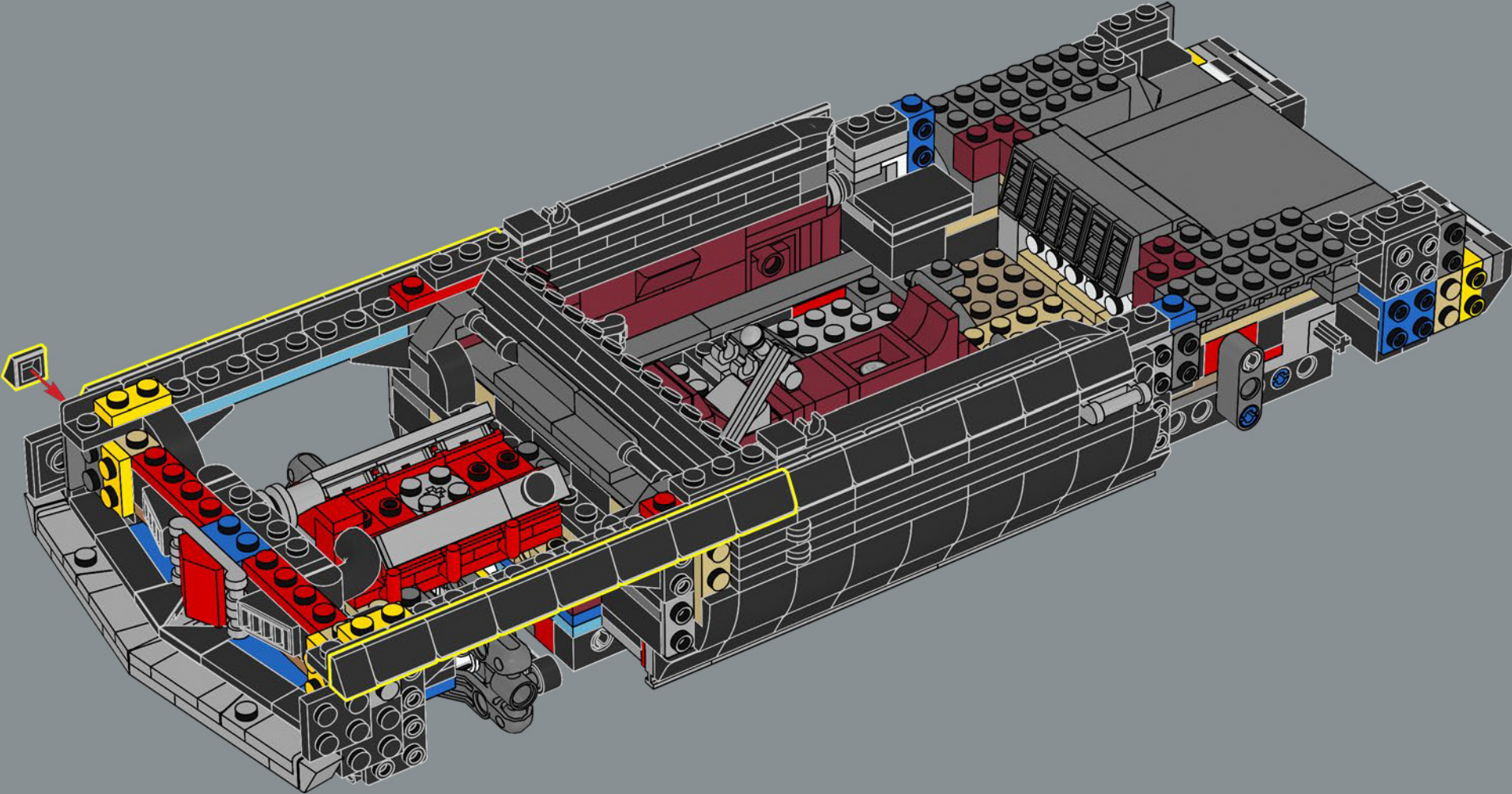

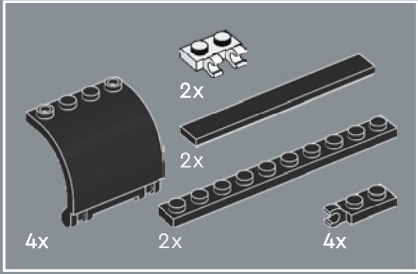
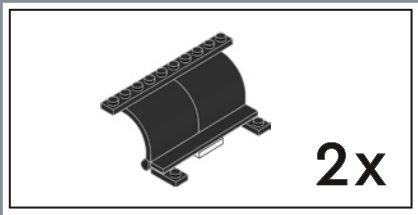

211

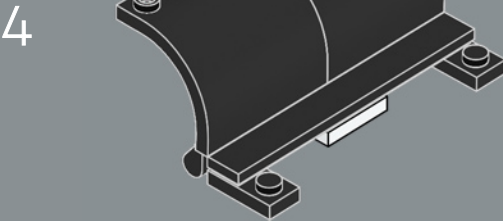
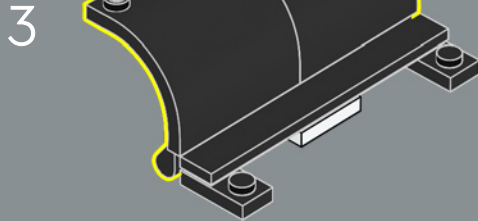
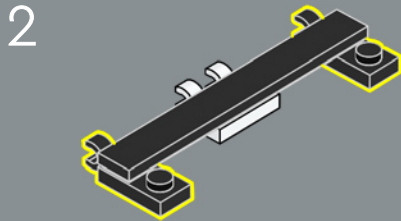
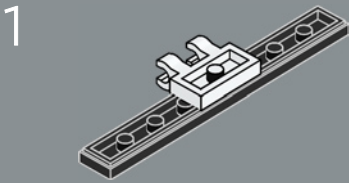

2x

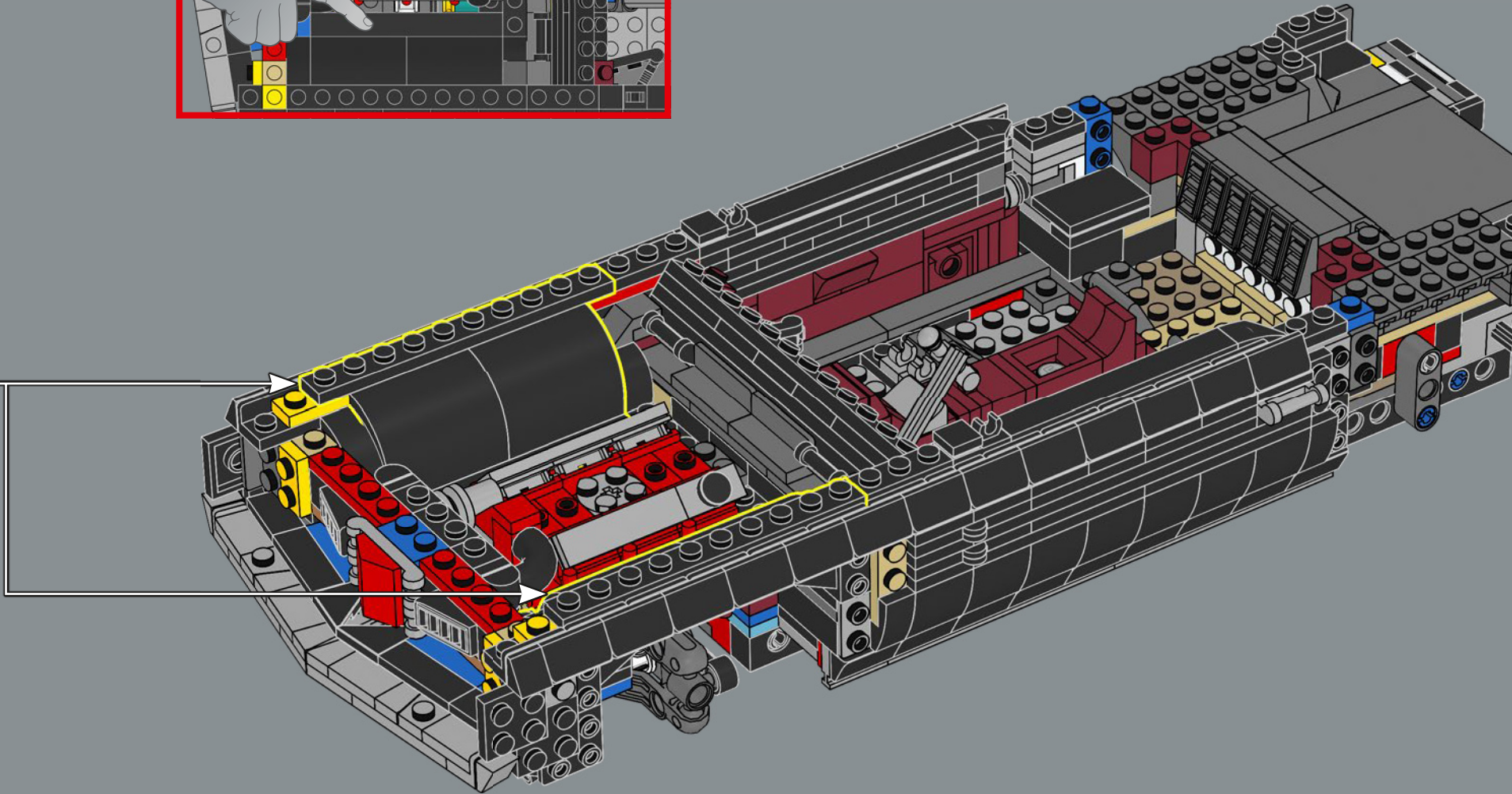
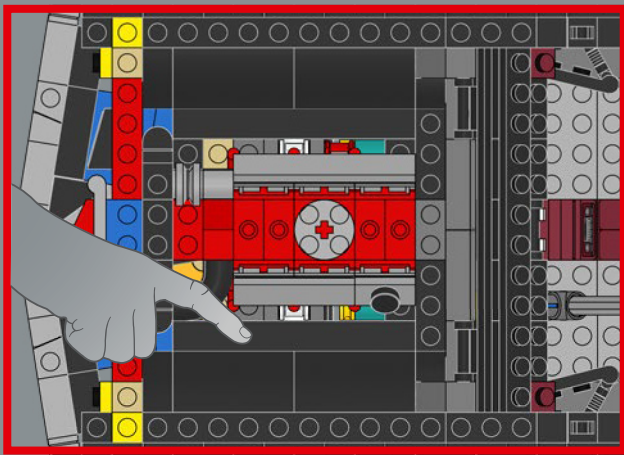

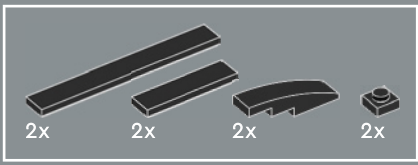

212

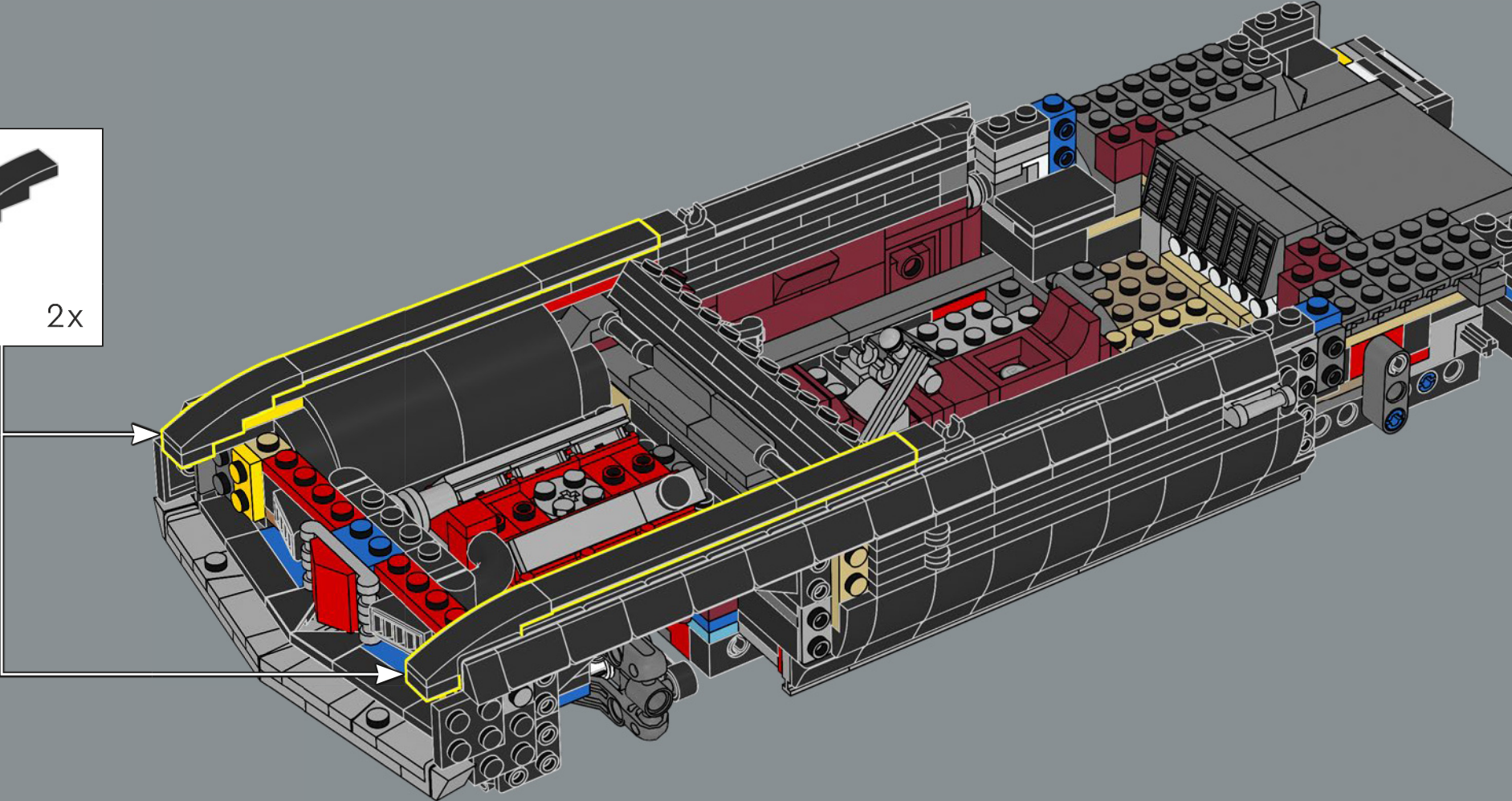
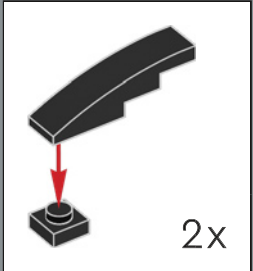

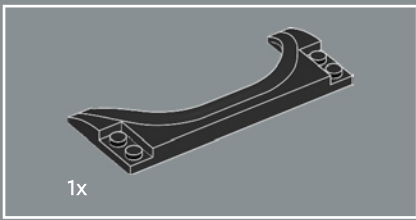

213

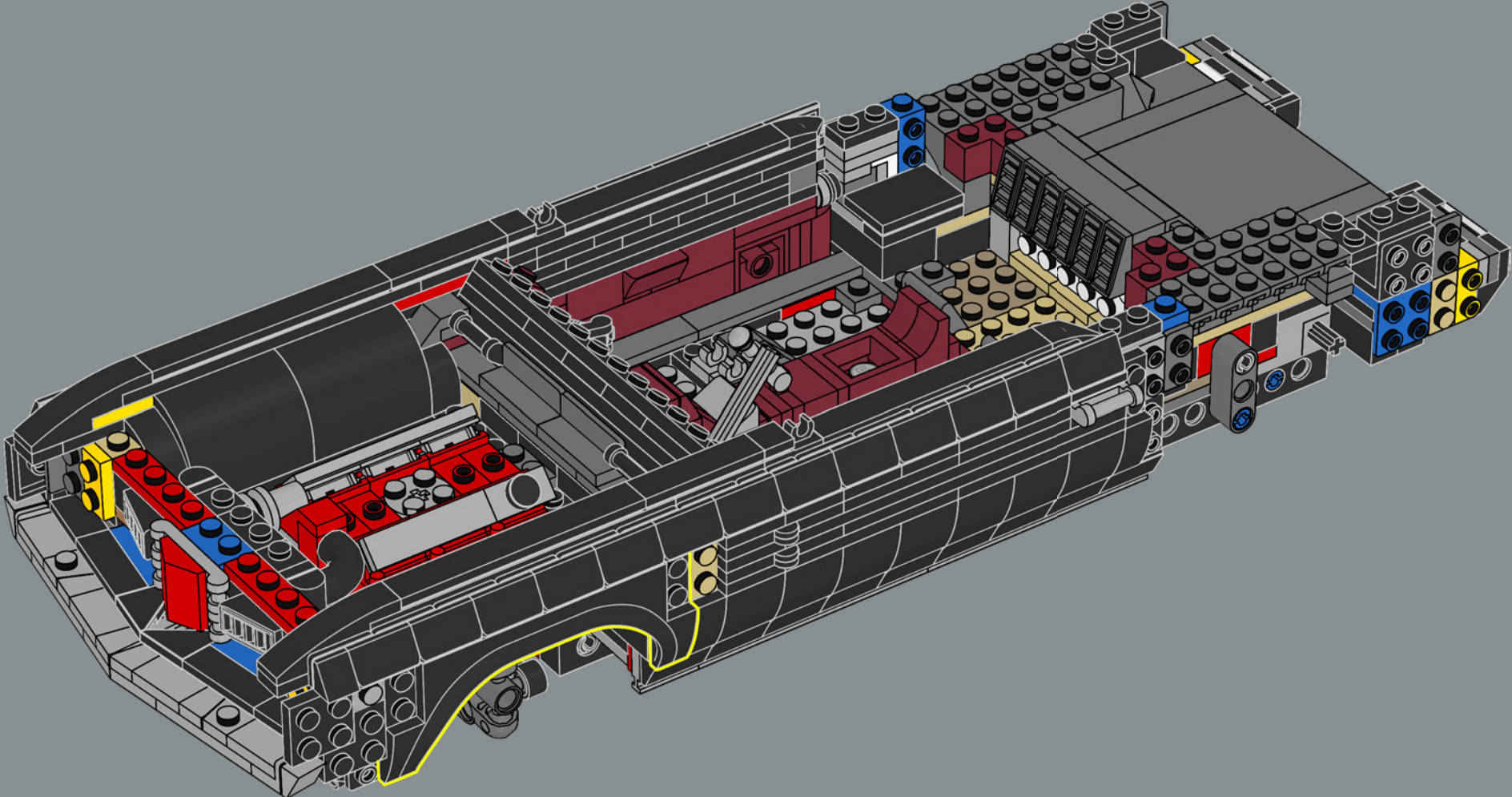

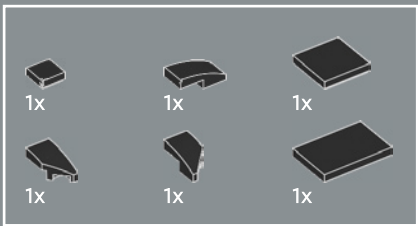

214

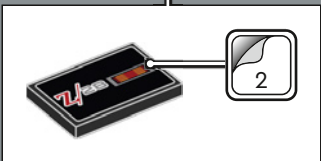
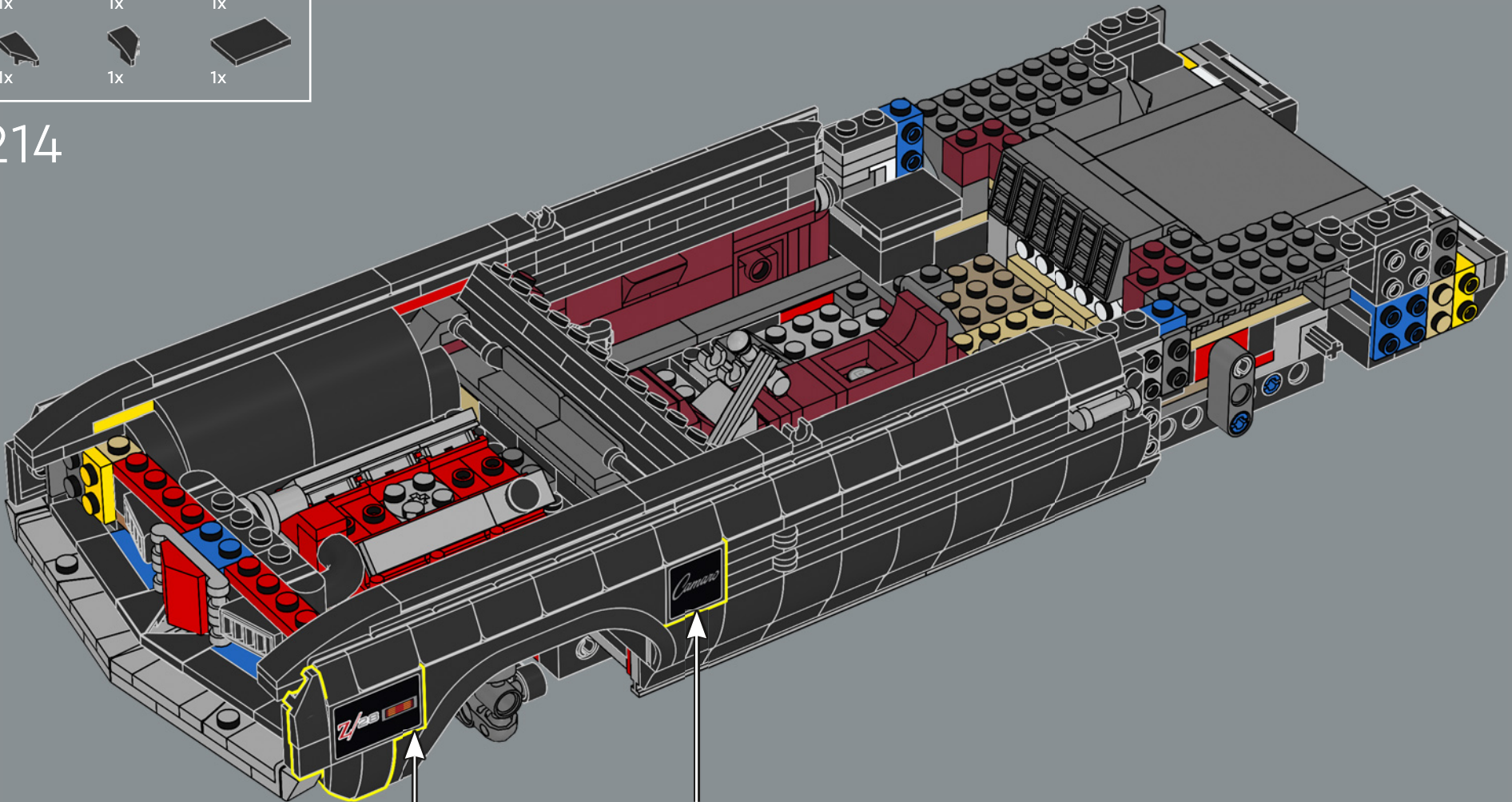

Ursprünglich hatte Chevrolet in Erwägung gezogen,
den Camaro auch als Kombi herzustellen.

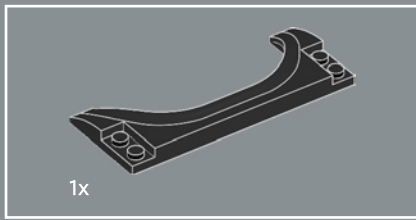

215

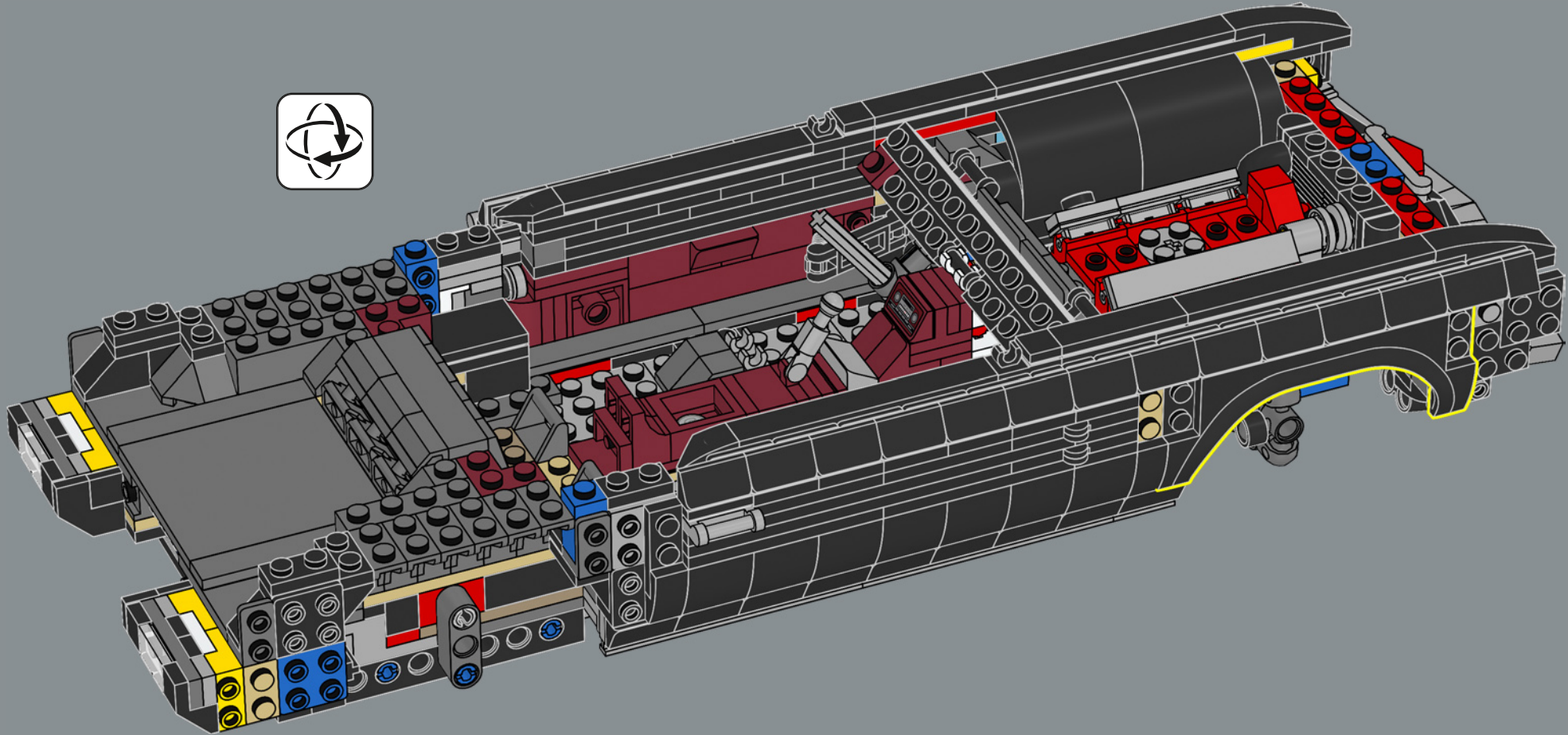

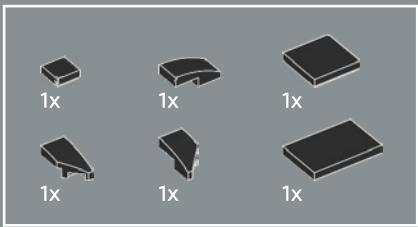

216

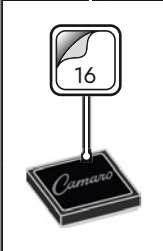
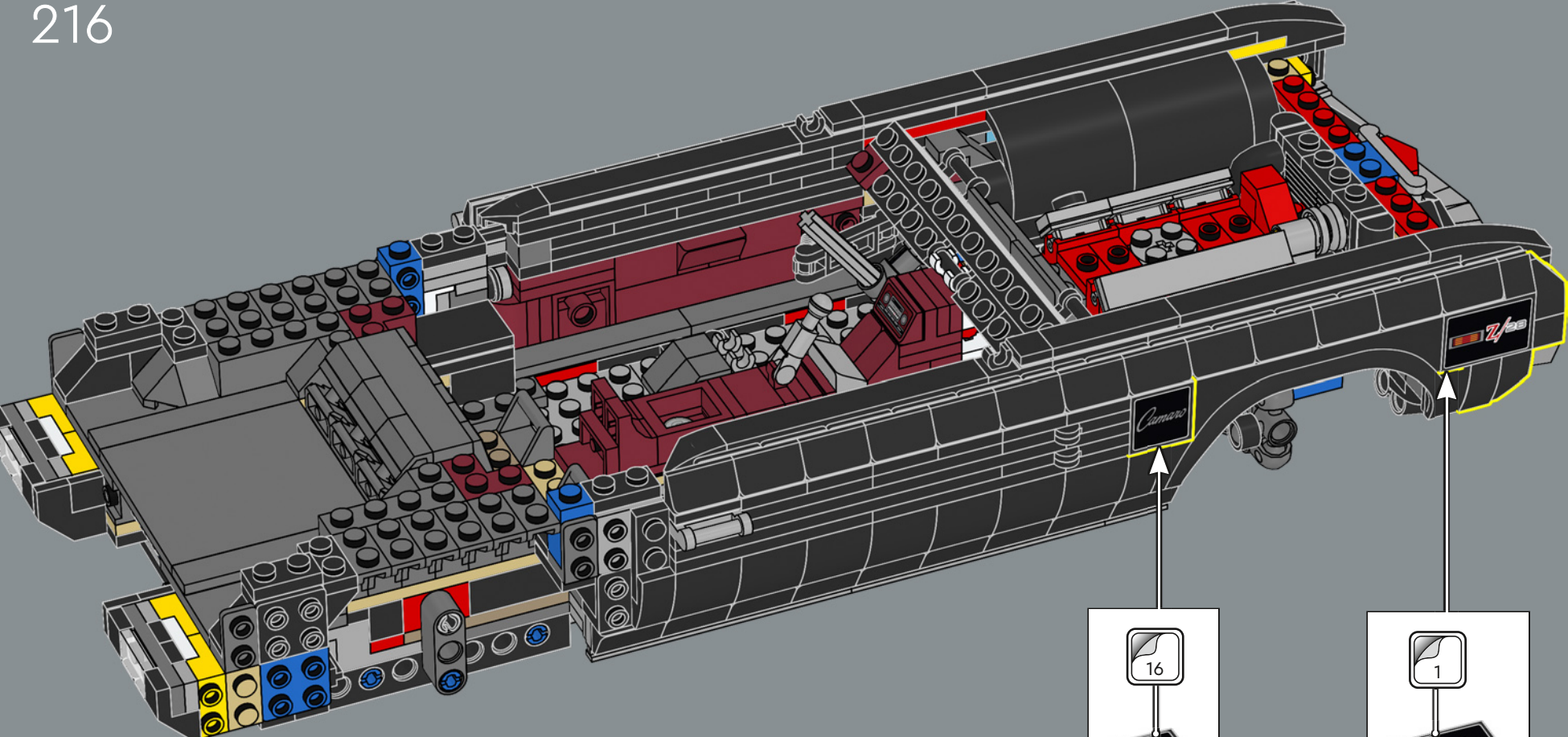

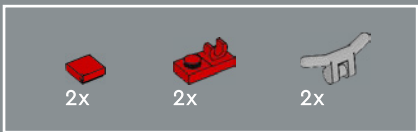

217

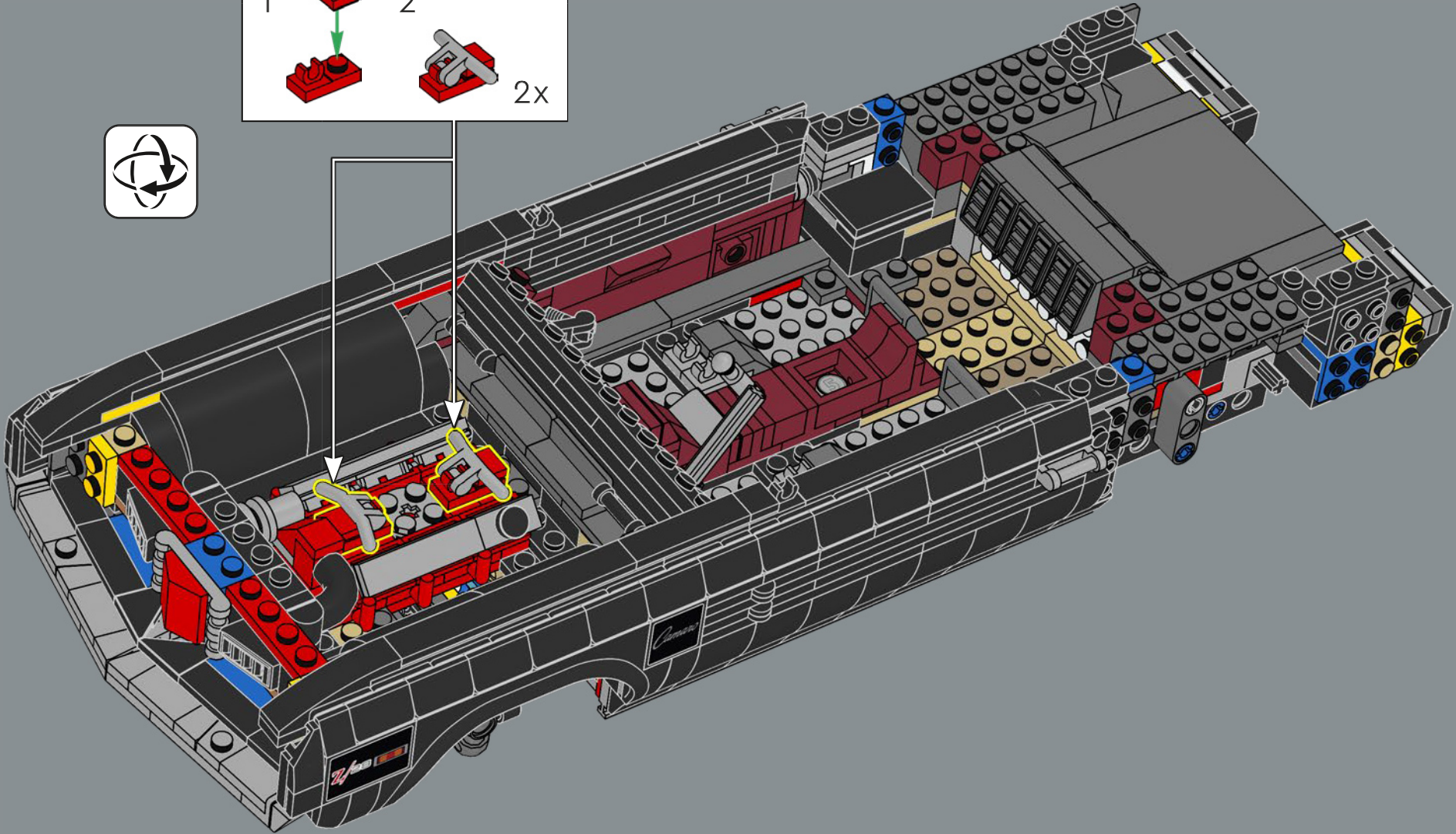
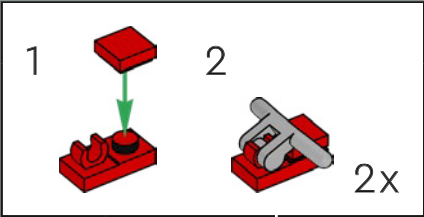

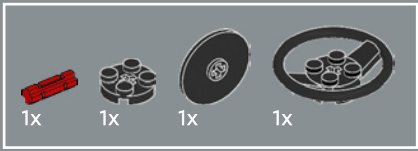

218

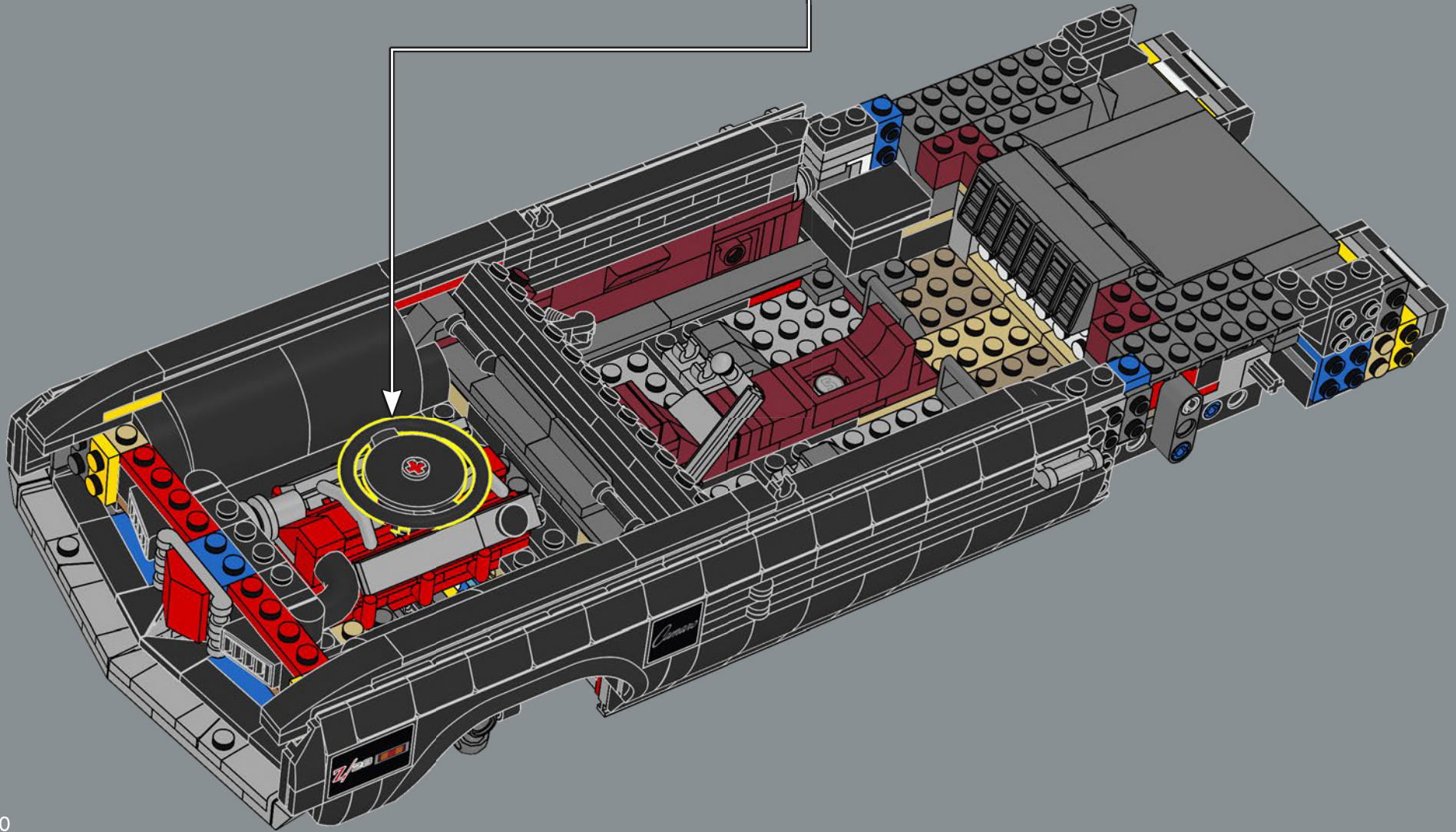
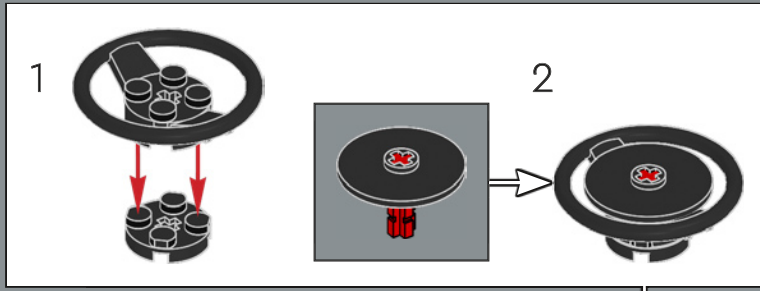

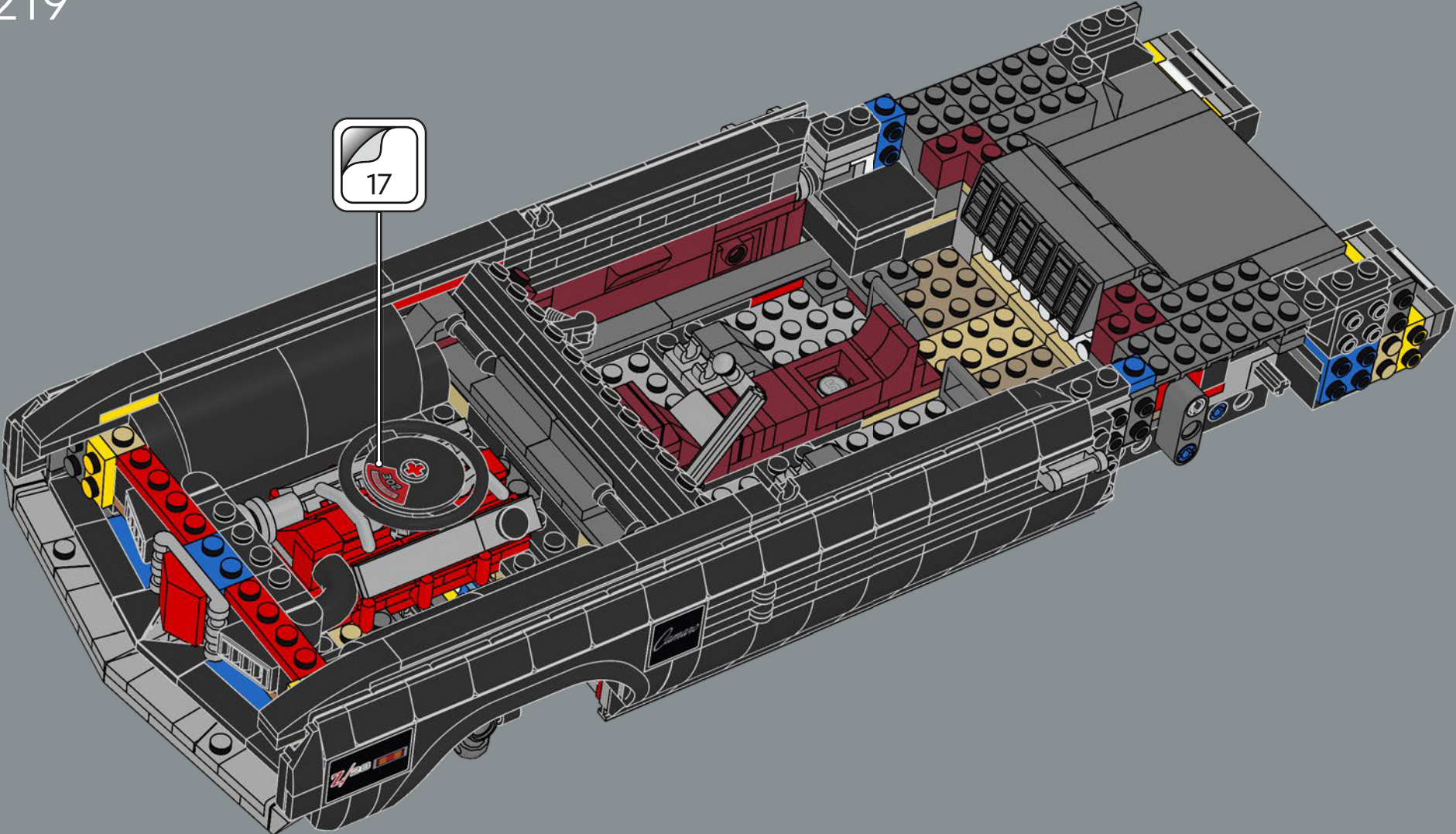

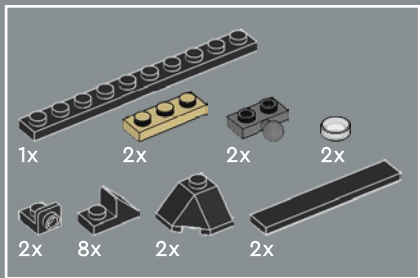

220

1

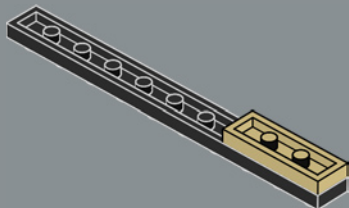

2

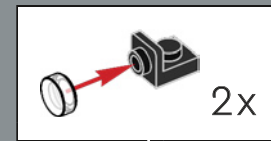
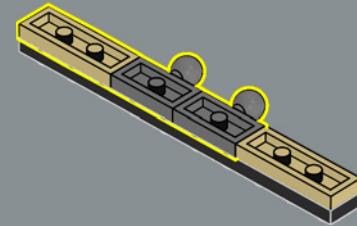

3

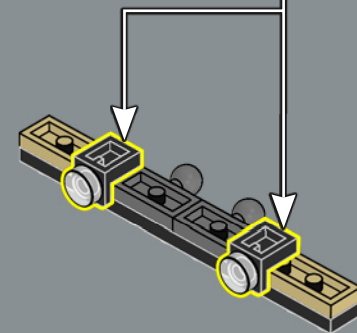

4

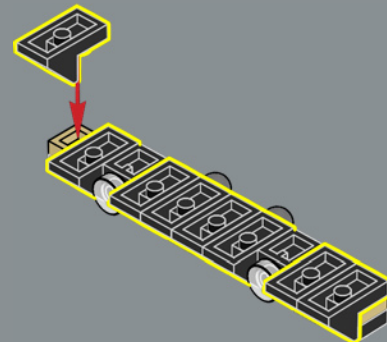

5

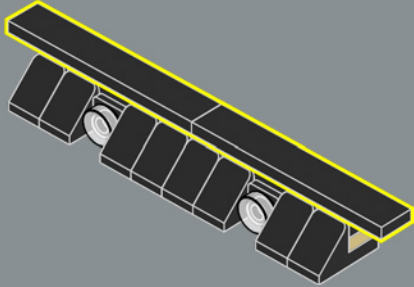

6

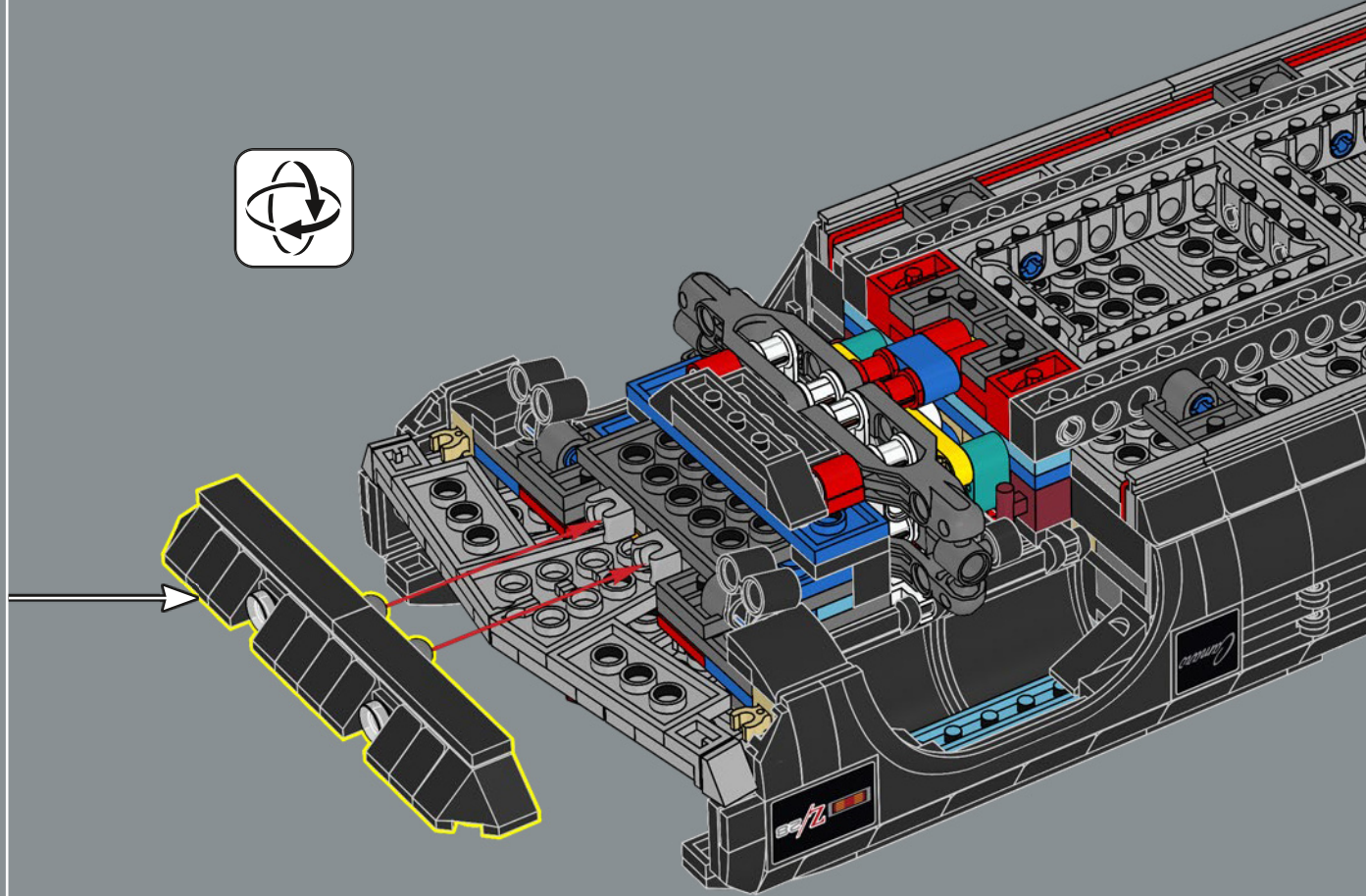
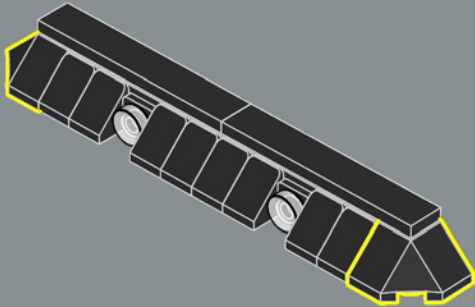

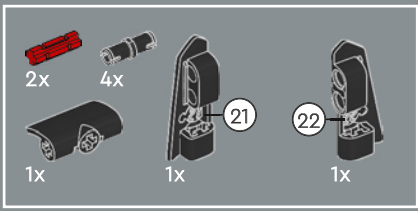

221

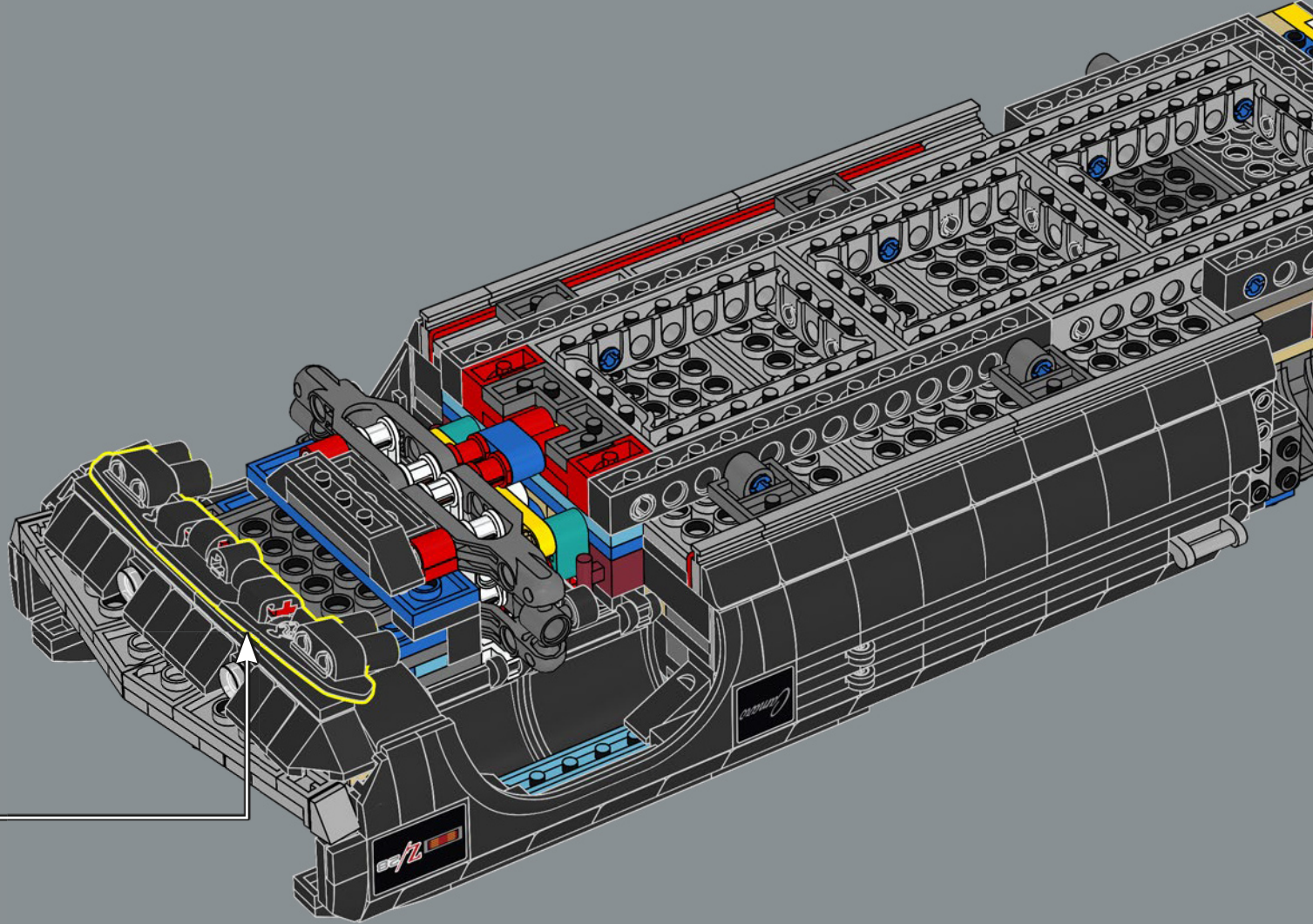
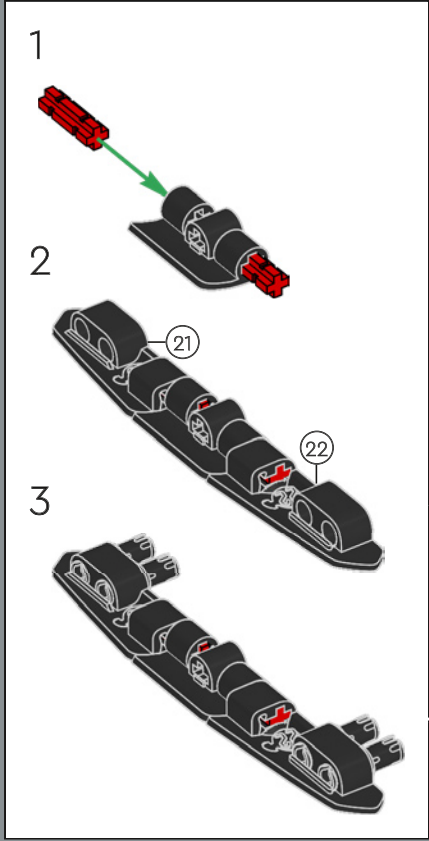



222

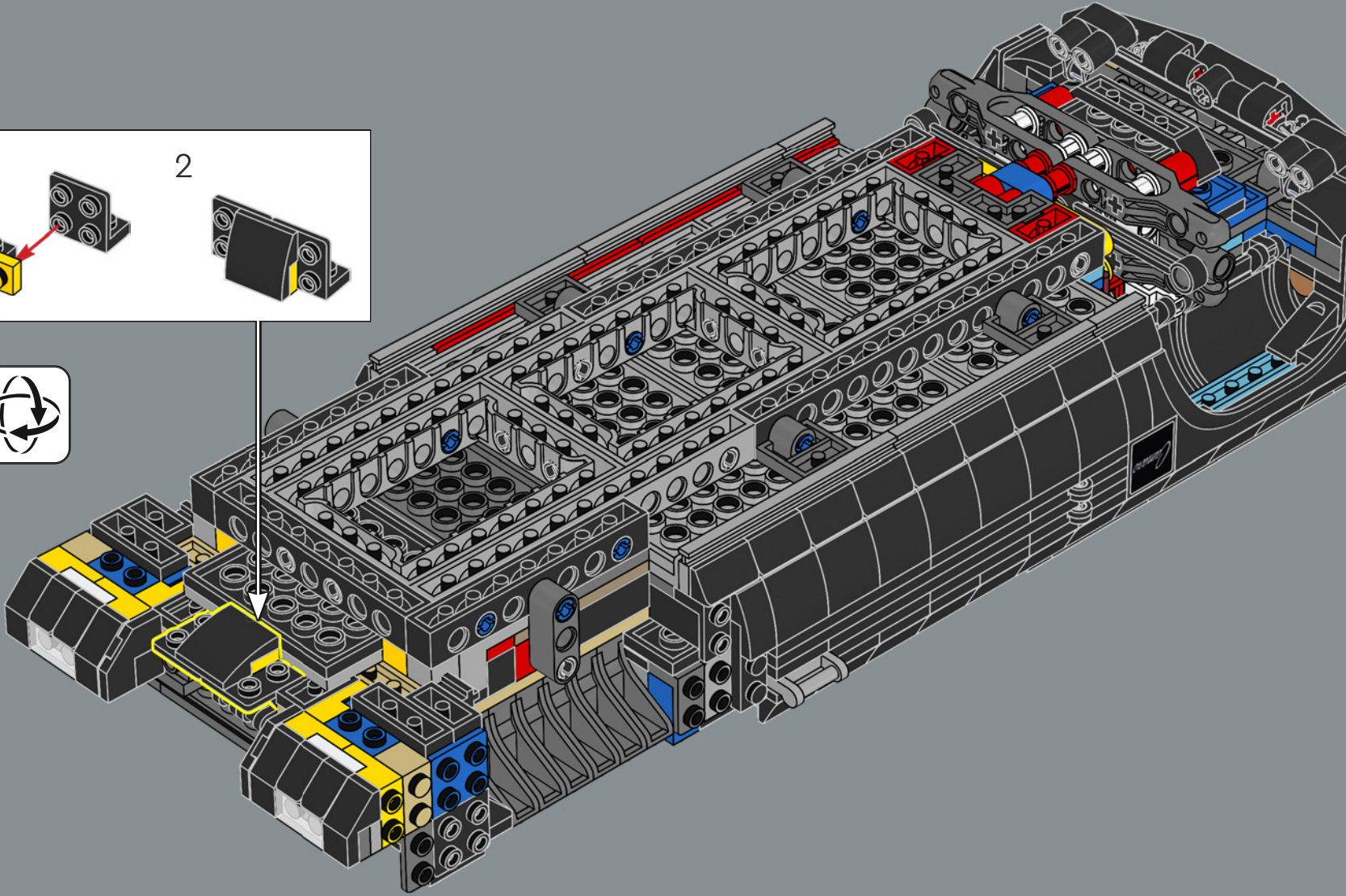
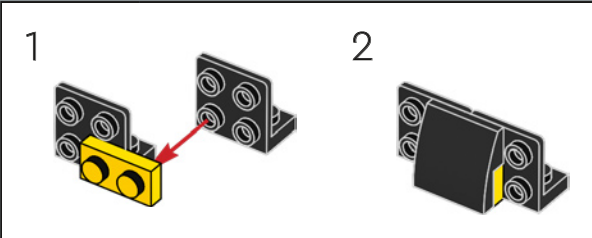

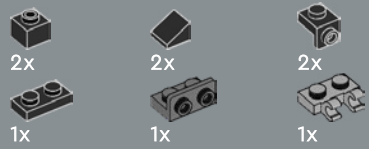

223

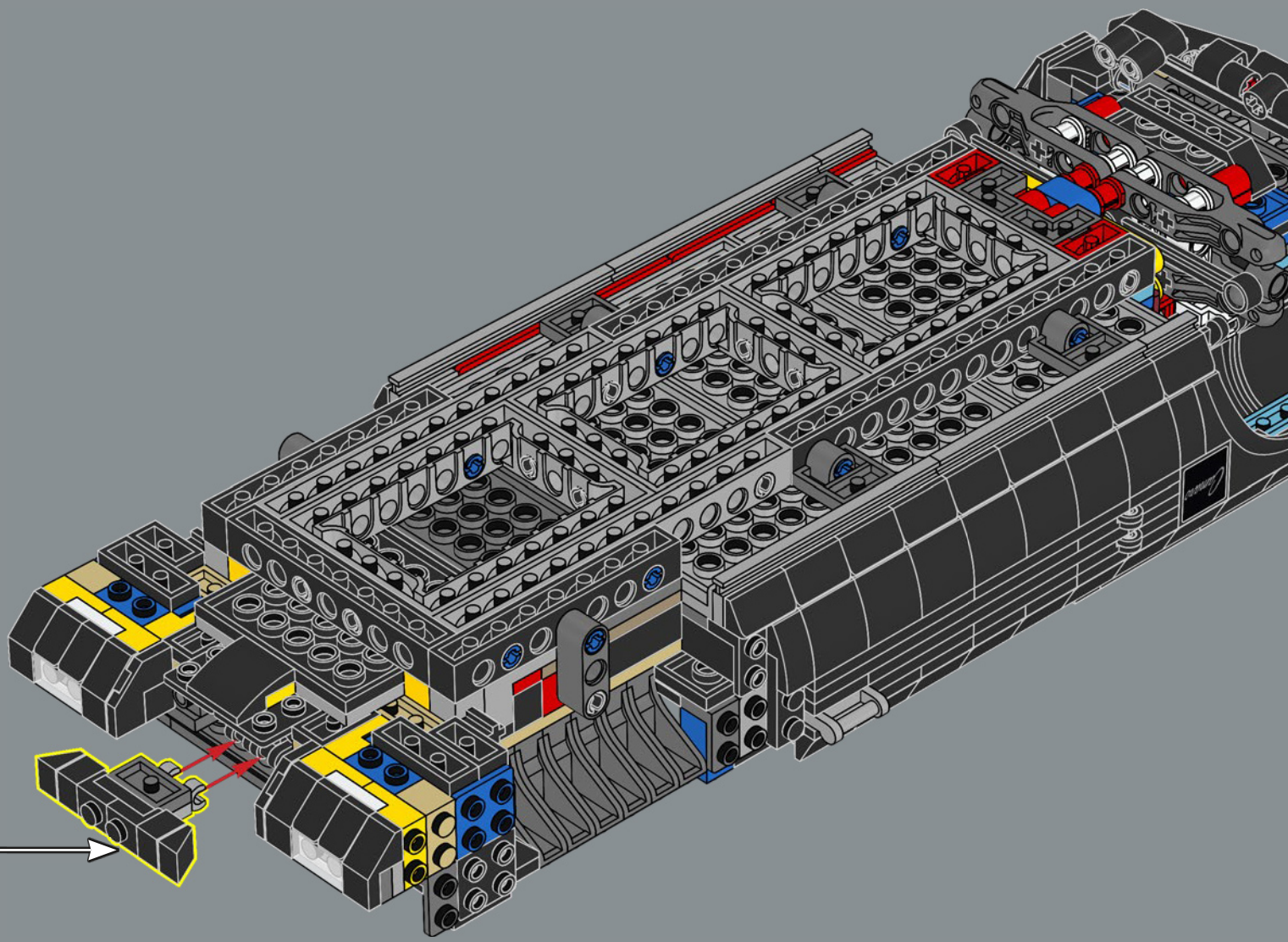
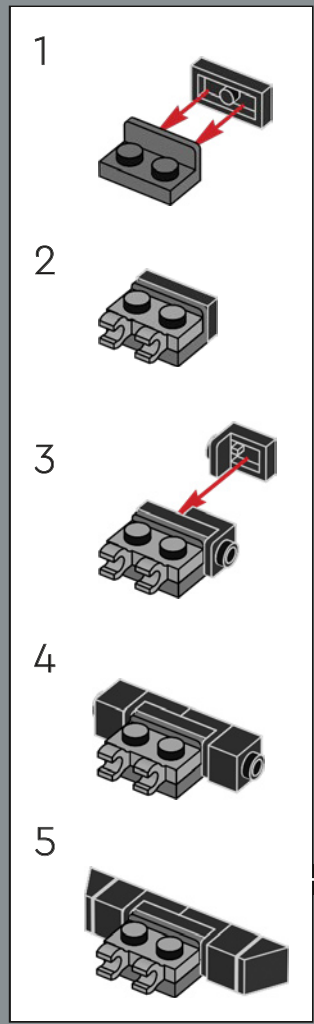

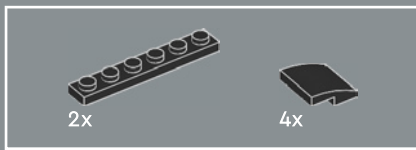

224

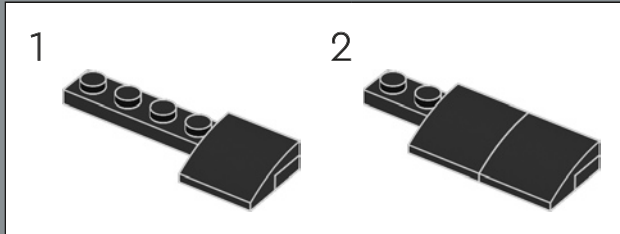

2

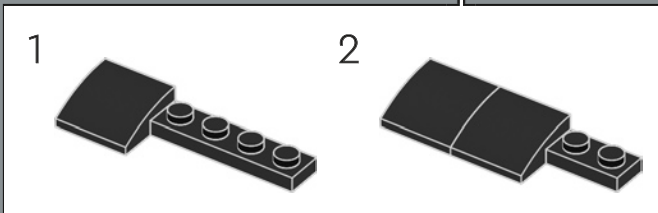
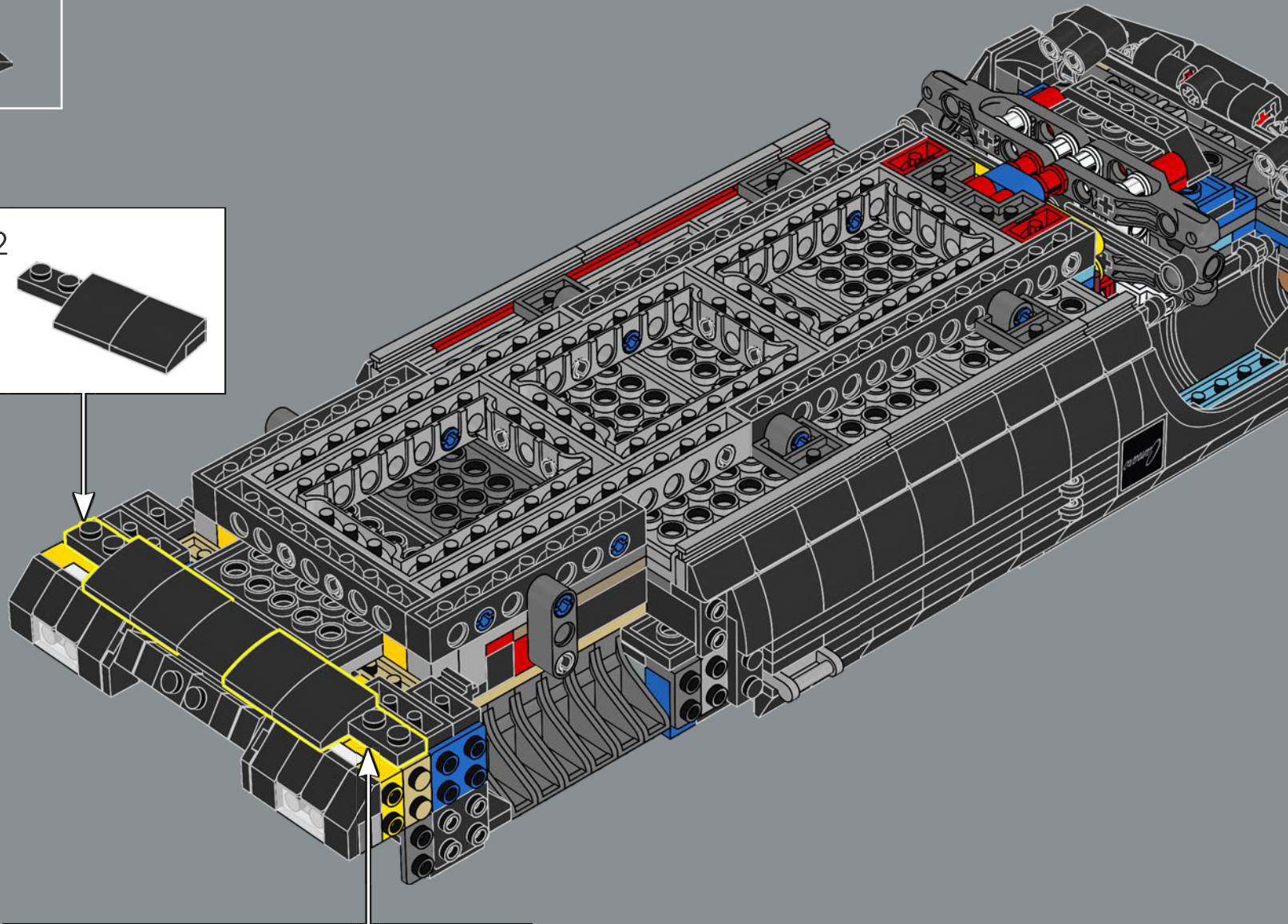
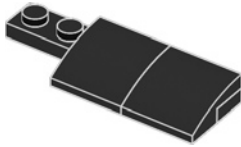

2

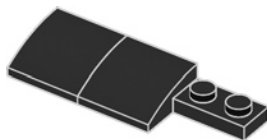



225

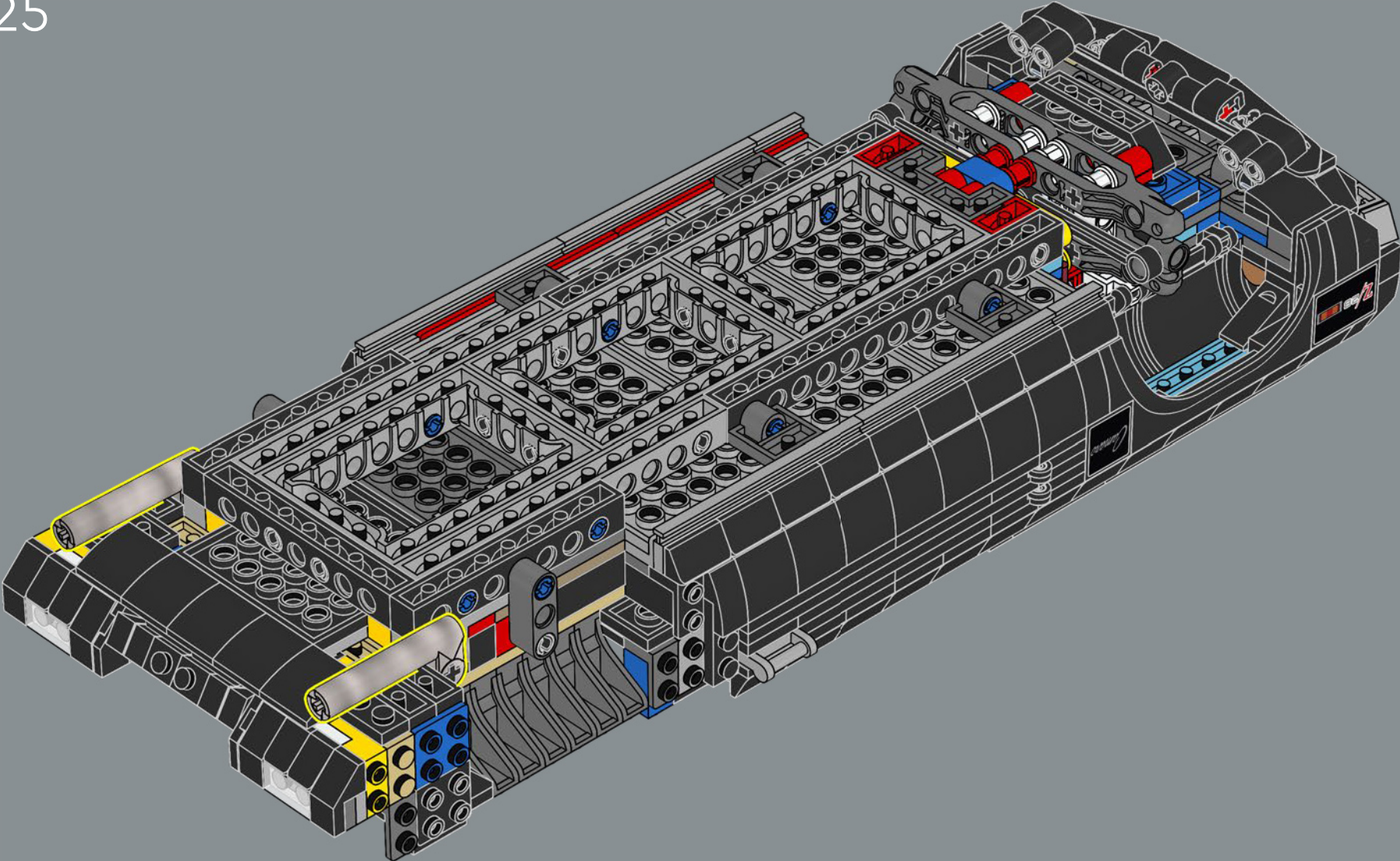

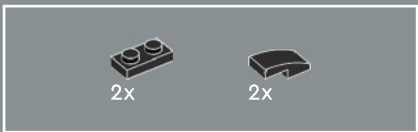

226

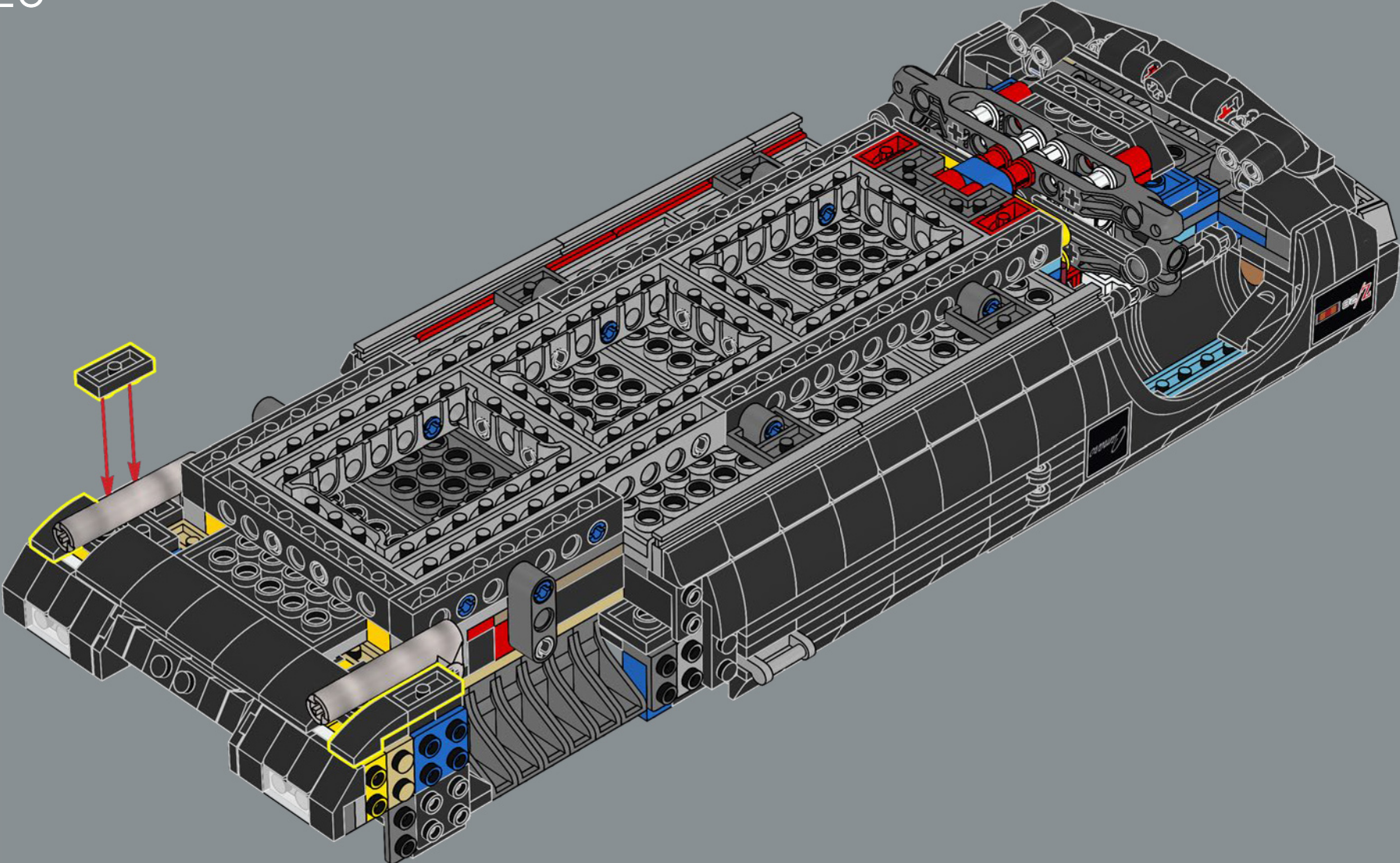

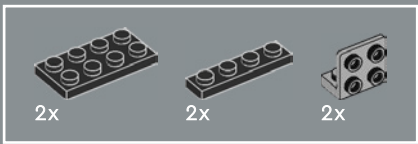

227

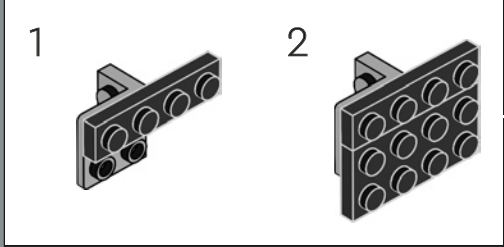
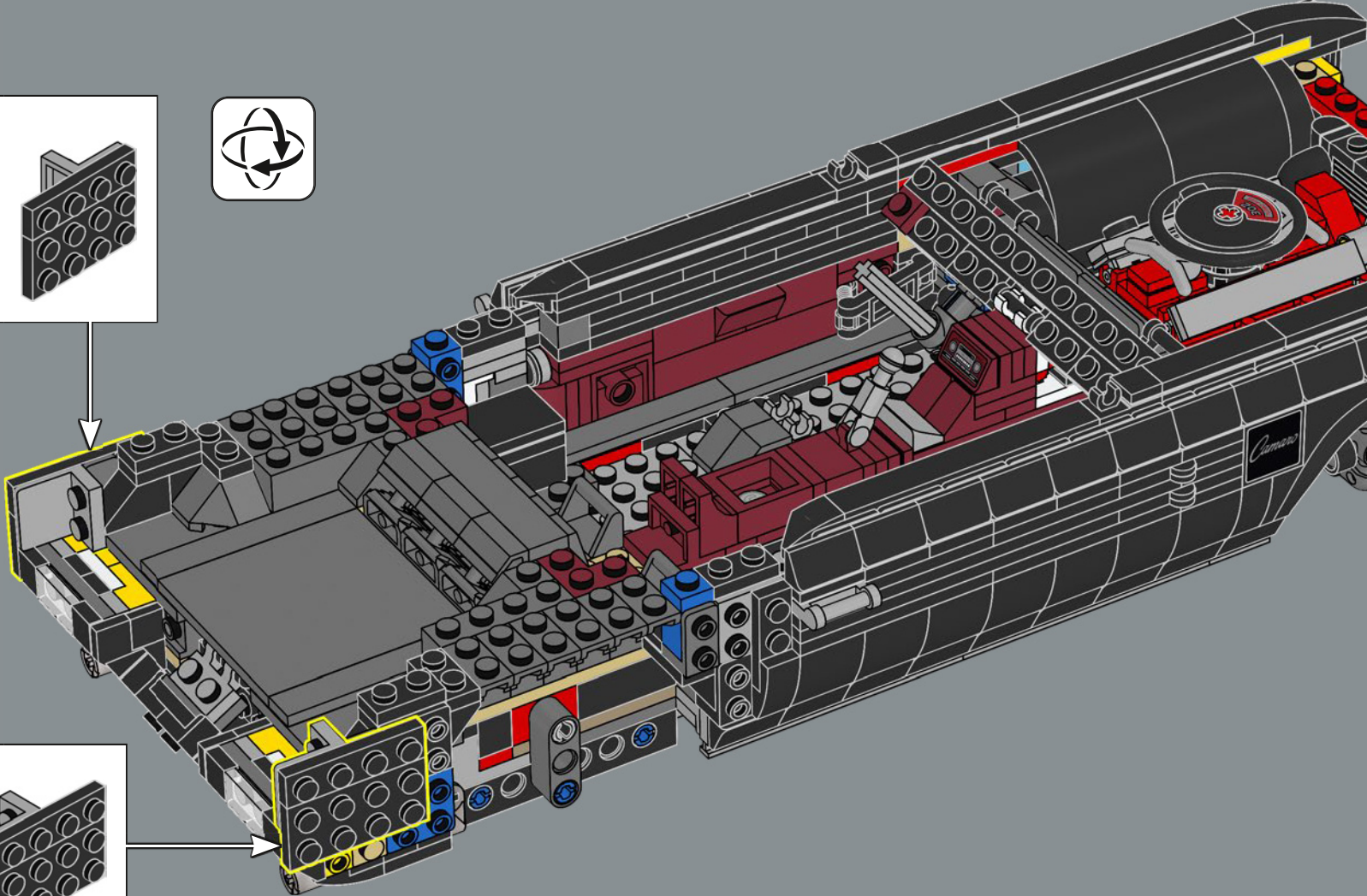
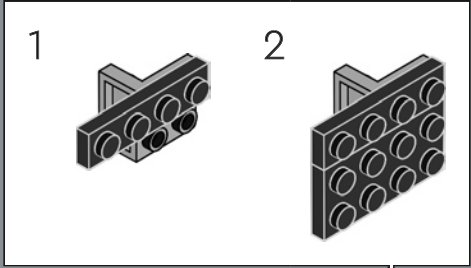

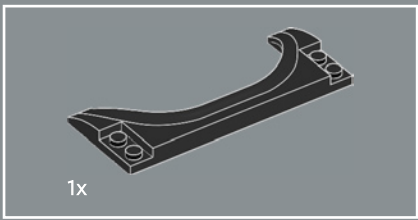

228

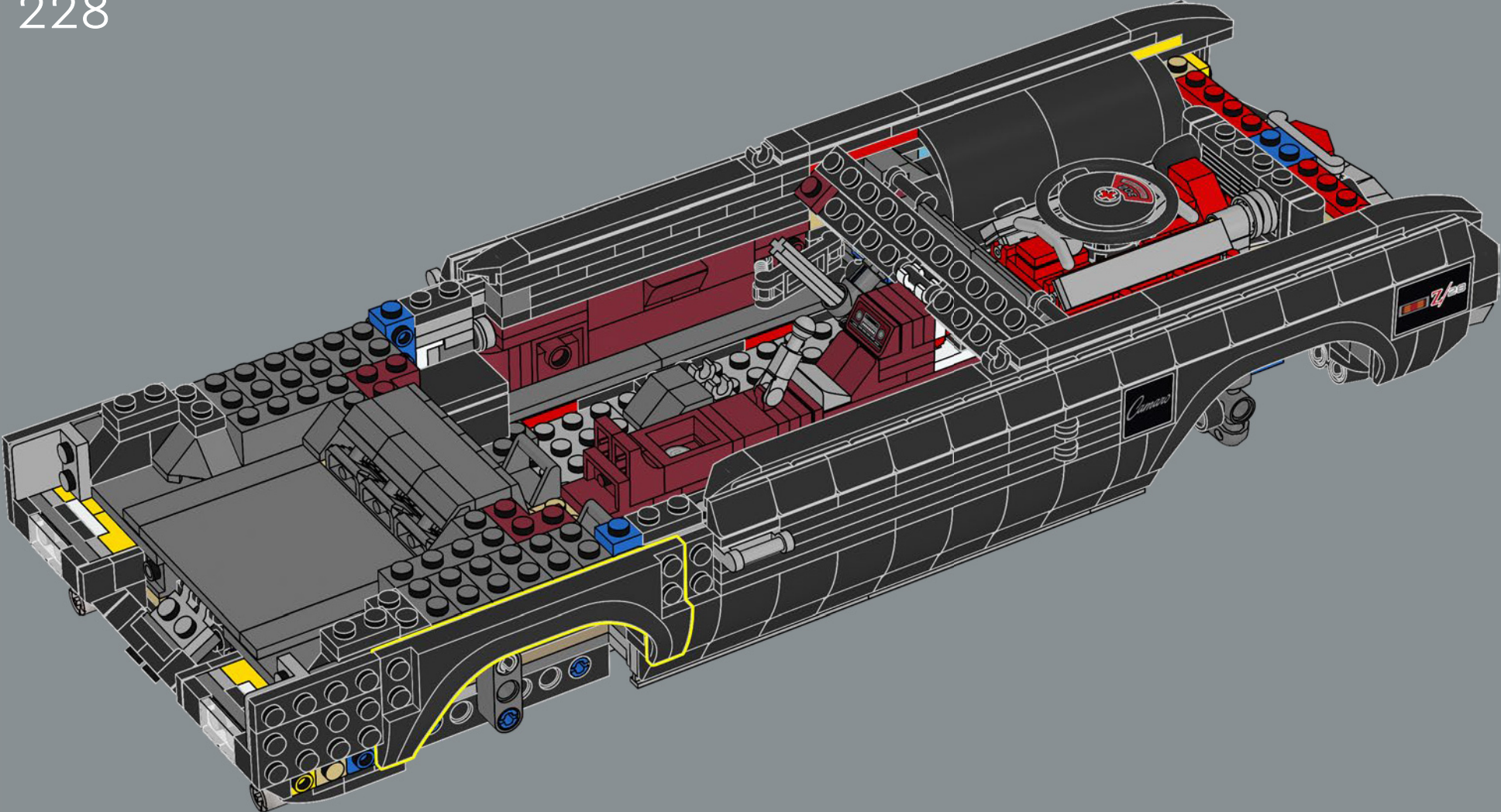

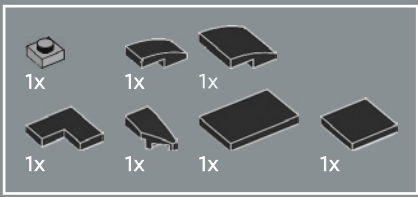

229

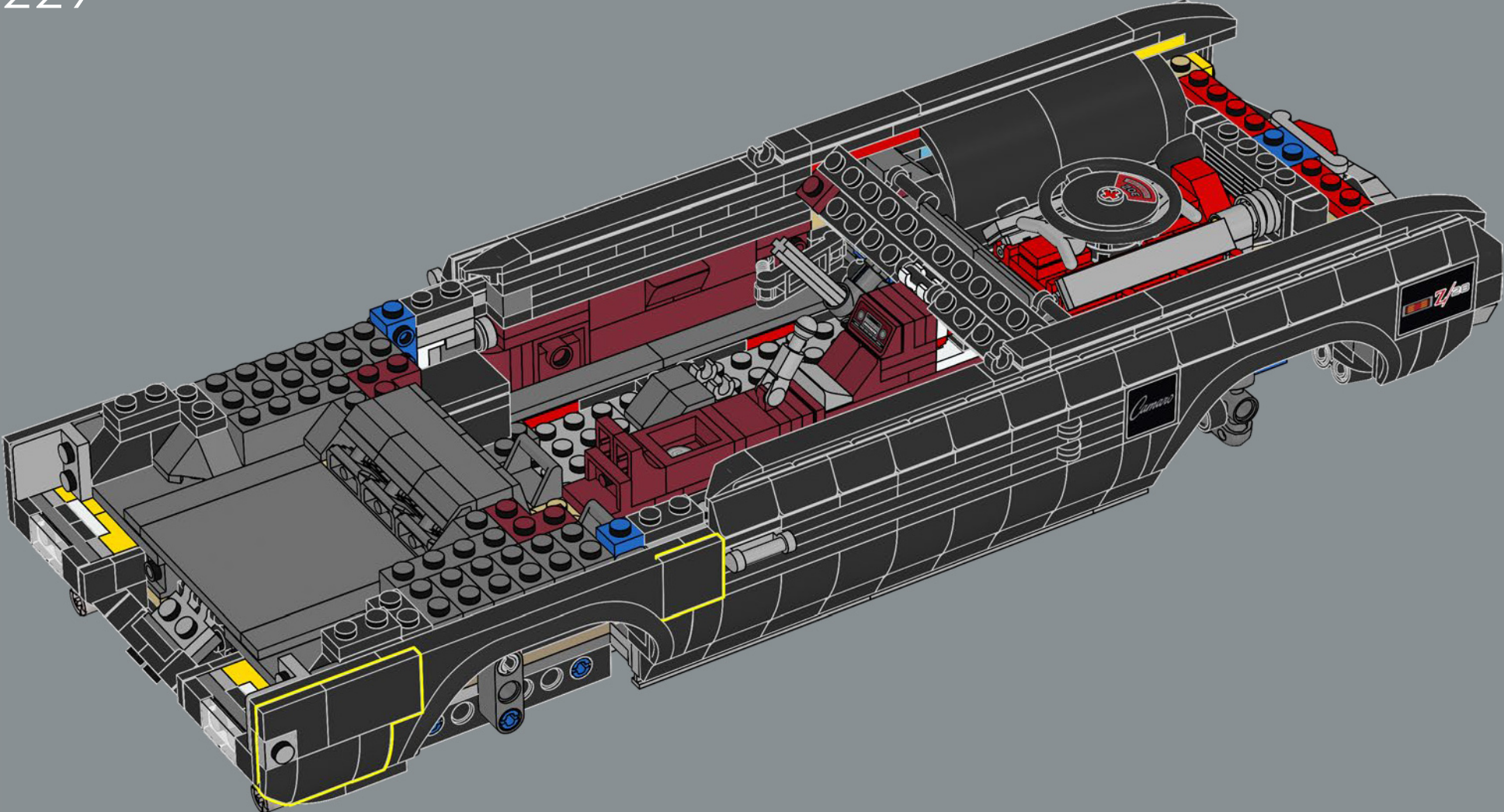

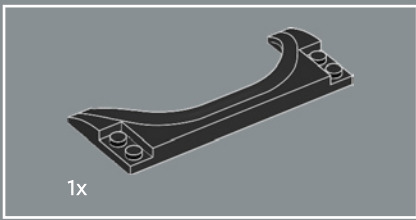

230

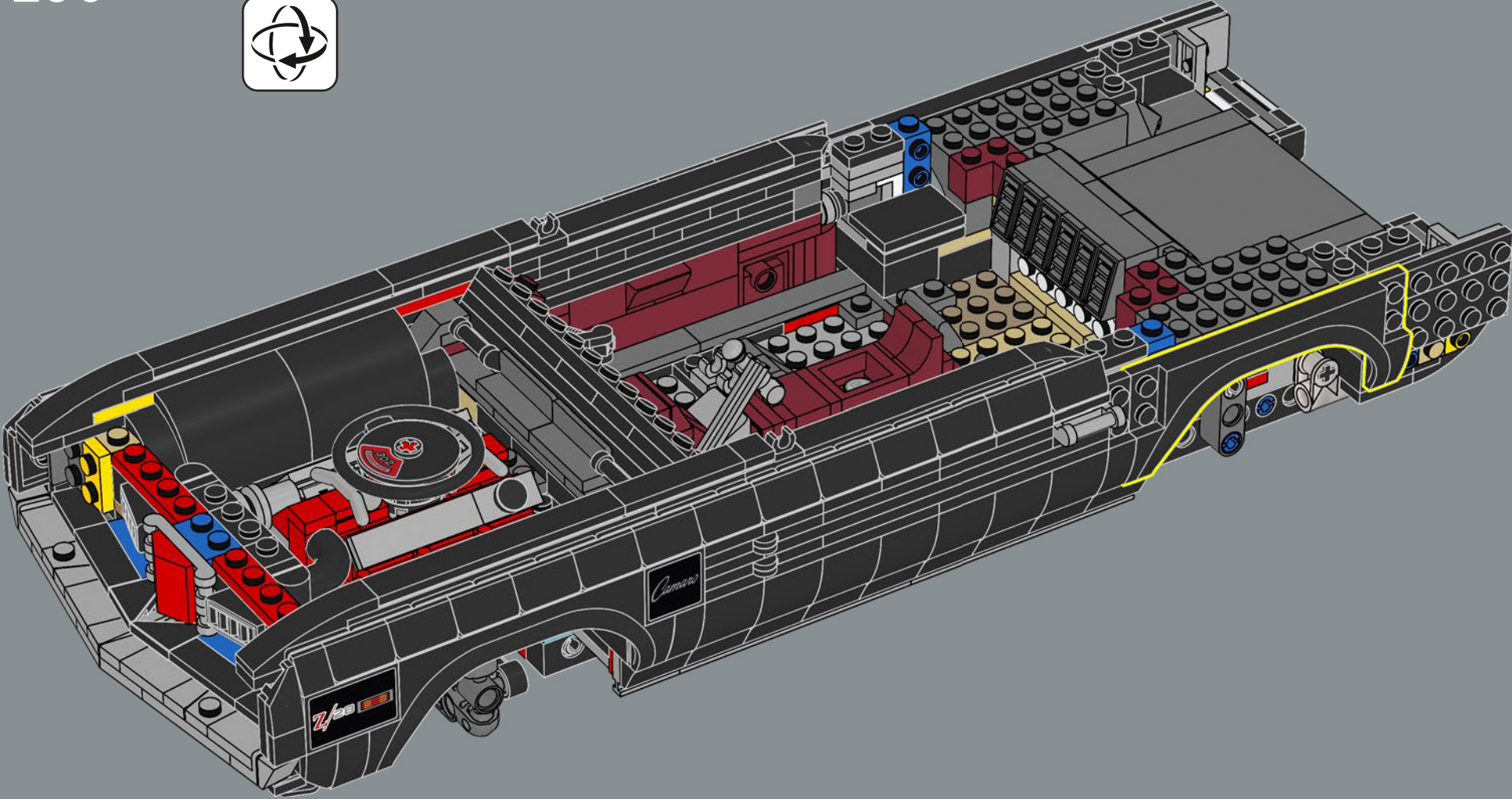

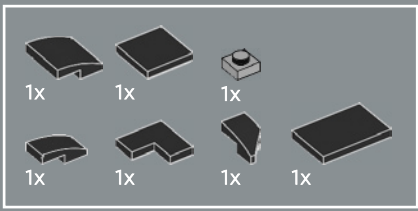

231

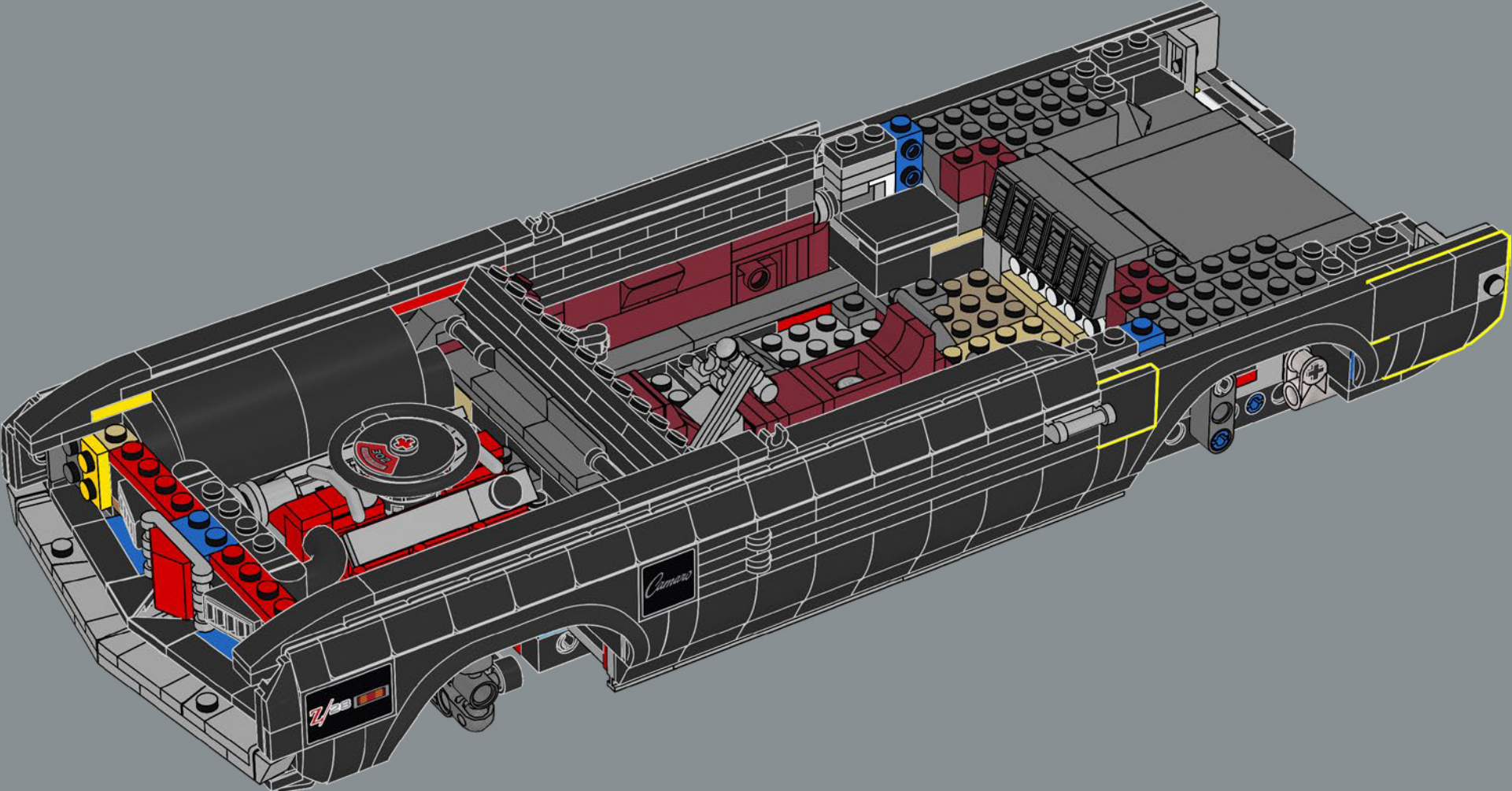

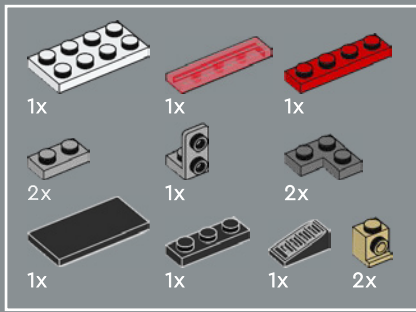

232

1



2



3

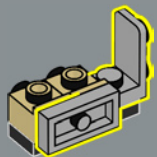

4

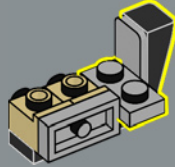

5

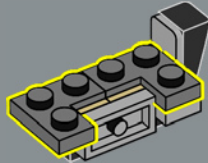

6

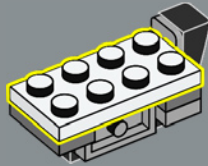

7

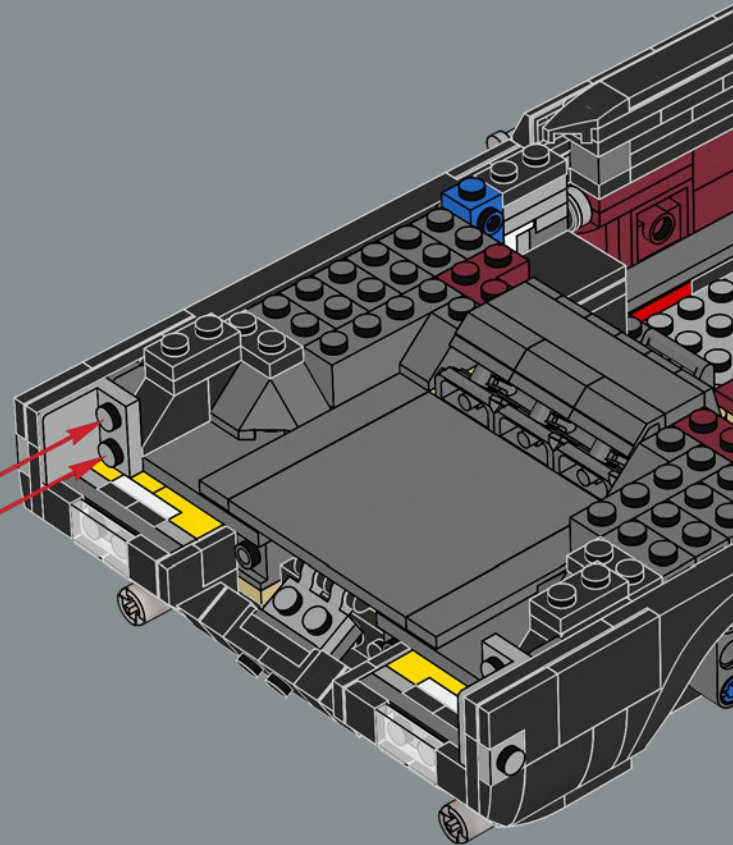
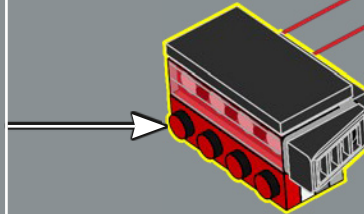
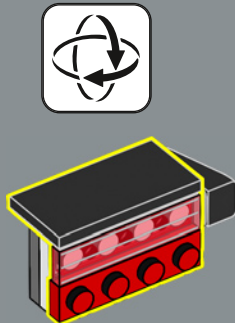

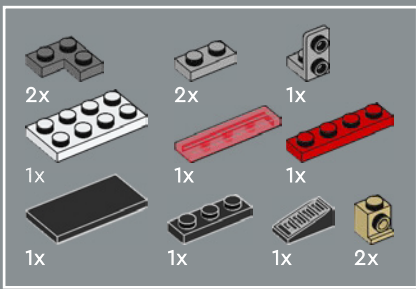

233

1



2

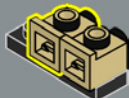

3

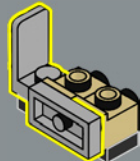

4

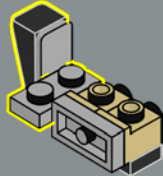

5

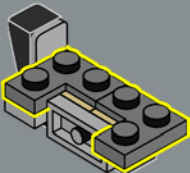

6

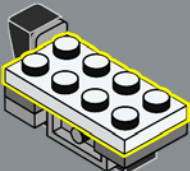

7

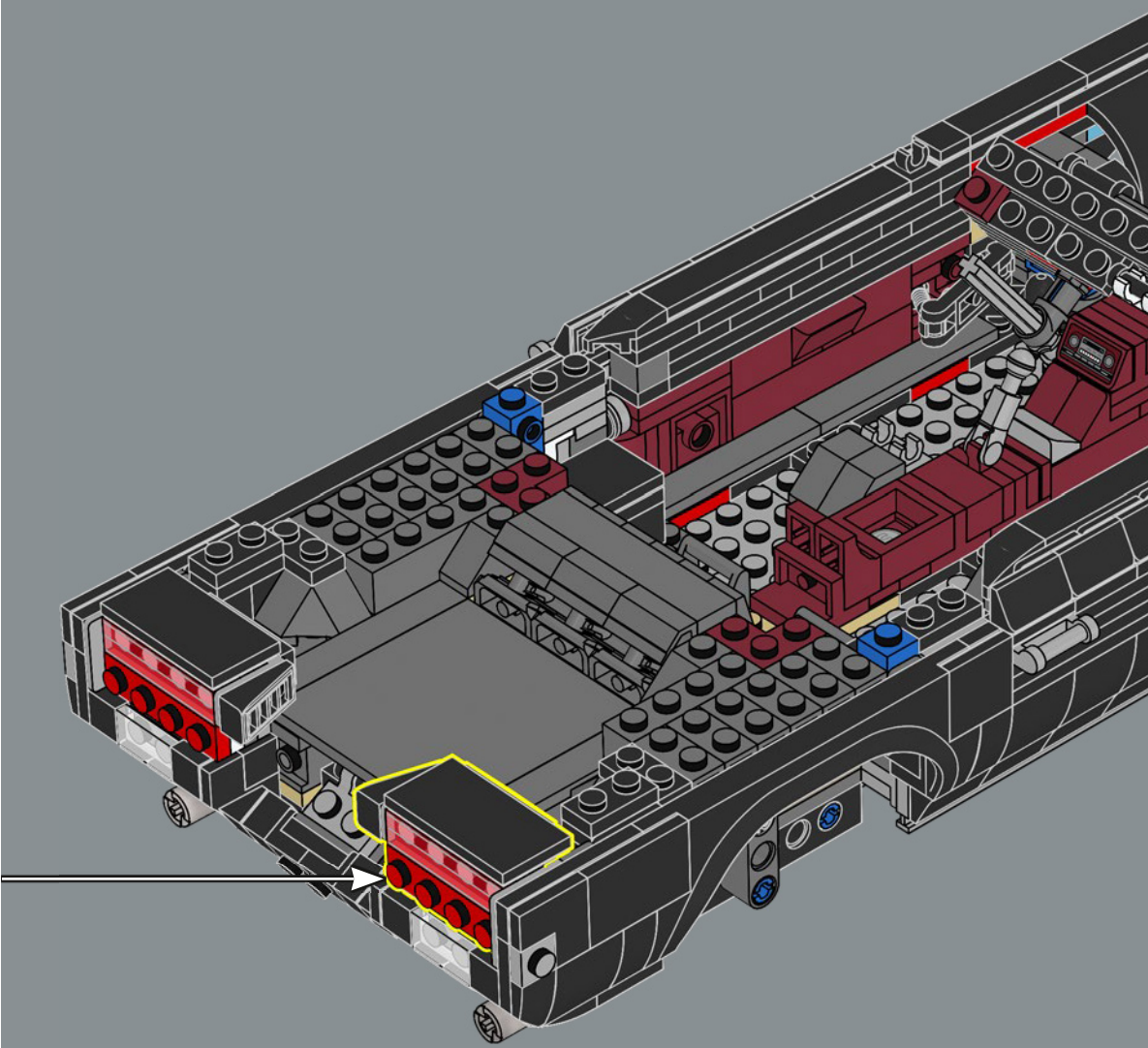
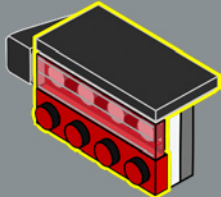

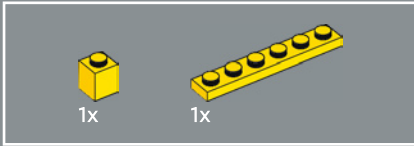
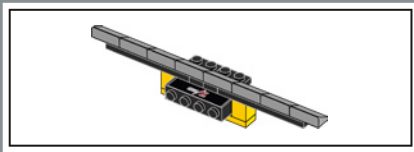

234

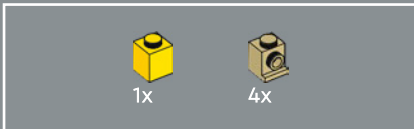
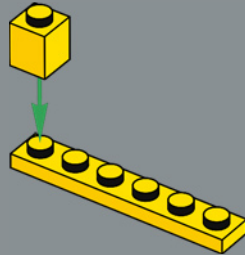

235

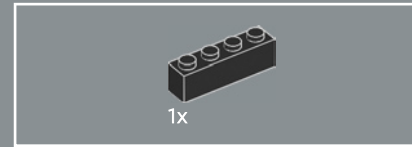
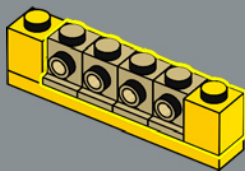

236

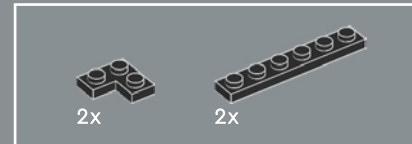
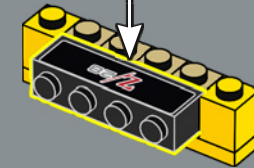
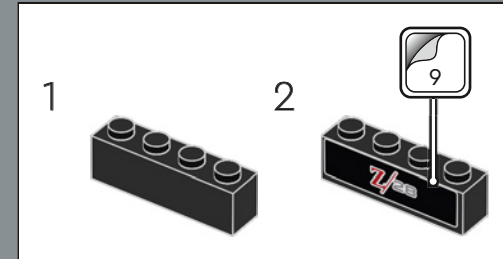

237

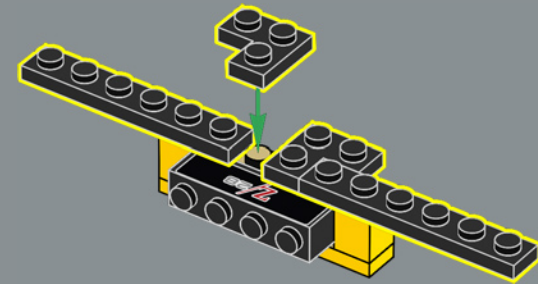



2x

238

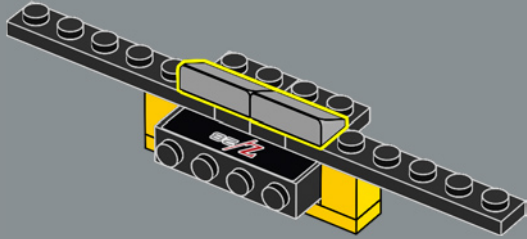

6x

239

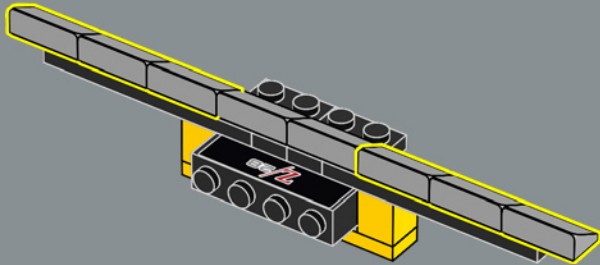

240

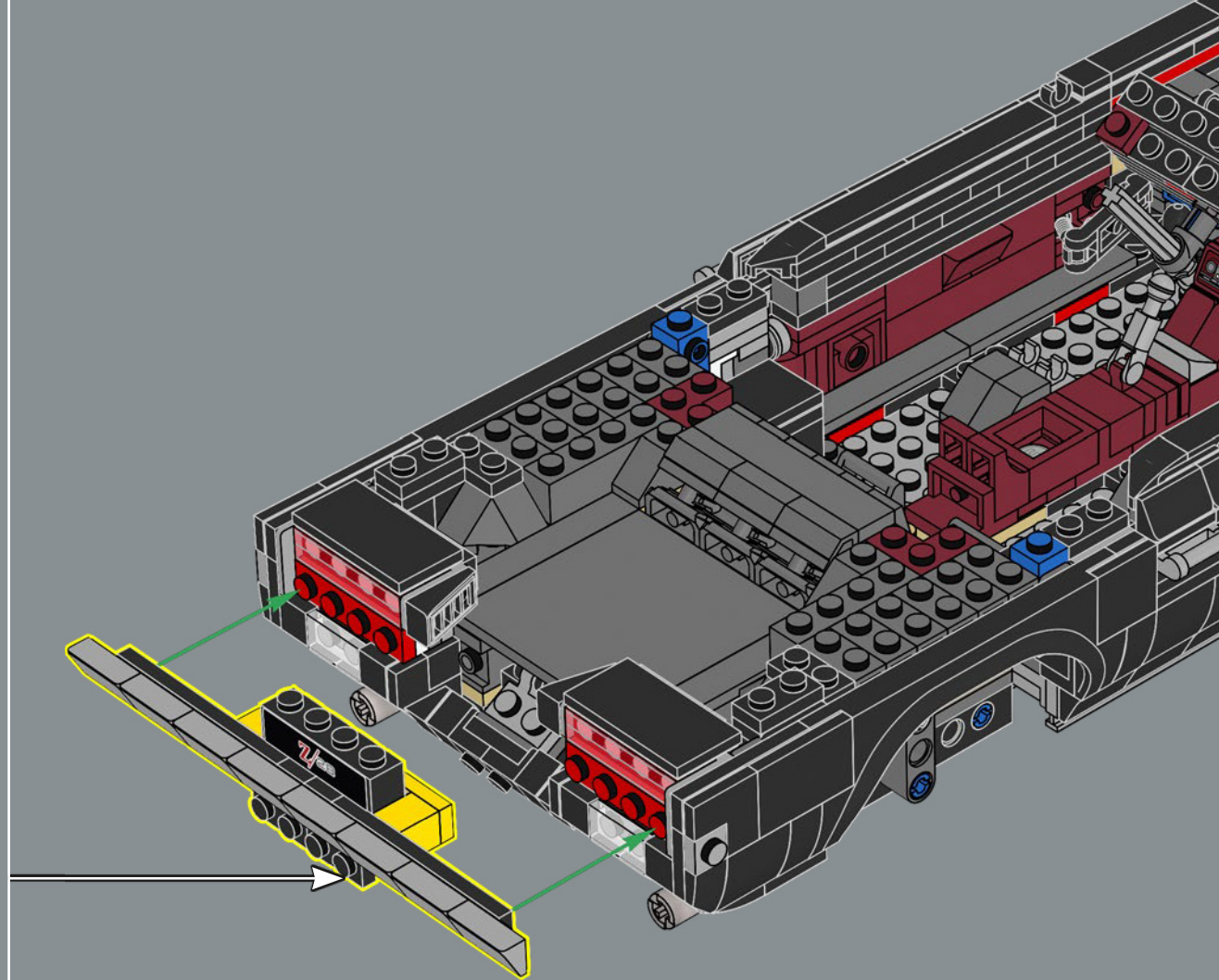

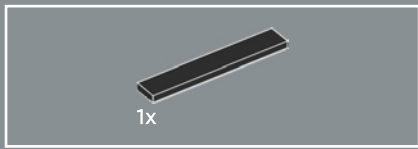

241

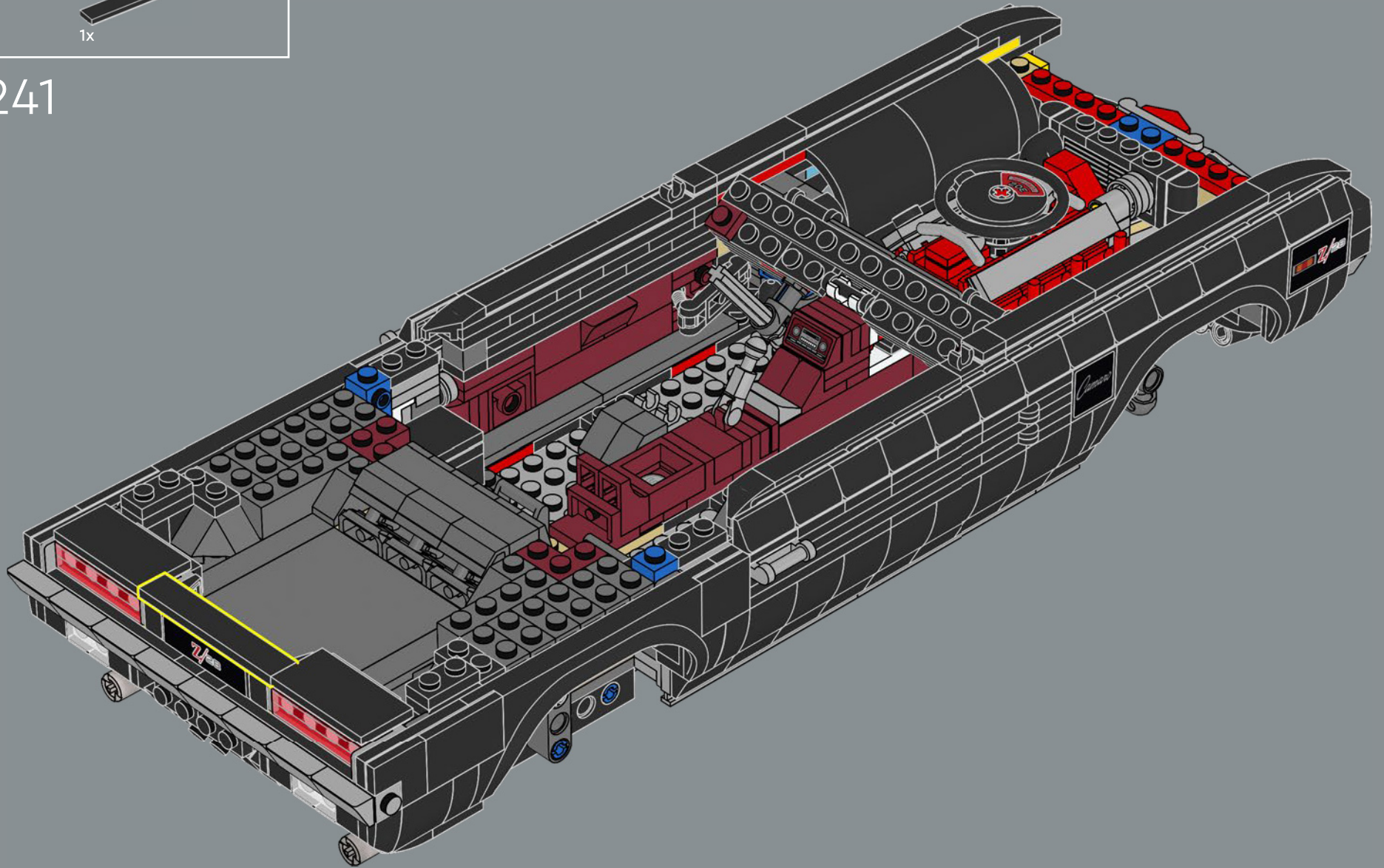

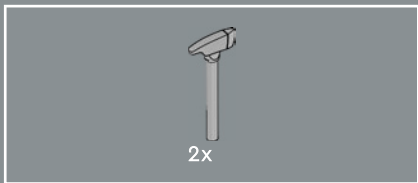

242

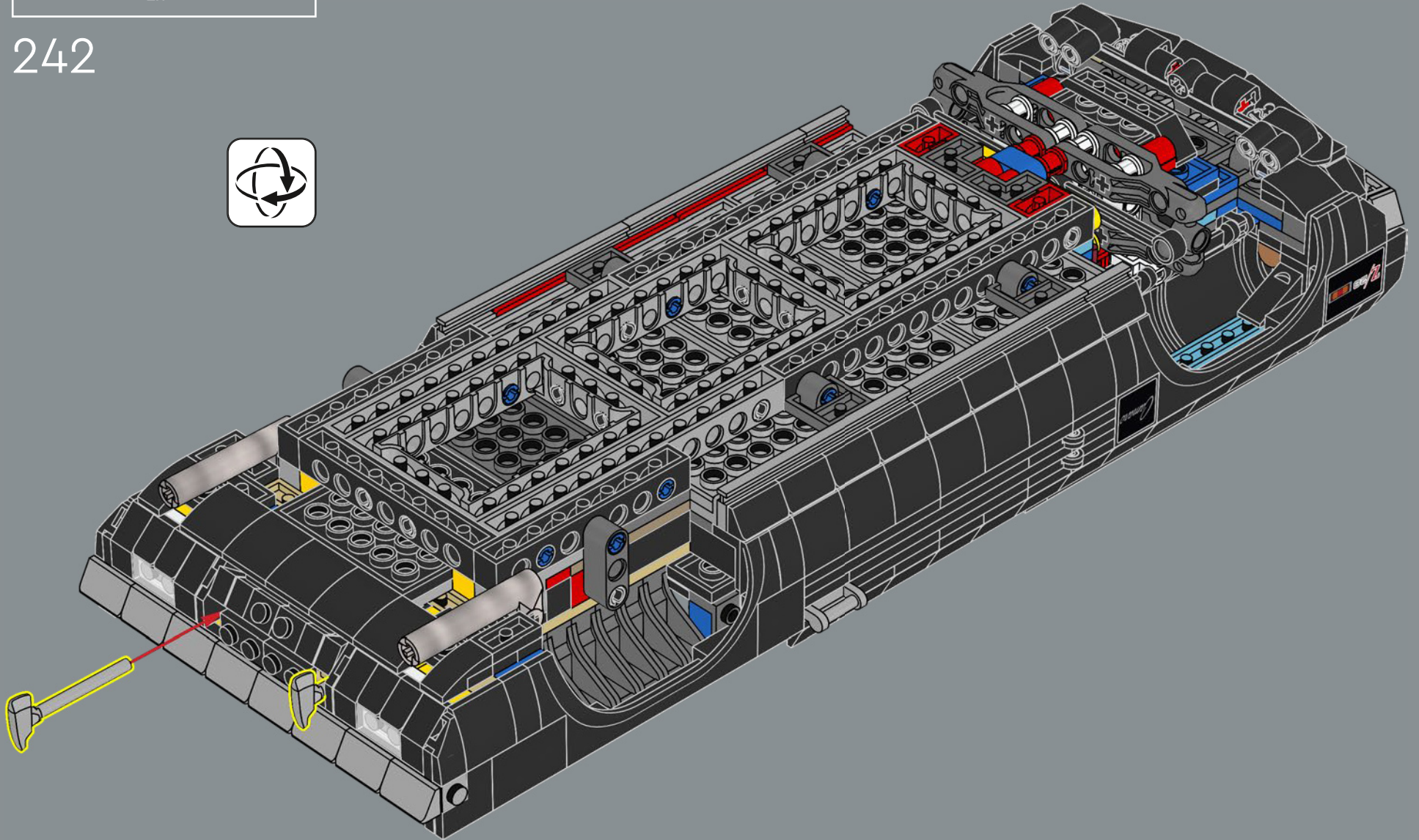

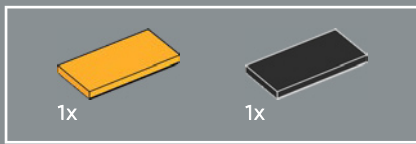

Im Gegensatz zu den meisten anderen Chevrolets wurden die Camaros der ersten 3 Generationen nicht in Detroit gebaut, sondern in den Werken in Norwood (Ohio) und Van Nuys (Kalifornien) produziert.

243

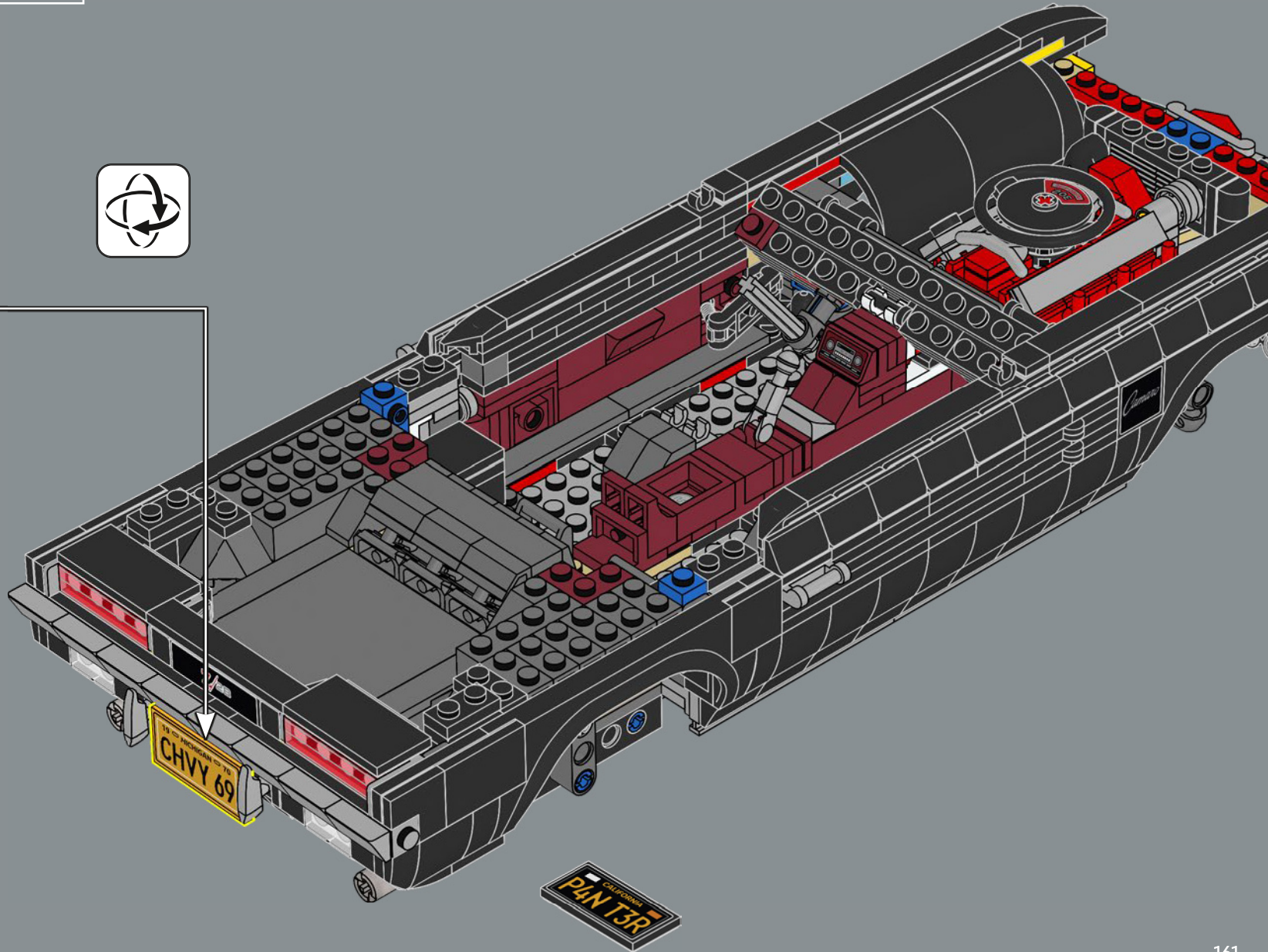
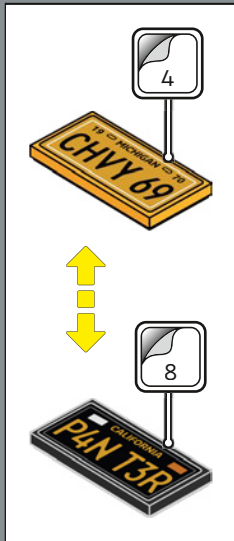

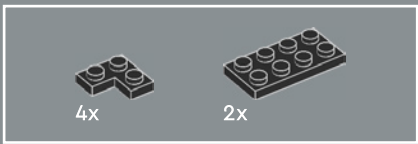

244

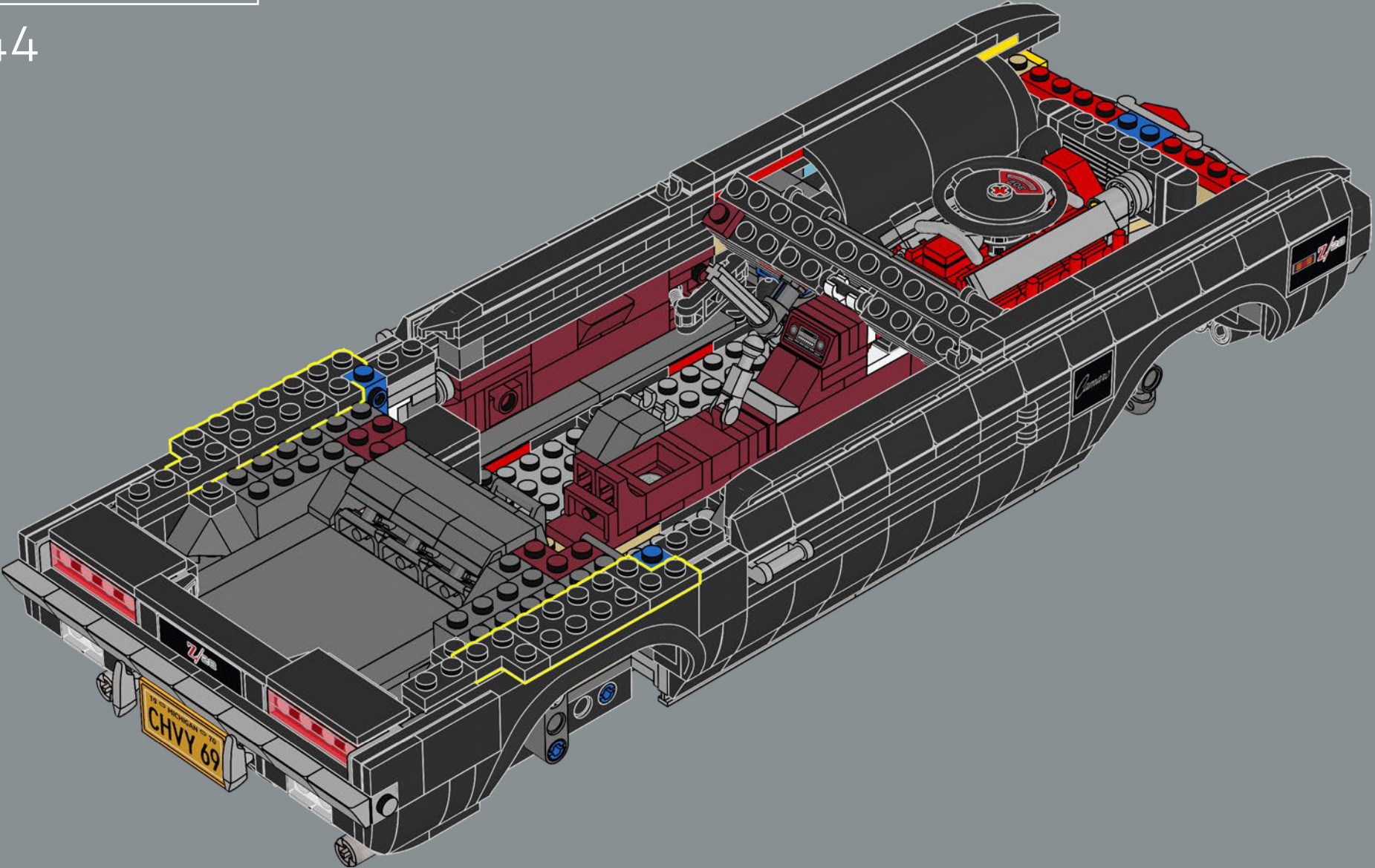

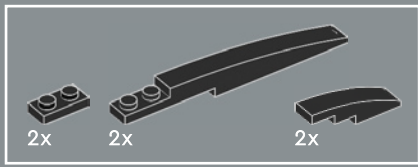

245

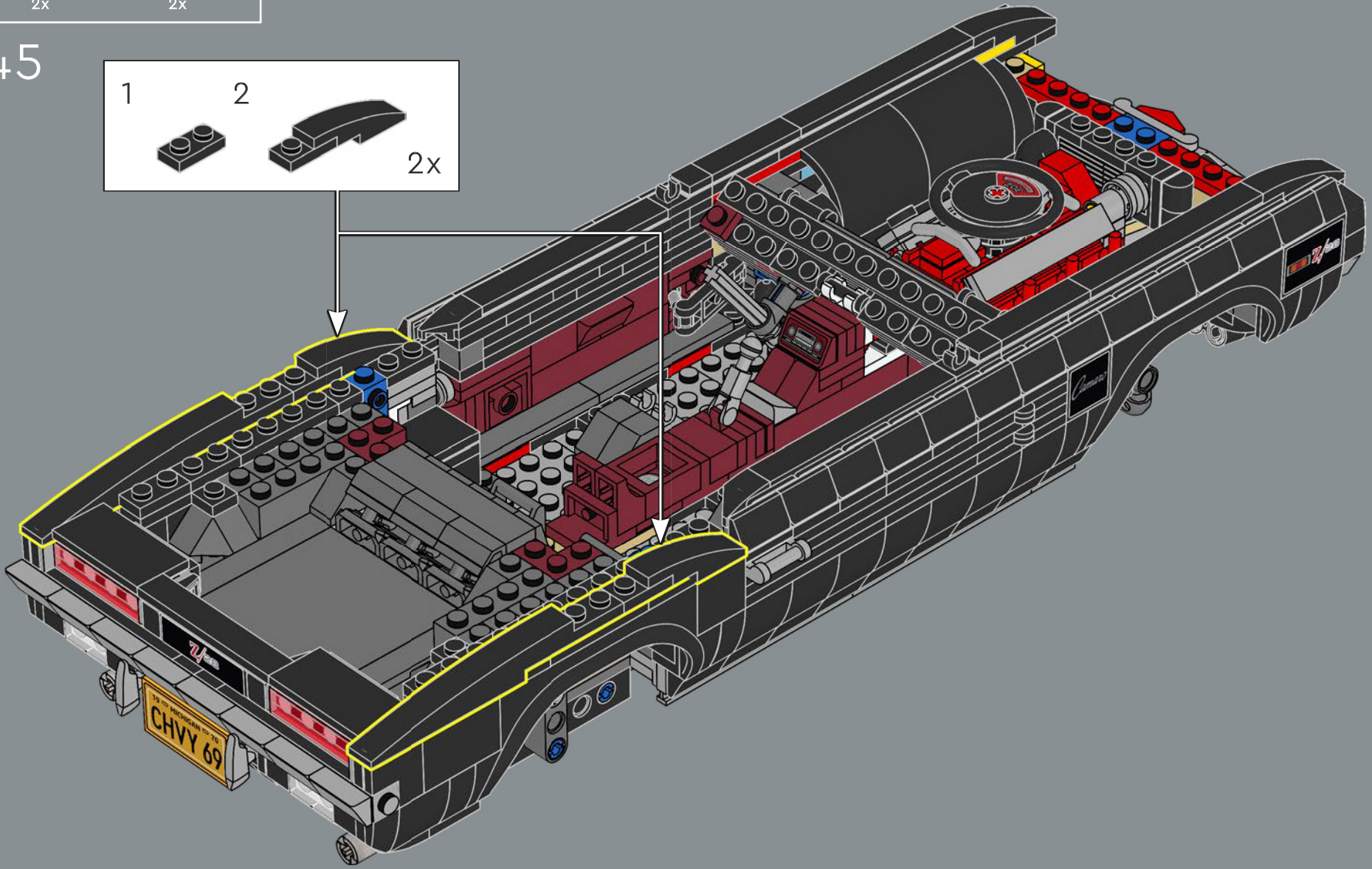
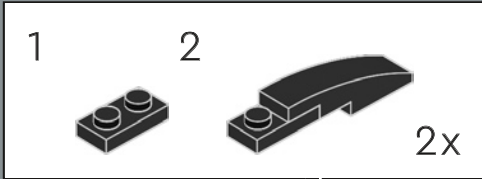

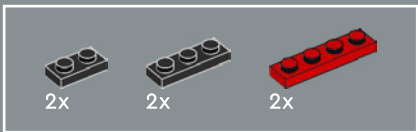

246

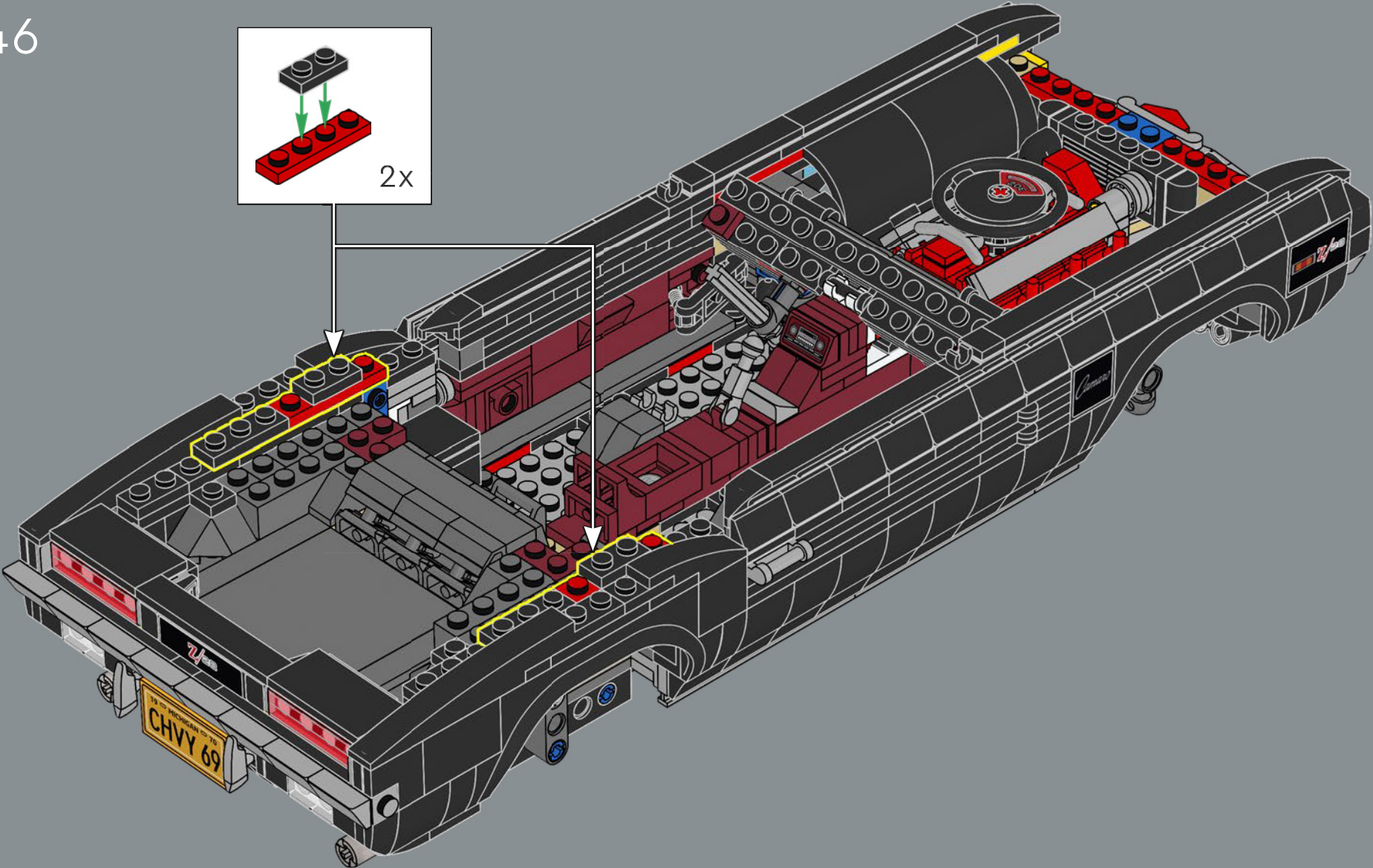
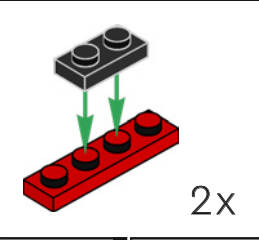

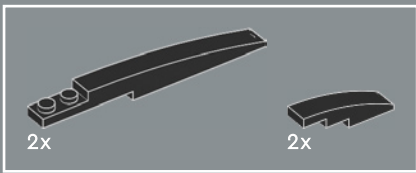

247

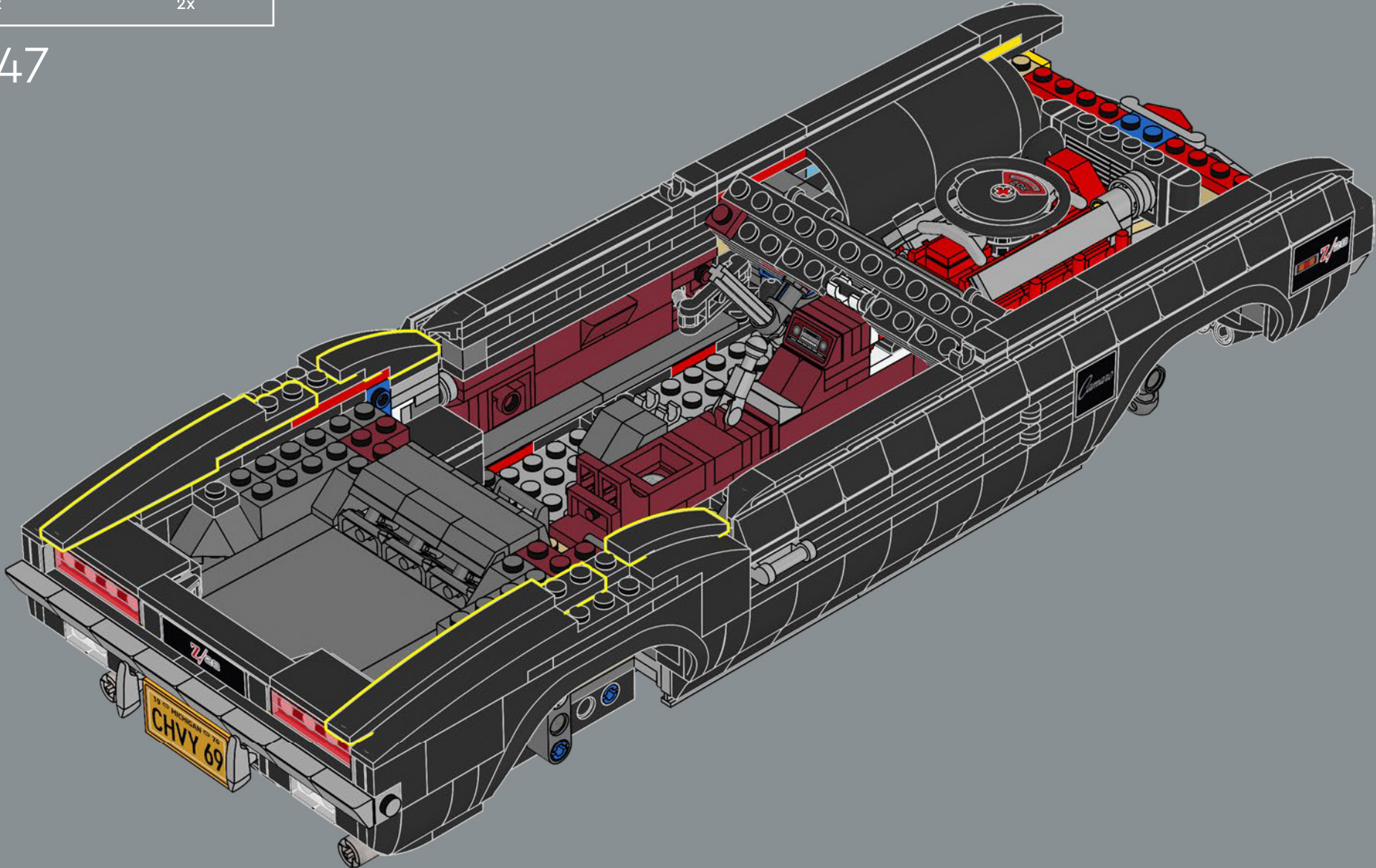

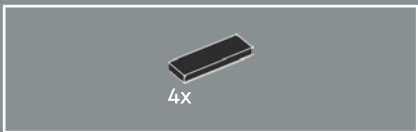

248

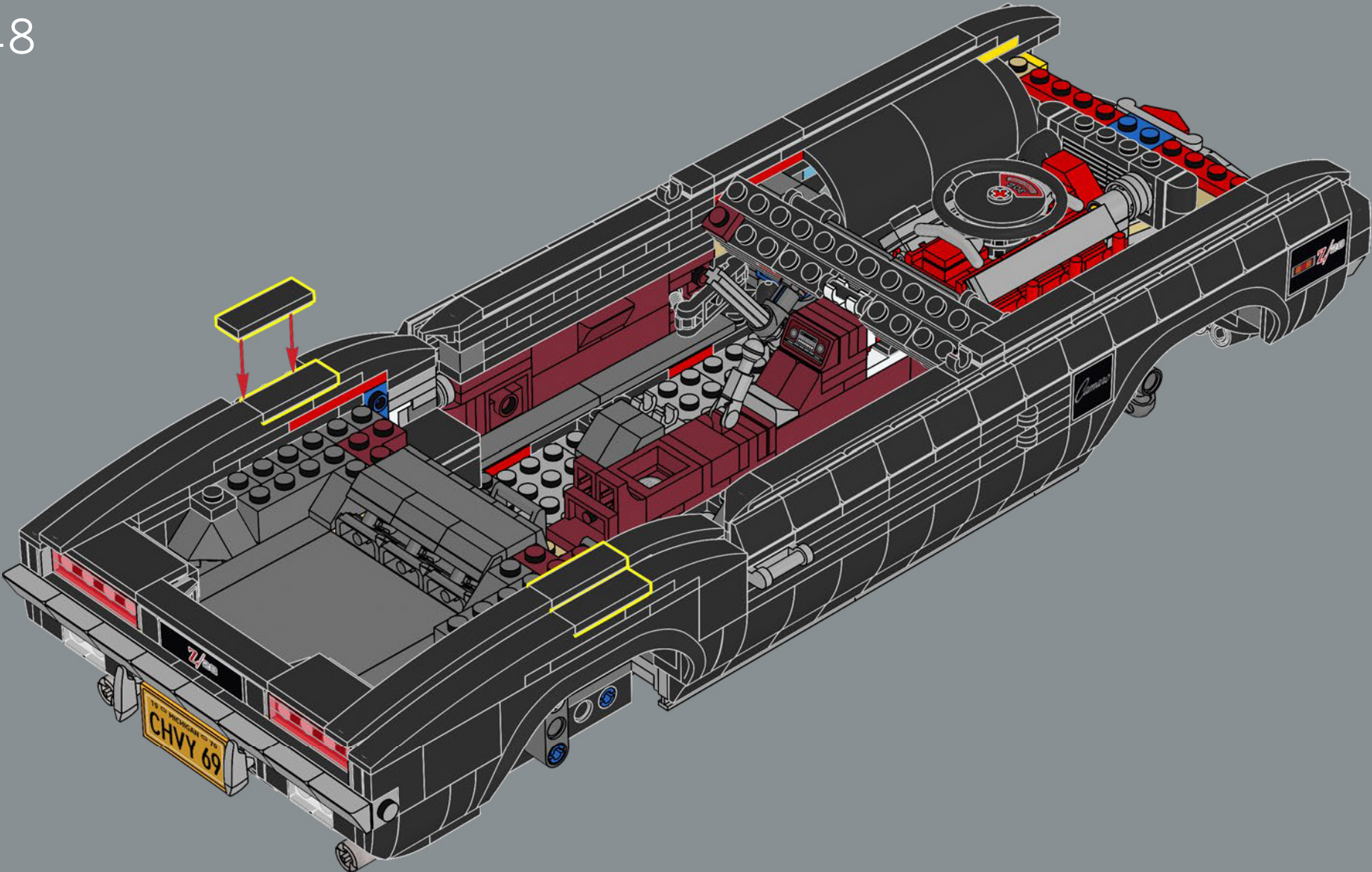

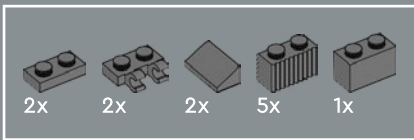

249

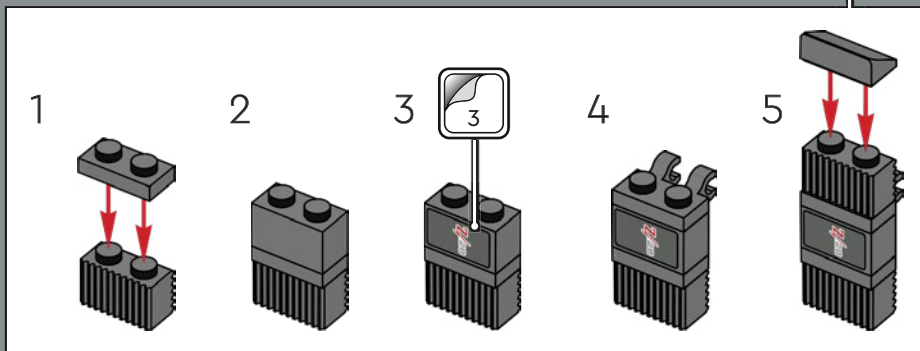
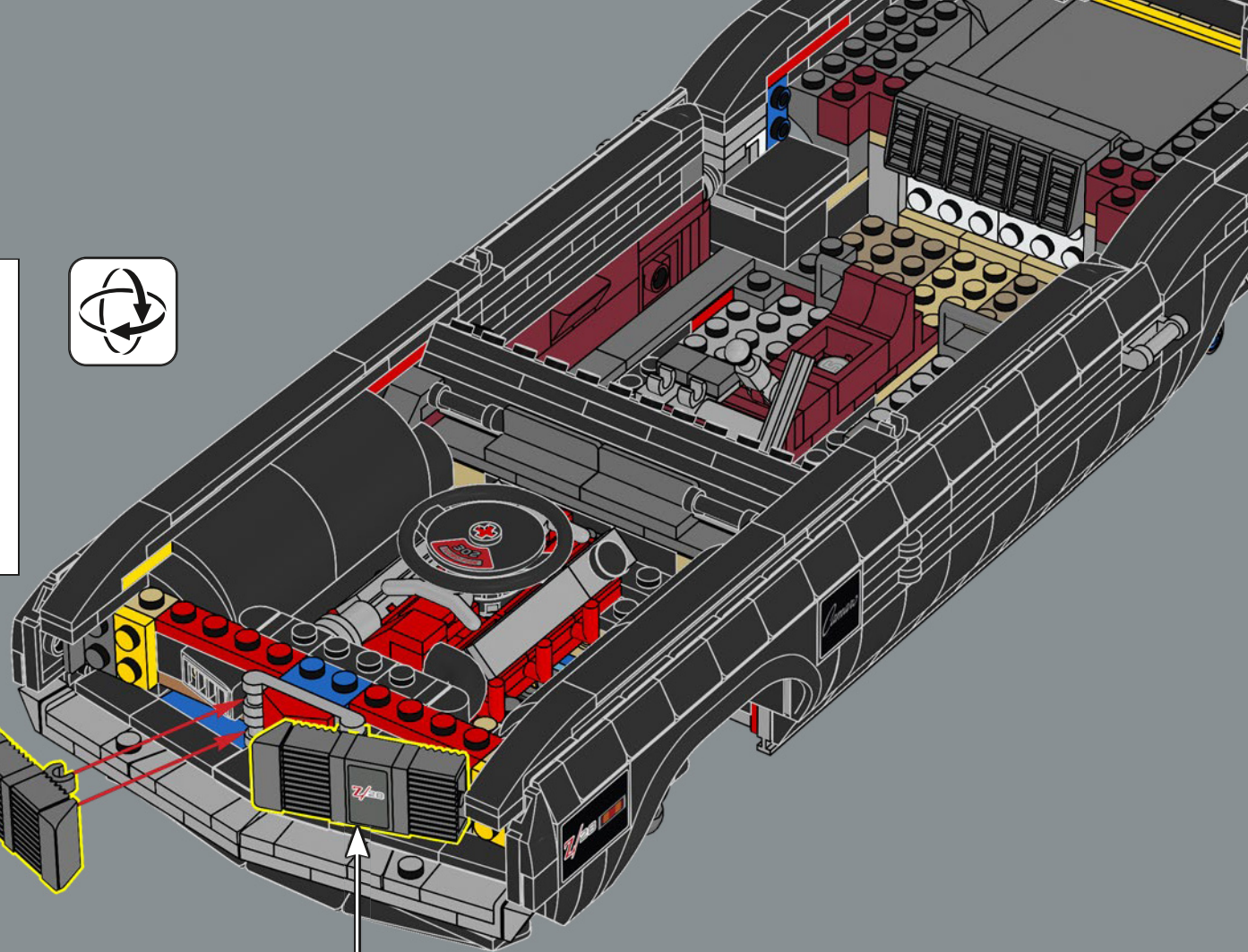
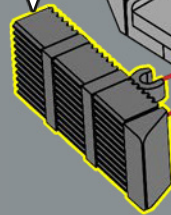
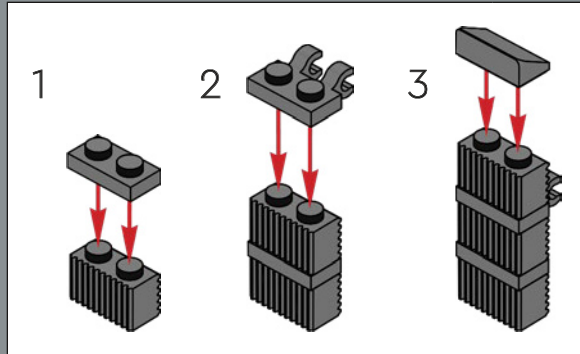

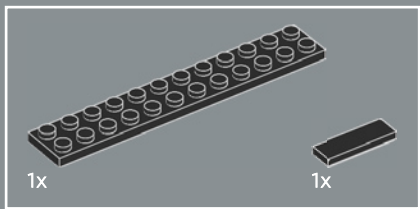

250

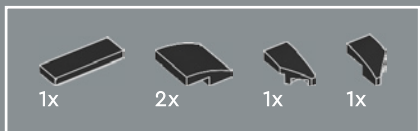
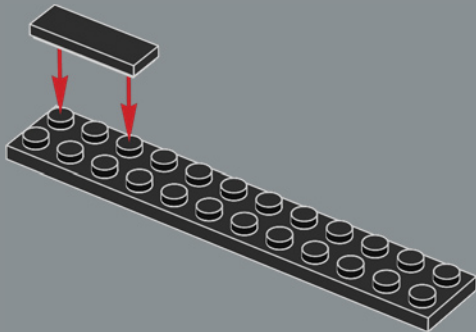

251

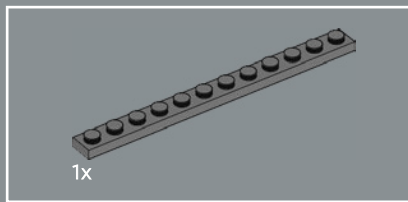
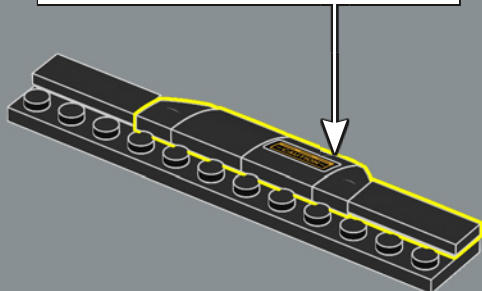
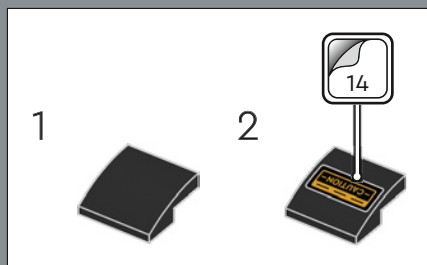

252

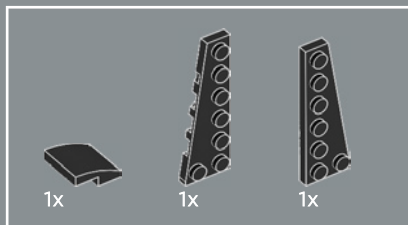
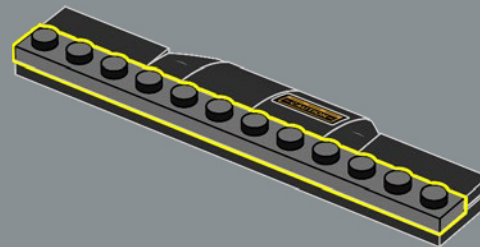

253

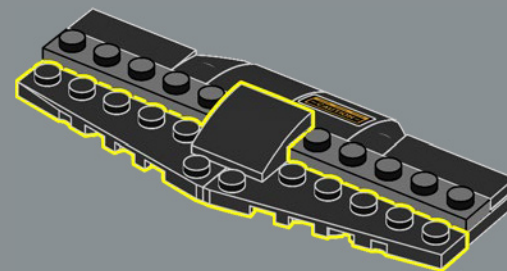



254

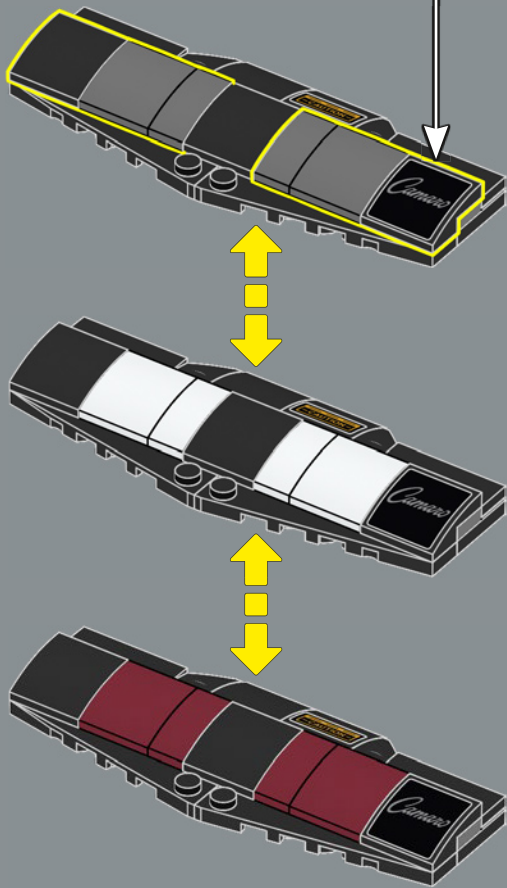
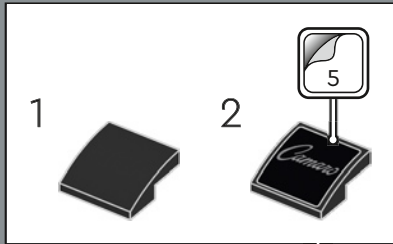

255

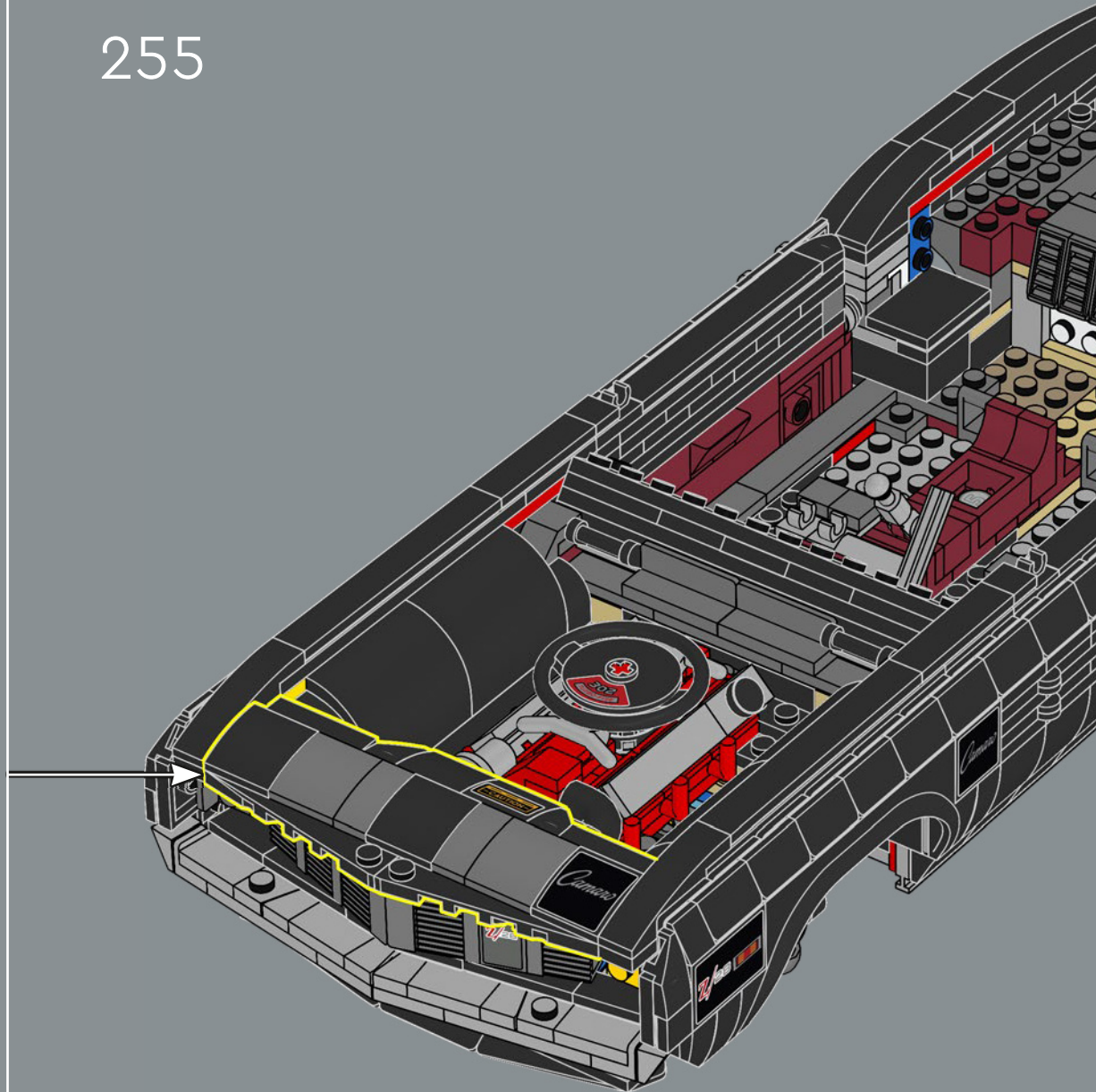

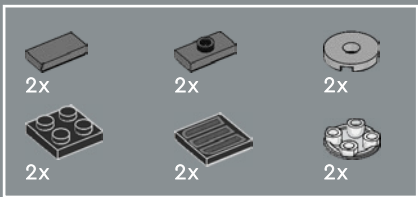

256

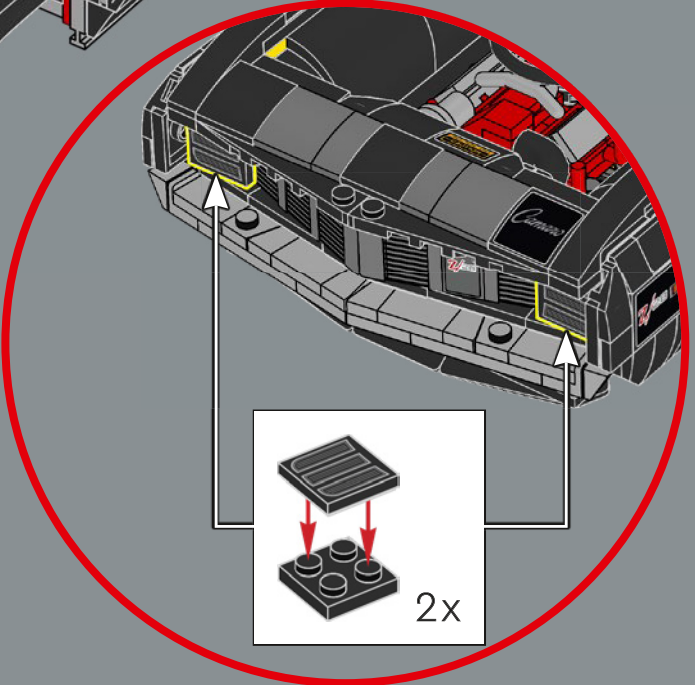
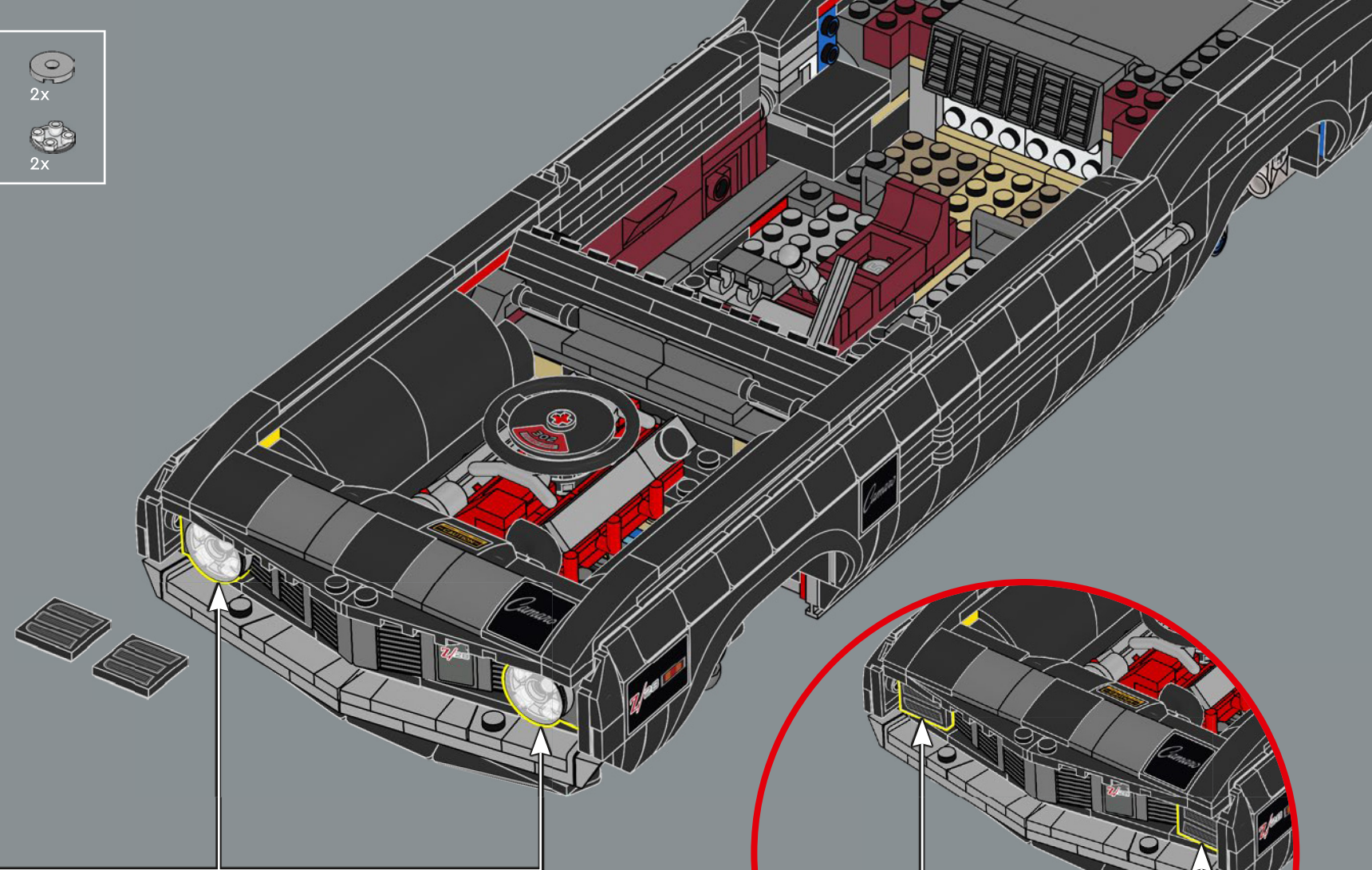
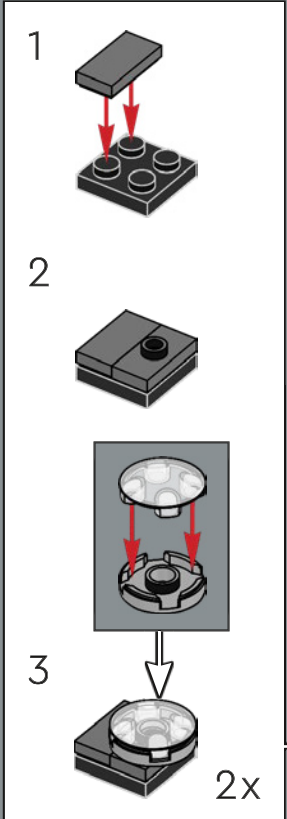

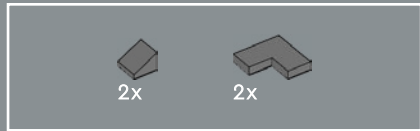

257

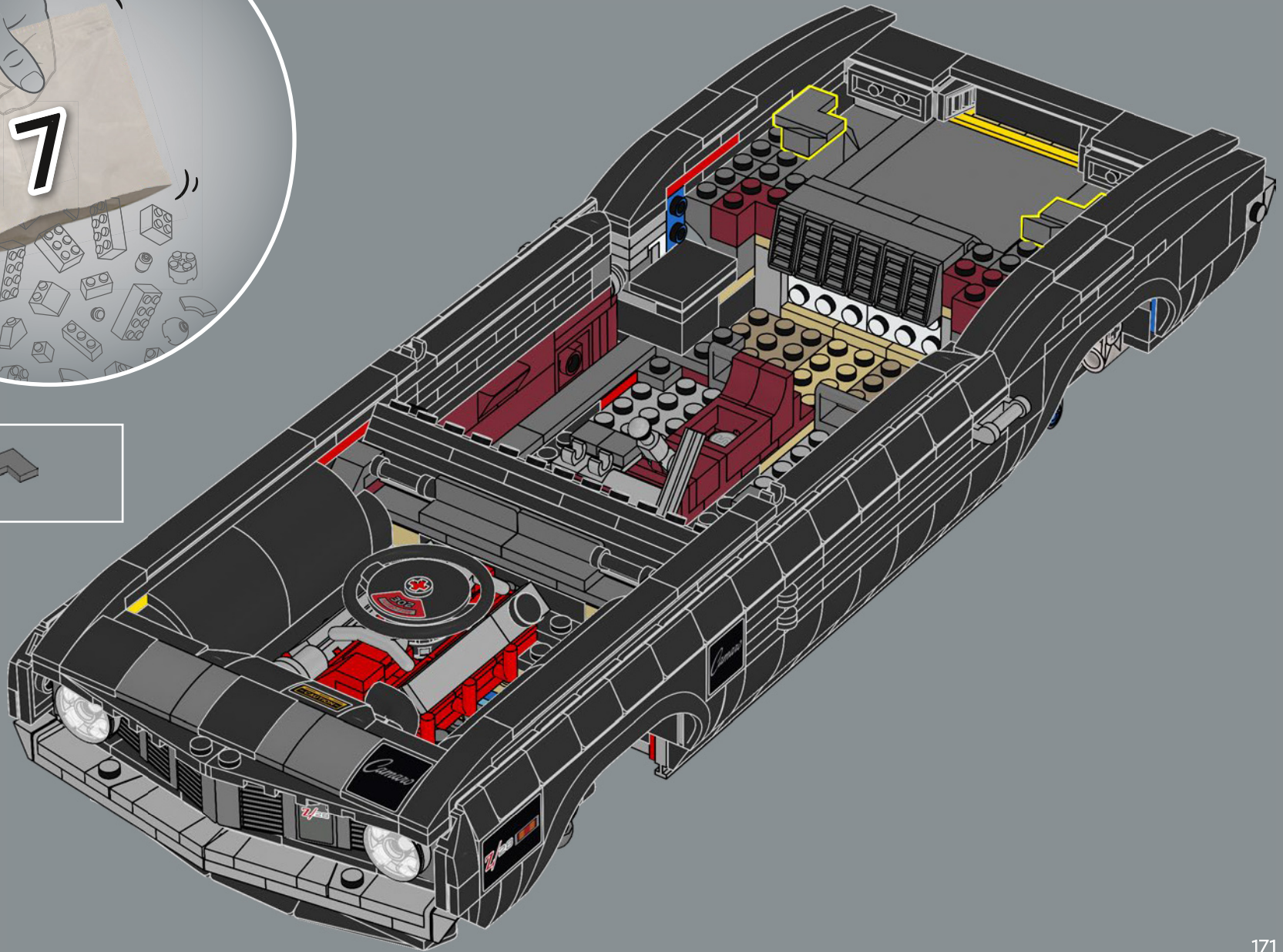

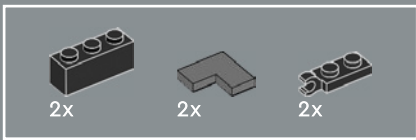

258

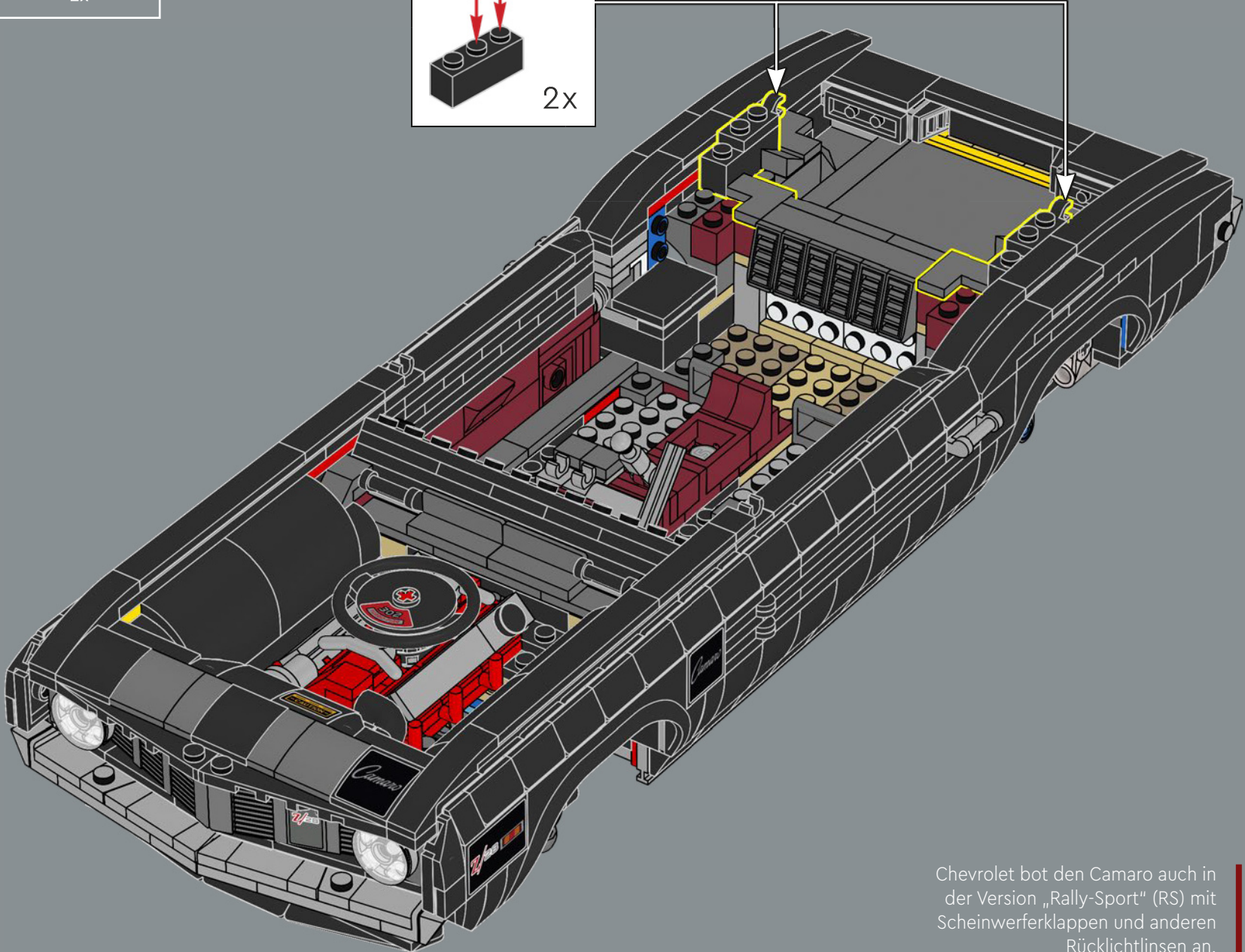
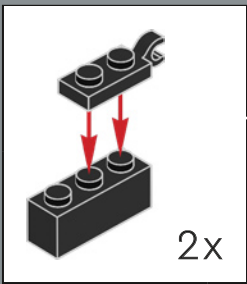

Chevrolet bot den Camaro auch in der Version „Rally-Sport“ (RS) mit Scheinwerferklappen und anderen Rücklichtlinsen an.

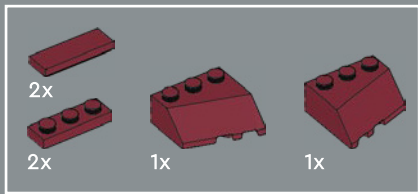

259

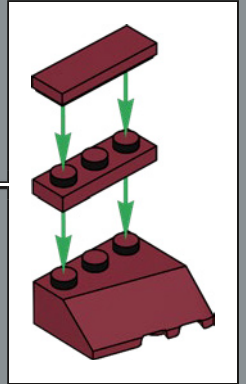
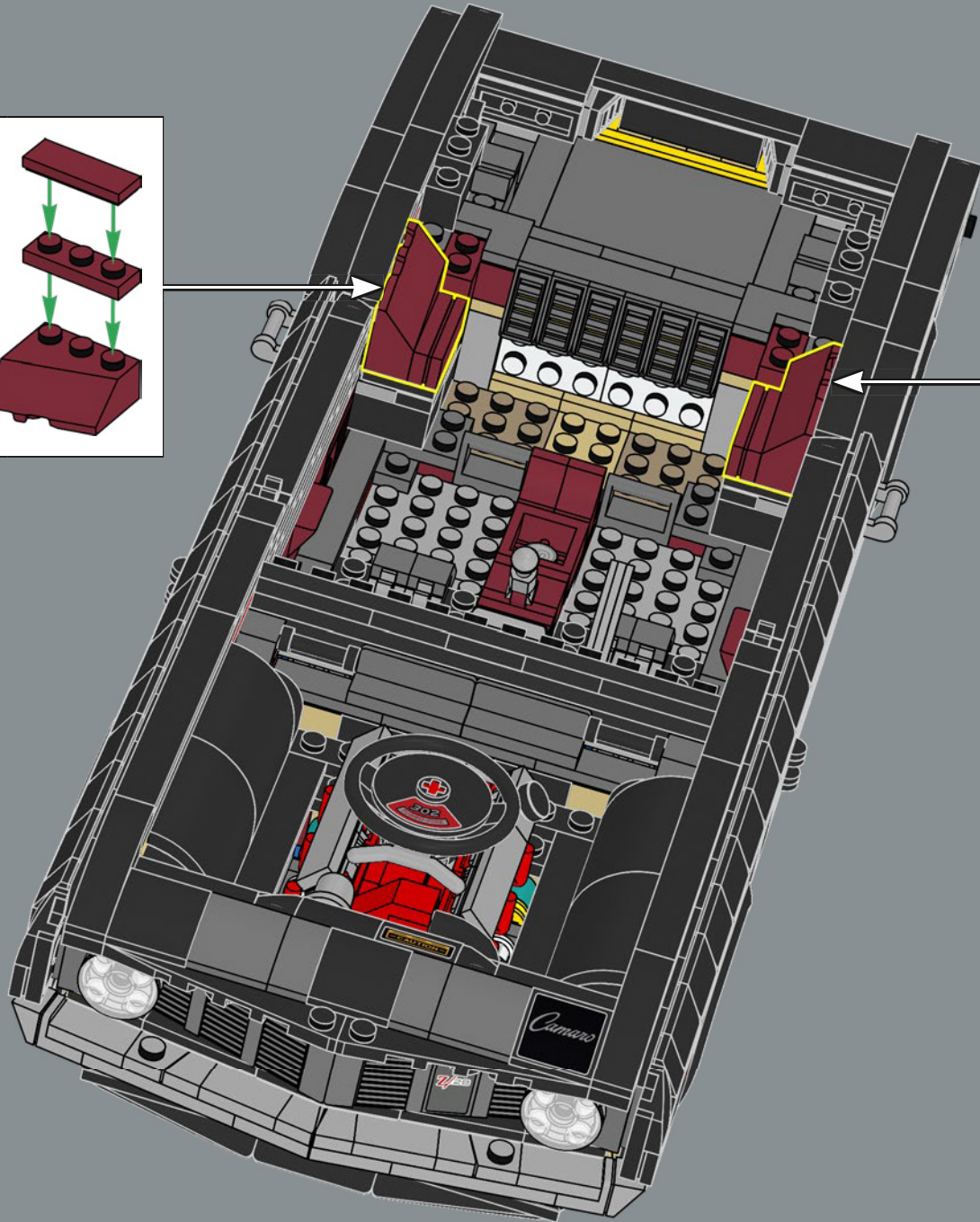
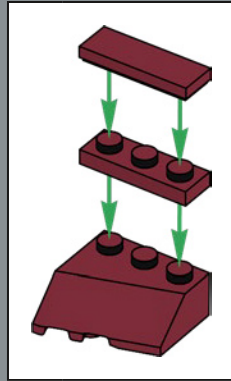

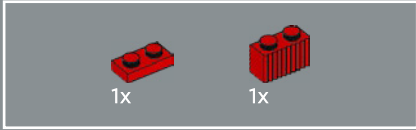

260

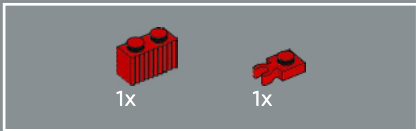
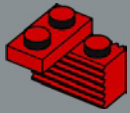

261

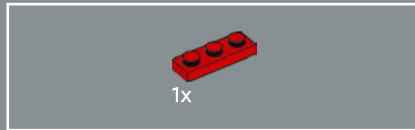
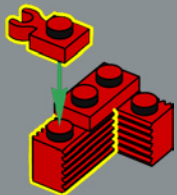

262

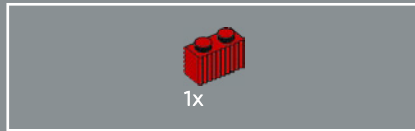
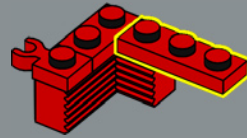

263

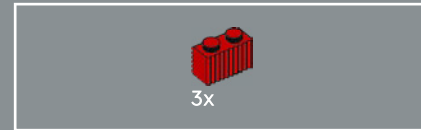
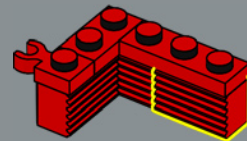

264

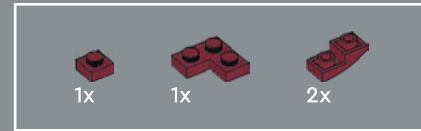
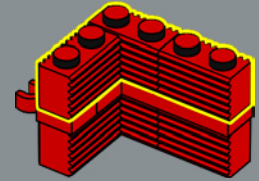

265

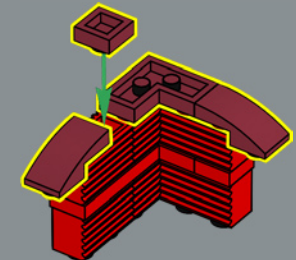

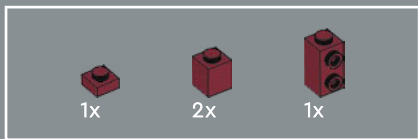

266

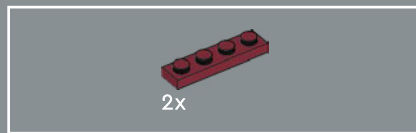
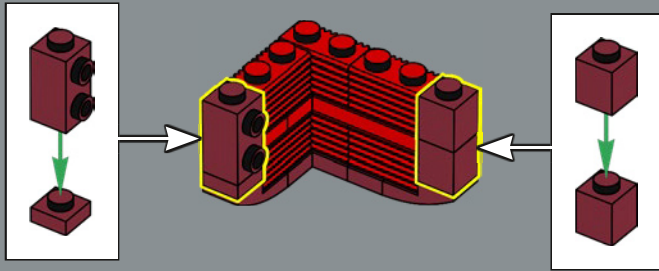

268

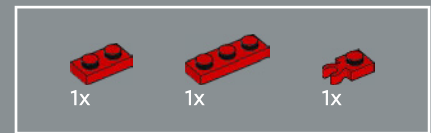
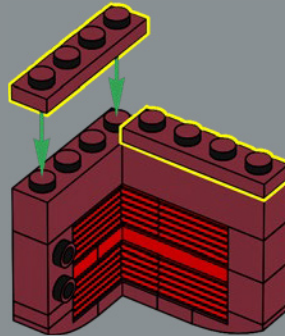

270

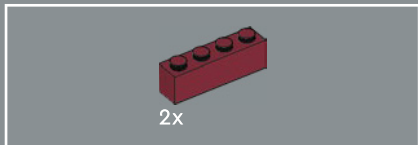
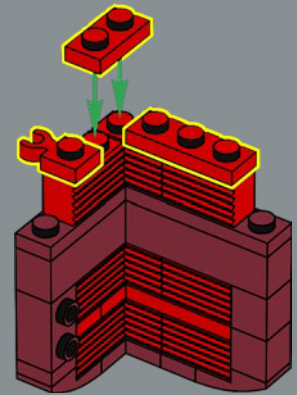

267

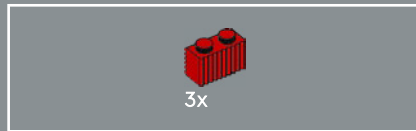
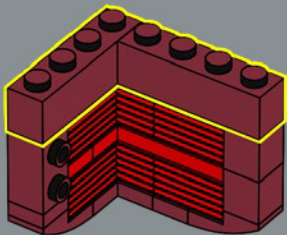

269

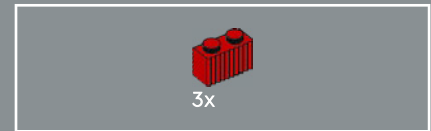
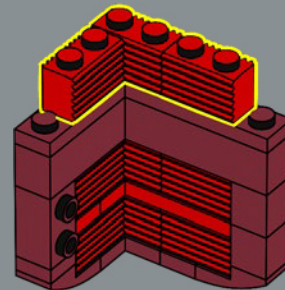

271

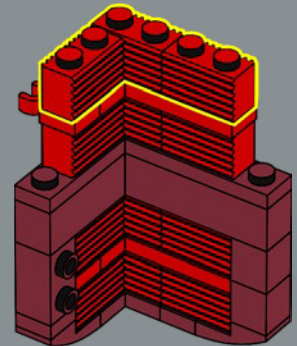



4x

272

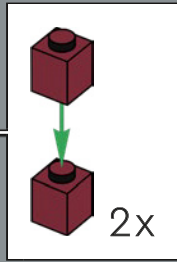
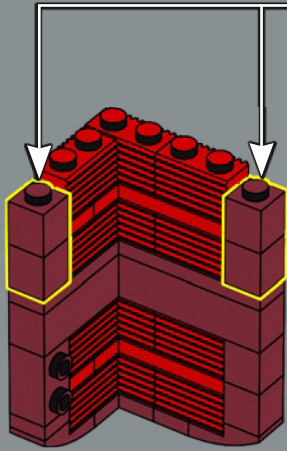

2x

1x

2x

1x

273

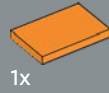
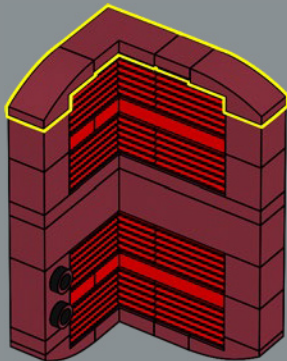

1x

274



15

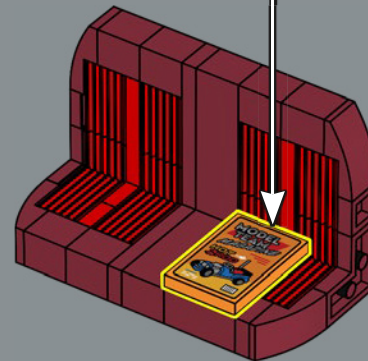

275

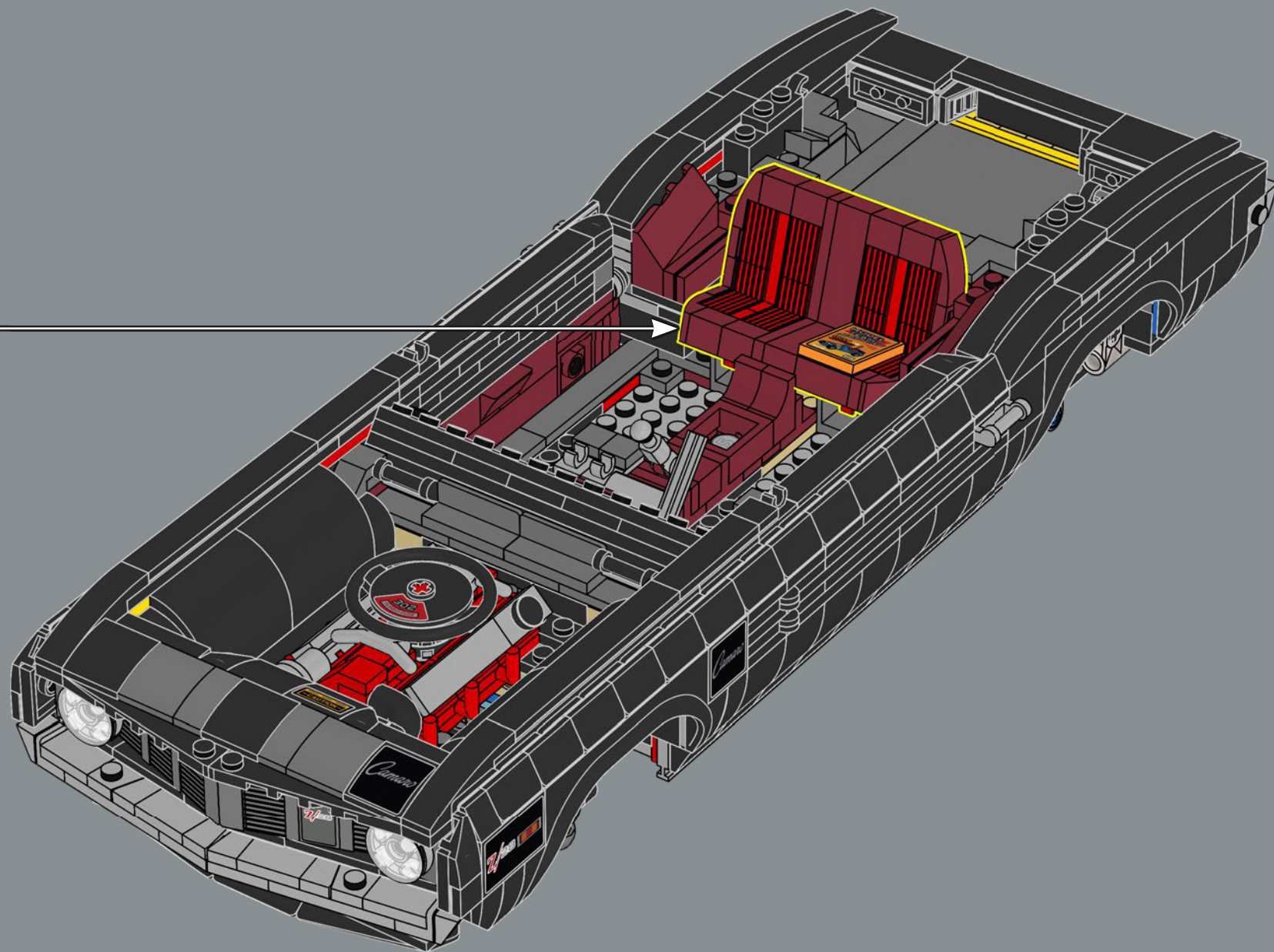

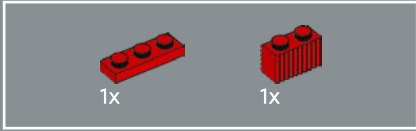

276

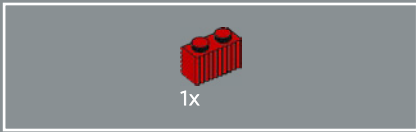
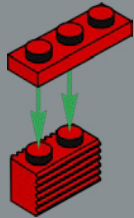

277

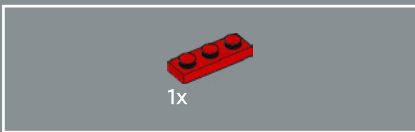
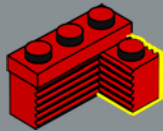

278

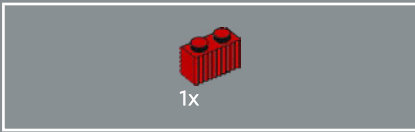
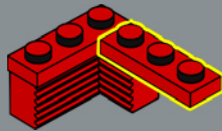

279

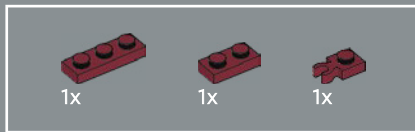
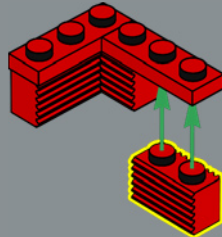

280

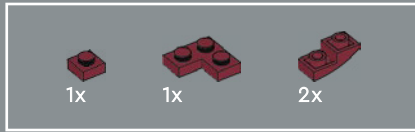
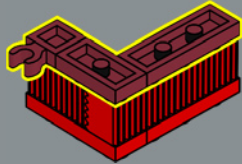

281

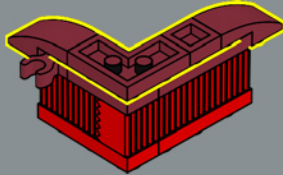



282

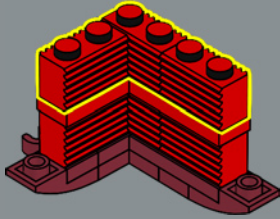

283

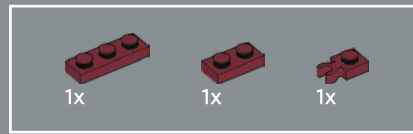
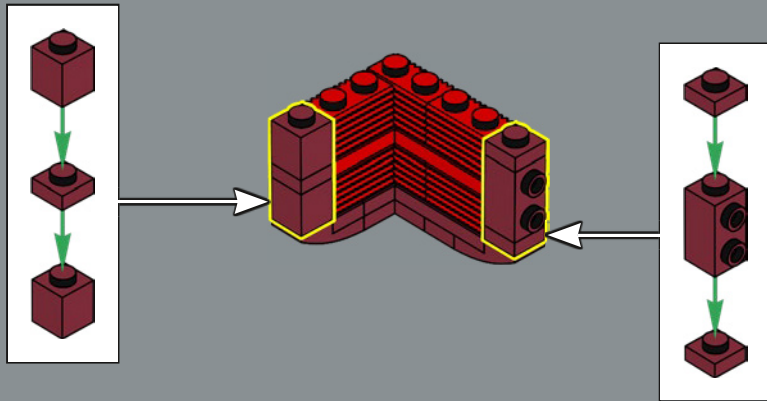

284

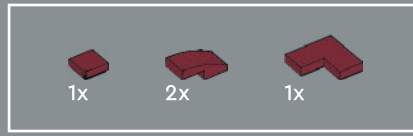
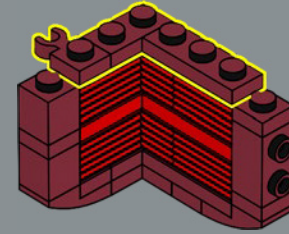

285

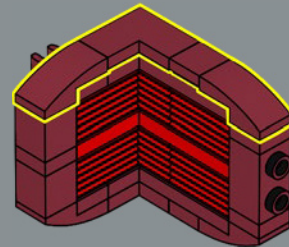



1x

286

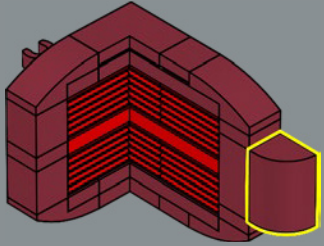

1x

287

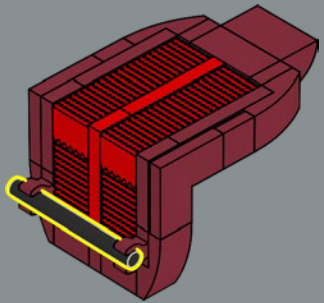

288

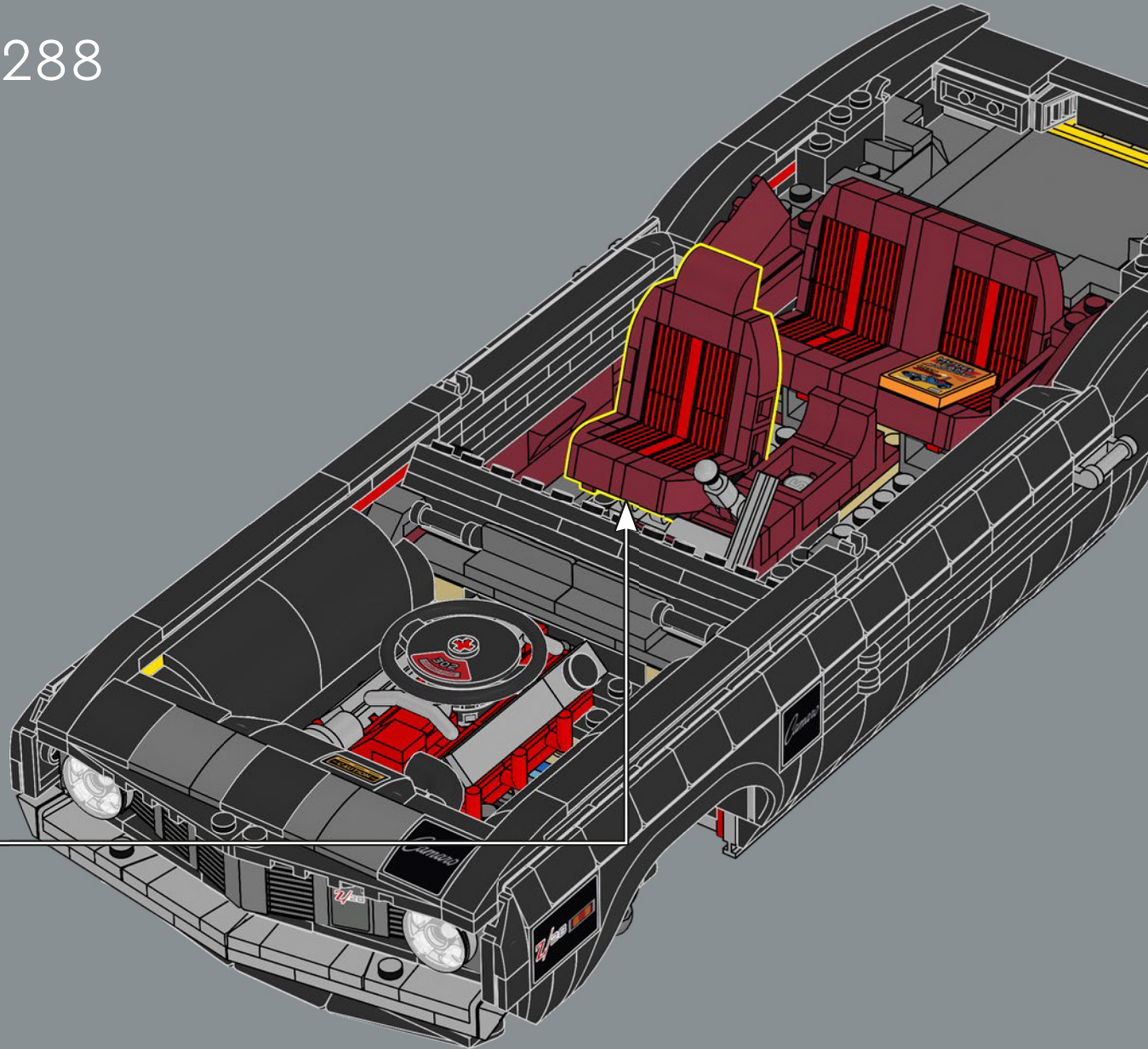

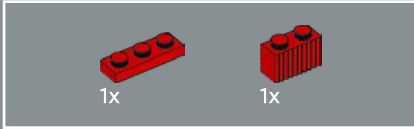
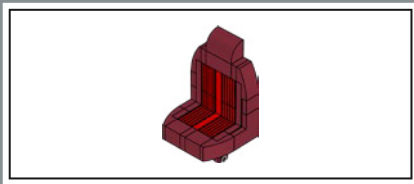

289

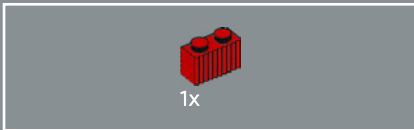
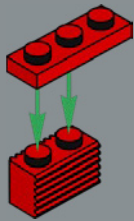

290

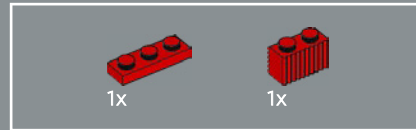
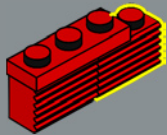

291

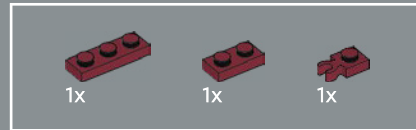
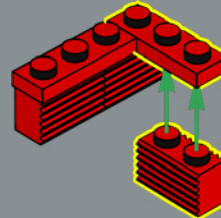

292

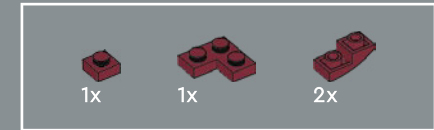
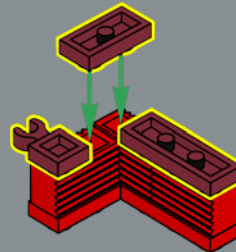

293

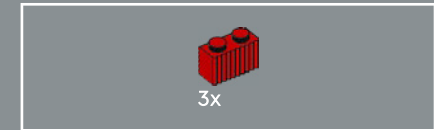
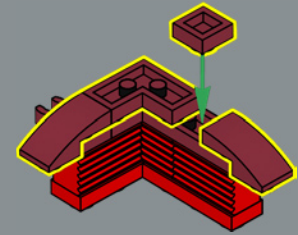

294

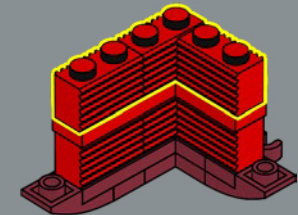

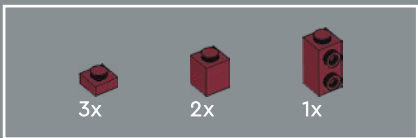

295

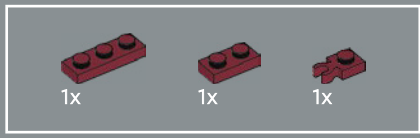
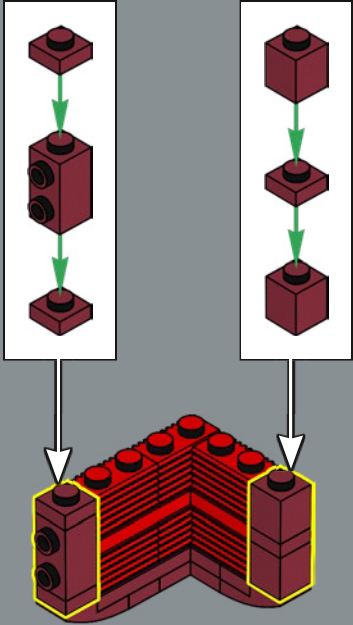

296

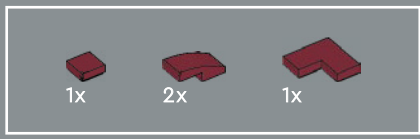
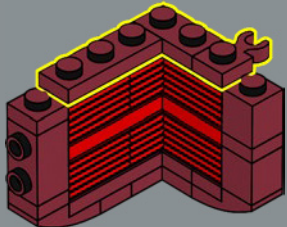

297

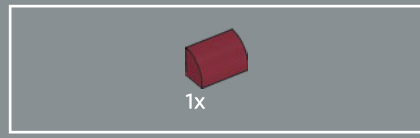
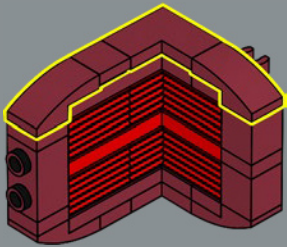

298

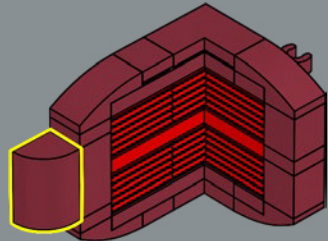

299

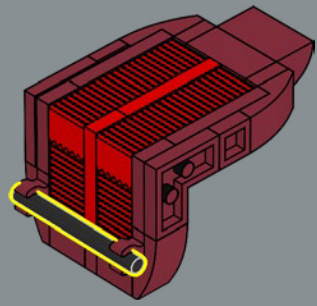

300

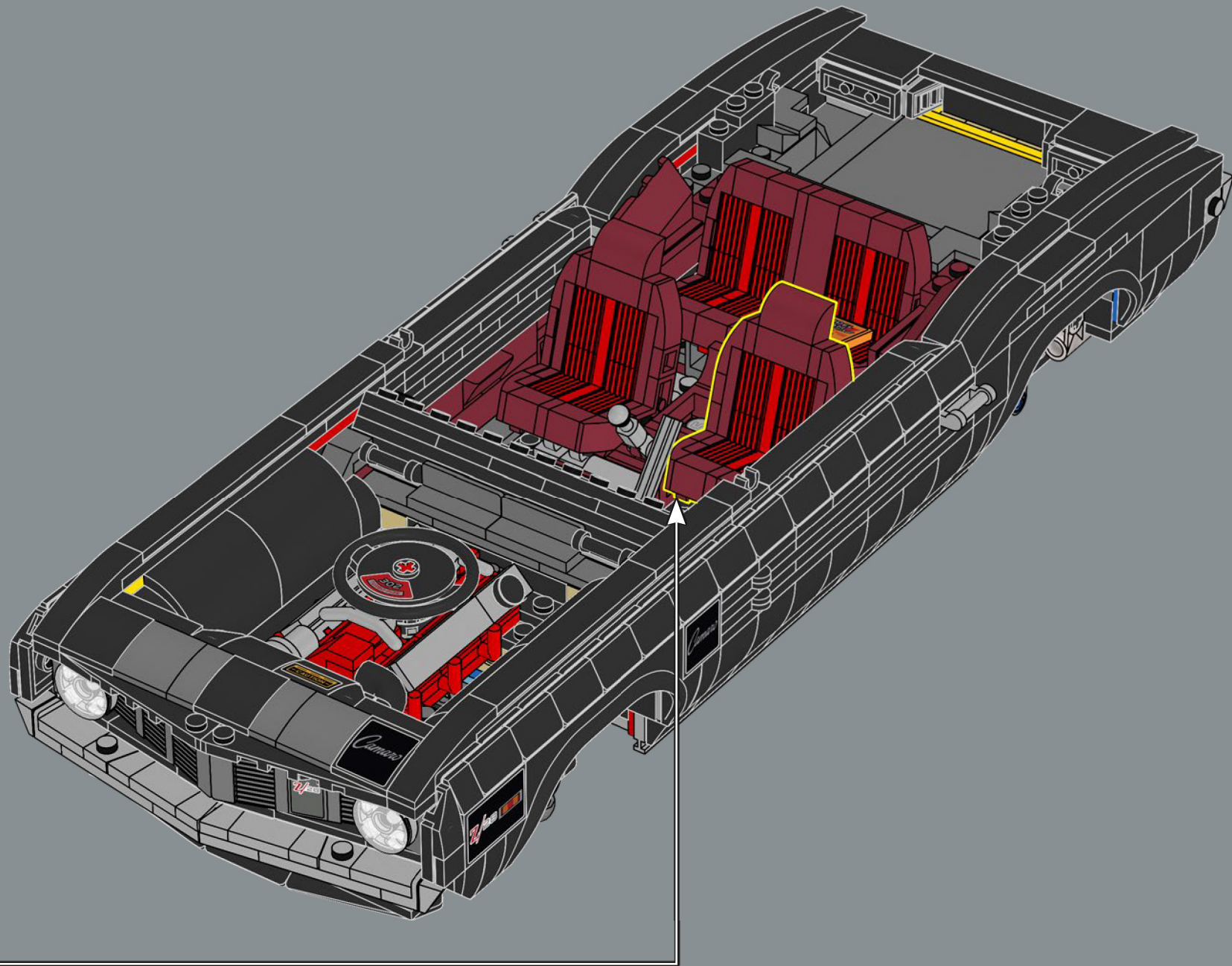

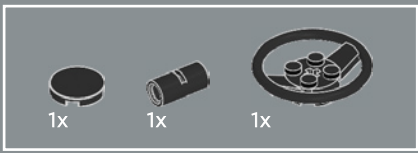

301

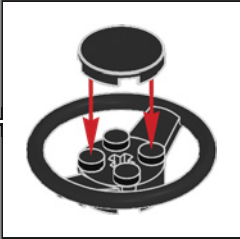
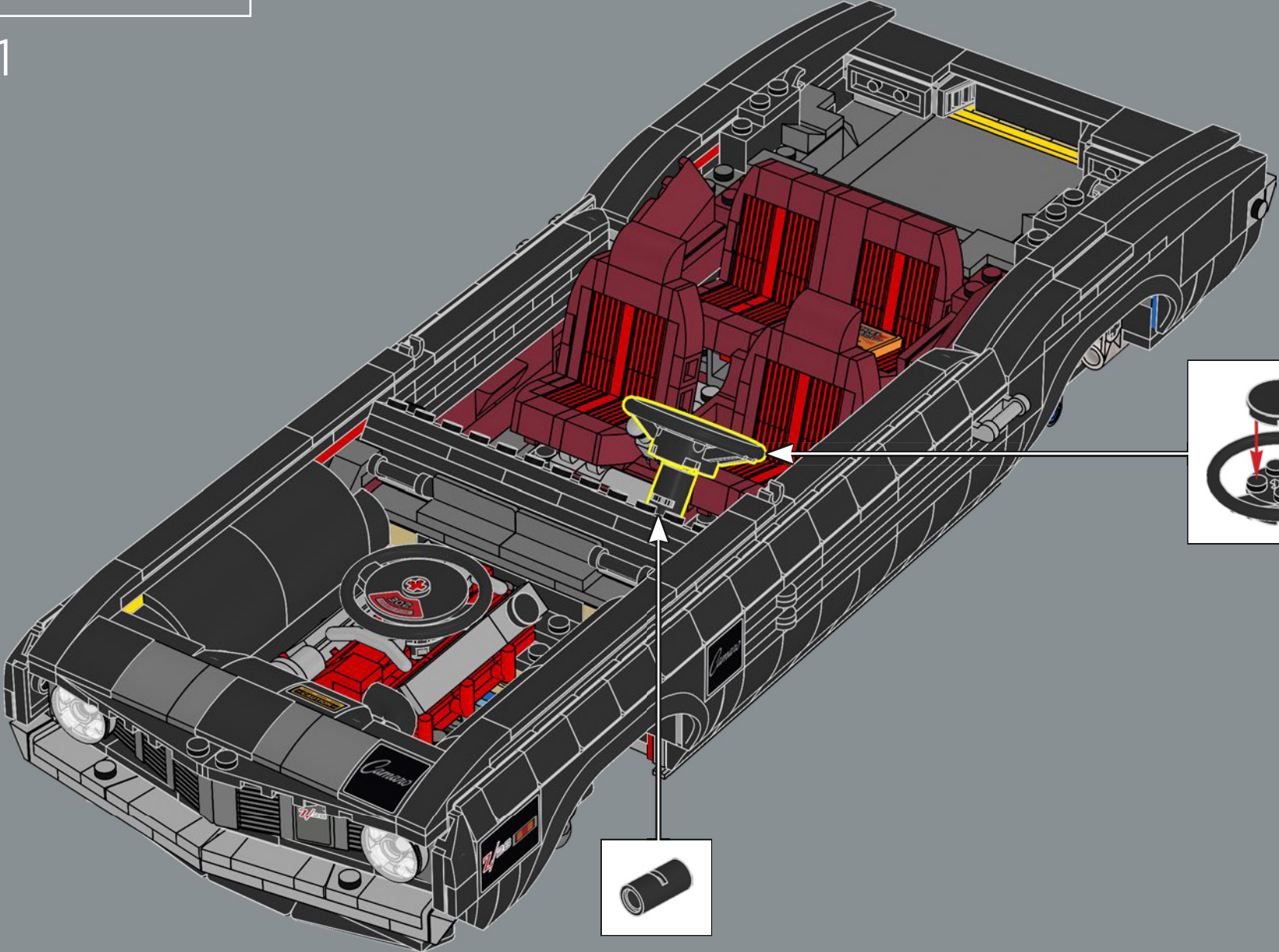

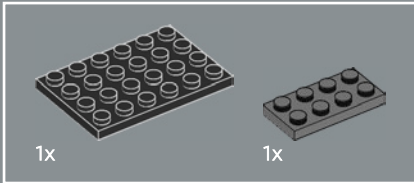
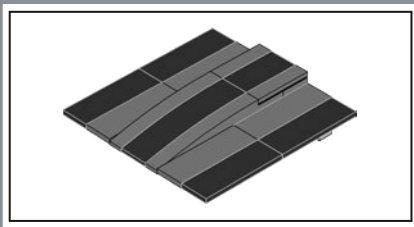

302

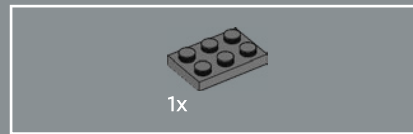
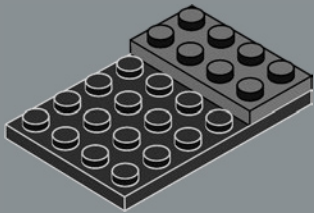

303

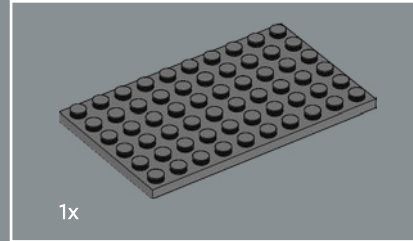
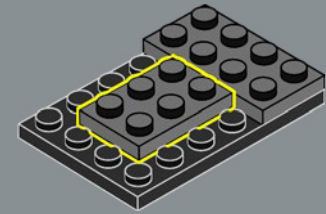

304

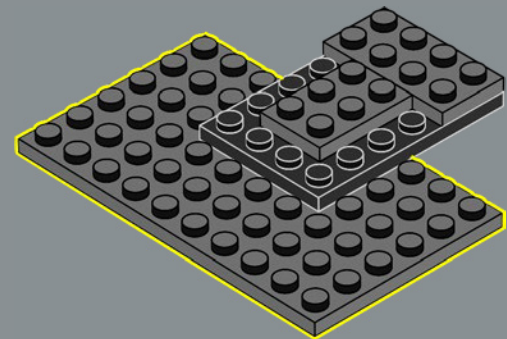

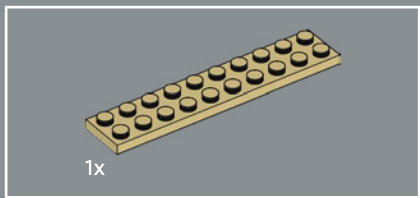

305

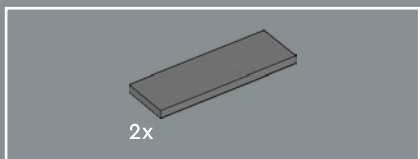
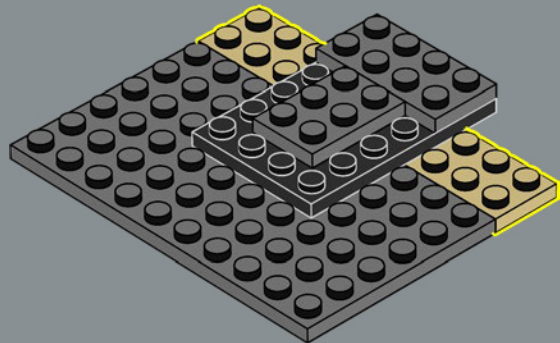

306

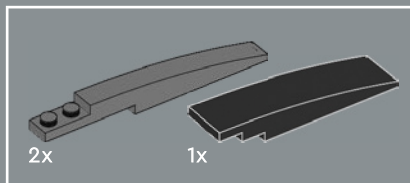
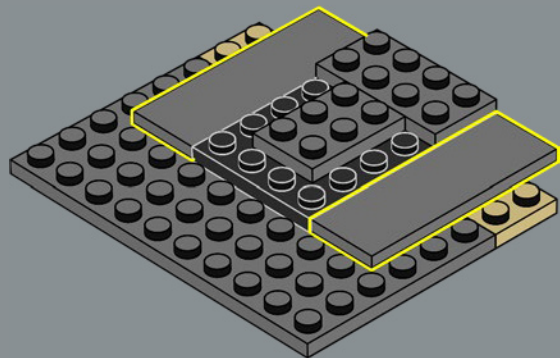

307

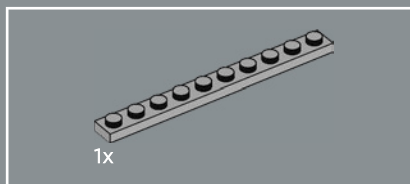
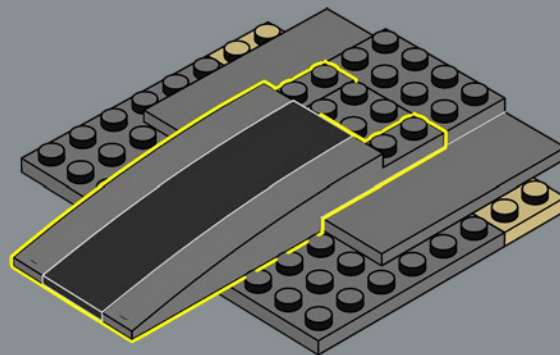

308

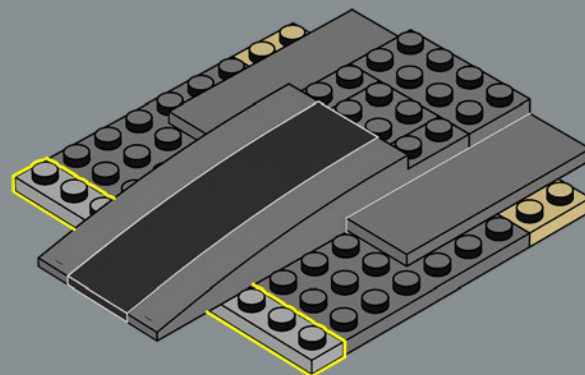

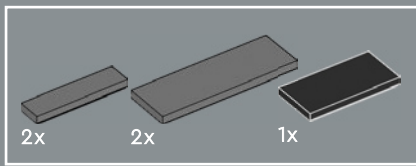

309

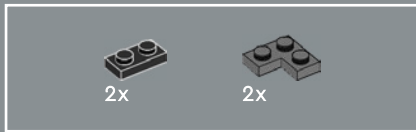
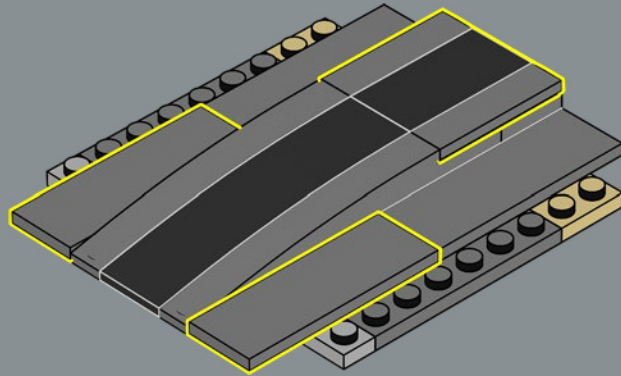

310

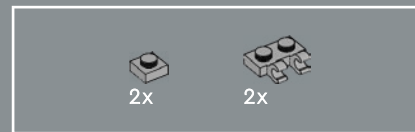
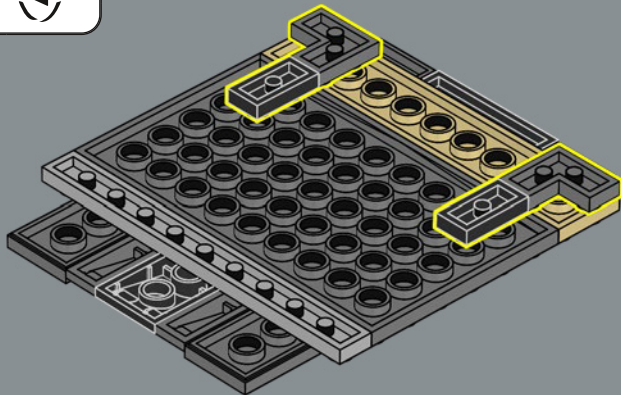

311

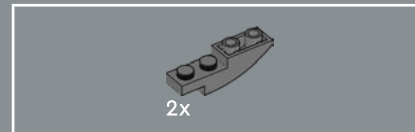
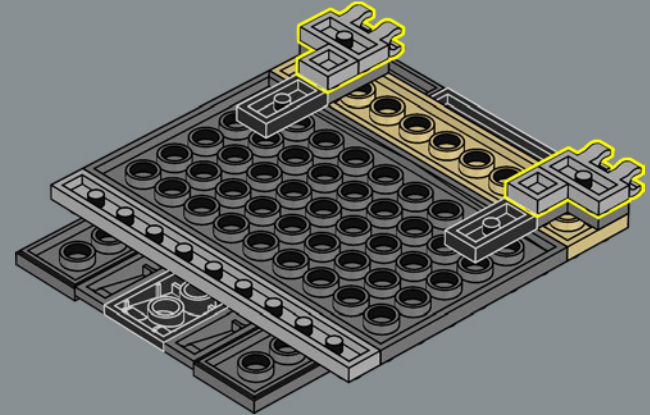

312

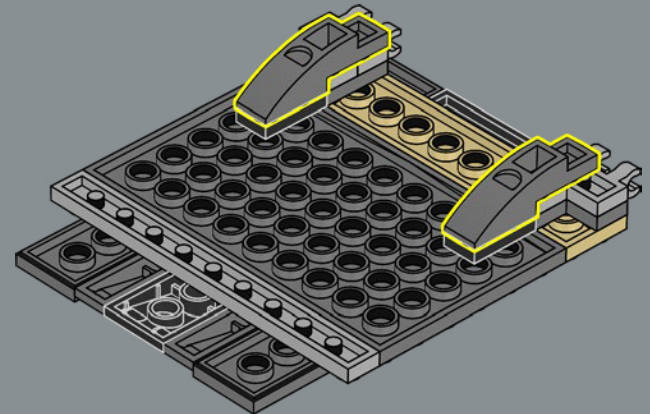

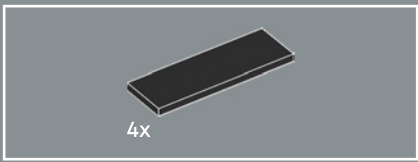

313

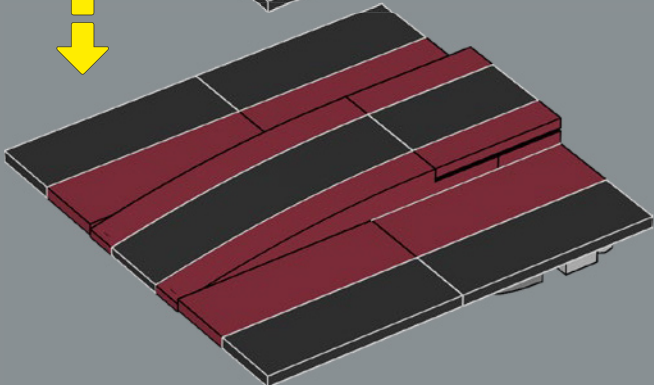
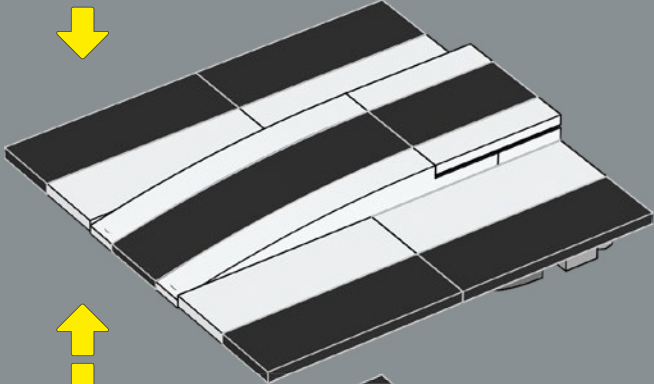
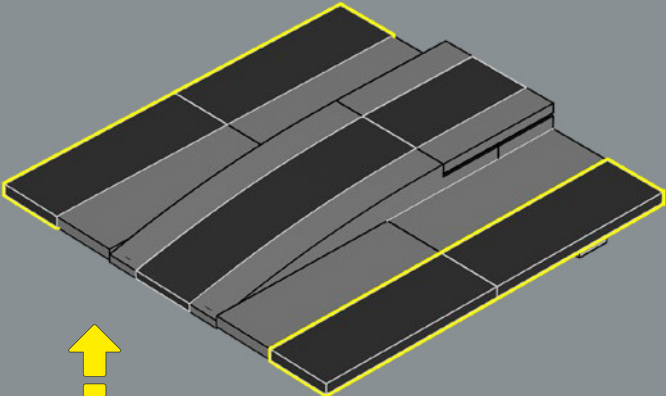

314

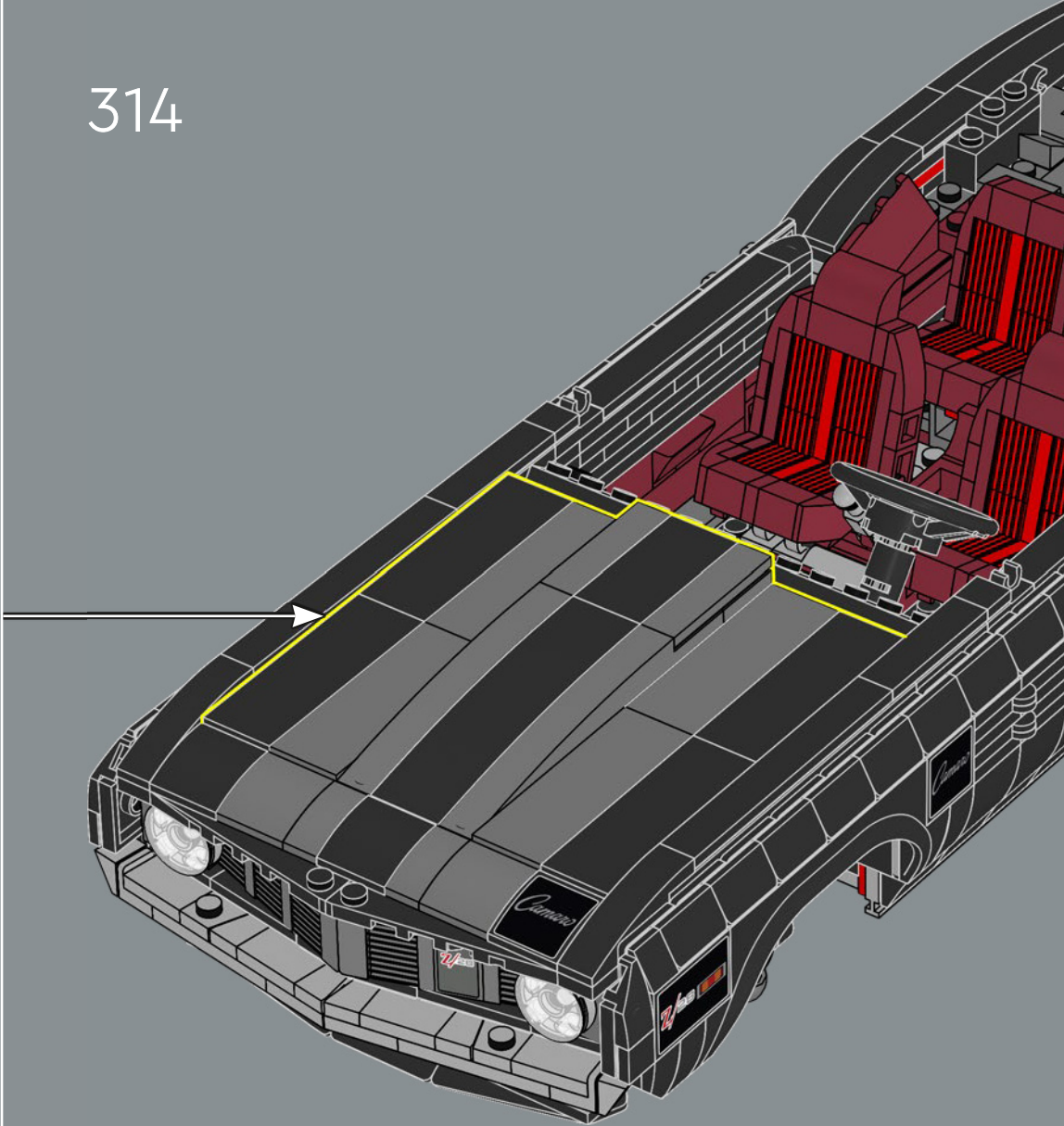

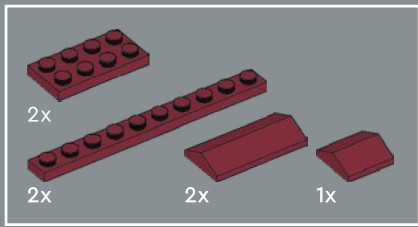

315

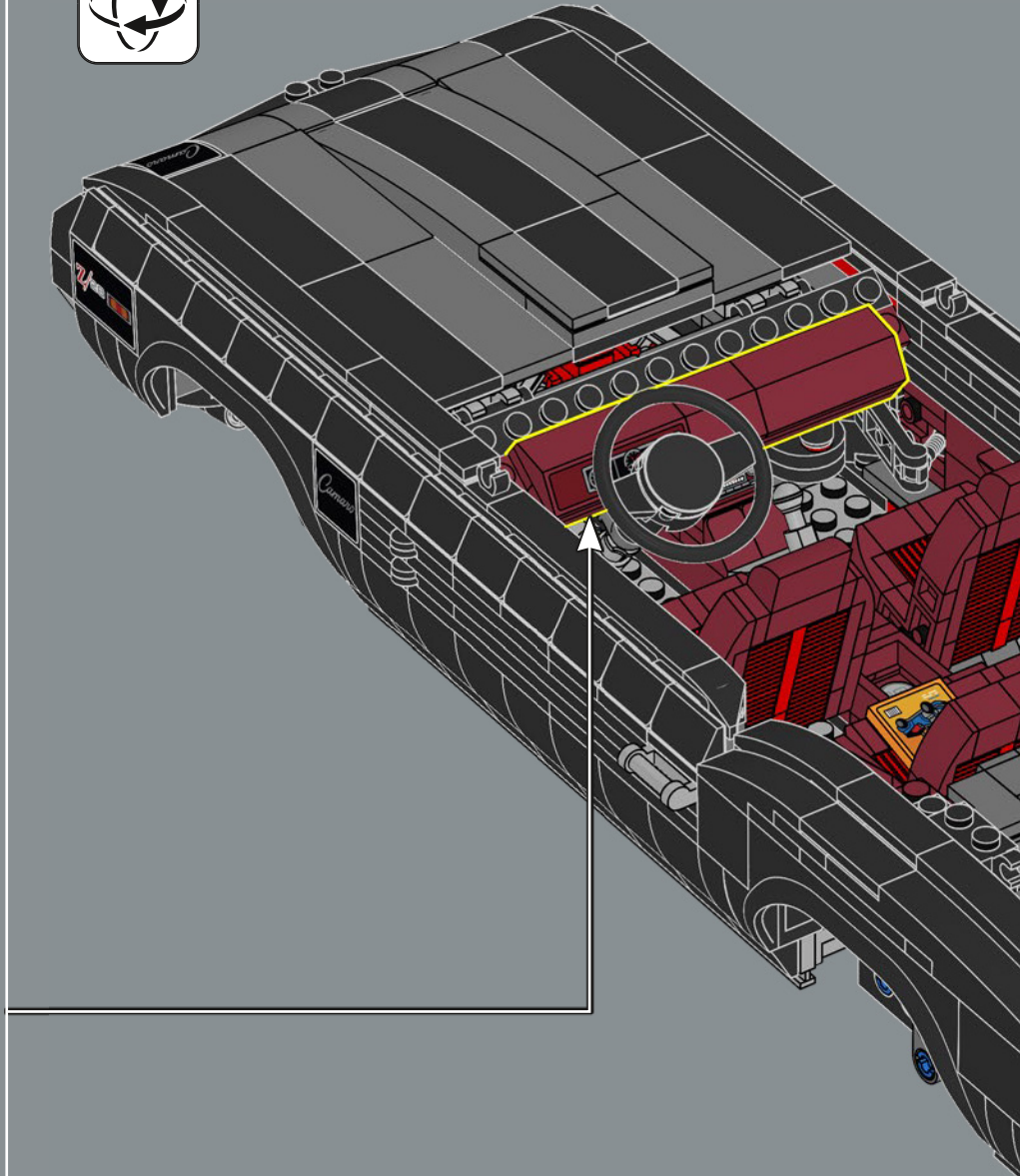
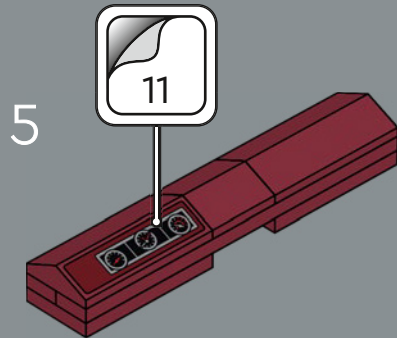
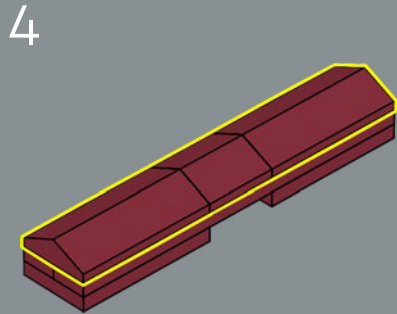
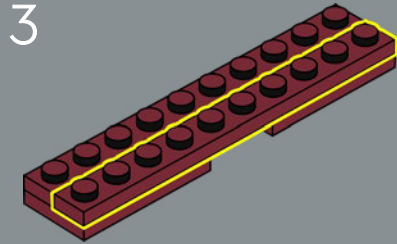
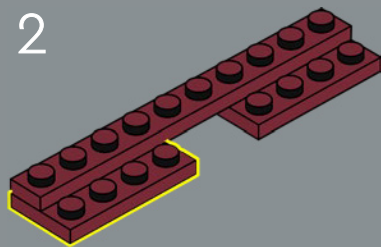
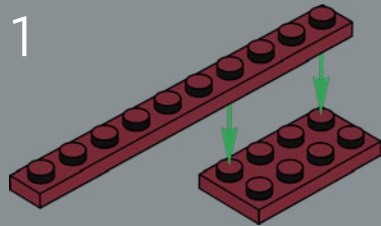

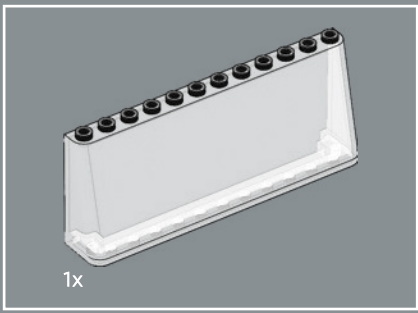

316

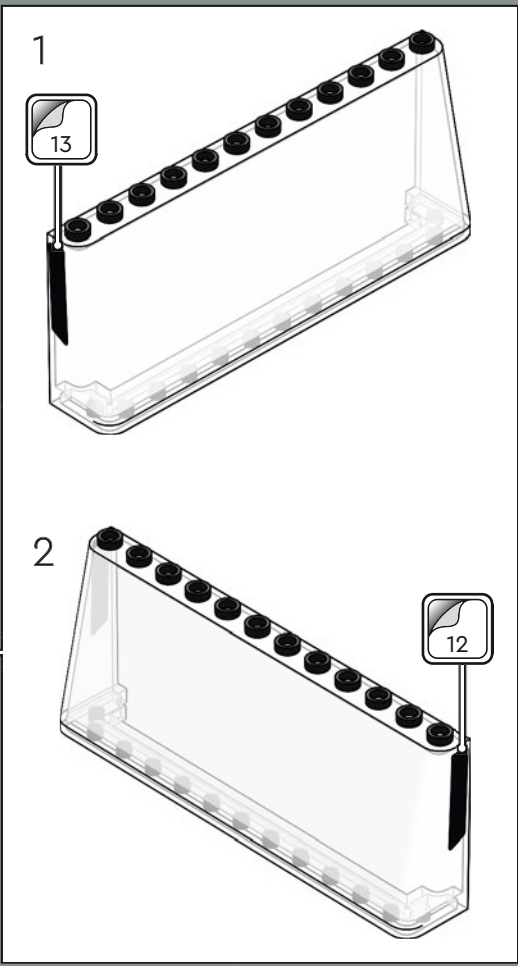
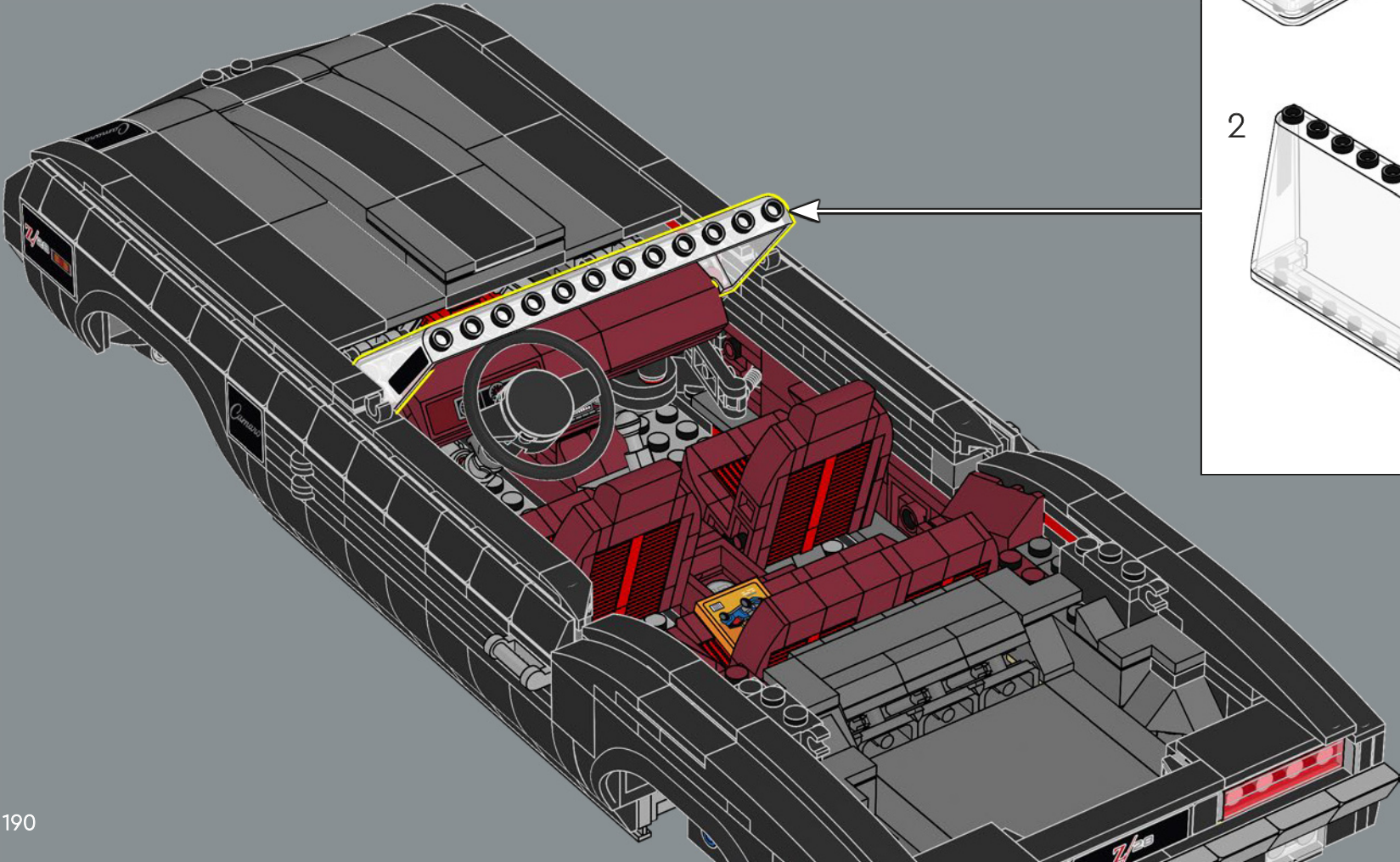

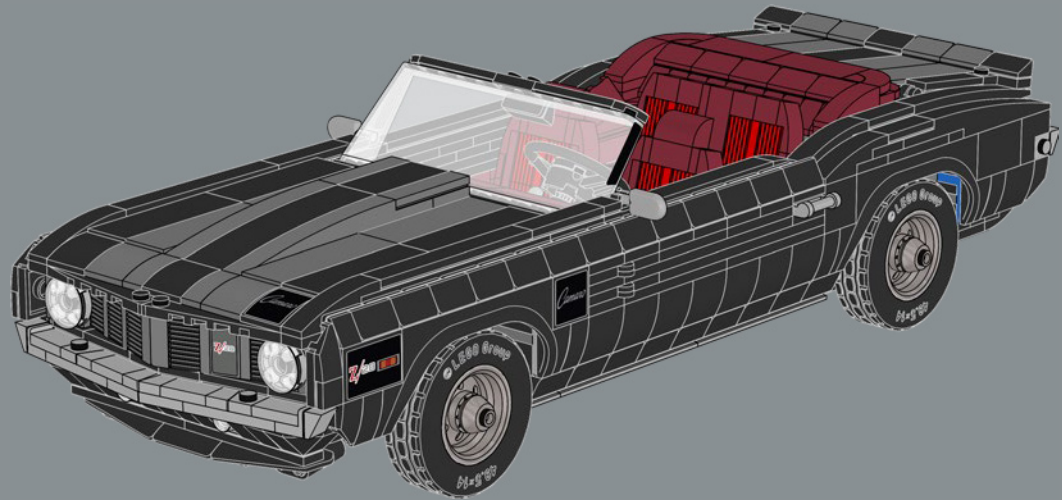
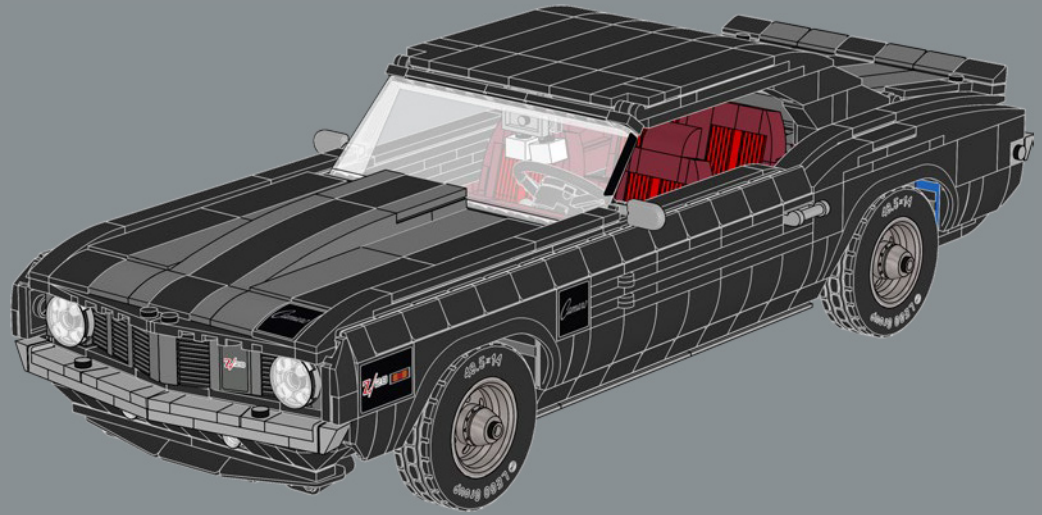

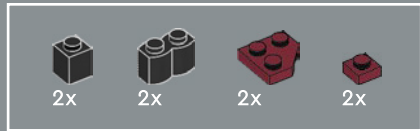
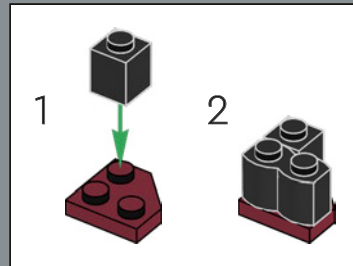

317

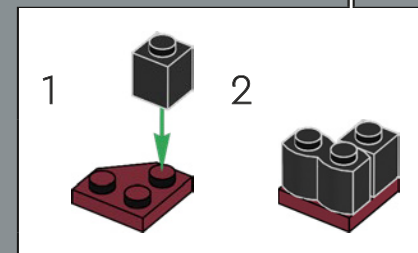
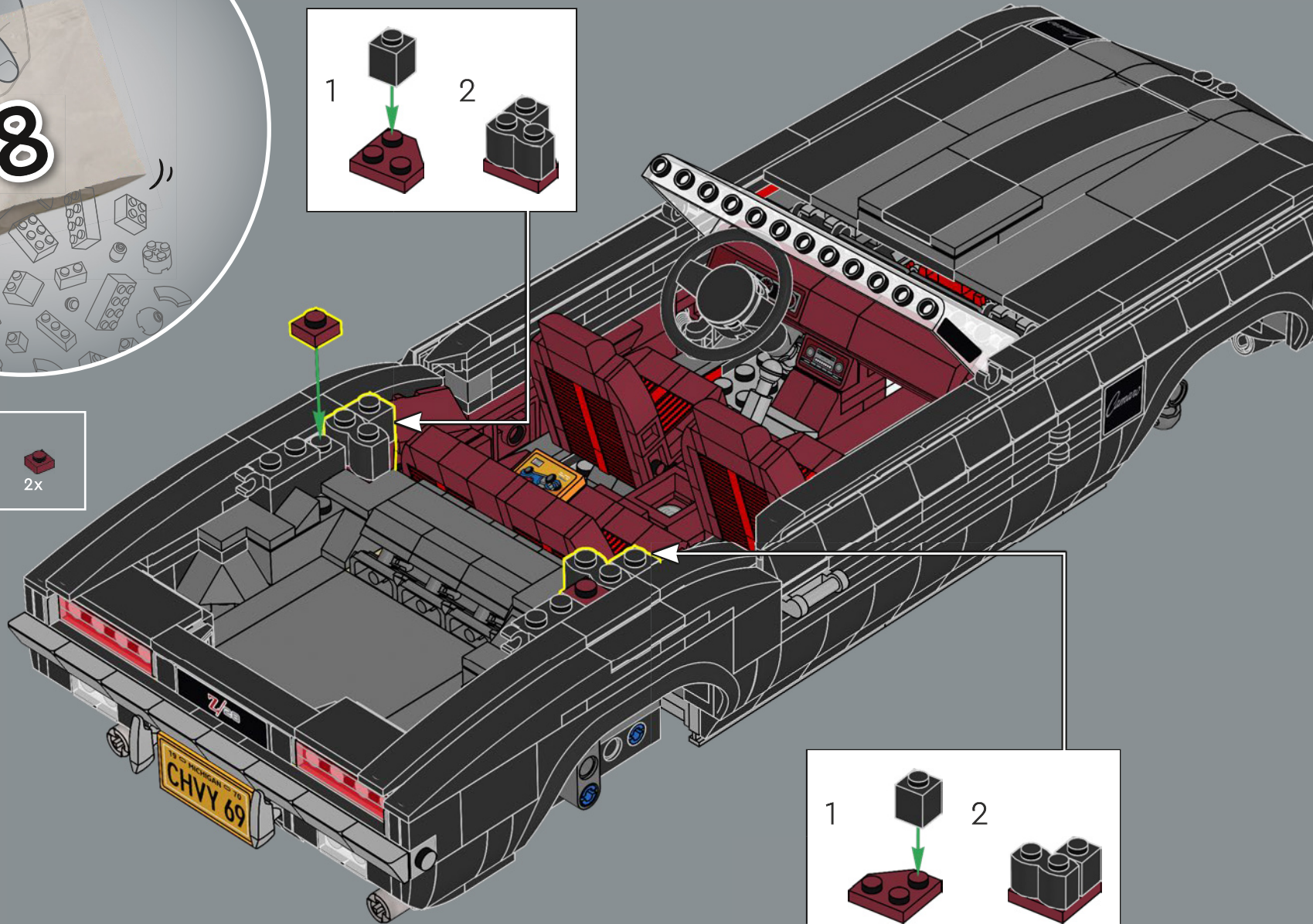

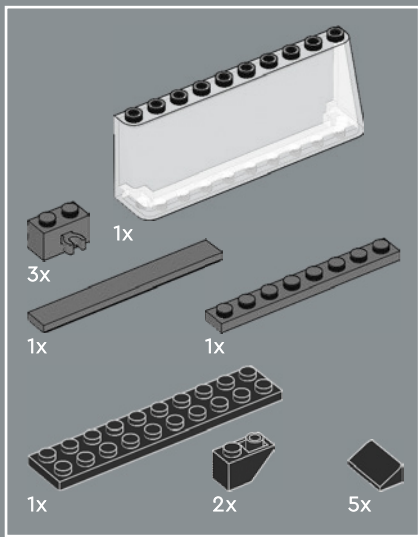

318

1

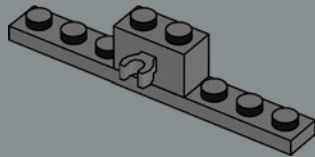

2

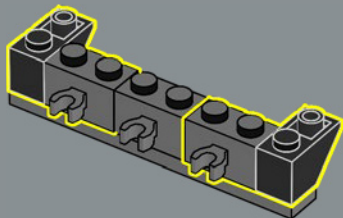

3

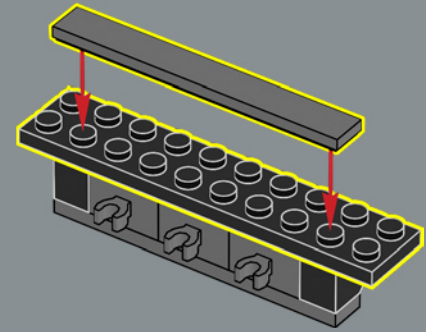

4

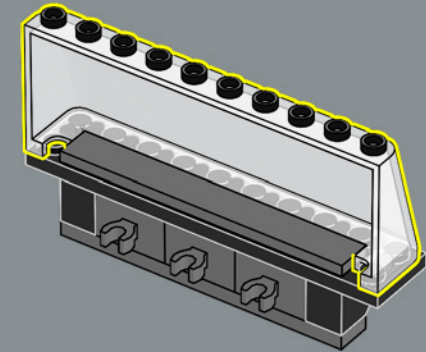

5

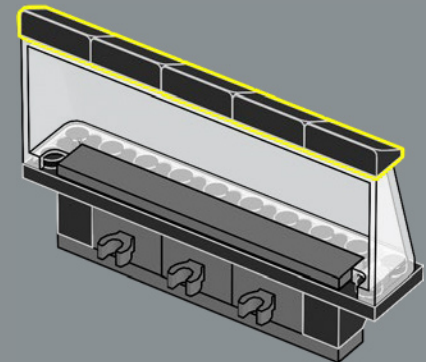

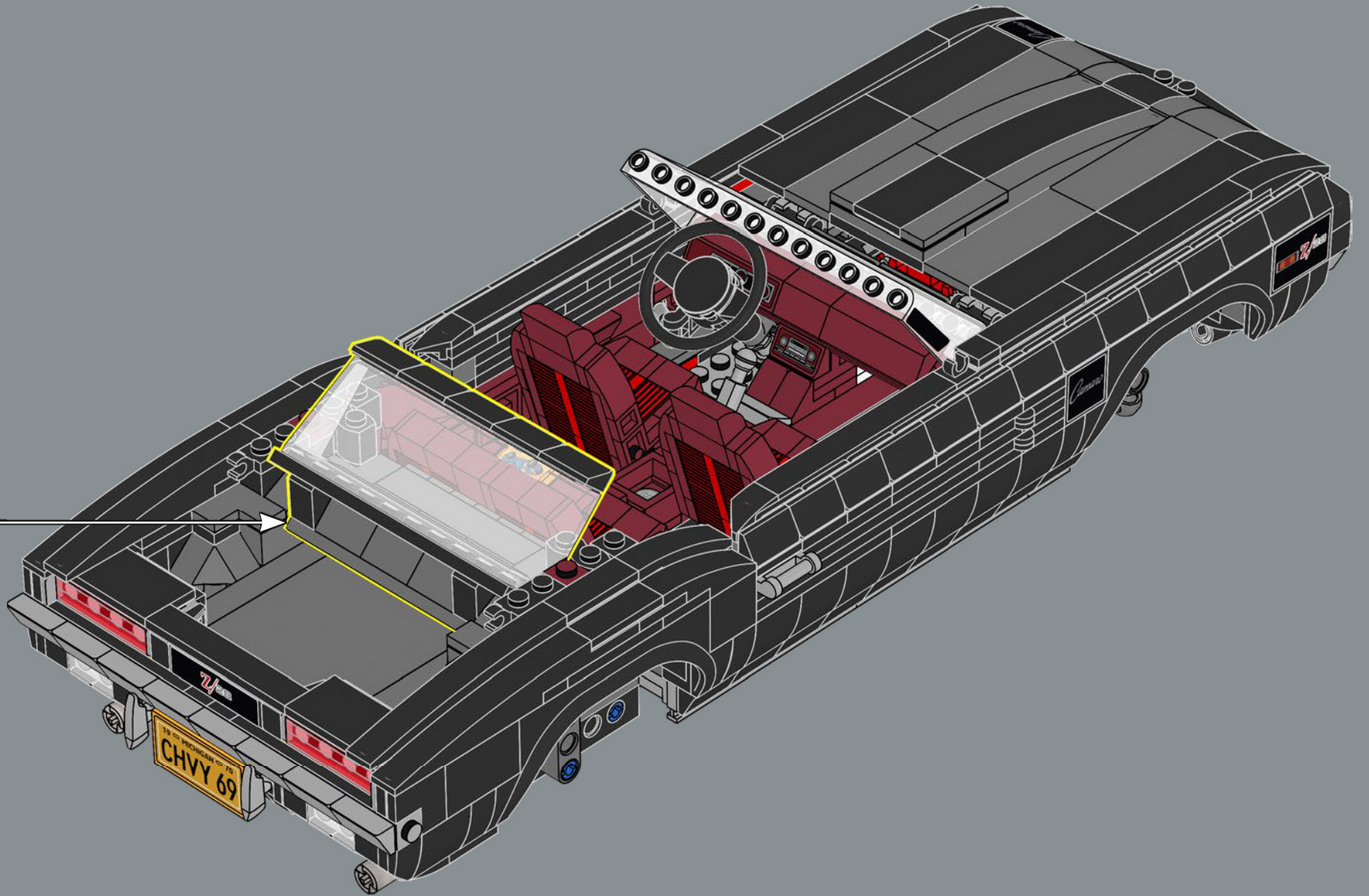

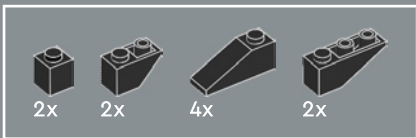

319

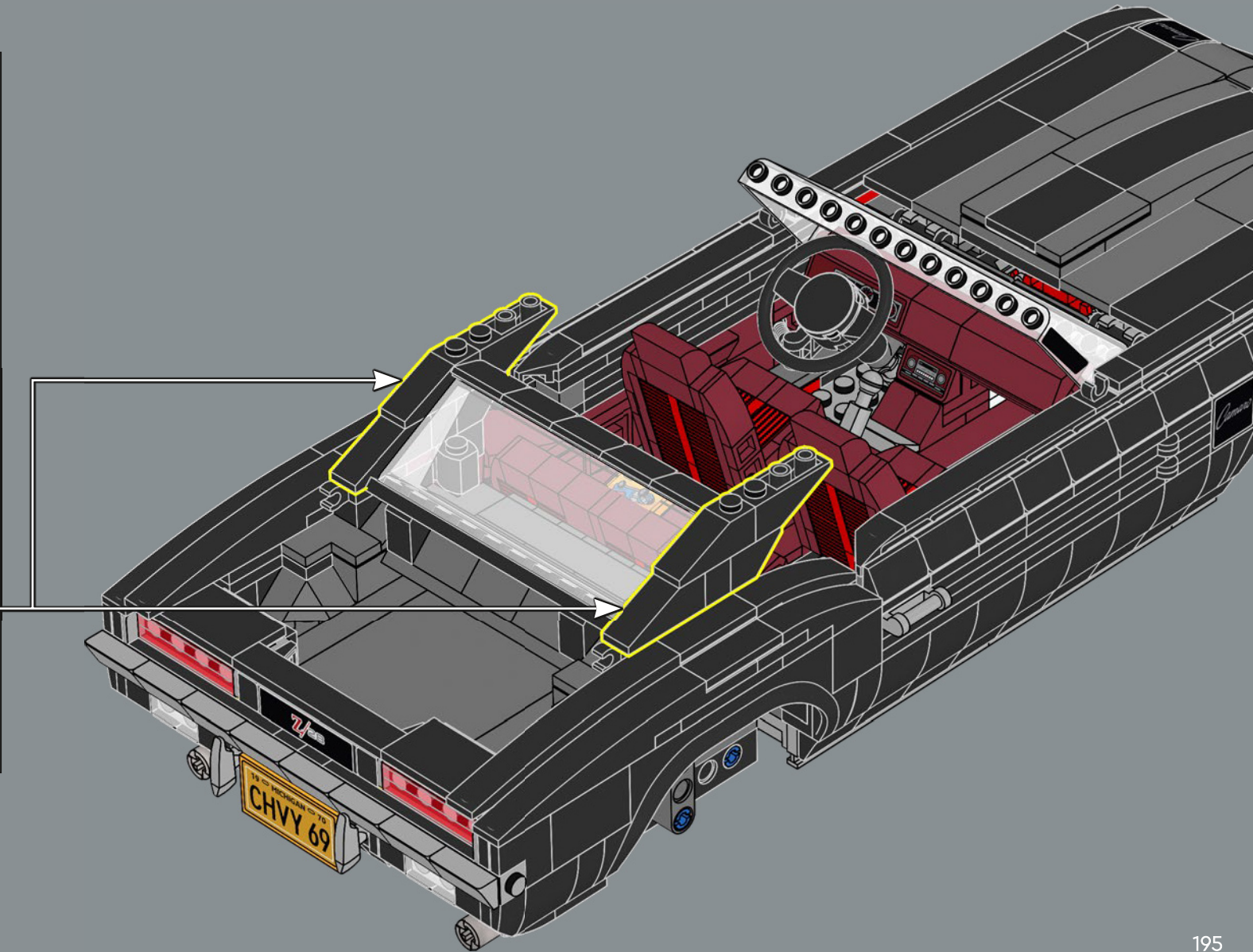
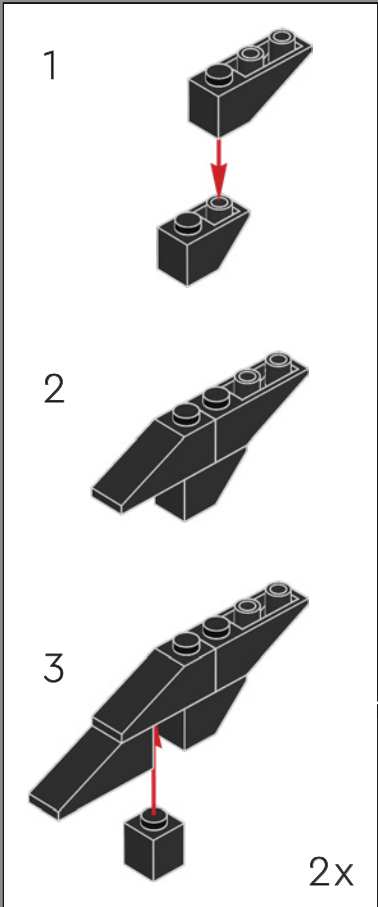

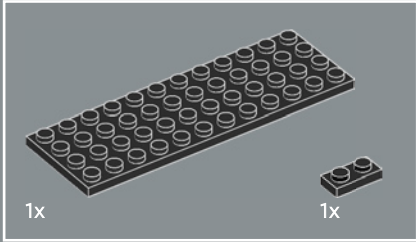
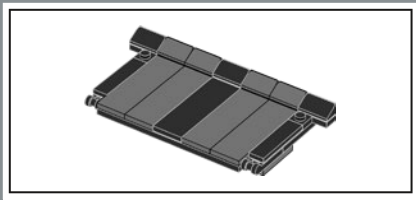

320

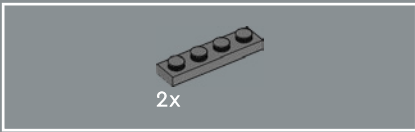
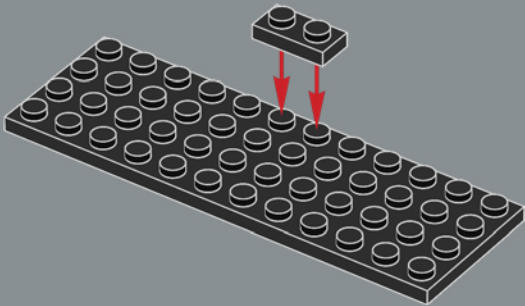

321

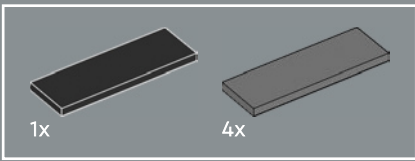
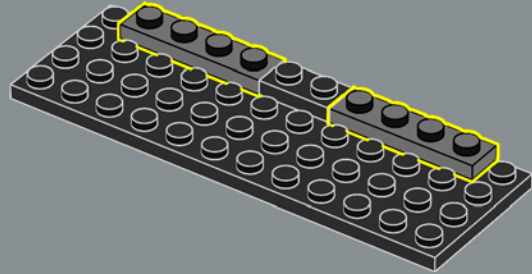

322

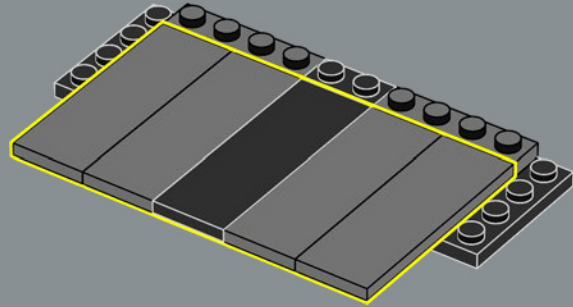

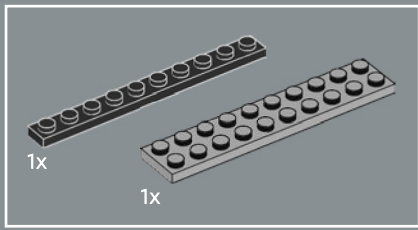

323

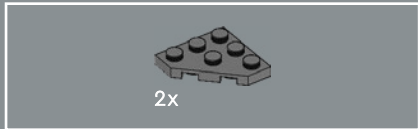
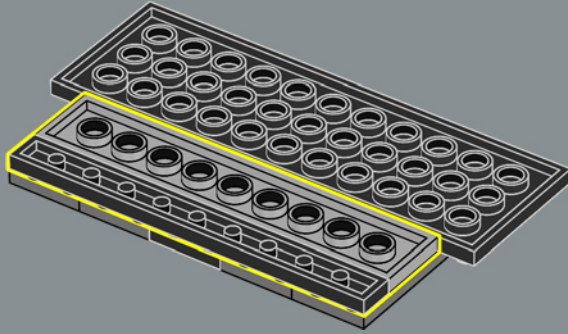

324

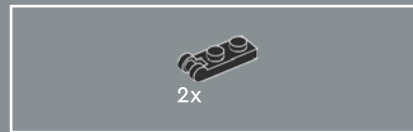
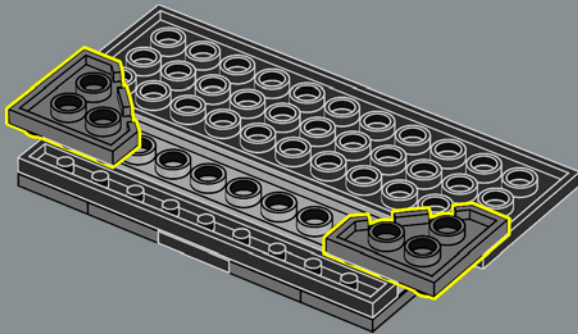

325

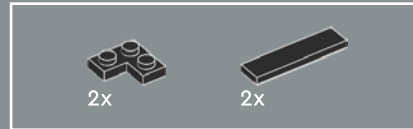
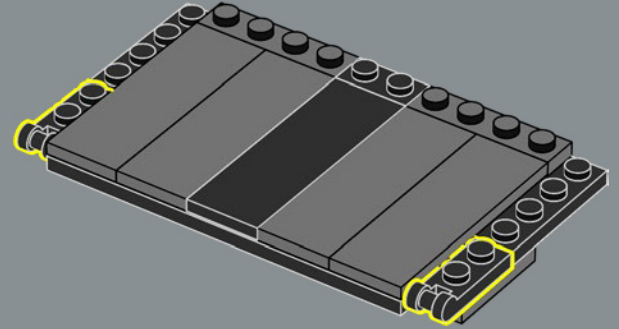

326

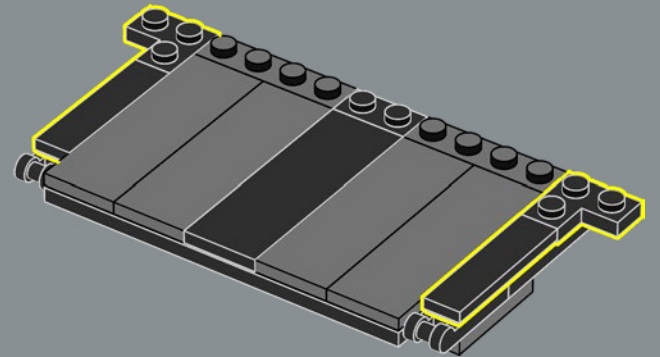

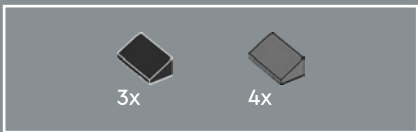

327

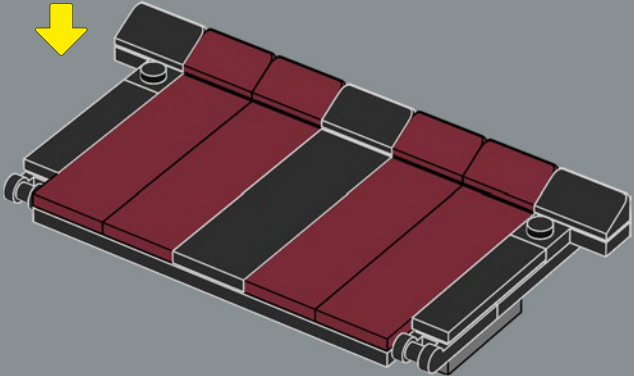
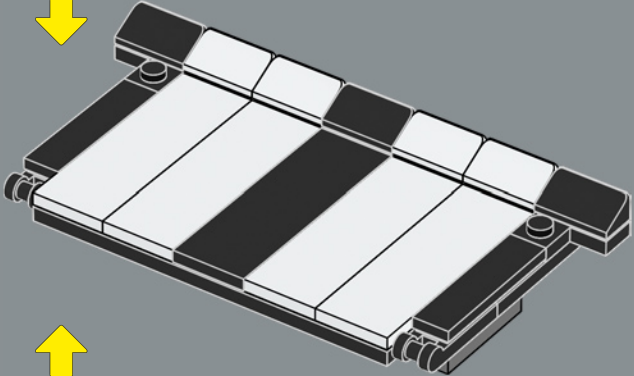
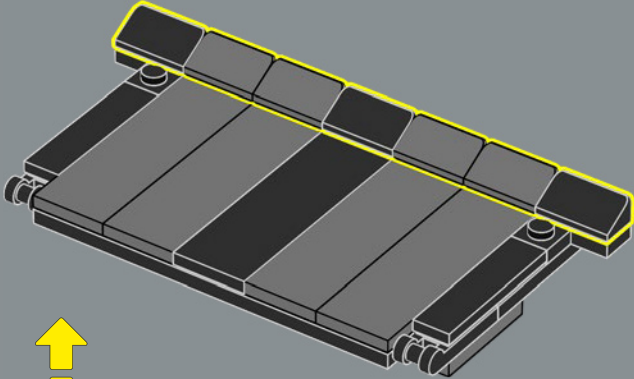

328

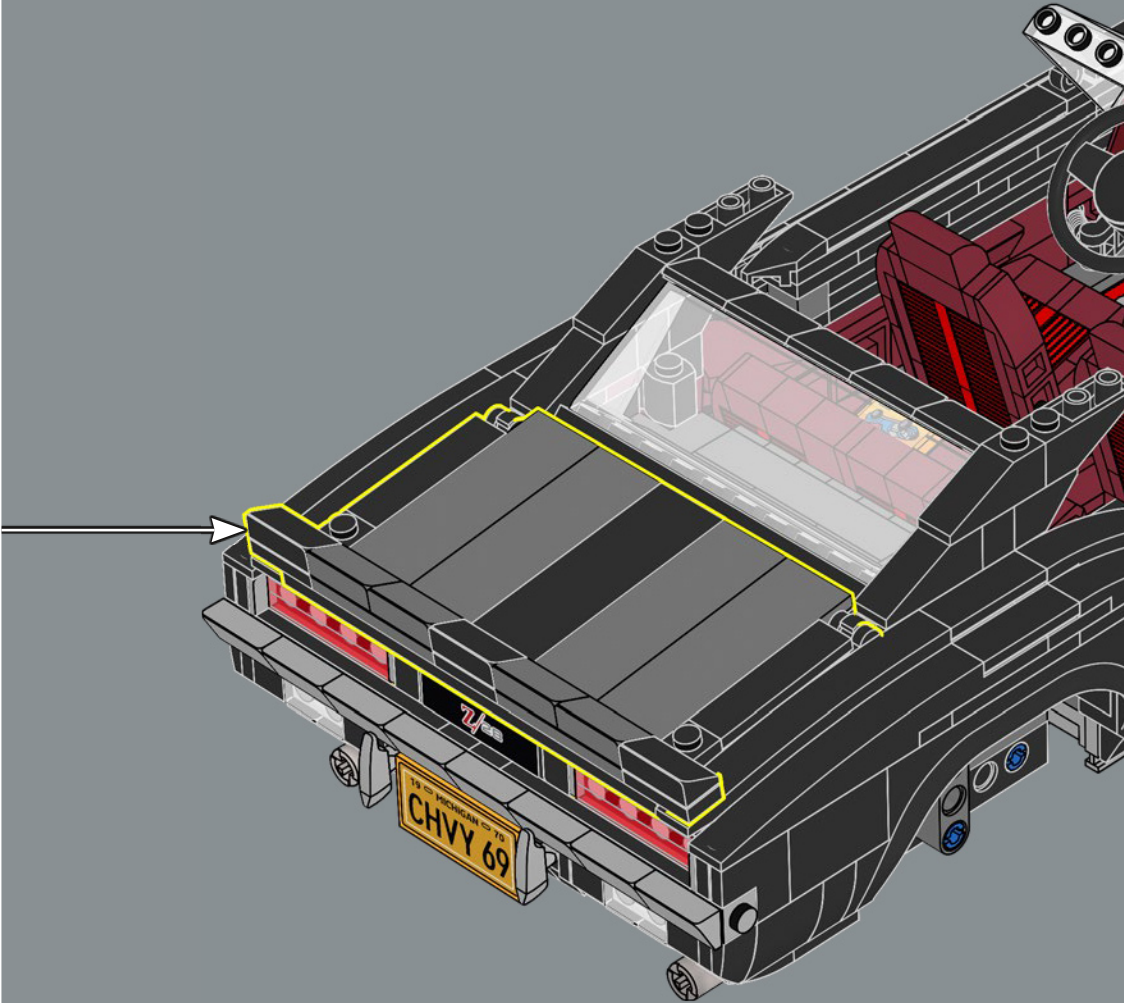

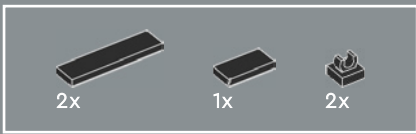

329

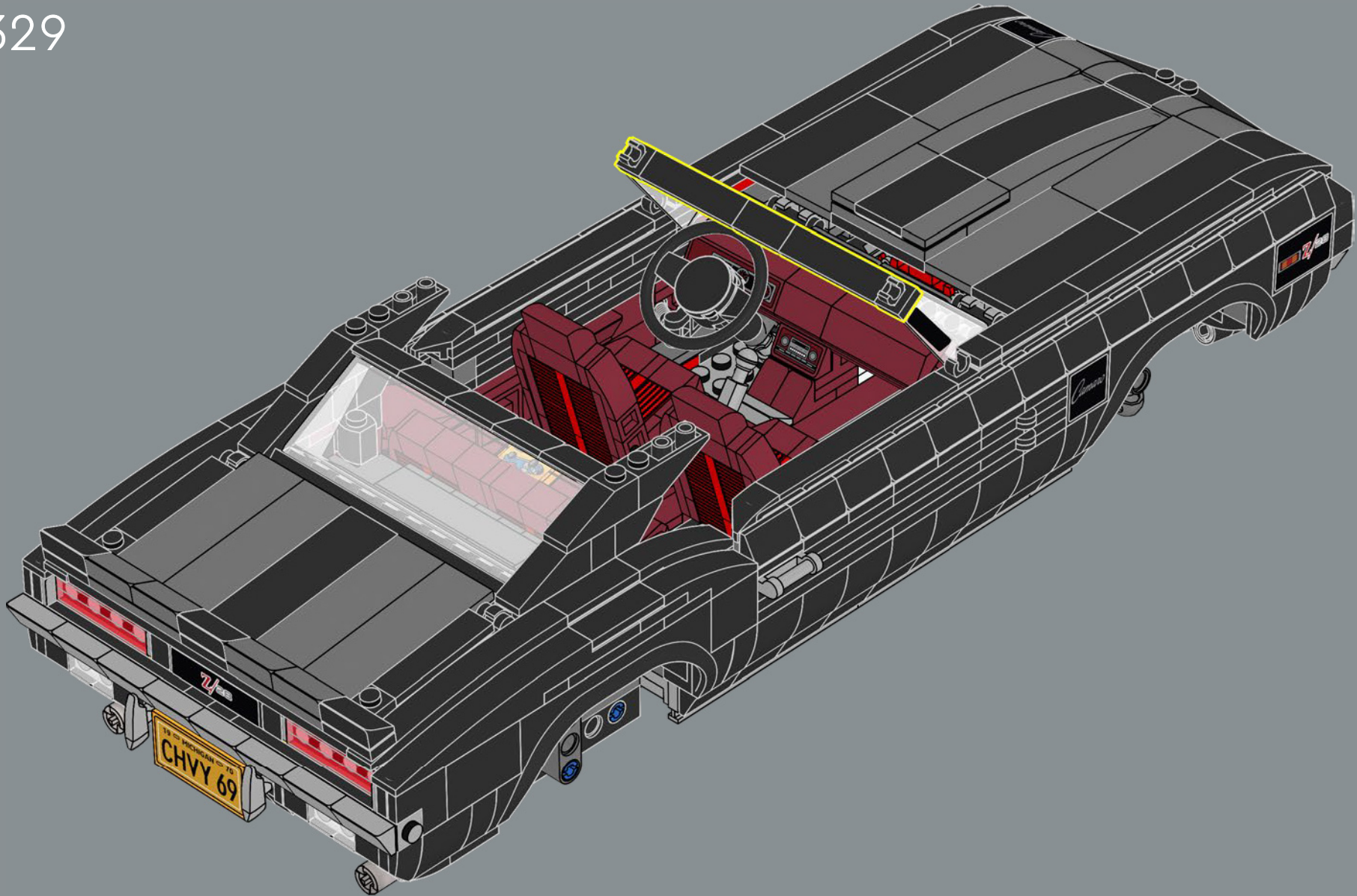

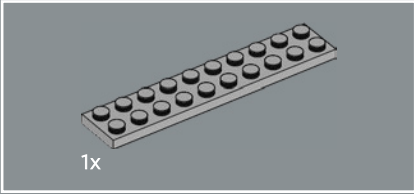
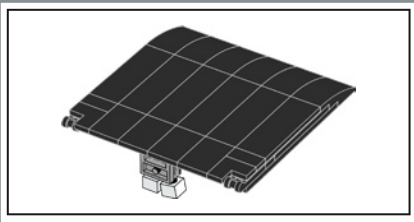

330

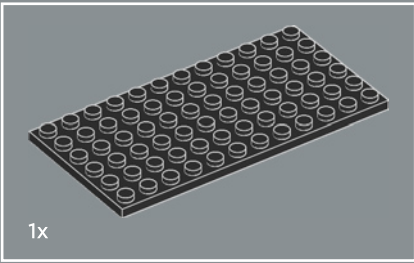
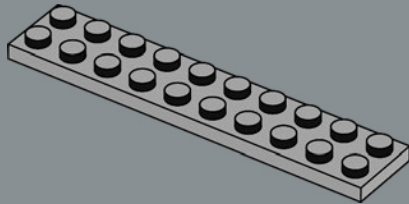

331

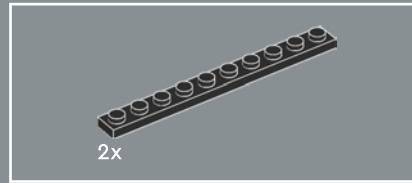
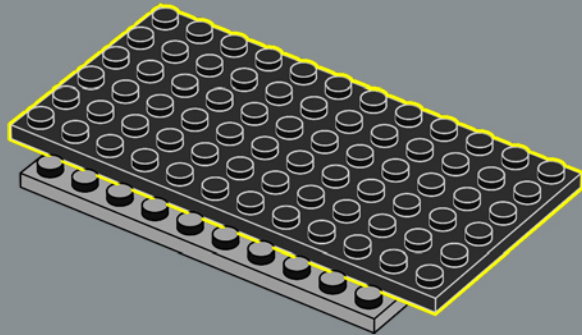

2x

332

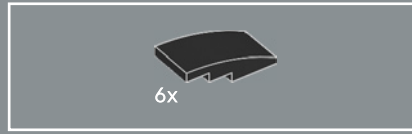
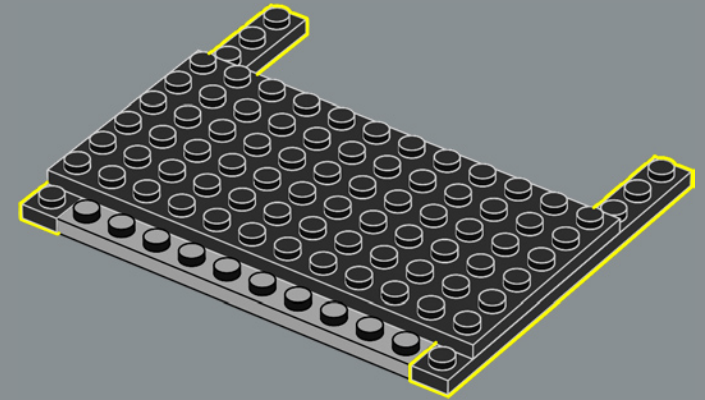

6x

333

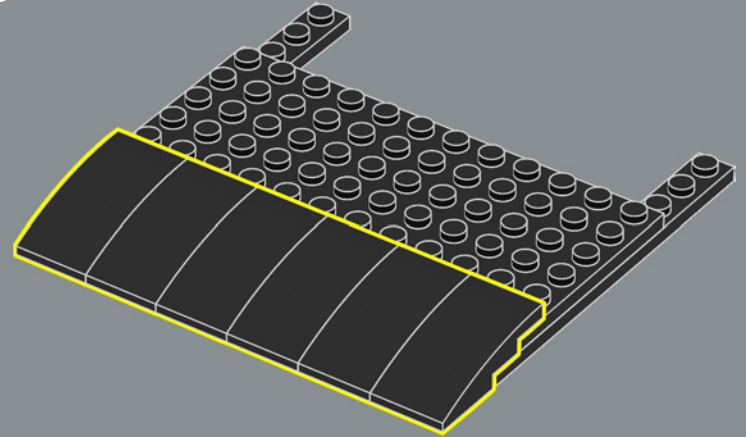

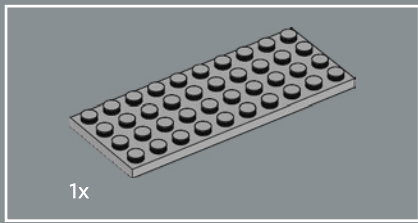

334

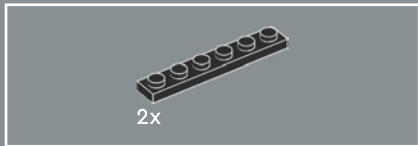
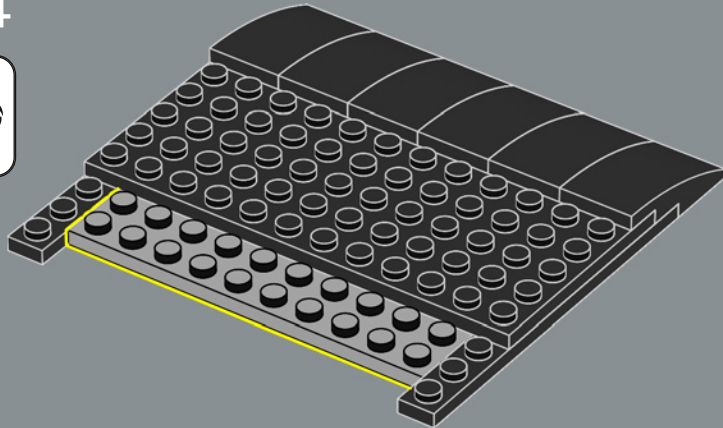

335

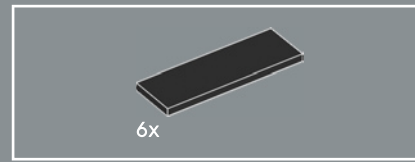
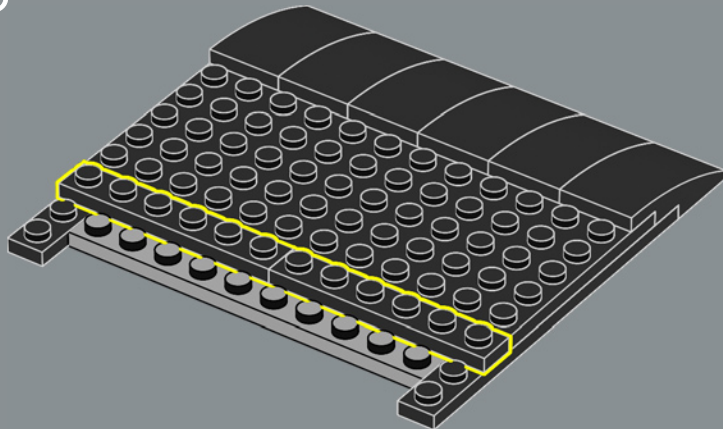

336

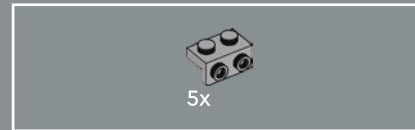
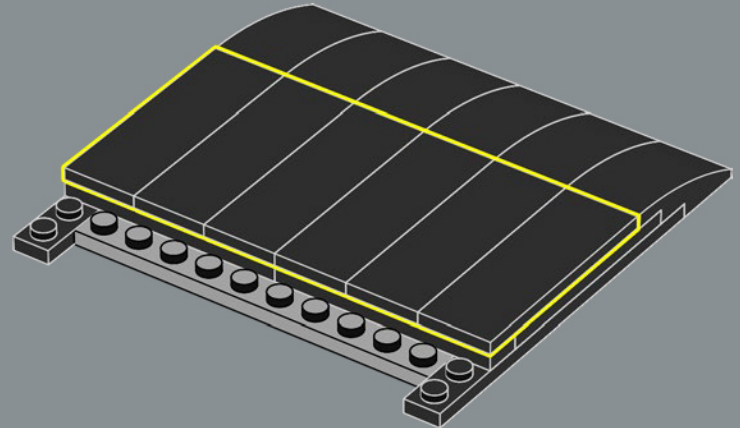

337

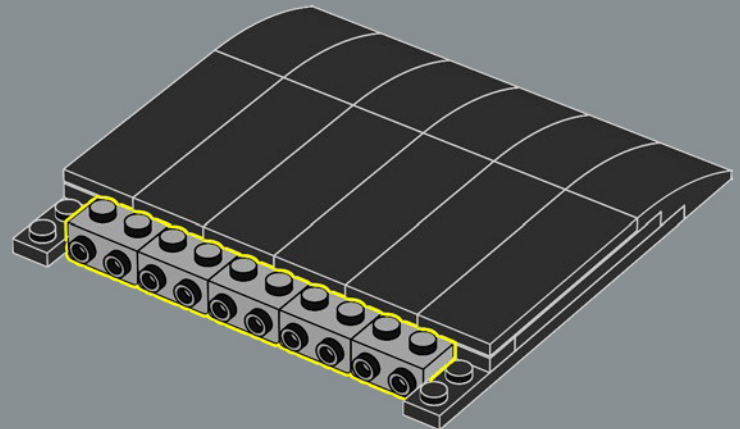

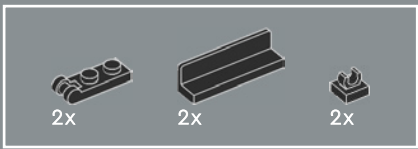

338

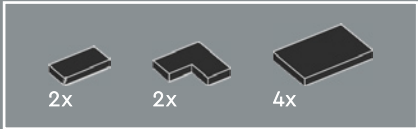
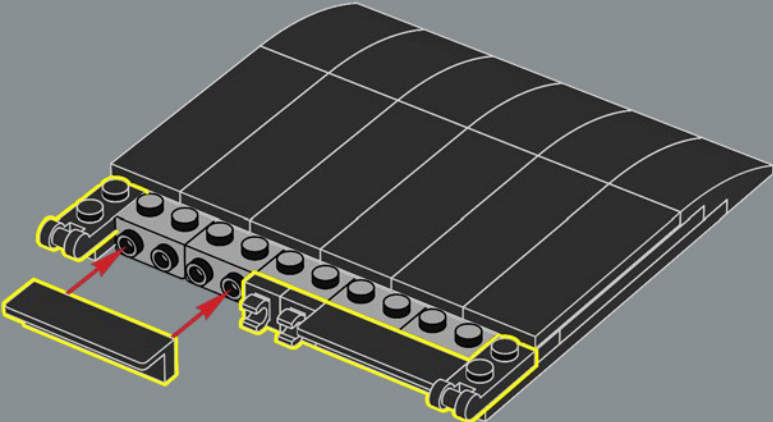

339

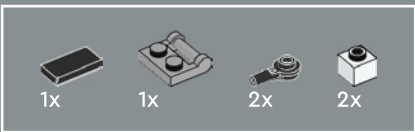
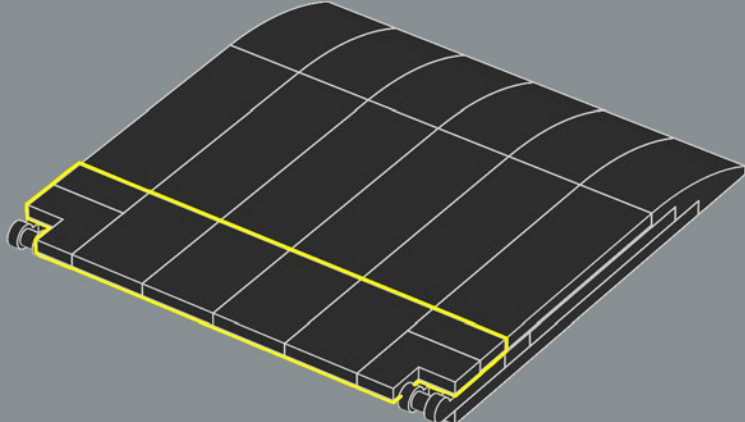

340

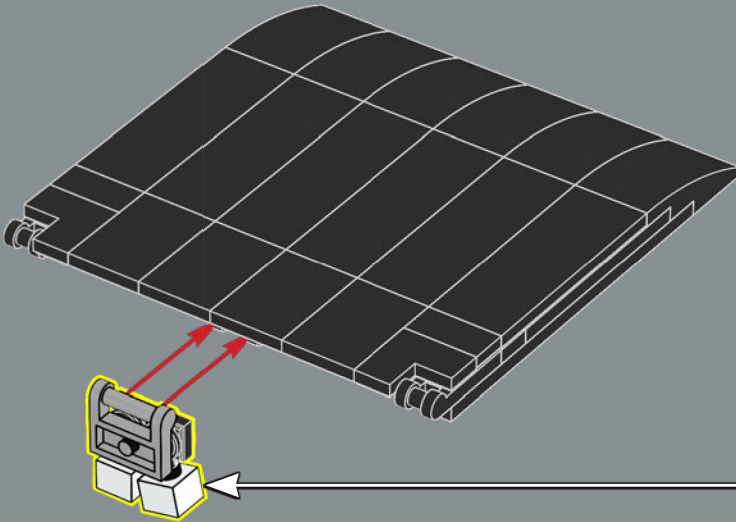
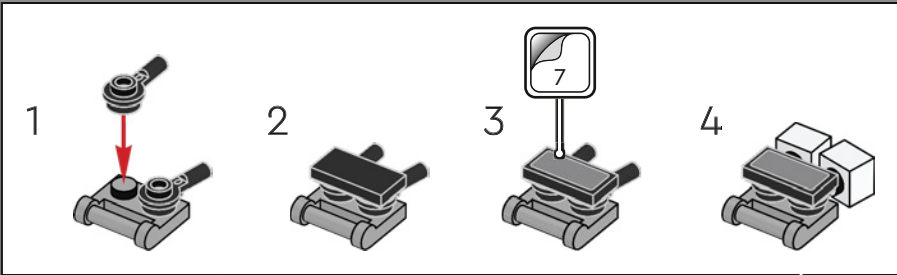

341

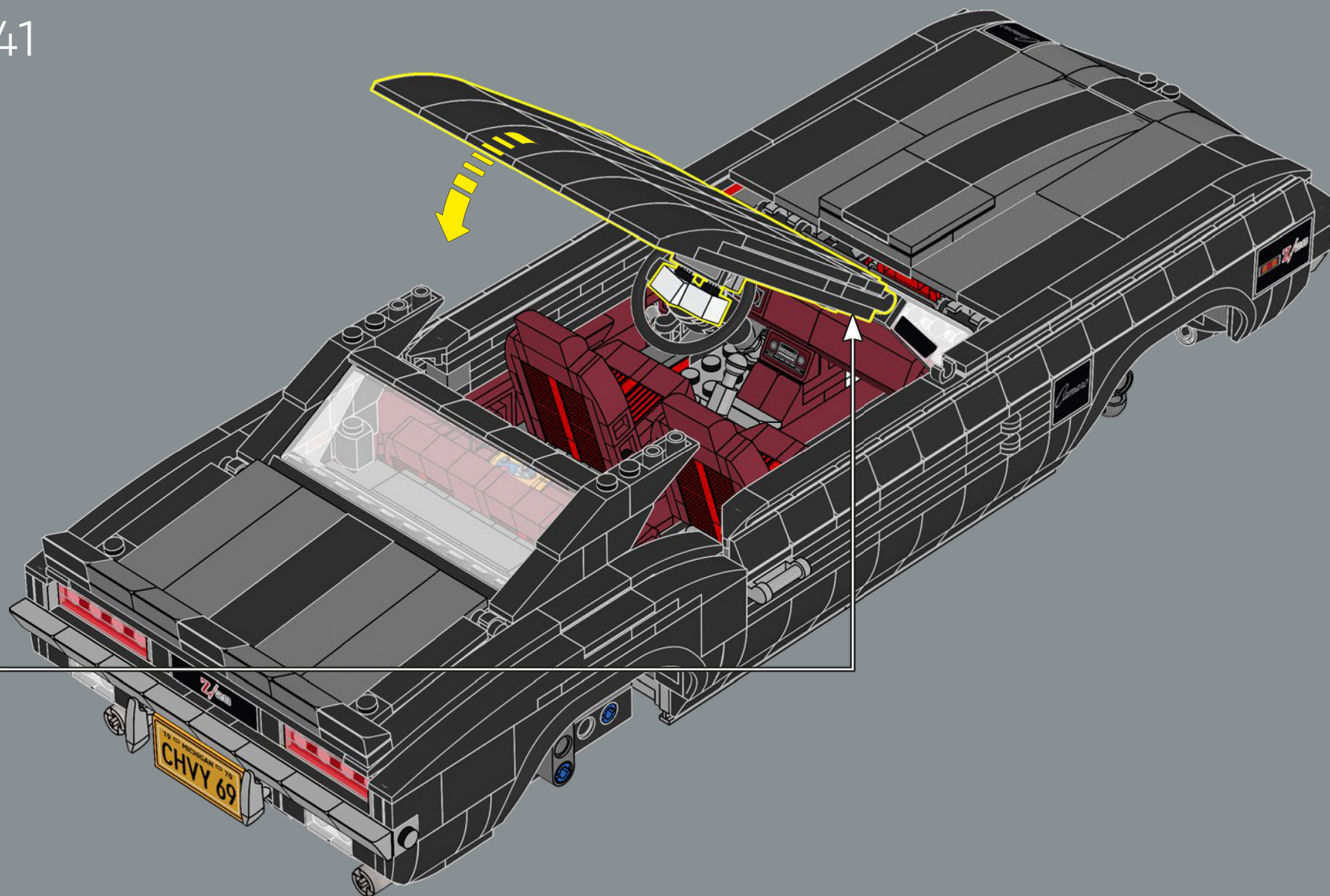

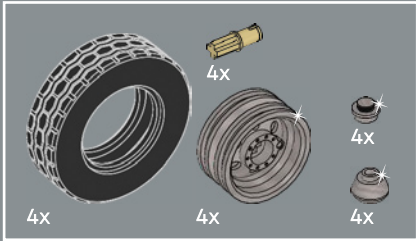
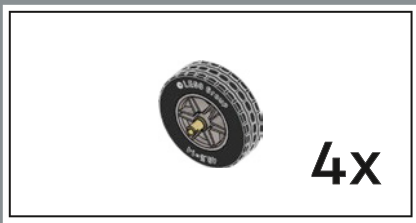

342

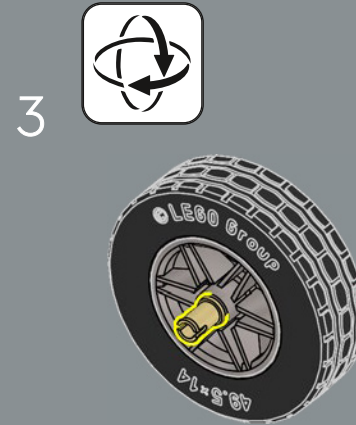
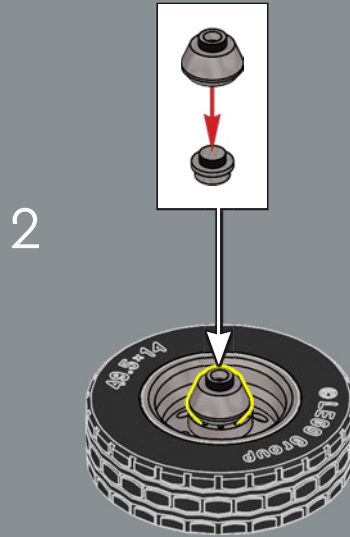
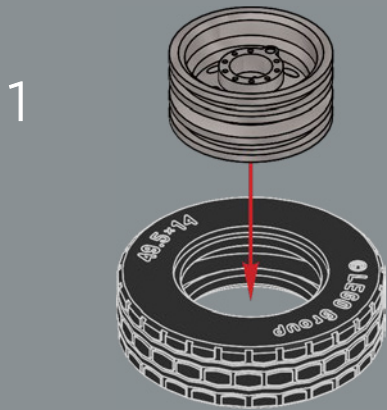

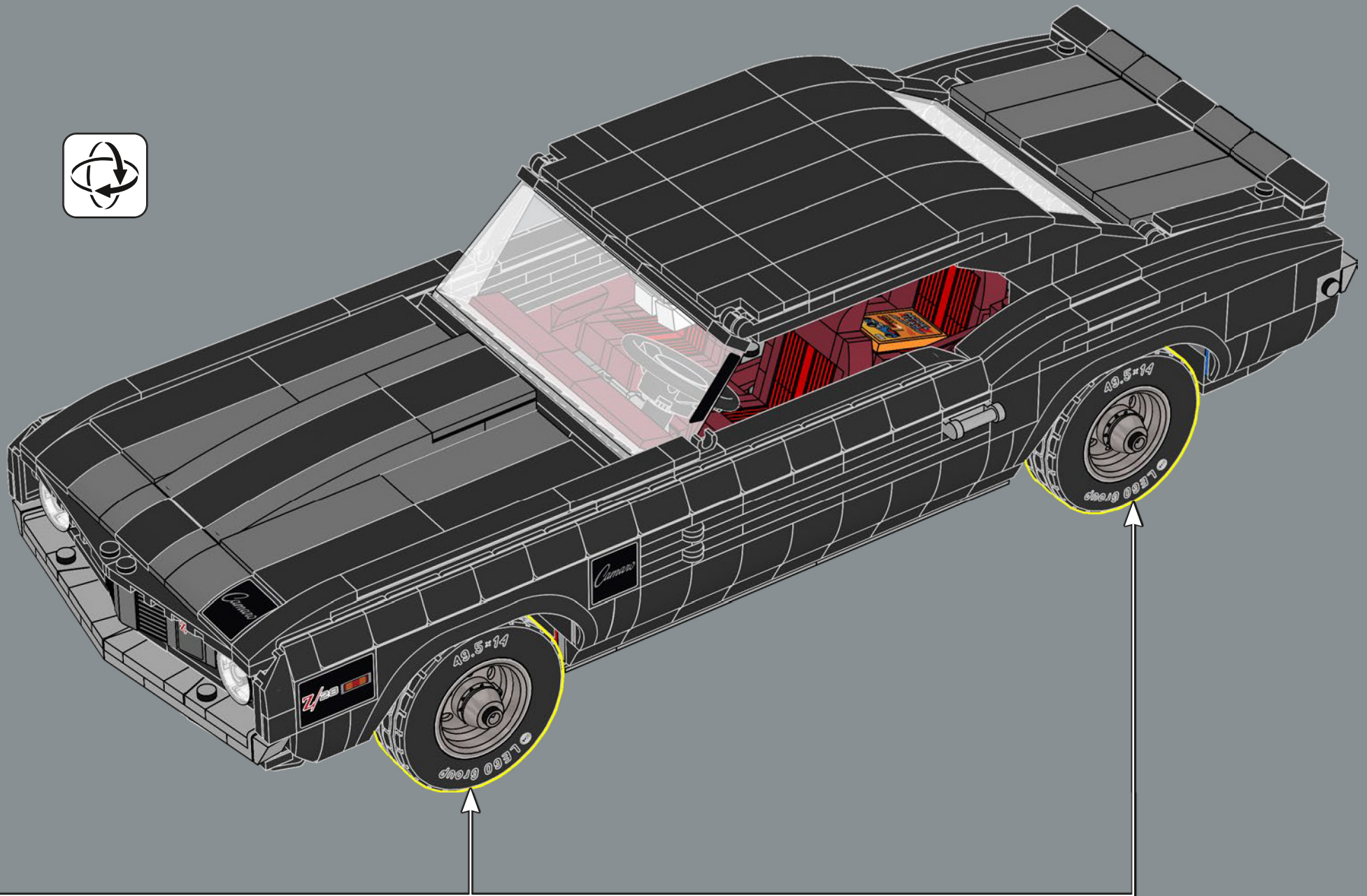



2x

343

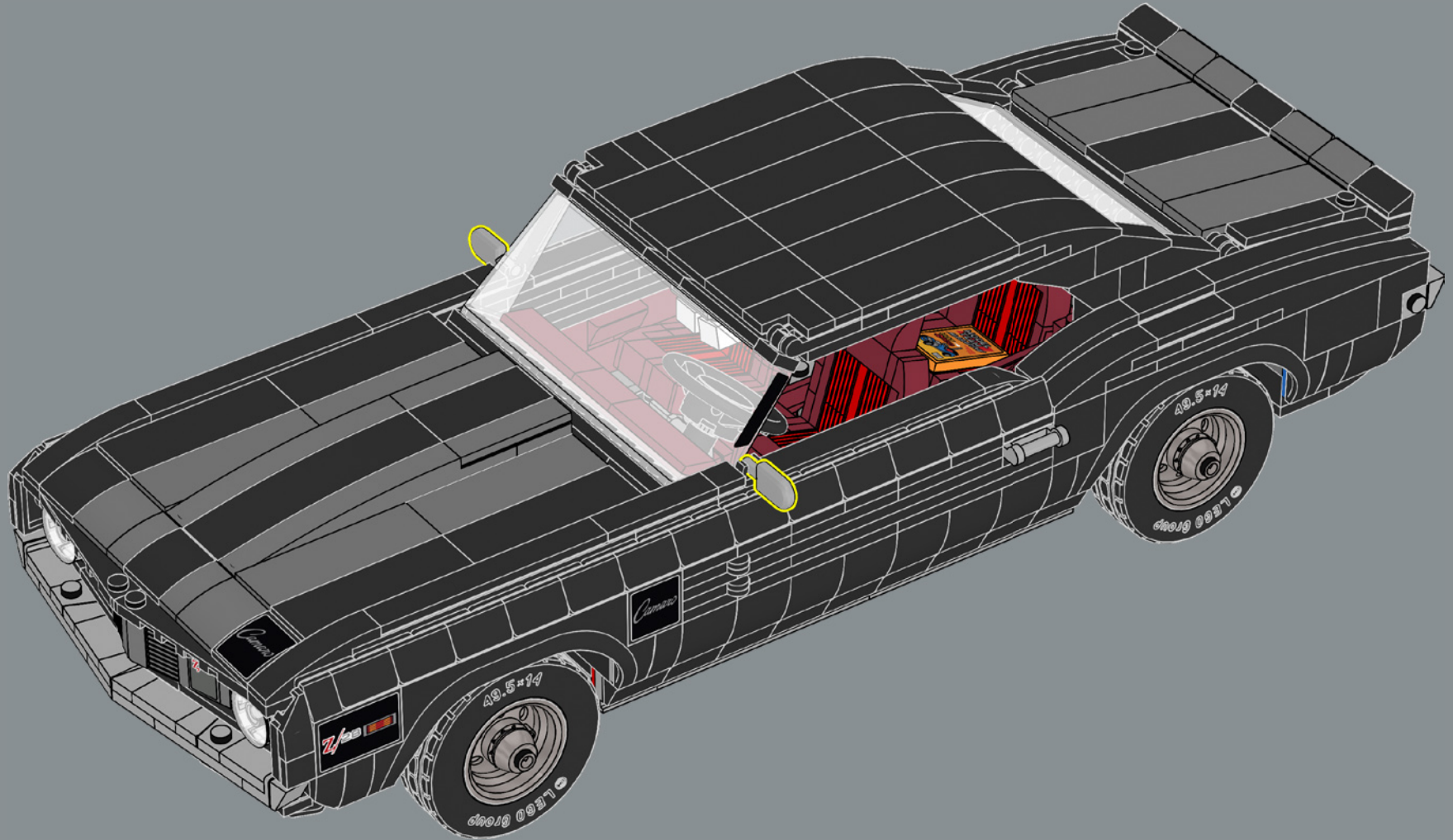

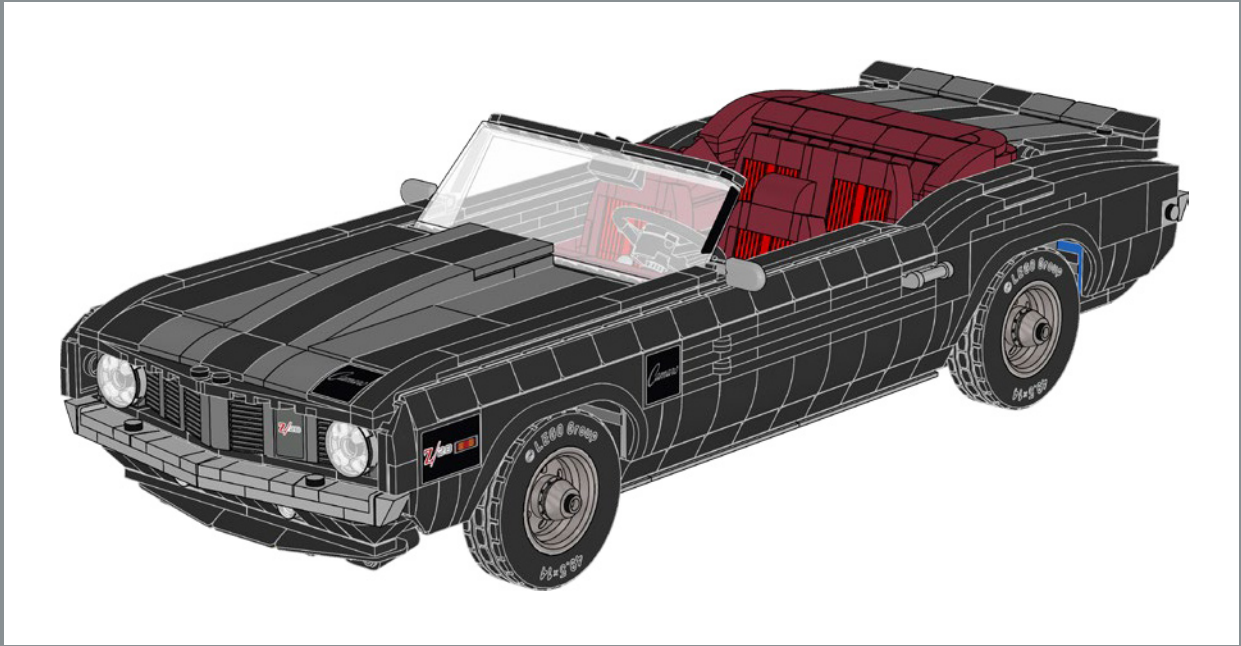

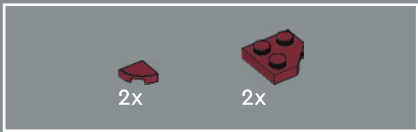

317

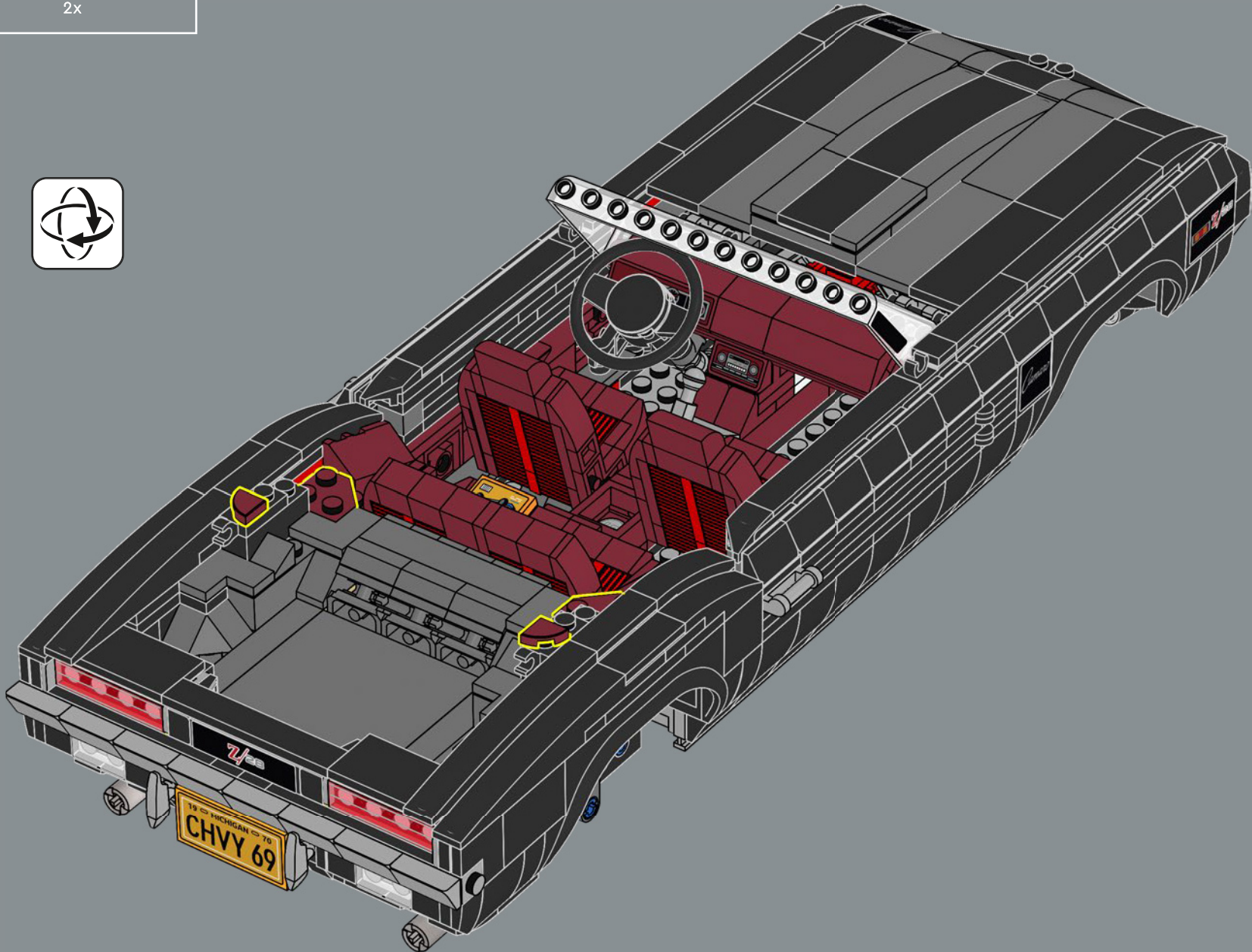



318

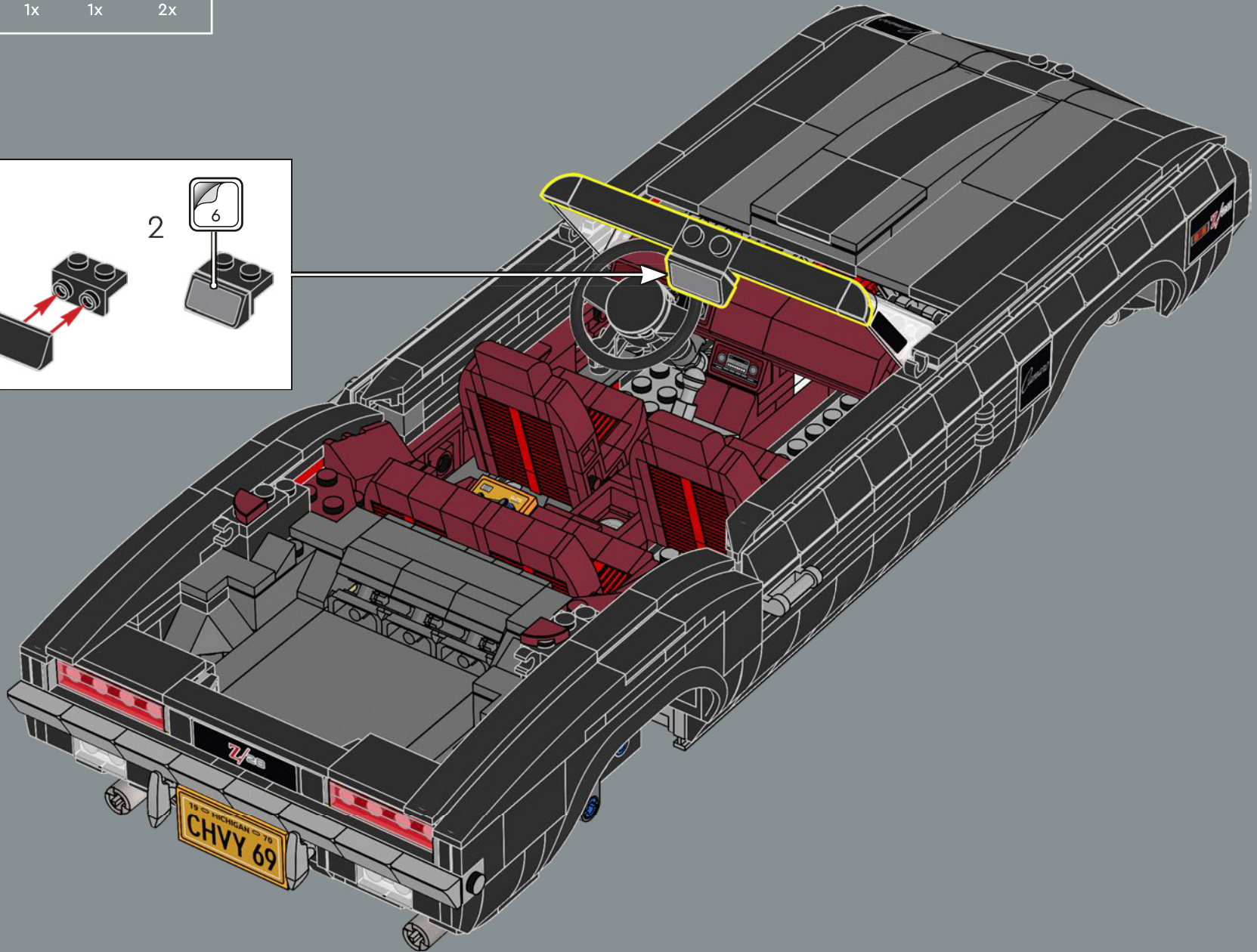
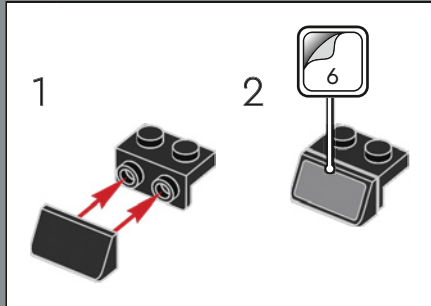

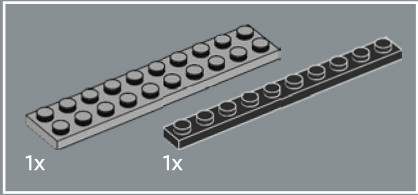

319

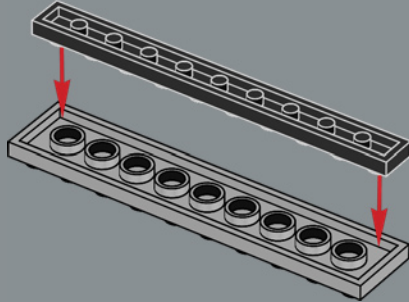

320

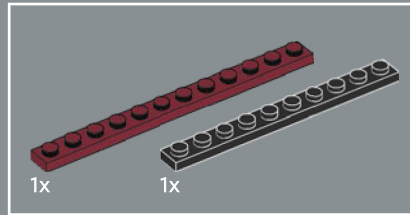
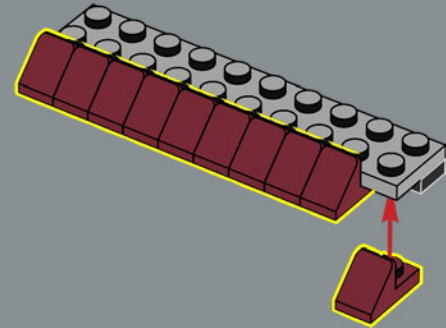

321

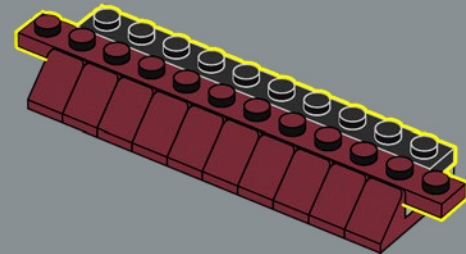

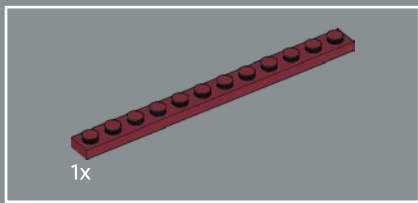

322

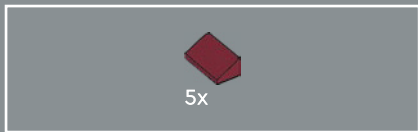
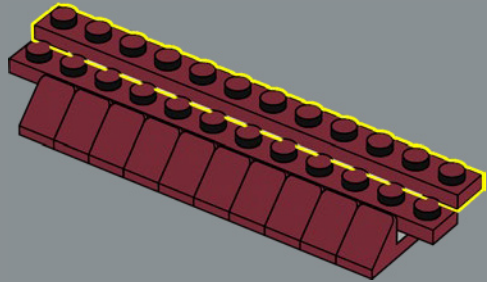

323

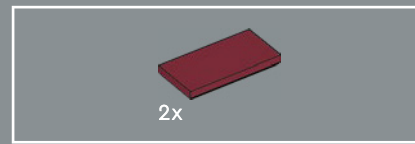
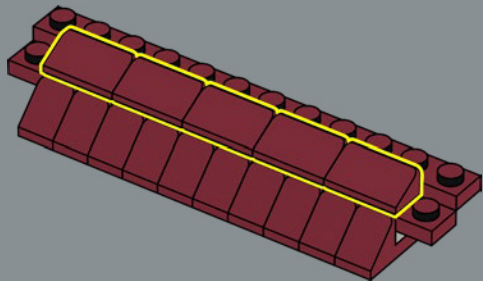

324

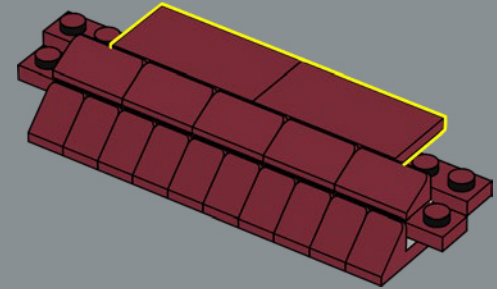

325

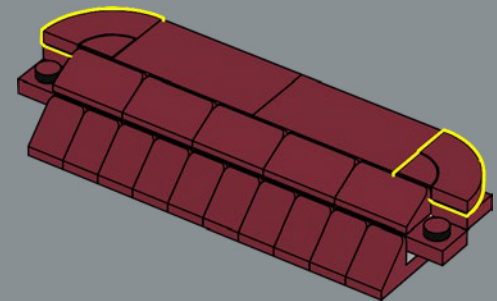

326

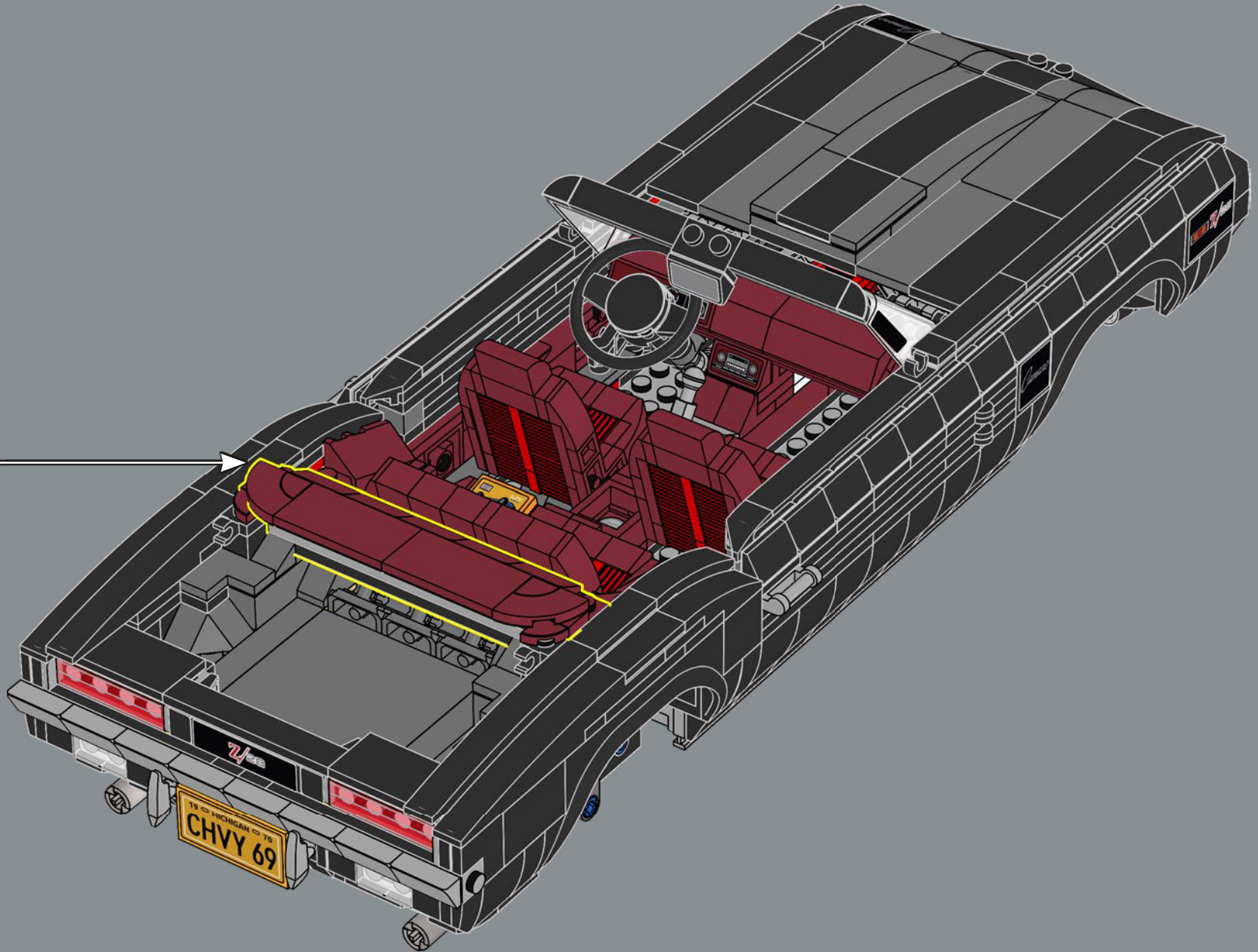

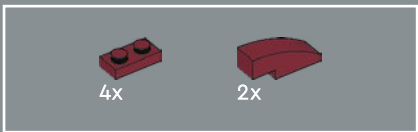

327

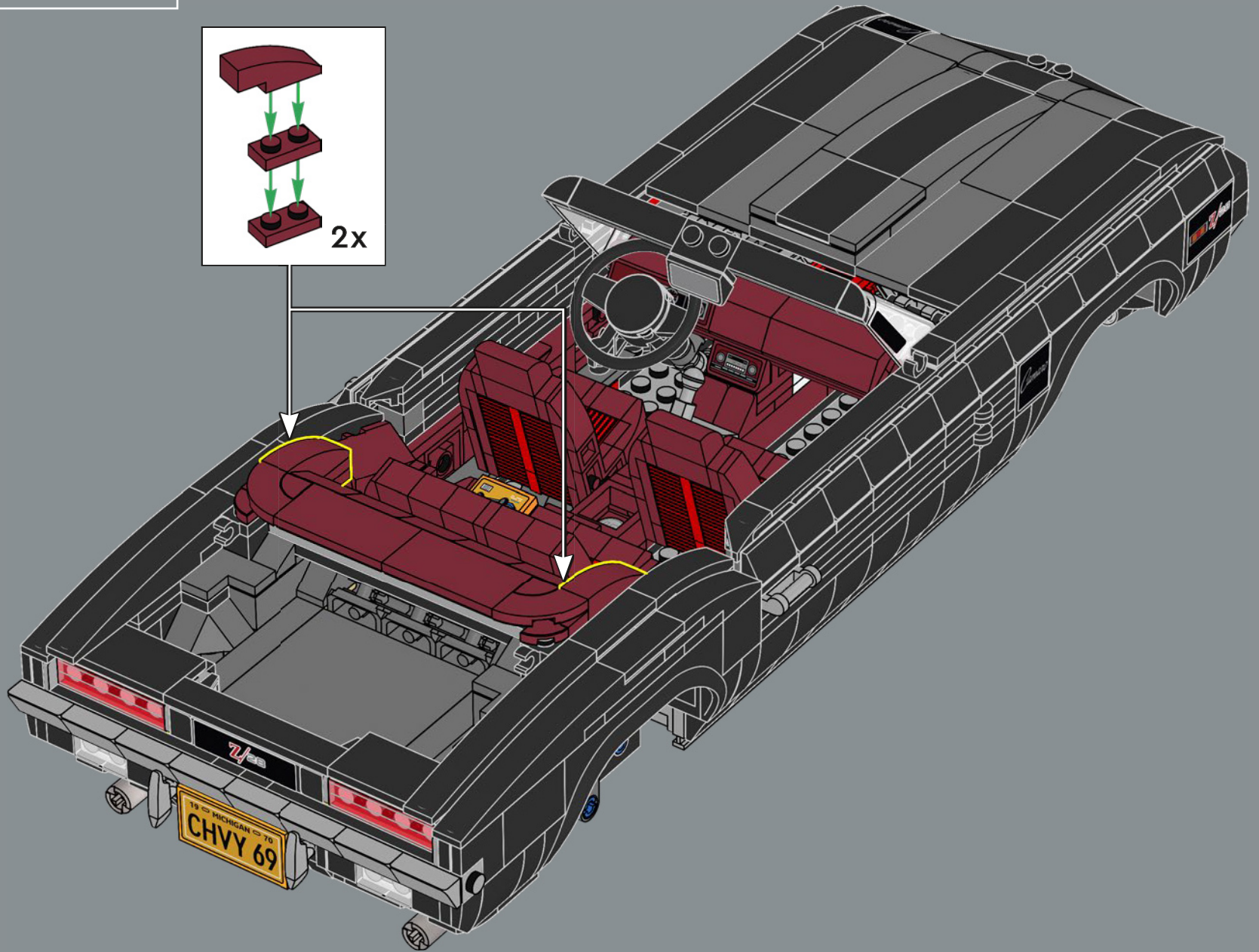
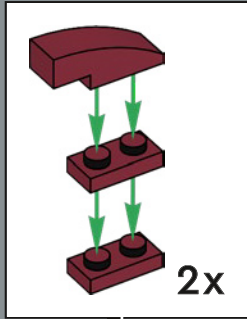

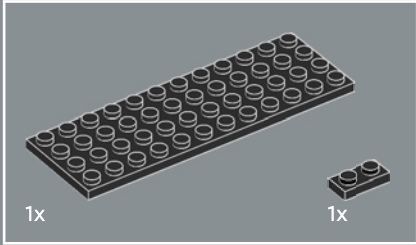
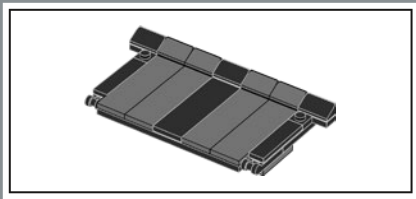

328

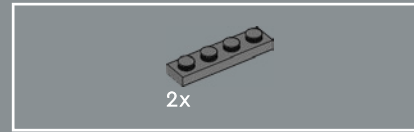
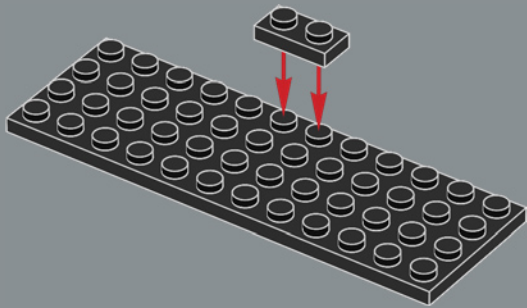

329

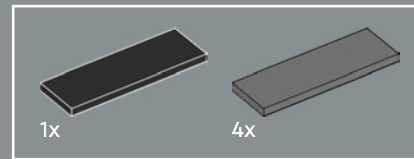
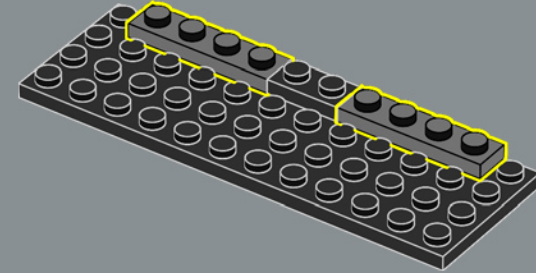

330

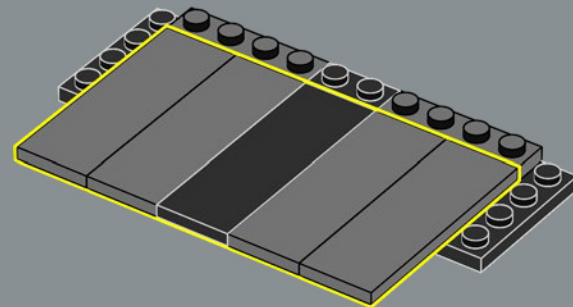

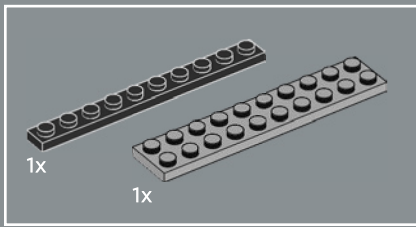

331

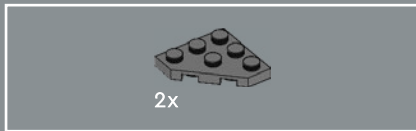
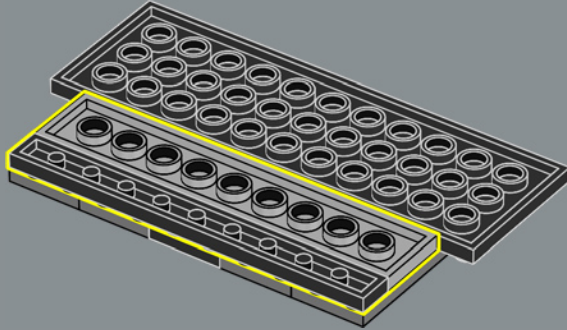

332

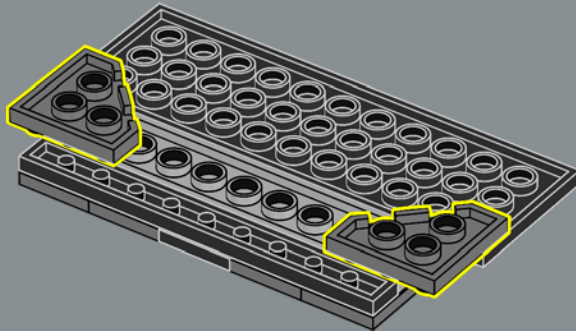

333

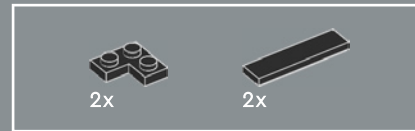
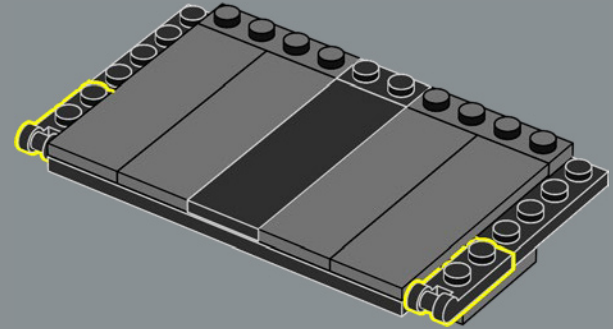

334

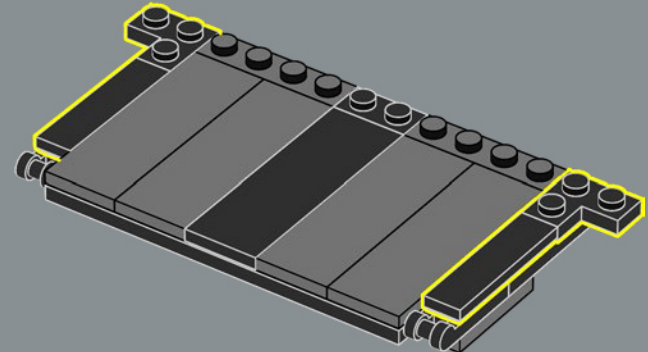



335

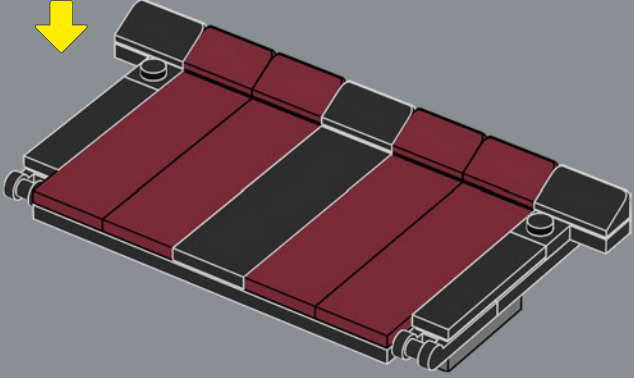
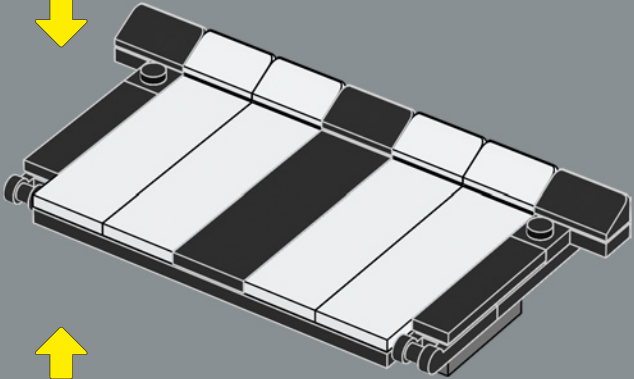
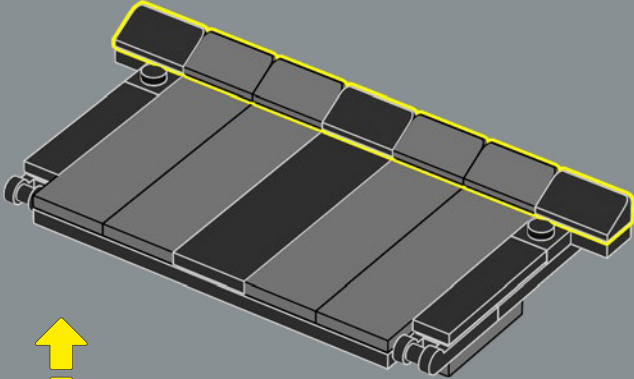

336

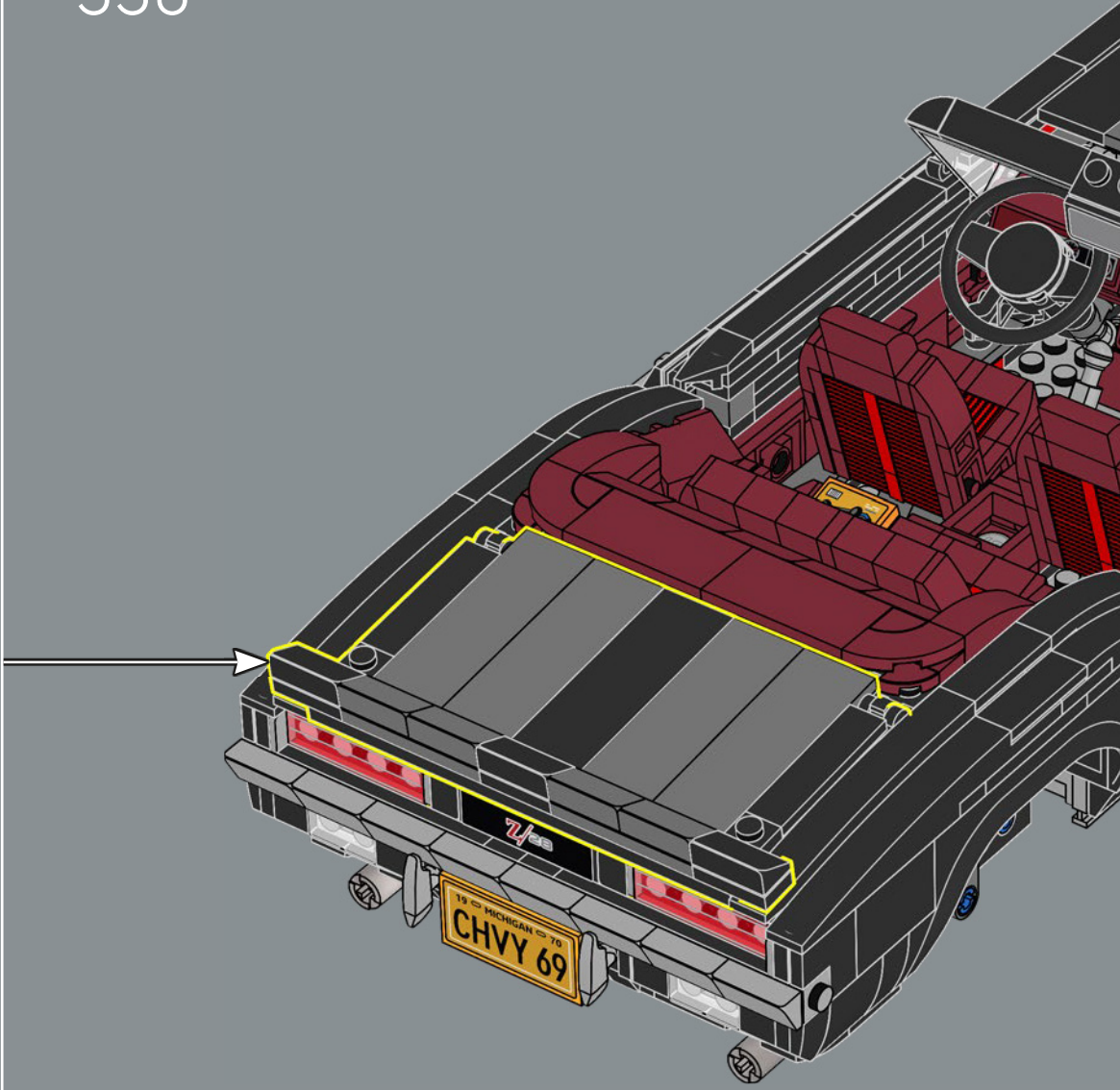

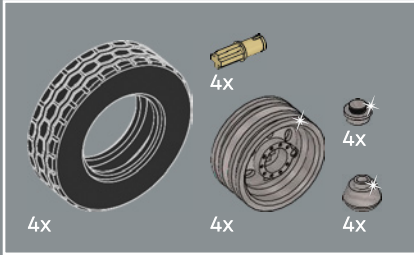
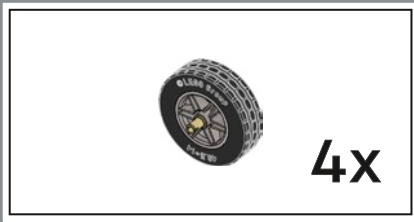

337

Der Camaro Z11, der als Safety Car beim Indy 500 im Jahr 1969 zum Einsatz kam, wurde in Kleinserie nachgebaut und zählt heute zu den begehrtesten Camaro-Modellen.

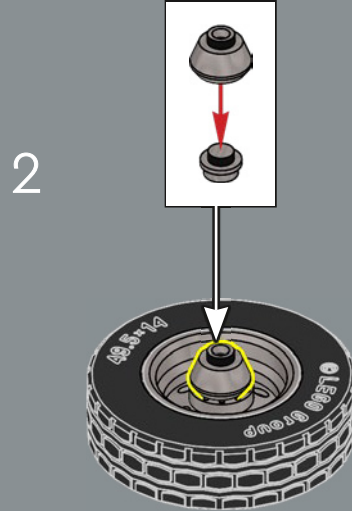
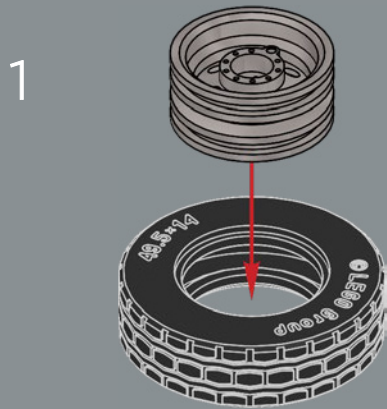

4x

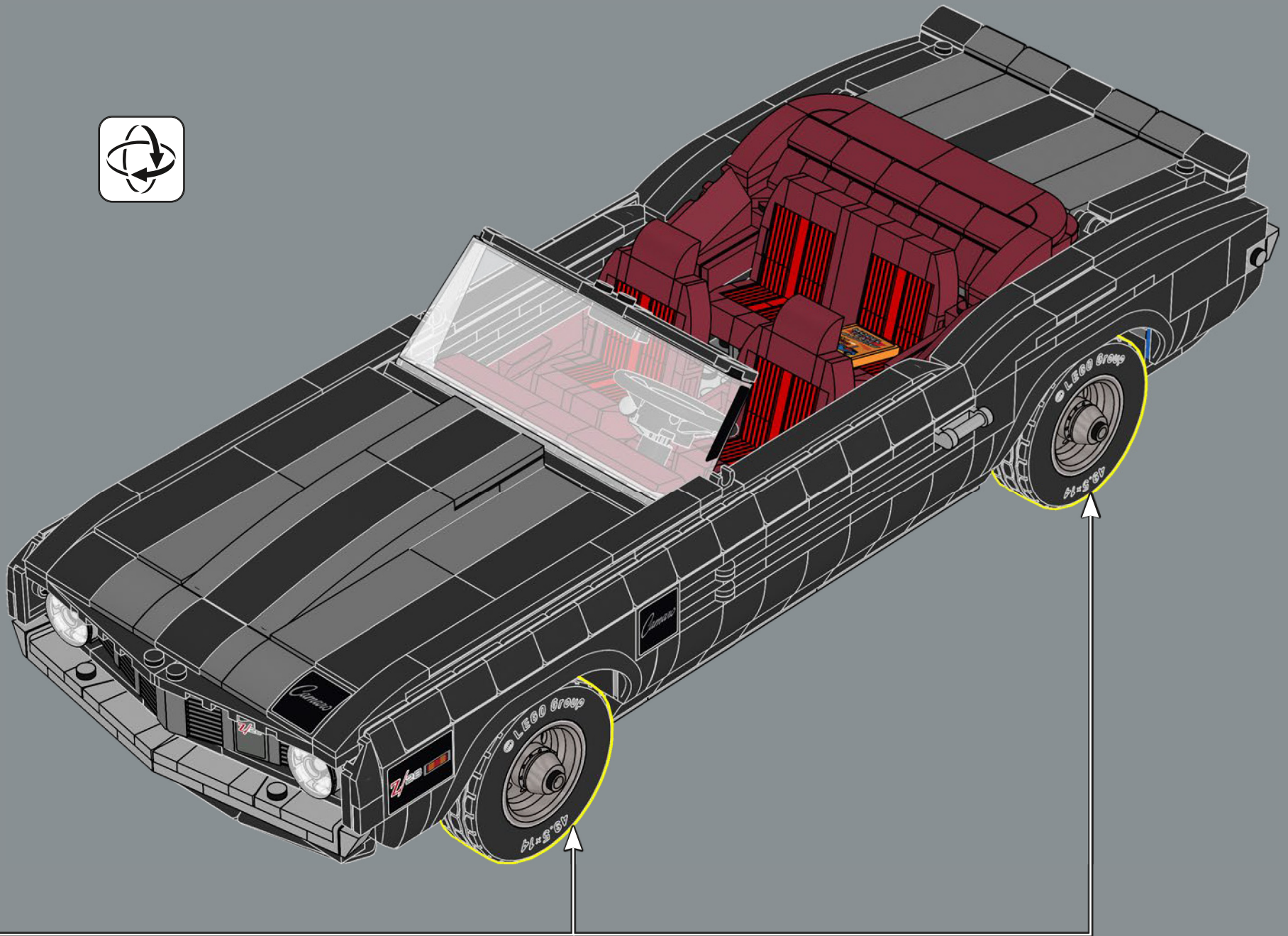



338

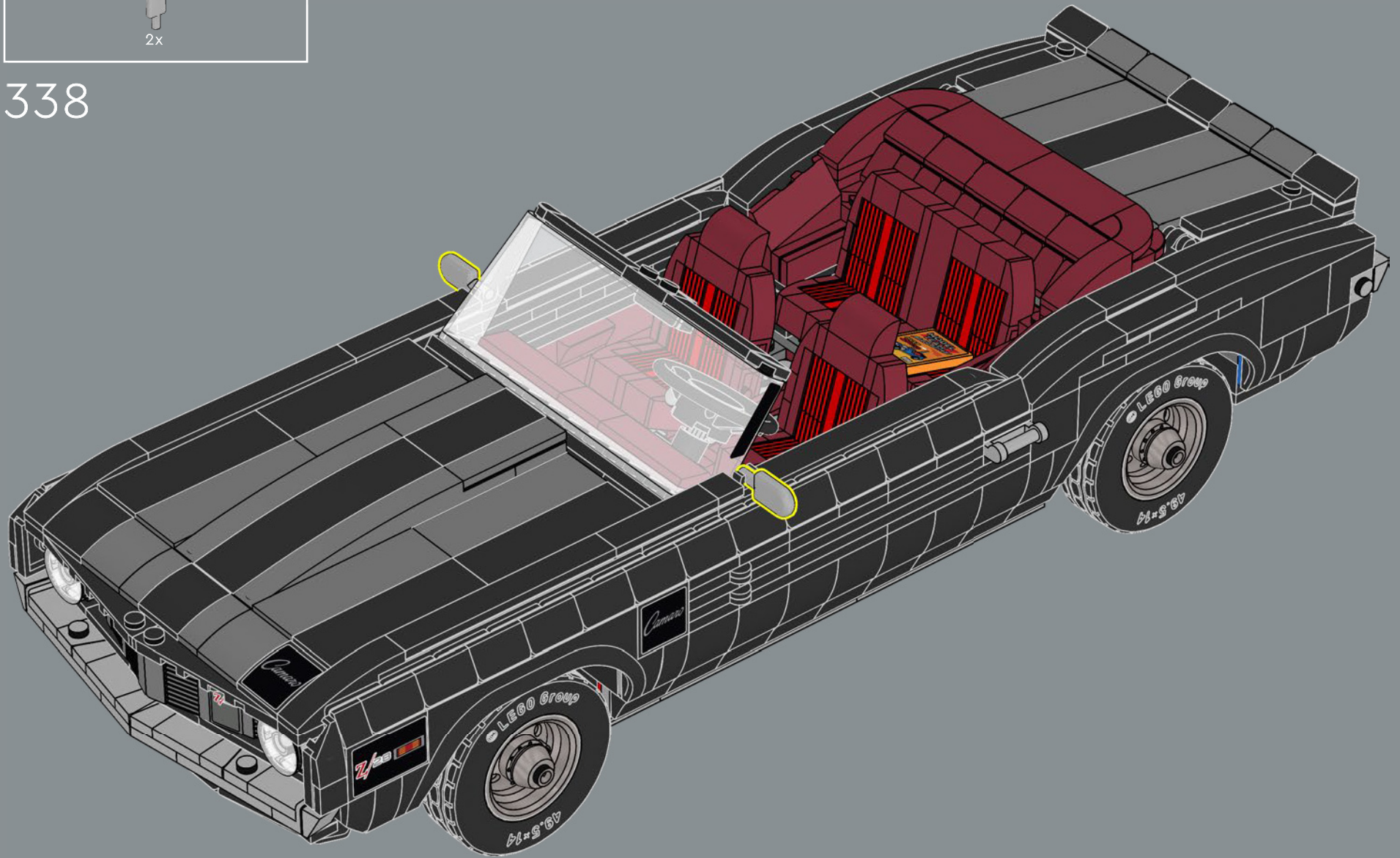

- 4x 4547489
- 2x 6034044
- 2x 6047220
- 4x 6276981
- 2x 6383985
- 4x 302201
- 2x 243101
- 2x 371001
- 2x 6104805
- 3x 302001
- 8x 6332042
- 2x 6035405
- 2x 6242241
- 3x 6347287
- 1x 6265740
- 2x 6146525
- 2x 614101
- 1x 6371416
- 1x 6289797
- 2x 4162465
- 8x 4118793
- 2x 6360037
- 8x 6024495
- 6x 4523145
- 8x 4121921
- 3x 4143409
- 3x 4249019
- 6x 6253003
- 2x 6013938
- 4x 4666579
- 2x 6416525
- 24x 6219677
- 2x 300321
- 2x 4558886
- 1x 654121
- 2x 370021
- 2x 6385920
- 1x 6275178
- 1x 330021
- 2x 307021
- 2x 302321
- 4x 6092565
- 2x 306921
- 6x 362321
- 2x 6378120
- 12x 371021
- 1x 303221
- 1x 303421
- 2x 6337002
- 2x 6347308
- 6x 6261351
- 5x 6168634
- 1x 6266205
- 8x 6168619
- 1x 6271820
- 3x 4142865
- 4x 6347789
- 1x 6130002
- 6x 393721
- 2x 300223
- 6x 6290531
- 1x 4212411
- 1x 6171063
- 2x 6057802
- 2x 306923
- 4x 6252060
- 2x 6196596
- 3x 303423
- 3x 6117968
- 4x 4206482
- 10x 6299413
- 2x 393723
- 2x 300524
- 2x 235724
- 2x 654124
- 14x 302324
- 2x 6195183
- 2x 6271167
- 1x 6170294
- 1x 6331822
- 2x 366624
- 6x 6248833
- 10x 300526
- 2x 4644456
- 4x 300426
- 6x 362226
- 2x 300226
- 5x 301026
- 2x 4584274
- 3x 370226
- 4x 4504382
- 53x 4548180
- 2x 4121966
- 4x 6267487
- 6x 366526
- 12x 6069000
- 1x 303926
- 2x 6176768
- 4x 428626
- 6x 428726
- 1x 6064228
- 5x 6181720
- 4x 6273589
- 2x 4107558
- 4x 302426
- 2x 6388352
- 6x 307026
- 44x 302326
- 8x 306926
- 2x 6214807
- 14x 6192346
- 4x 306826
- 2x 6312724
- 10x 302226
- 6x 242026
- 4x 6133722
- 4x 6195271
- 1x 403226
- 5x 6181713
- 2x 6184784
- 10x 6047276
- 26x 6053077
- 2x 6211476
- 2x 4618880
- 2x 6280394
- 1x 6319983
- 1x 6316923
- 1x 6331026
- 6x 6037746
- 6x 4647286
- 1x 6296083
- 4x 6037664
- 6x 243126
- 6x 371026
- 7x 302026
- 4x 4560182
- 2x 6350415
- 3x 663626
- 12x 366626
- 11x 6318582
- 6x 416226
- 1x 303226
- 1x 395826
- 14x 447726

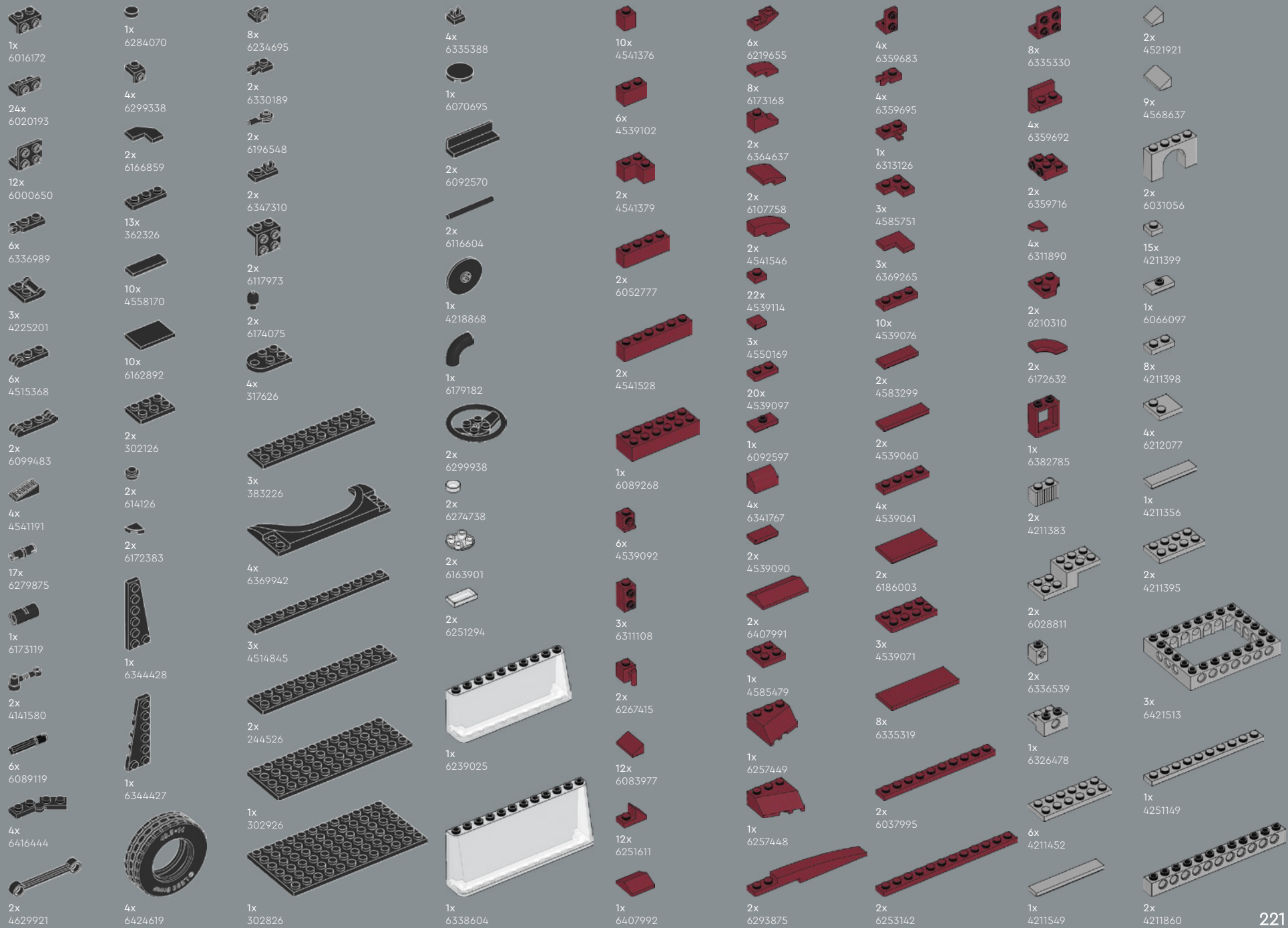



Customer Service
 Kundenservice
 Service Client
 Assistenza clienti
 Atención al cliente
 Serviço de Apoio ao Consumidor
 Ügyfélszolgálat
 Klientu apkalpošanas dienests
 Serviciul pentru clienț
 客户服务
 コンシューマーサービス
 고객 서비스
LEGO.com/service



FEEDBACK AND WIN



FEEDBACK AND WIN

Your feedback will help shape the future development of this product series.

Please visit:

FEEDBACK UND GEWINNEN

Dein Feedback trägt zur Weiterentwicklung dieser Produktreihe bei.

Geh auf:

COMMENTEZ ET GAGNEZ

Vos commentaires nous aideront à concevoir les futurs produits de cette gamme.

Rendez-vous sur :

COMENTA Y GANA

Tu opinión nos ayudará a dar forma al desarrollo de esta serie de productos en el futuro.

Visita:

反馈有奖

您的反馈将有助于我们在今后改进本系列产品。

请访问：

[LEGO.com/productfeedback](https://www.lego.com/productfeedback)

By completing, you will automatically enter a drawing to win a LEGO® set.

Terms & Conditions apply.

Durch Ausfüllen nimmst du automatisch an der Verlosung eines LEGO® Preises teil.

Es gelten die Teilnahmebedingungen.

En envoyant vos commentaires, vous serez automatiquement inscrit(e) à un tirage au sort qui vous permettra de remporter un prix LEGO®.

Offre soumise à conditions.

Al contestar, participarás automáticamente en el sorteo y podrás ganar un set LEGO®.

Sujeto a Términos y Condiciones.

完成我们的反馈调查，即可自动进入抽奖环节，赢取乐高®套装。

适用《条款和条件》。



LEGO and the LEGO logo are trademarks of the LEGO Group. ©2022 The LEGO Group.

General Motors trademarks used under license to the LEGO Group.