



*Camaro* Z/28  
1969





**We've got a mean streak.**

**Z/28 Camaro.**

The '69 Z/28. So ominous it goes by its code name. Cable lockers. 302. Standard equipment: mechanical lifters, high-performance cam springs and heavy-duty shocks. New for '69 are special white lettered tires on 15 x 7-inch wide wheels and a Hurst shifter for the 4-speed. To complete the setup, just add the new 'Vette-type 4-wheel power disc brakes. By now you know the mean streak isn't just painted on—it's built in. One more thing. People are bound to ask what the Z stands for. Tell them "Zaps." **Putting you first, keeps us first.**

## 运动型轿跑车

具有运动风格的“Pony Cars”时尚而又经济实惠，在 20 世纪 60 年代中期首次出现即令汽车行业发生了翻天覆地的变化。年轻一代的新车手立即被这种汽车的流线型车身、修长的引擎盖以及强大的发动机所吸引。尽管几乎所有的汽车制造商都对“Pony Cars”做出了自己的诠释，但很少能企及雪佛兰标志性的 Camaro。



**Z-28**

Competition's newest nightmare!

**The skier's skier with the Camaro's Camaro.**



There are skiers. And then there are skiers. Jean-Claude Killy is one of the latter.

The Camaro Z/28 is a special breed, too. It comes poised on a beefed-up suspension and special road-grabbing wide oval tires.

Under that striped hood is a tough 302 V8 that inhales through a big Holley 4-barrel and exhales through dual exhausts.

**Z/28**

Add four-on-the-floor with a Hurst shifter plus 4-wheel power disc brakes and you've got the closest thing to a 'Vette yet.

Z/28. In our Sports Department. Almost as much fun as skiing.

**Putting you first, keeps us first.**

See Olympic Gold Medalist Jean-Claude Killy, Sundays, CBS-TV. Check your local TV listings.

69 CH-43 A  
Ski February  
February  
page-4 colors  
A P 7729-11 21 68-5



## 脱颖而出

第二代雪佛兰 Camaro Z28 很好地保留了肌肉车的精髓。1969 年推出的凸起式引擎盖（带有标志性的“cowl induction”进气装置）和冲压在挡泥板和车门上的速度线确保了它的原创性和独特性。它拒绝借鉴当时其他汽车的设计，而半个世纪后，它看起来依然清新醒目。



camaro

Camaro

CAMARO



## 汽车典范

虽然距离推出第一款雪佛兰 Camaro 已经过去了 55 年,但这个知名品牌至今仍然充满活力、深受欢迎,这款标志性车辆的第六代已在生产。这是一个将继续跨越不同时代的品牌和名称,它深受肌肉车铁杆粉丝的喜爱,并出现在无数电子游戏、电视节目、电影和流行文化中。

CAMARO

CAMARO





## 设计团队感言

“我从小就热爱汽车，并且很早就开始翻阅改装汽车杂志，因此，能够与真正的雪佛兰汽车设计师一起设计这款乐高®模型算是让我梦想成真。设计过程中，一方面需要确保模型的整体造型和姿态正确，另一方面我们还想添加那些有趣却必不可少的细节，如可以工作的车门和转向装置。能够提供一些定制选项也很棒，就像当时的原始版 Camaro 那样。”

**Sven Franic, 乐高®设计师**





## 你的模型你做主

原始款 Camaro 深受欢迎的一项功能是提供多种个性化选项和高性能发动机。同样,这里也由你来决定如何设计乐高®版汽车:是硬顶轿跑车还是酷炫的敞篷车?那么条纹呢?经典的白色,淡淡的灰色还是鲜艳的红色?大灯灯罩和车牌(两个)都可供选择。



三款模型不能同时拼搭。

你可以访问以下网址,找到这些可选模型的说明:  
[LEGO.com/buildinginstructions](https://www.lego.com/buildinginstructions)





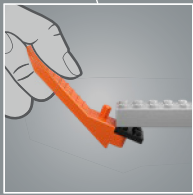
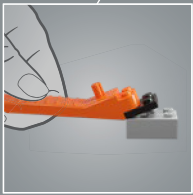
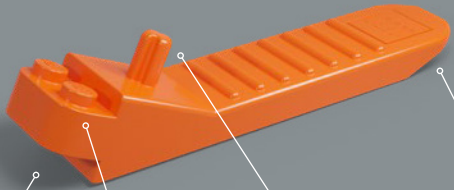
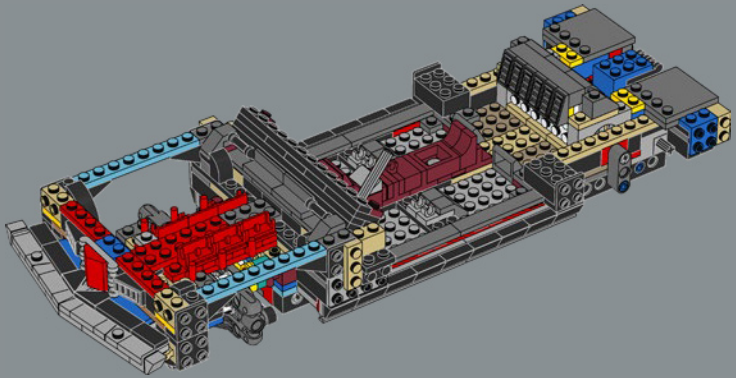
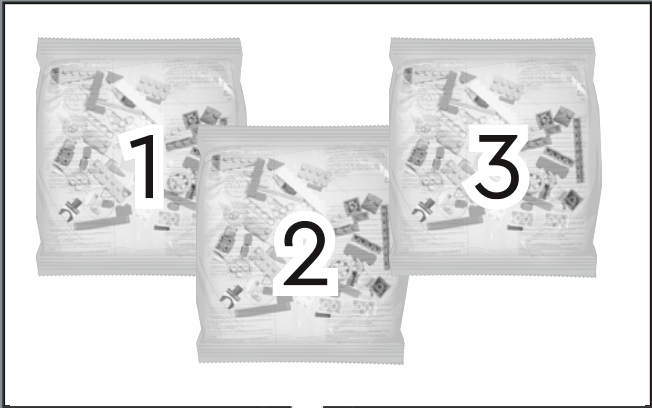

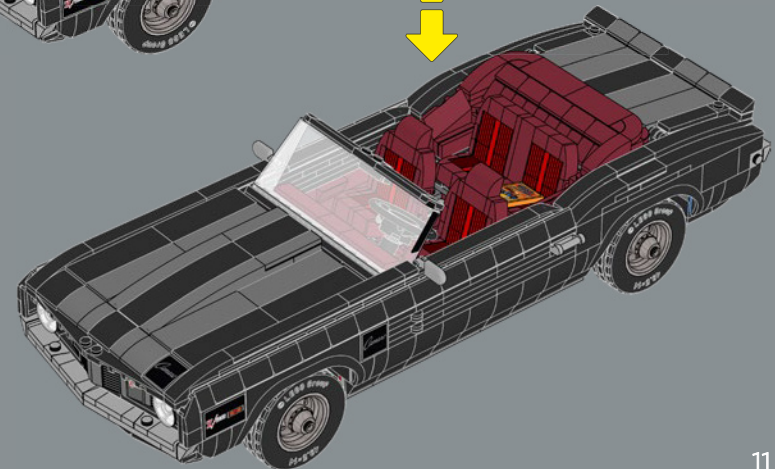
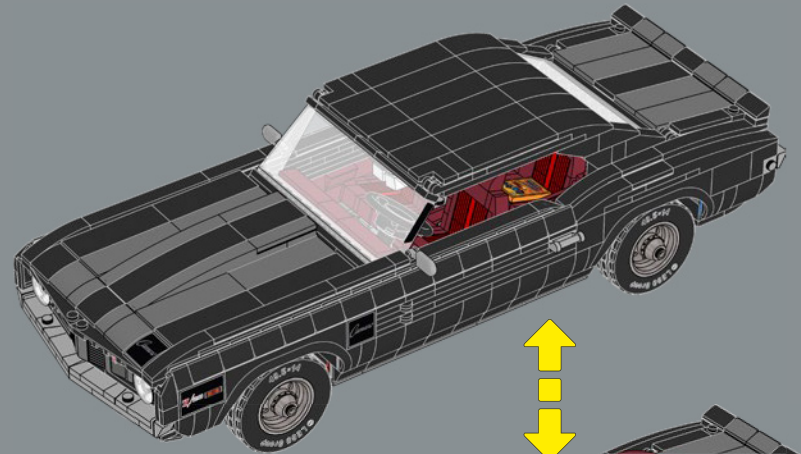
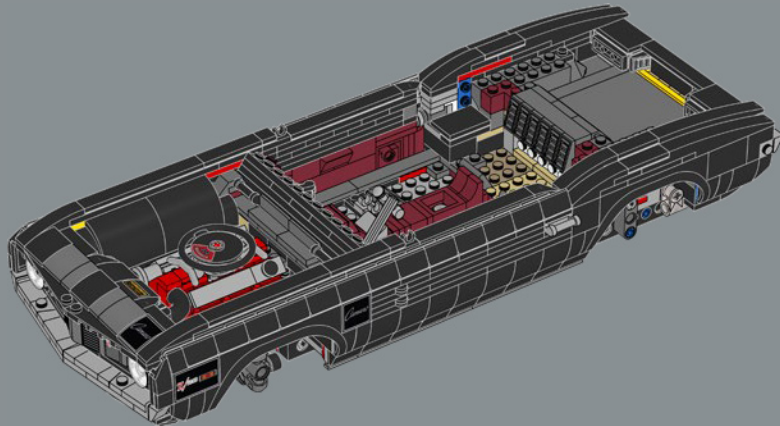
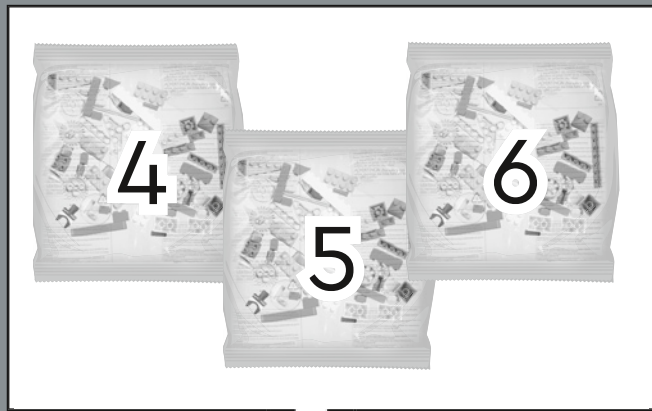

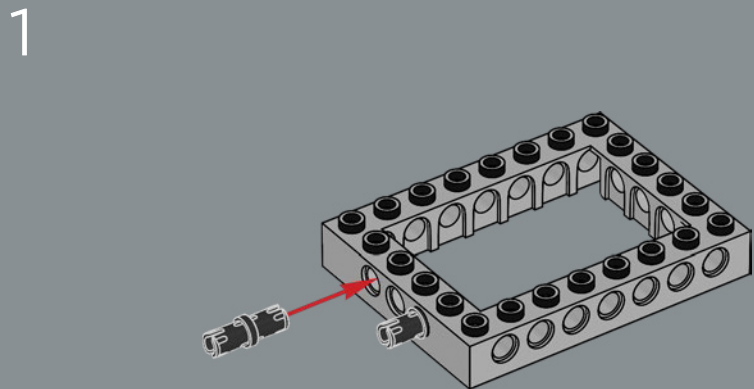
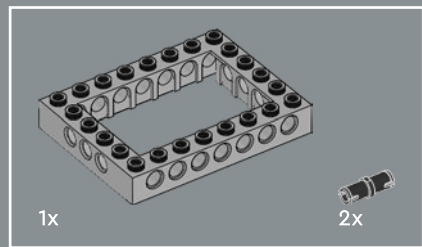

2

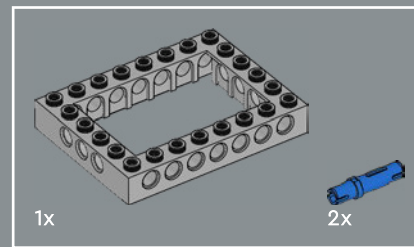
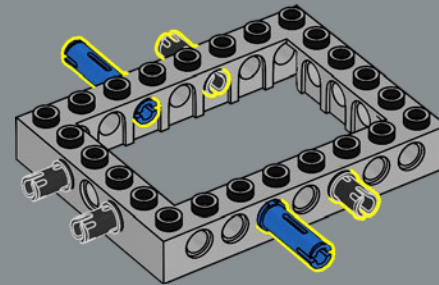

3

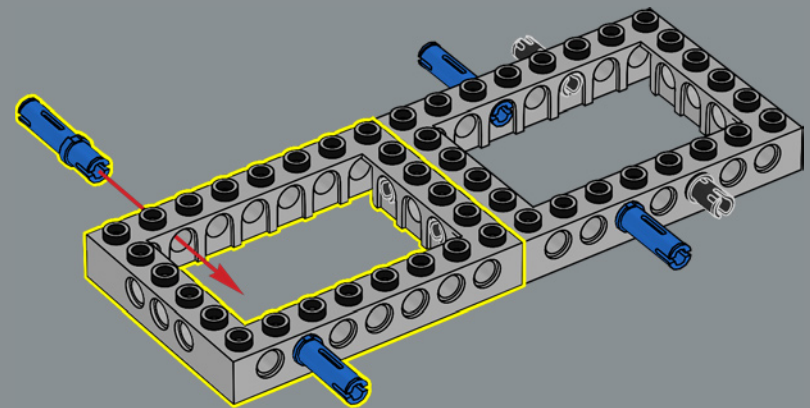

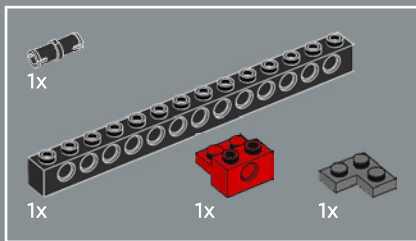

4

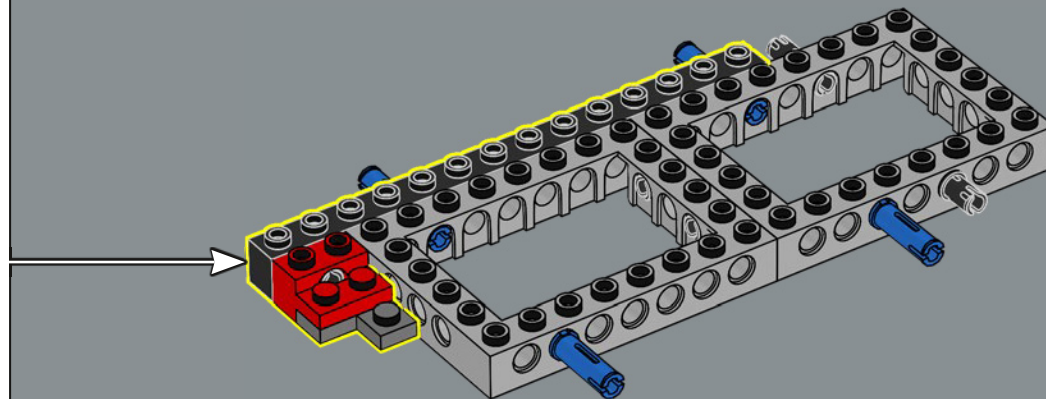
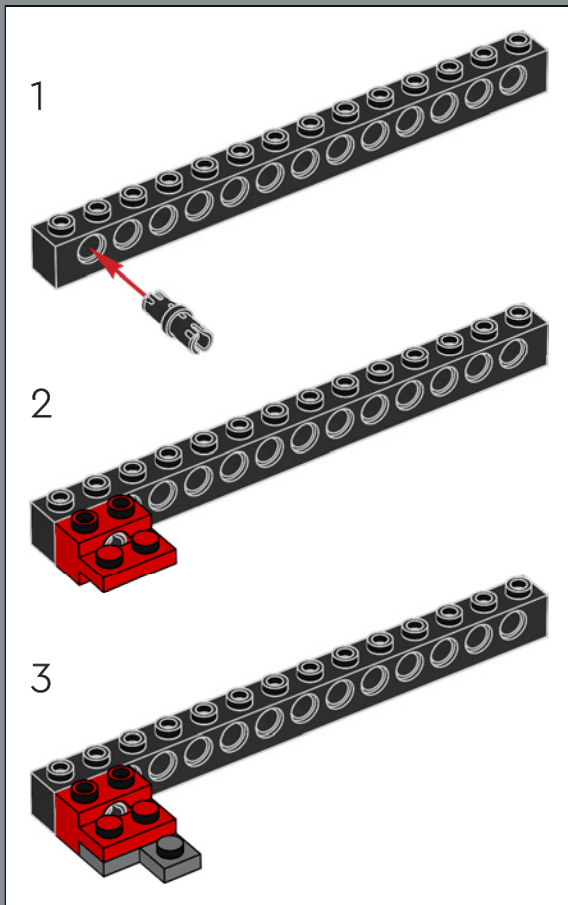

Camaro 这个名称符合雪佛兰的传统，  
即其大部分车型的名称都以字母“C”开头  
(如 Corvair、Corvette、Chevelle 等)。

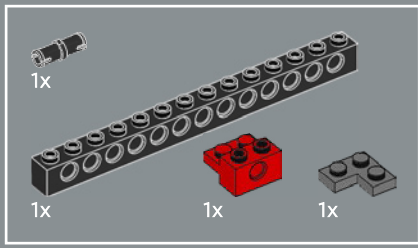

5

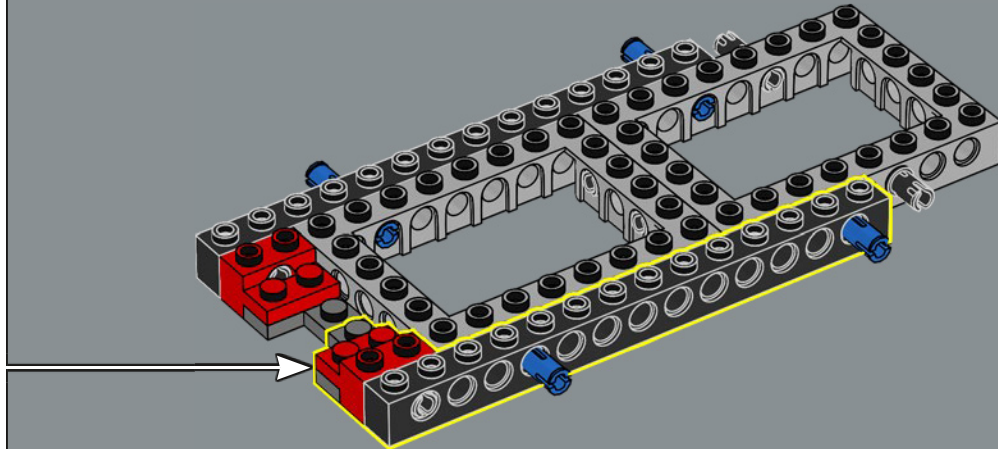
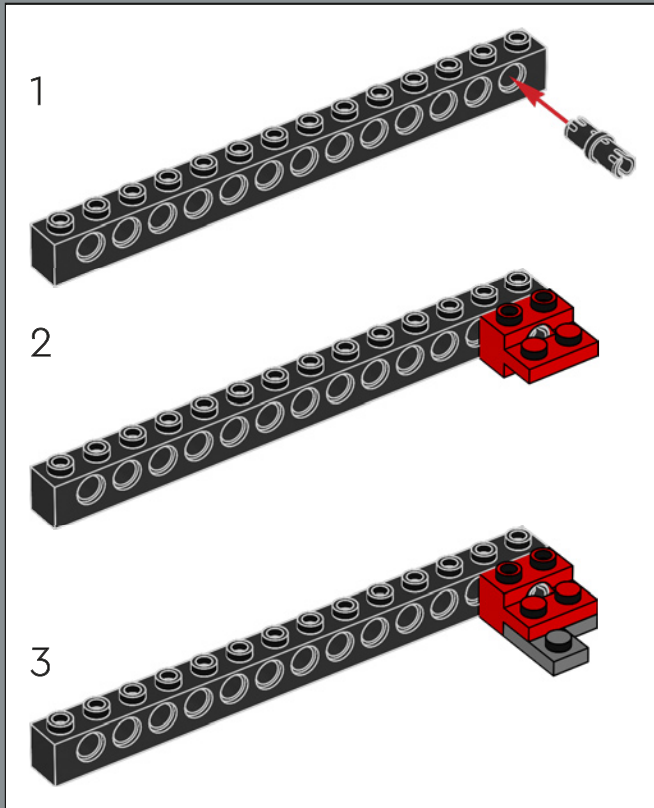

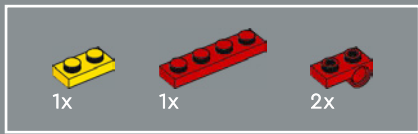

6

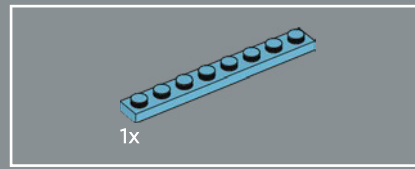
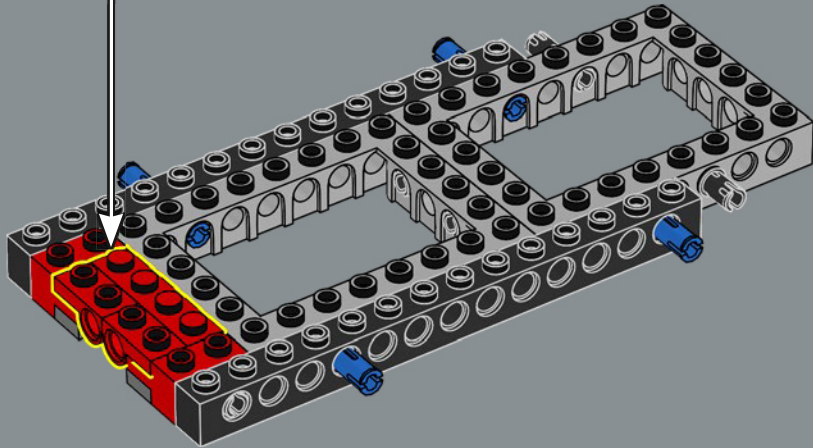
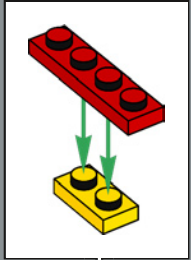

7

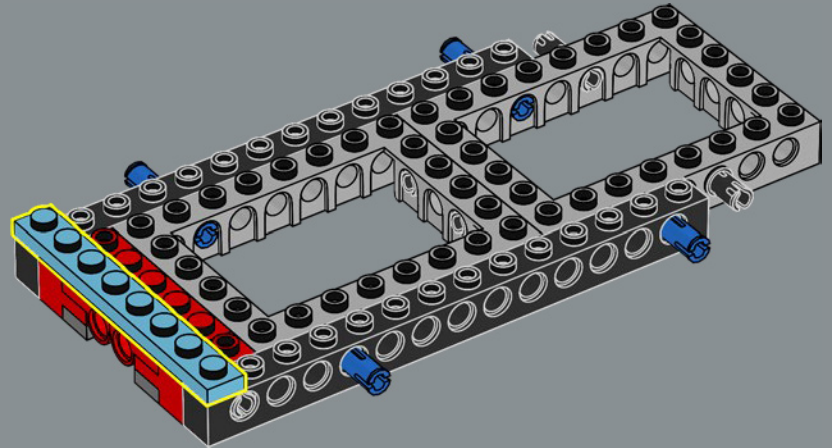

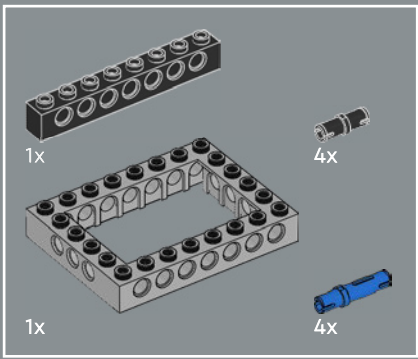

8

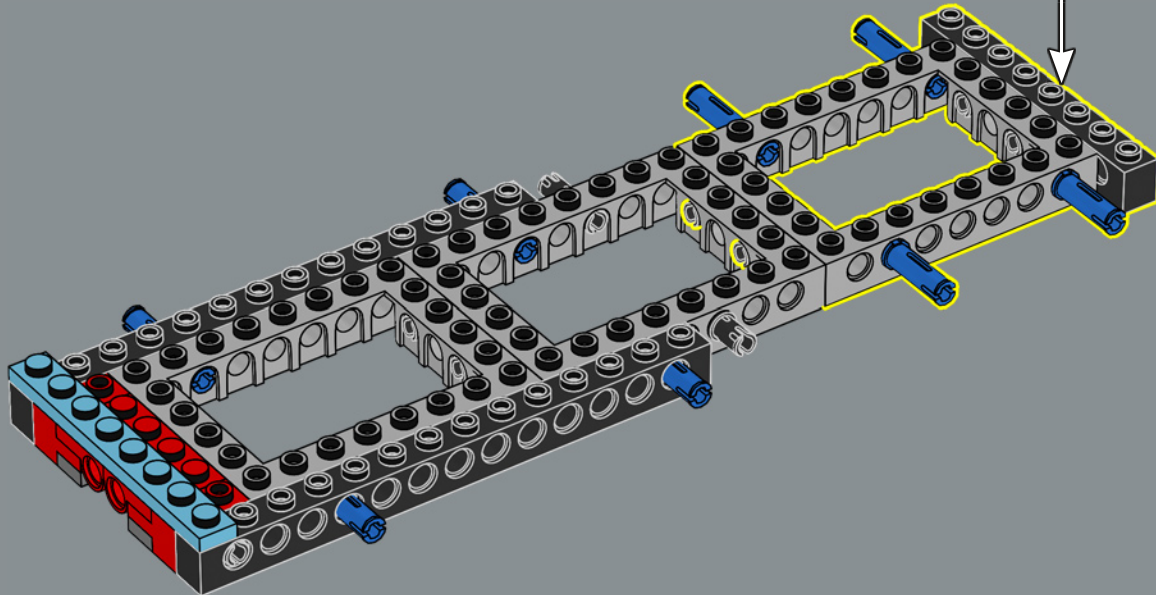
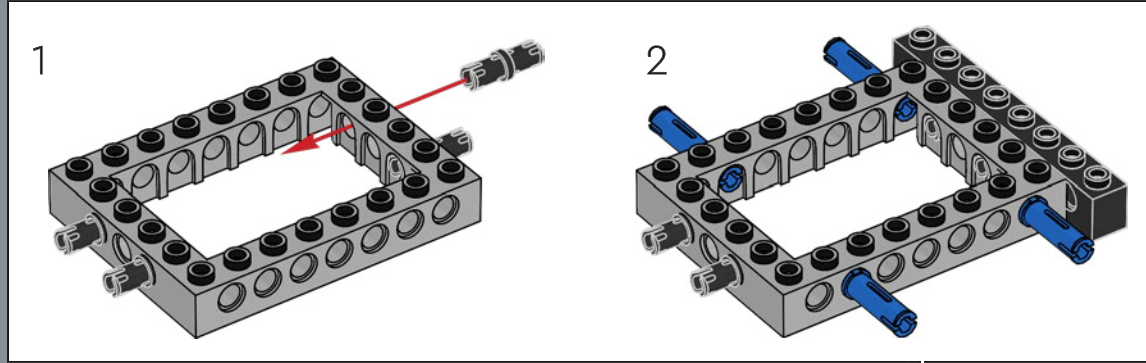



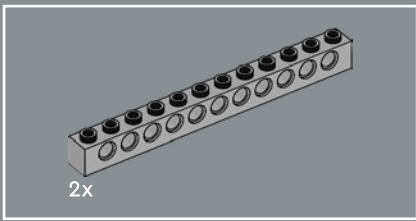

9

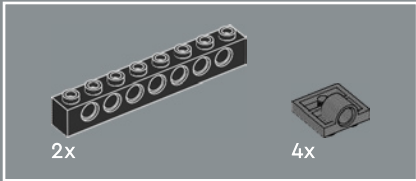
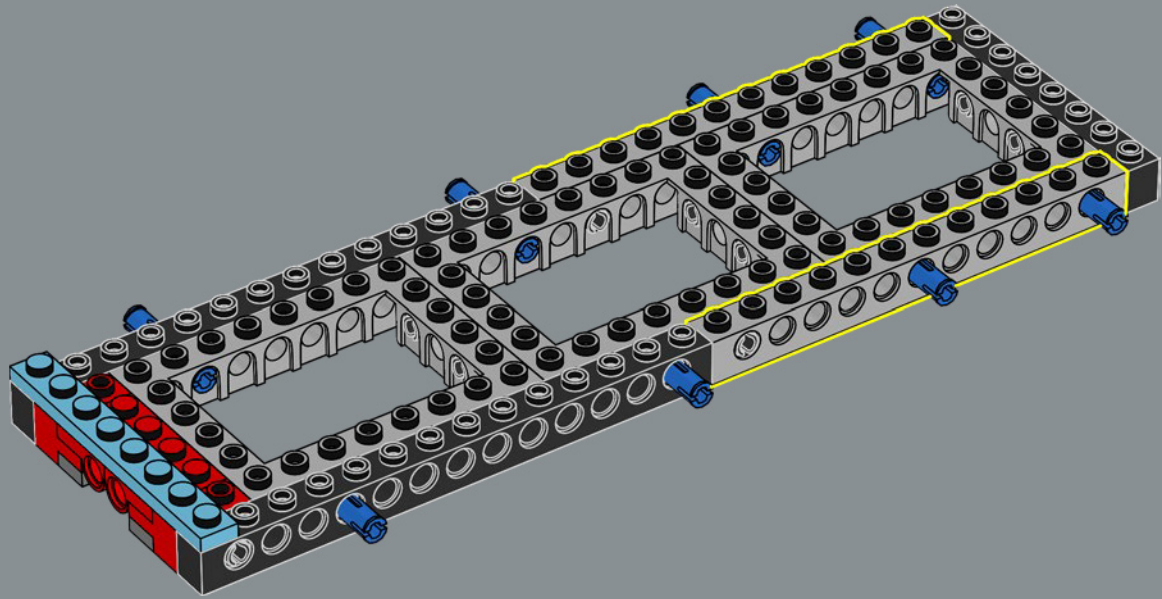

10

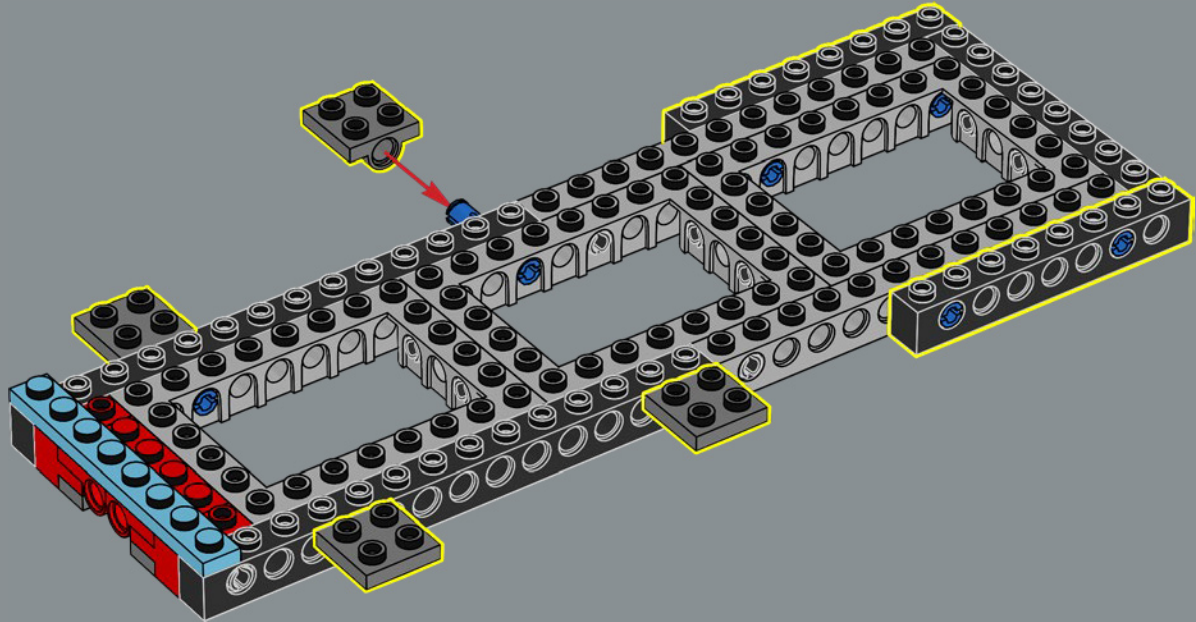

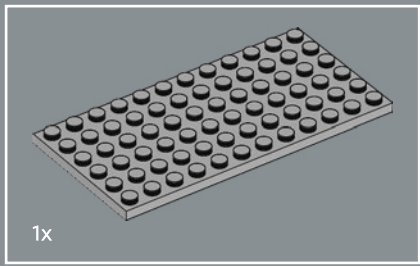

1x

11

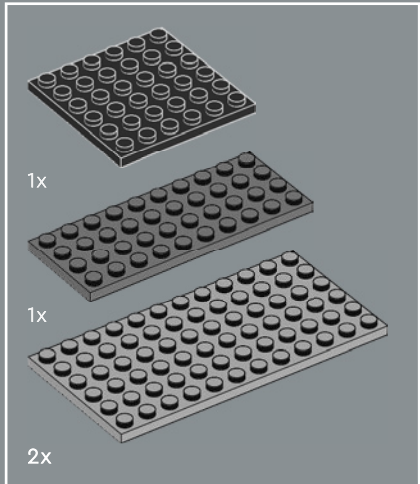
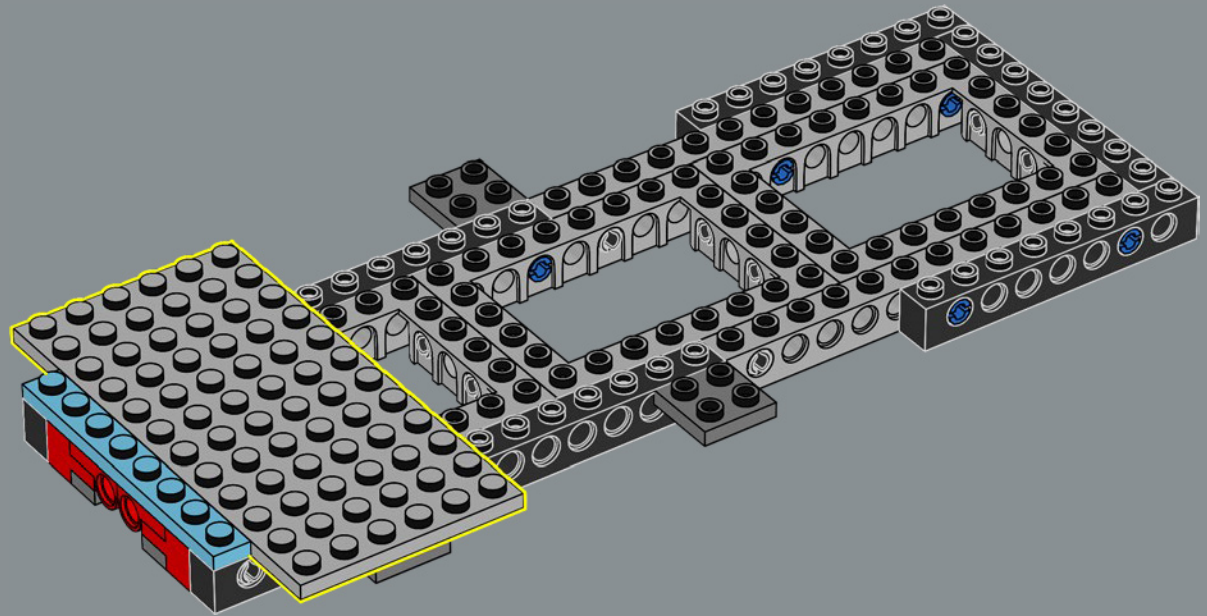

1x

1x

2x

12

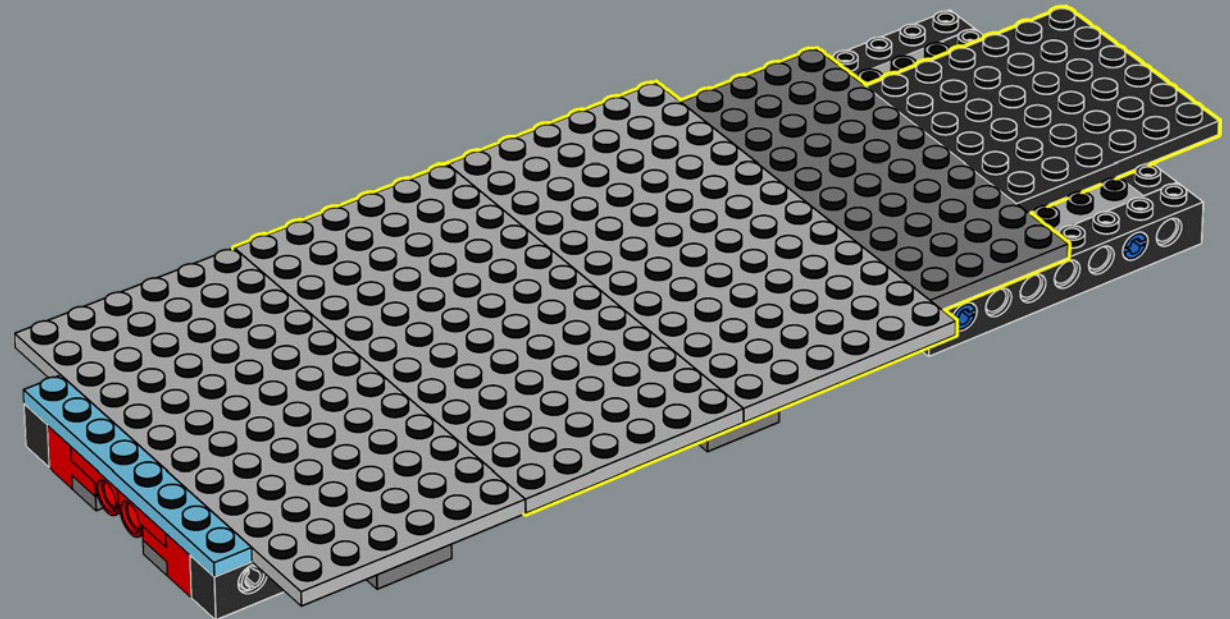



13

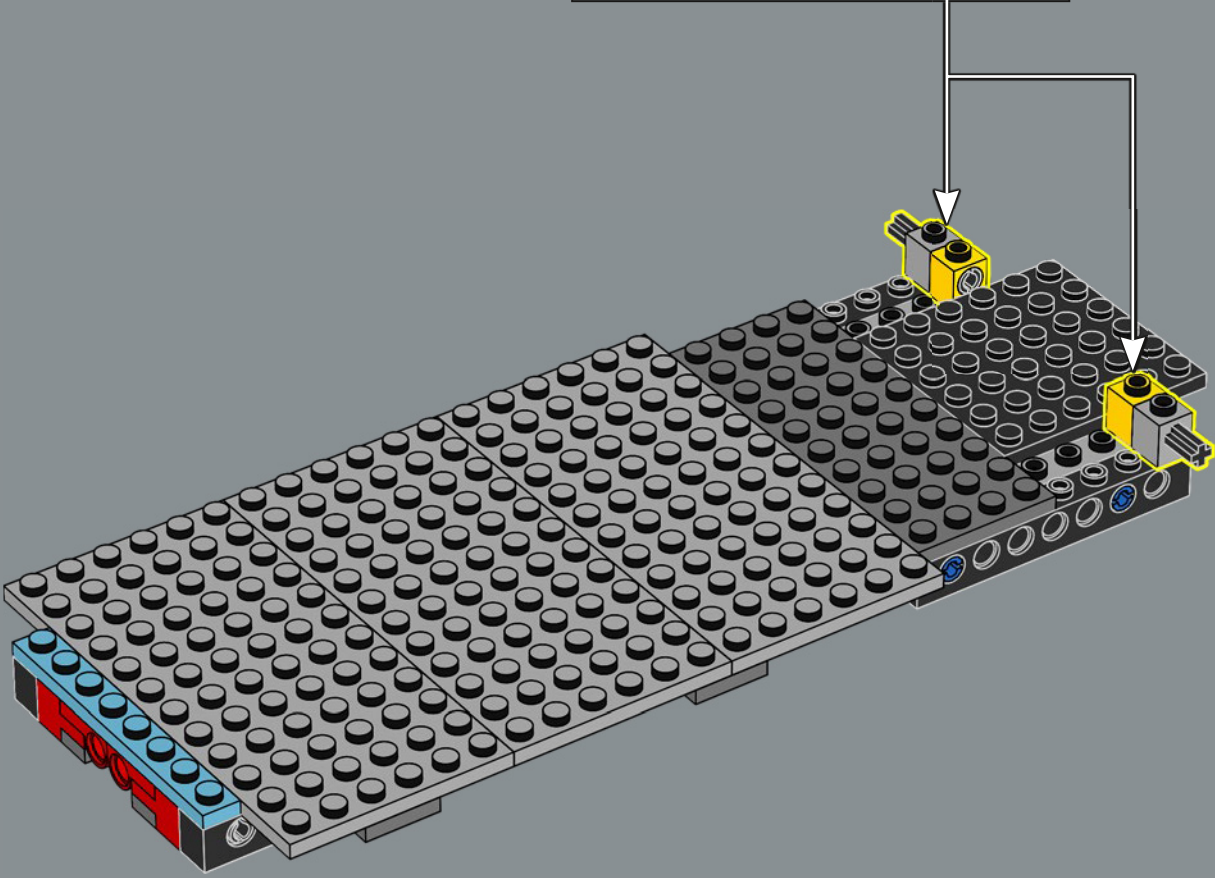
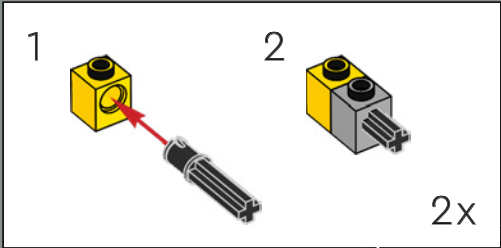

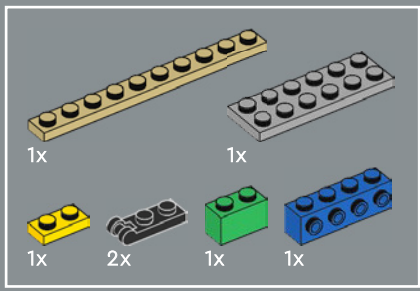

14

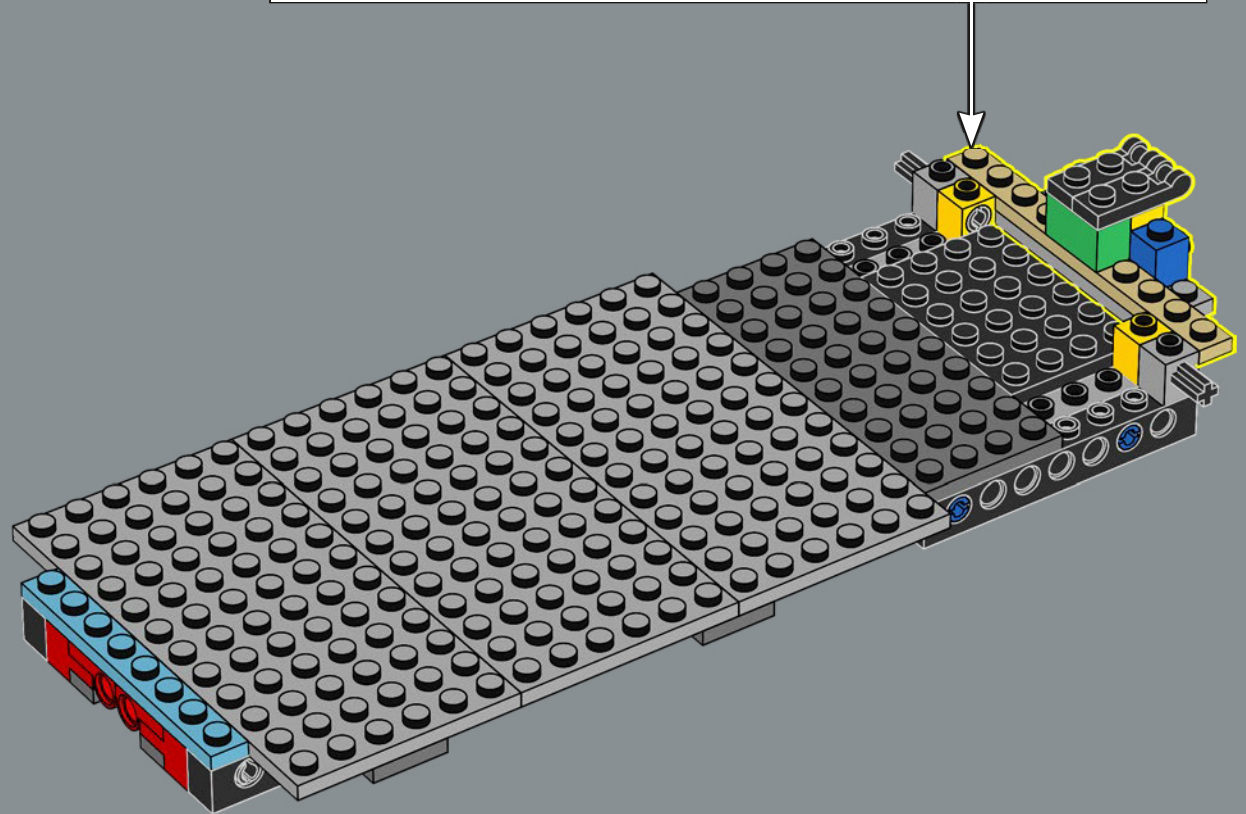
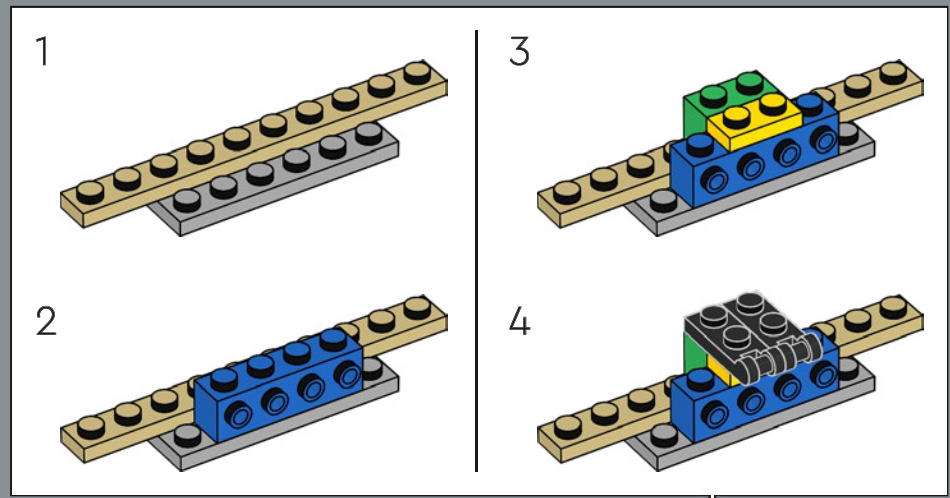

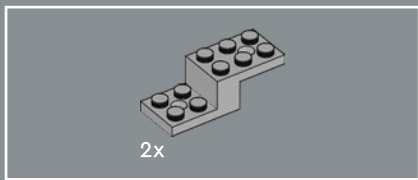

15

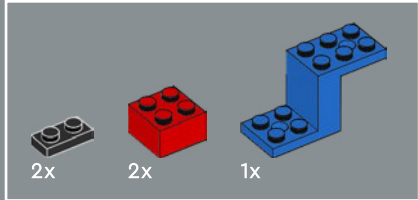
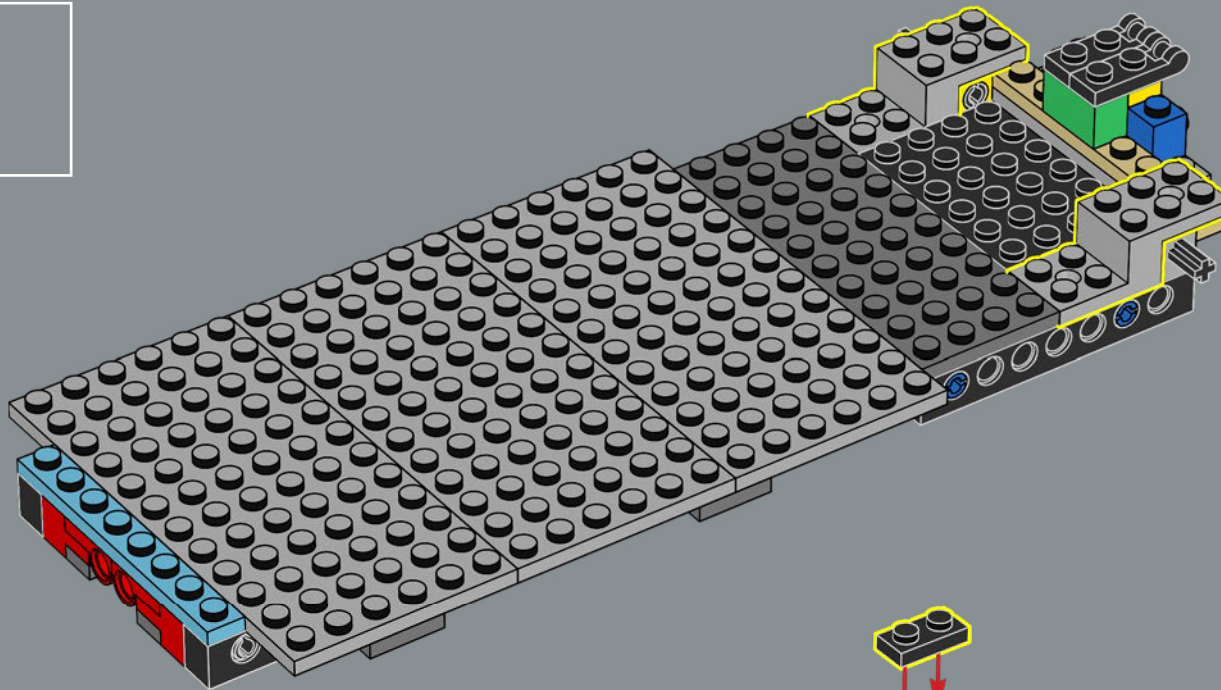

16

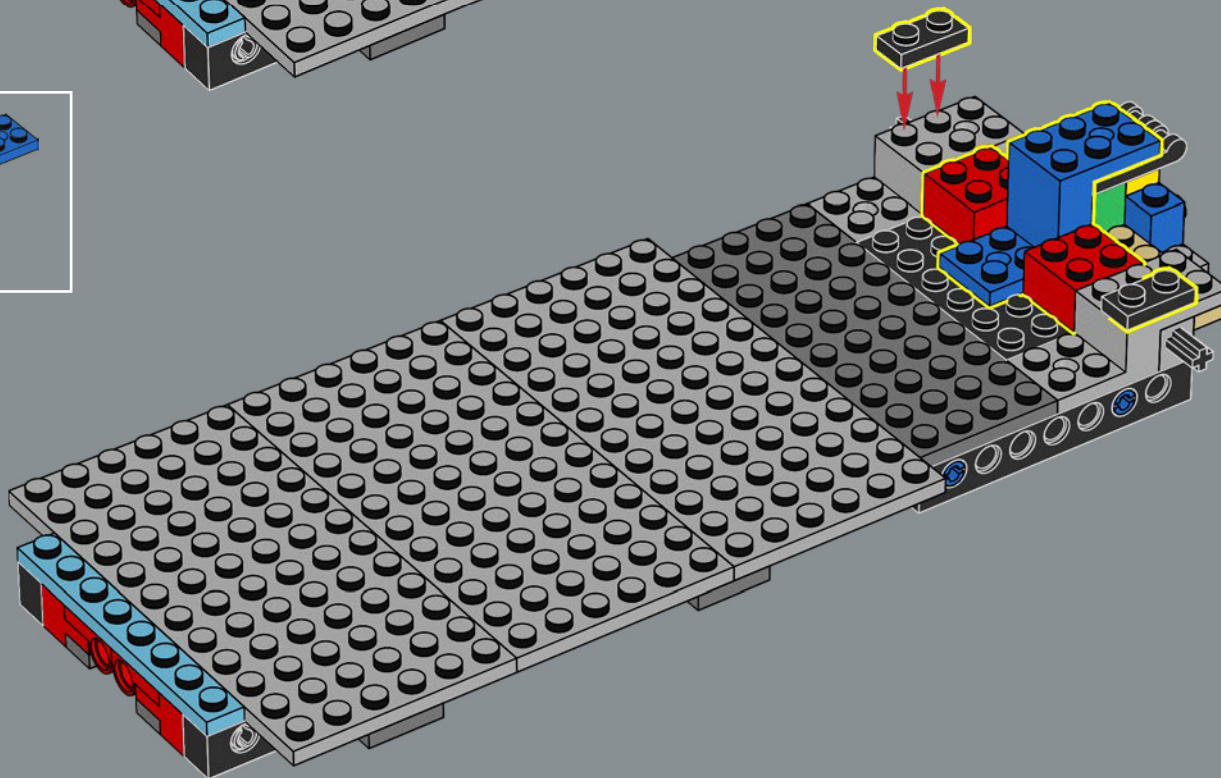

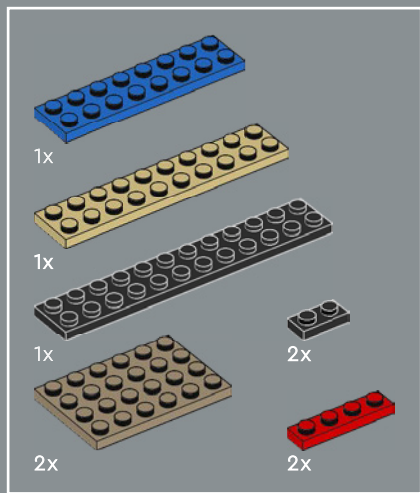

17

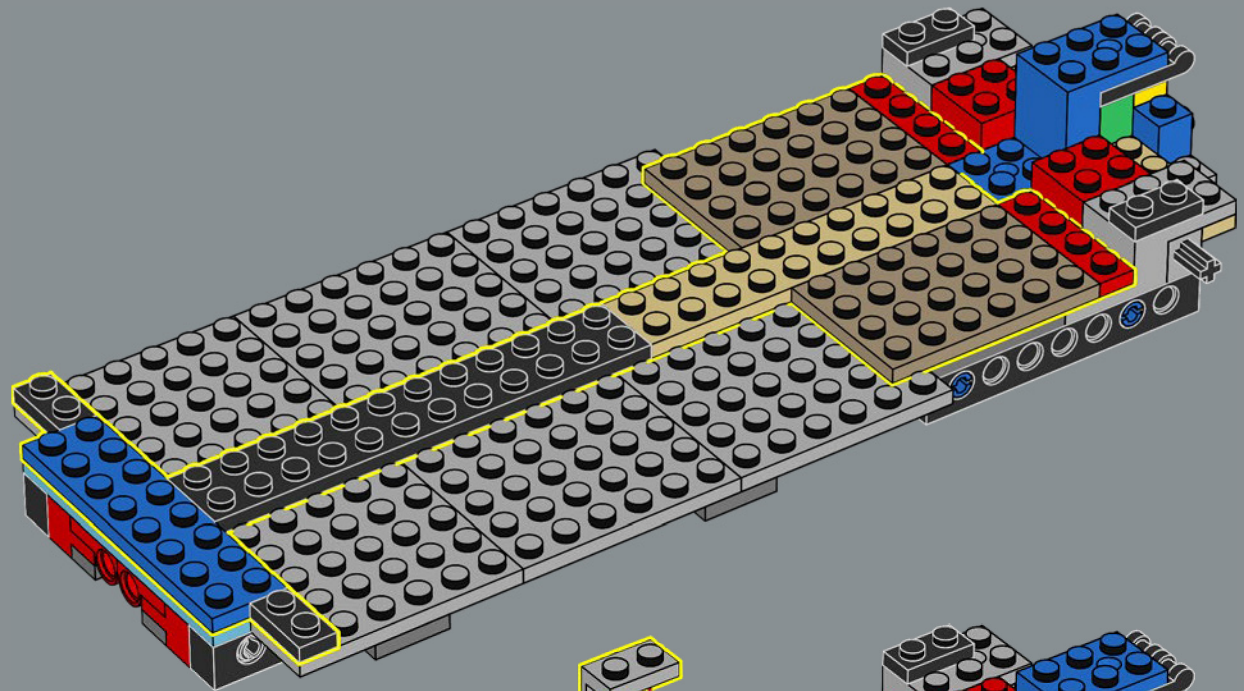

18

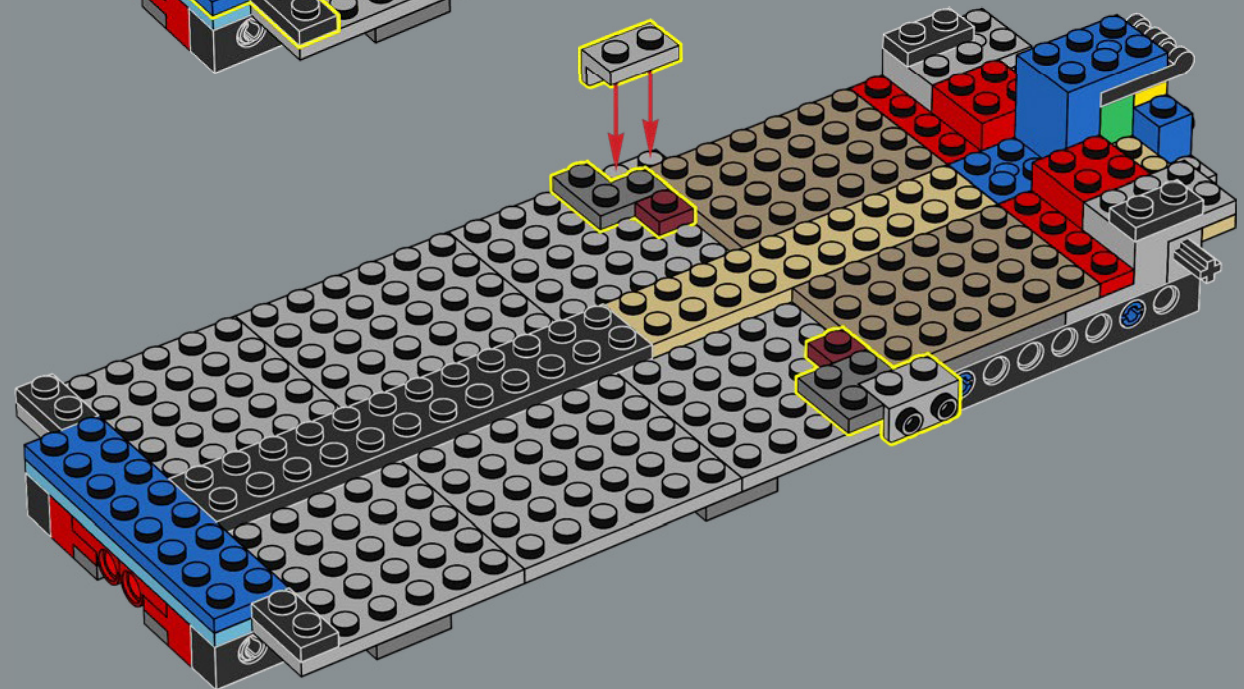

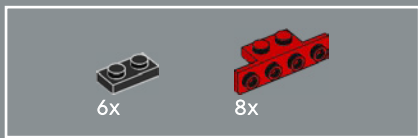

19

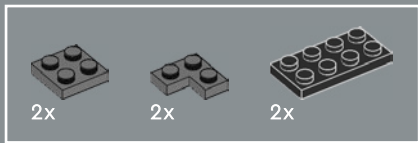
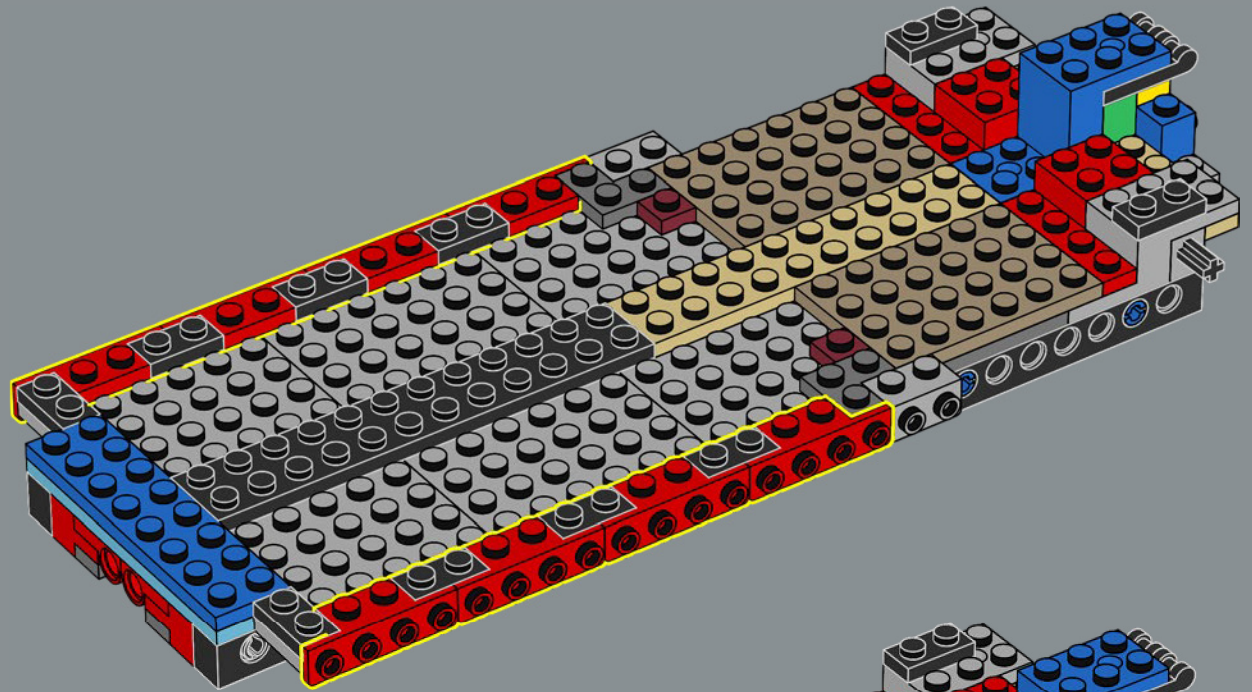

20

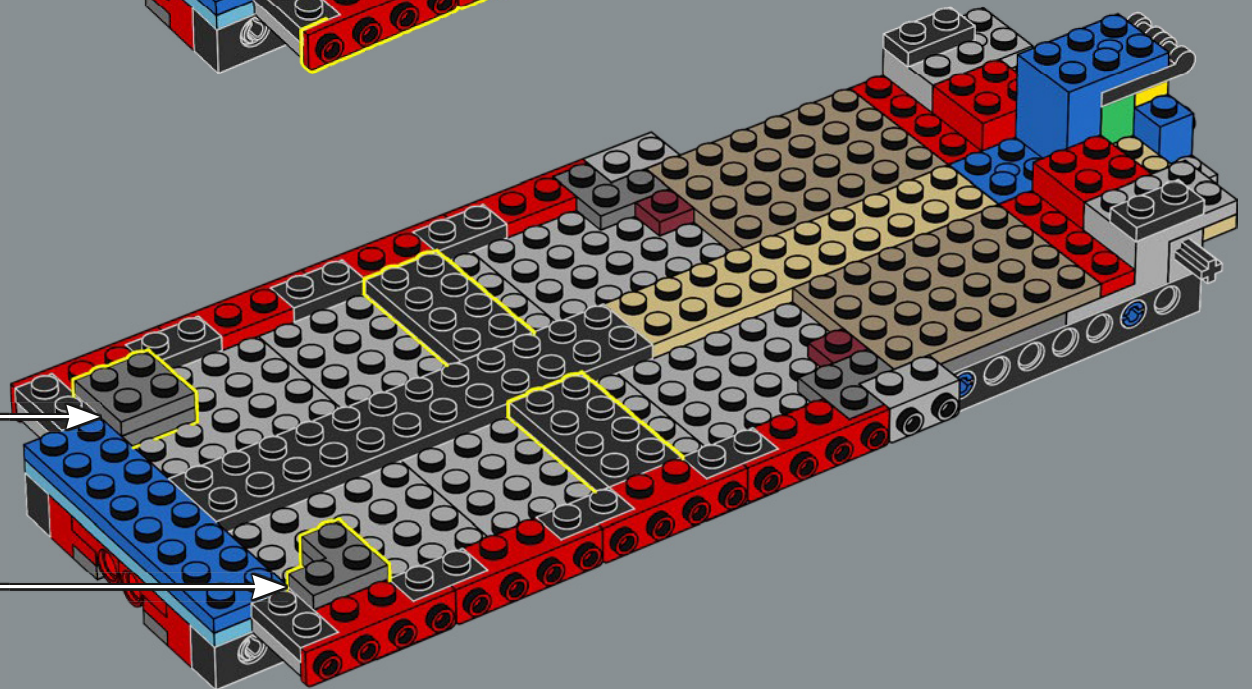
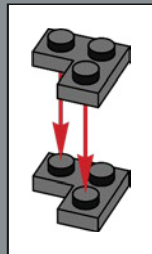
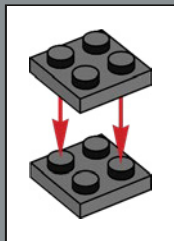

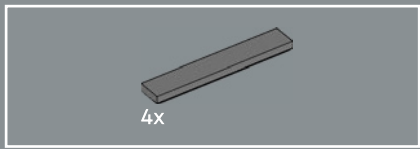

21

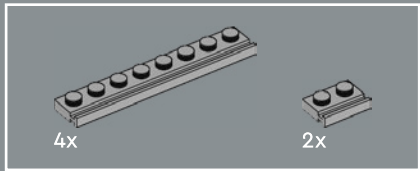
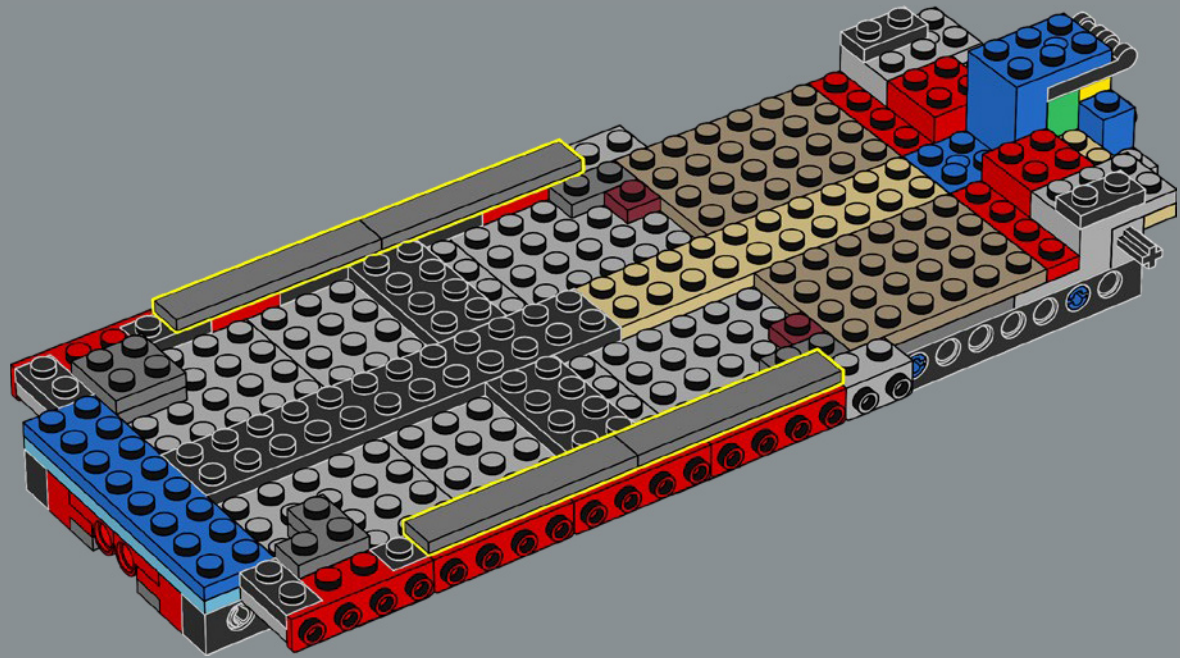

22

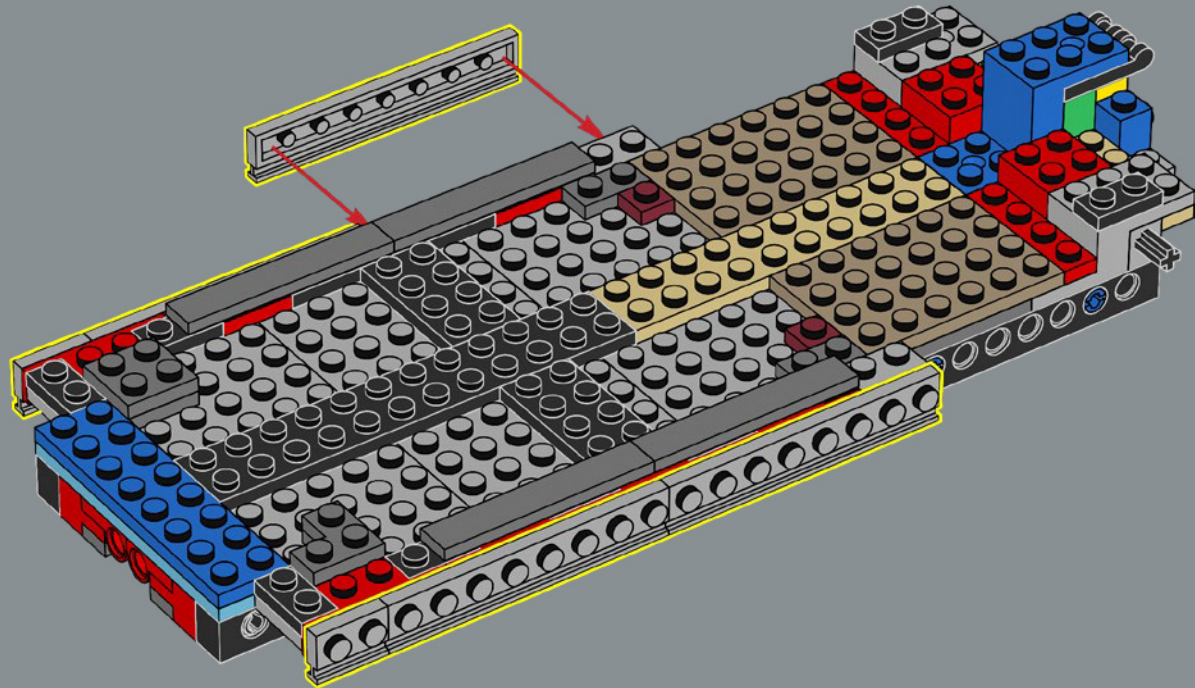





23

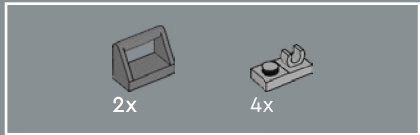
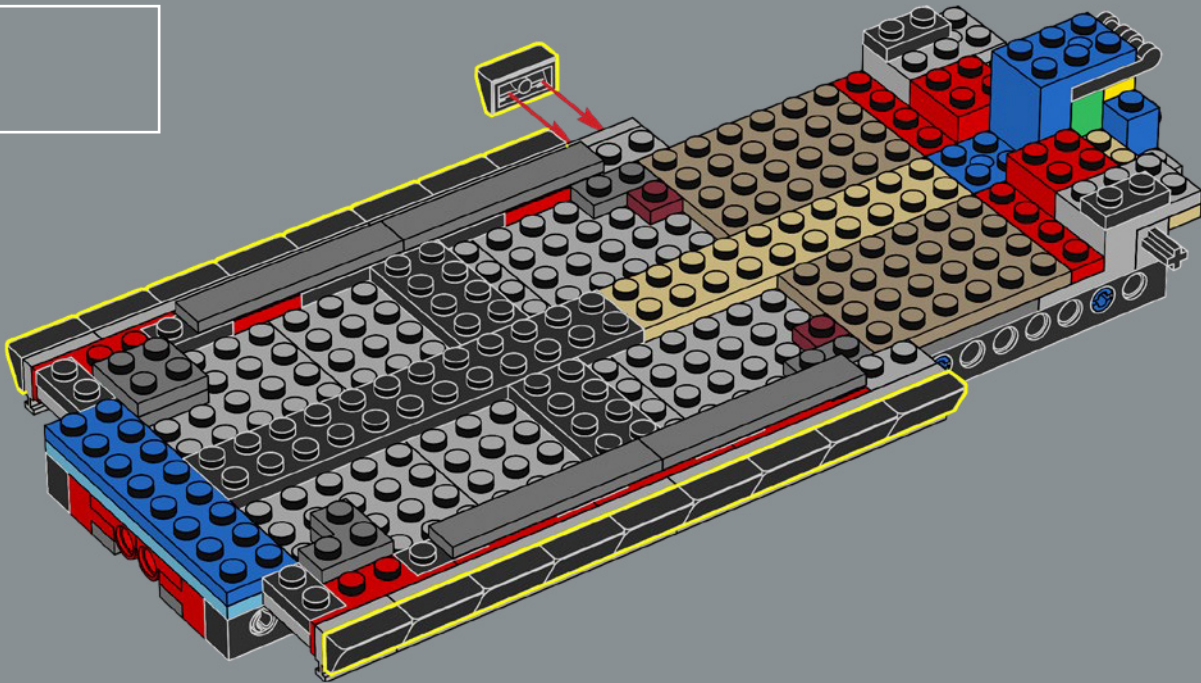

24

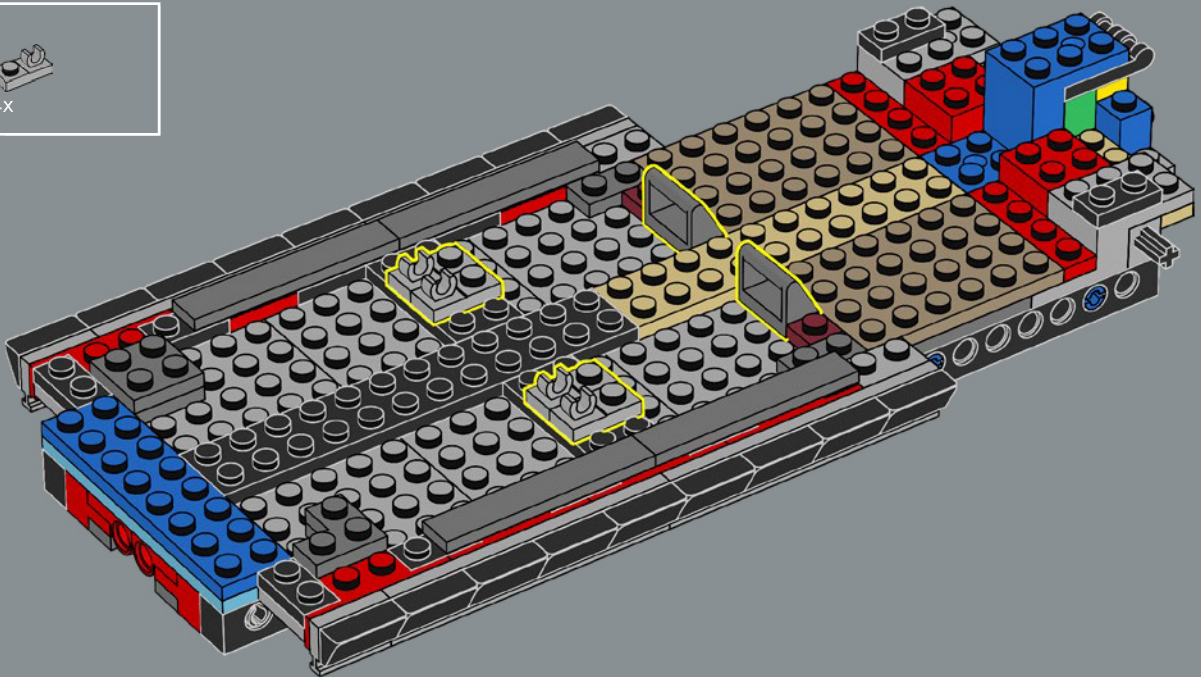



4x

25

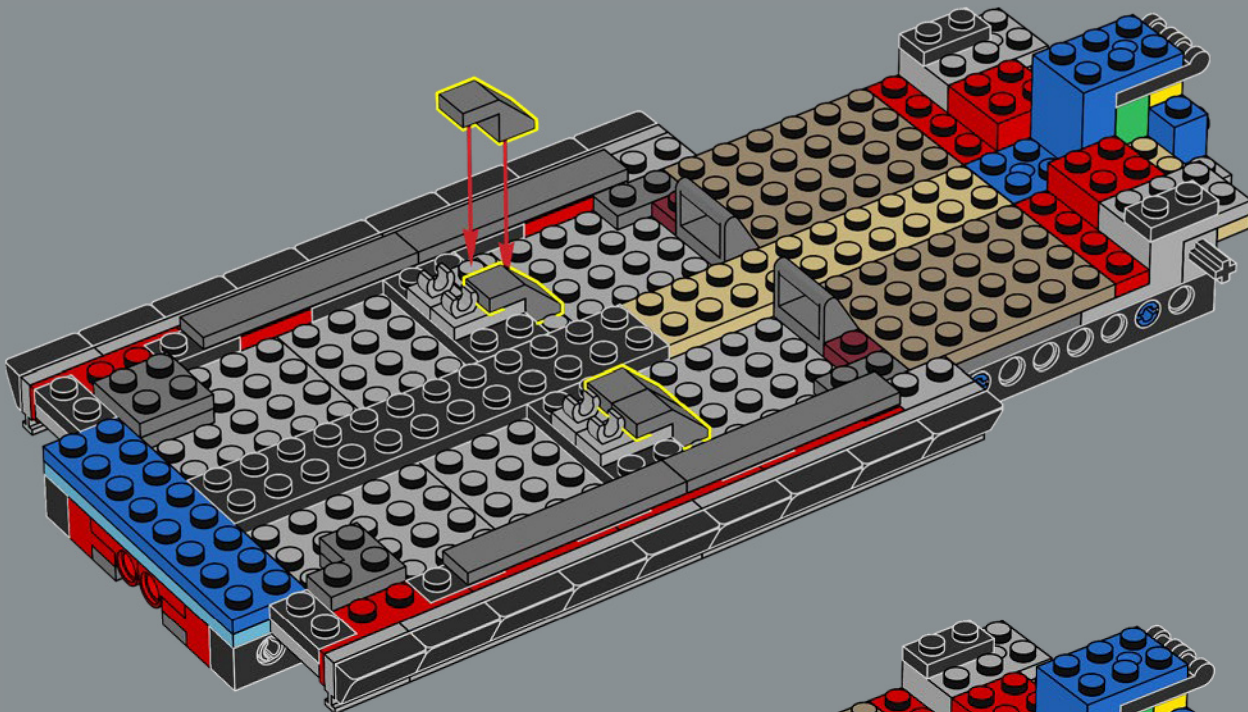

1x



1x



1x

26

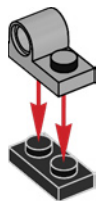
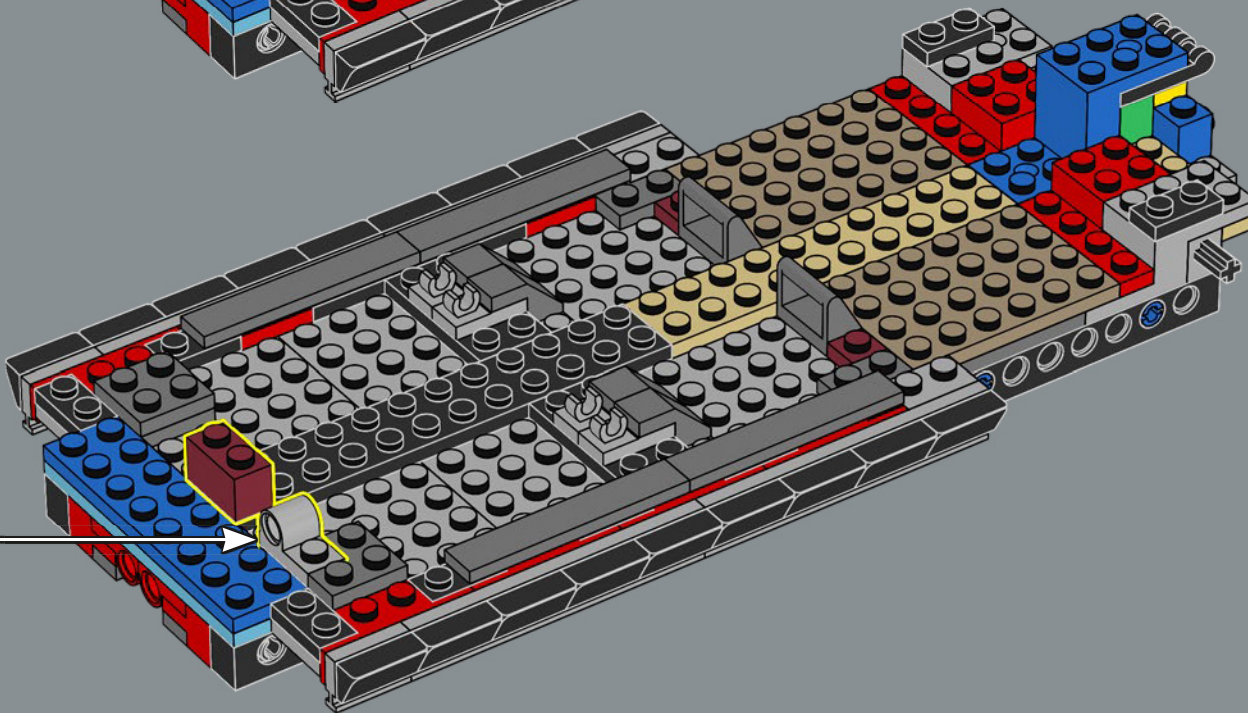

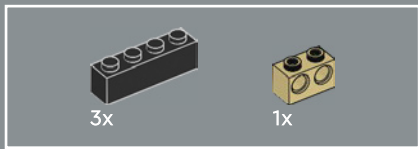

27

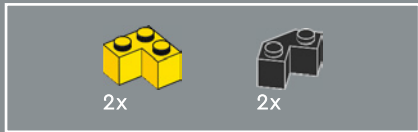
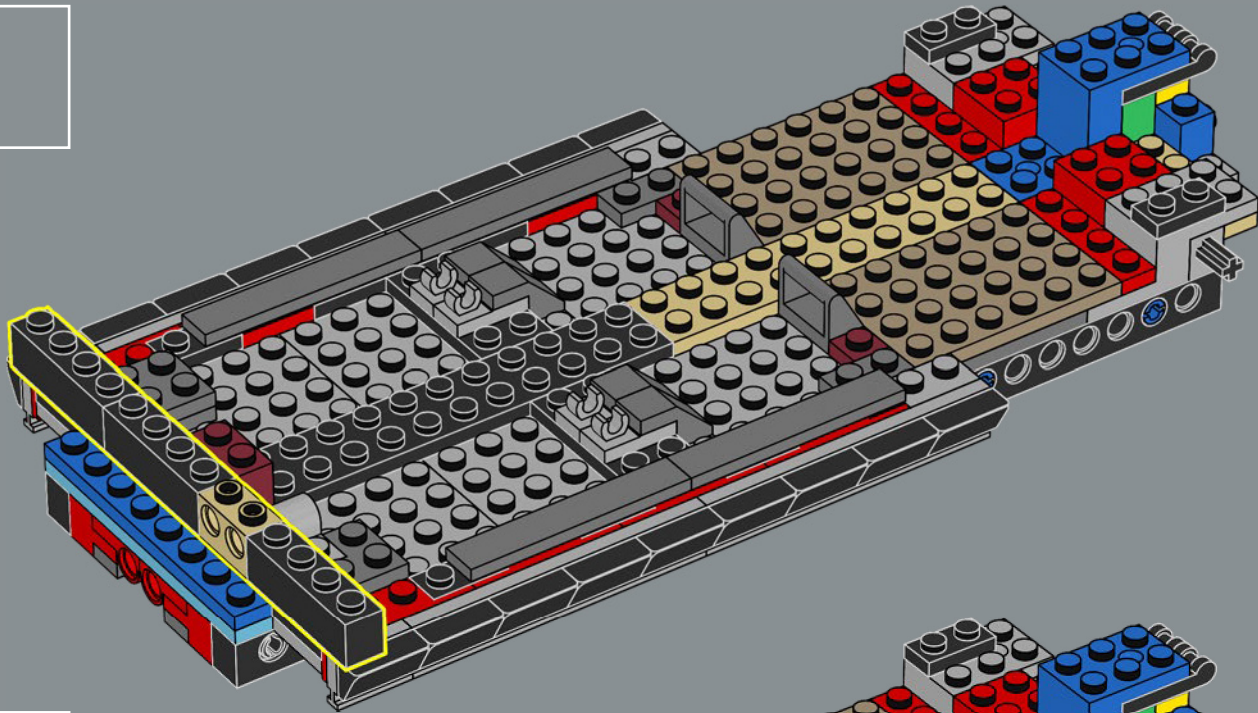

28

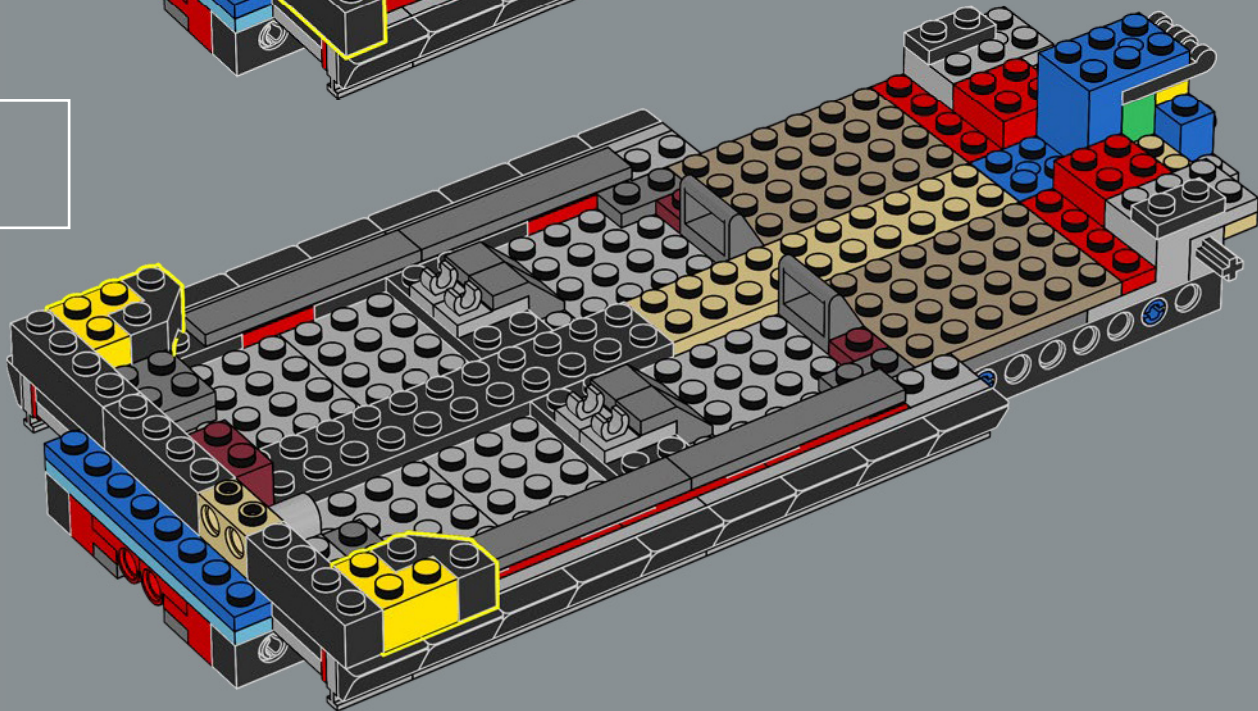



29

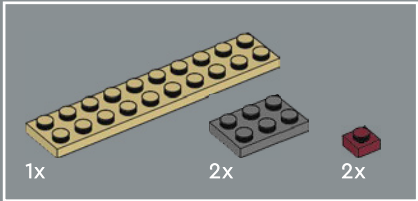
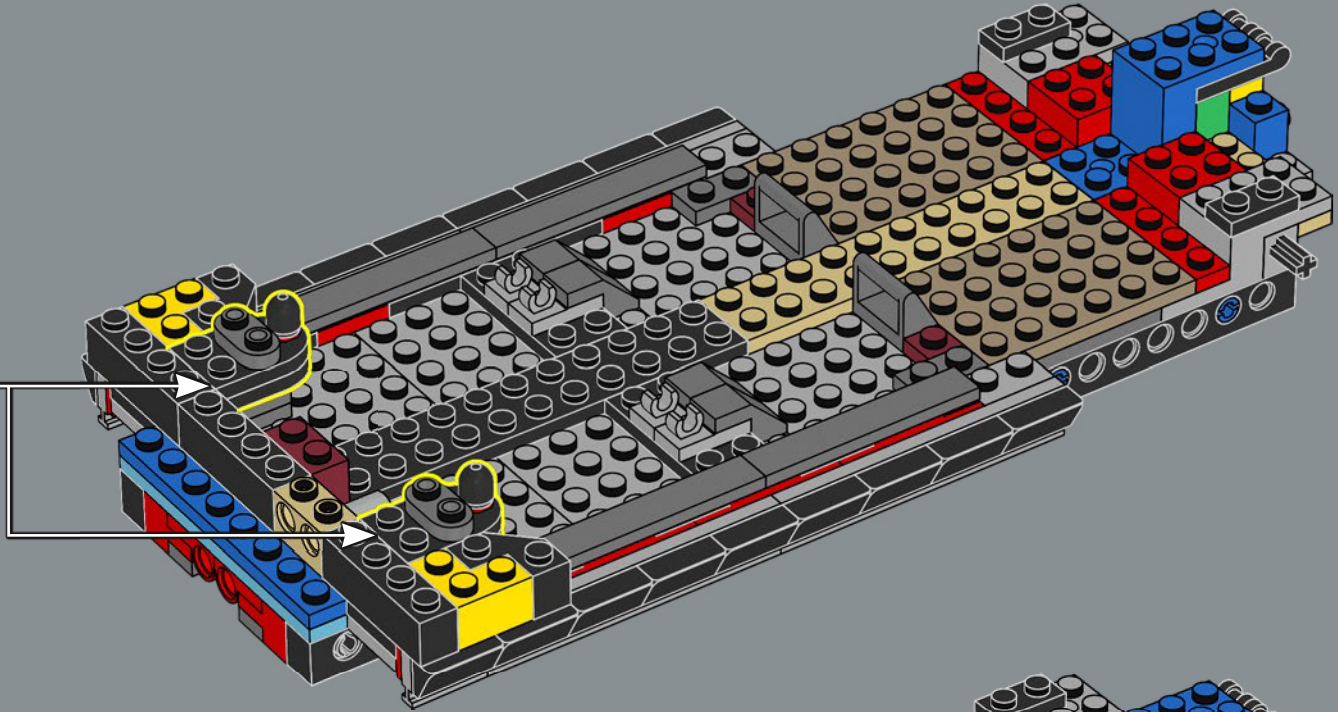
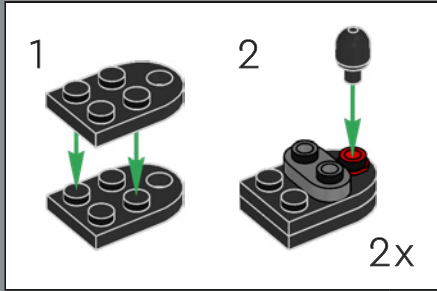

30

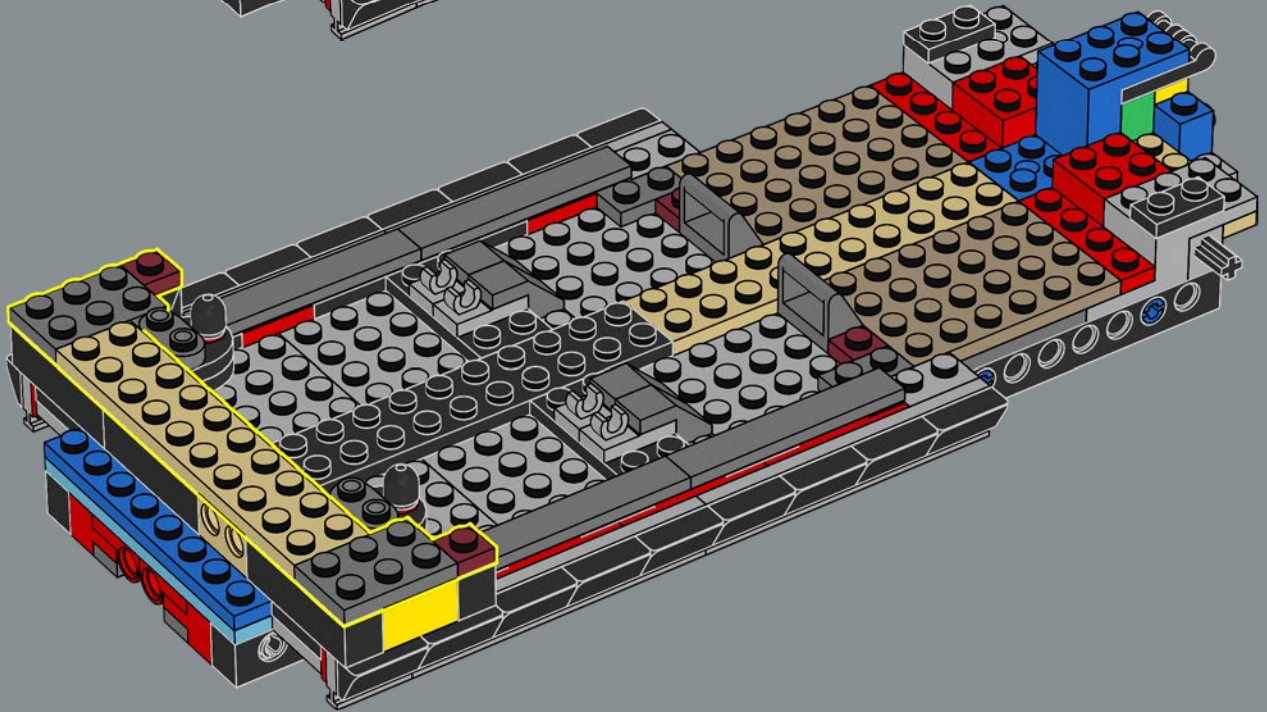

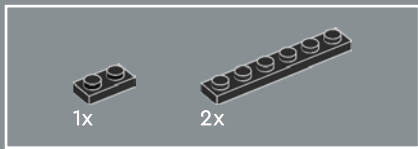

31

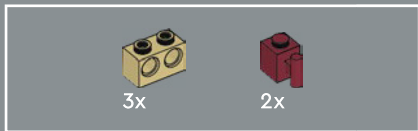
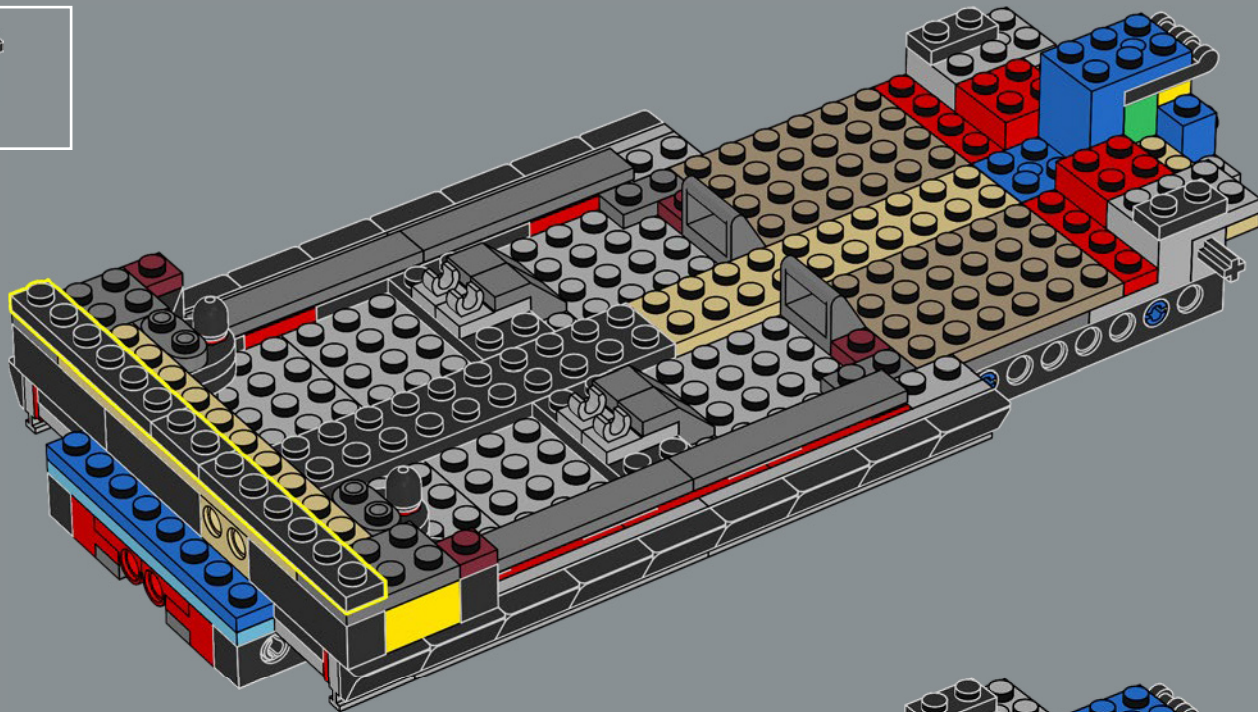

32

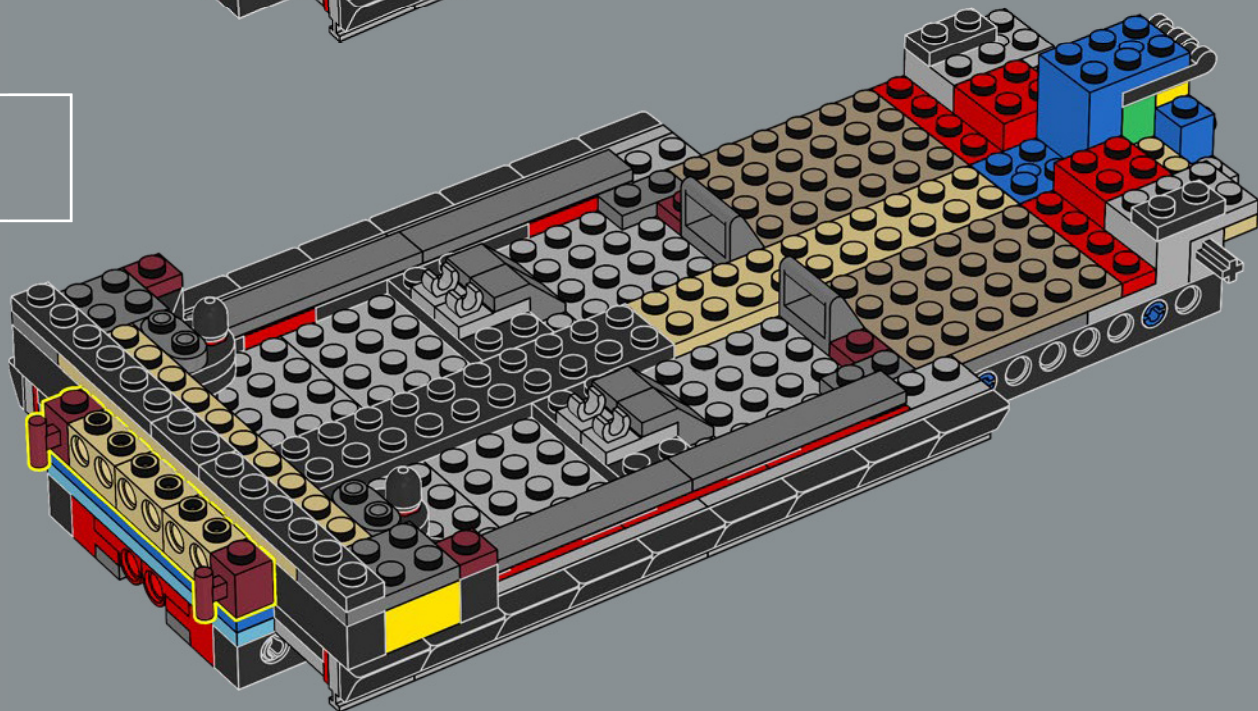

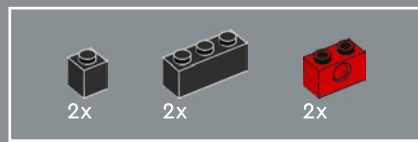

33

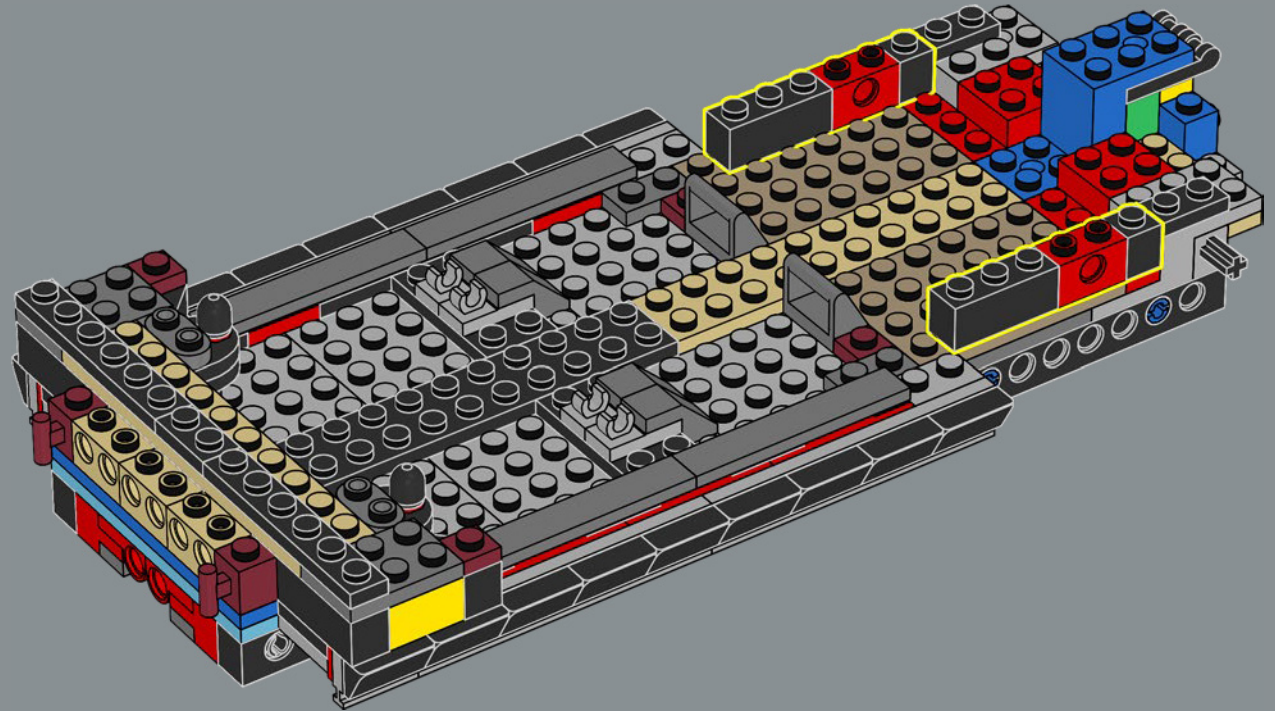

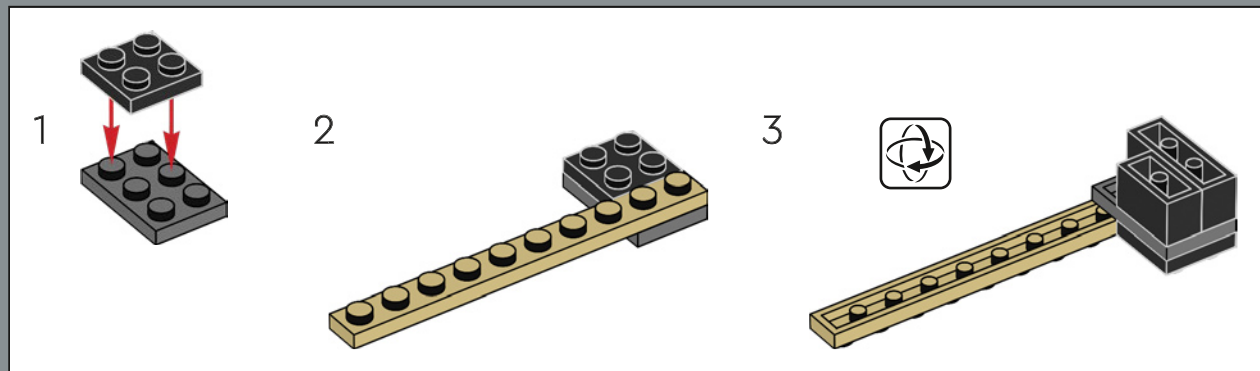
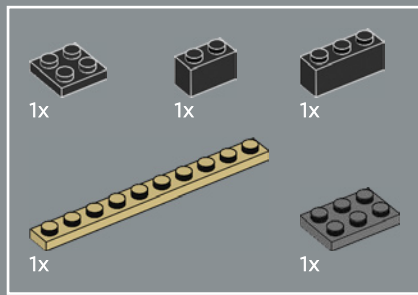

34

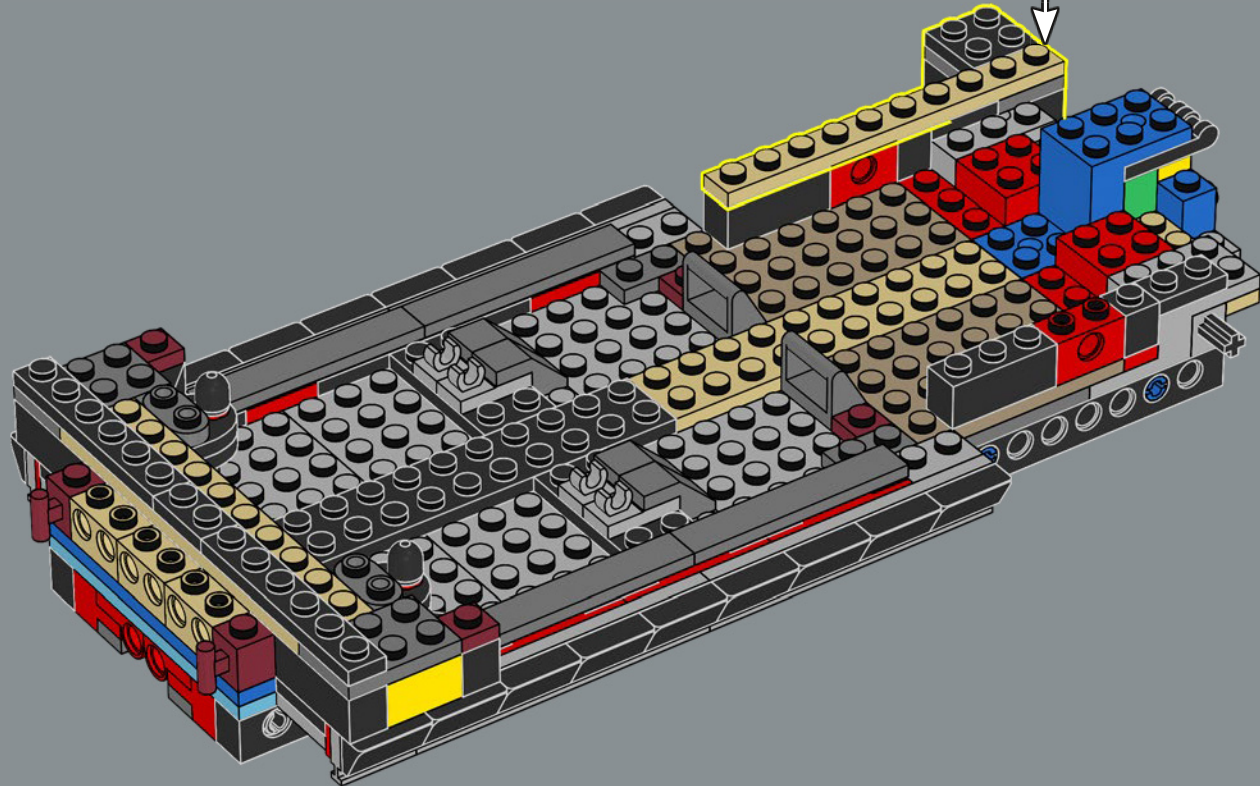

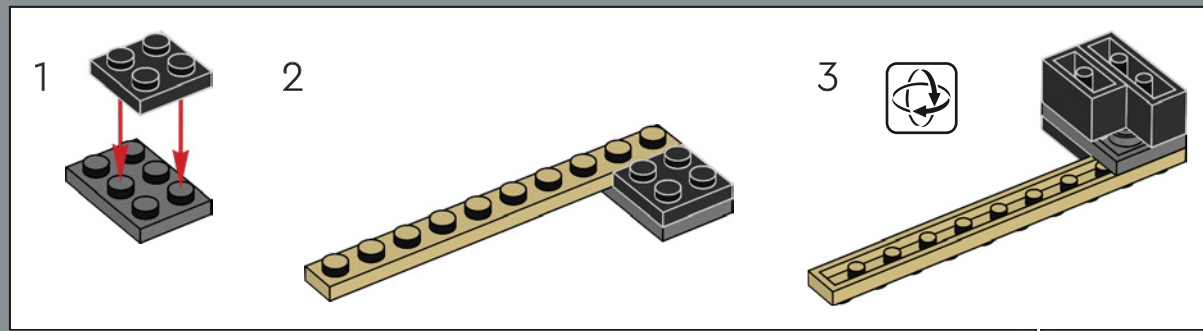
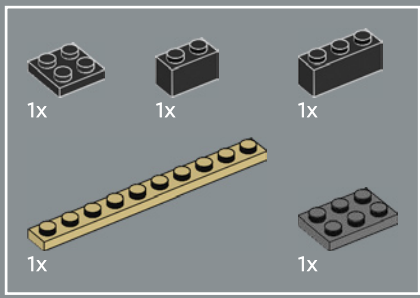

35

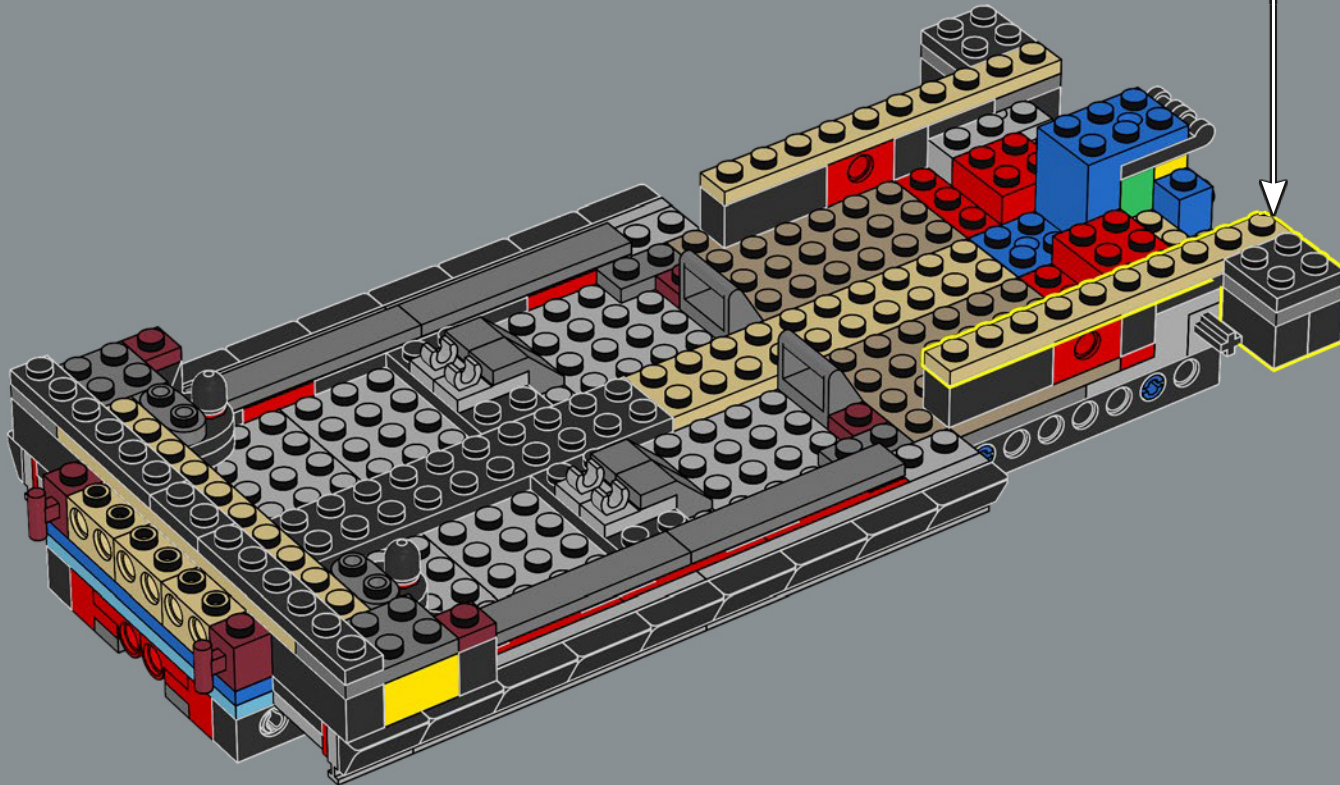



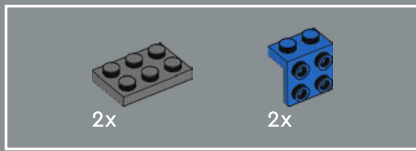

36

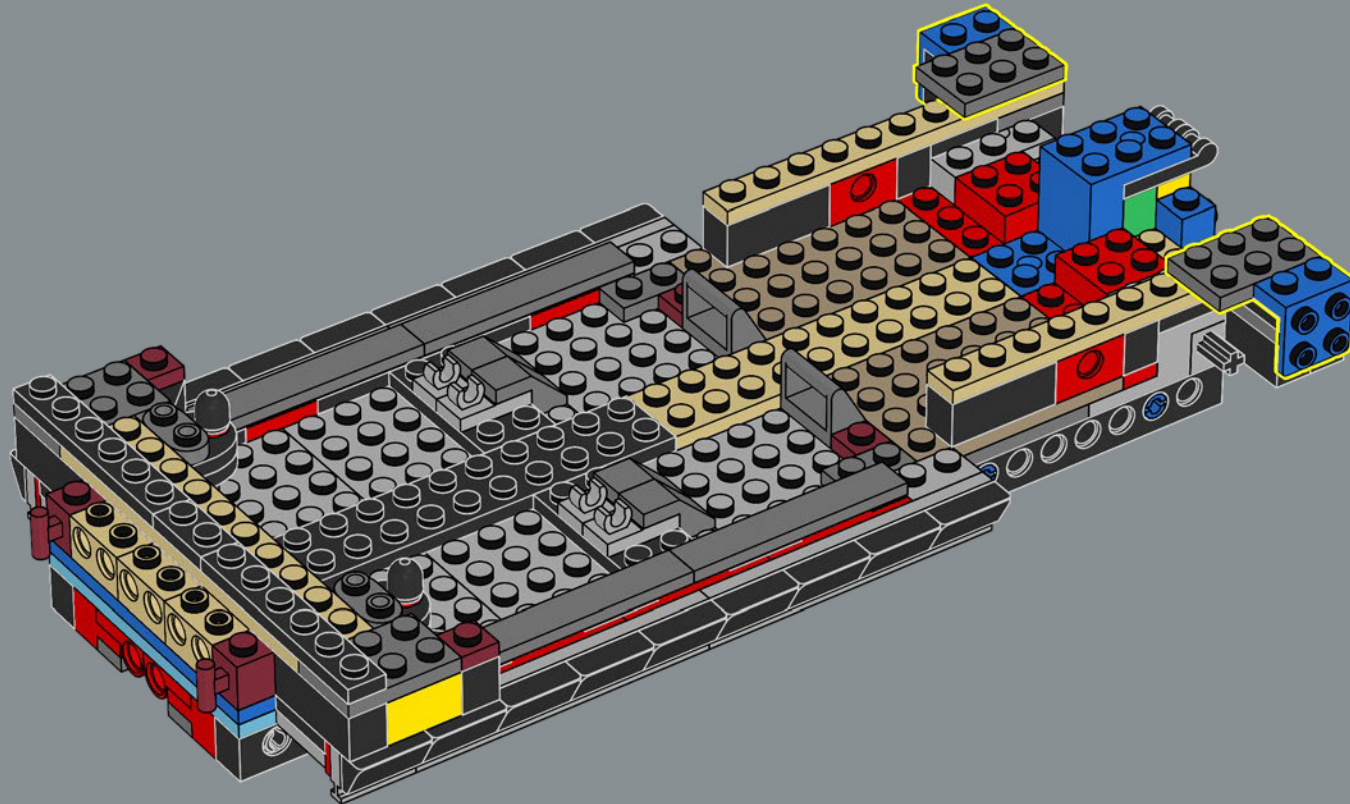

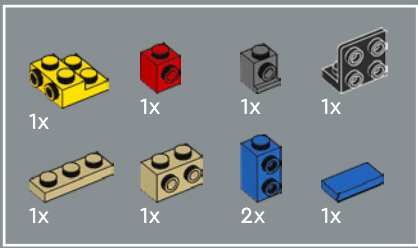

37

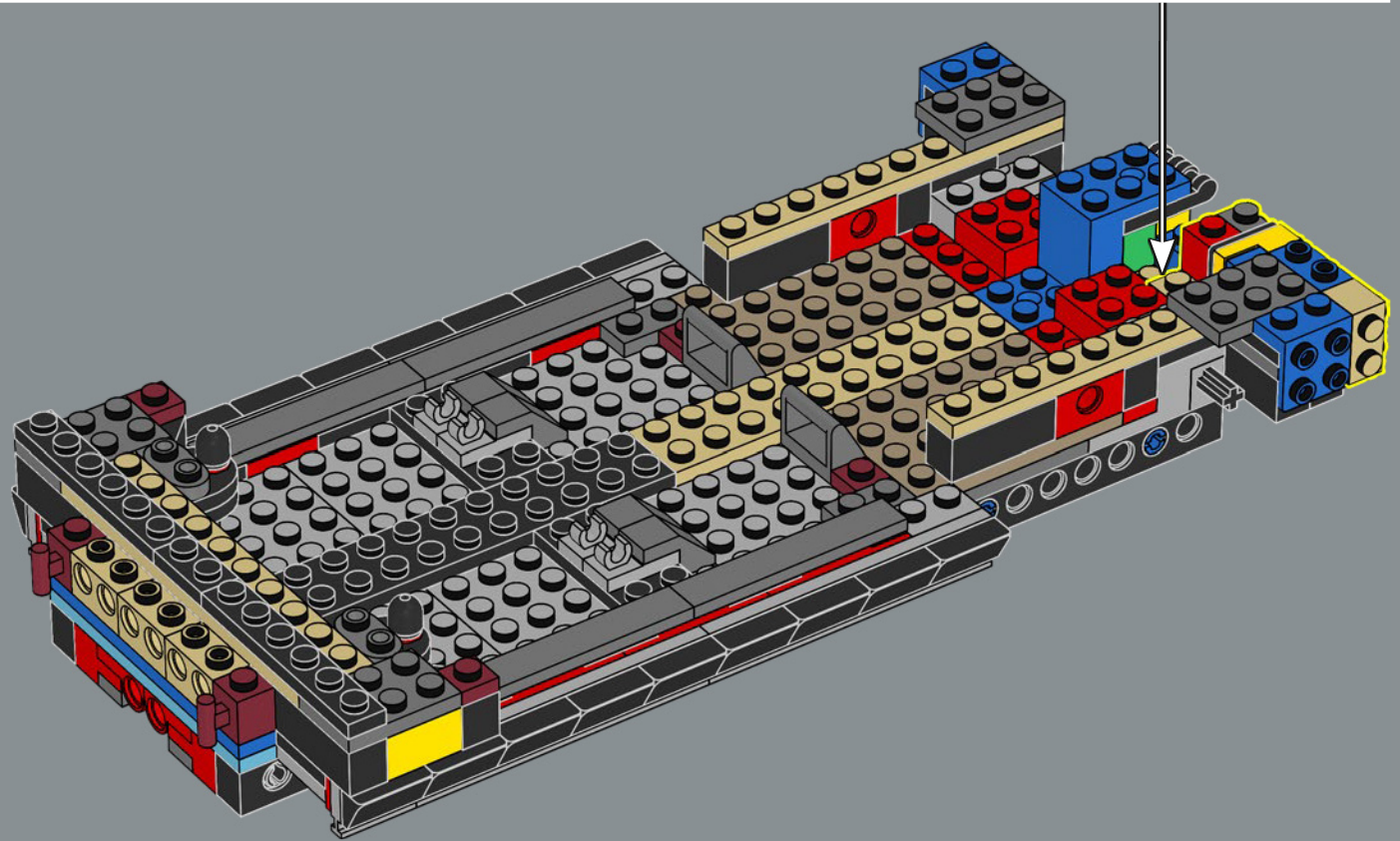
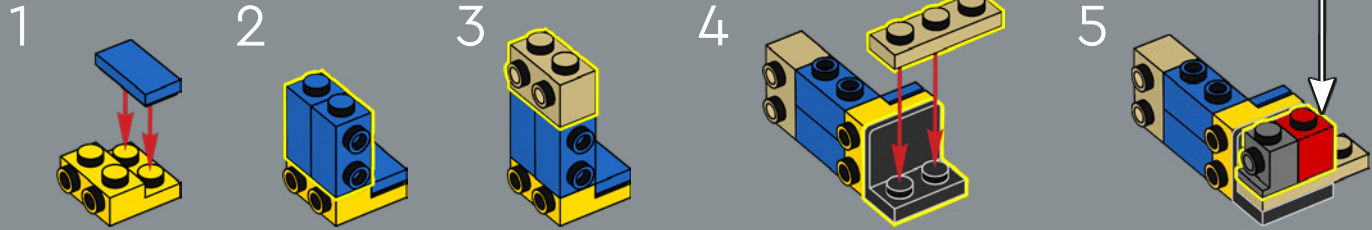

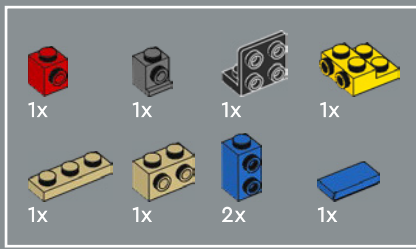

38

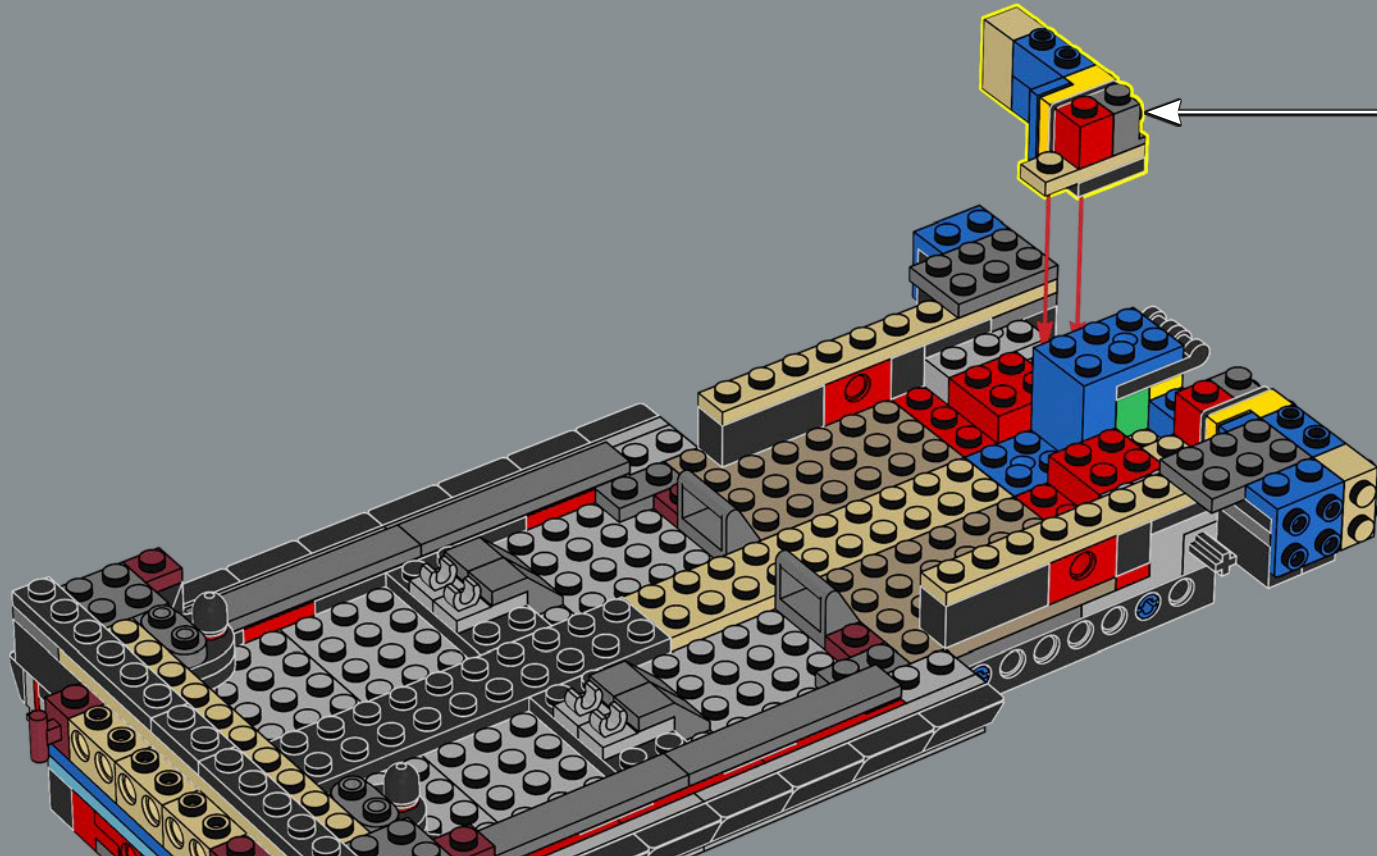
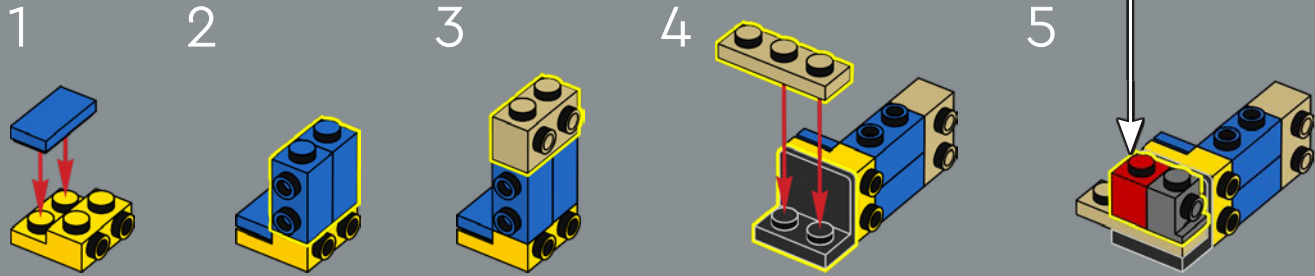

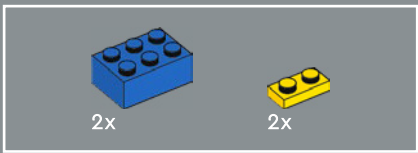

39

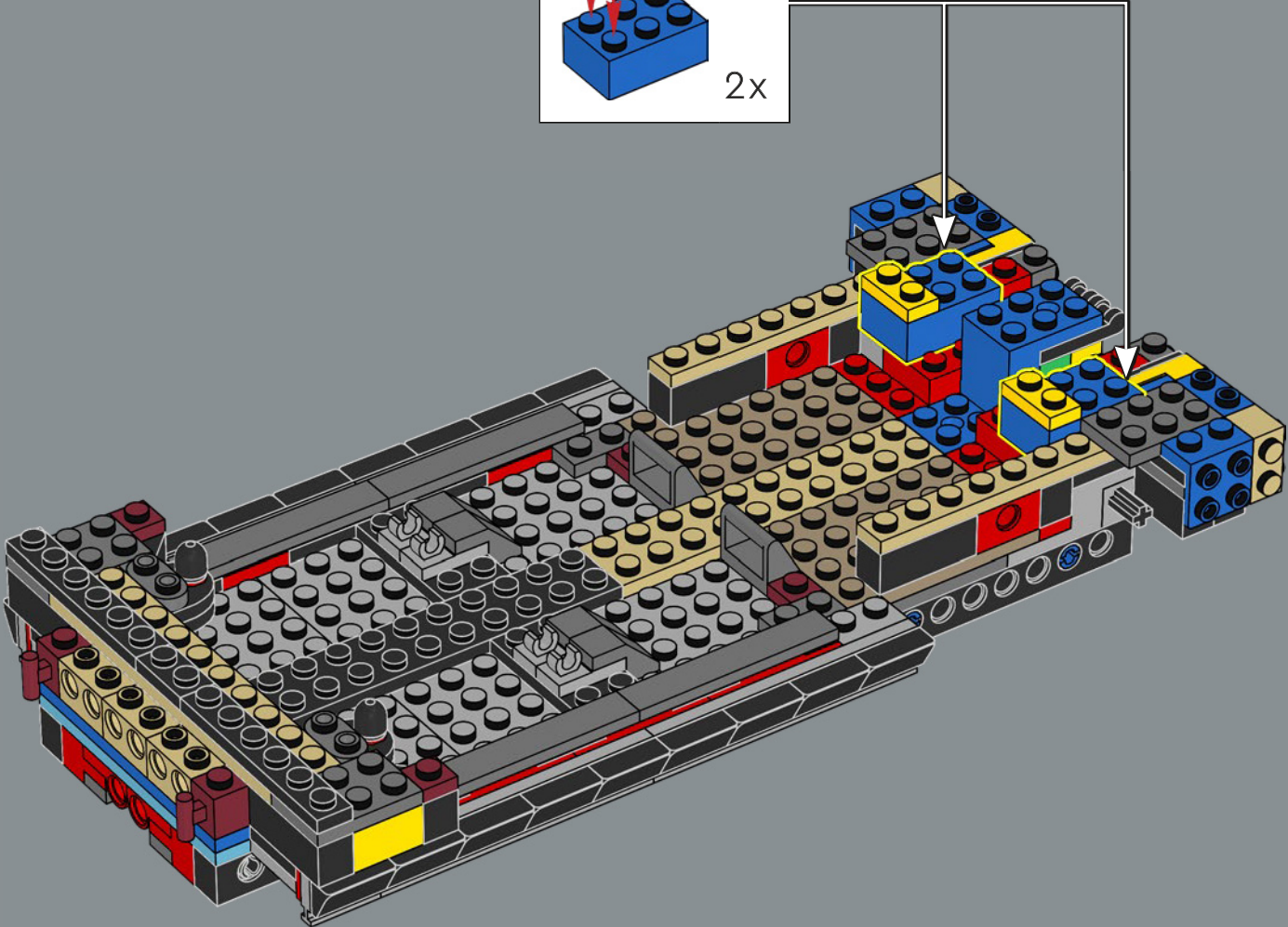
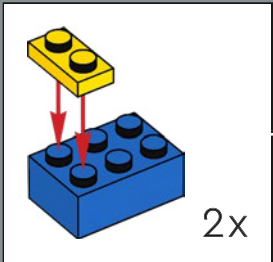

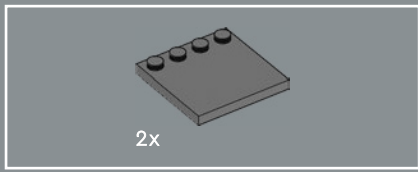

40

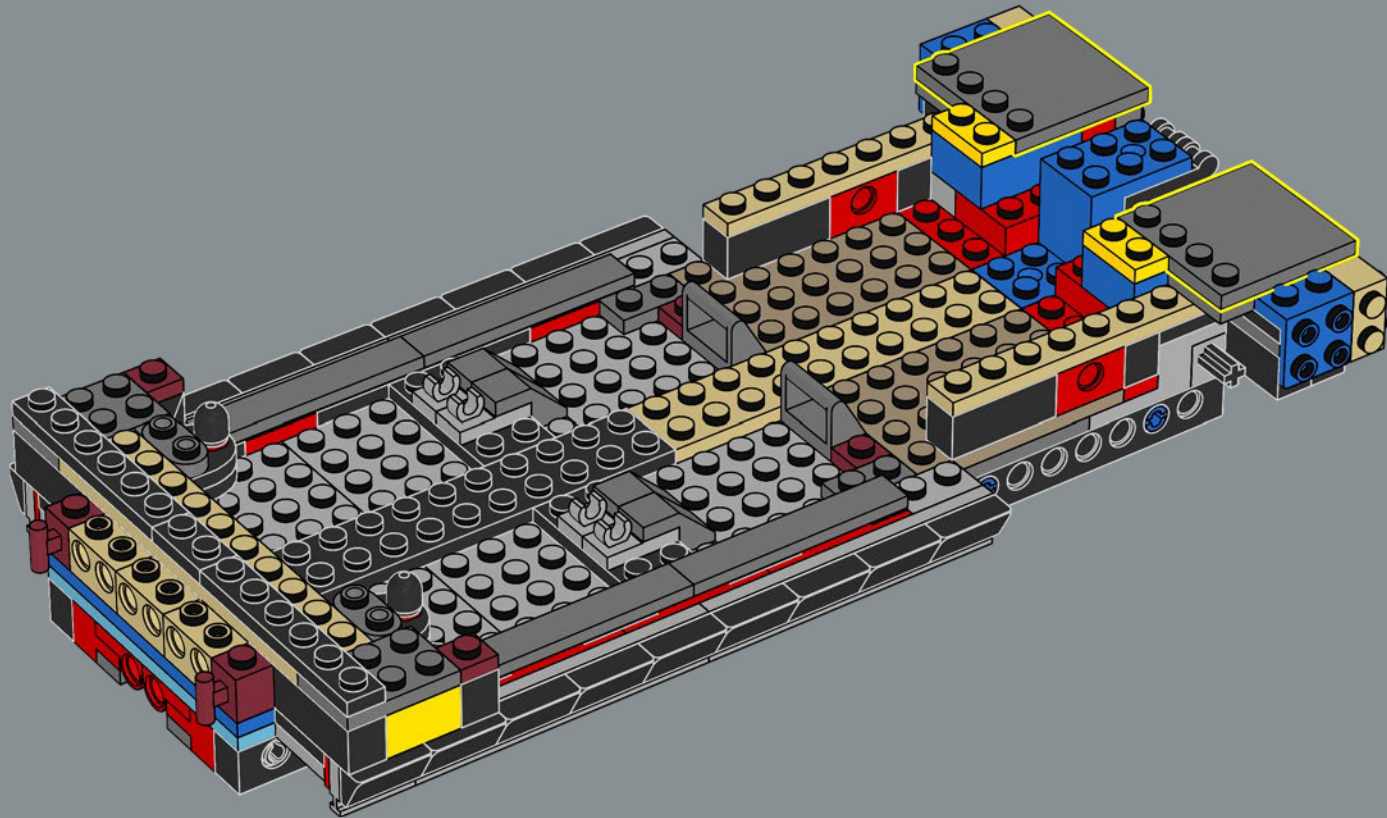



41

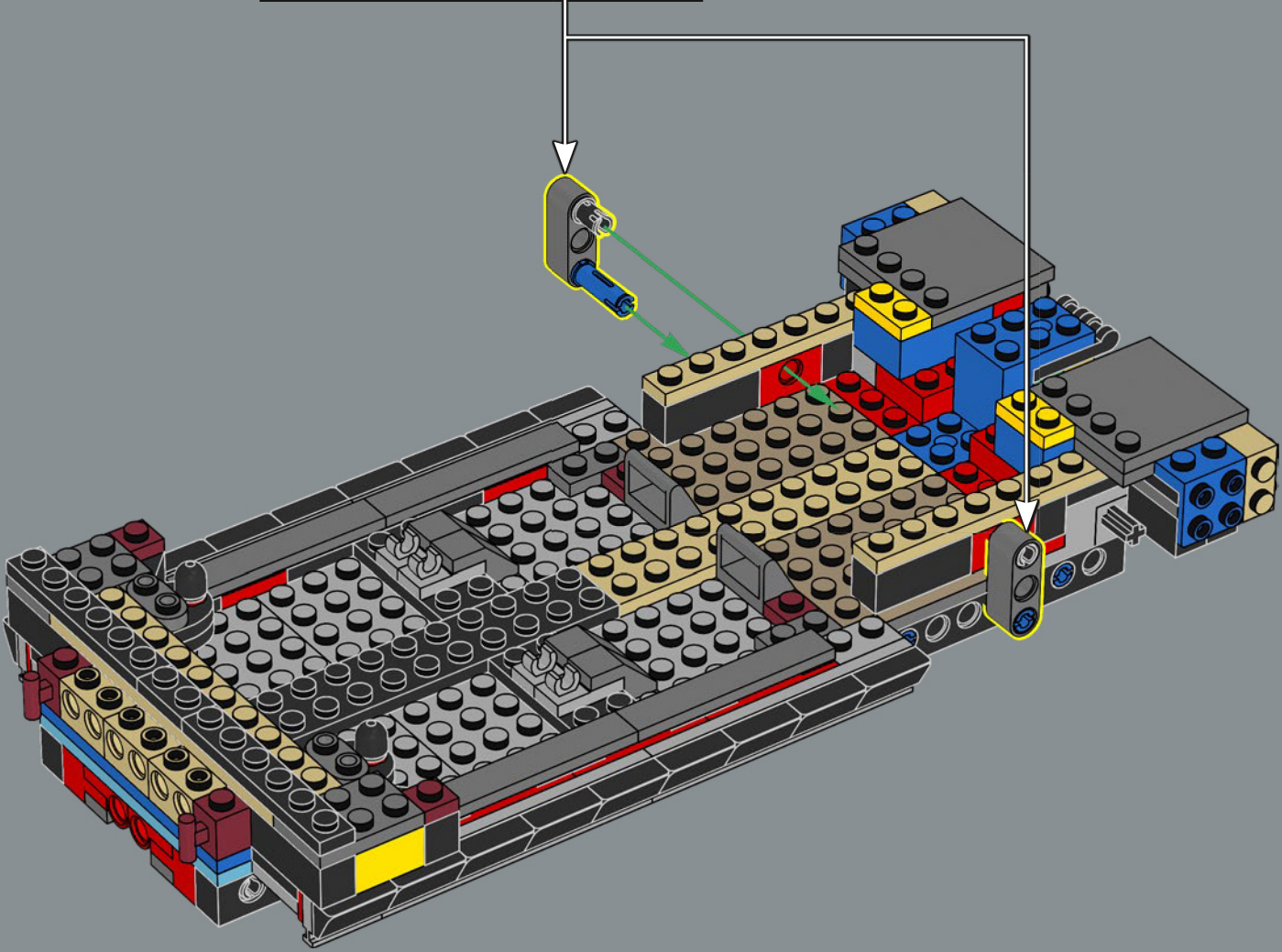
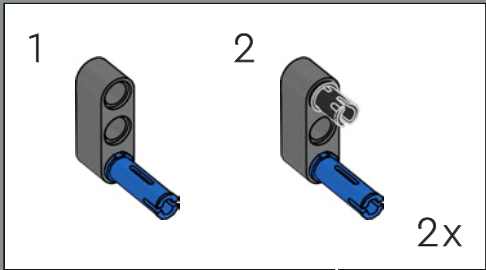

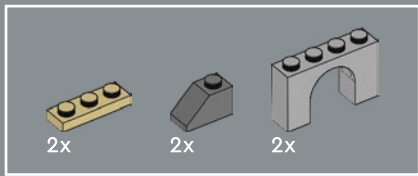

42

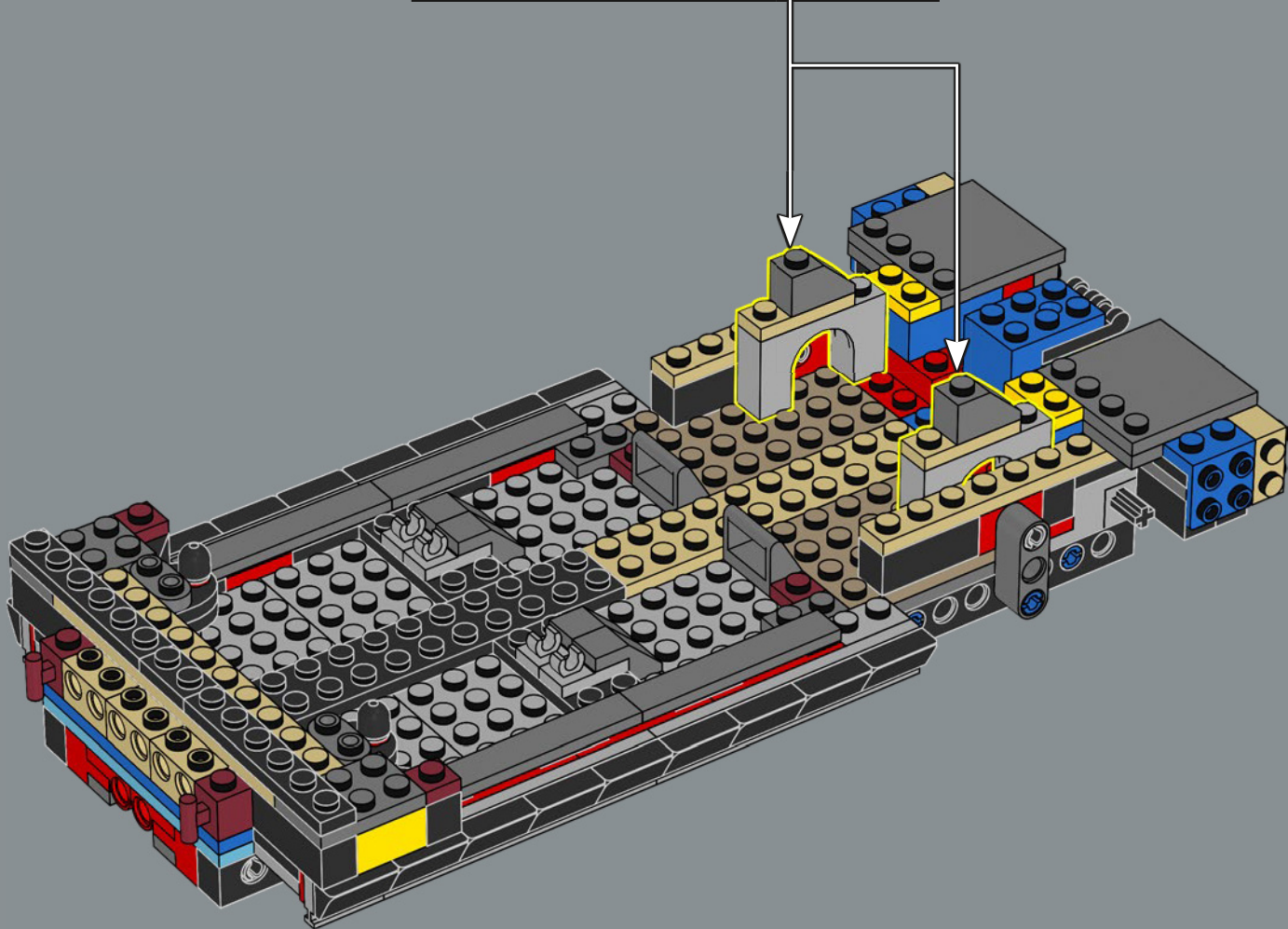
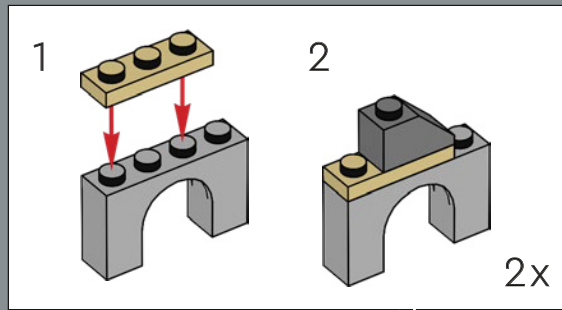

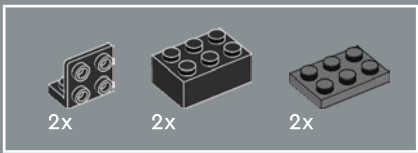

43

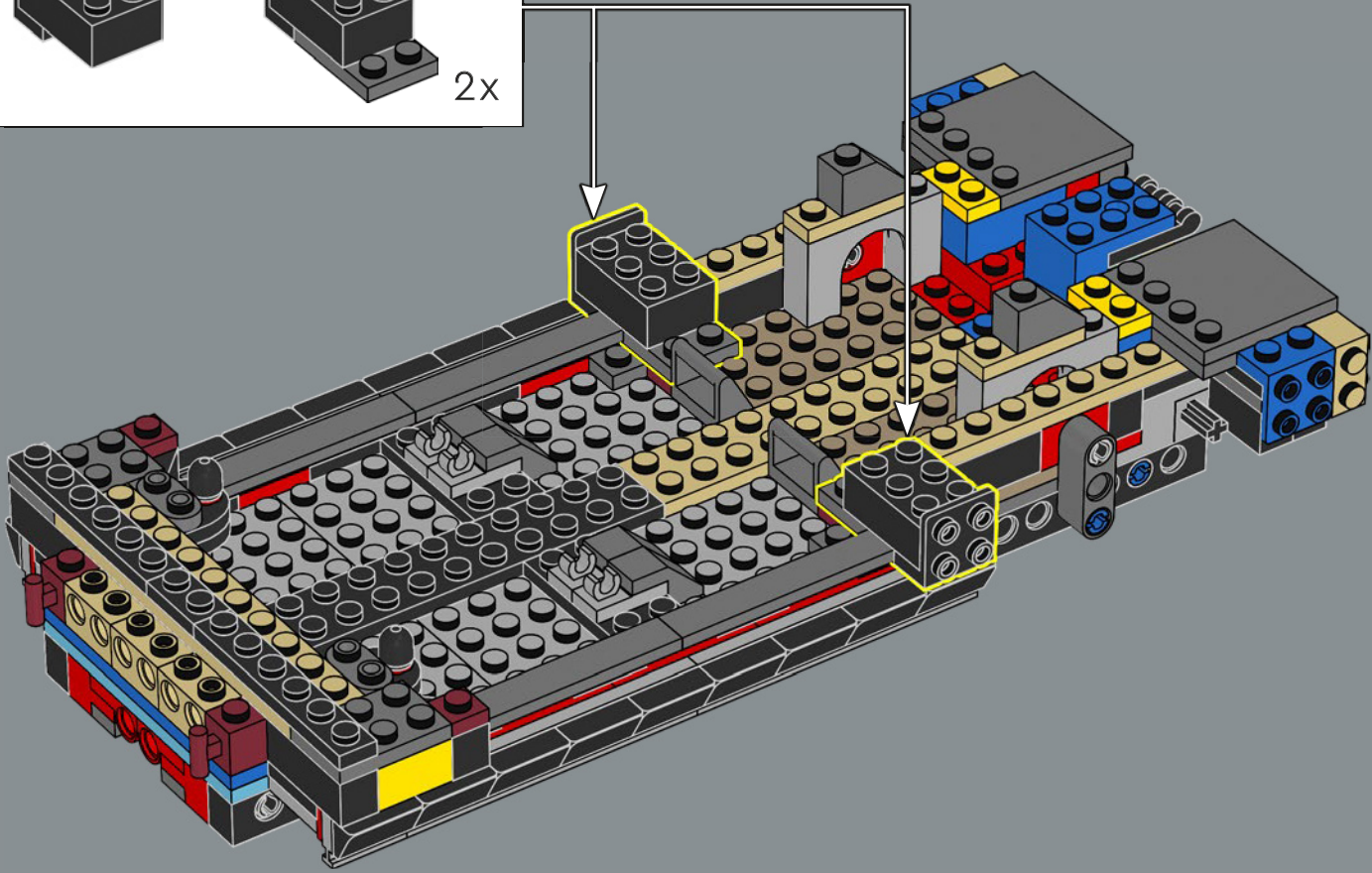
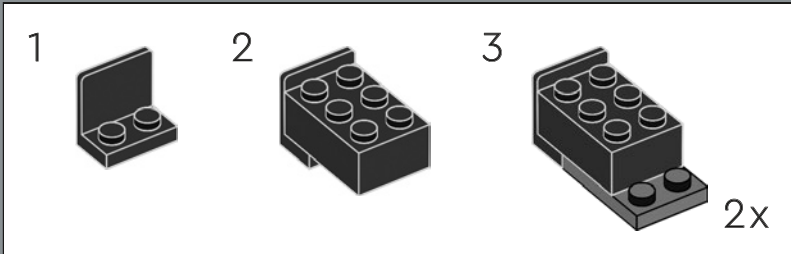





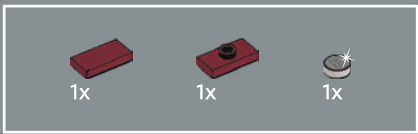

45

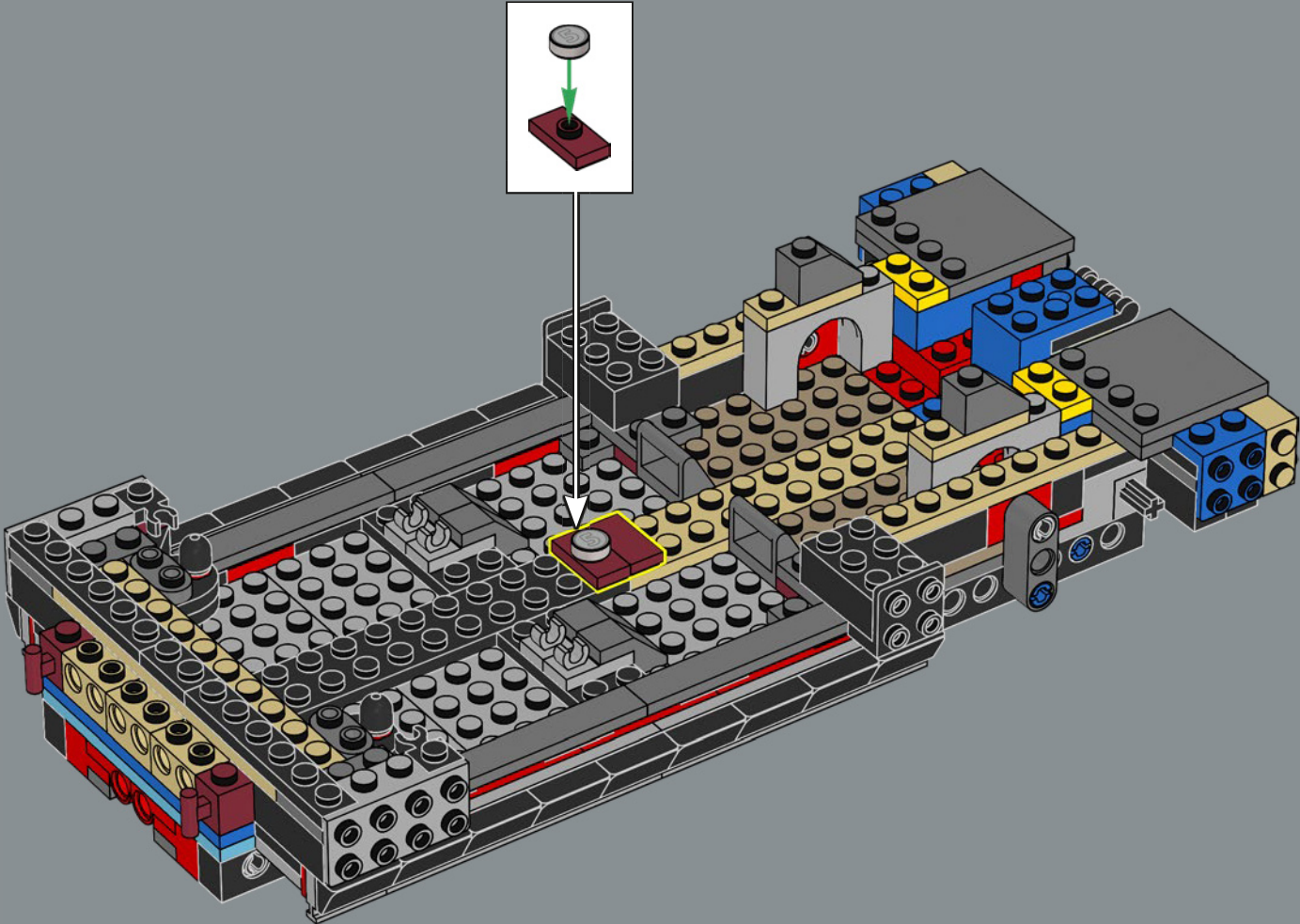

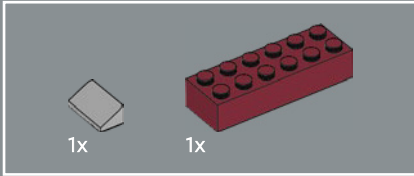
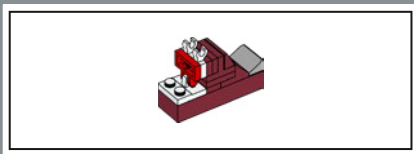

46

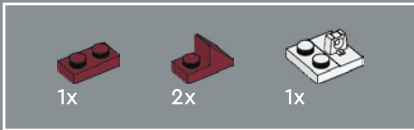
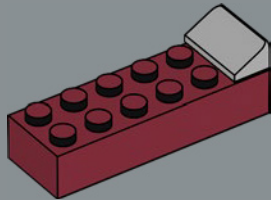

47

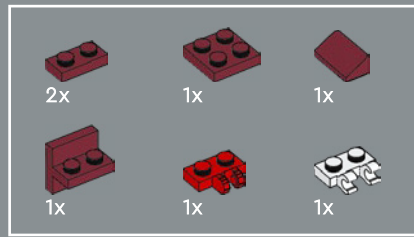
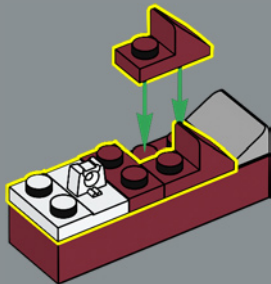

48

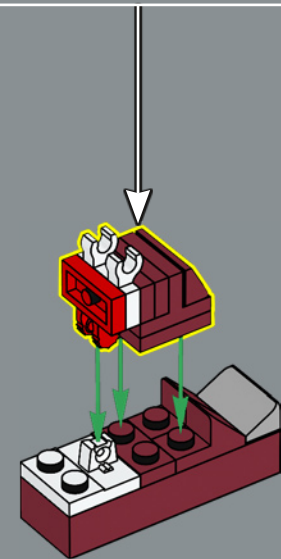
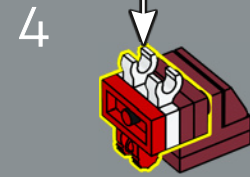
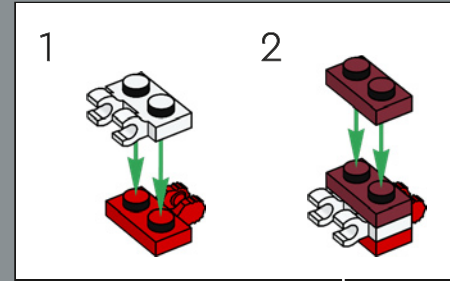
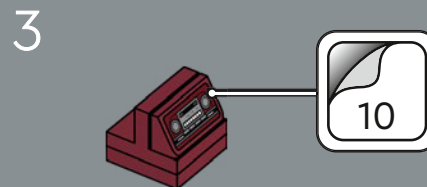
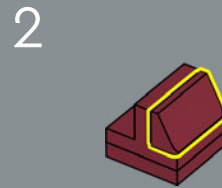
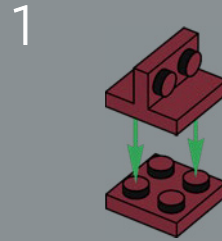

Camaro 有史以来建造的第一辆原型样车 (底盘编号 10001) 仍然存在, 并被列入了美国国家历史车辆名录 (National Historic Vehicle Register)。

49

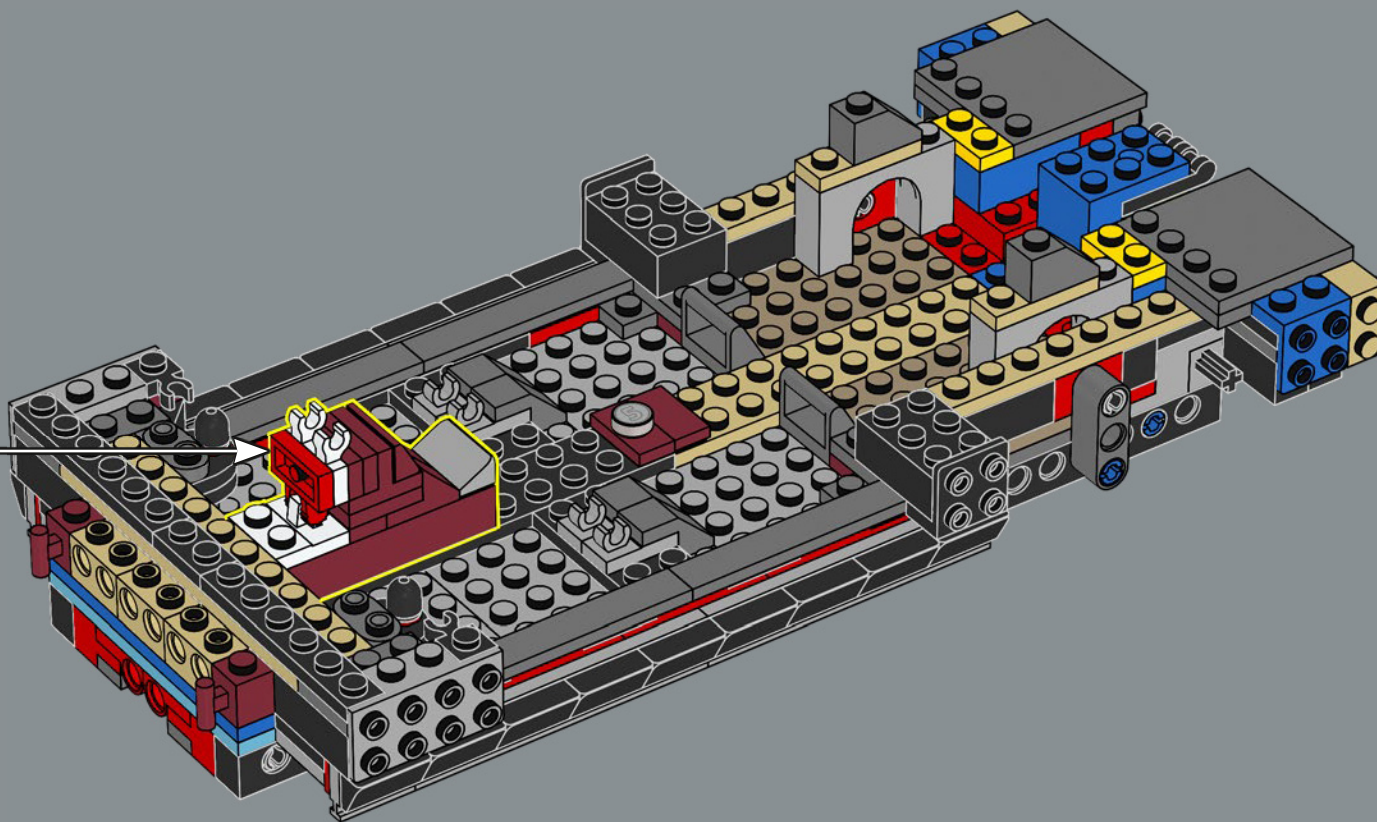

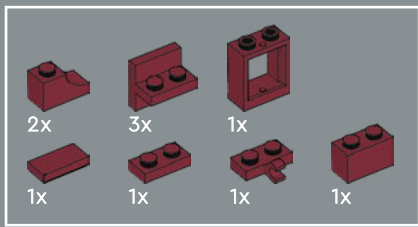

50

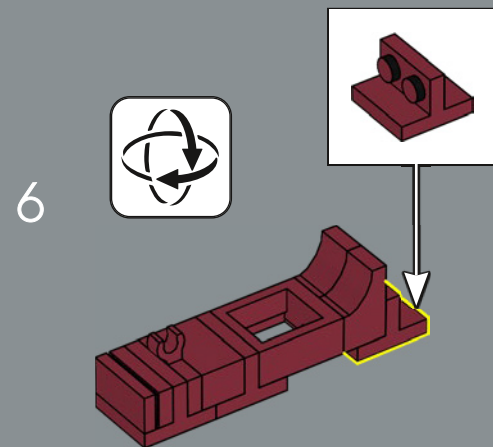
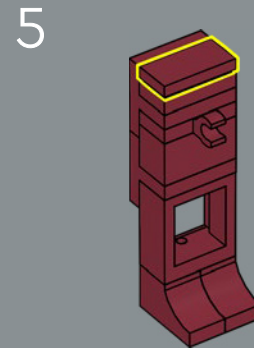
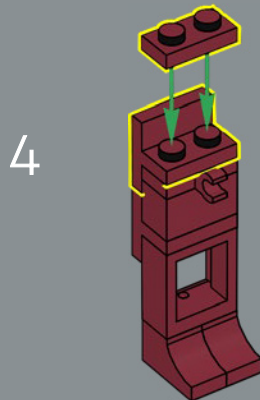
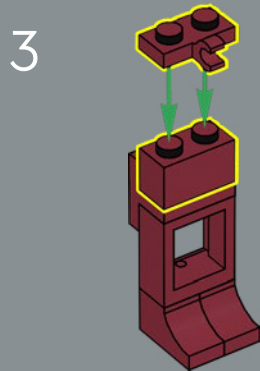
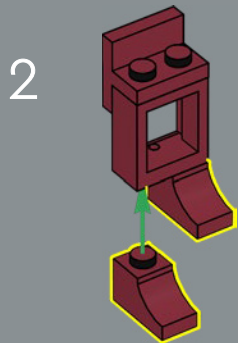
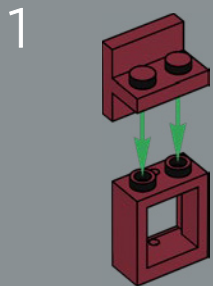

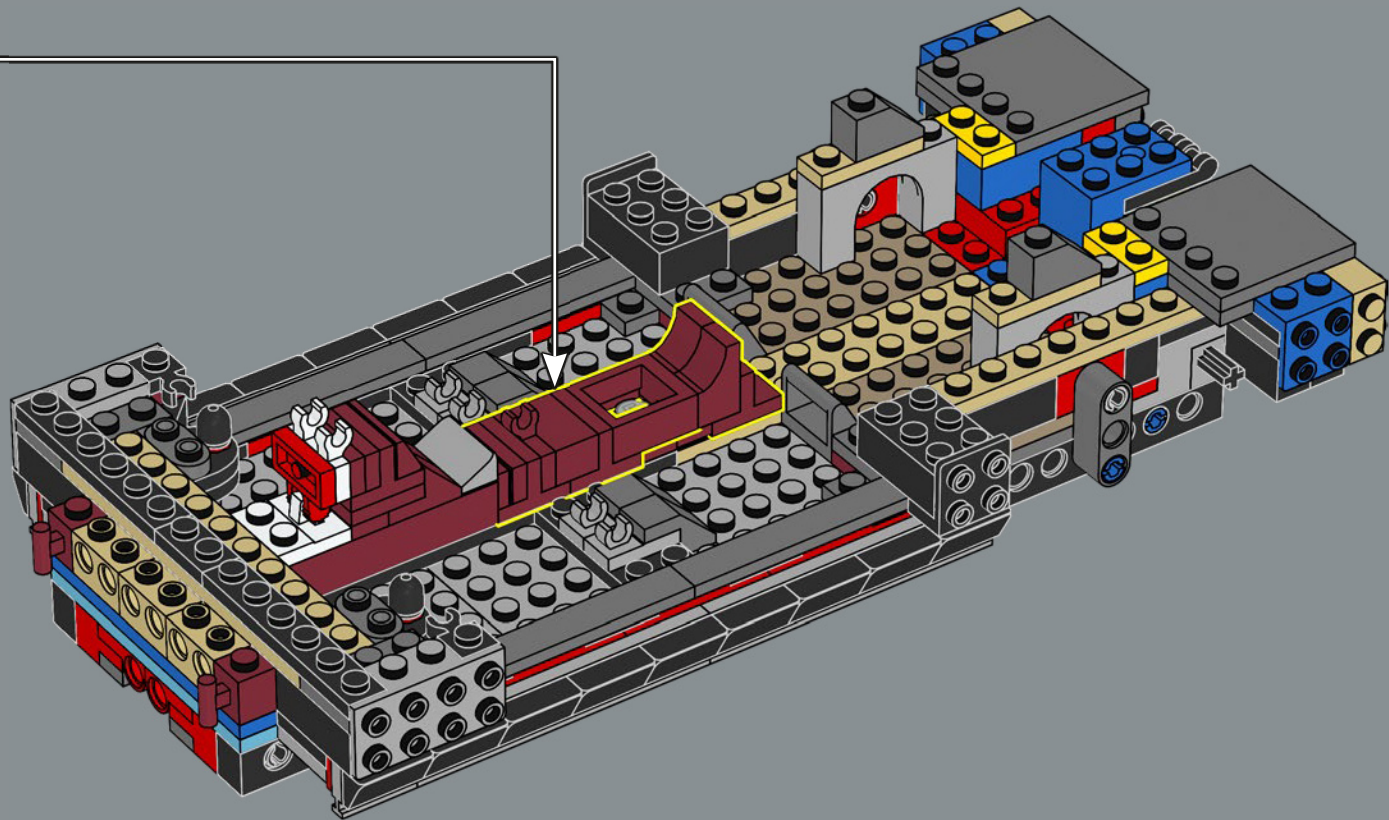

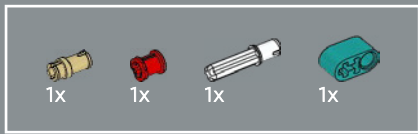

51

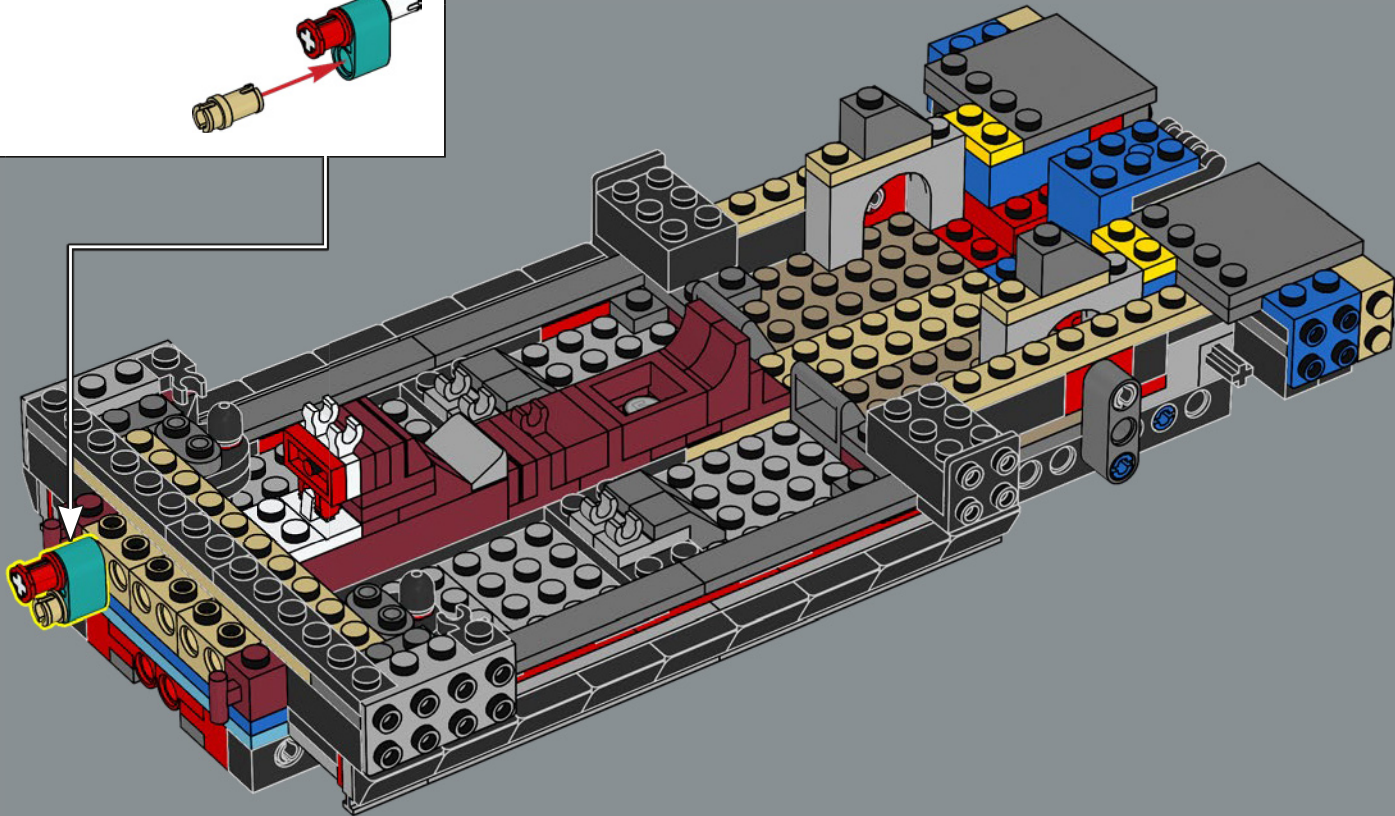
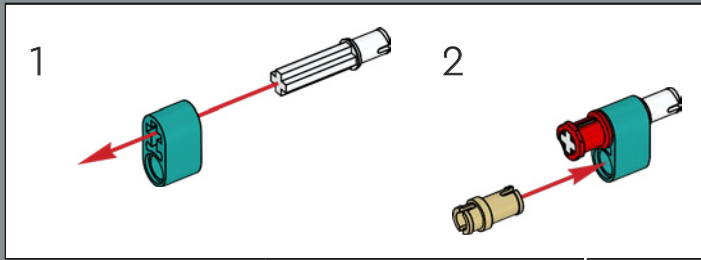

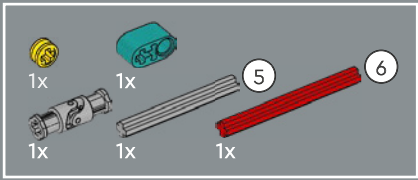

52

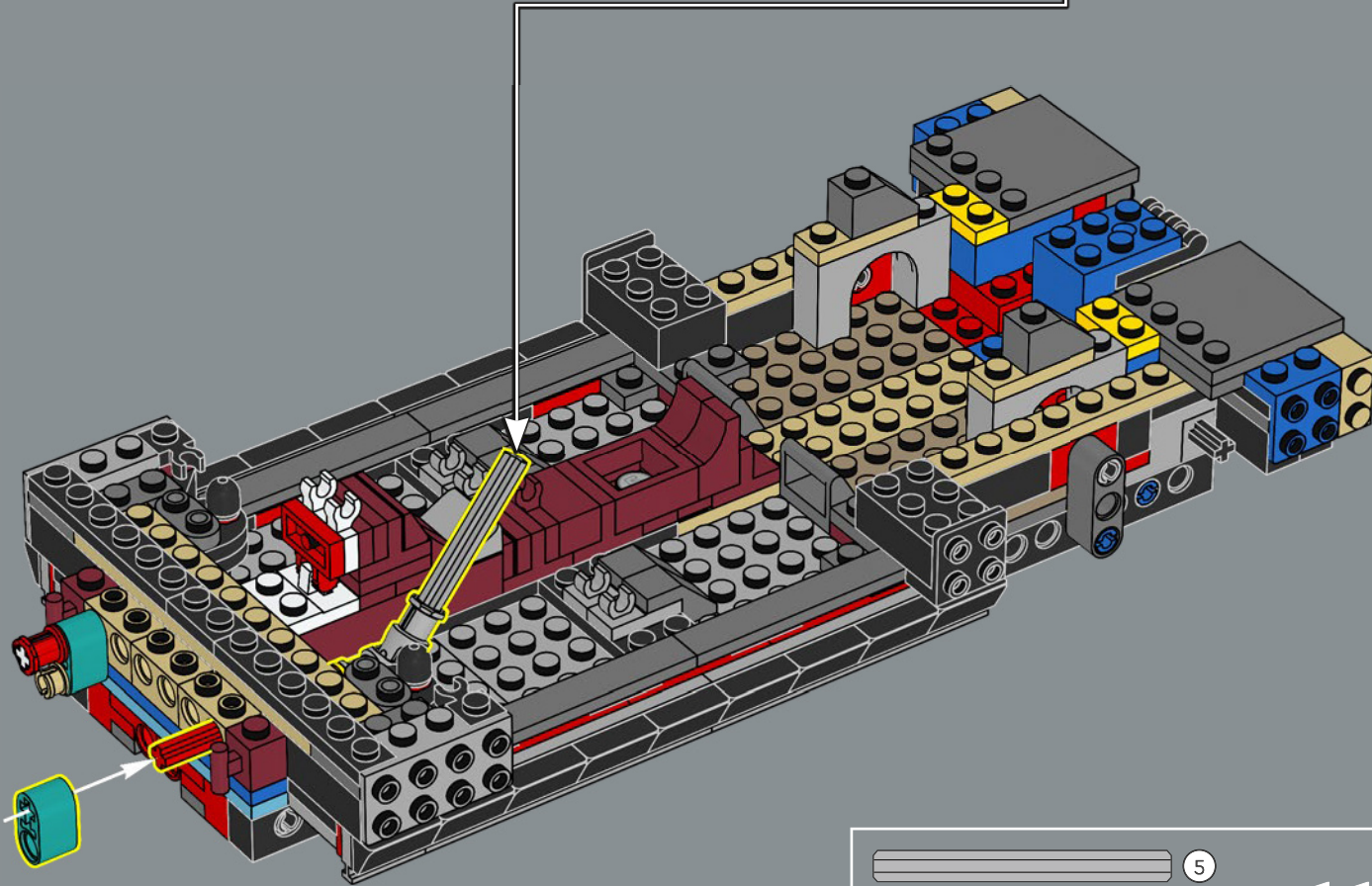
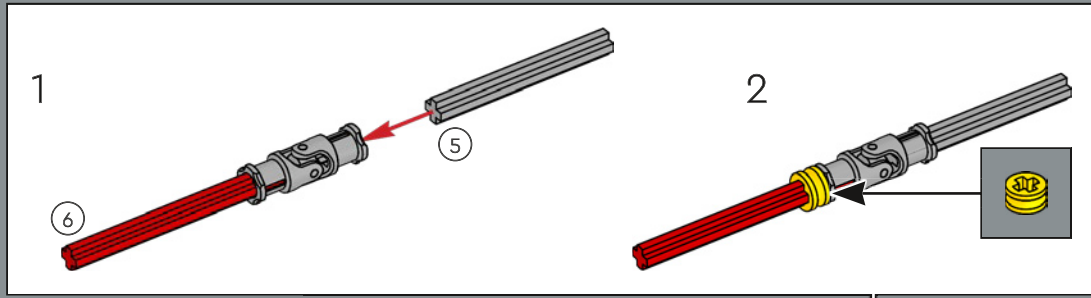





53

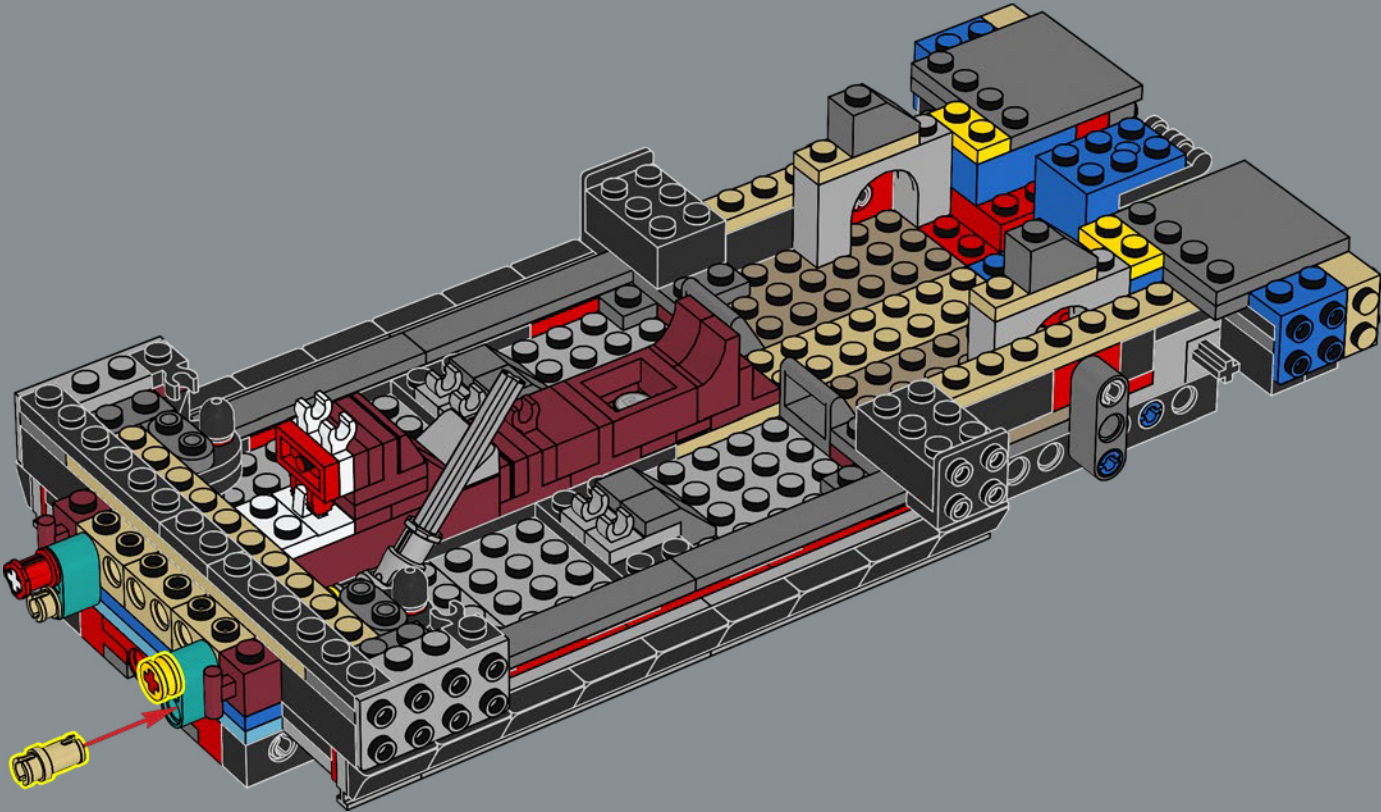

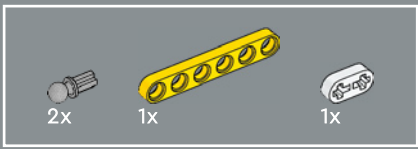

54

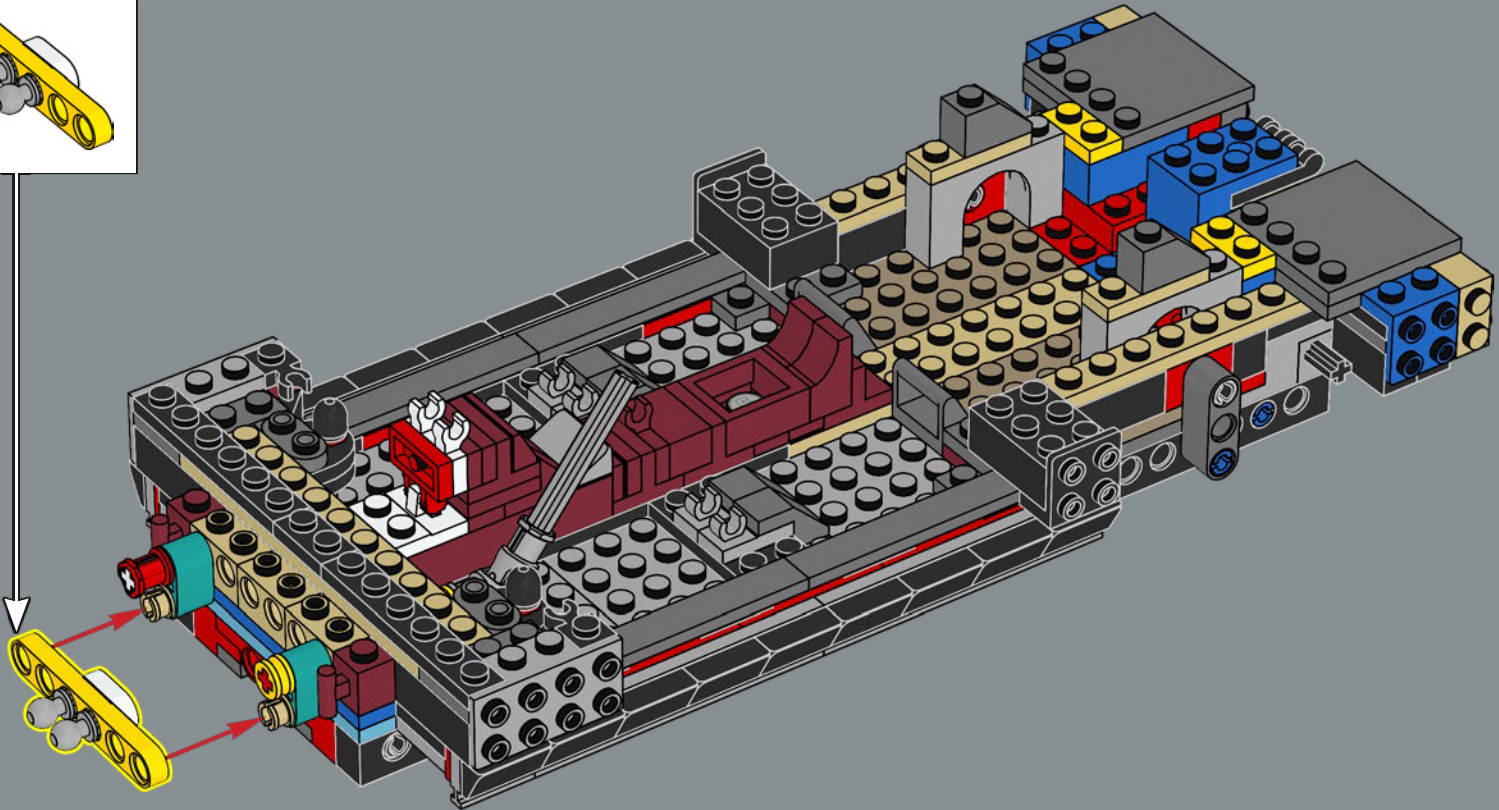
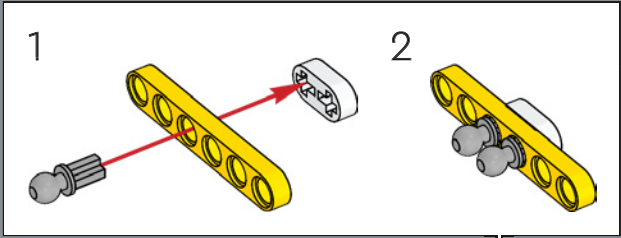

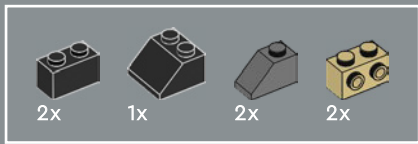

55

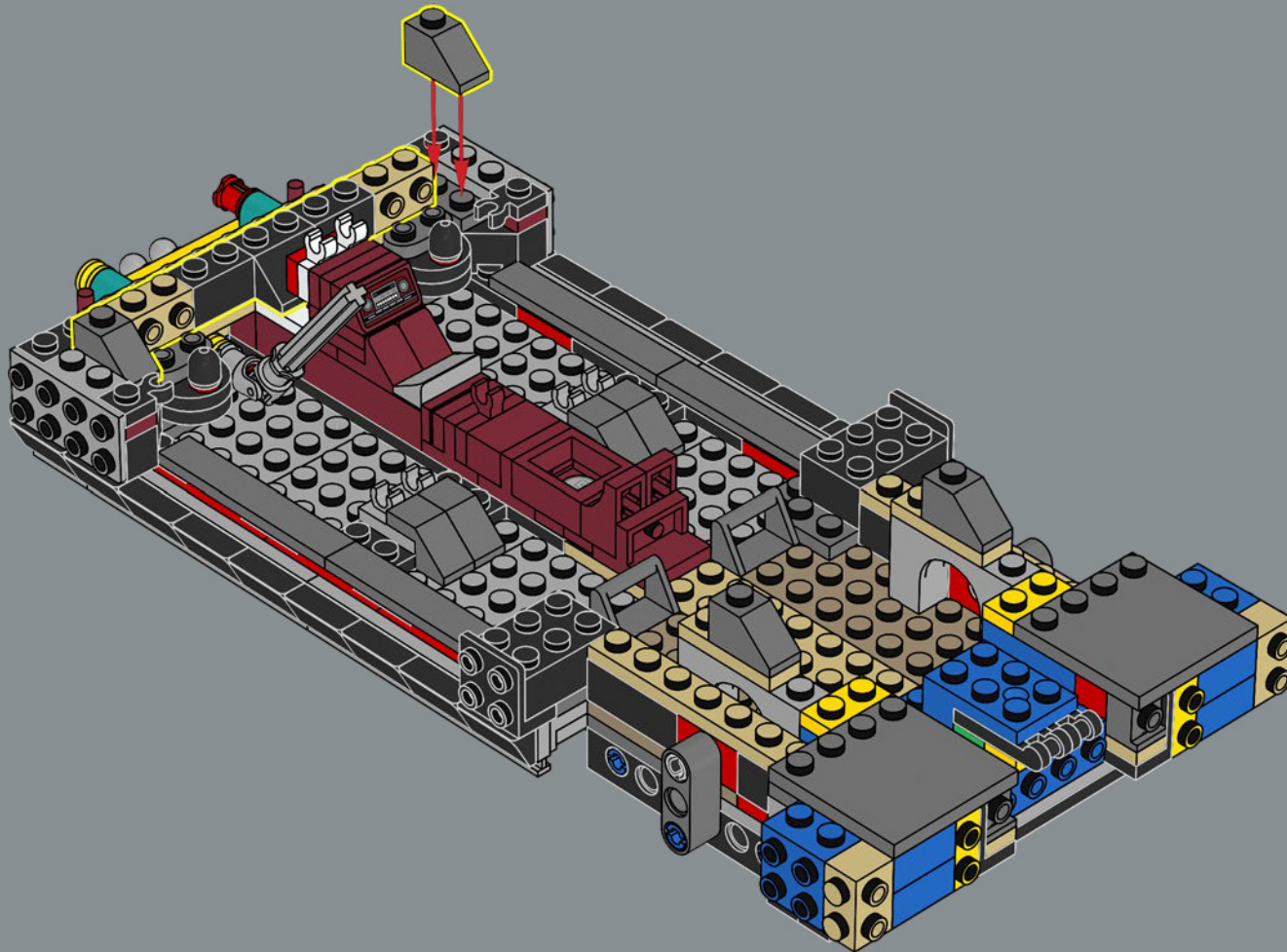

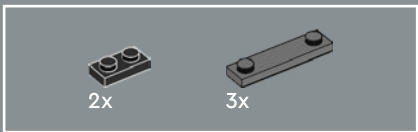

56

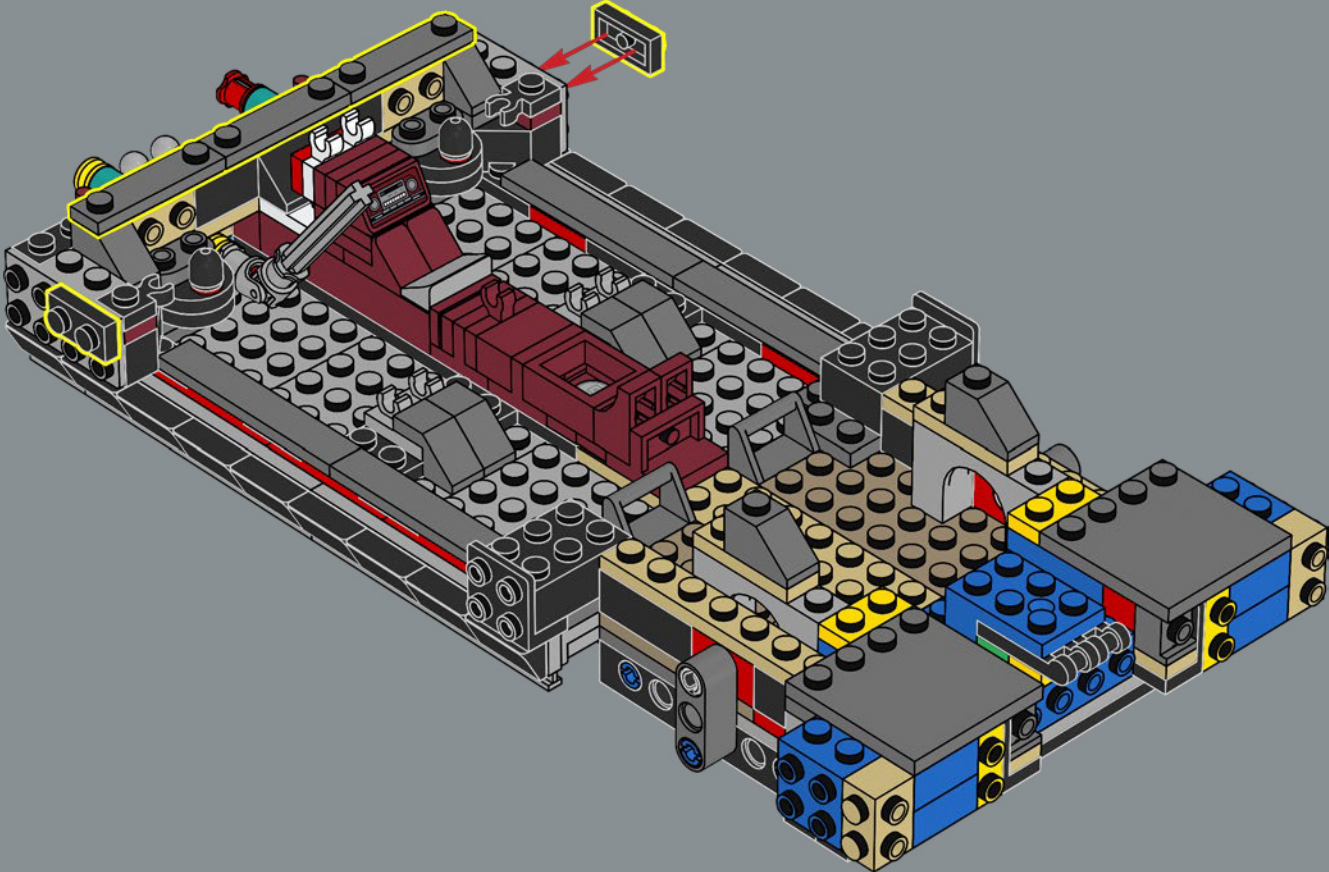

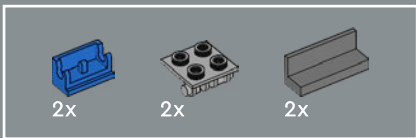

57

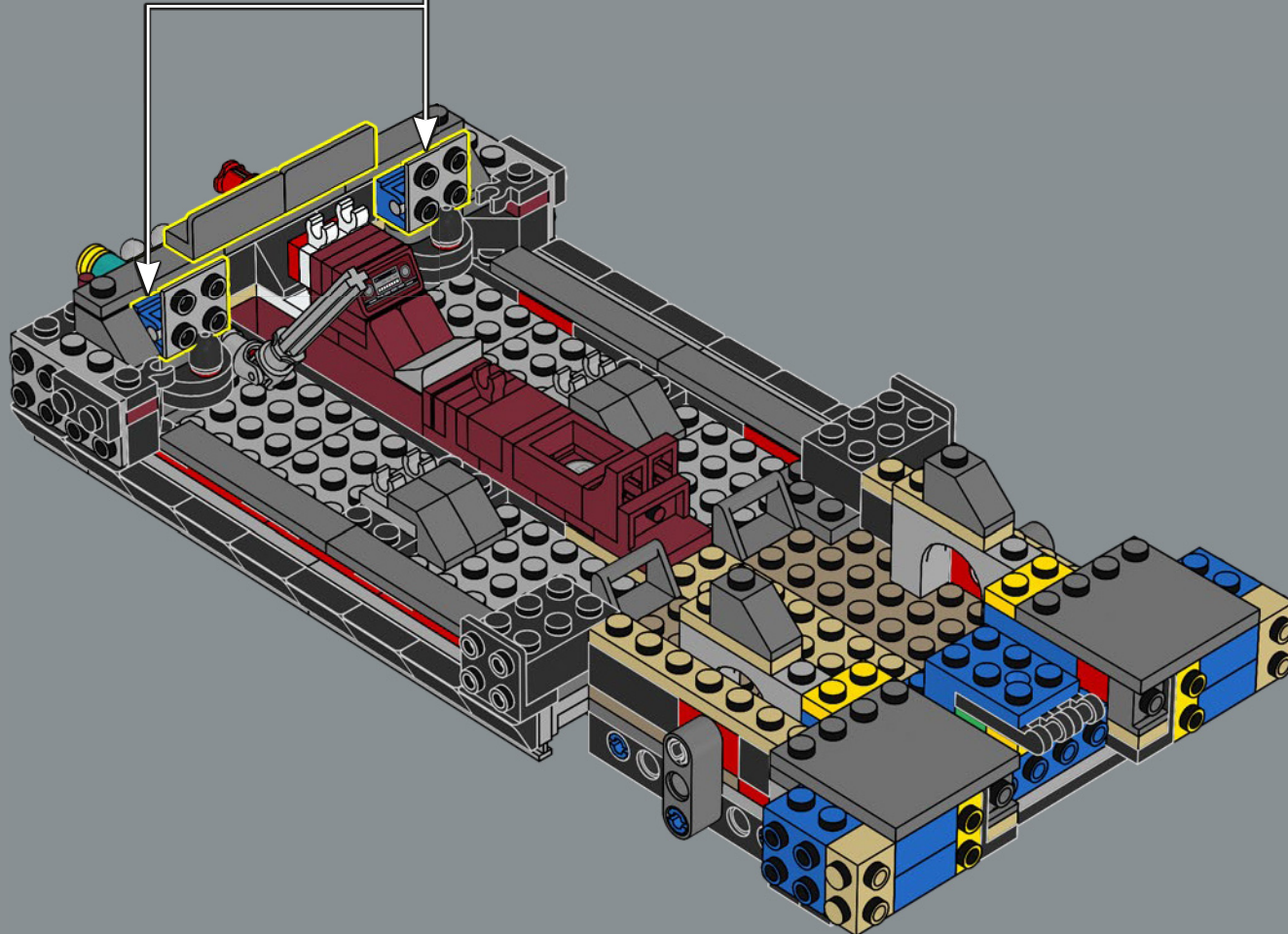
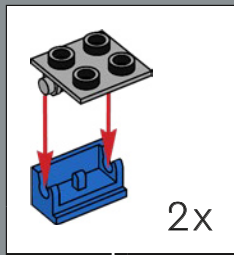

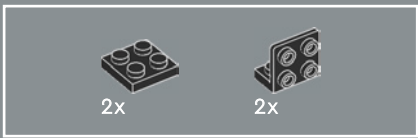

58

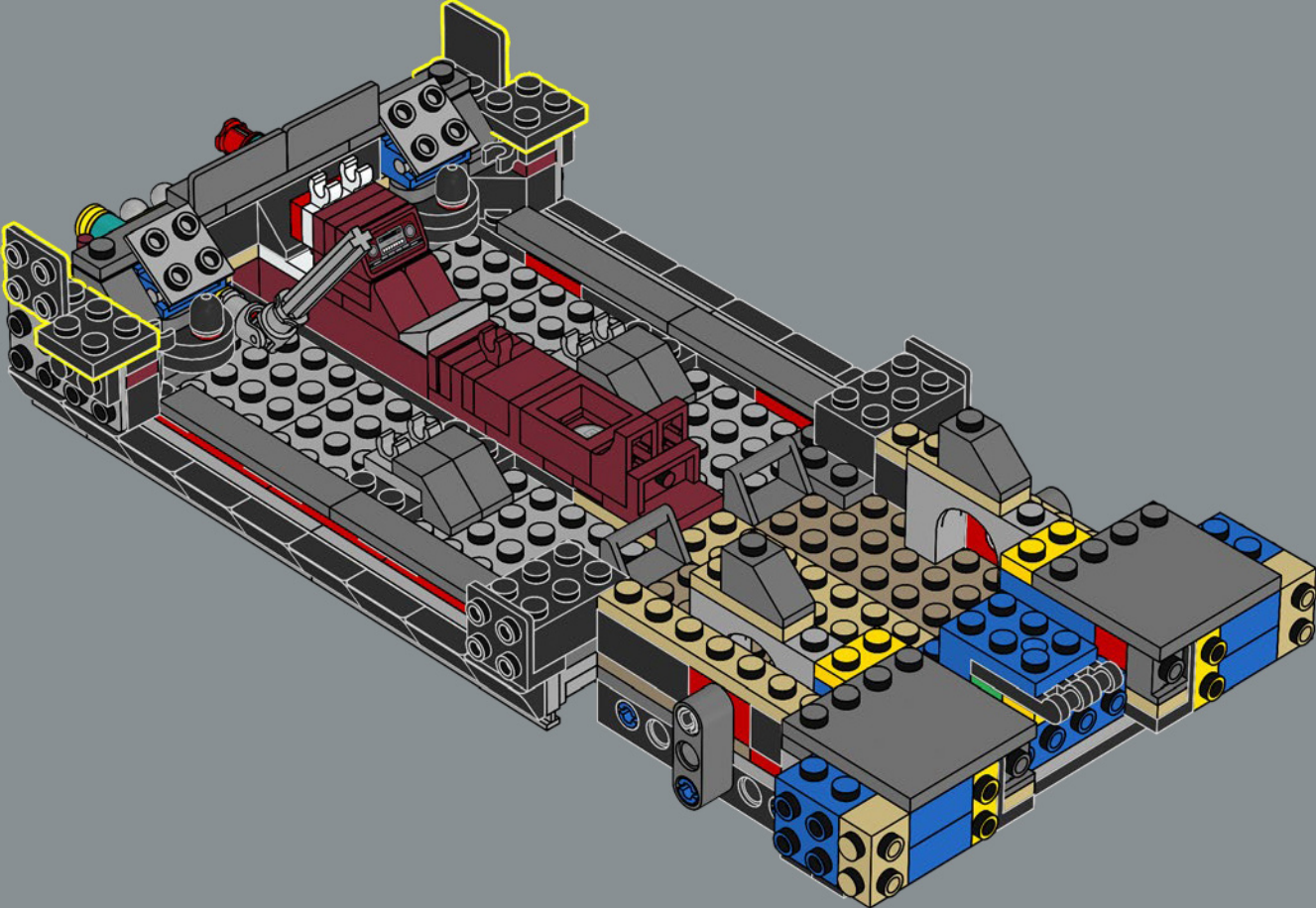

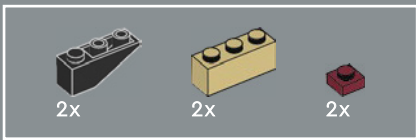

59

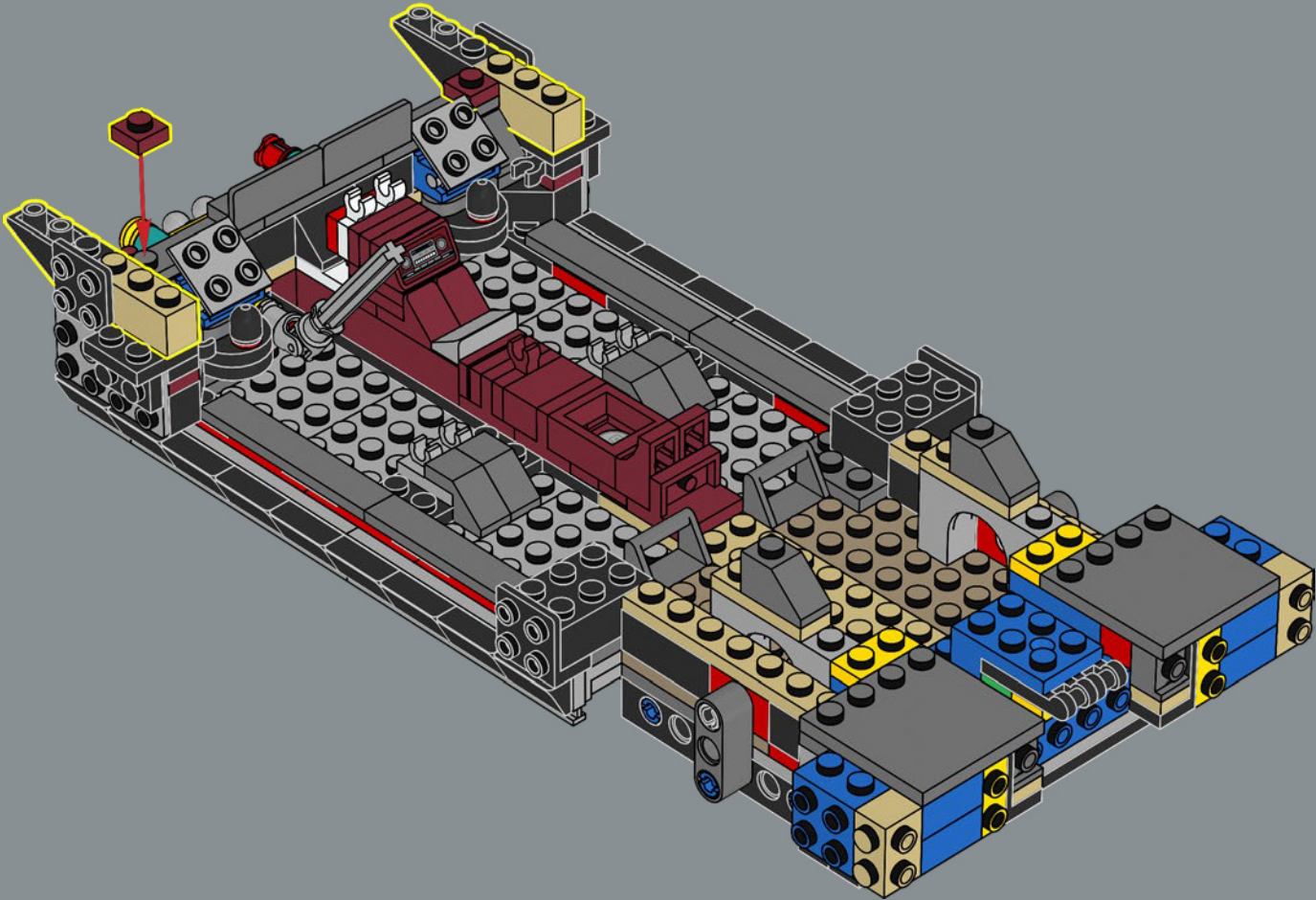



60

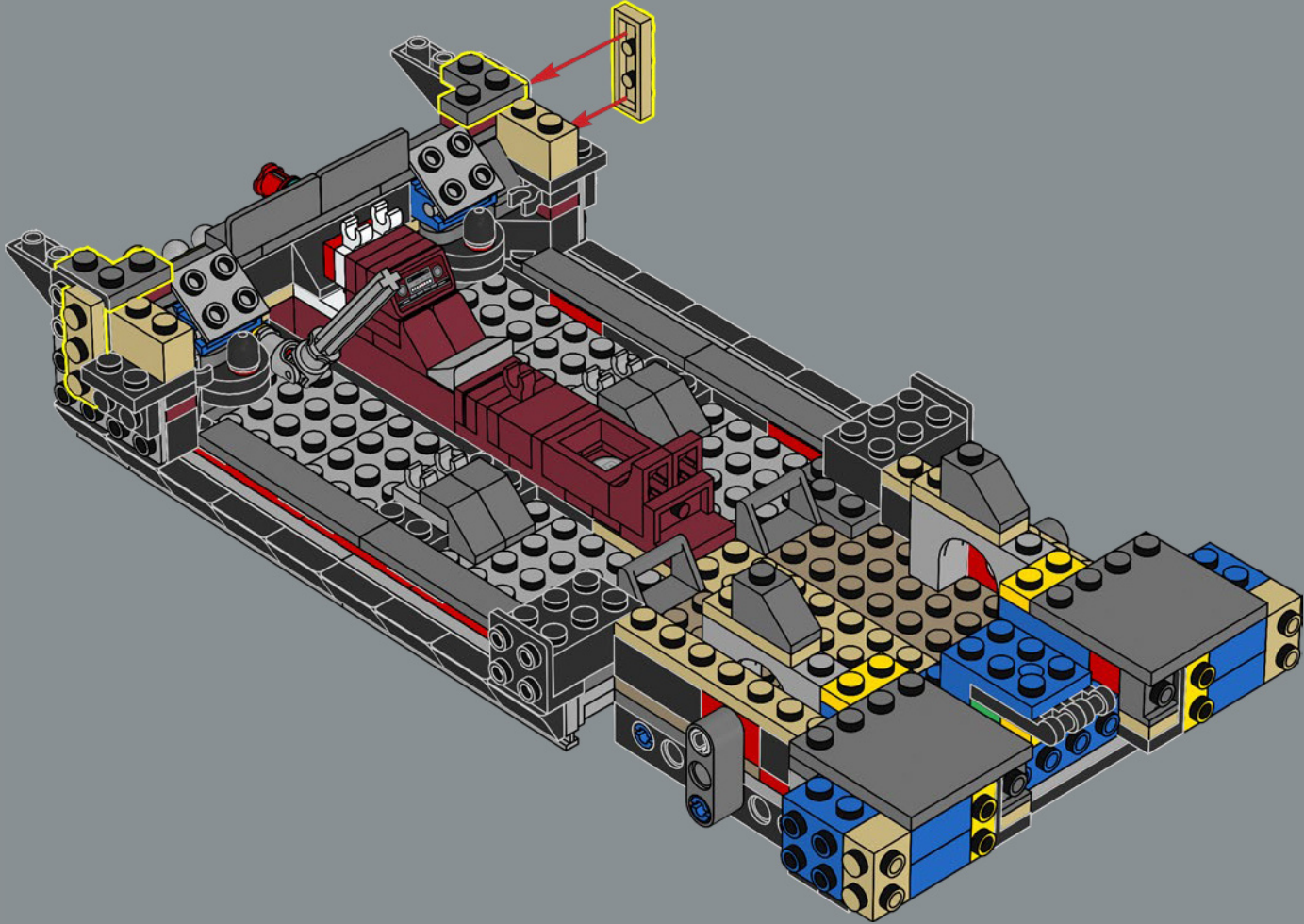



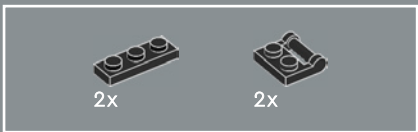

61

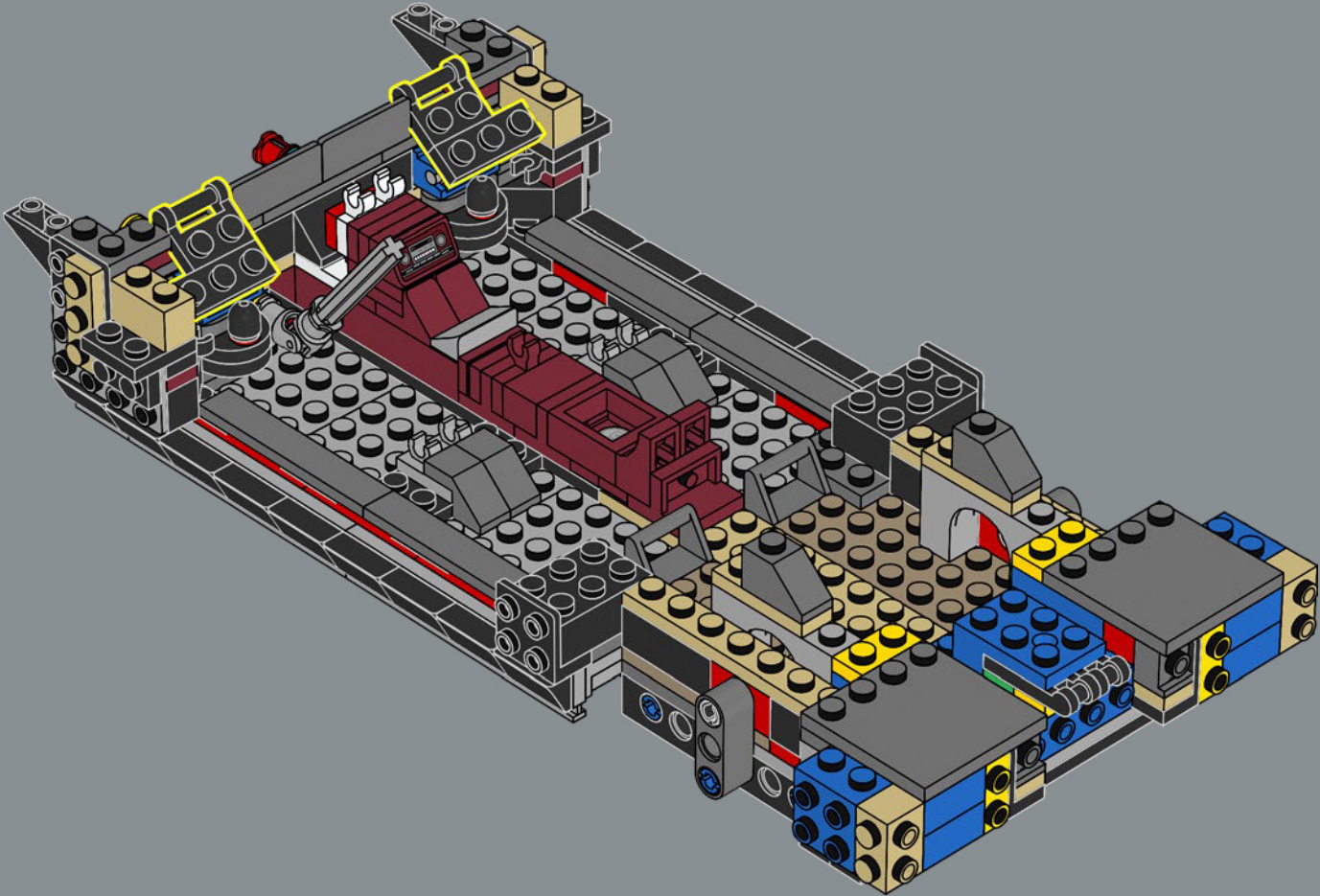

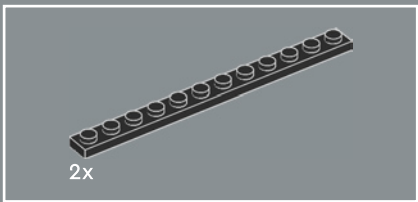

62

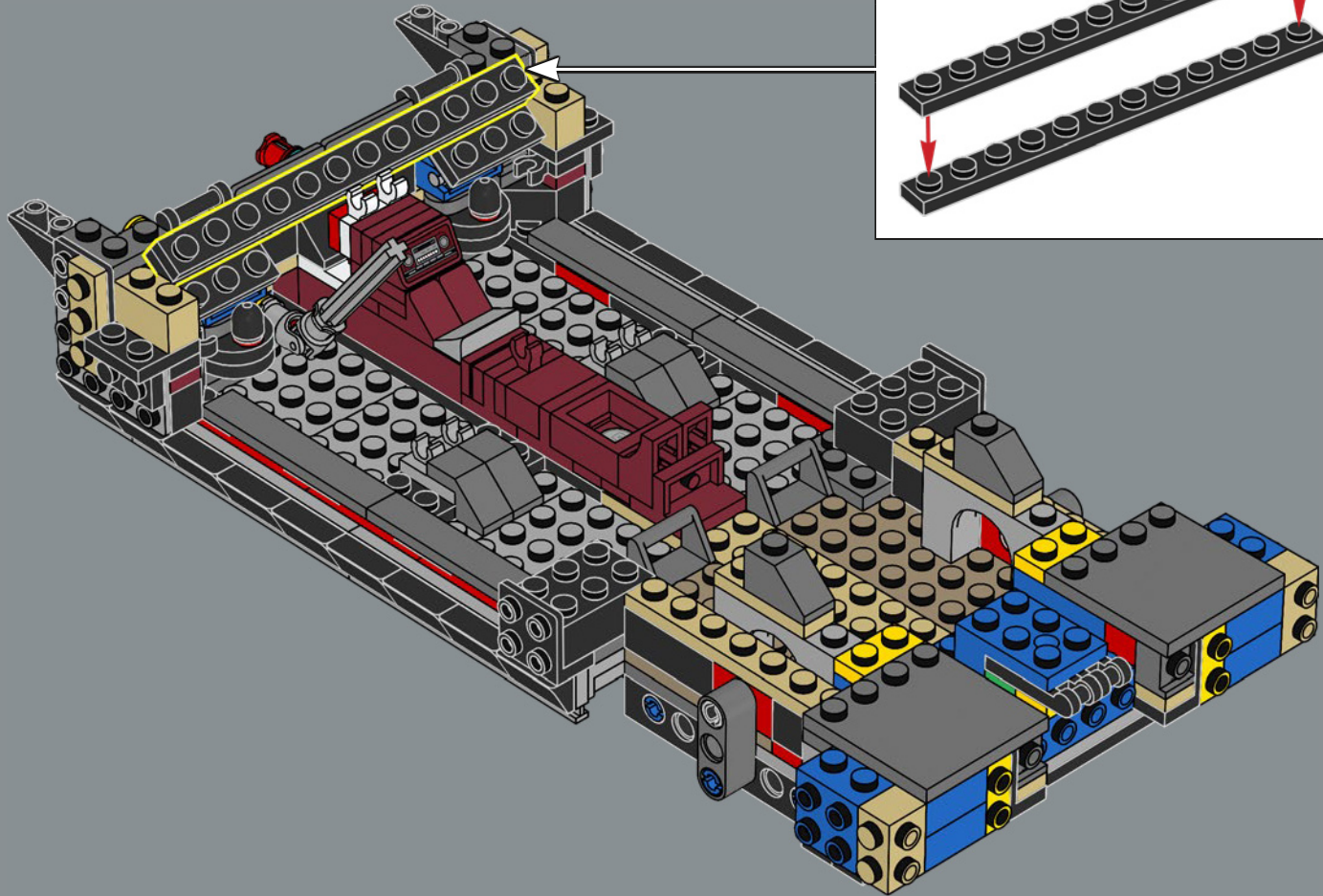

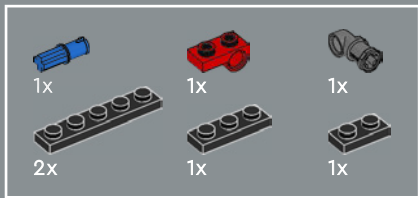

63

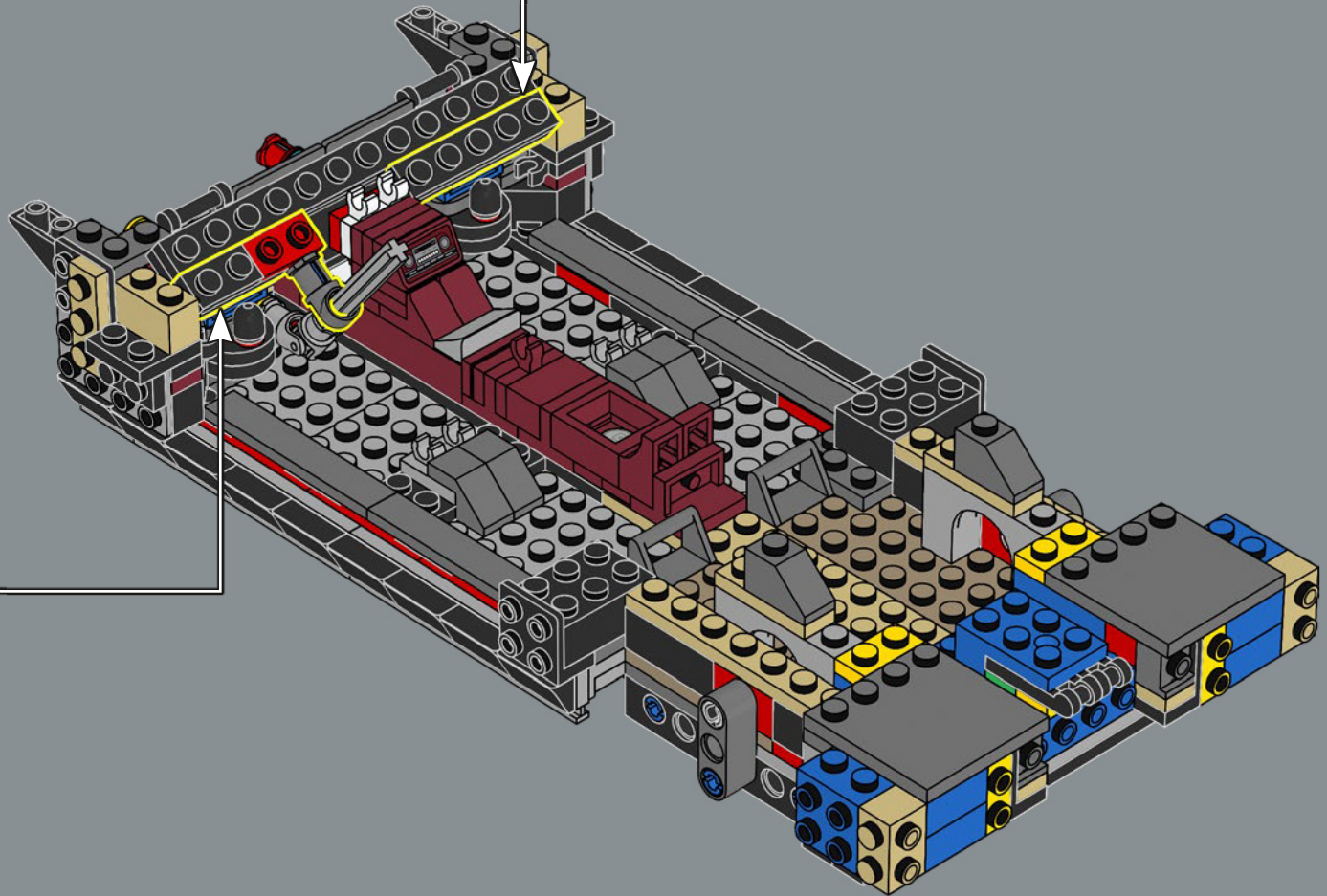
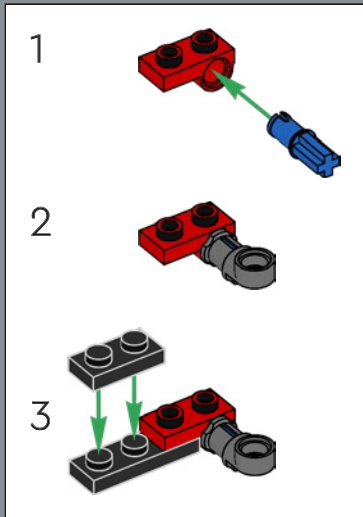
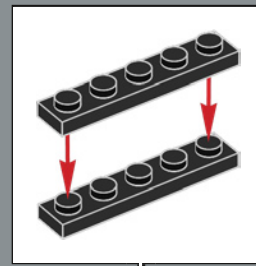

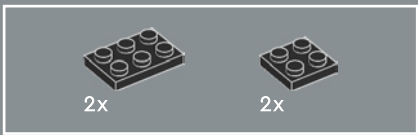

64

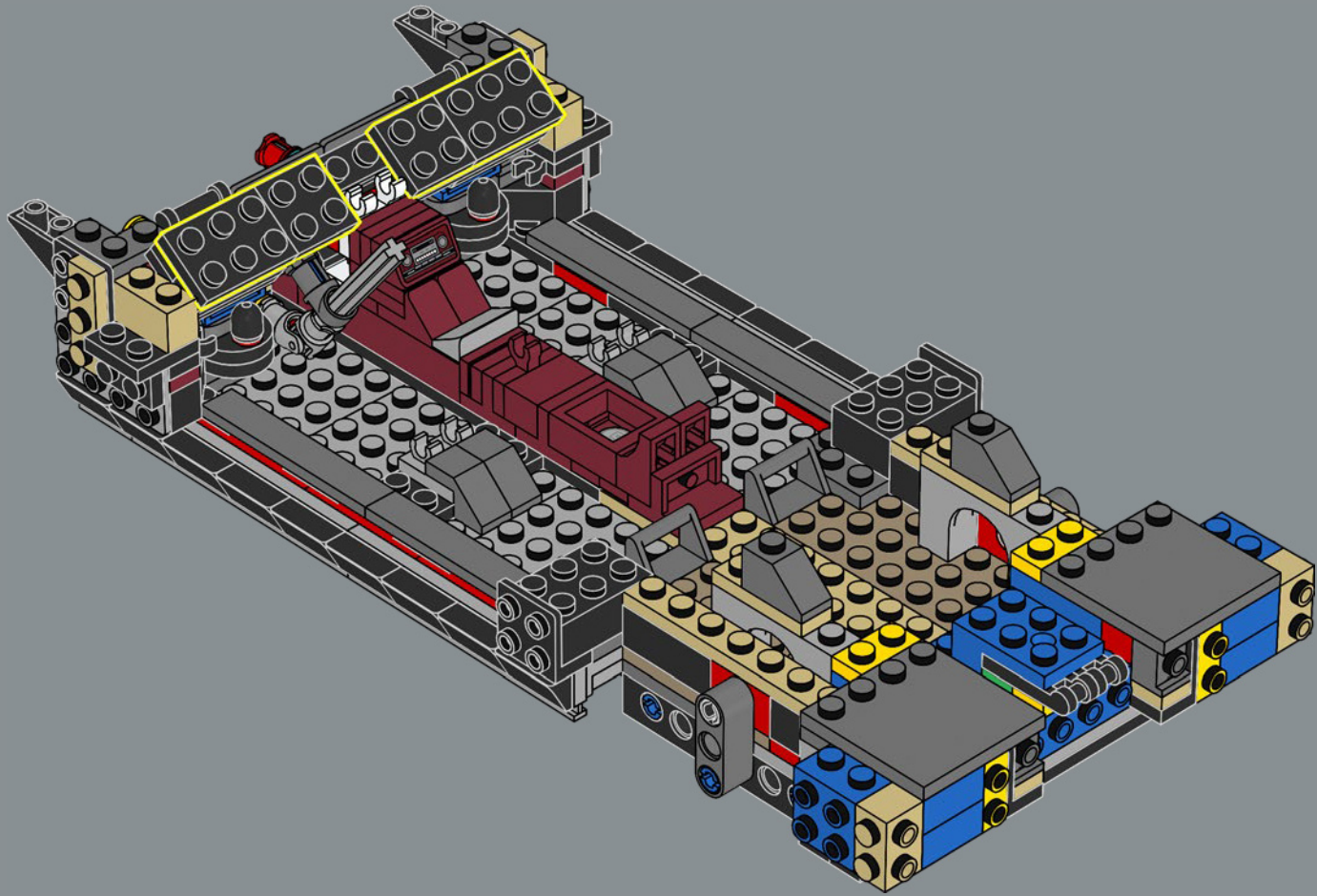



65

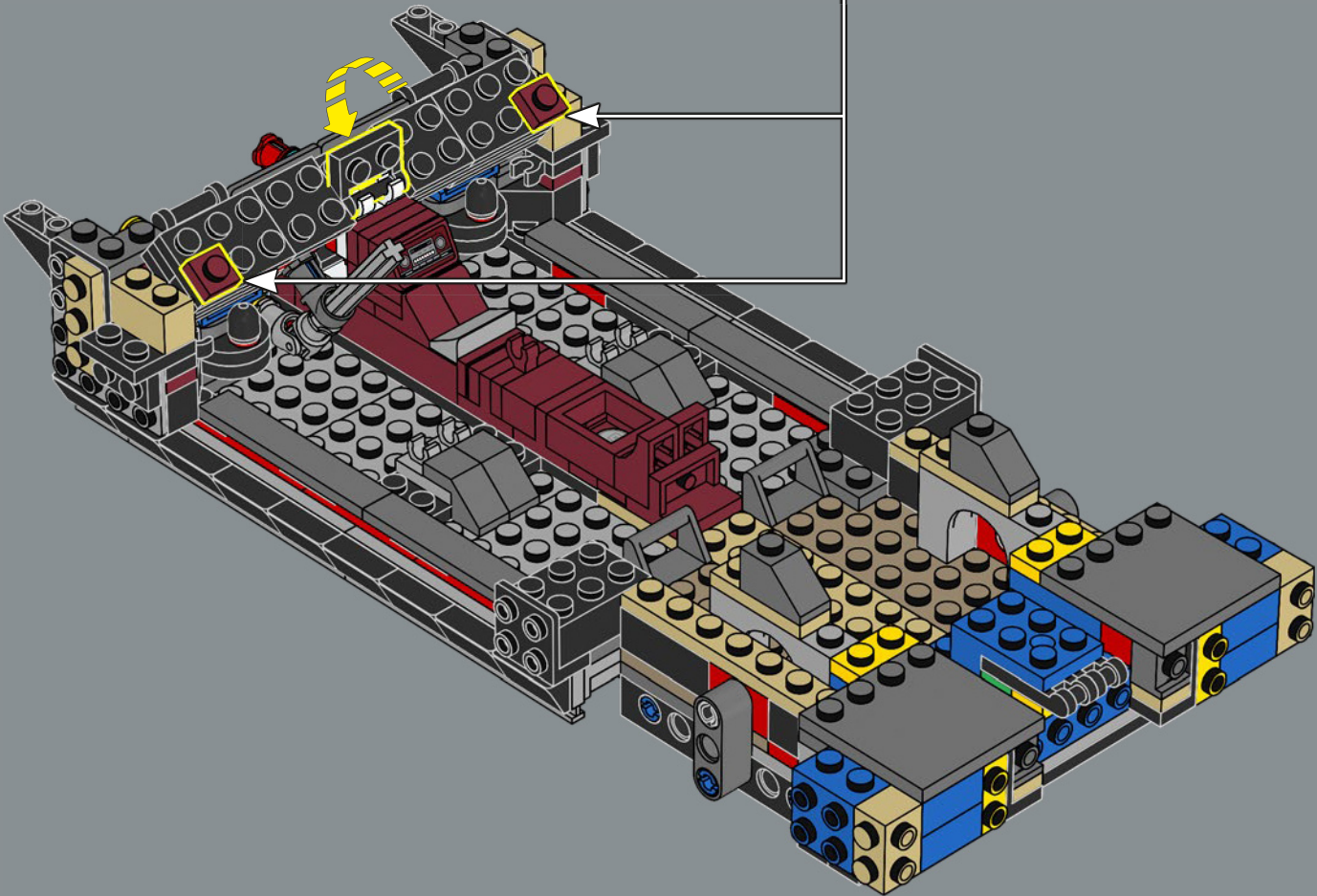
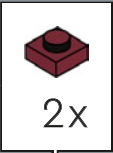

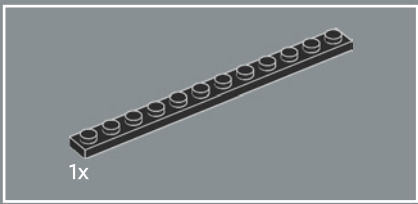

66

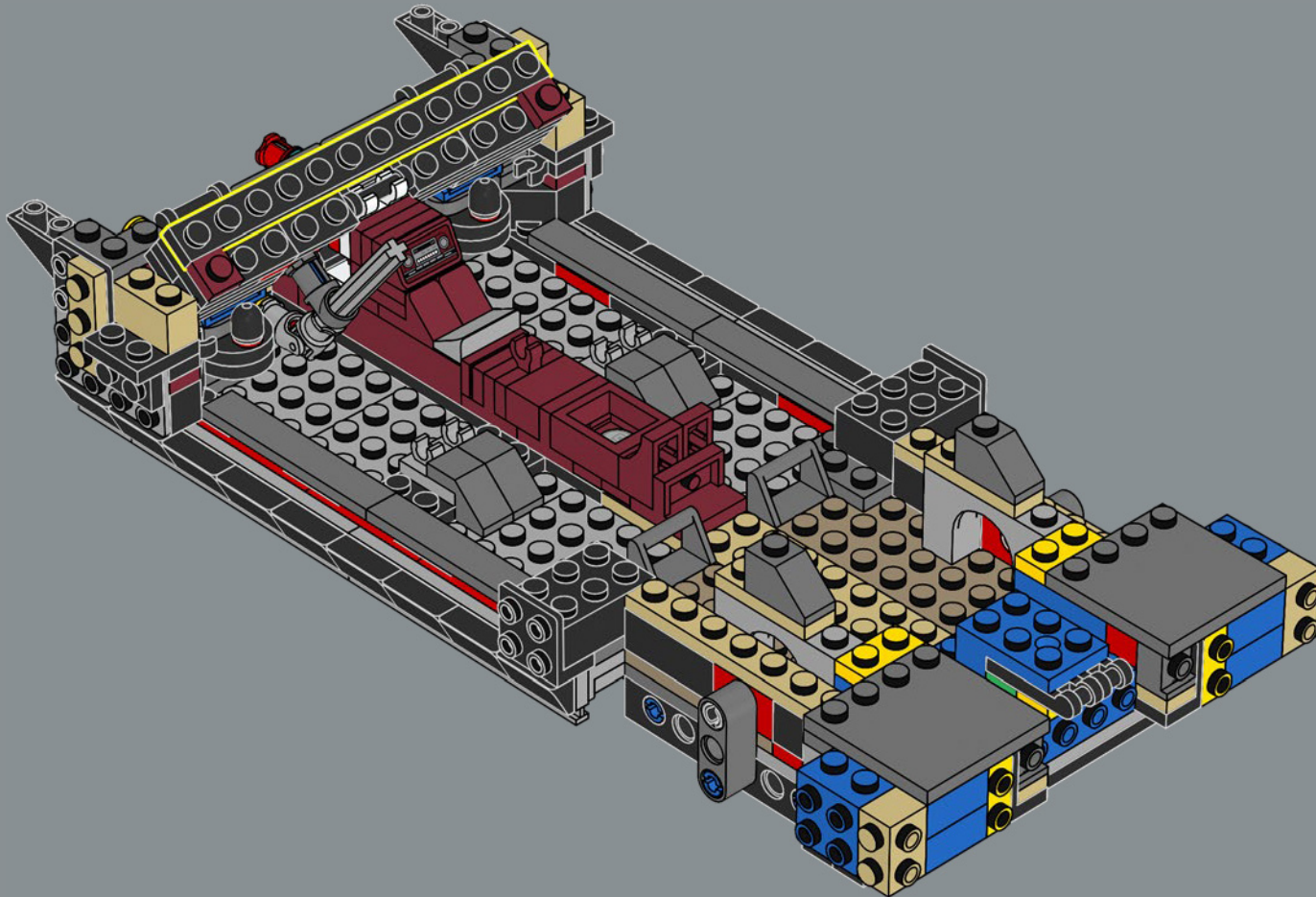

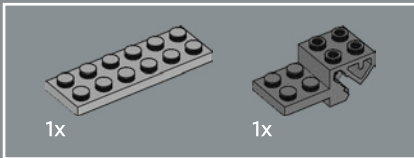
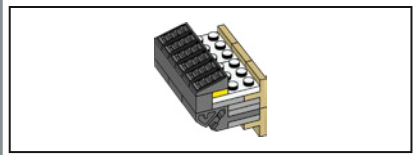

67

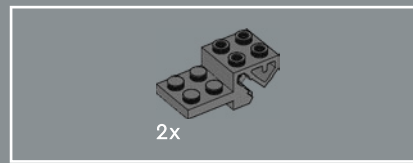
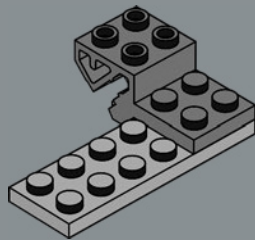

68

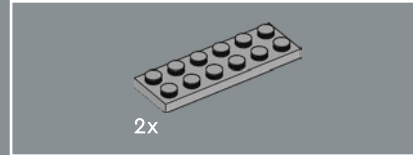
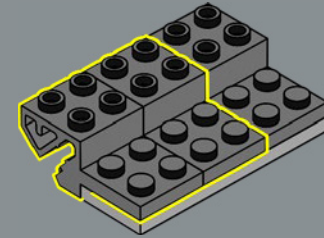

69

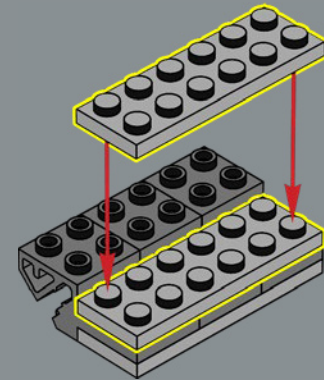

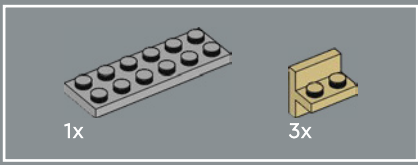

70

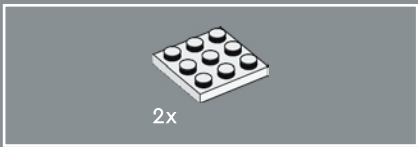
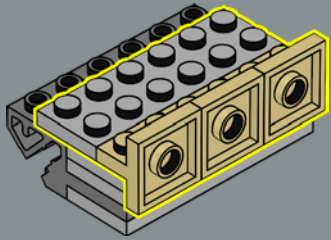

71

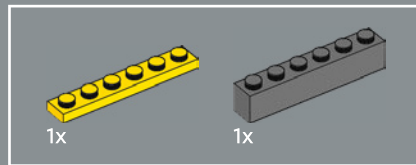
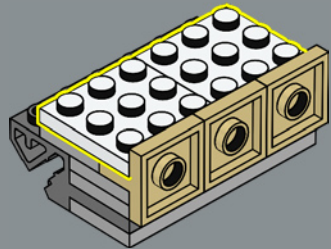

72

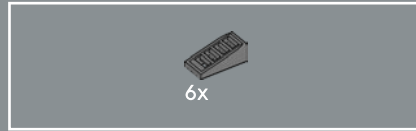
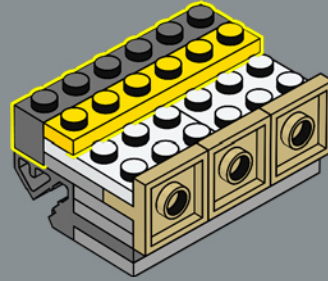

73

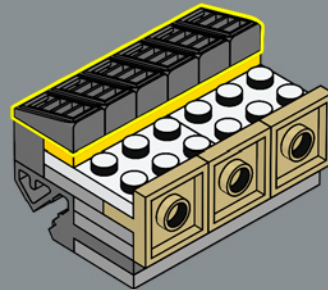

74

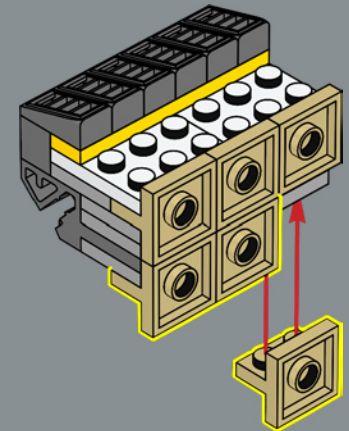



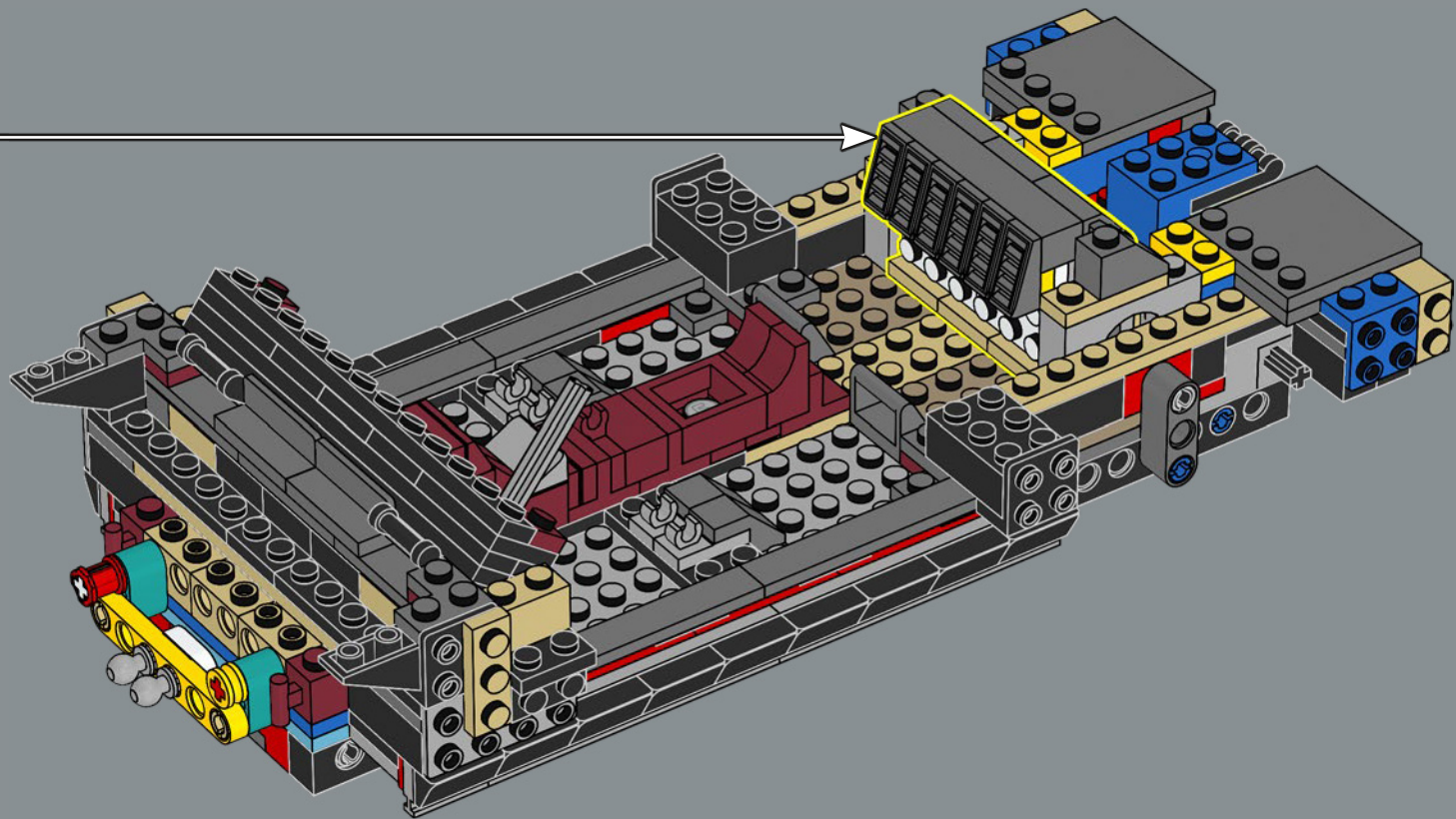



76

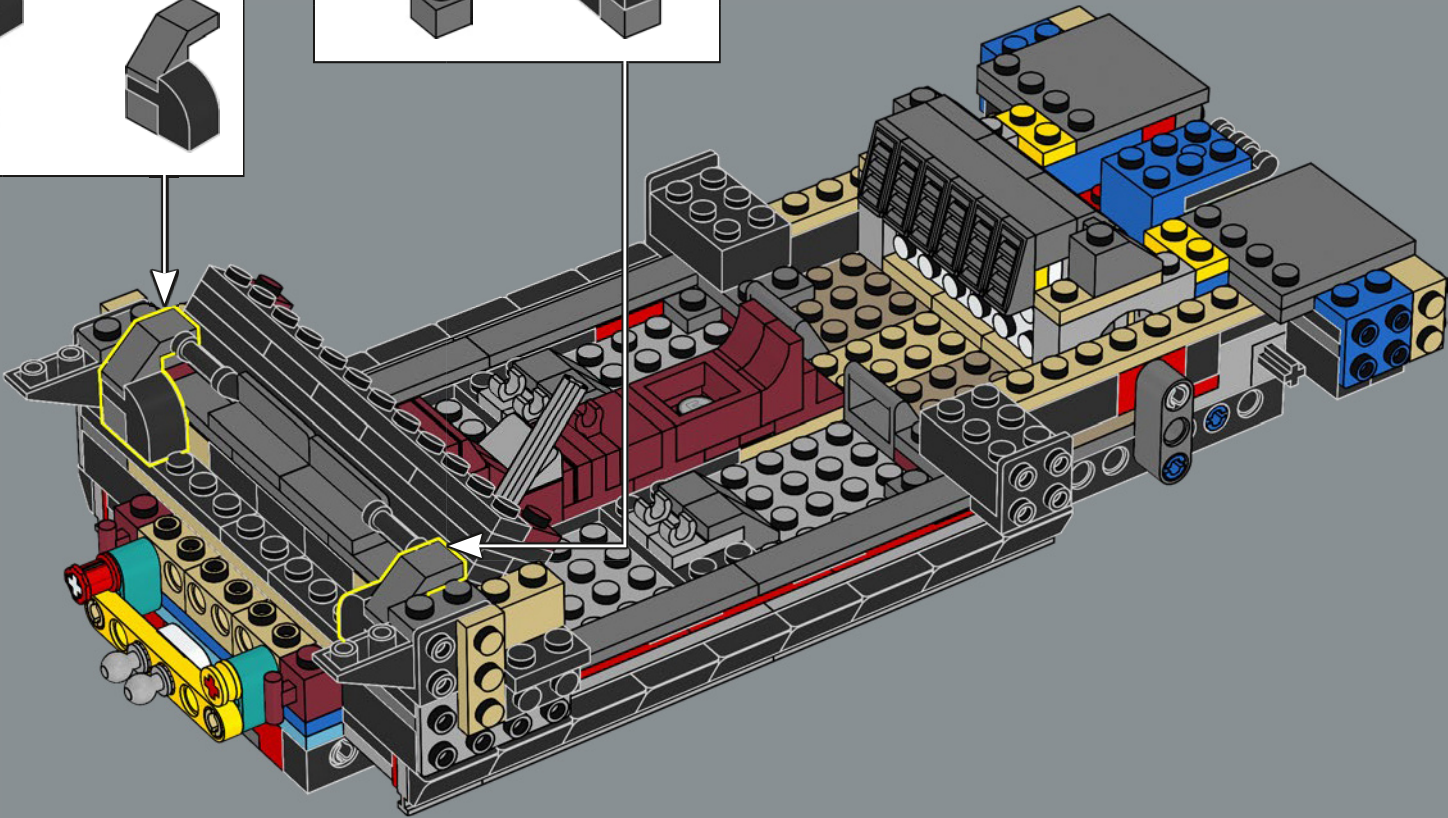
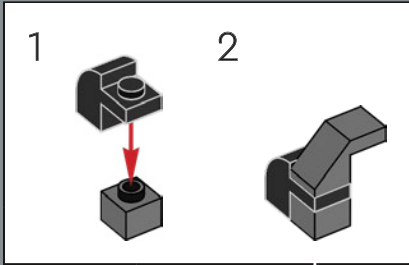
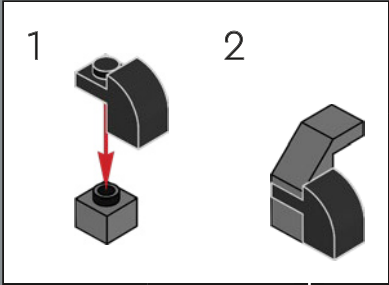

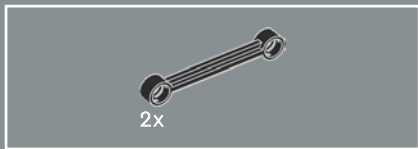

早在 1969 年，一辆特殊的敞篷  
Camaro Z11 被用作印第安纳波利  
斯 500 英里大奖赛的安全车。

77

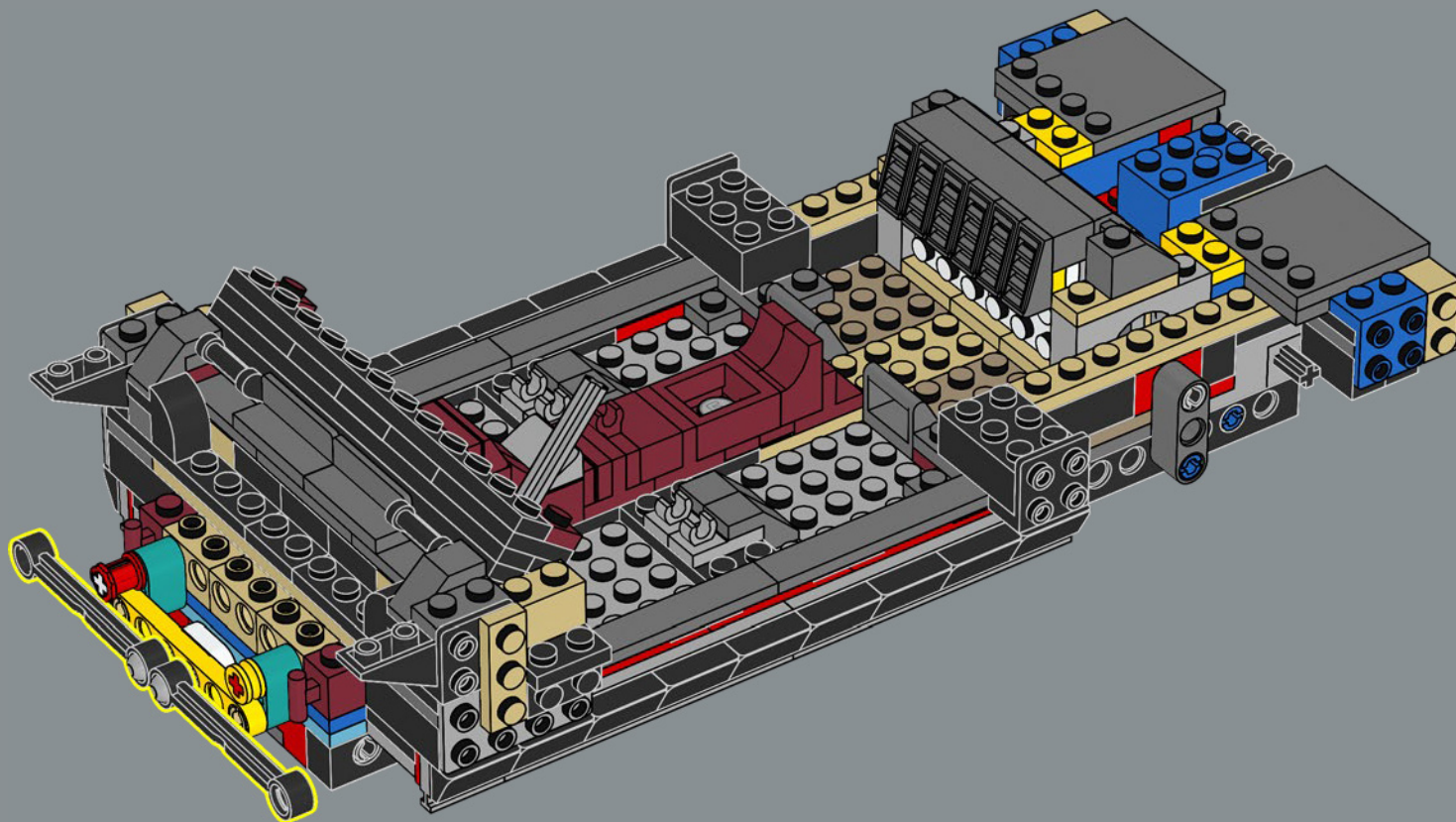

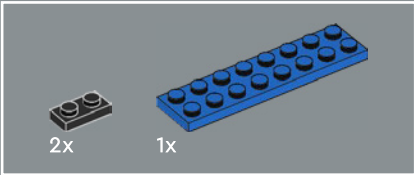
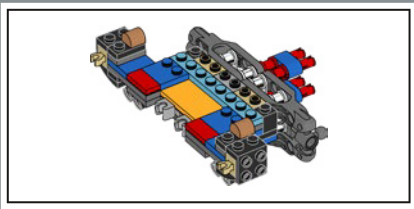

78

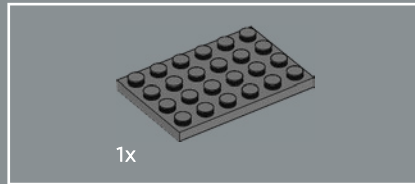
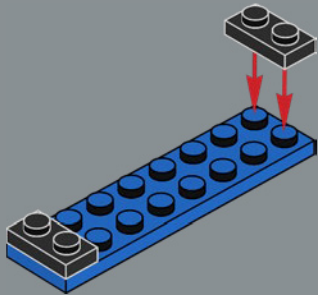

79

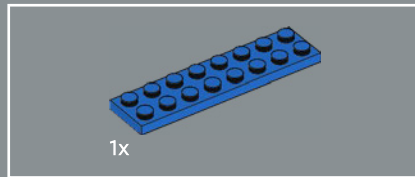
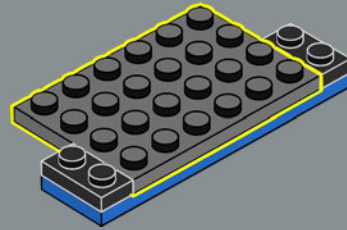

80

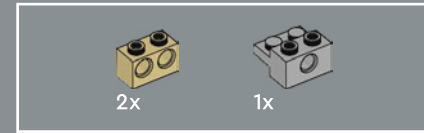
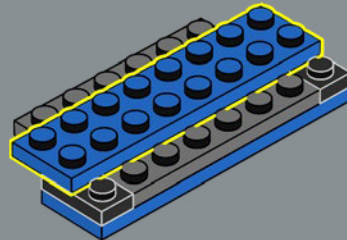

81

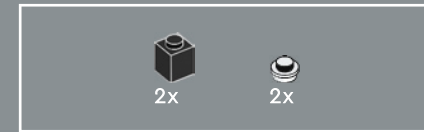
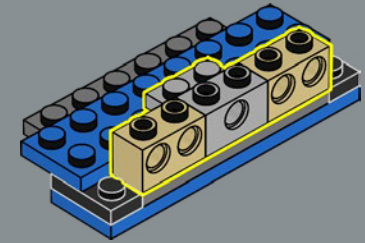

82

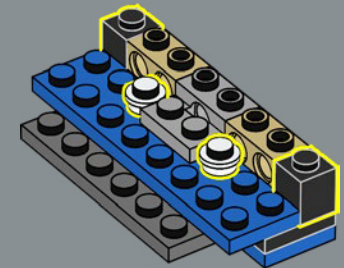

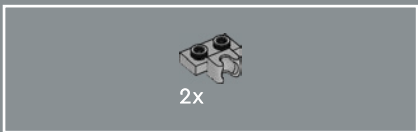

83

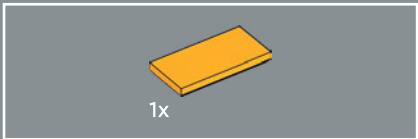
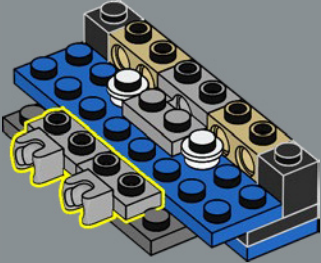

84

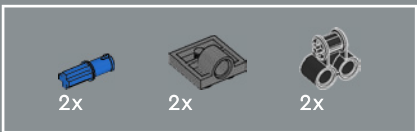
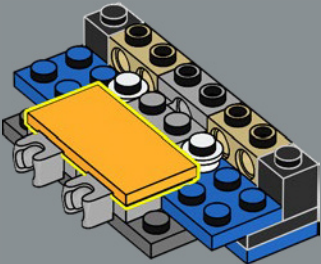

85

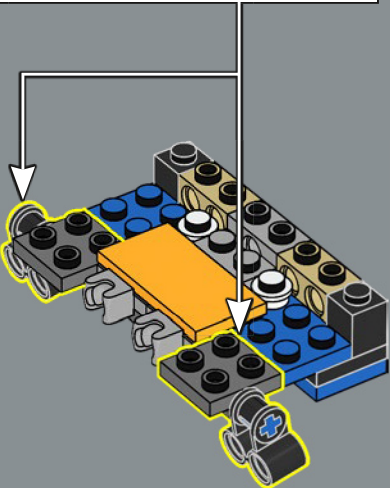
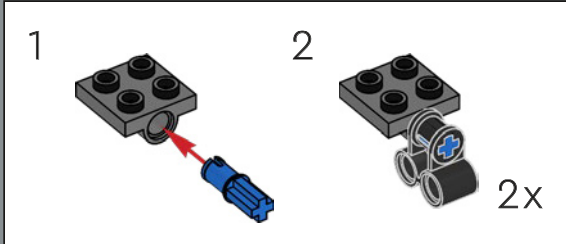

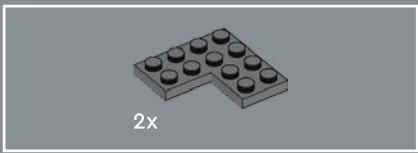

86

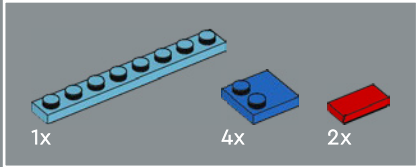
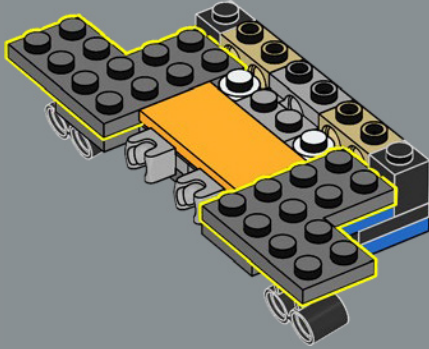

87

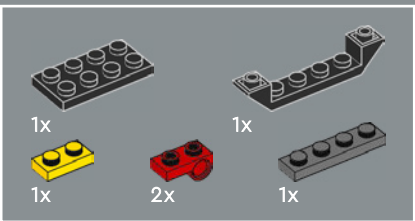
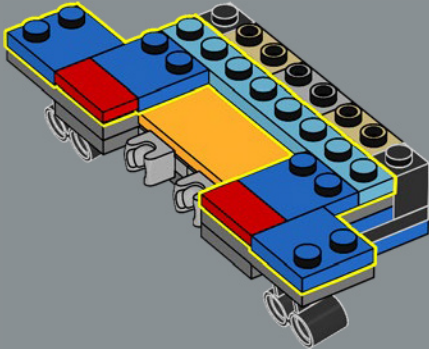

88

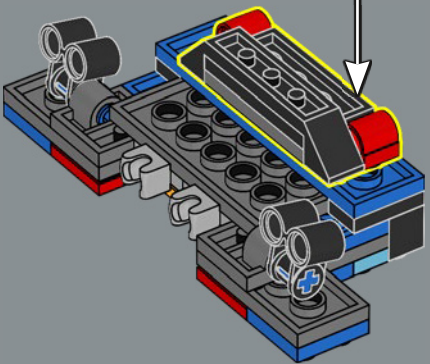
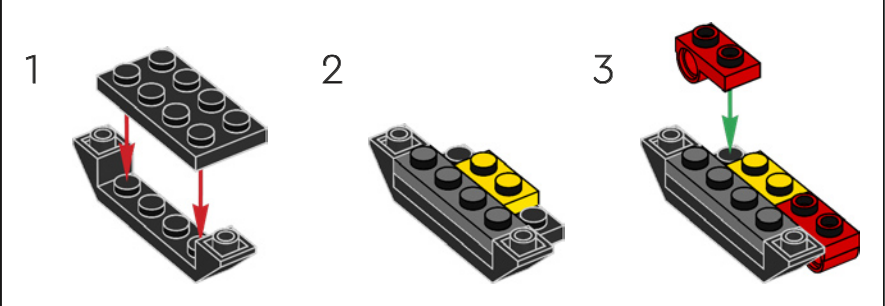

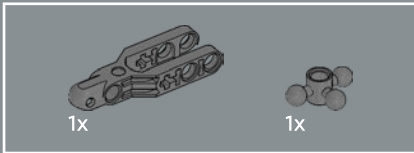
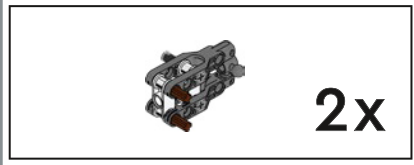
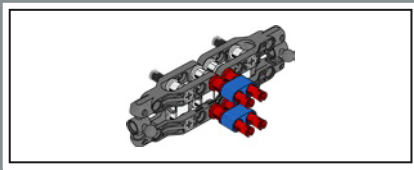

89

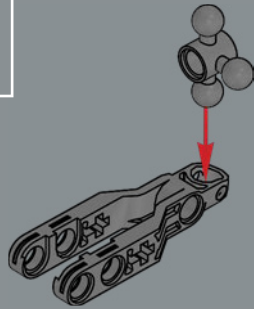

90

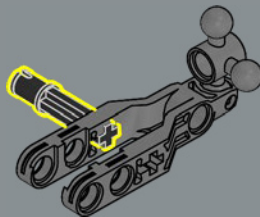

91

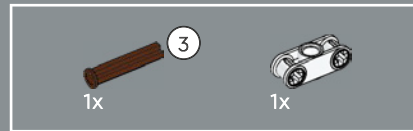
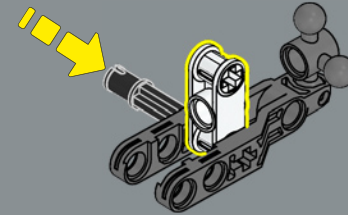

92

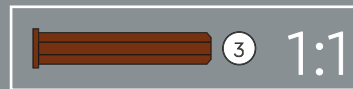
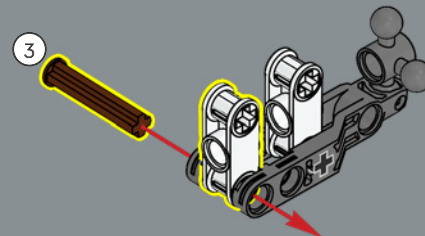



93

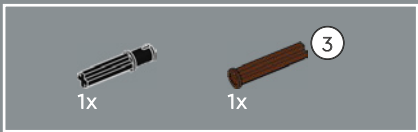
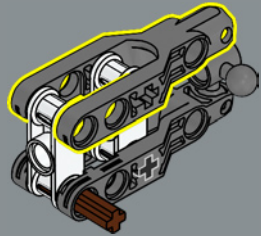

94

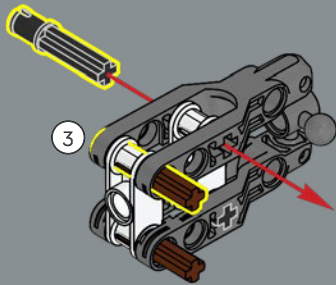

2x



95

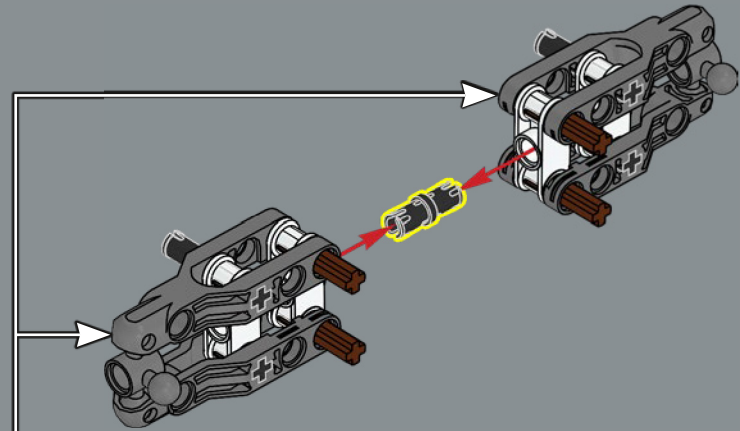





96

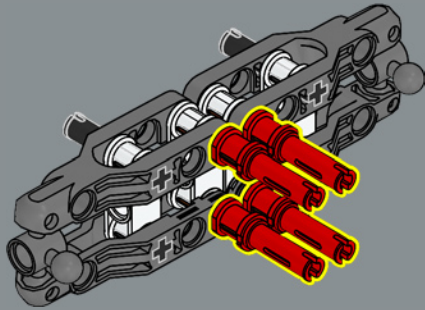

97

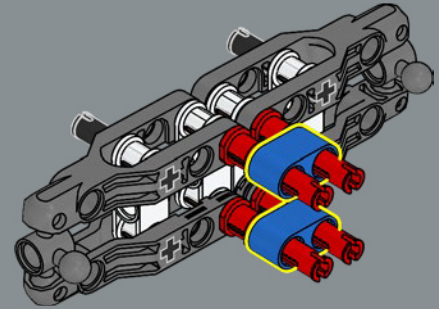

98

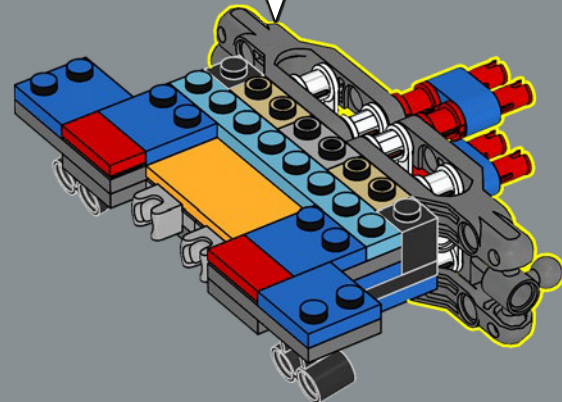

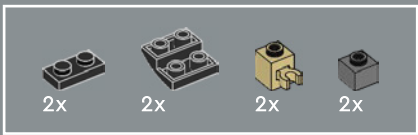

99

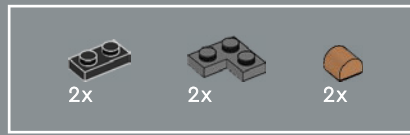
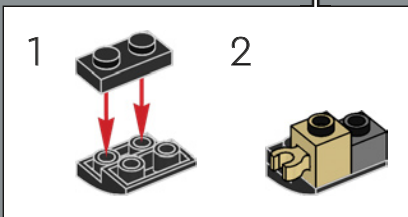
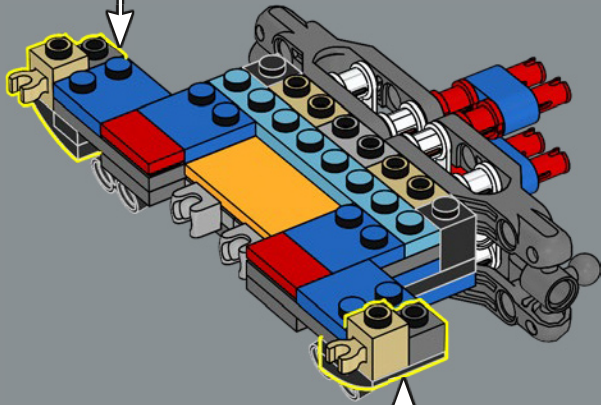
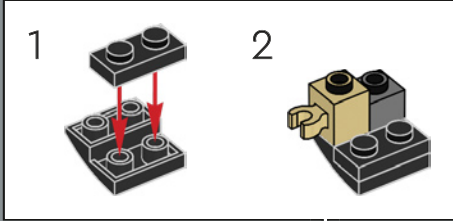

100

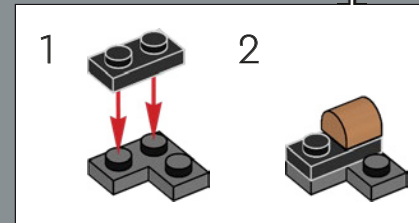
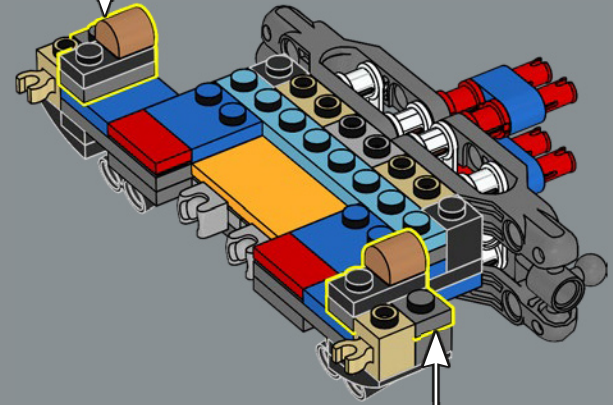
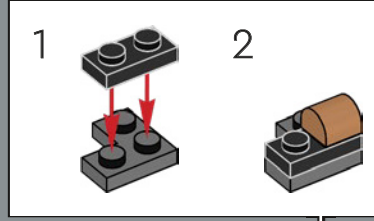



101

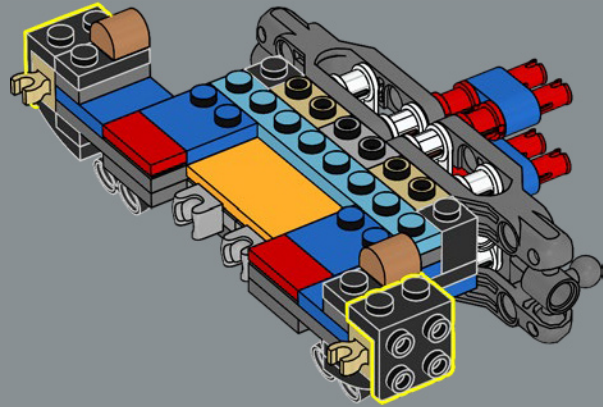

102

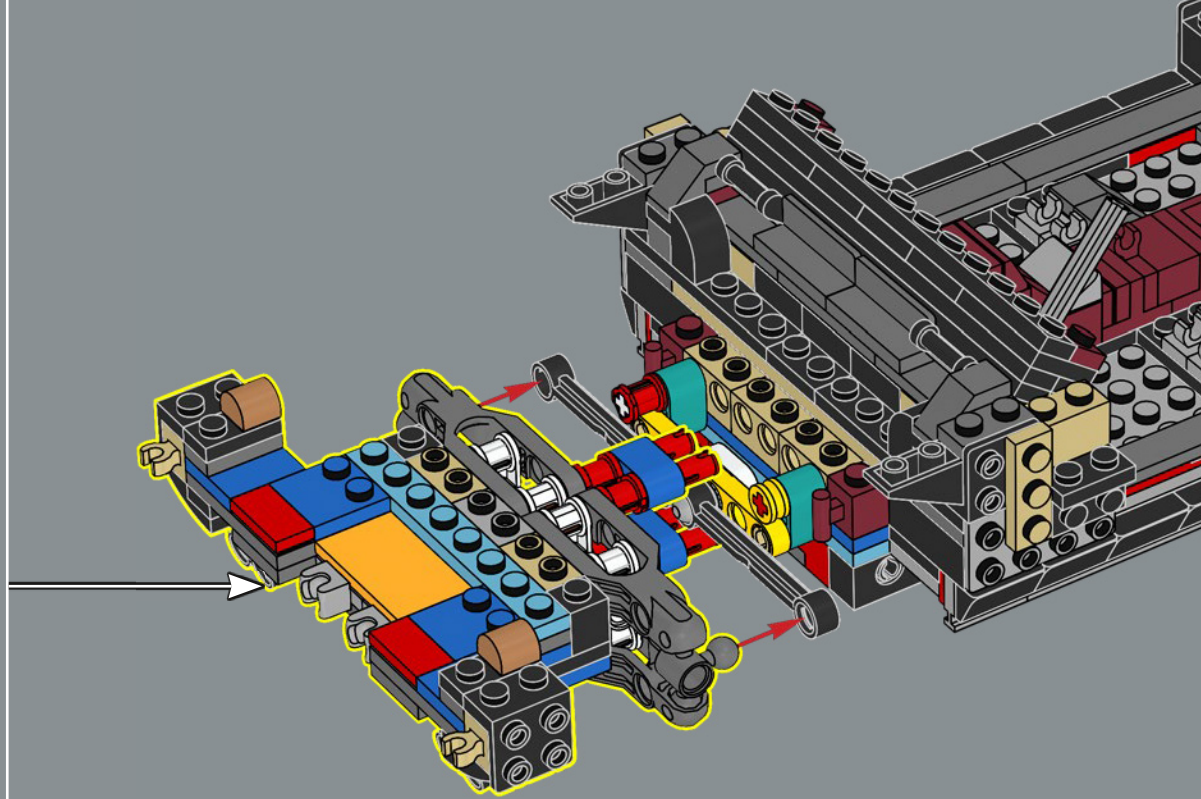

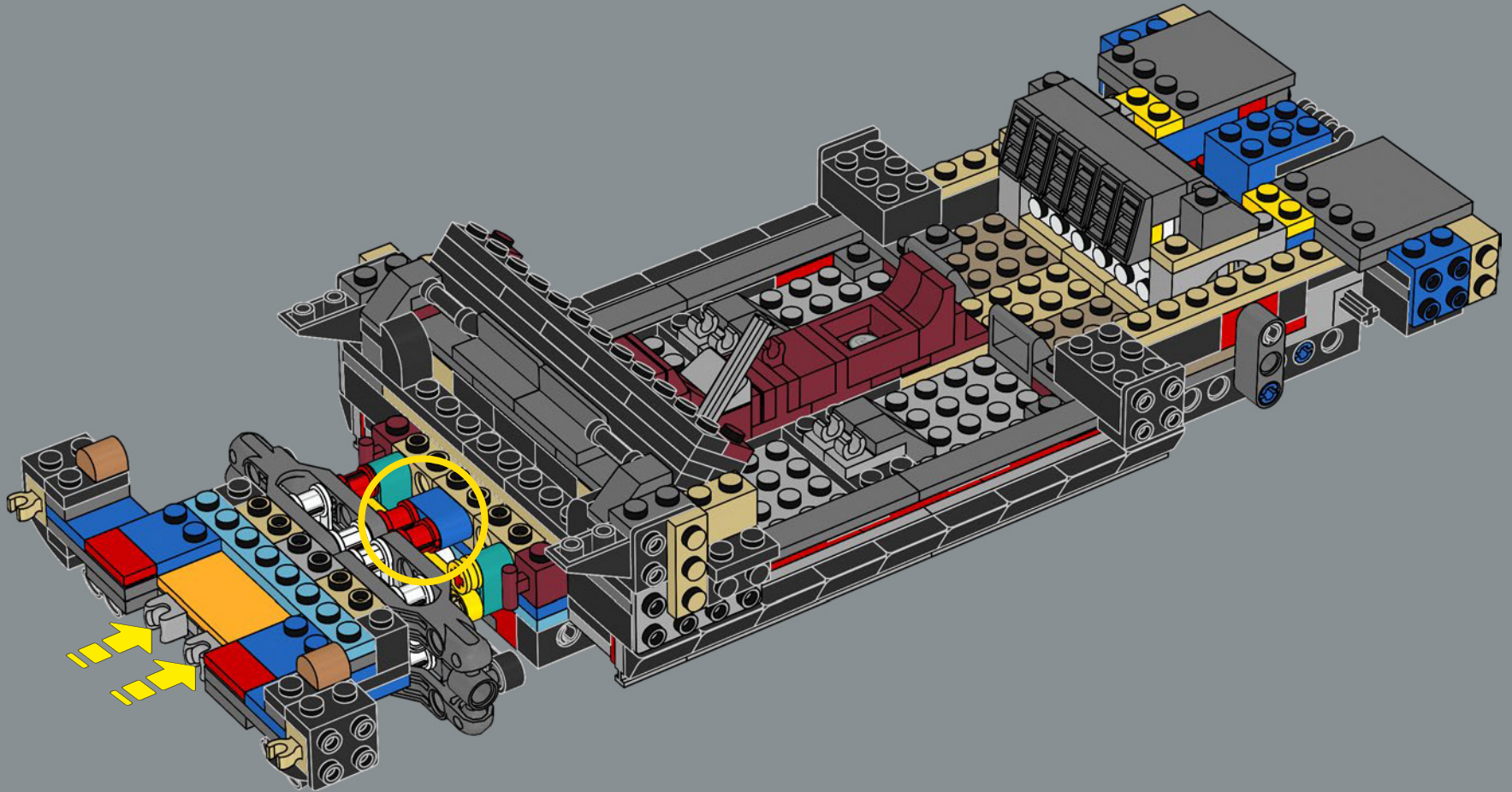

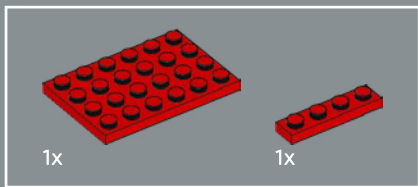

104

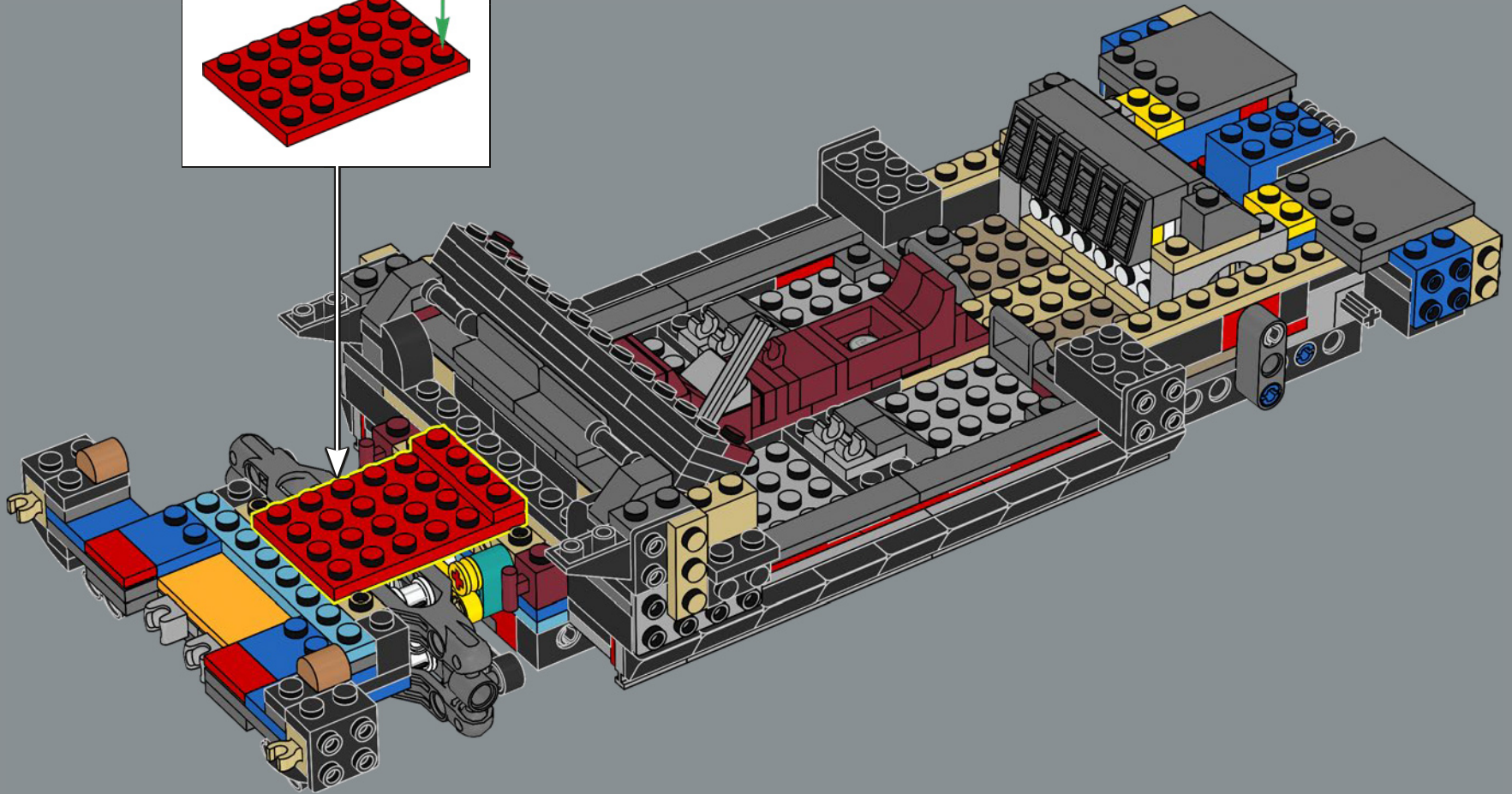
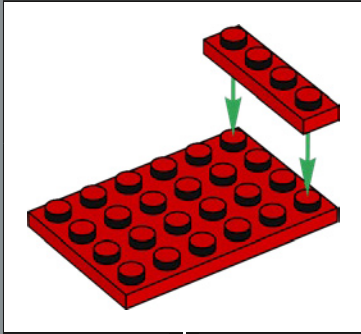

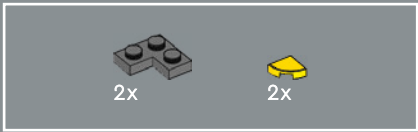

105

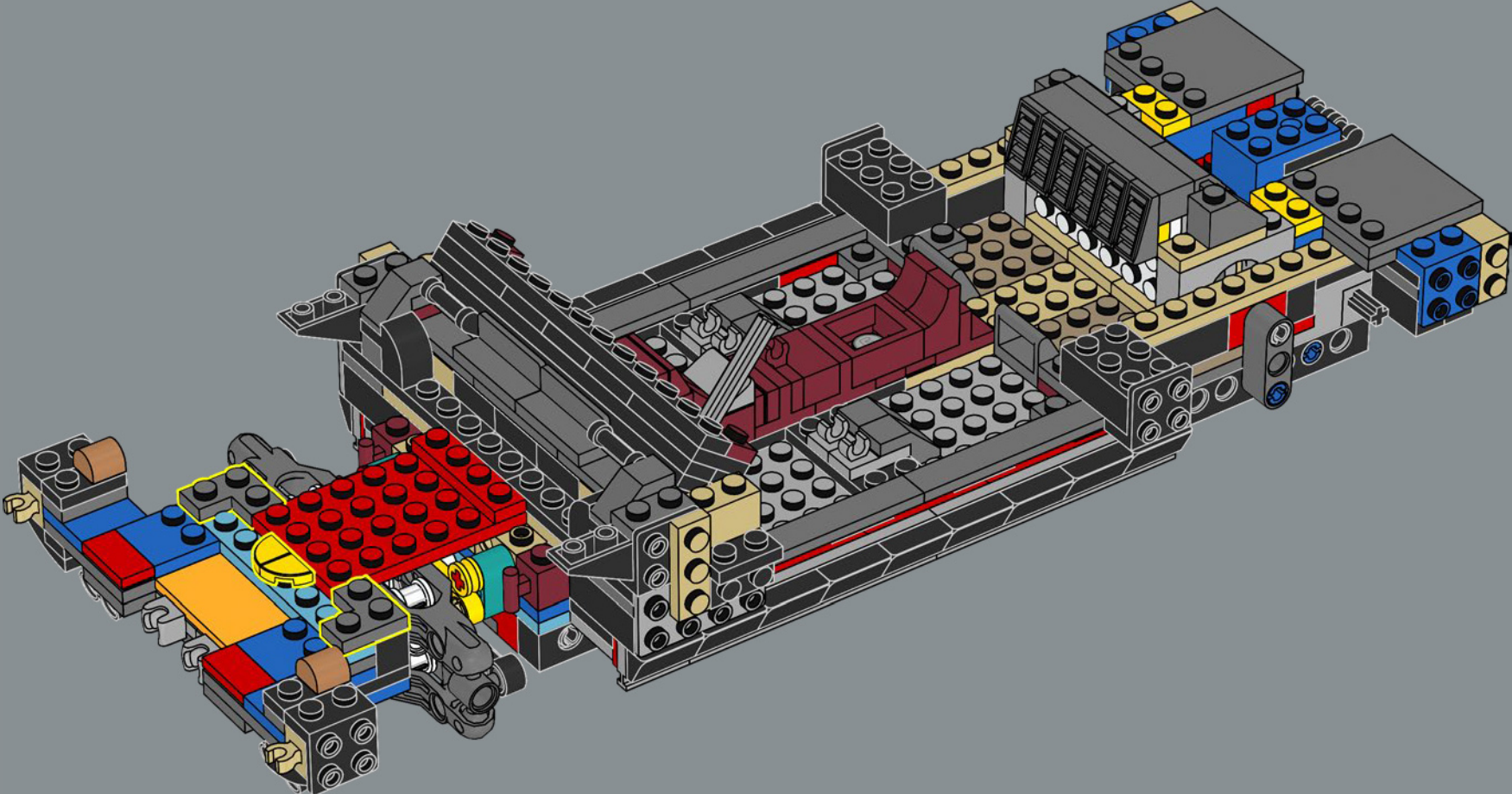

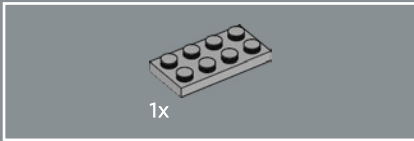
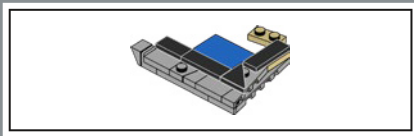

106

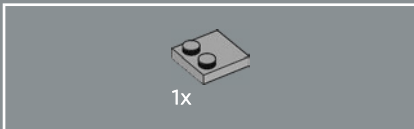
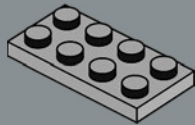

107

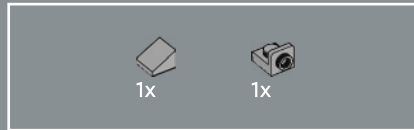
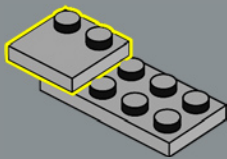

108

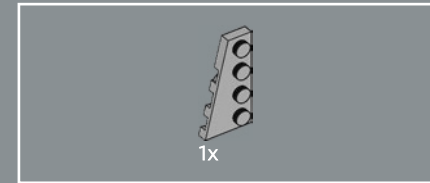
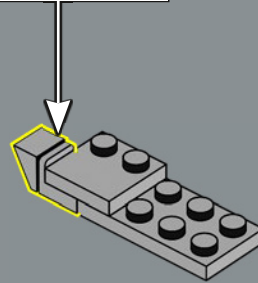
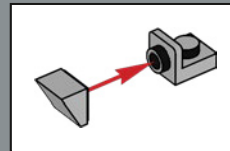

109

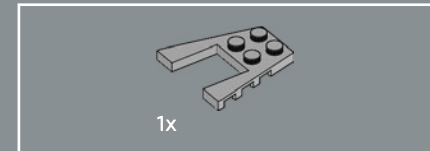
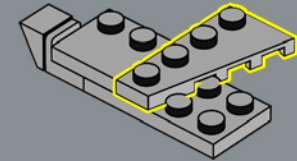

110

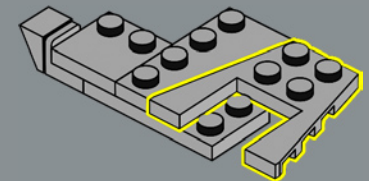

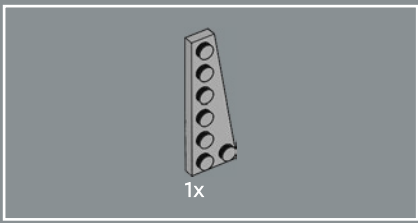

111

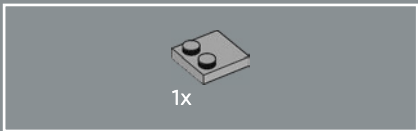
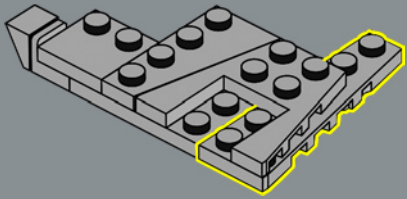

112

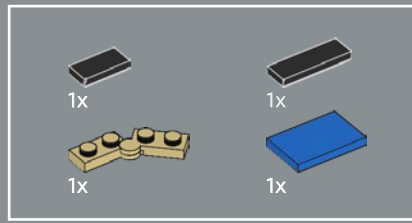
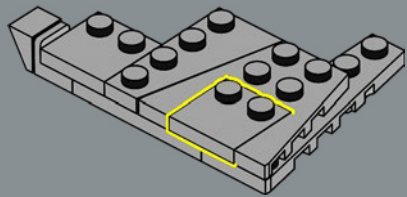

113

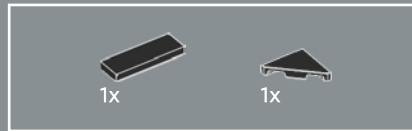
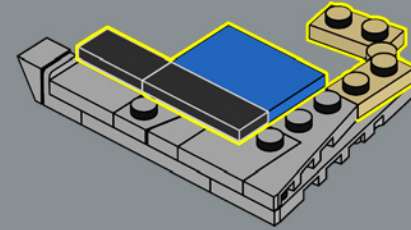

114

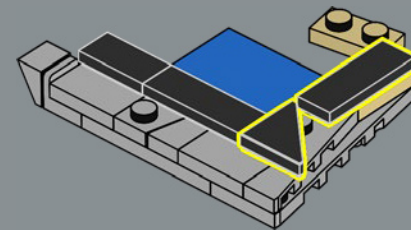



115

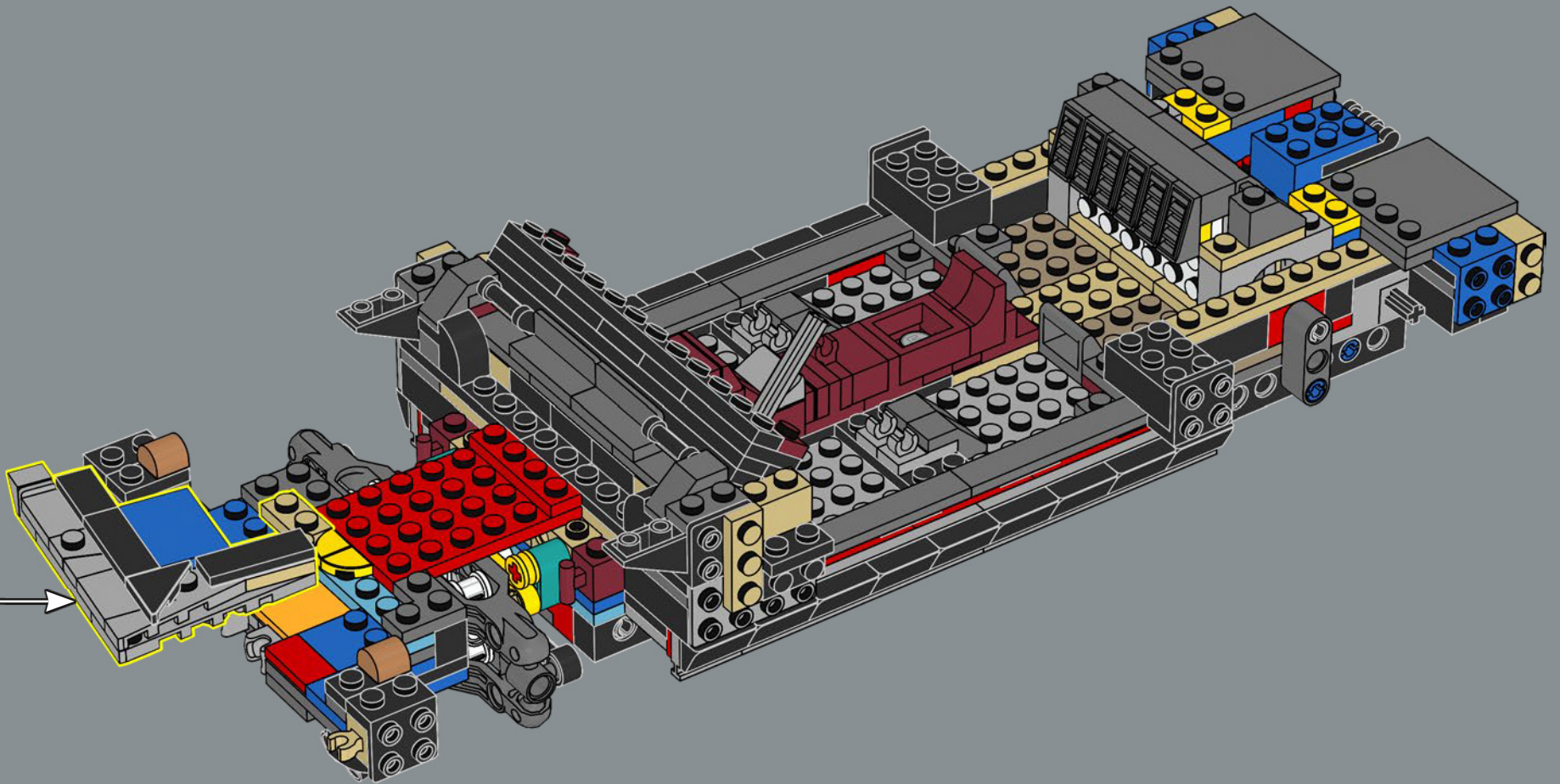

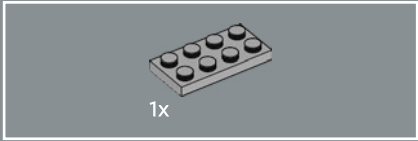
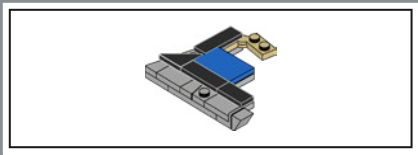

1x

116

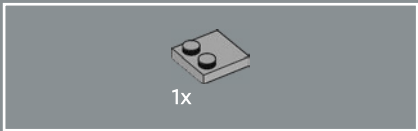
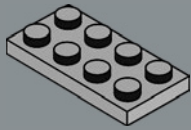

1x

117

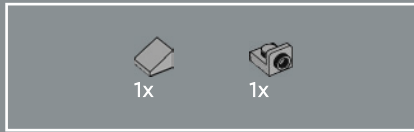
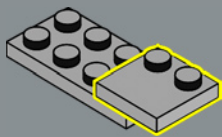

1x

1x

118

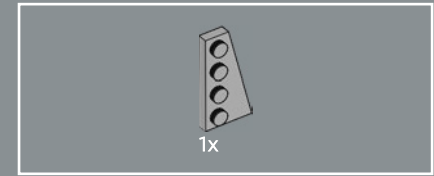
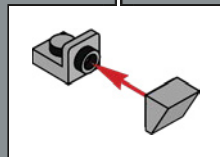
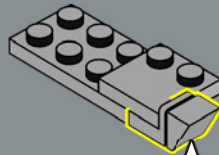

1x

119

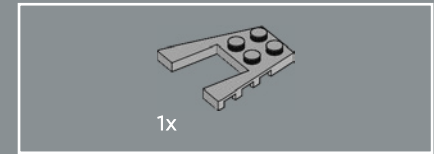
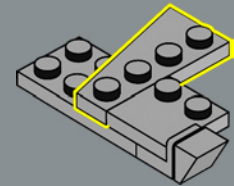

1x

120

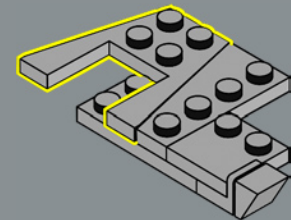

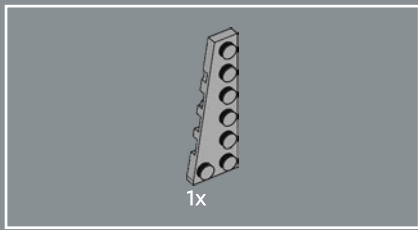

121

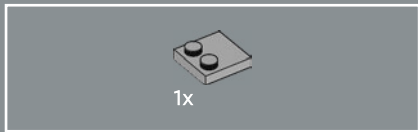
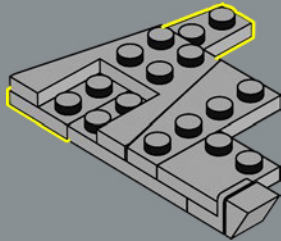

122

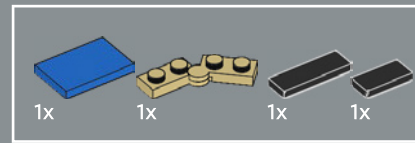
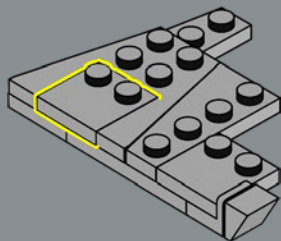

123

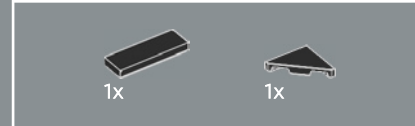
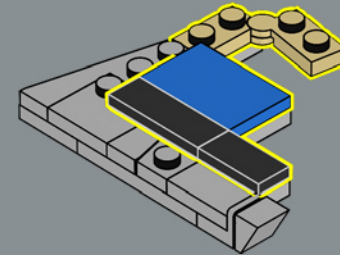

124

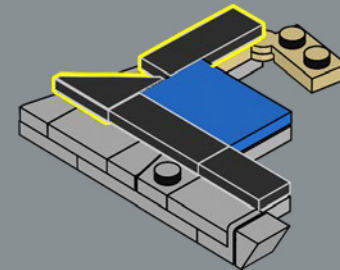

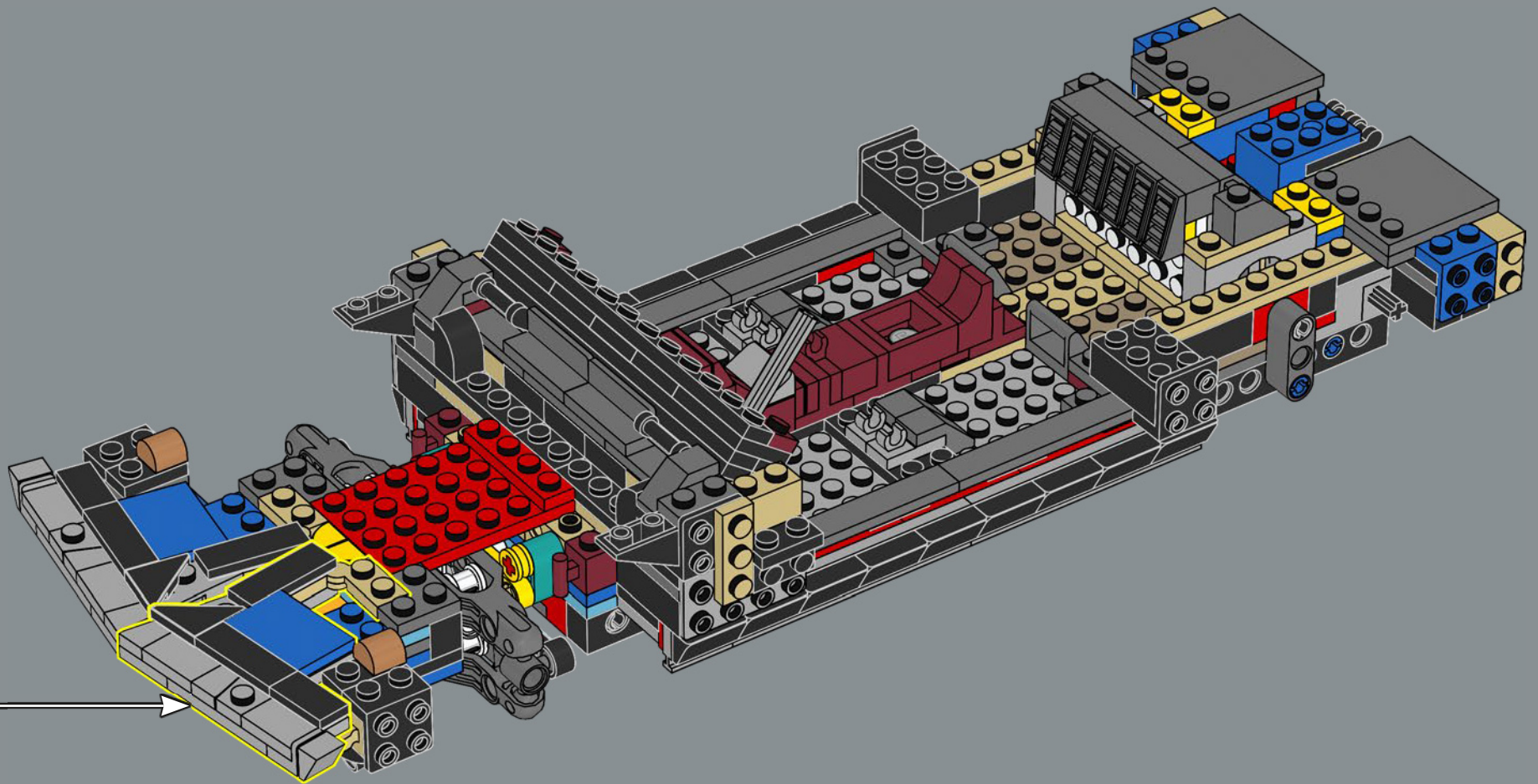

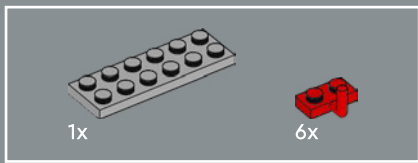

126

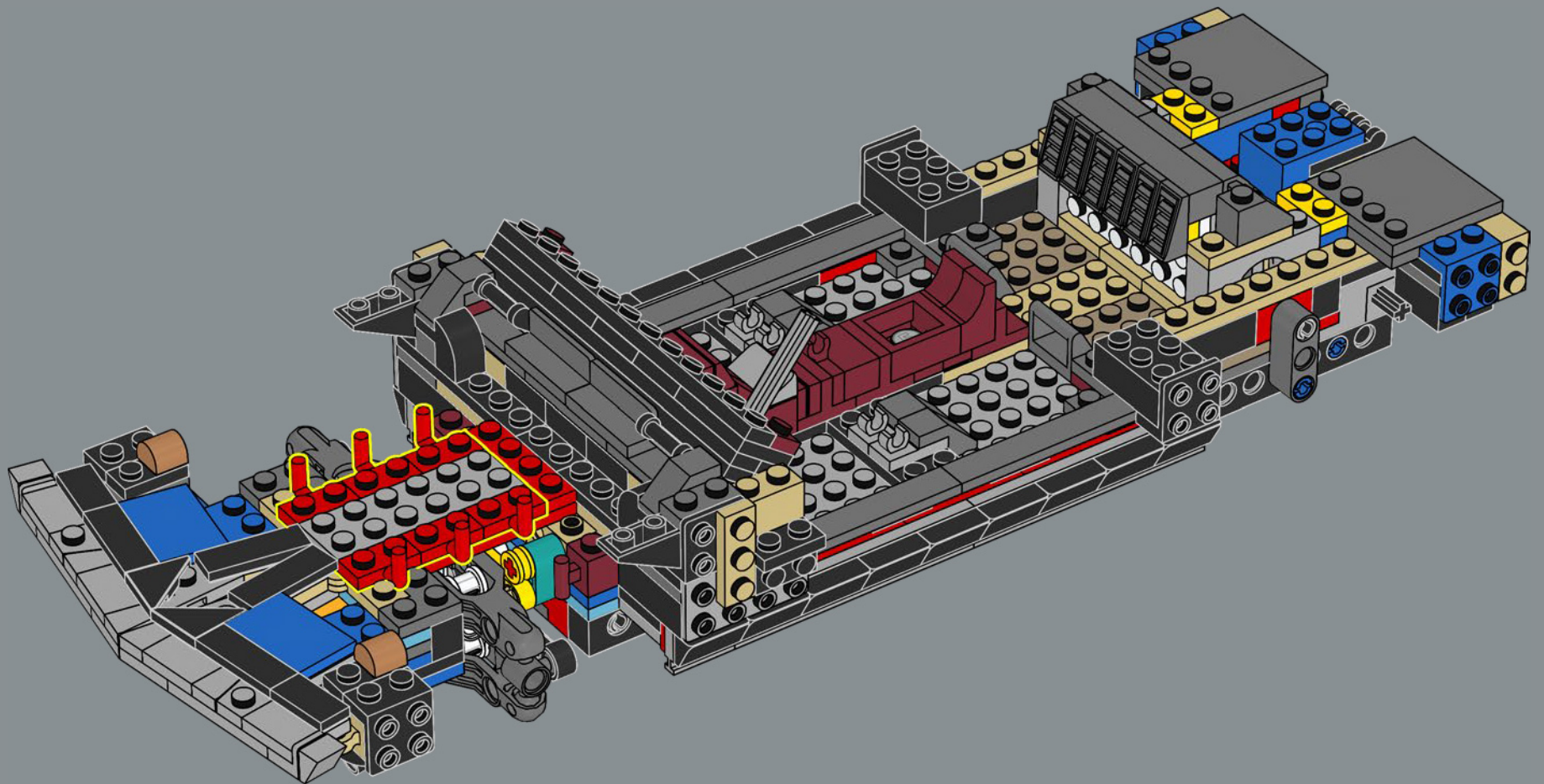

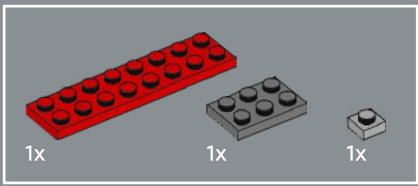

127

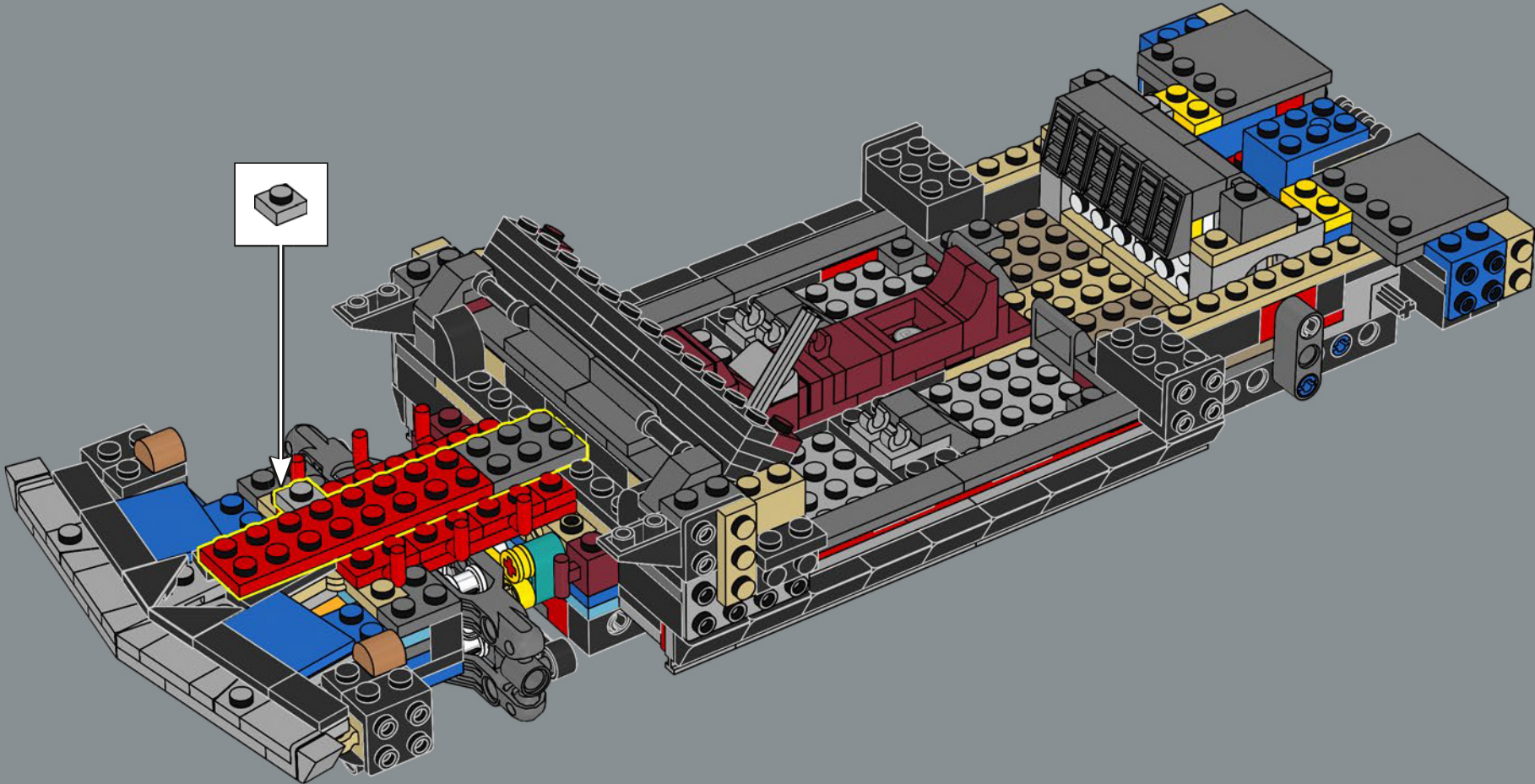

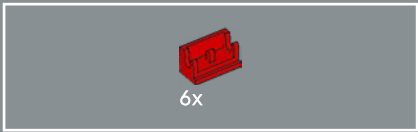

128

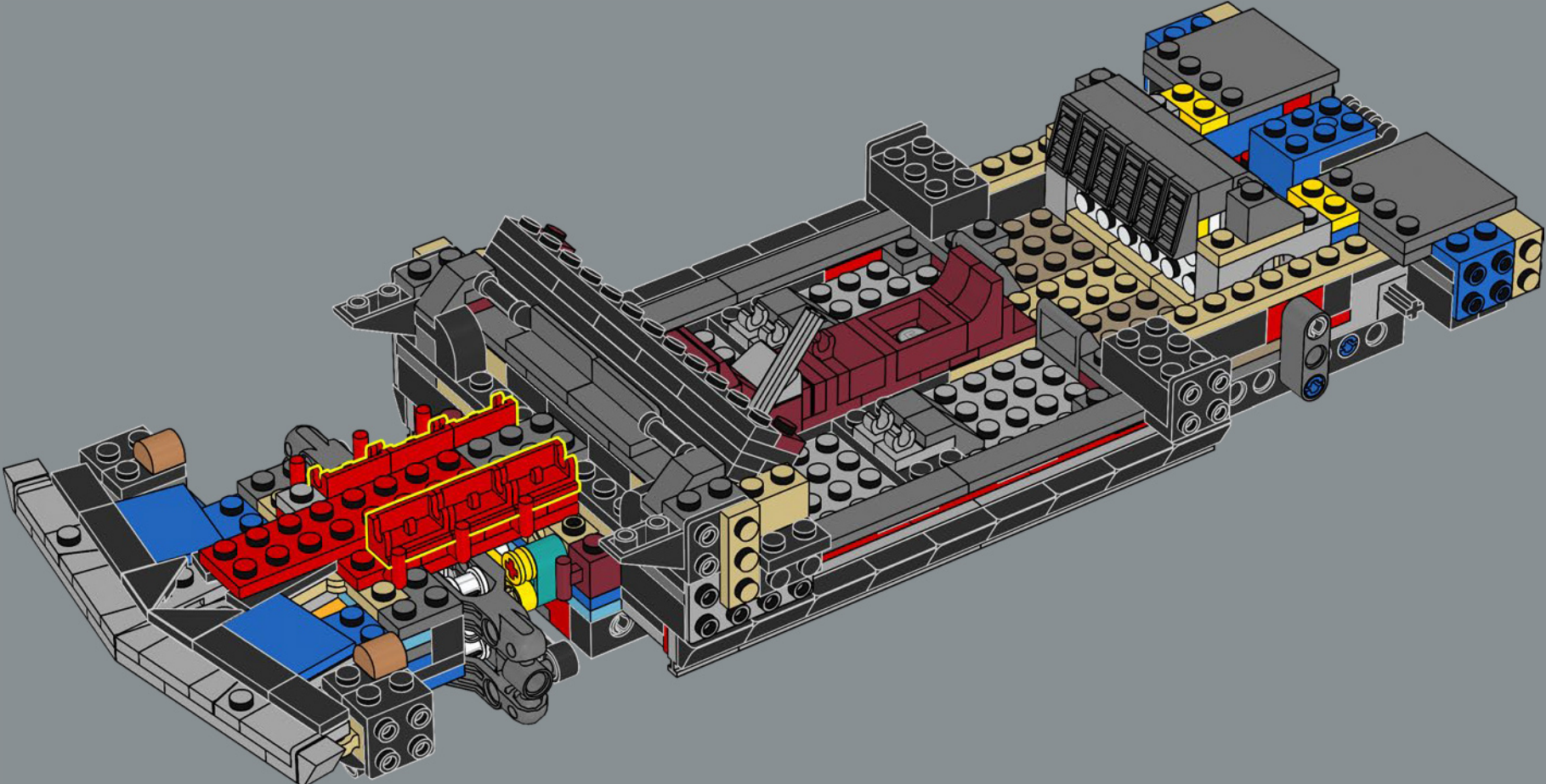

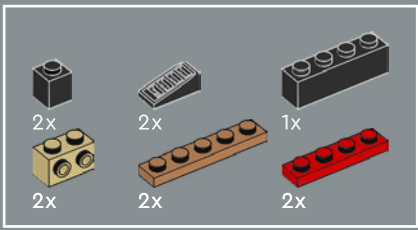

# 129

1

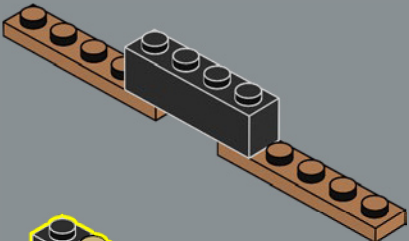

2

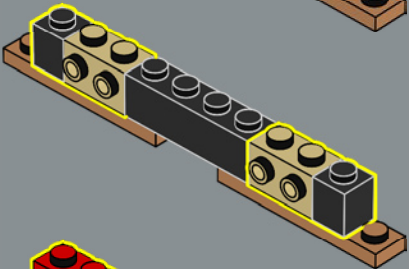

3

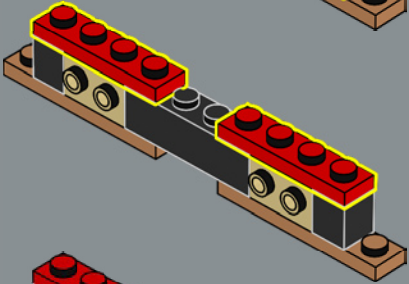

4

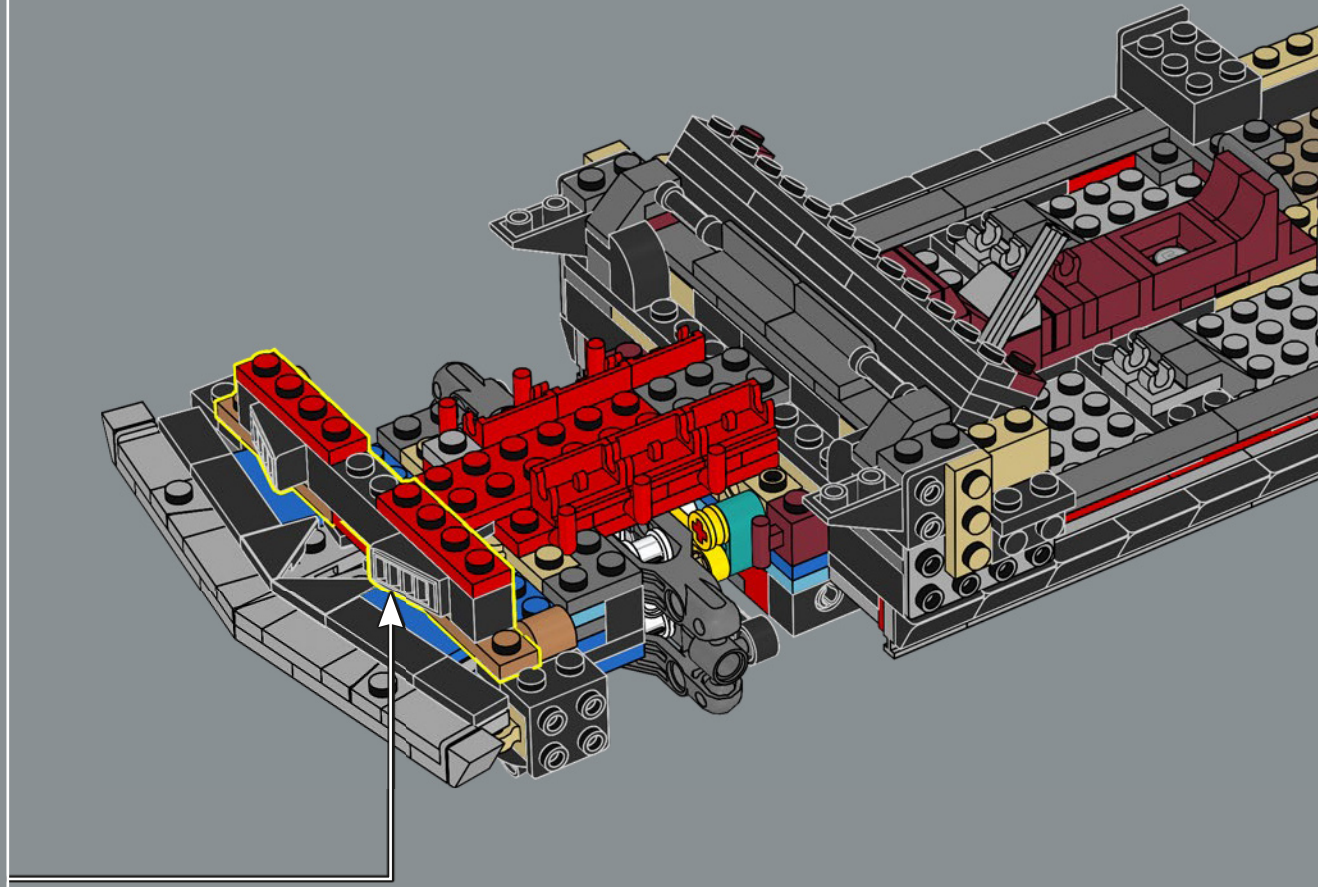
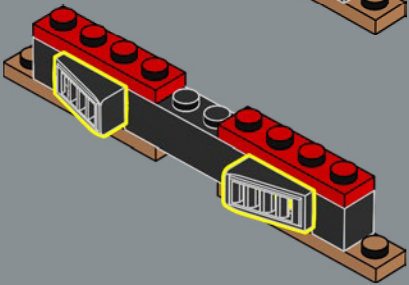



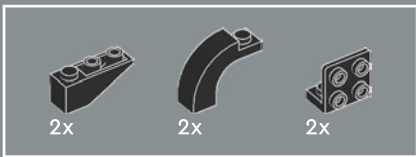

130

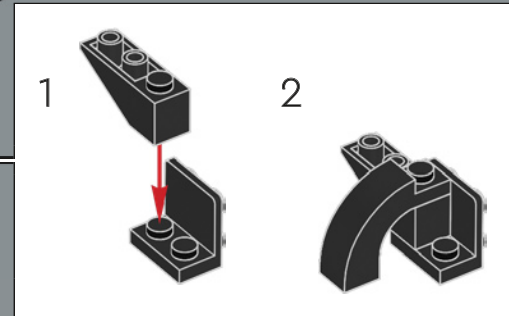
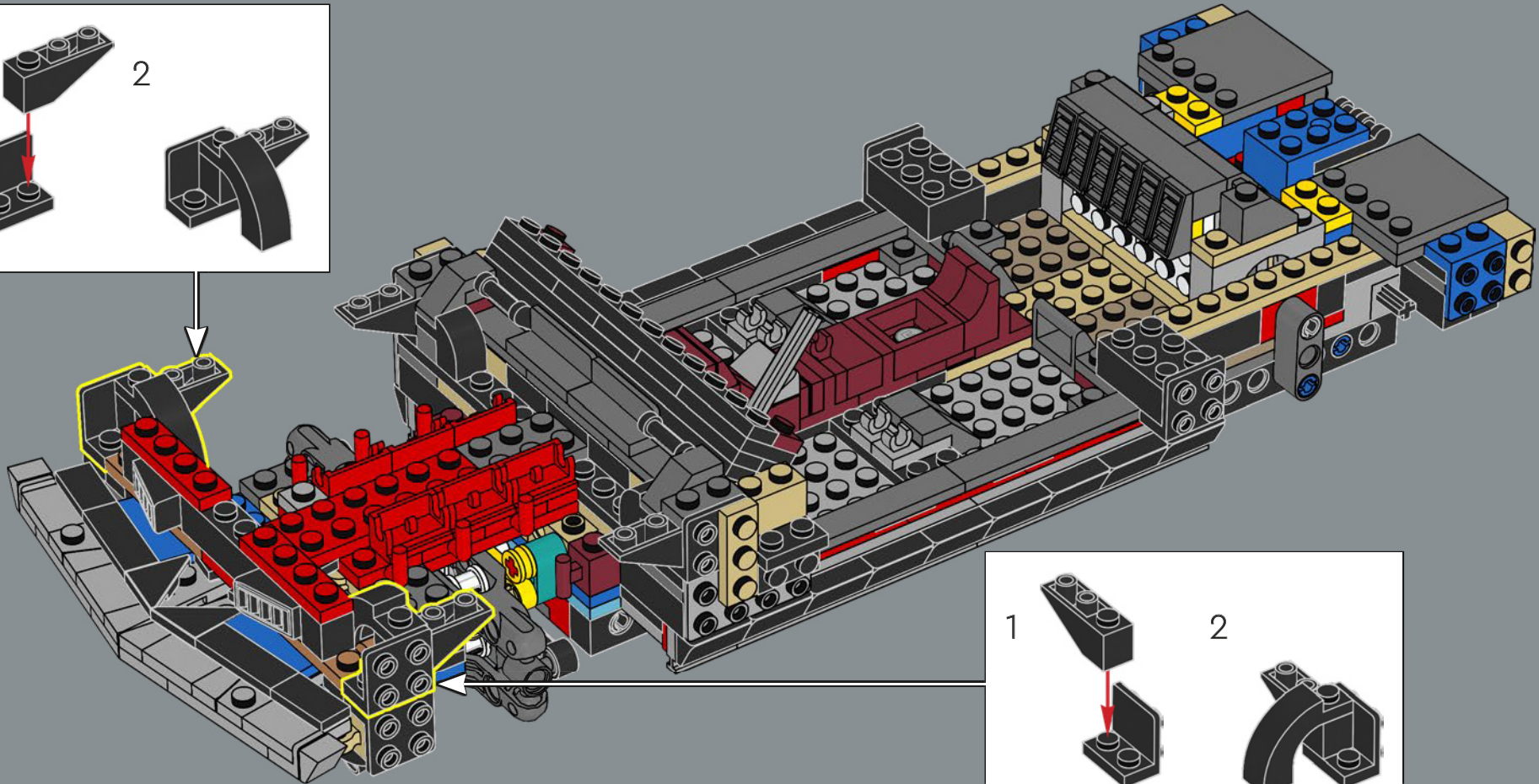
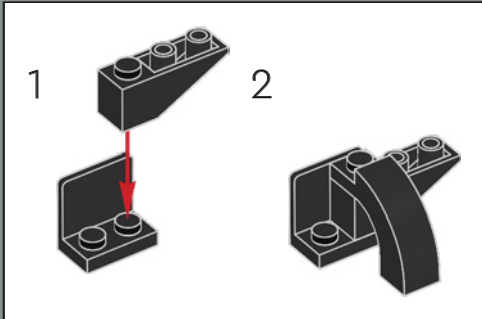

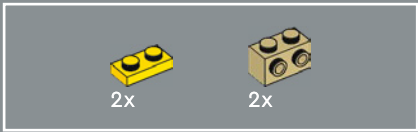

131

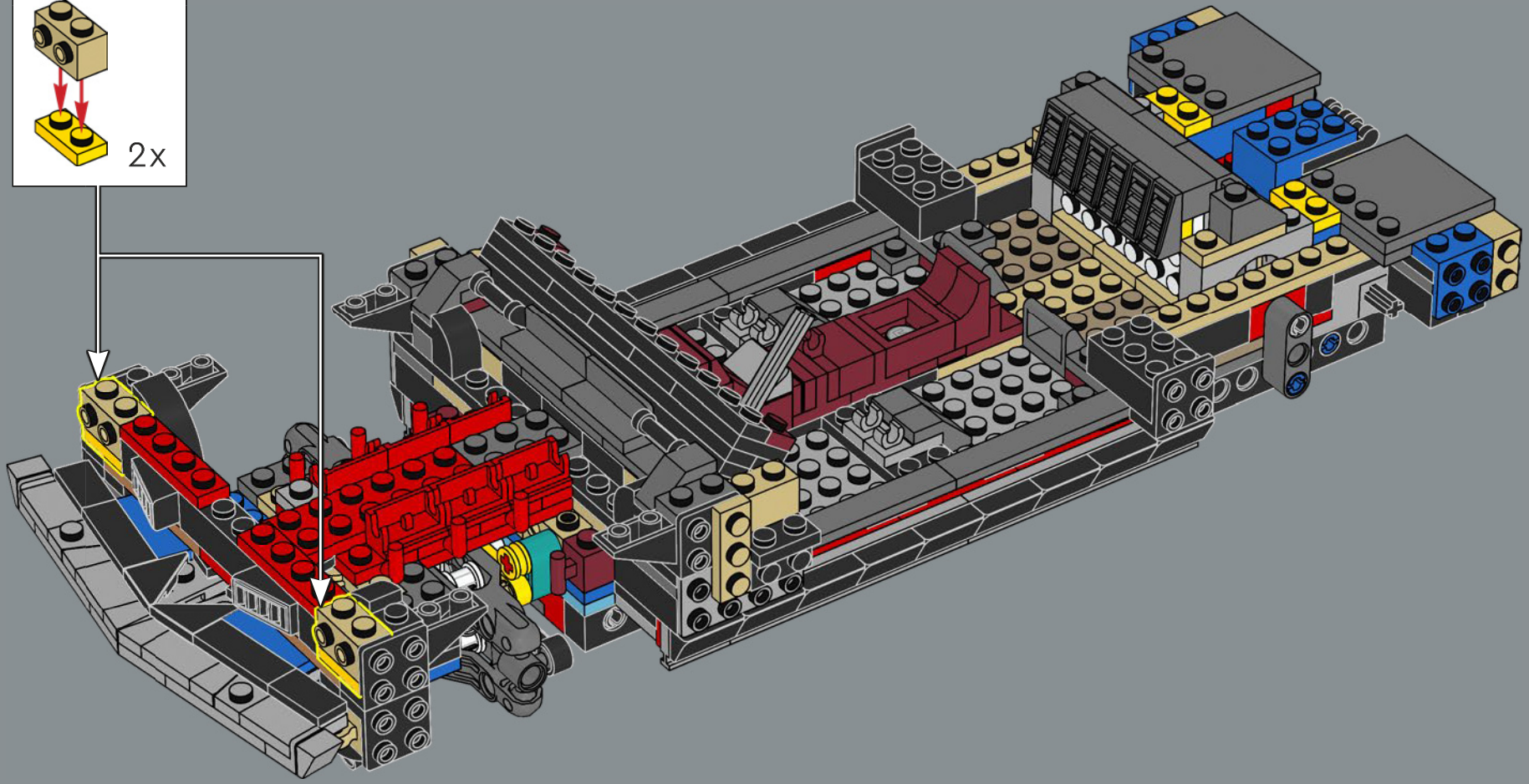
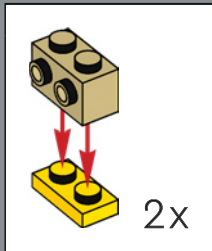

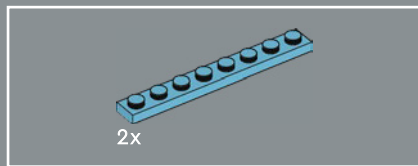

132

1966年，雪佛兰 Camaro 向媒体揭幕，这是世界上第一次大型电话会议，来自美国 14 个城市的 200 多名记者参加了会议。

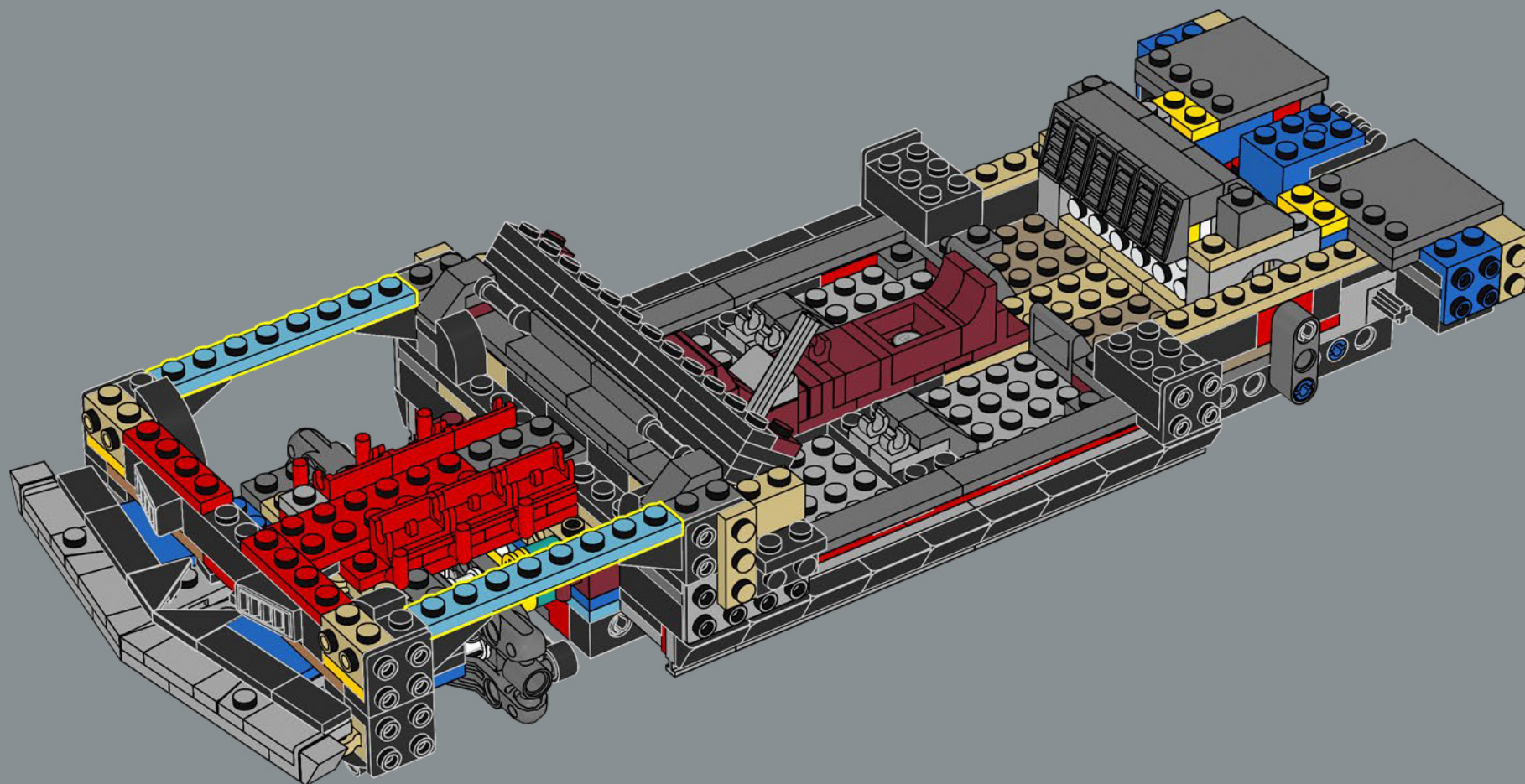



133

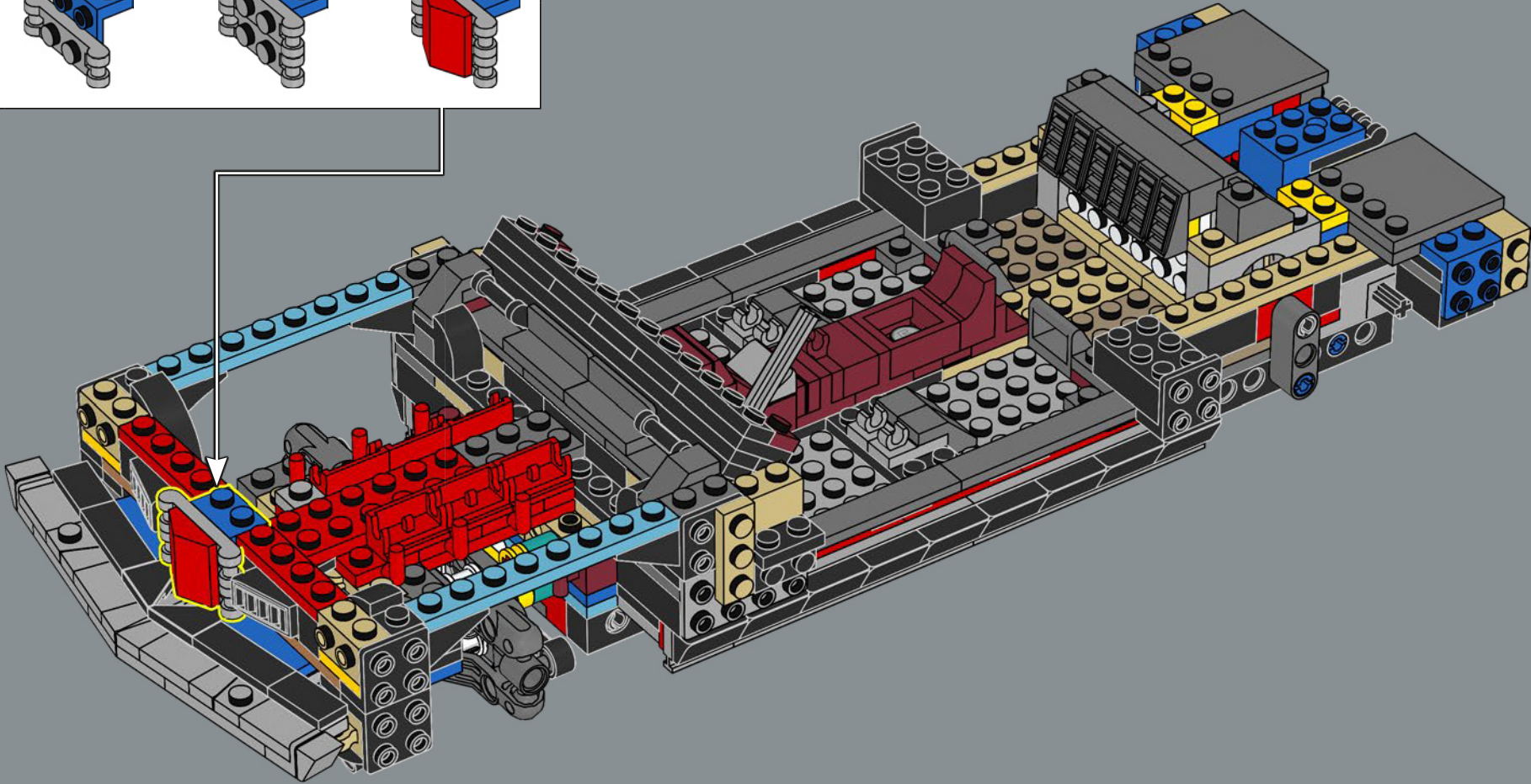
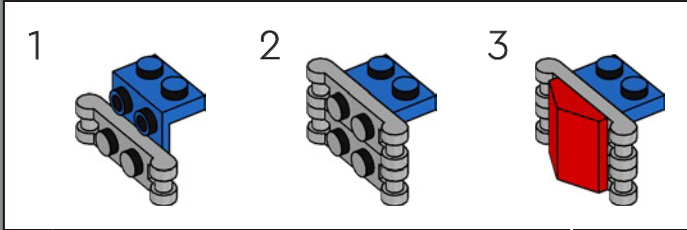



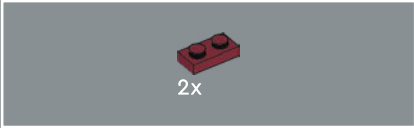
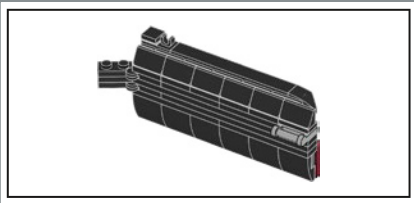

135

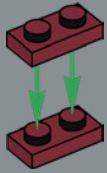

136

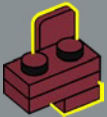

137

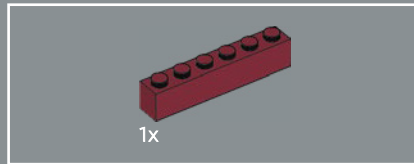
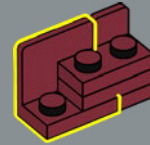

138

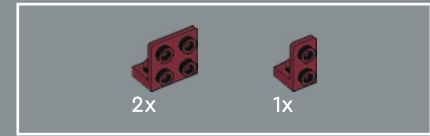
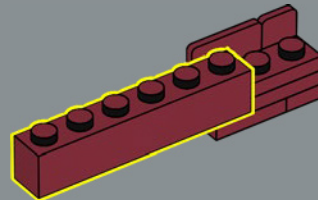

139

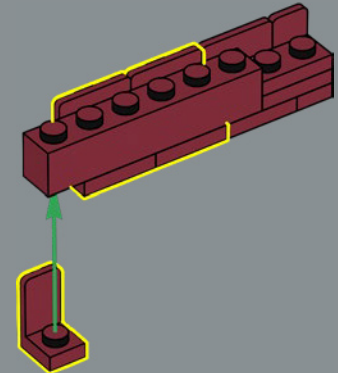



140

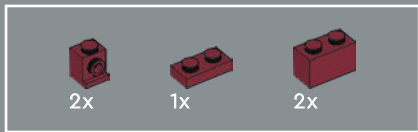
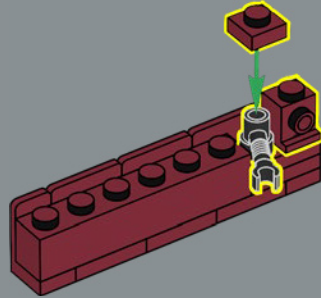

141

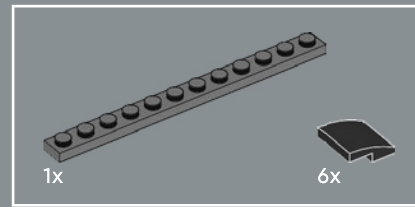
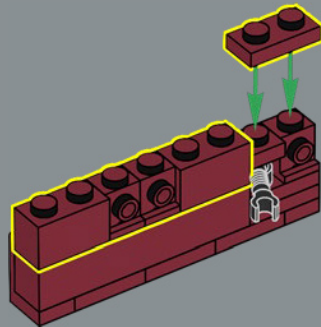

142

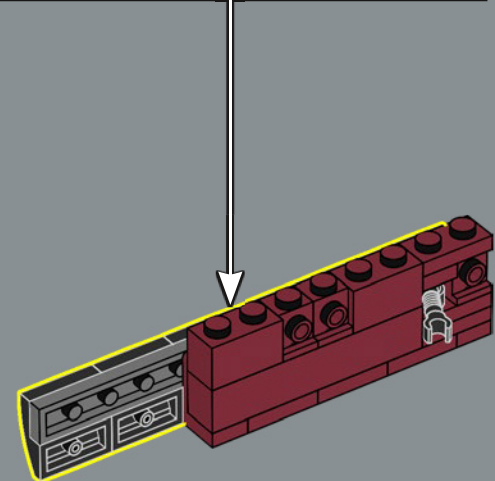
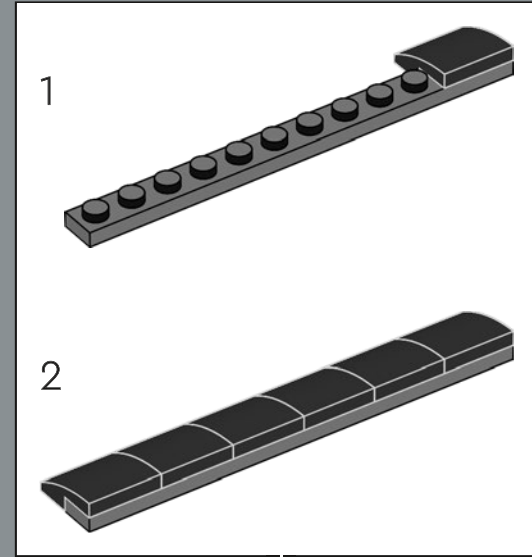

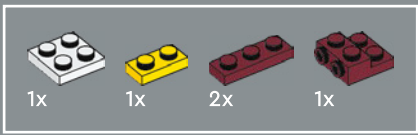

143

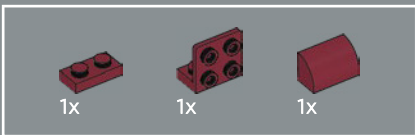
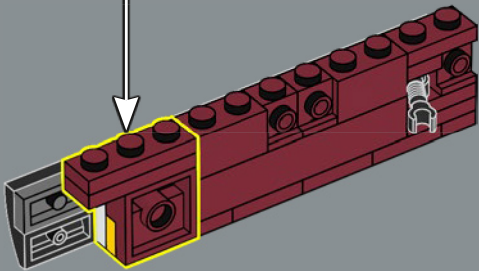
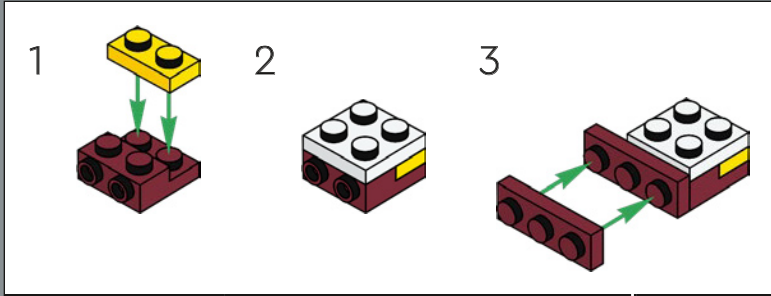

144

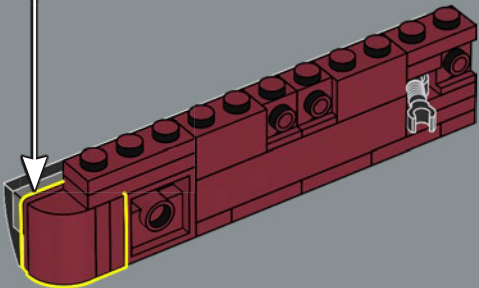
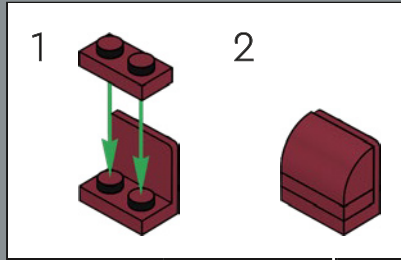



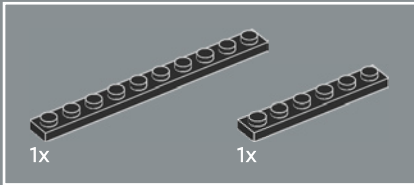
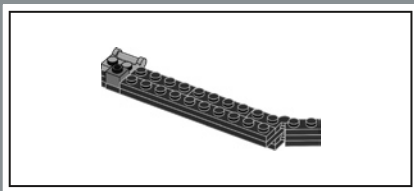

145

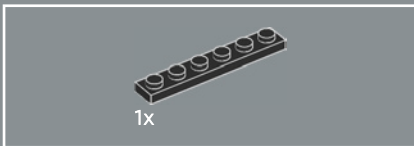
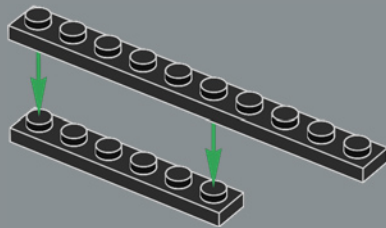

146

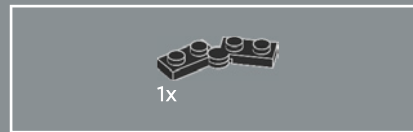
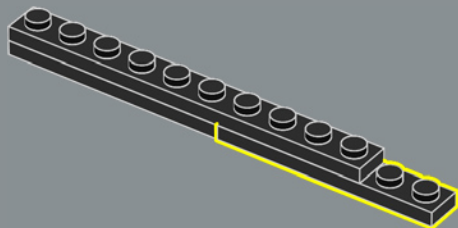

147

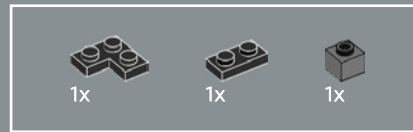
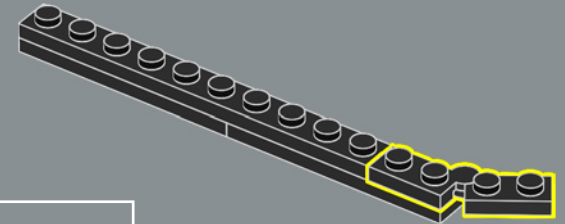

148

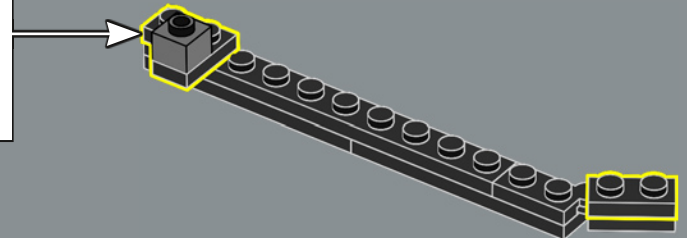
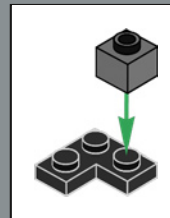

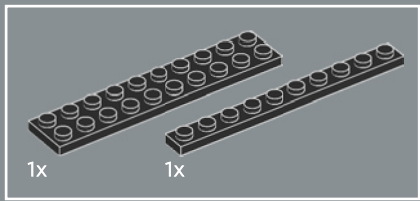

149

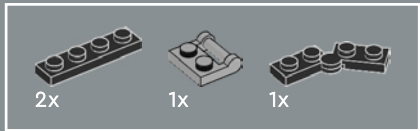
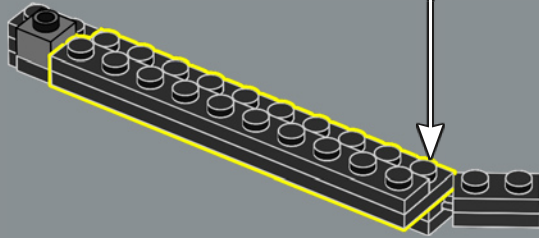
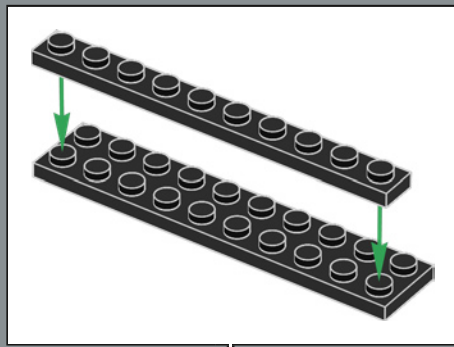

150

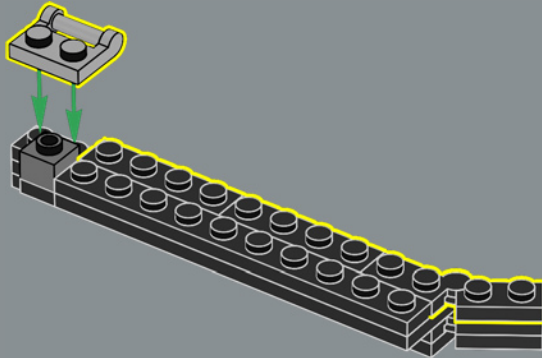

151

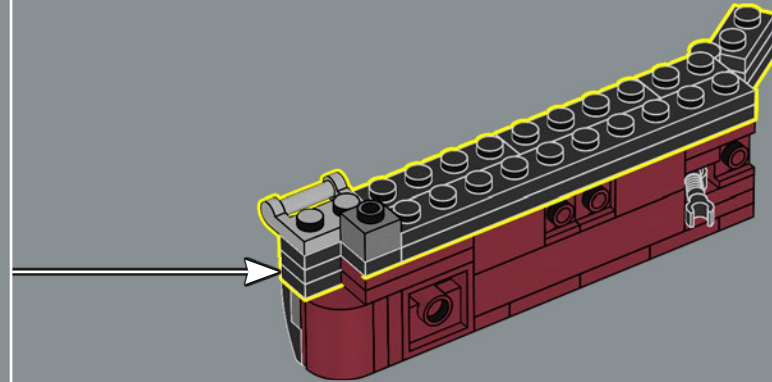

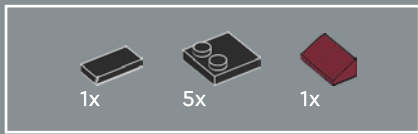

152

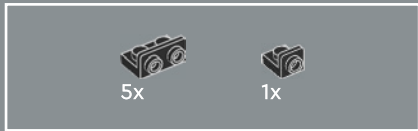
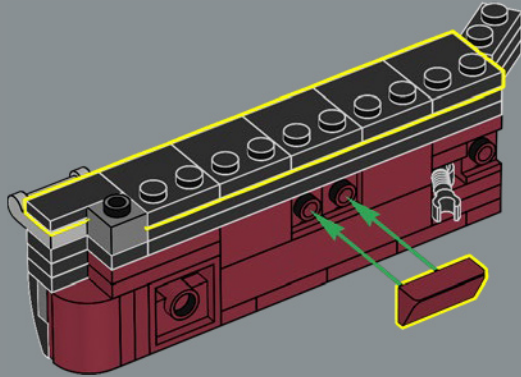

153

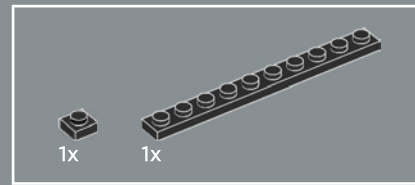
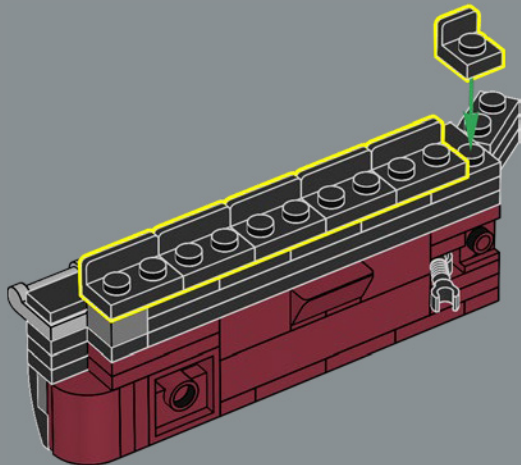

154

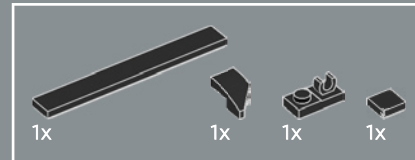
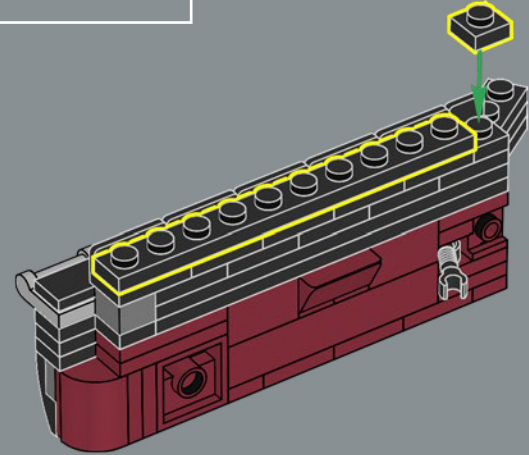

155

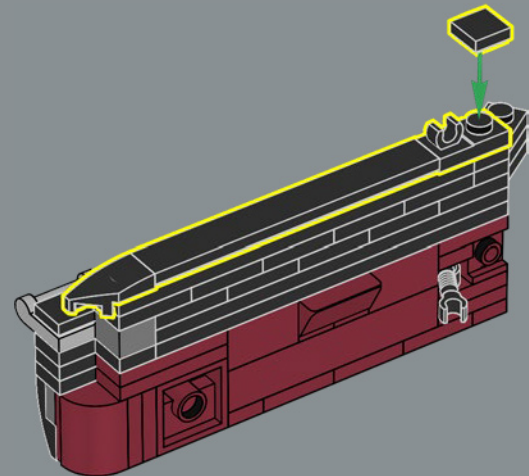



6x

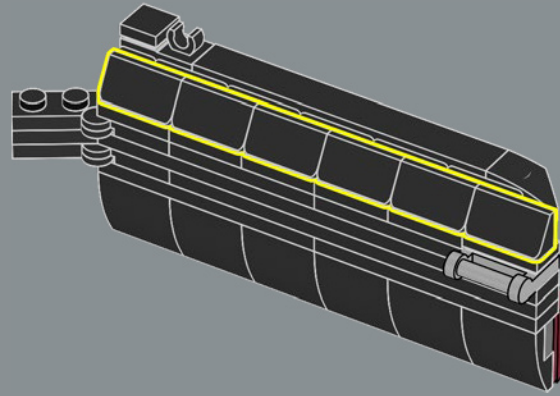

156

157

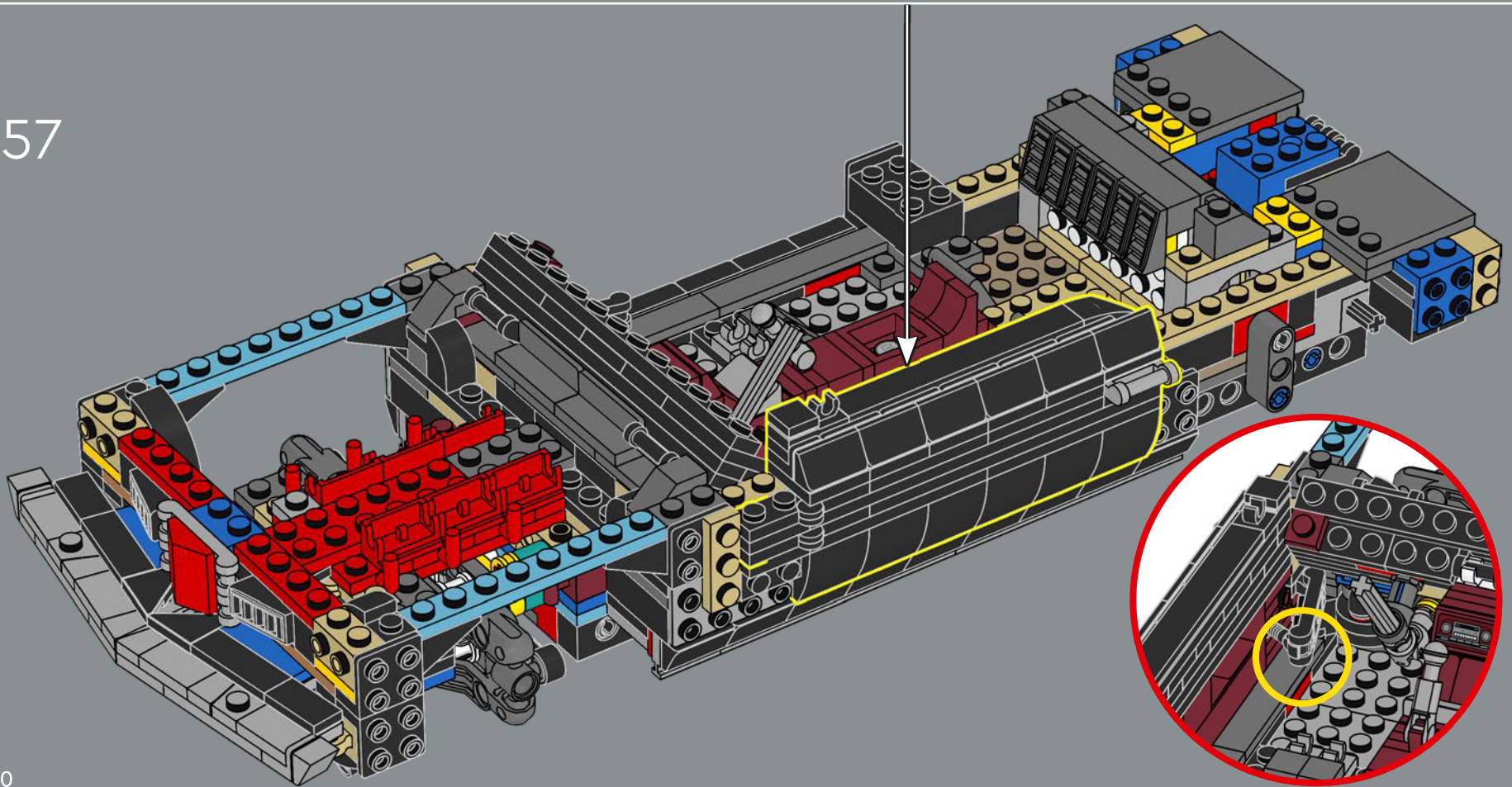



158

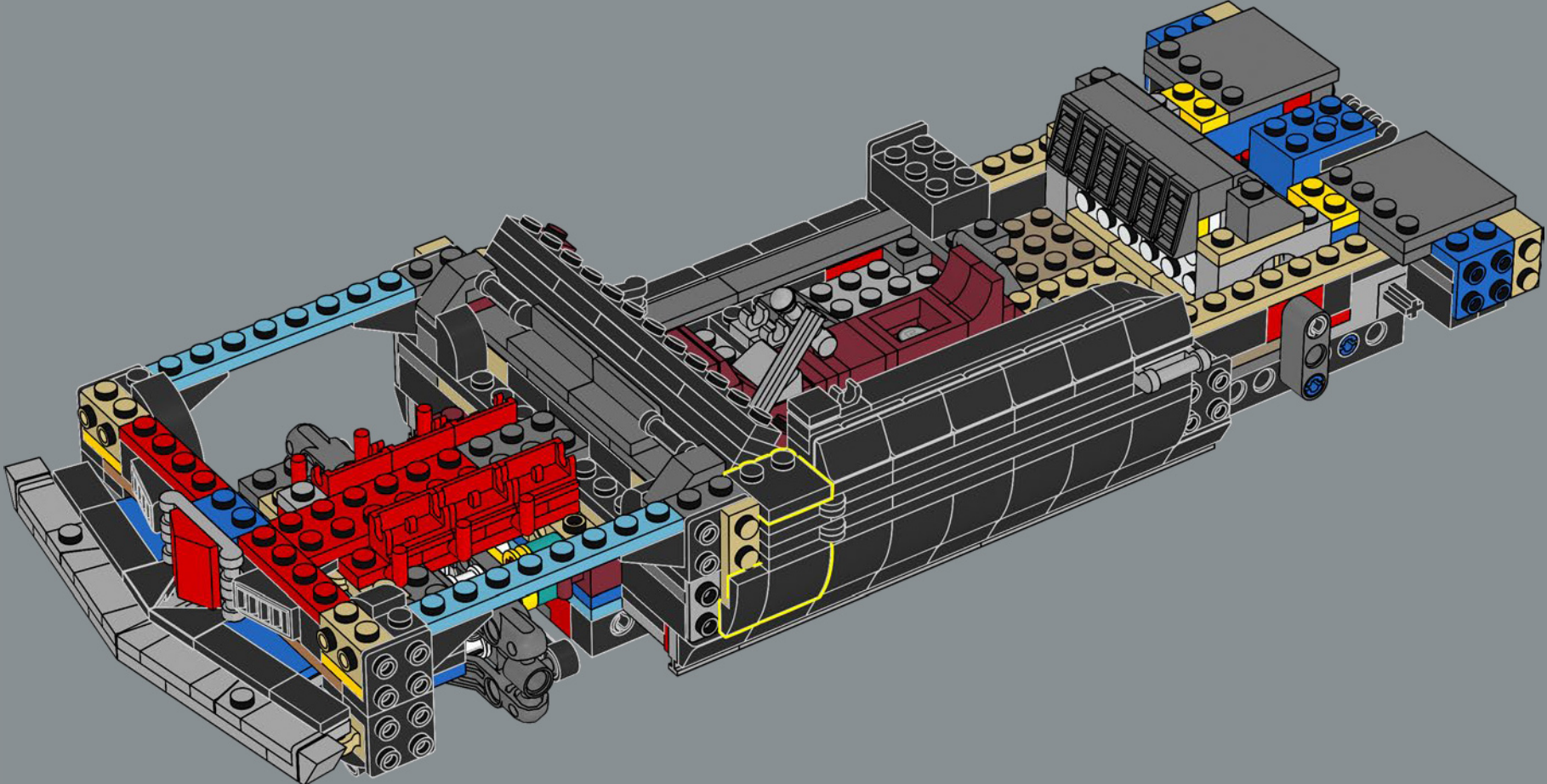

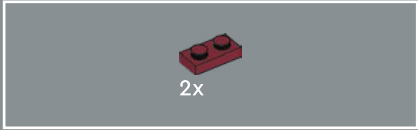
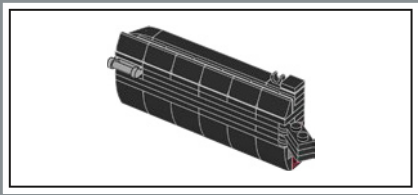

159

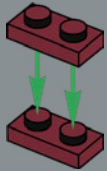

160

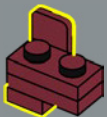

161

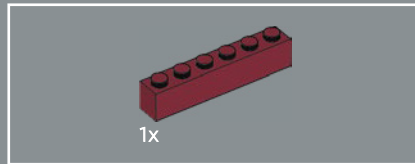
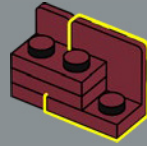

162

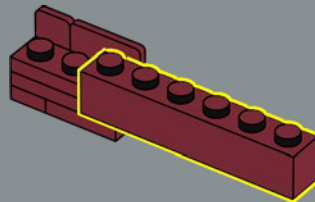

163

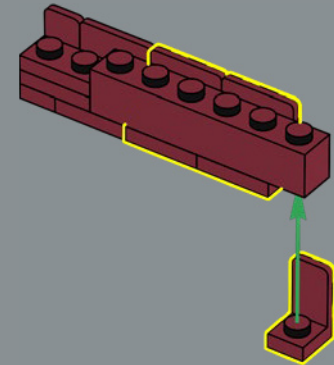



164

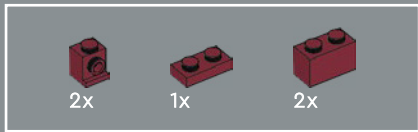
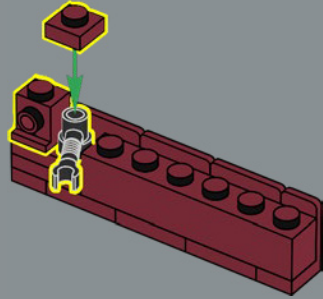

165

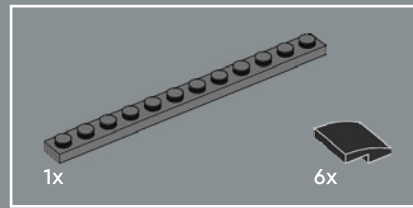
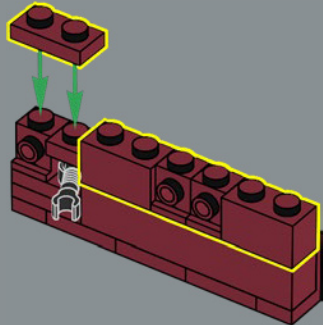

166

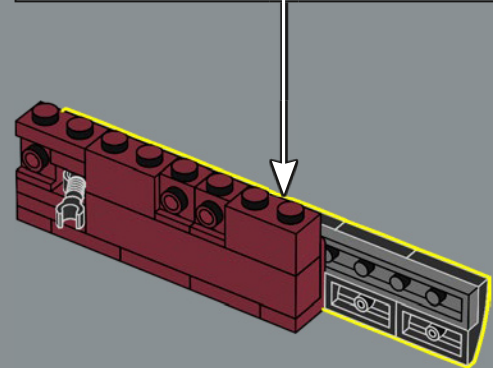
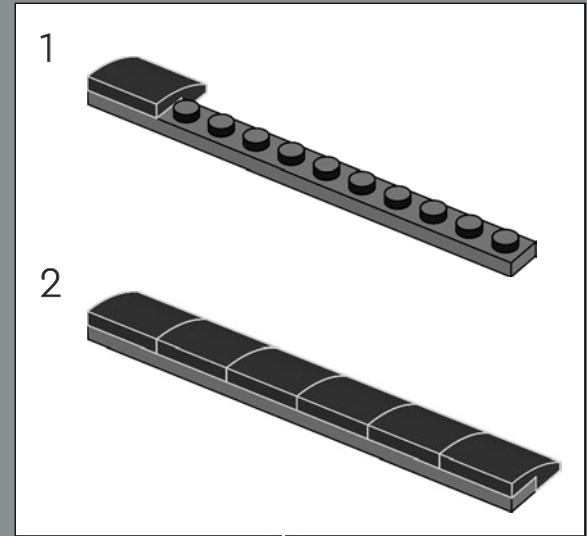

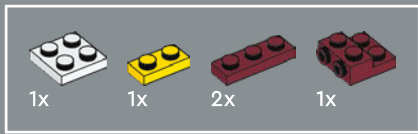

167

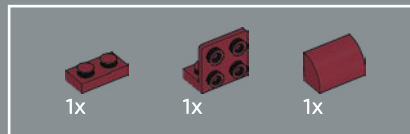
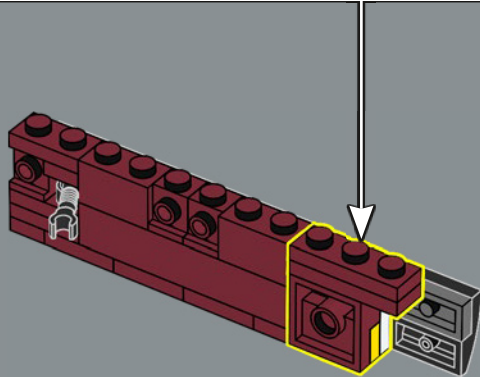
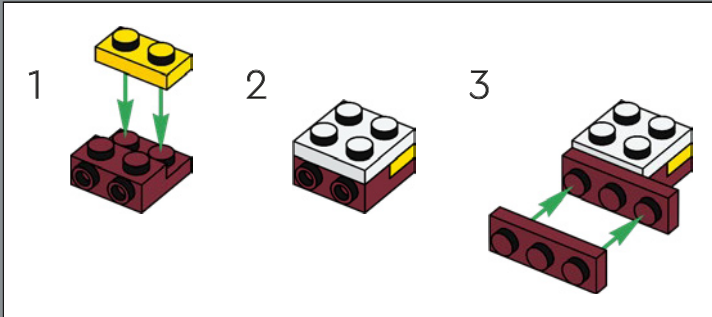

168

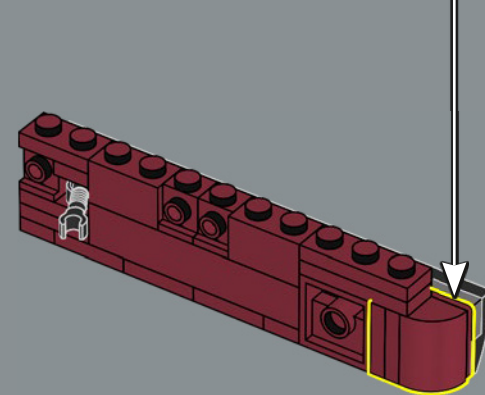
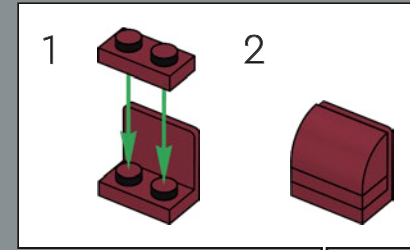



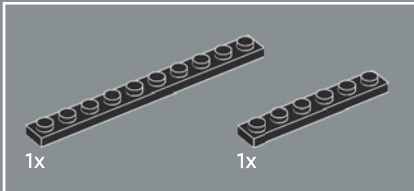
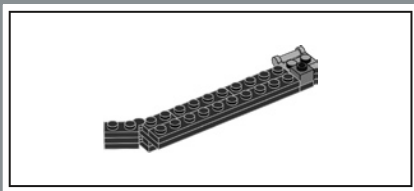

169

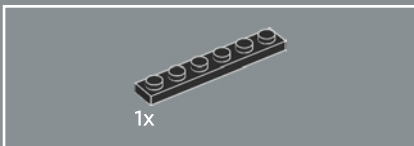
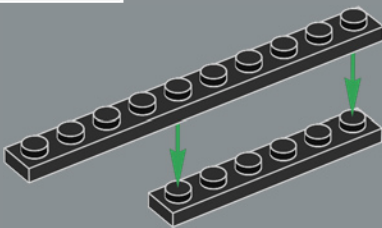

170

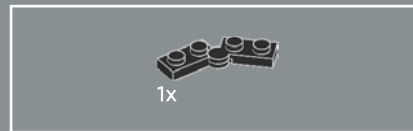
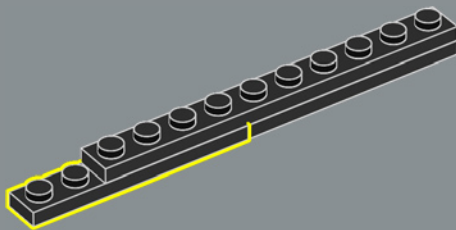

171

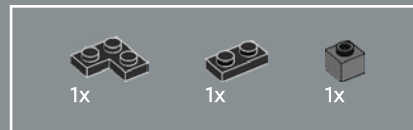
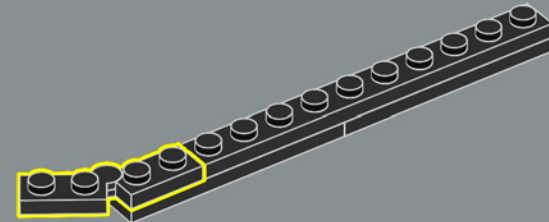

172

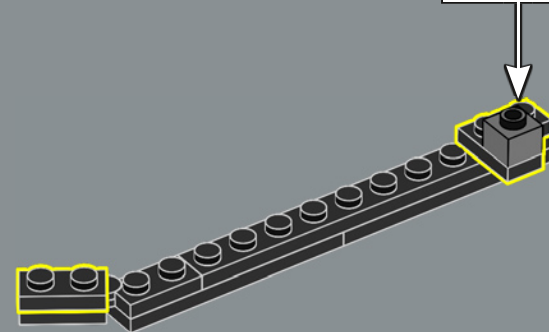
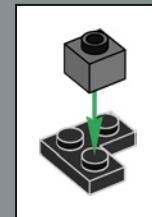

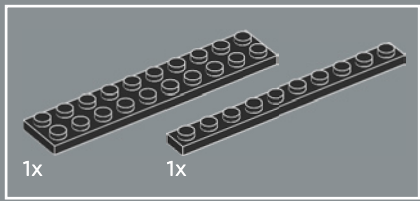

173

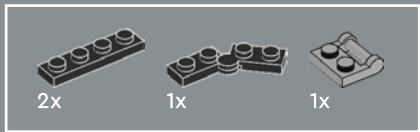
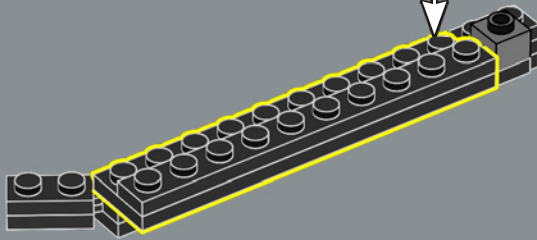
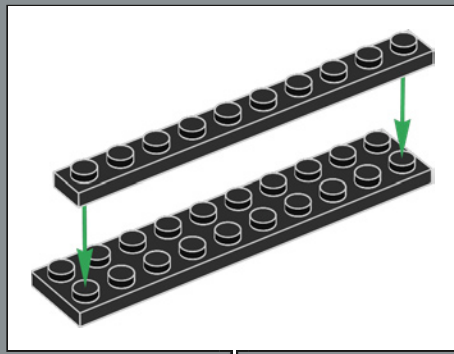

174

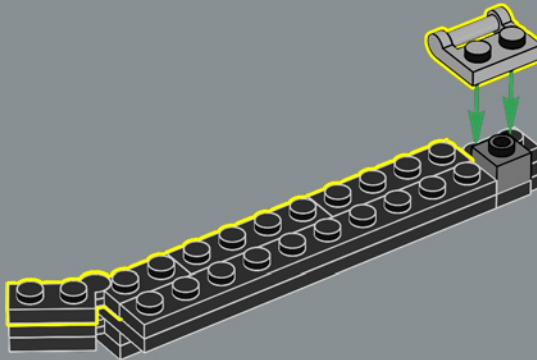

175

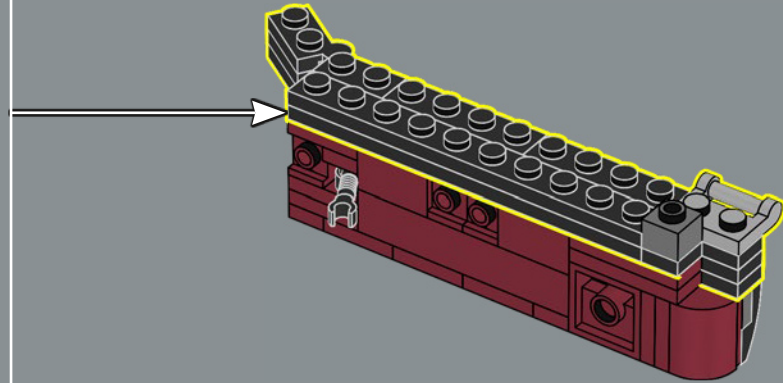

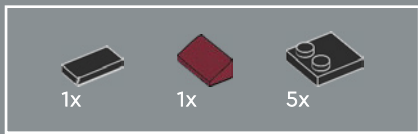

176

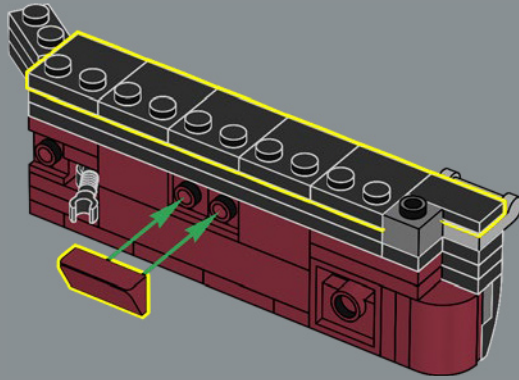

177

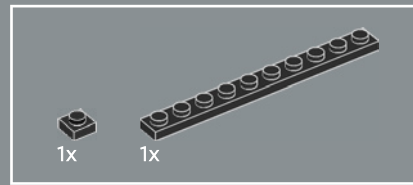
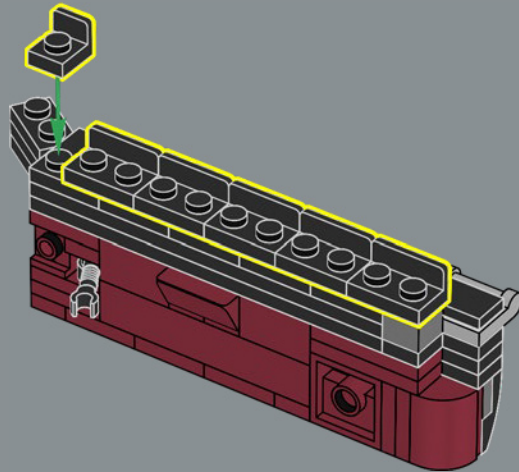

178

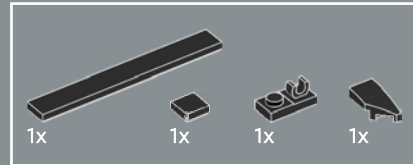
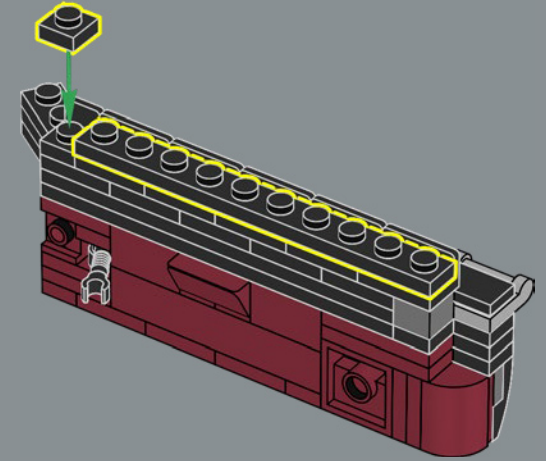

179

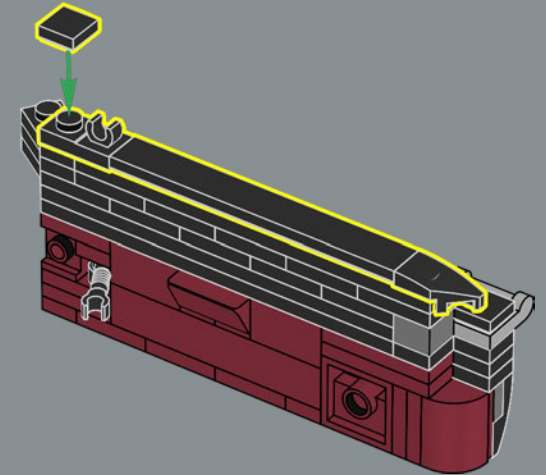



6x

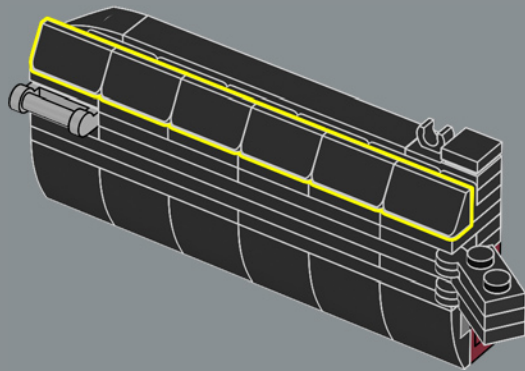

180

181

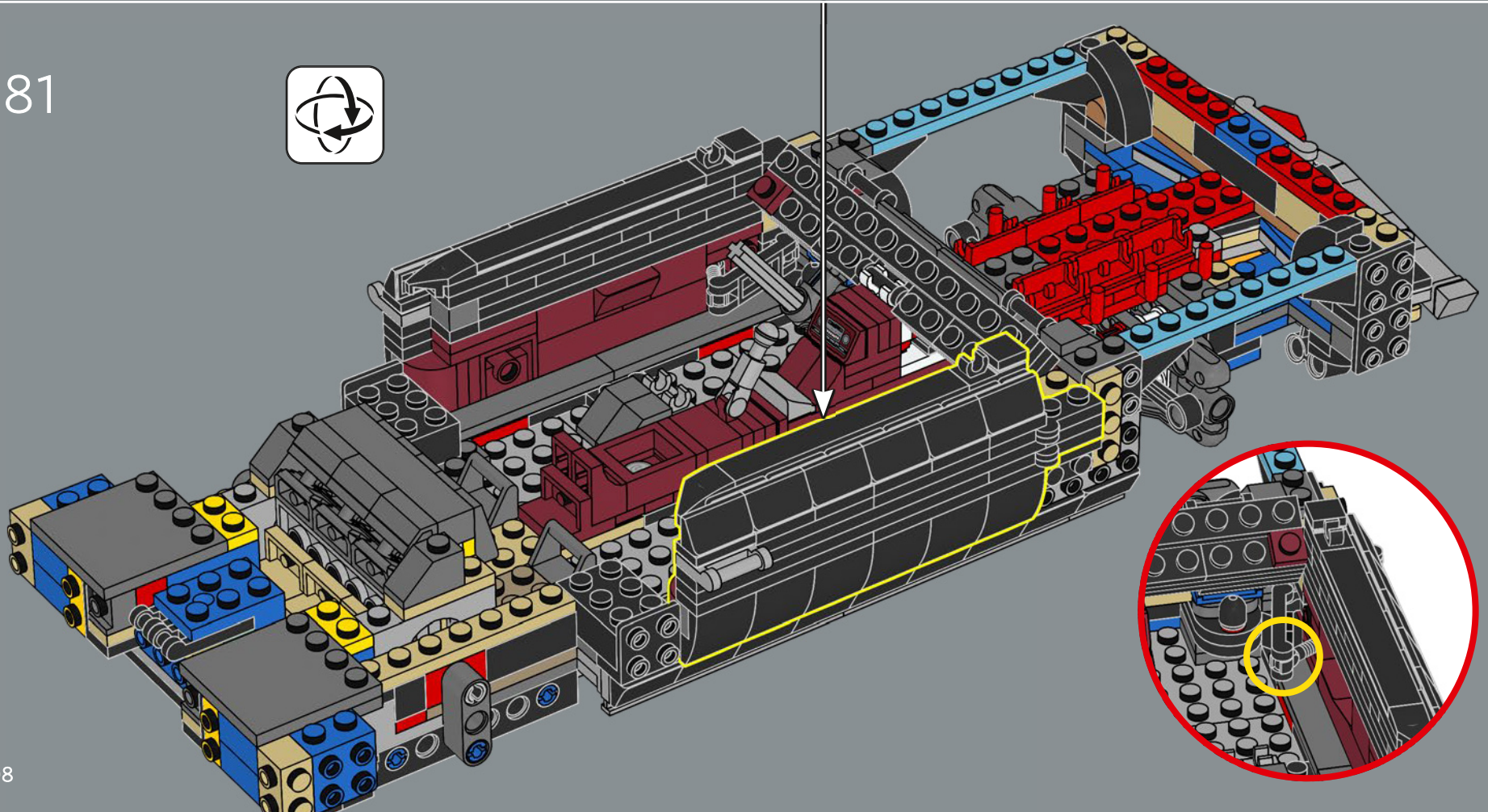



182

对于所有的车型和包装，  
Camaro 的原始买家可在 80  
个不同的工厂选项中选择。

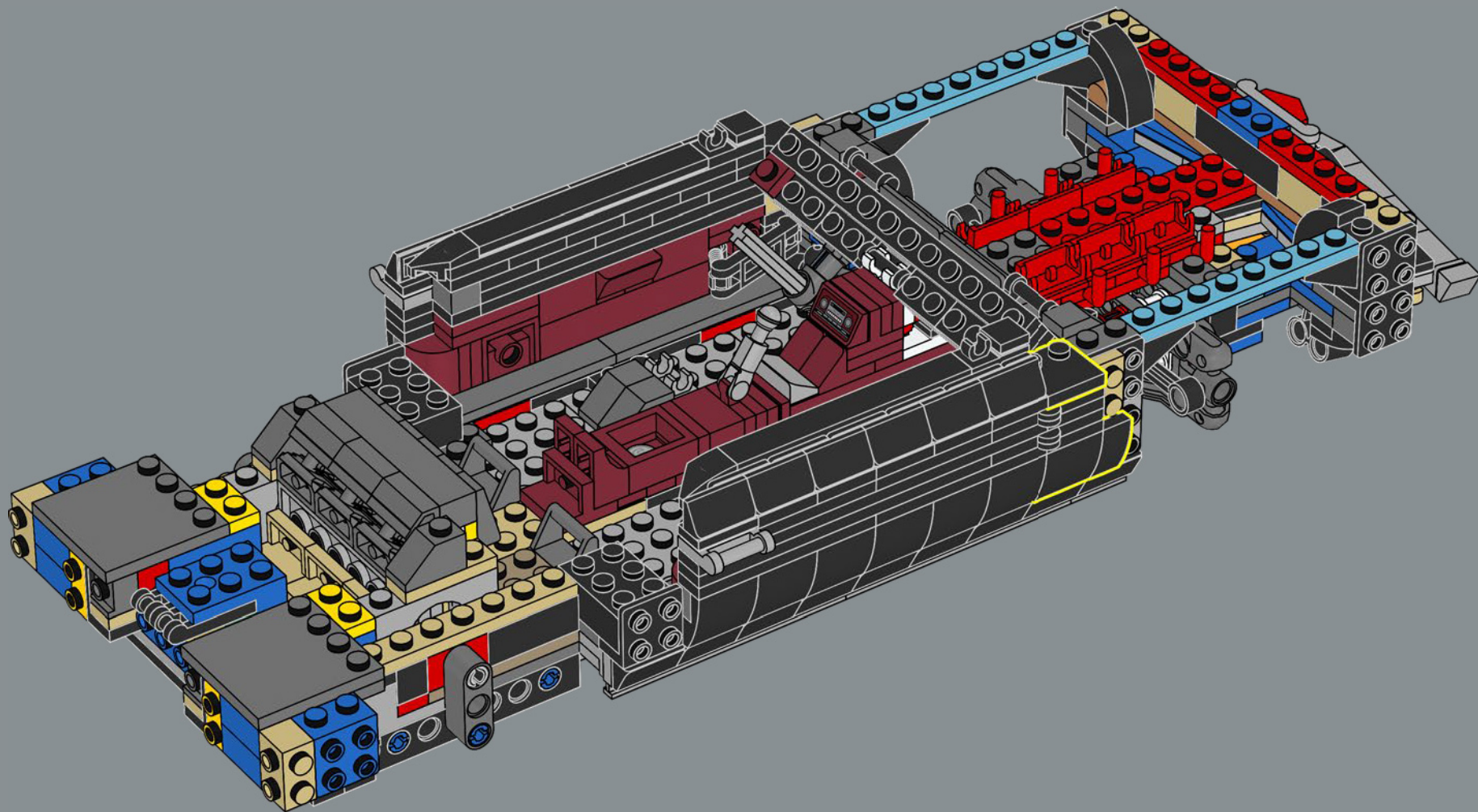

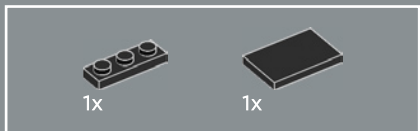

183

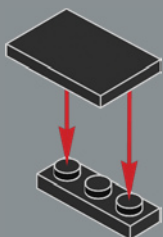

184

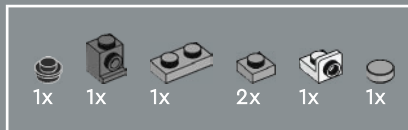
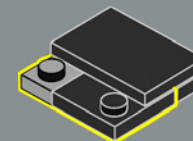

185

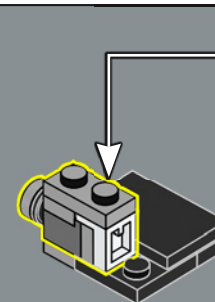
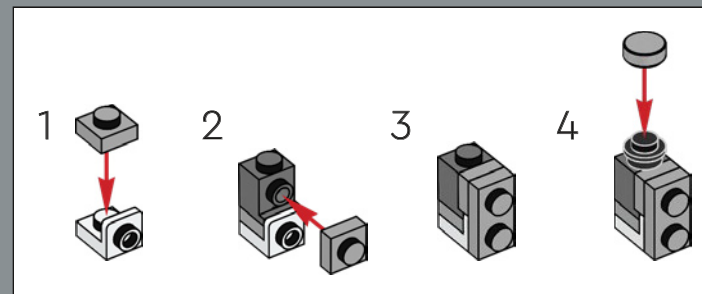

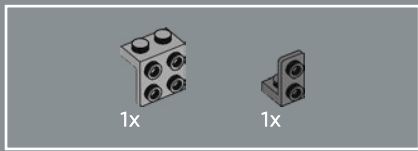

186

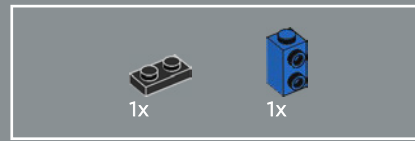
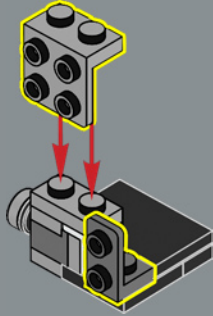

187

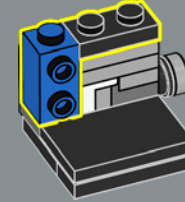

188

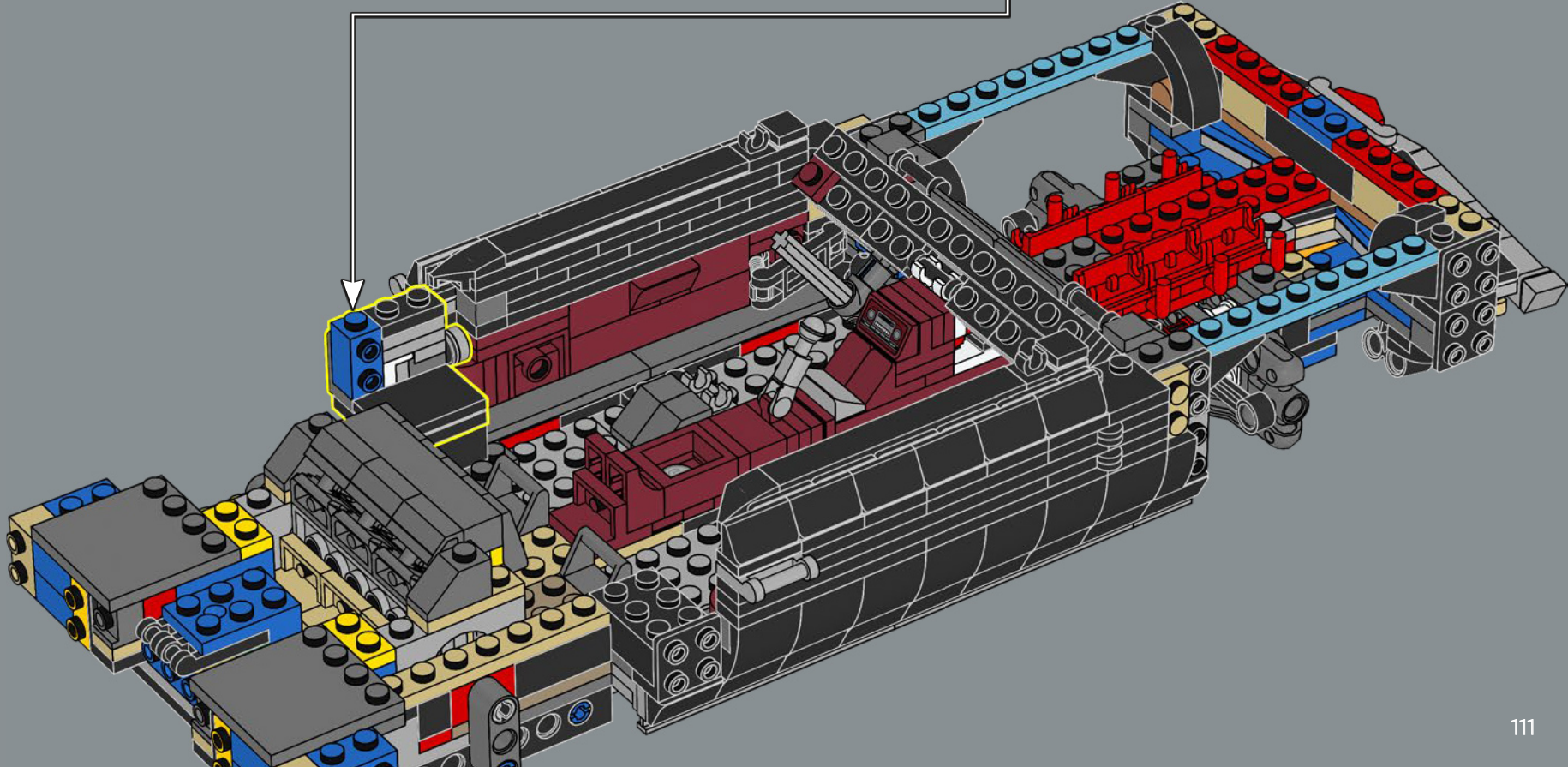

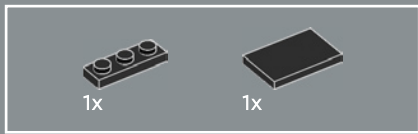

189

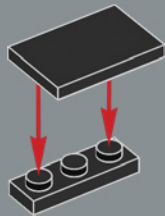

190

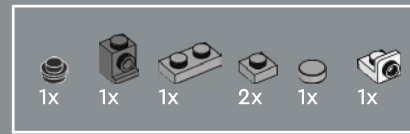
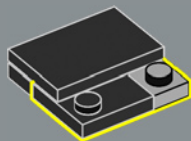

191

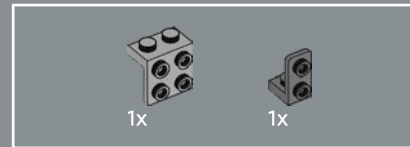
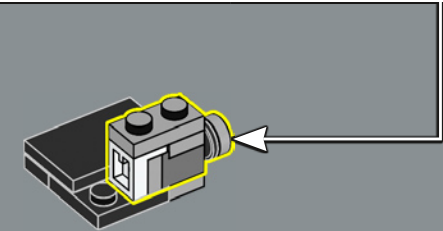
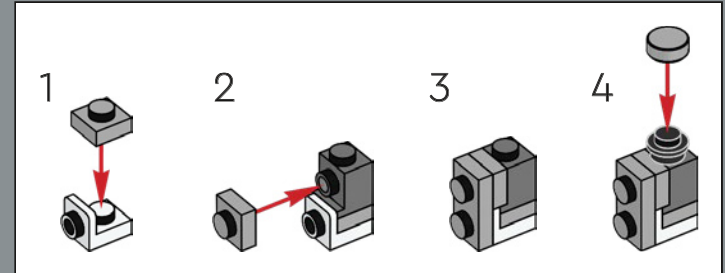

192

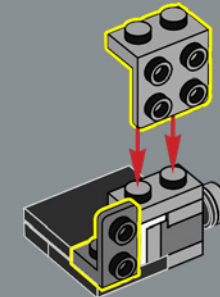



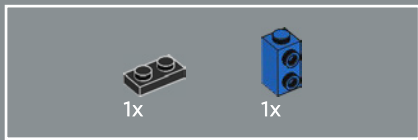

193

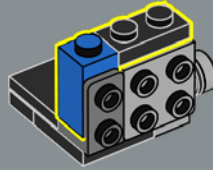

194

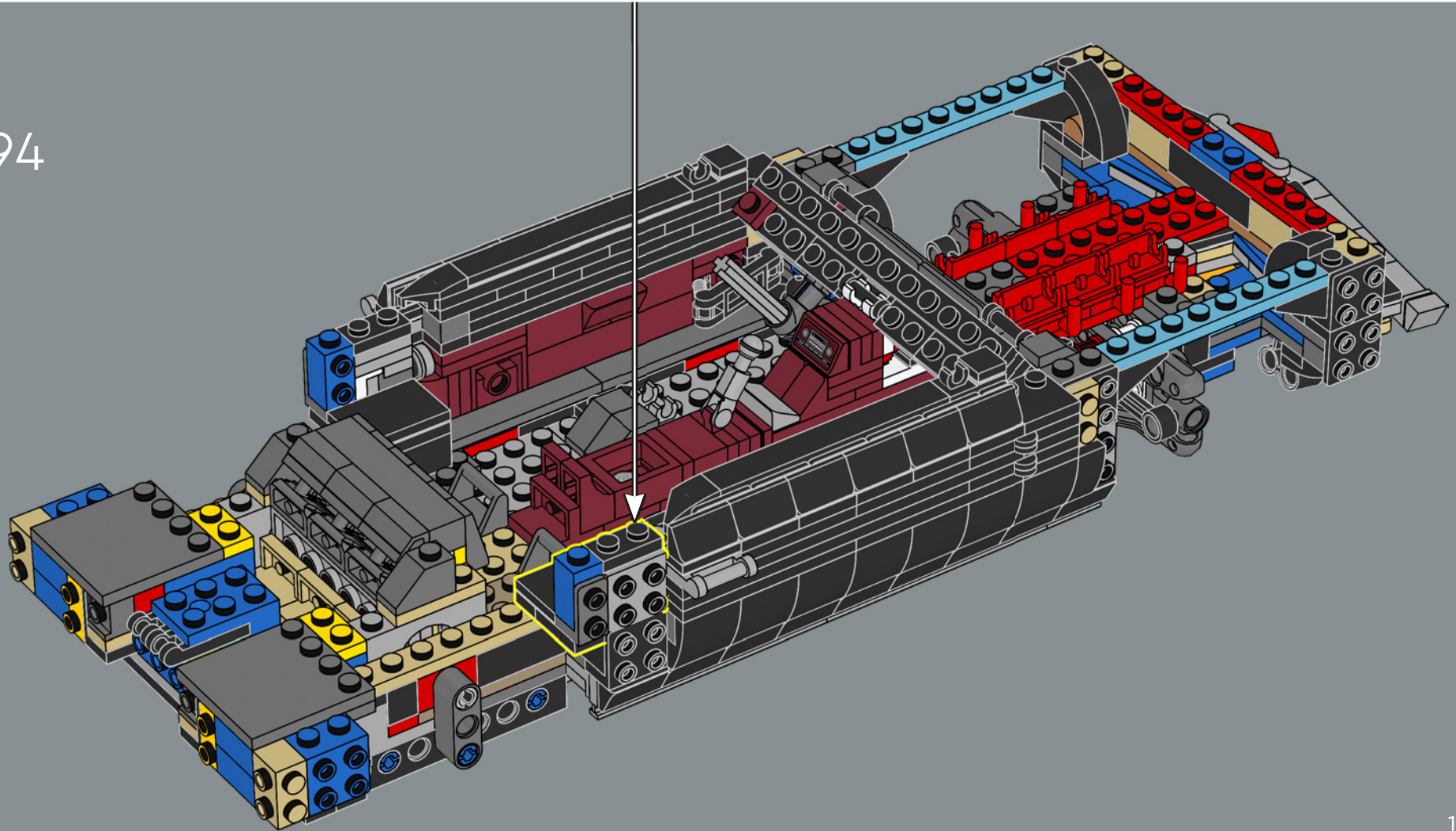

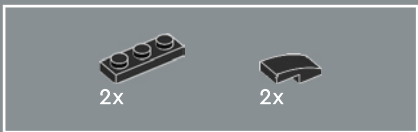

195

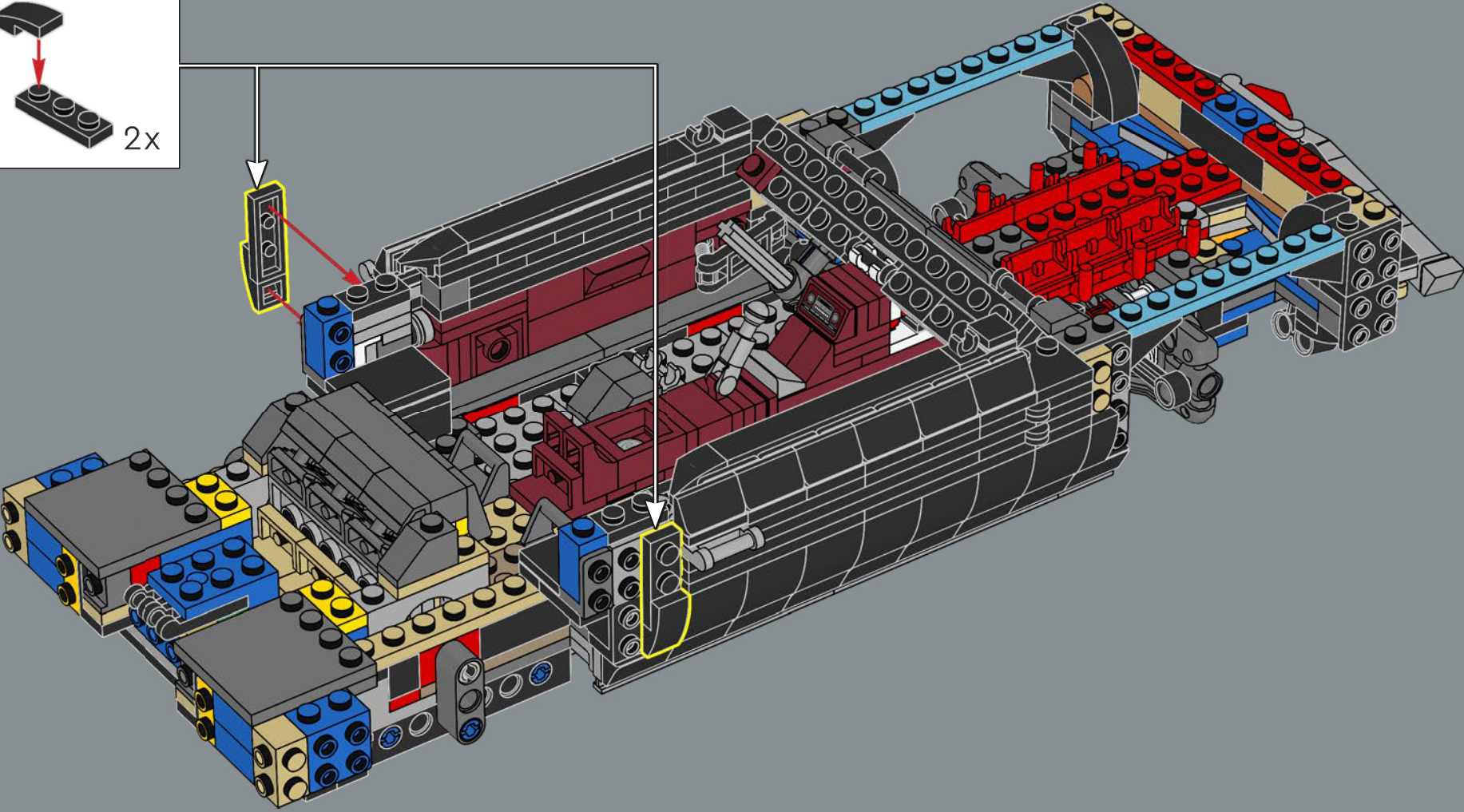
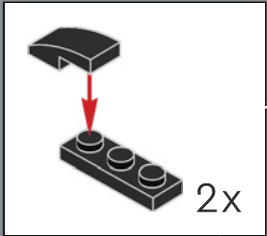

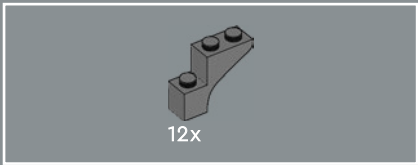

196

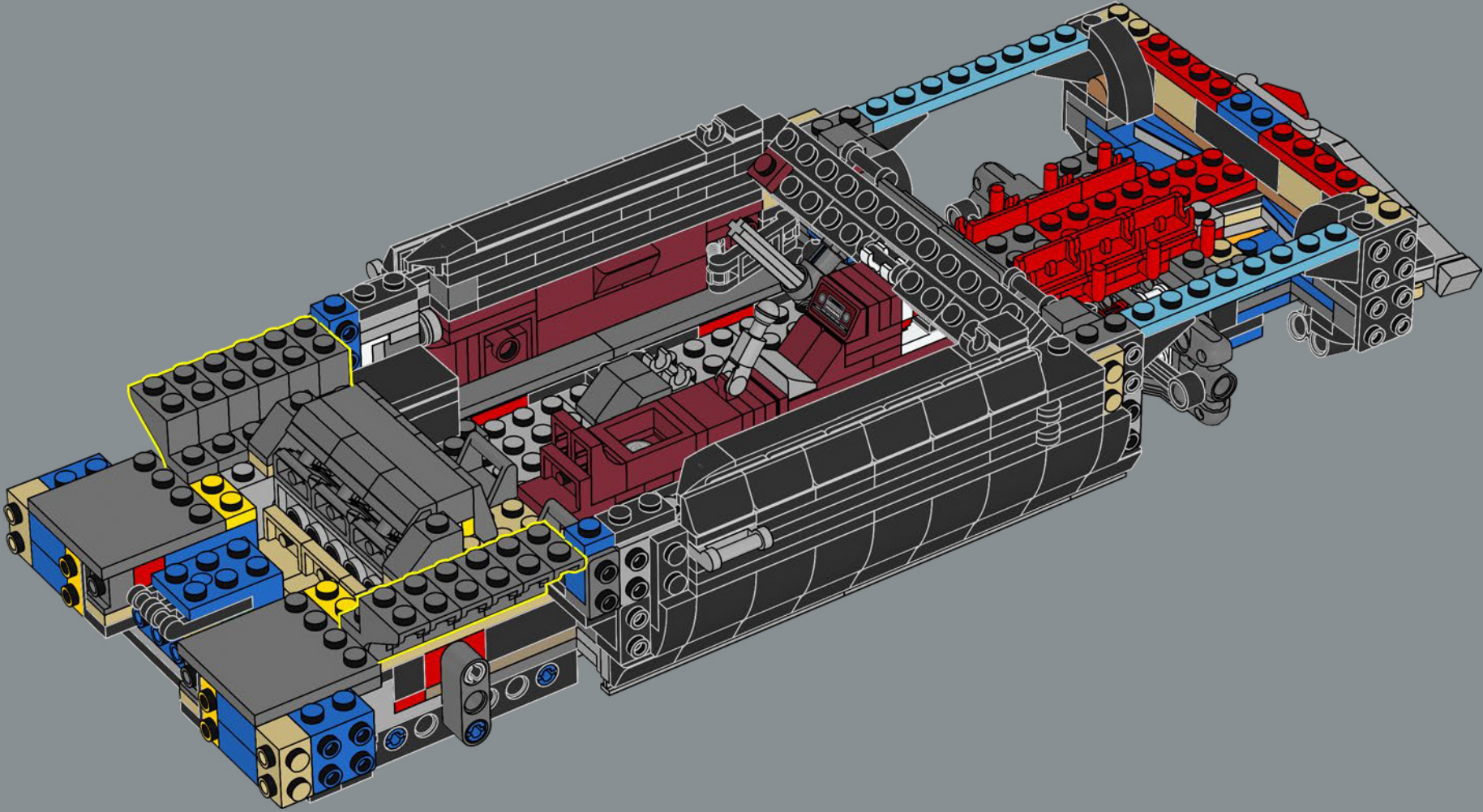

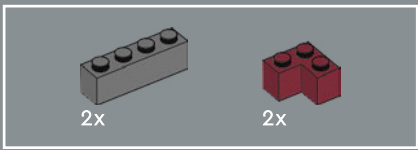

197

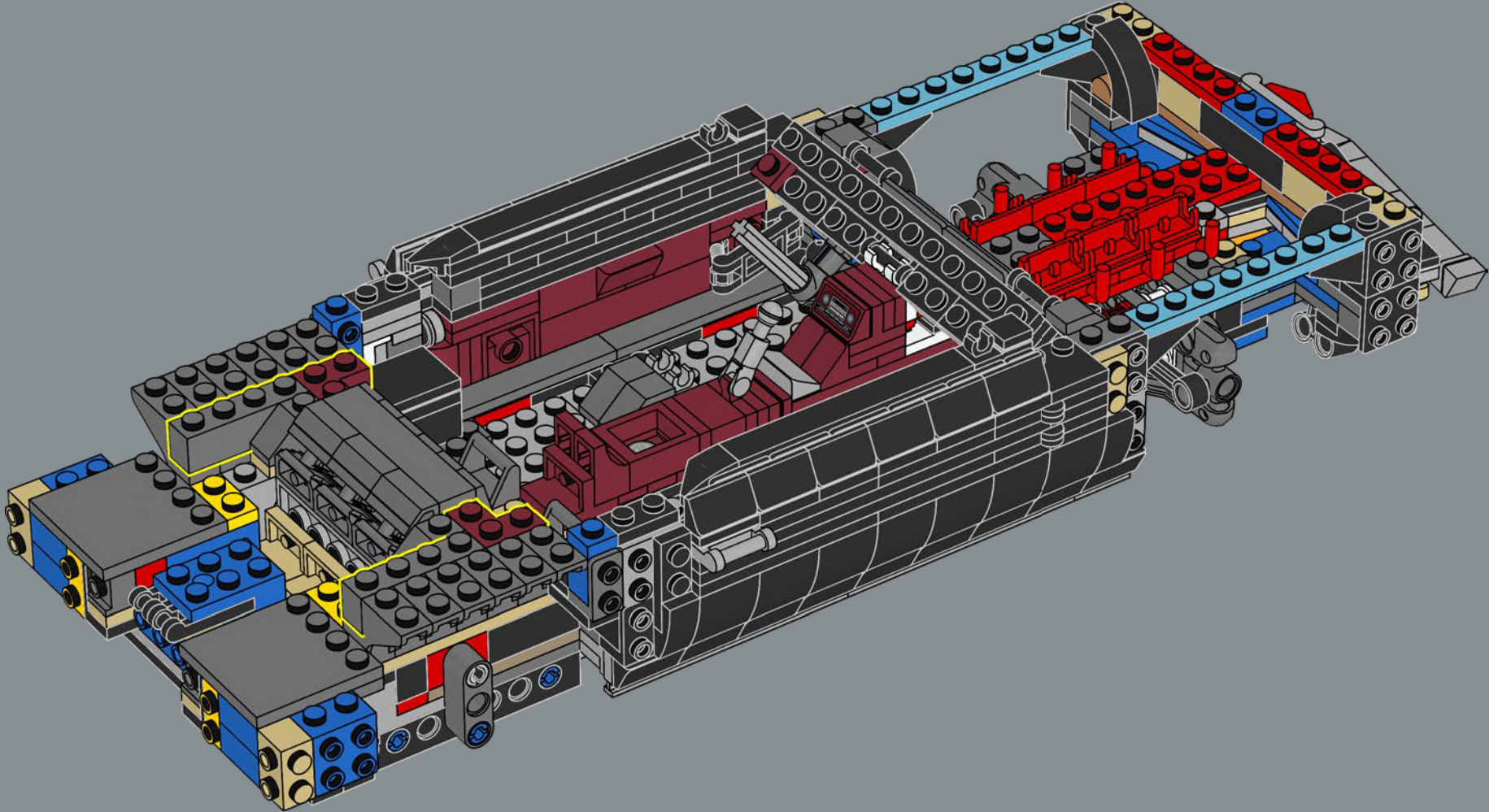

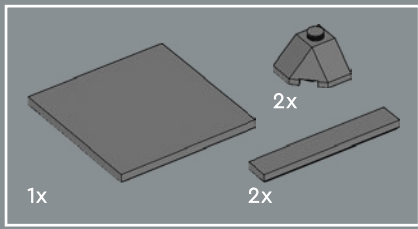

198

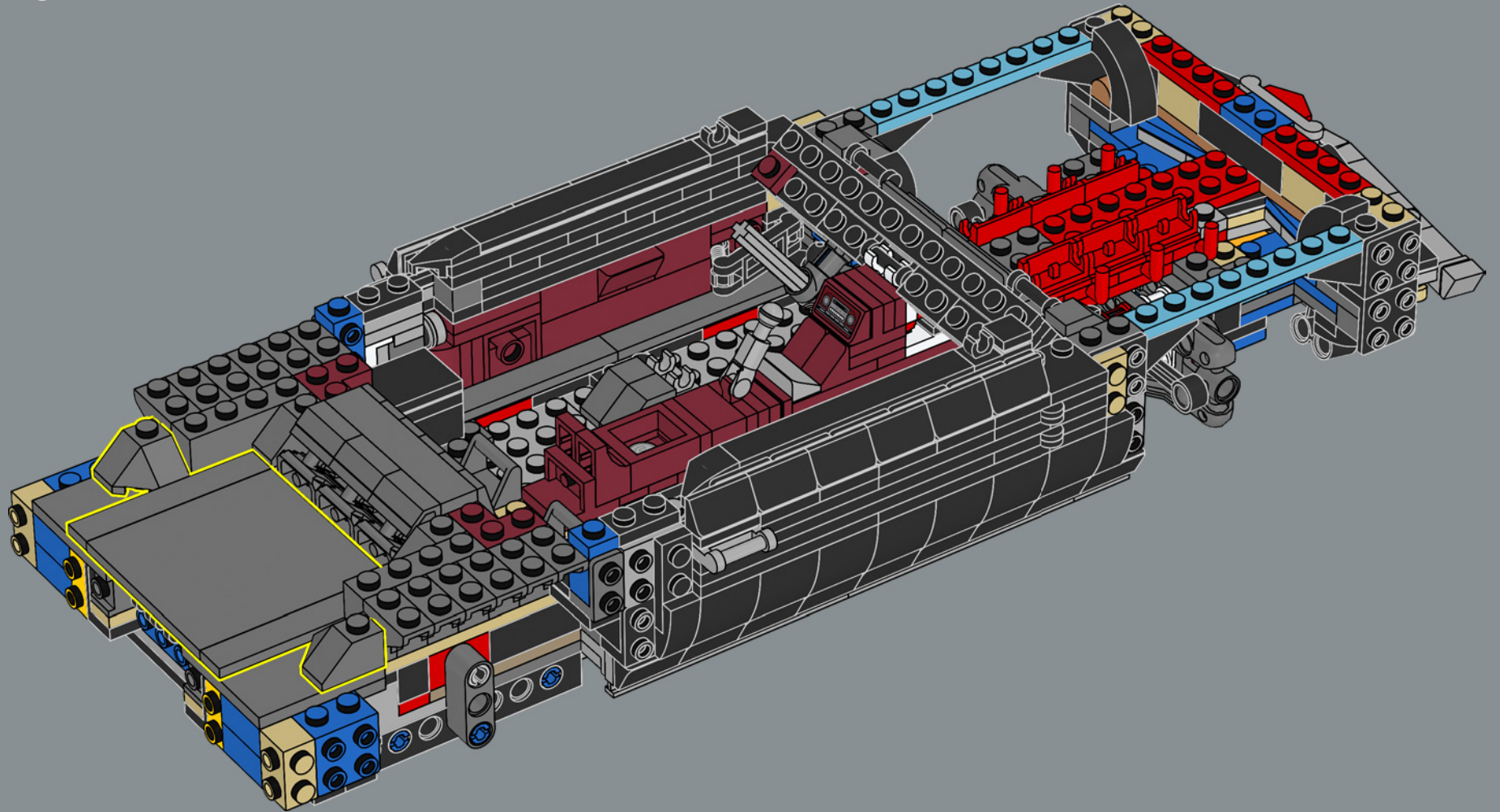

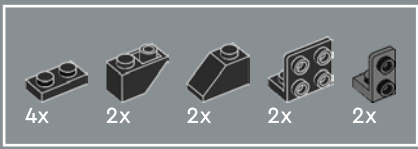

199

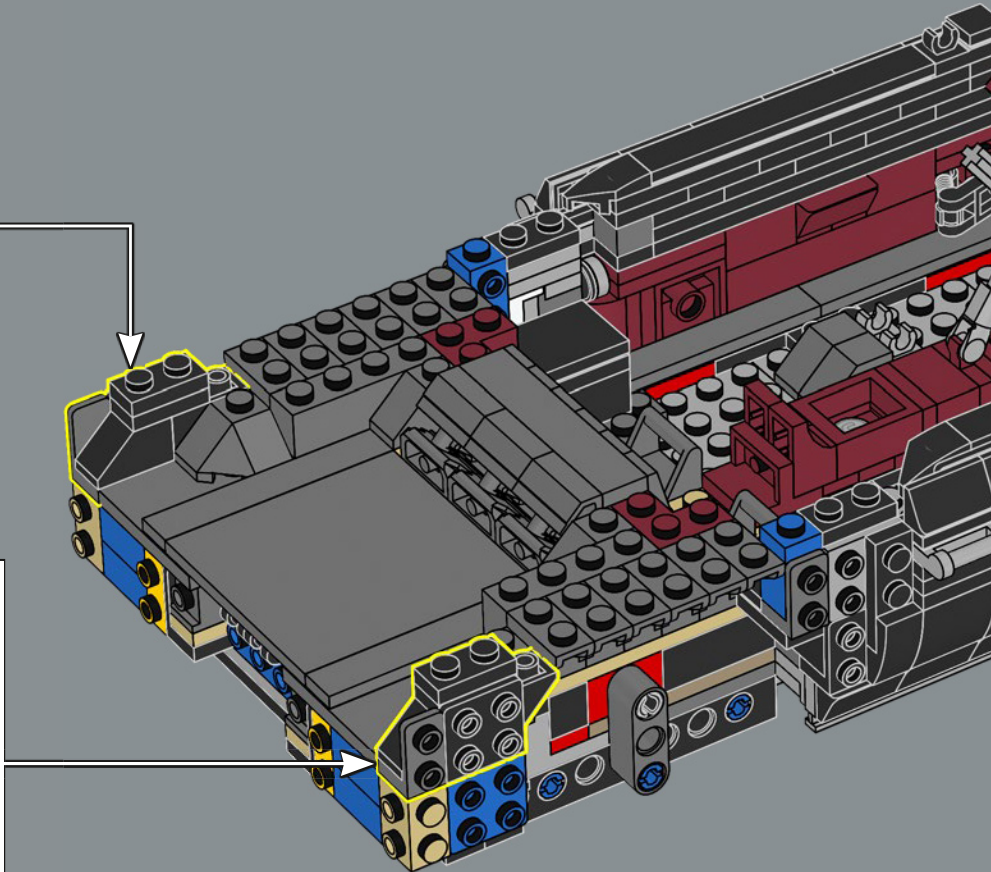
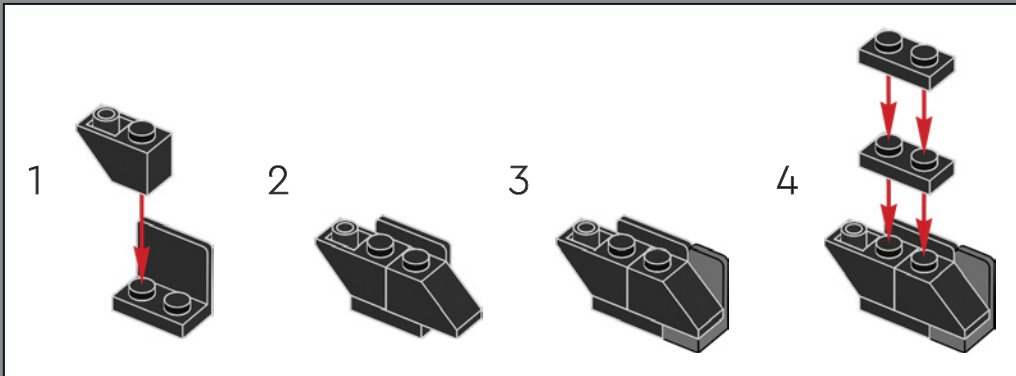
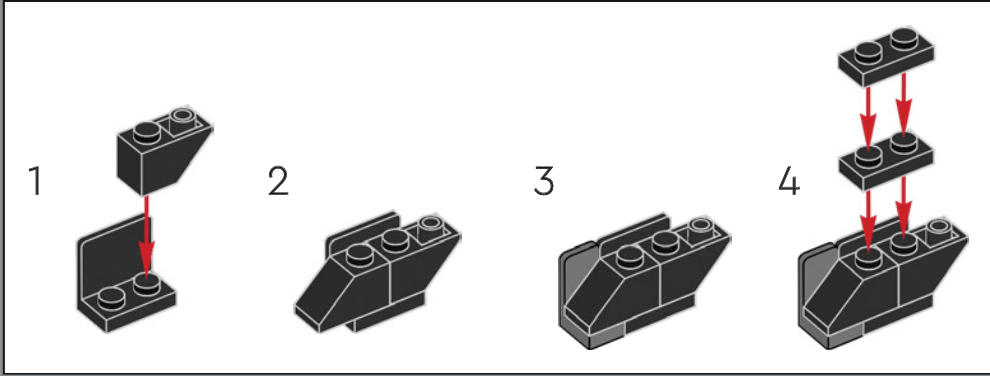



200

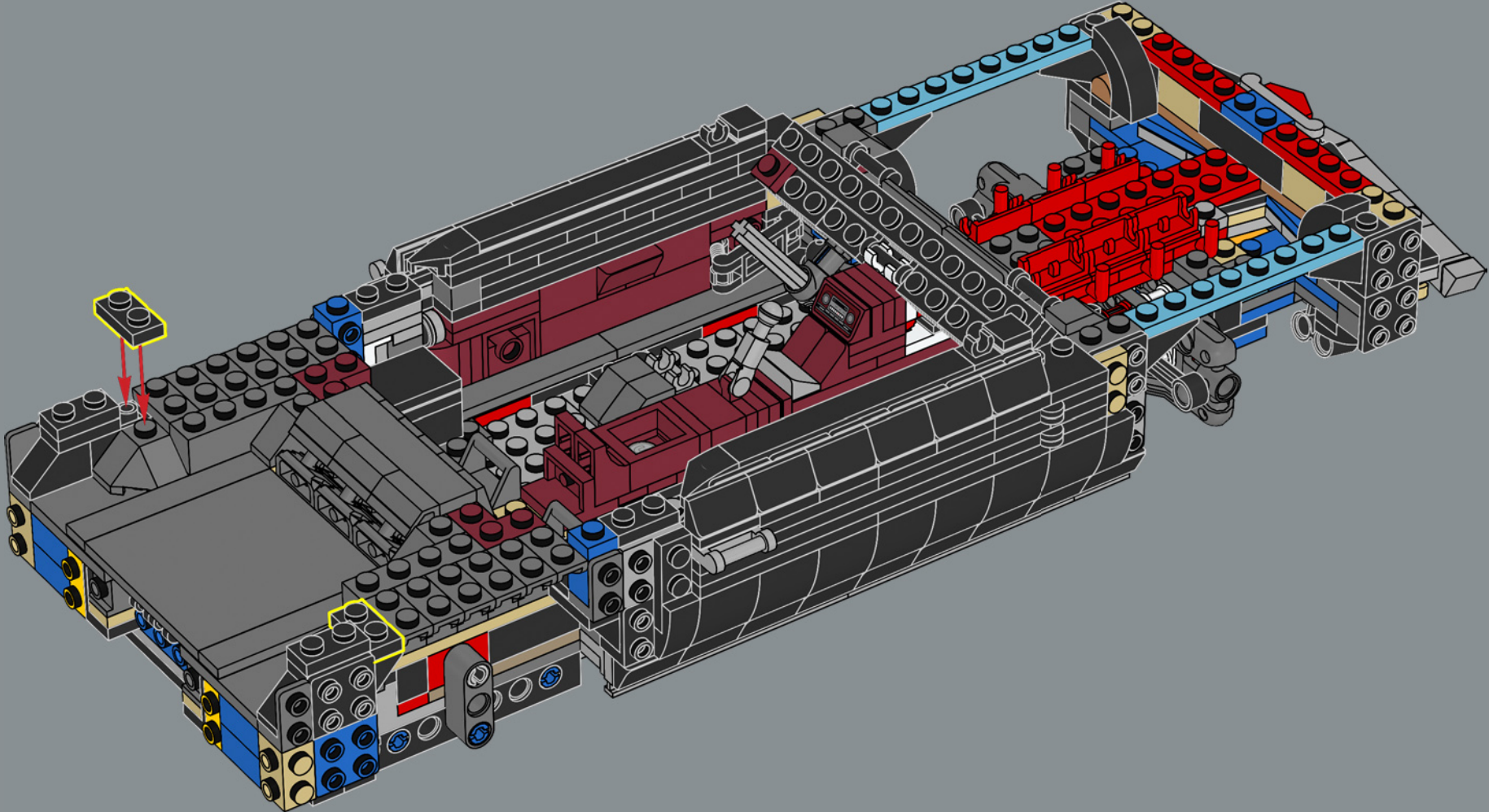



2x

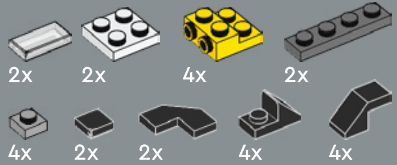

201

1

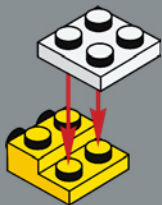

2

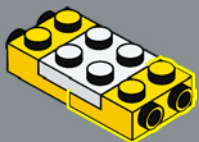

3

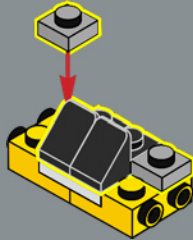

4

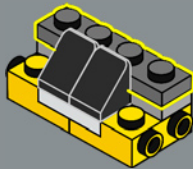

5

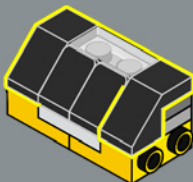

2x

6

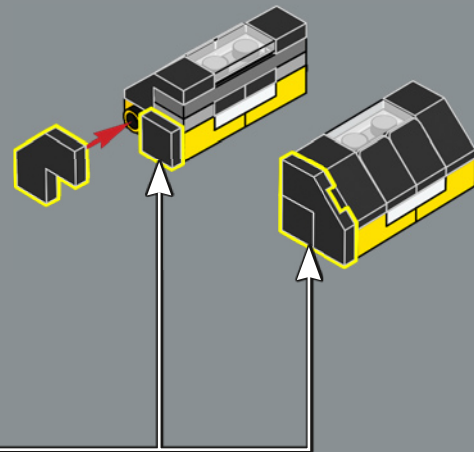



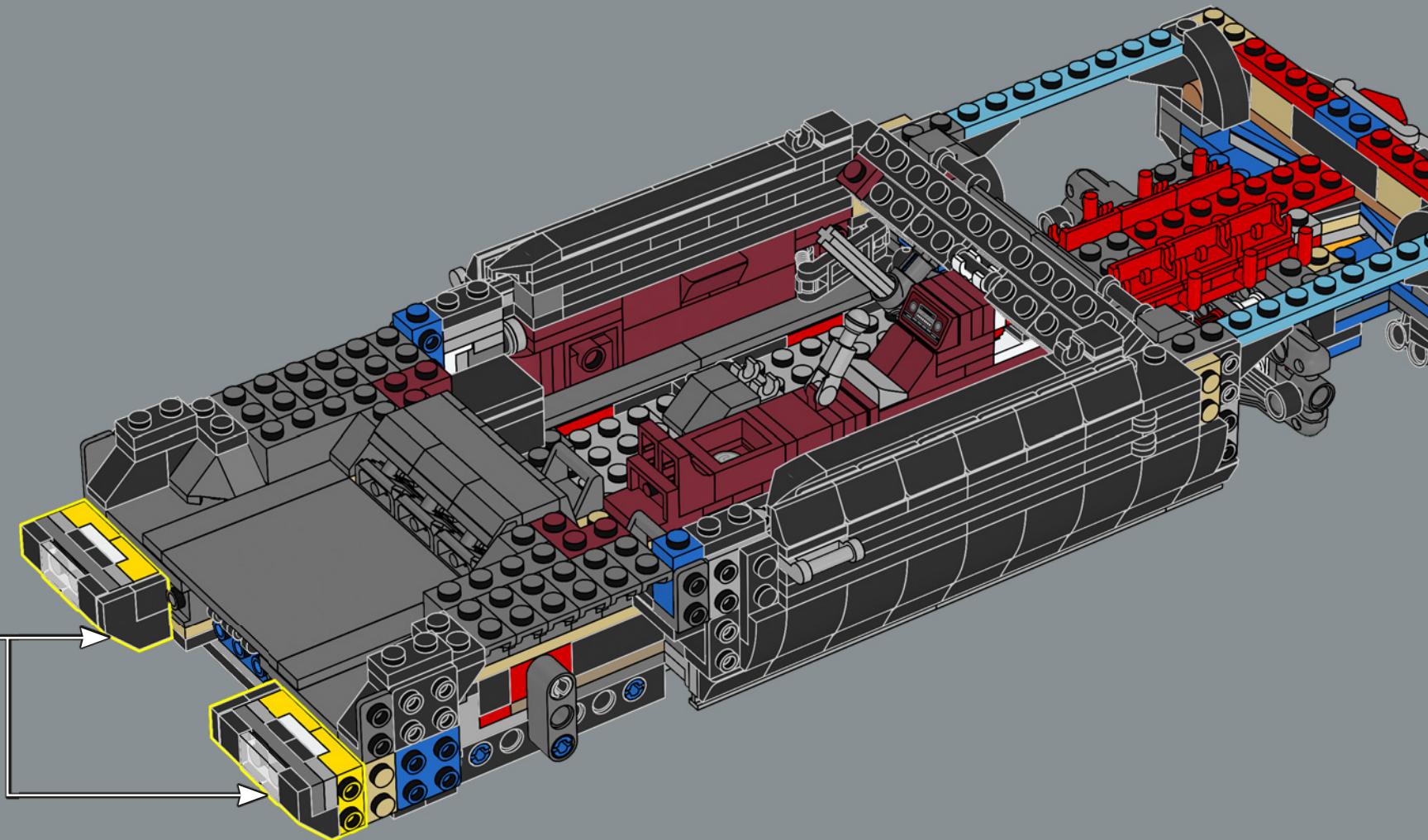



202

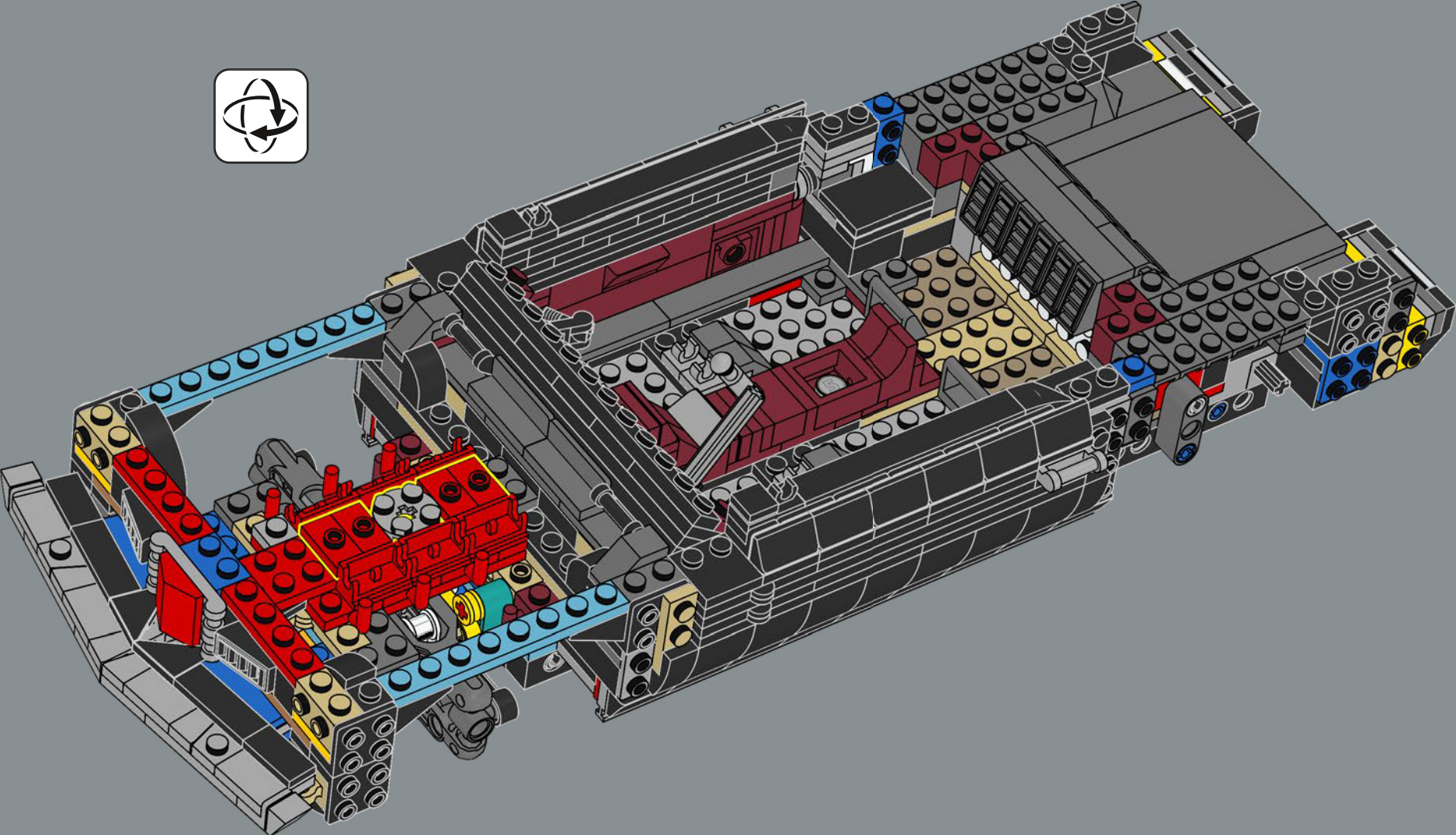

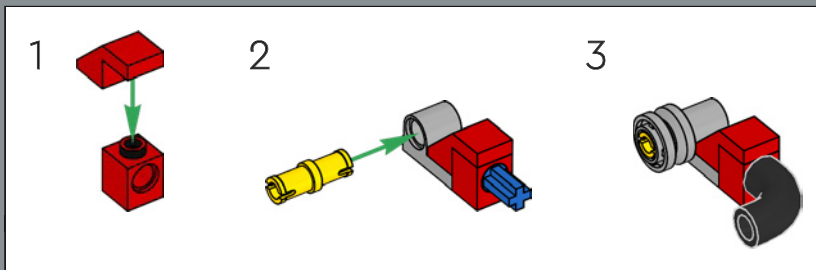
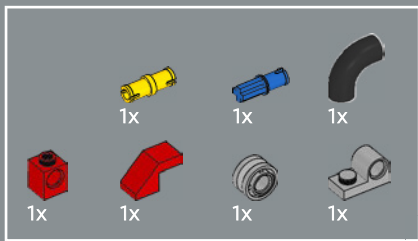

203

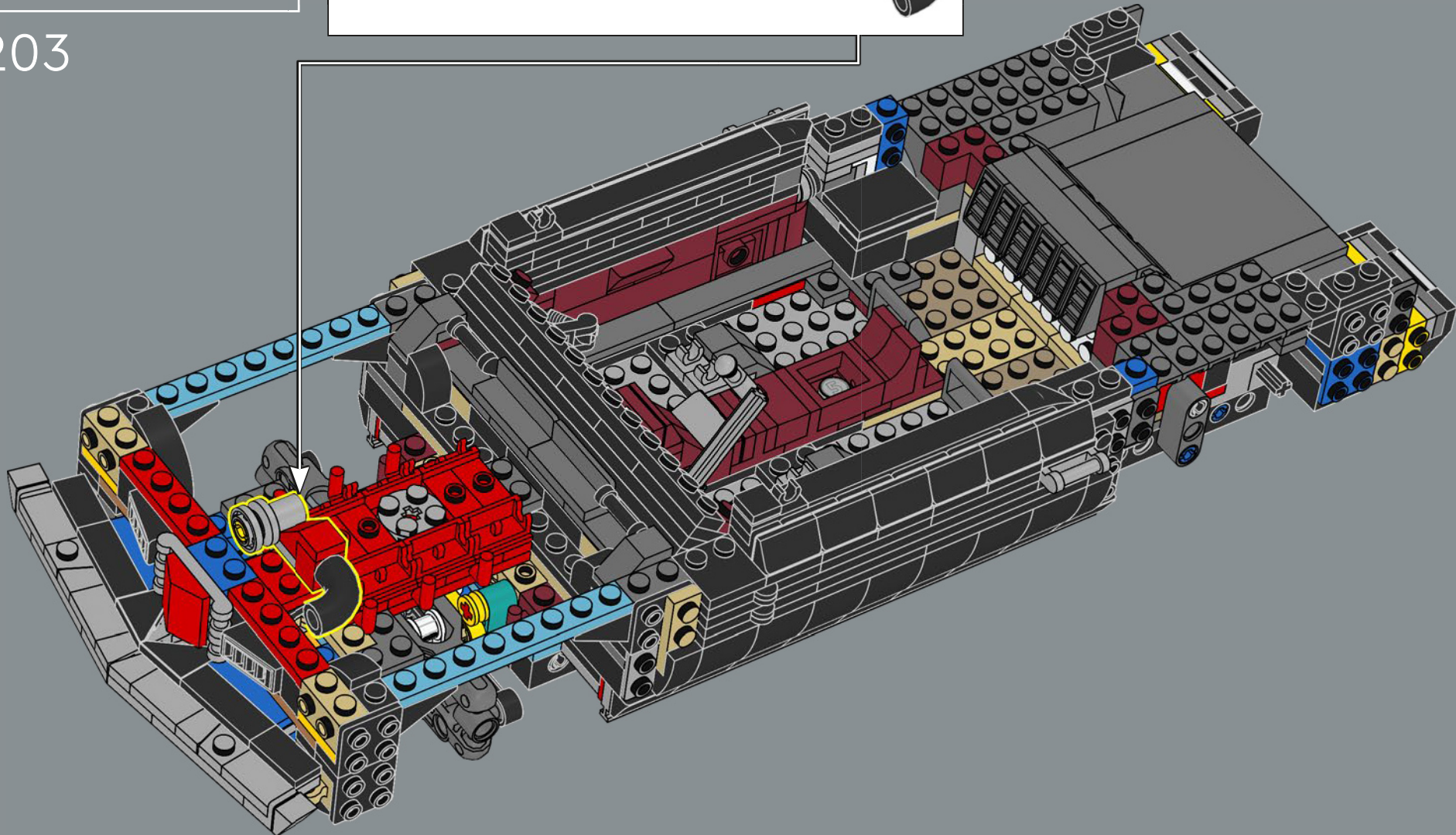

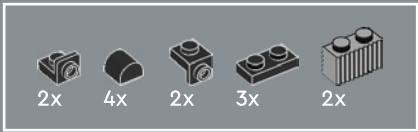

# 204

1

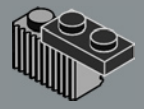

2

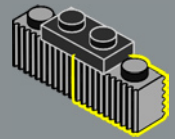

3

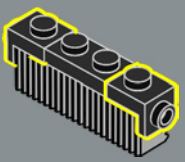

4

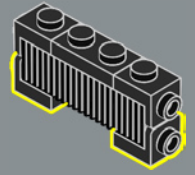

5

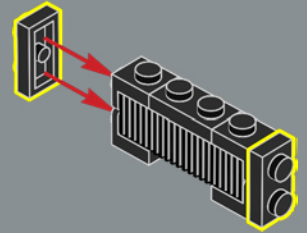

6

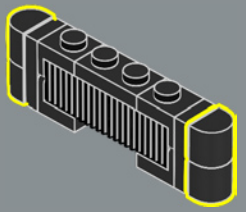

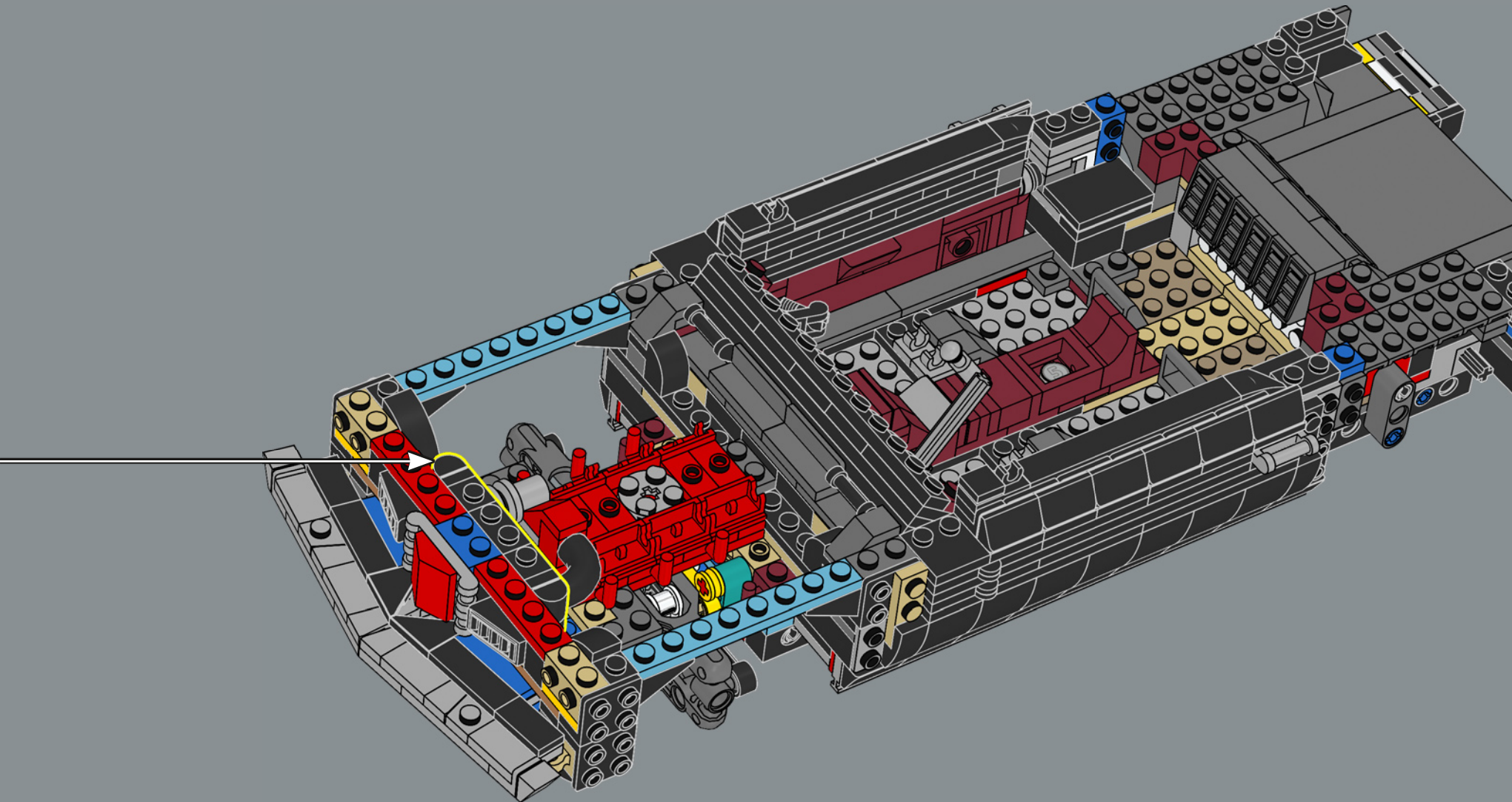





206

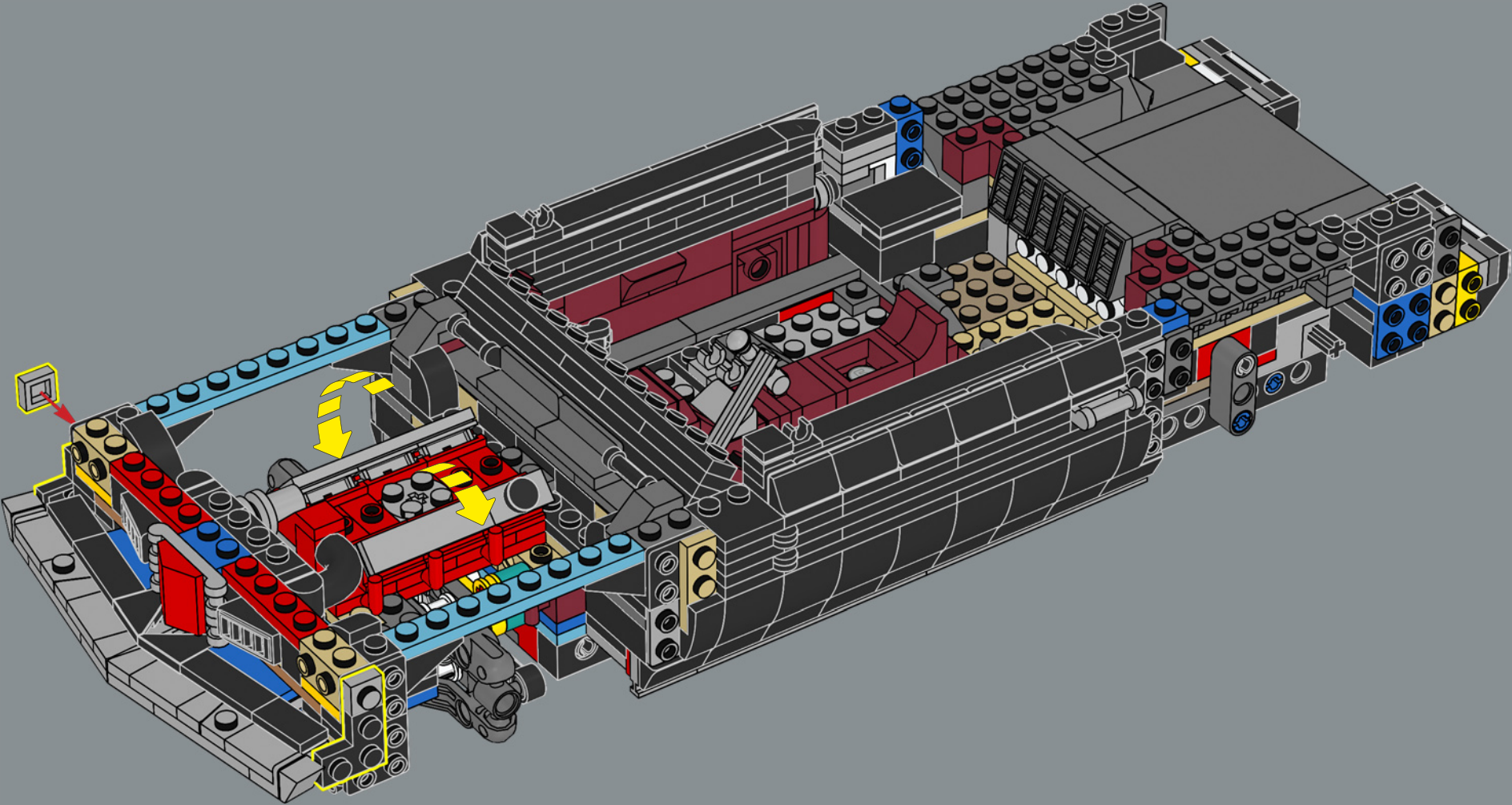



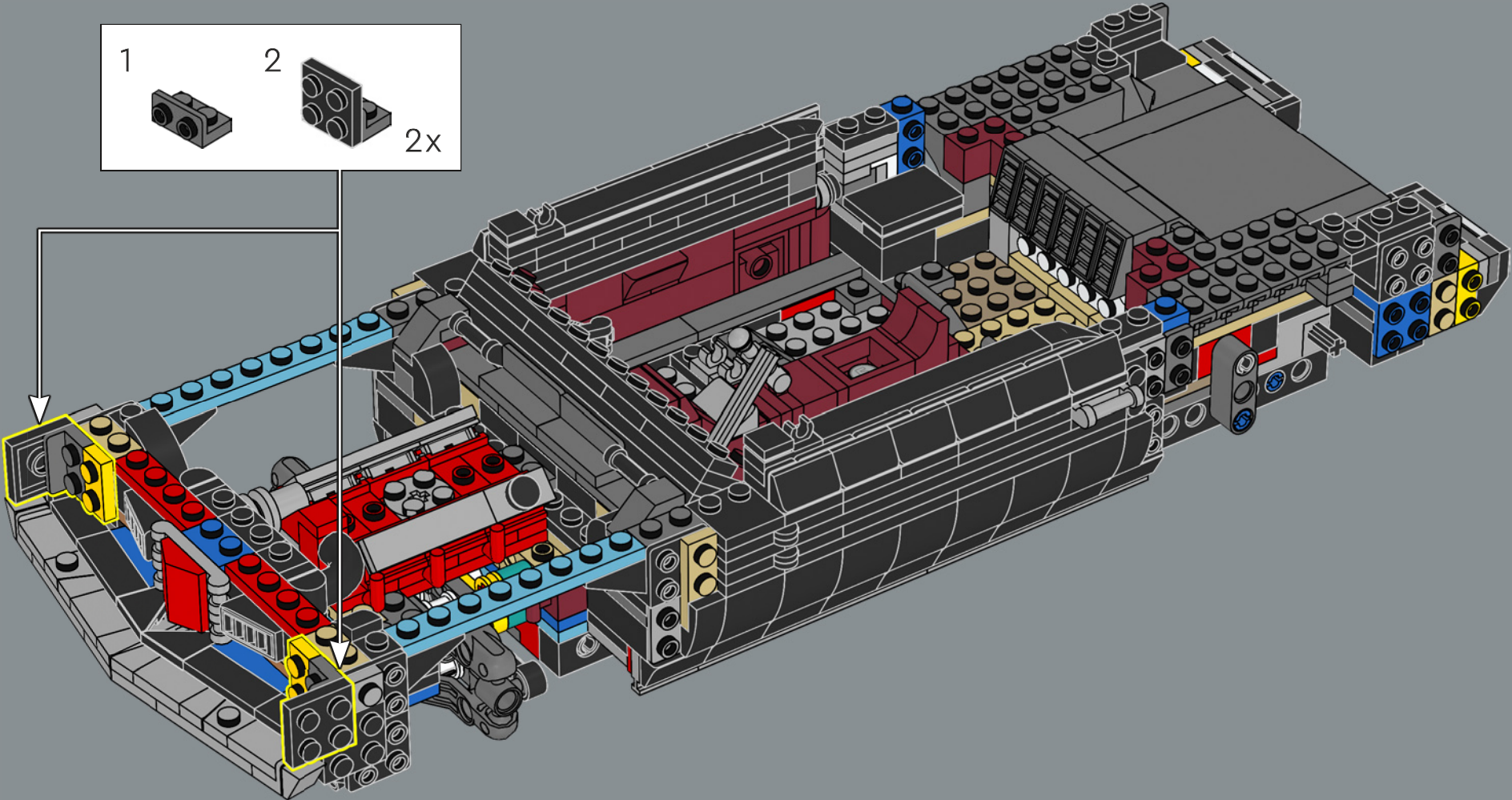
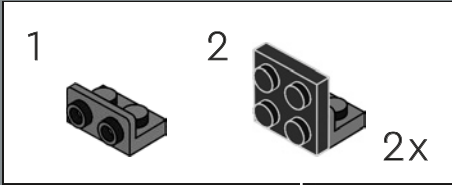

207





14x  2x 

208

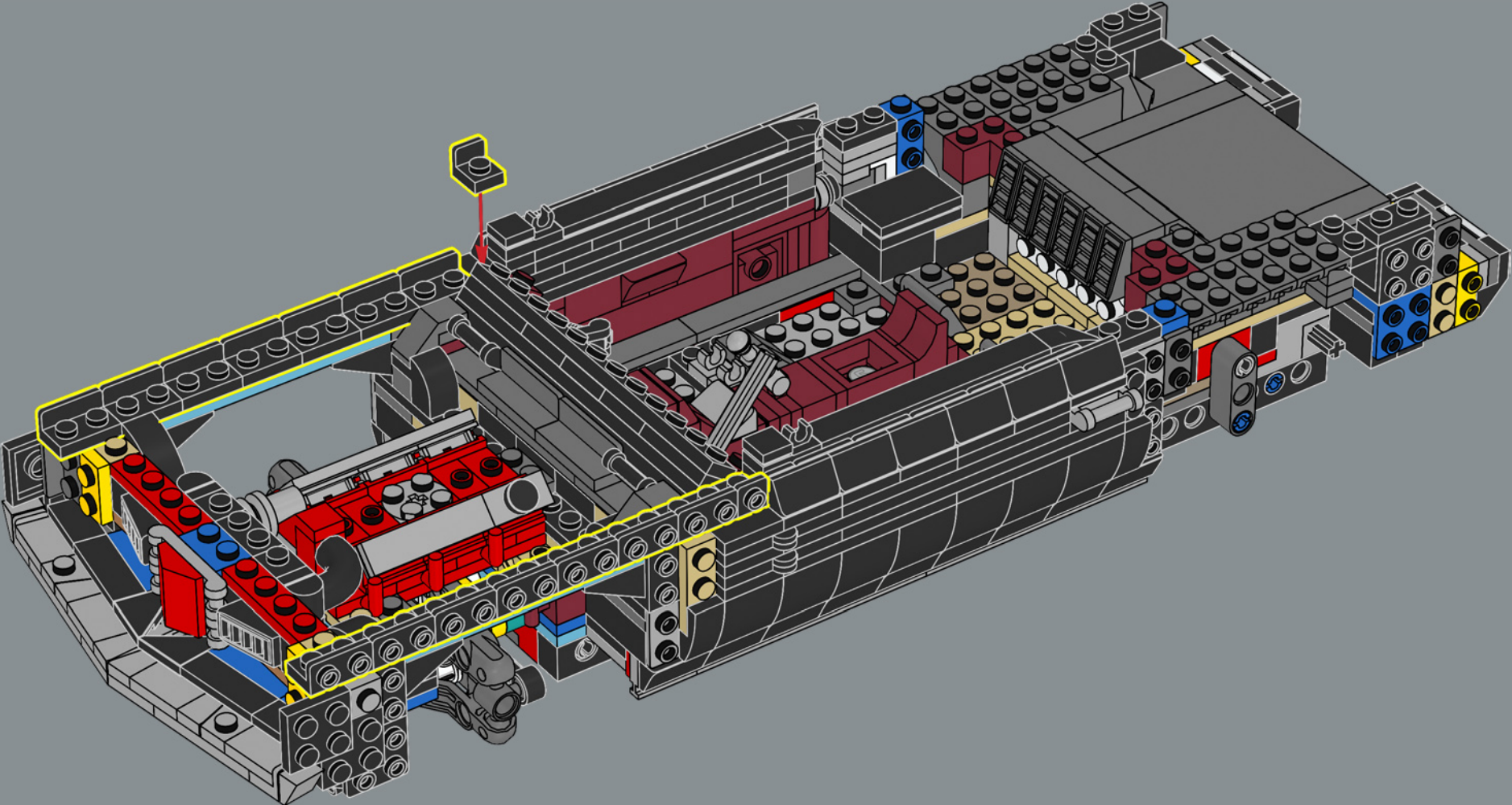

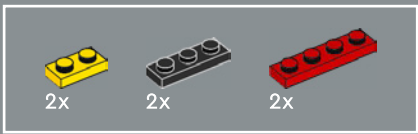

209

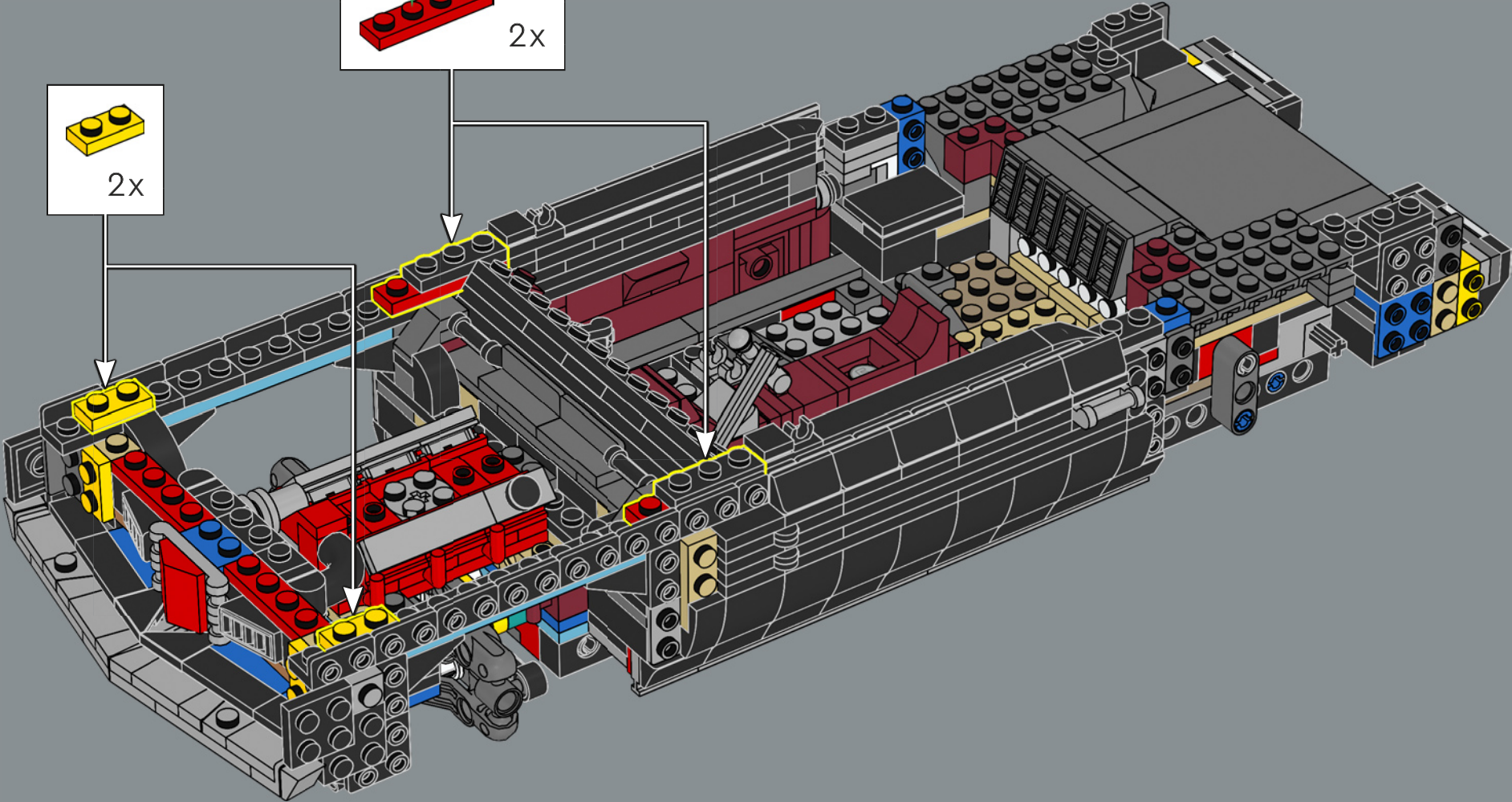
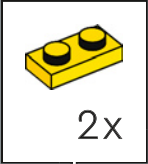
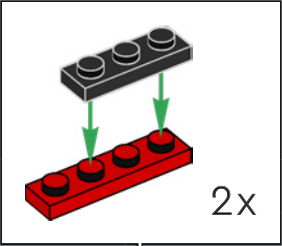

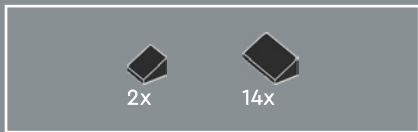

210

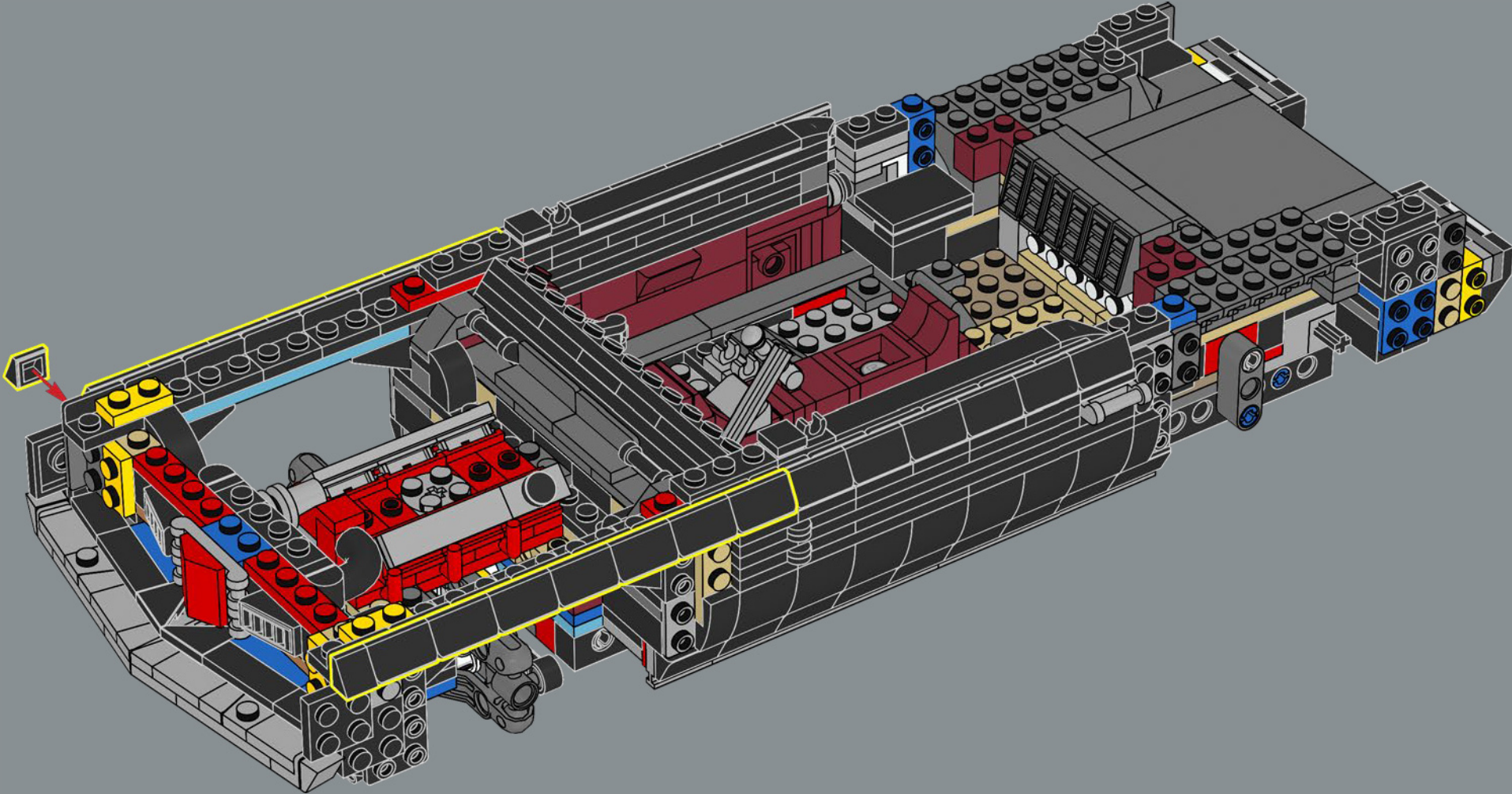

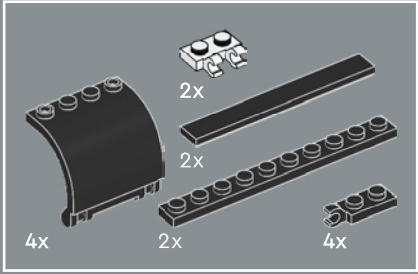
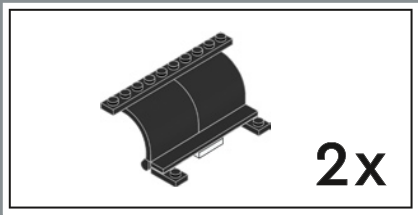

211

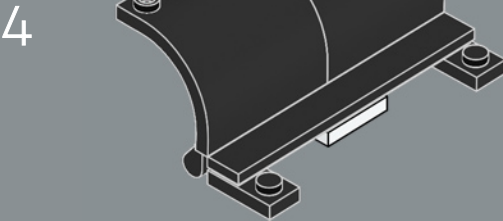
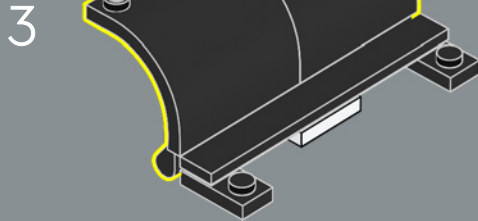
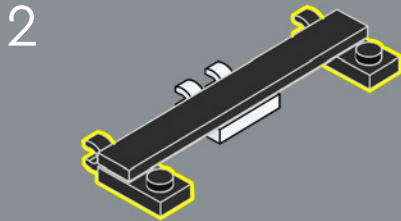
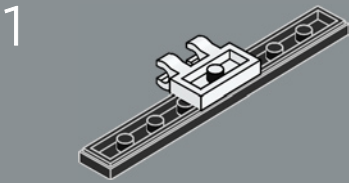

2x

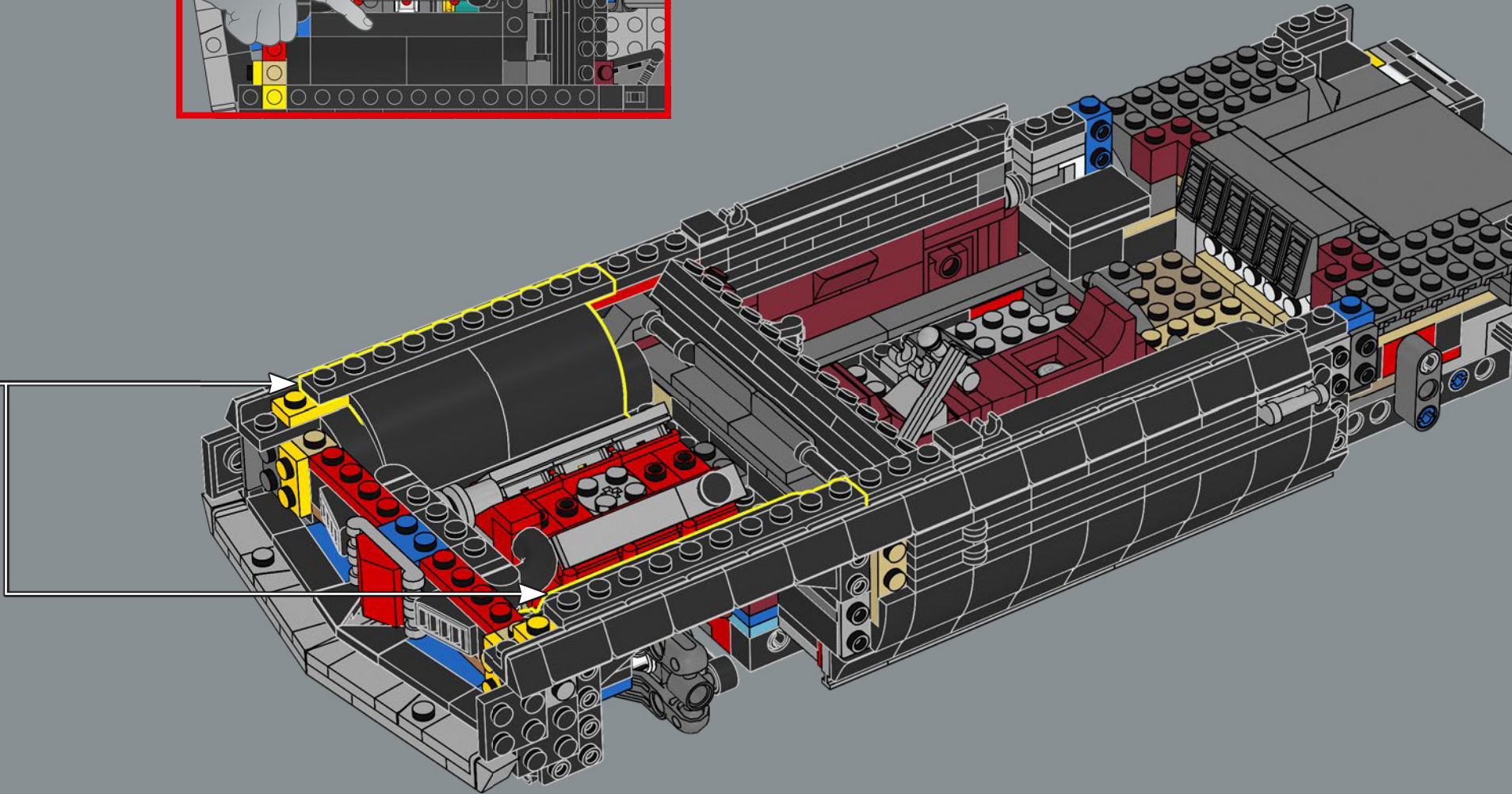
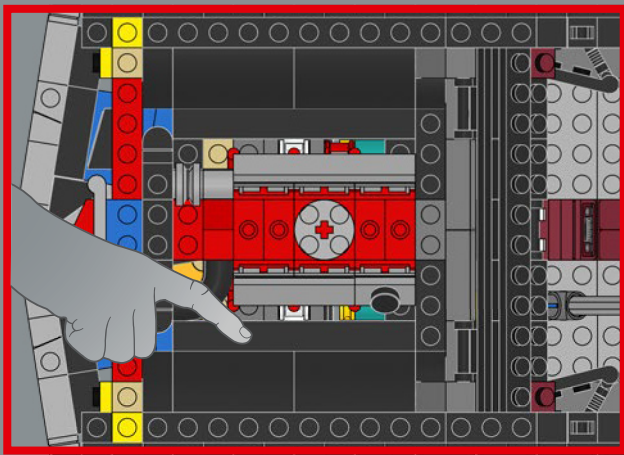

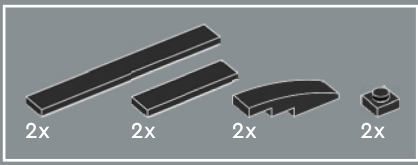

212

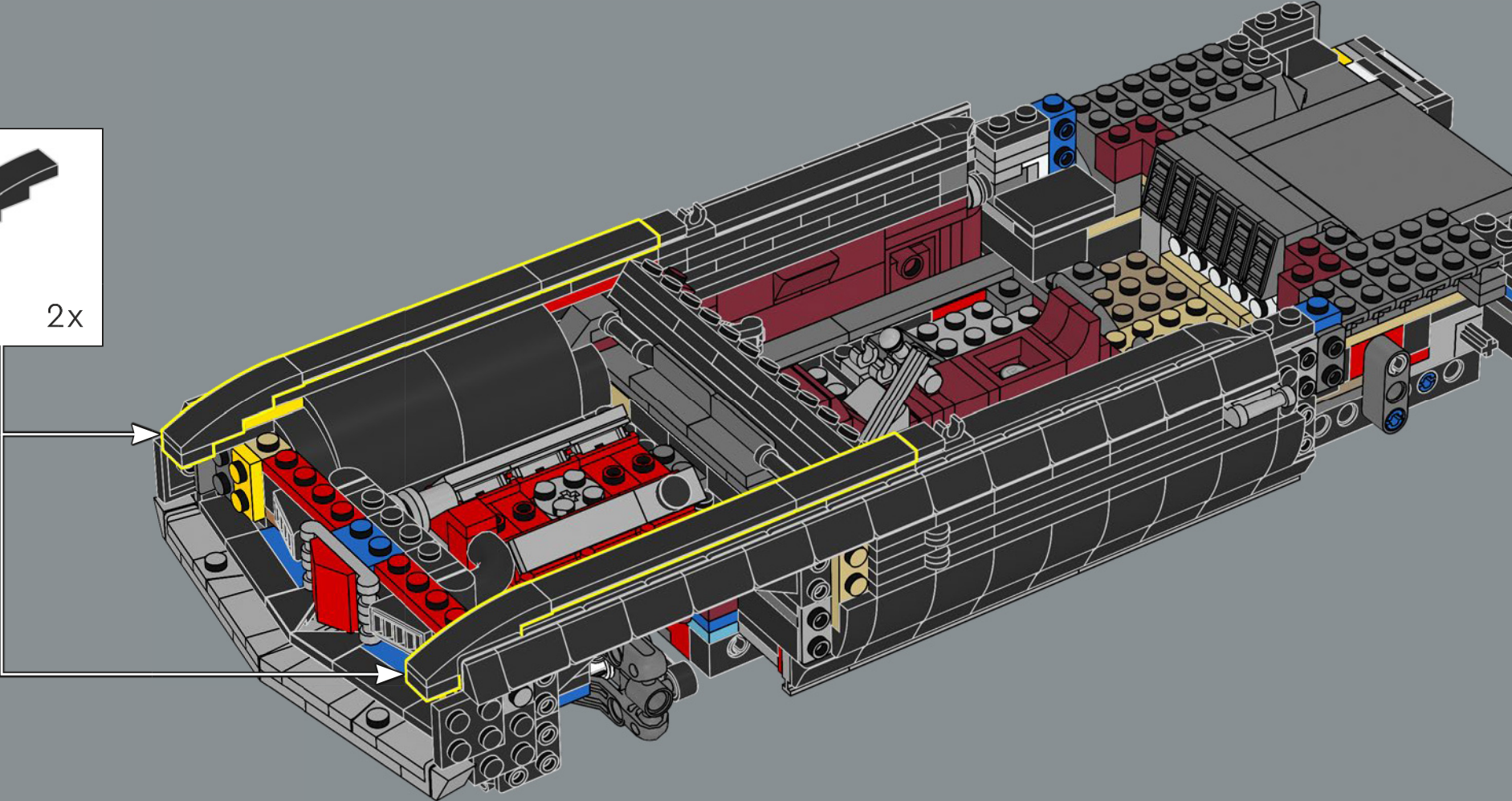
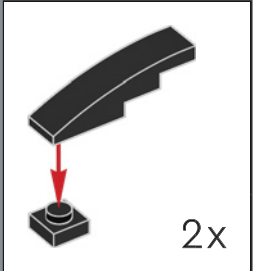

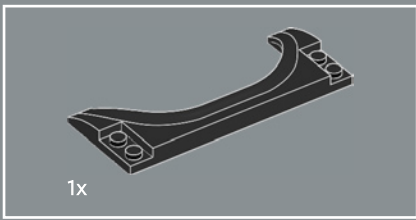

213

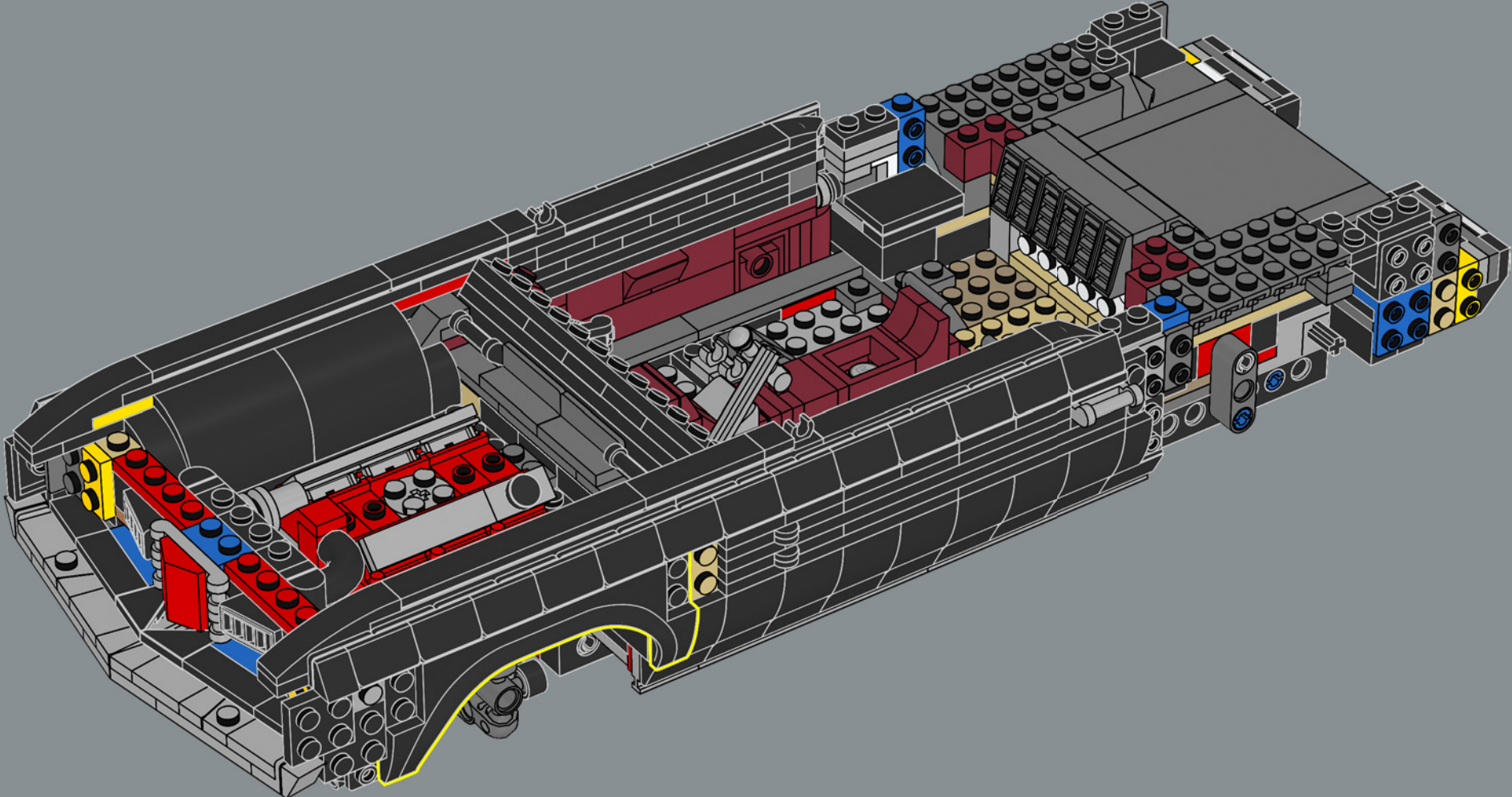

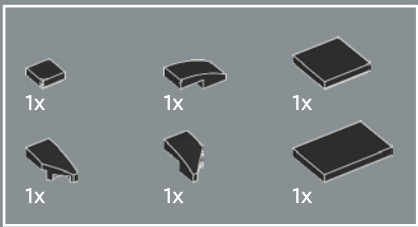

214

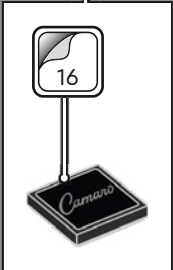
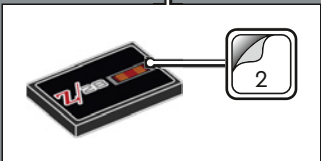
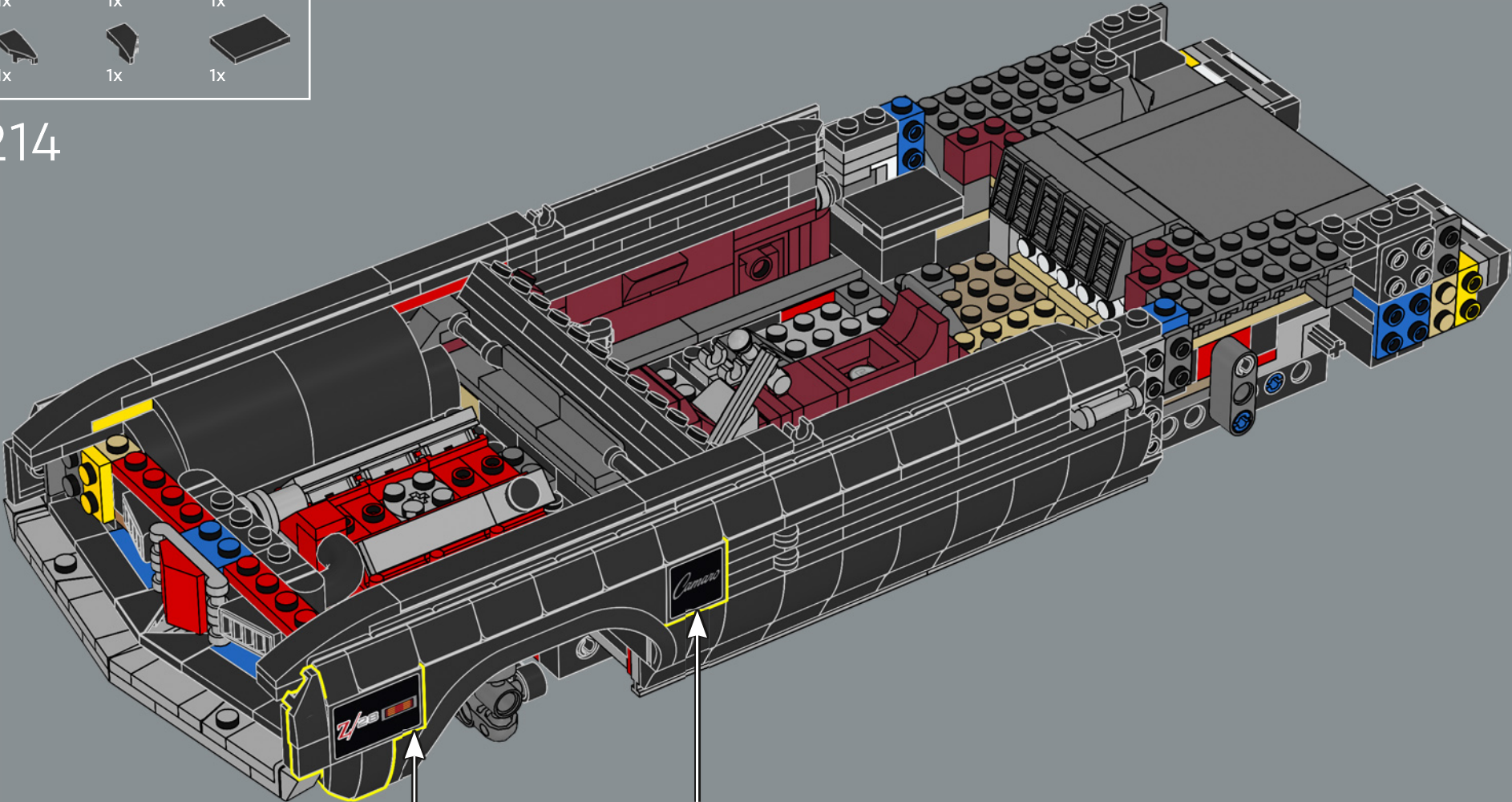



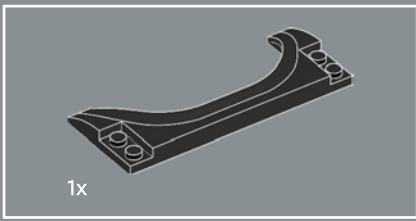

215

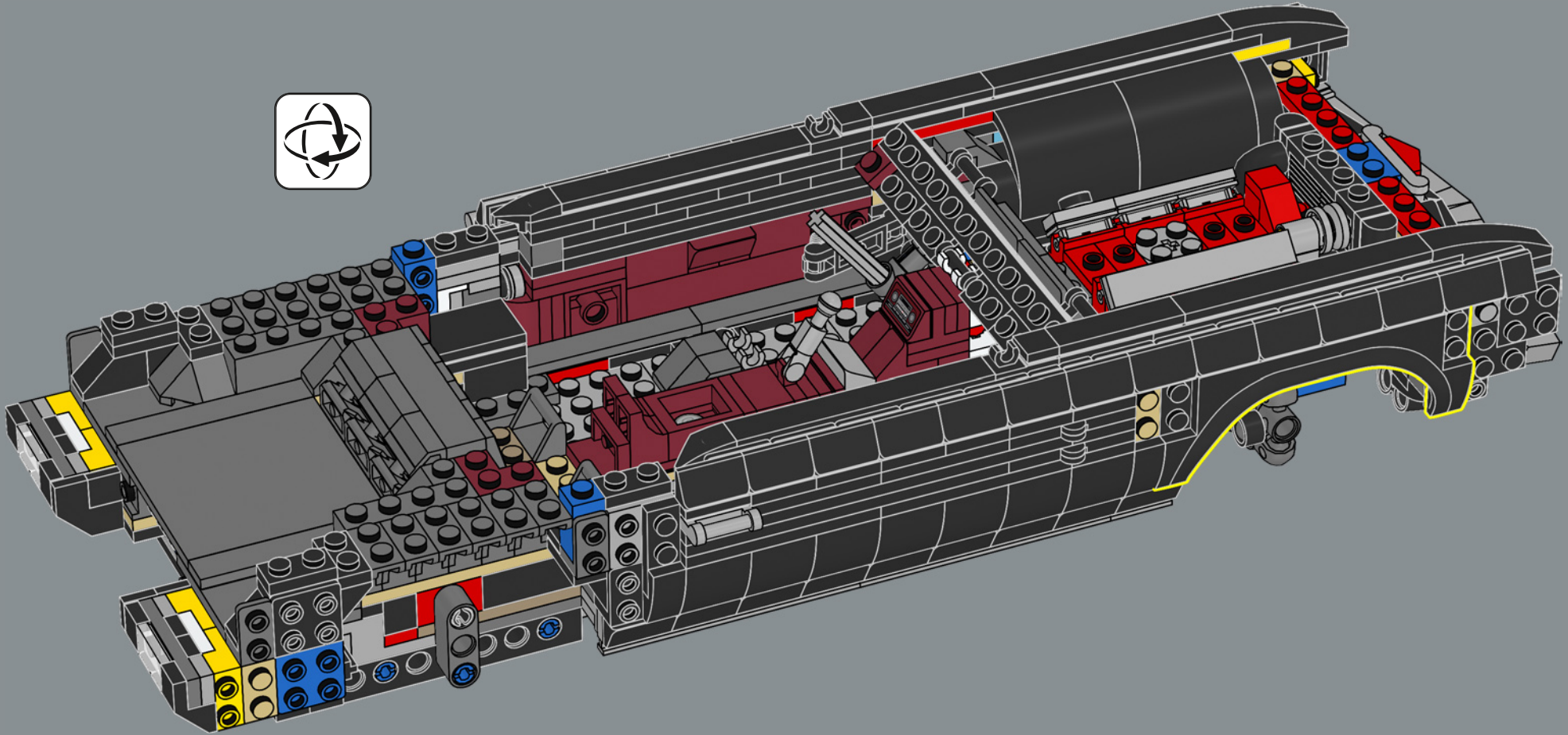

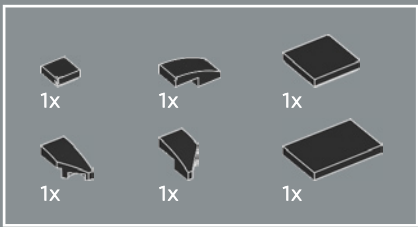

216

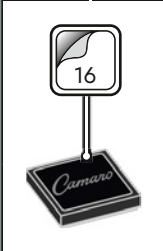
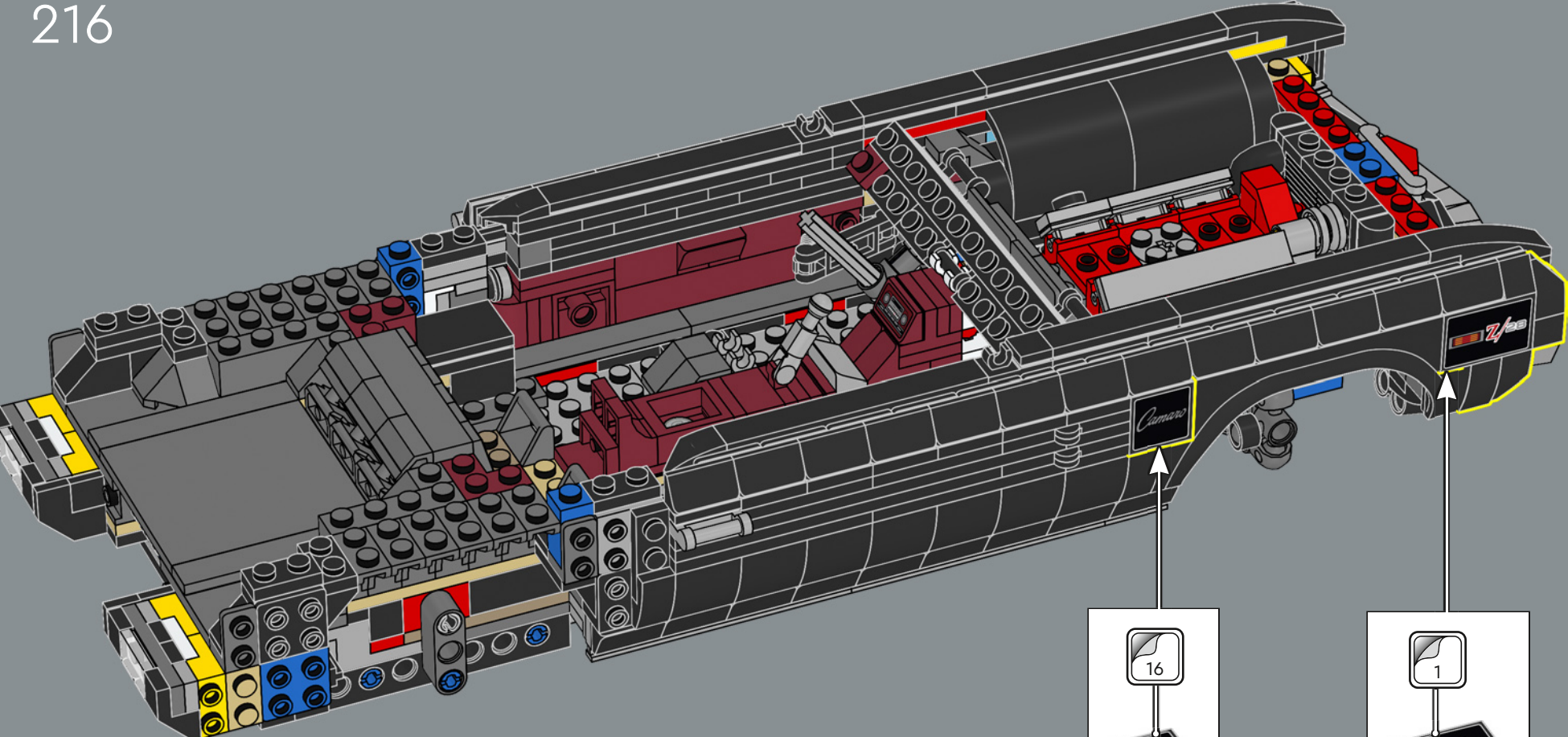

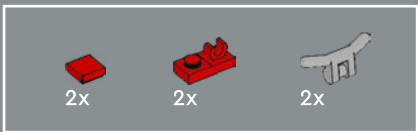

217

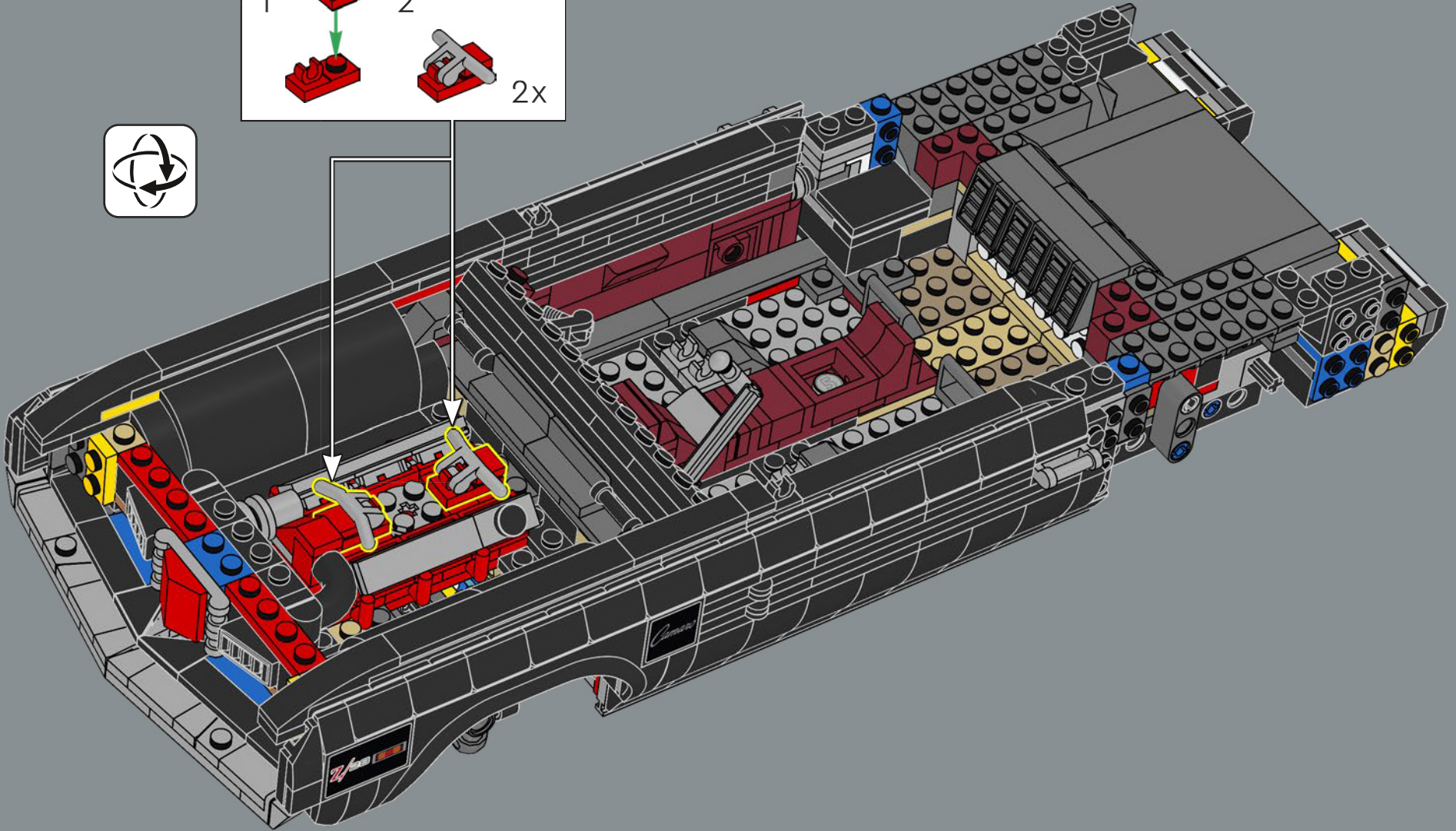
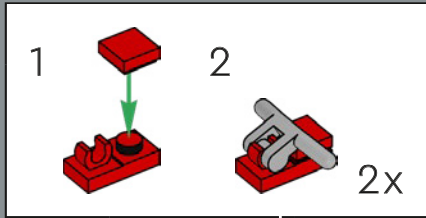

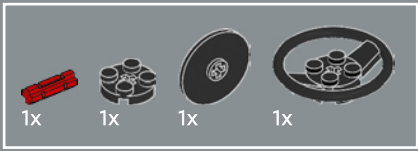

218

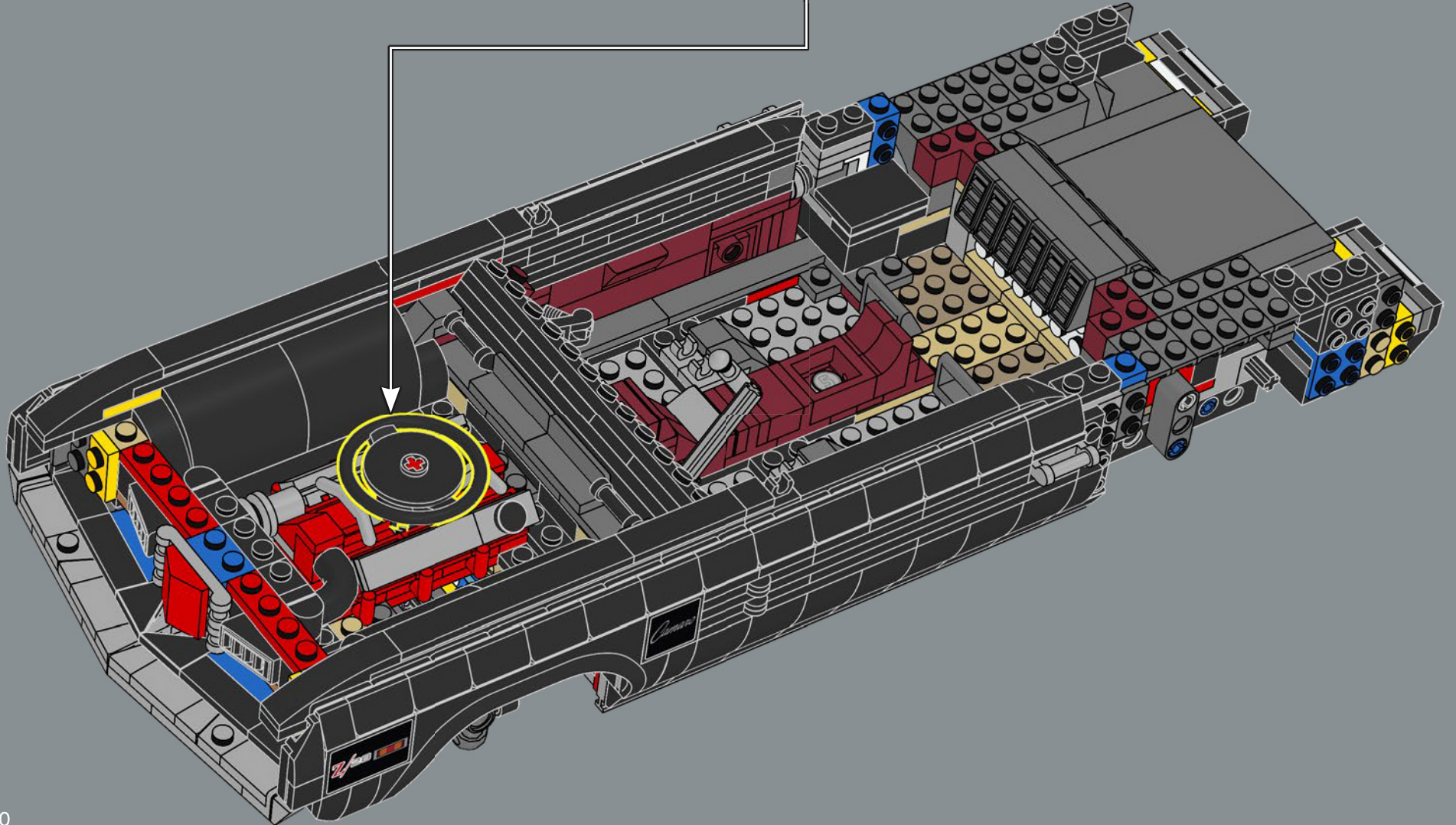
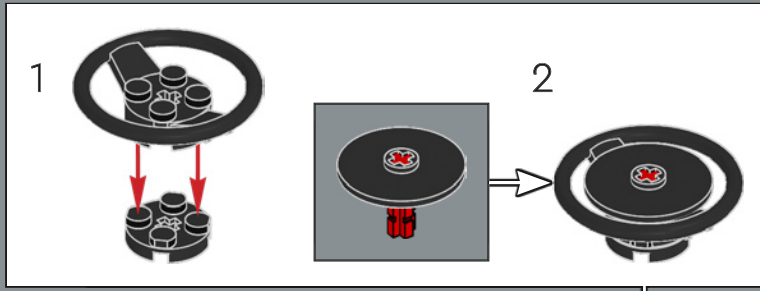

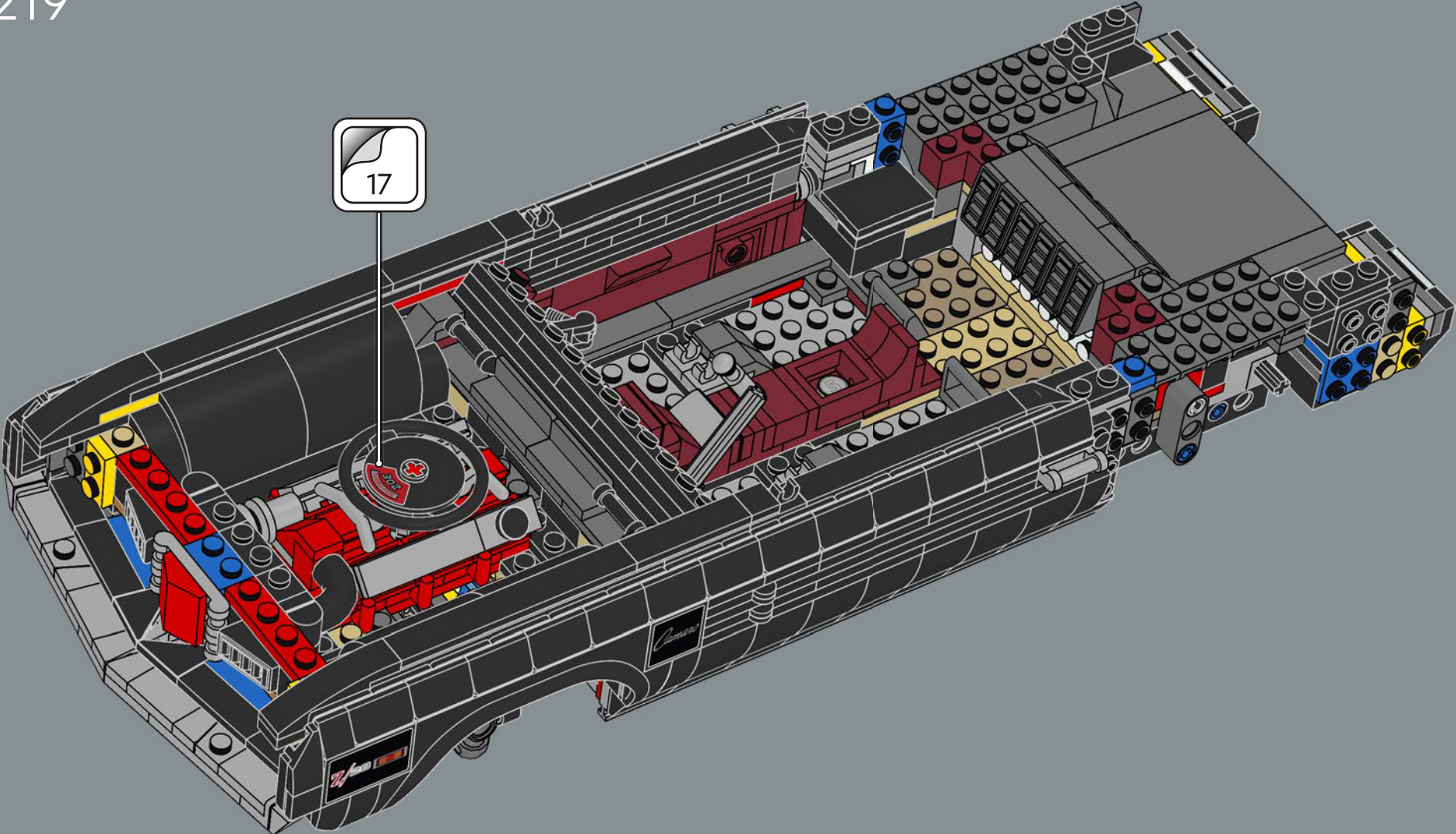

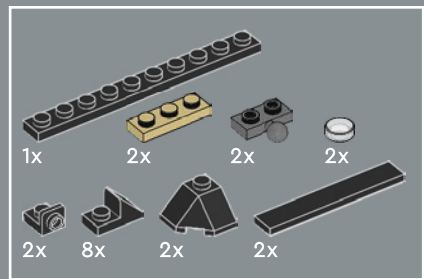

220

1

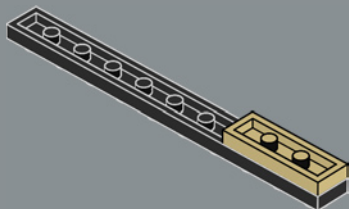

2

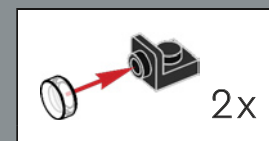
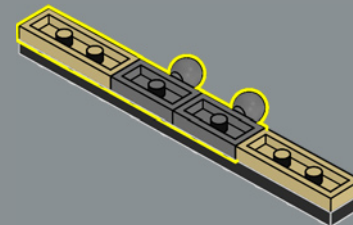

3

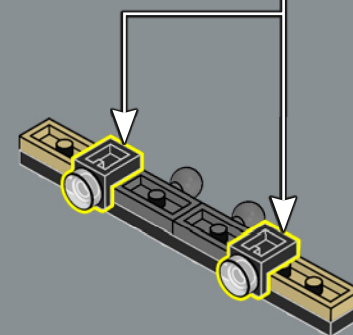

4

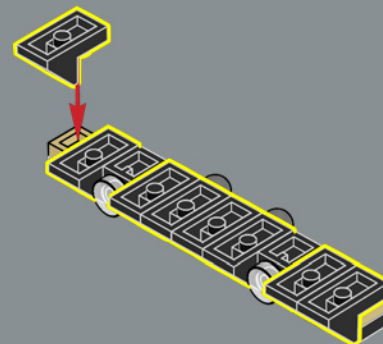

5

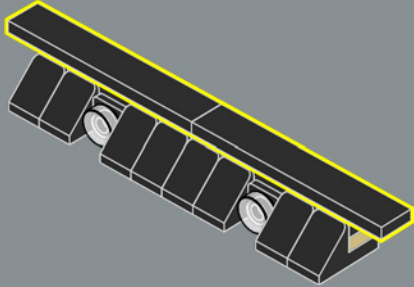

6

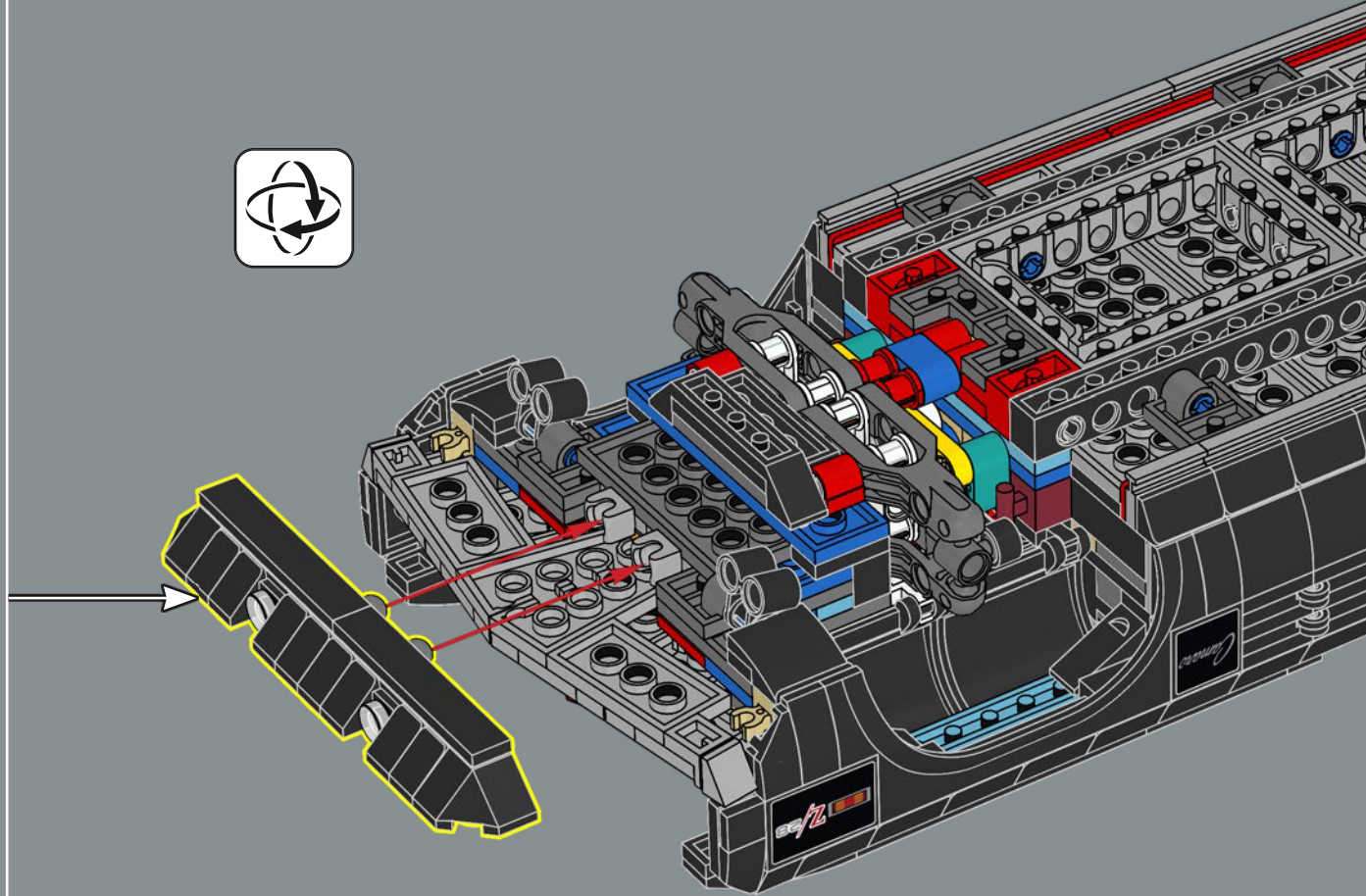
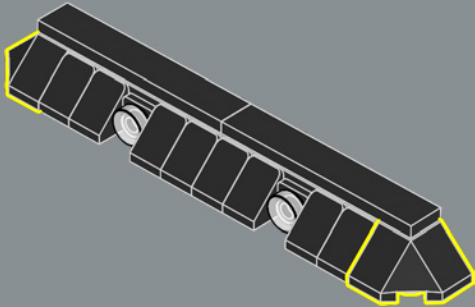

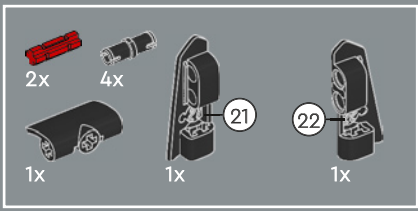

221

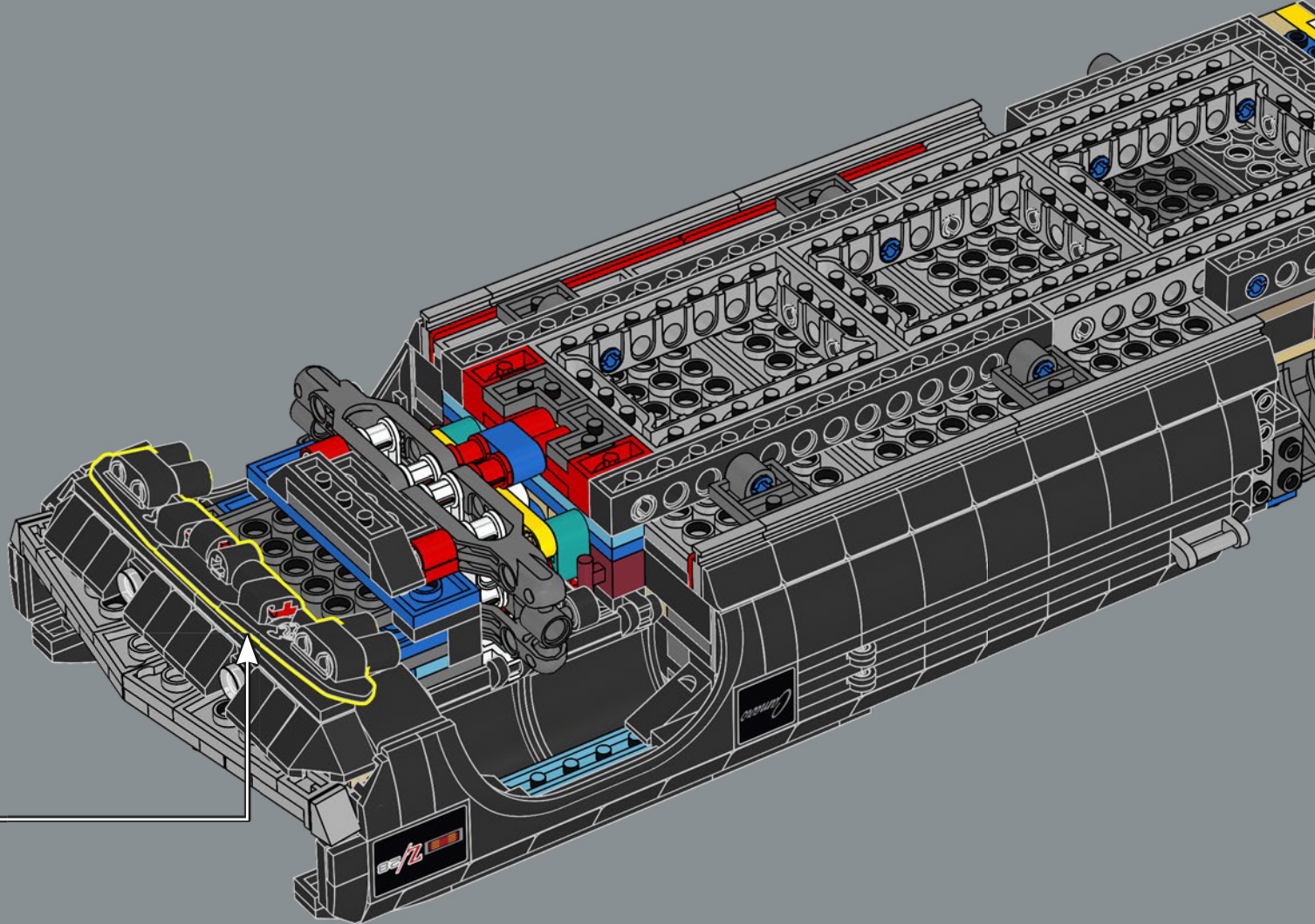
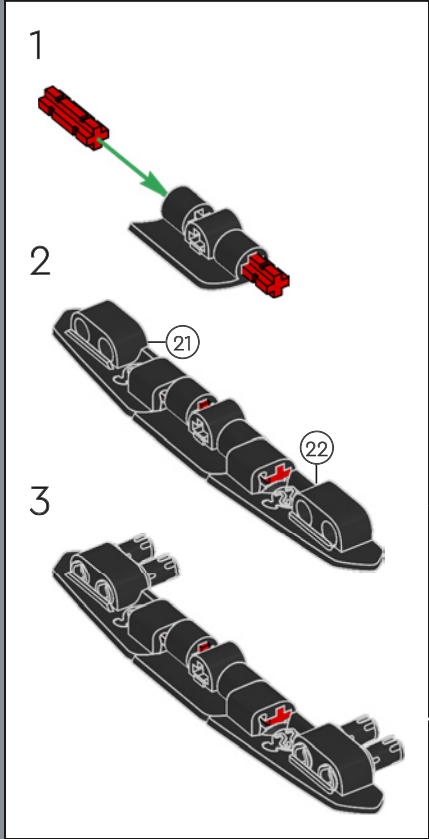





222

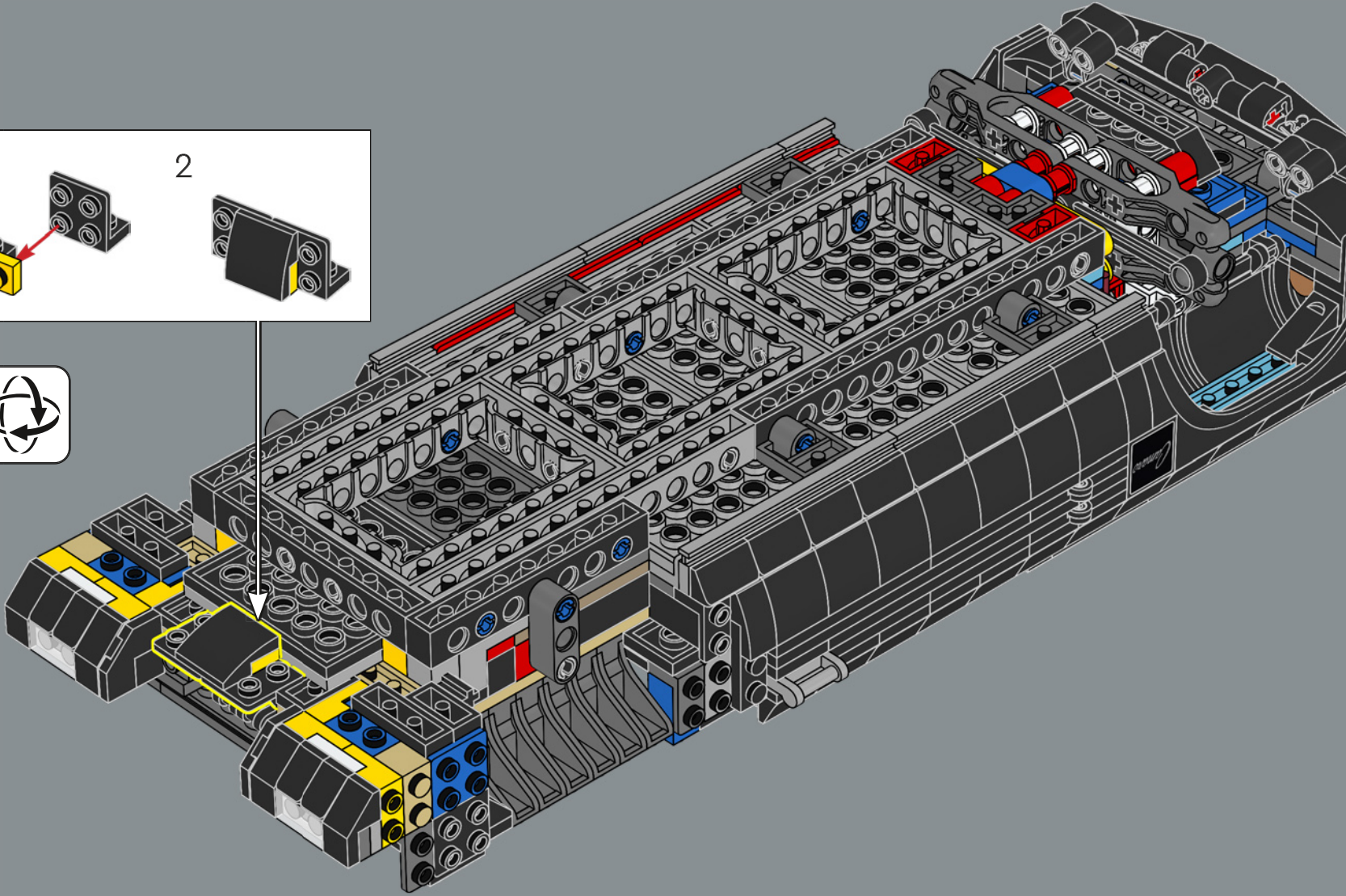
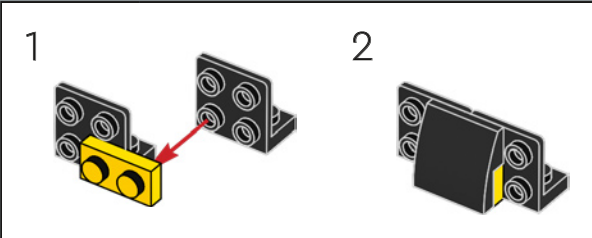

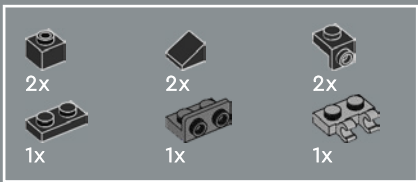

# 223

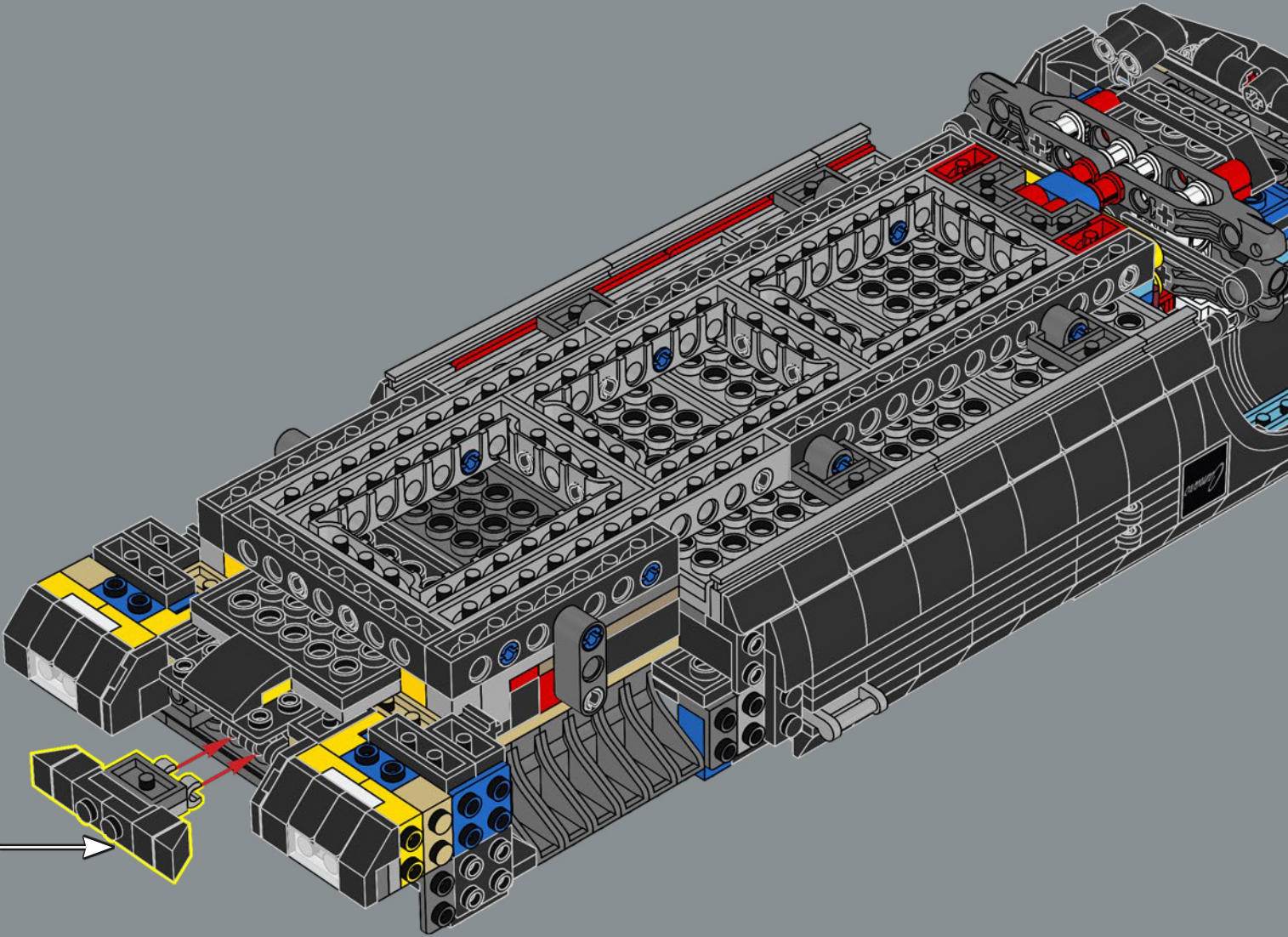
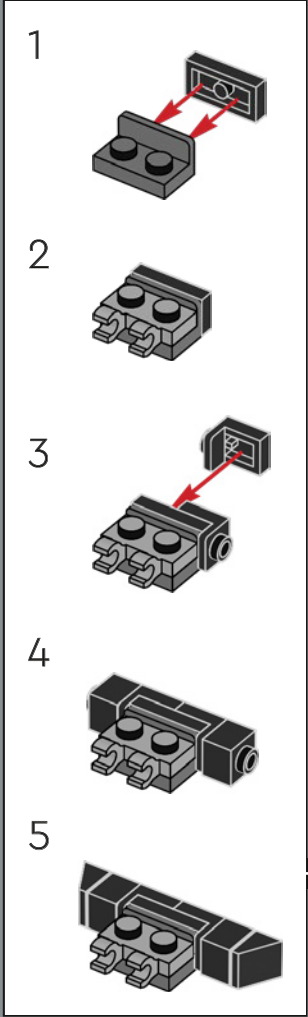

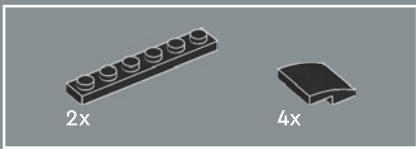

224

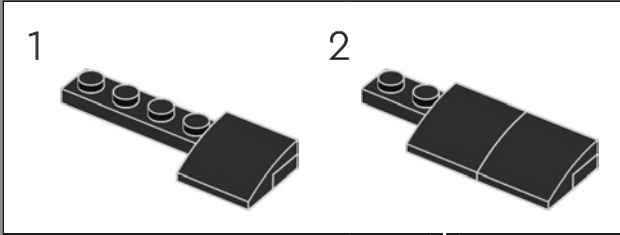

2

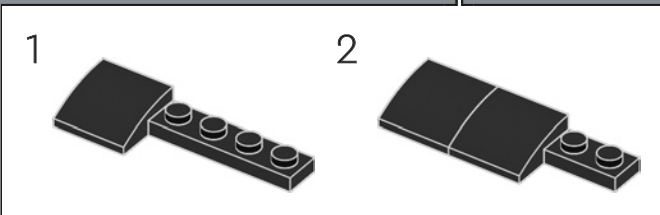
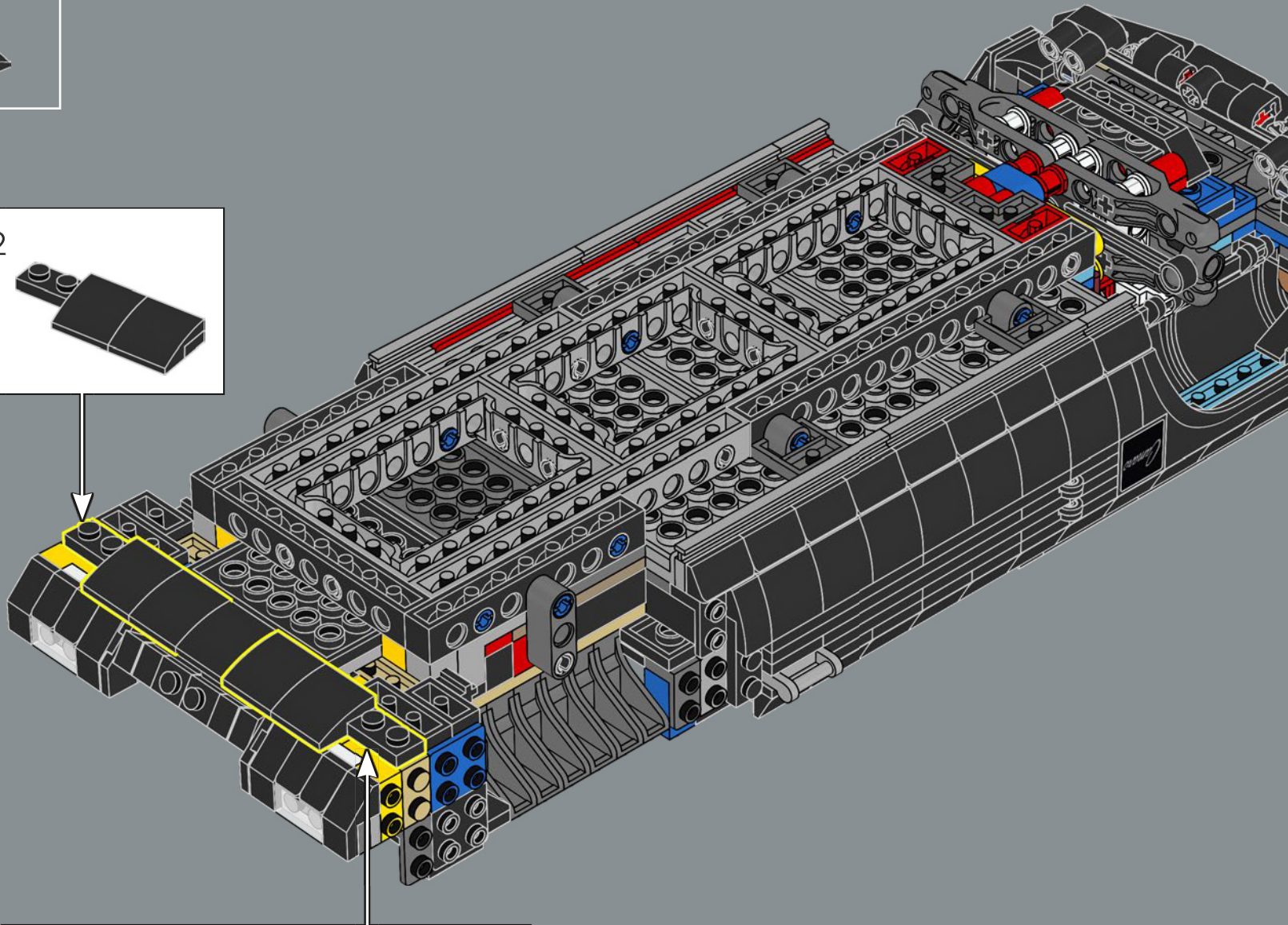
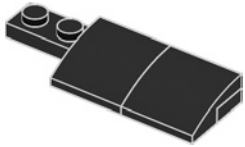

2

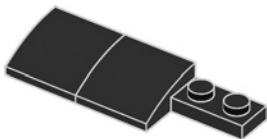



225

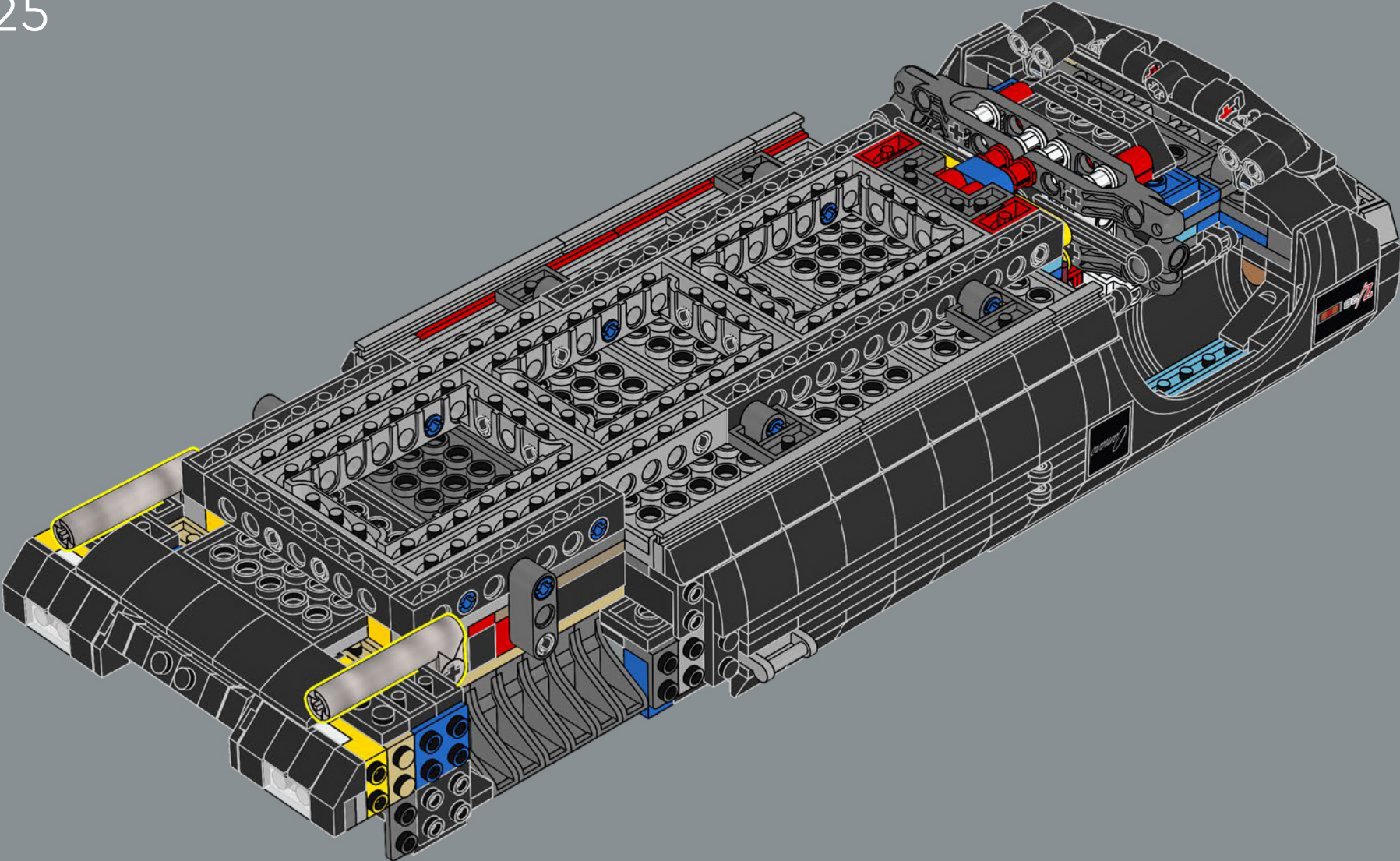

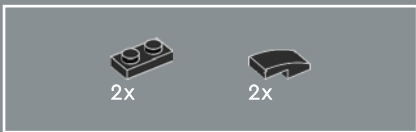

226

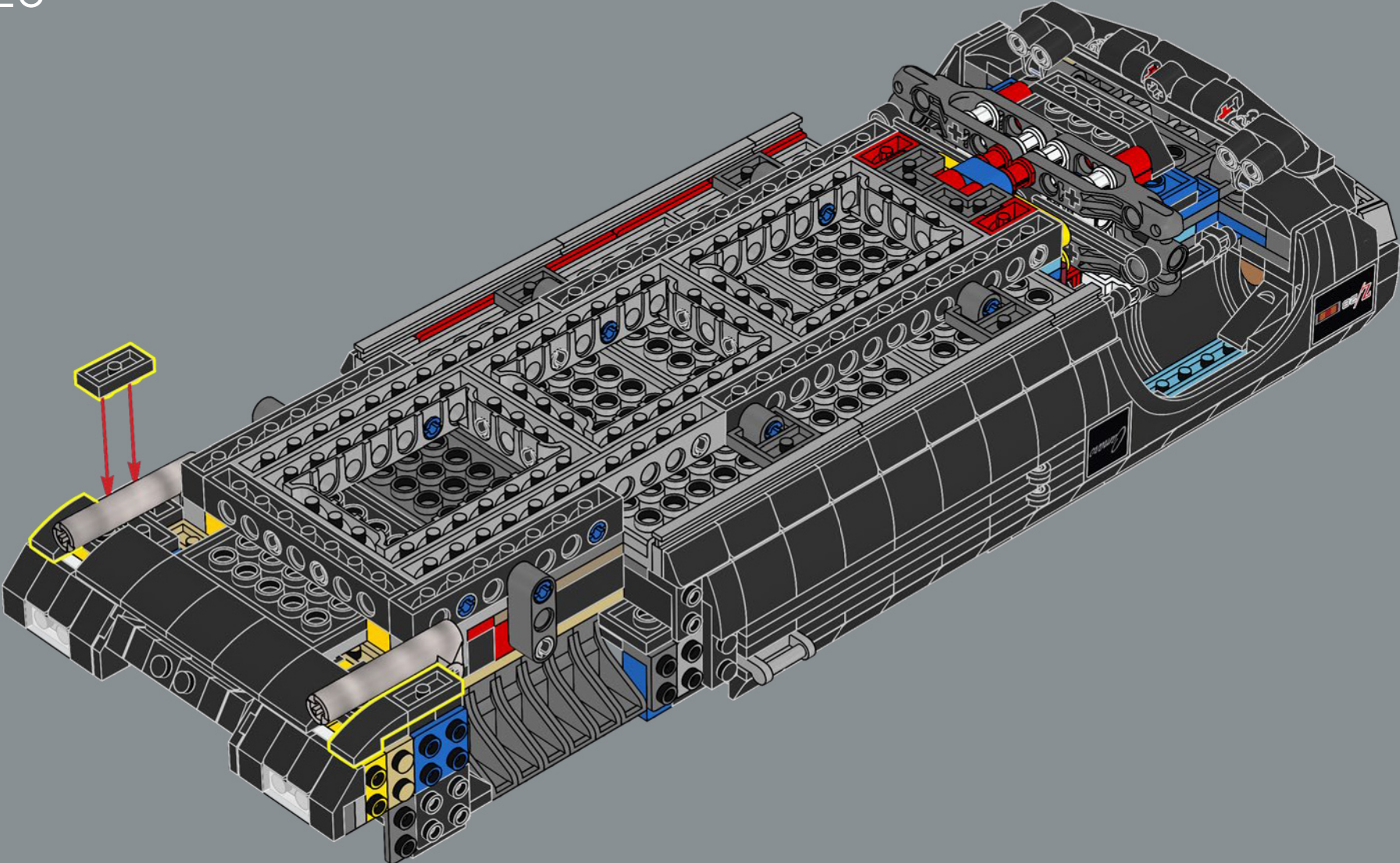

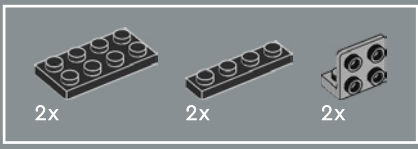

227

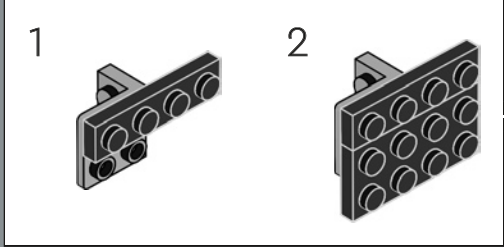
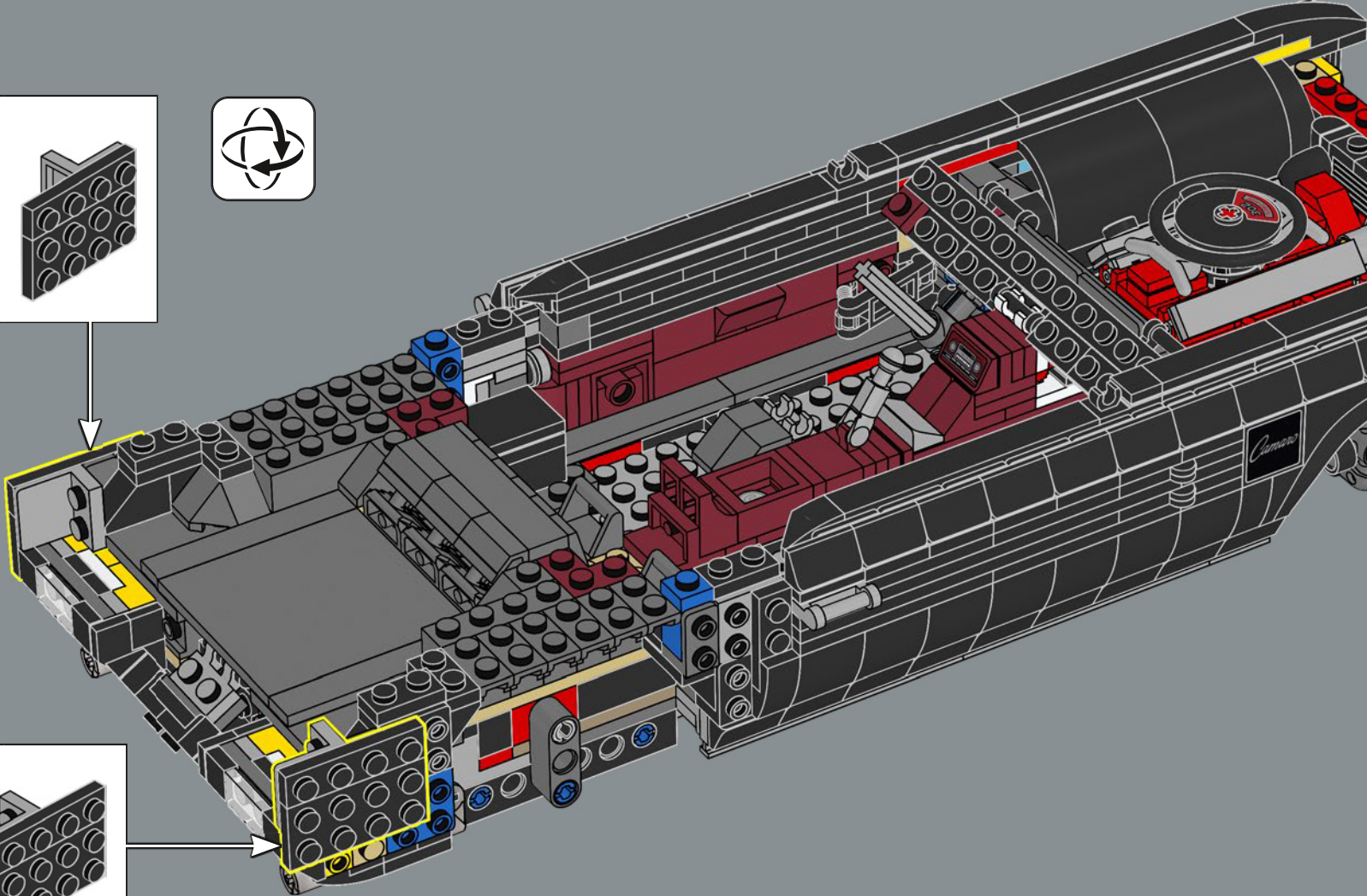
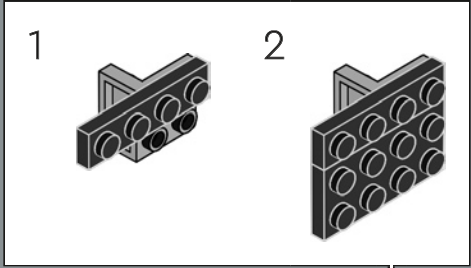

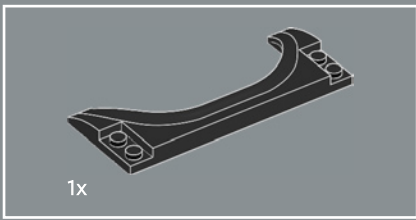

228

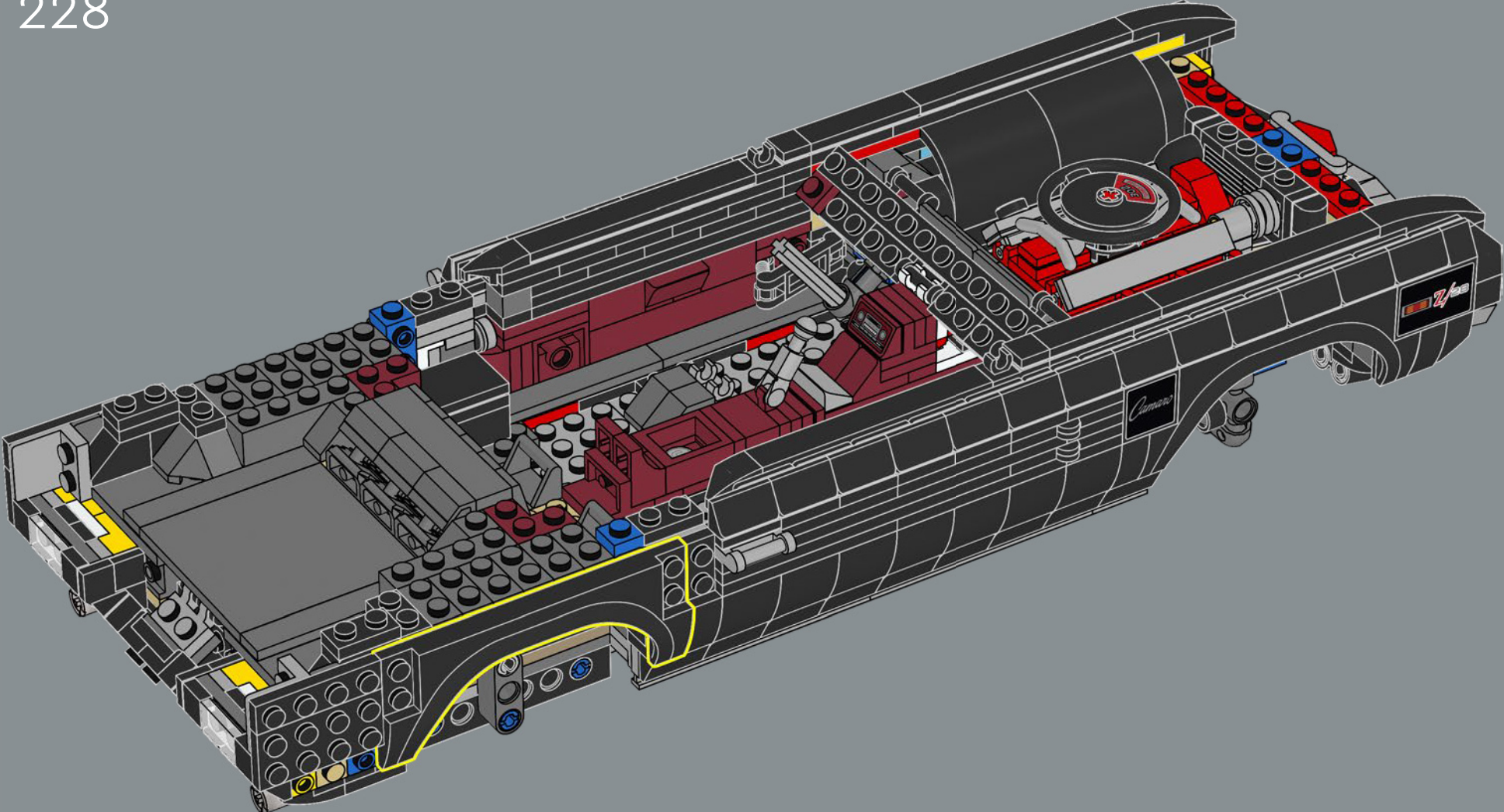

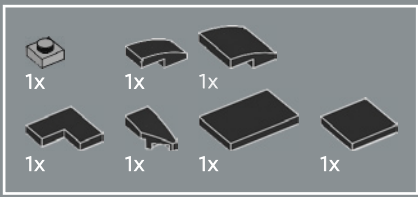

229

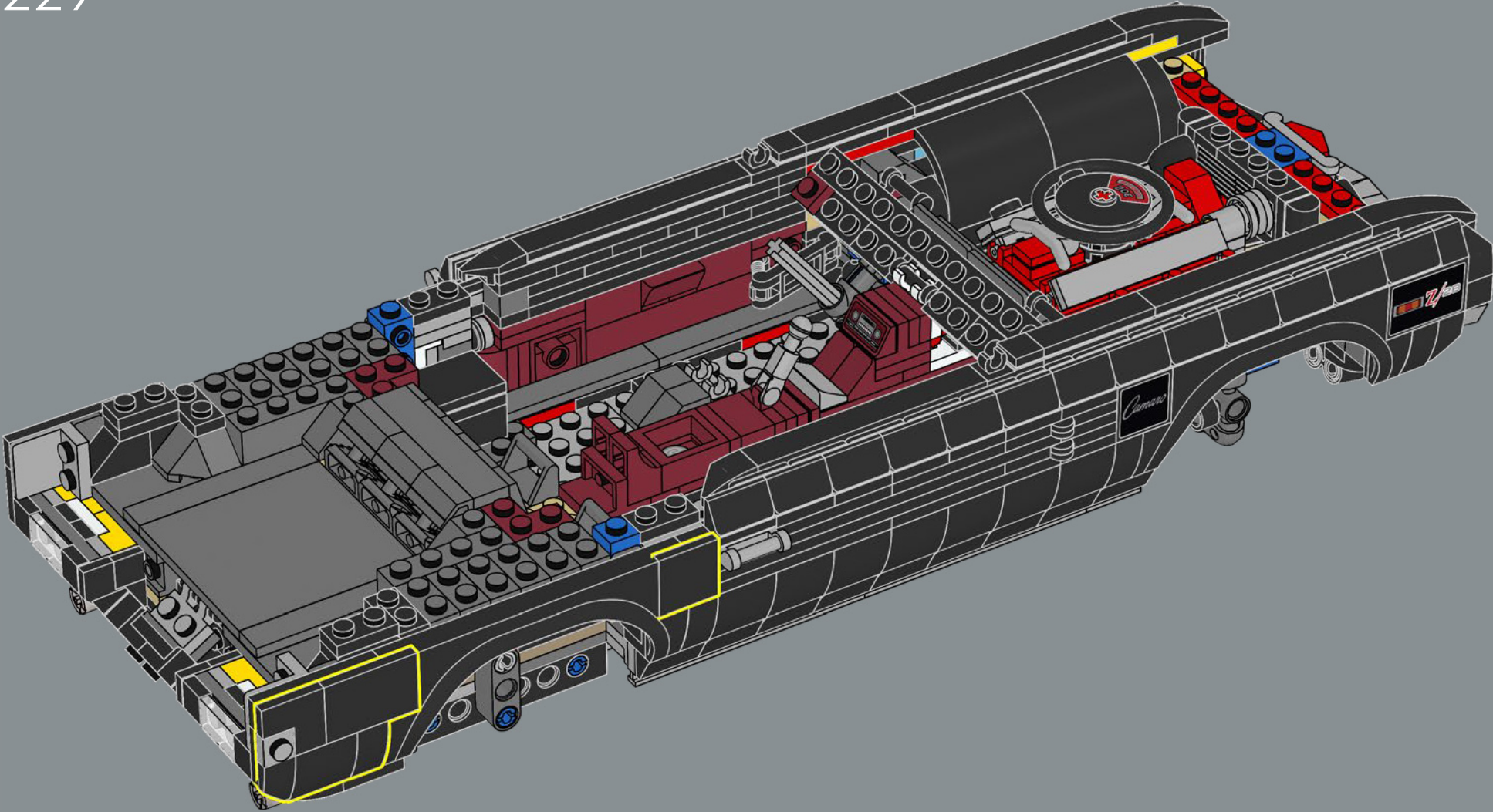



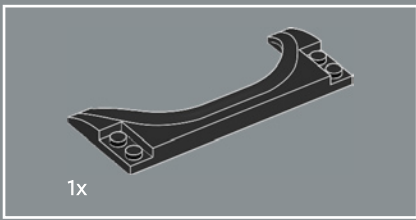

230

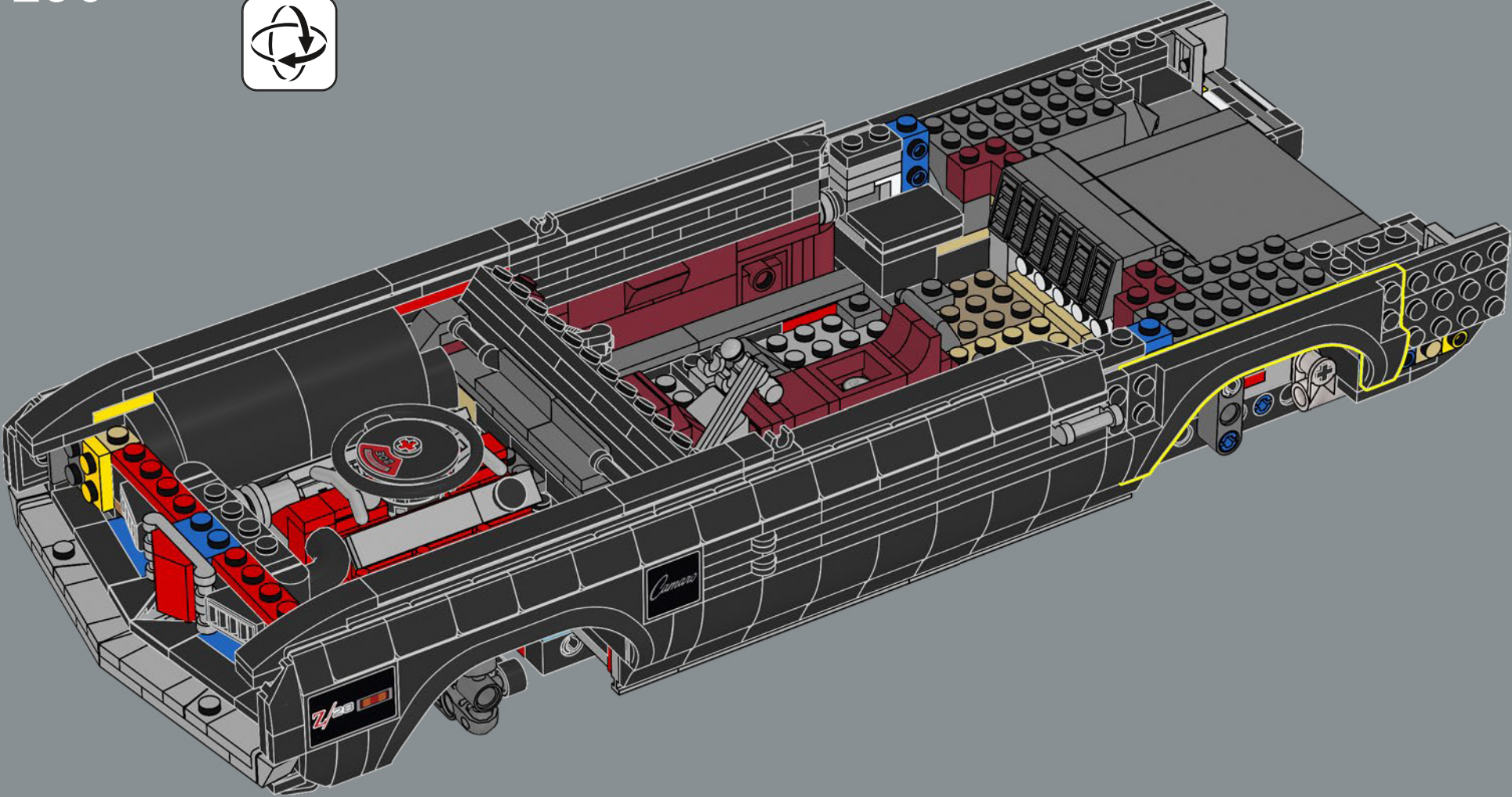

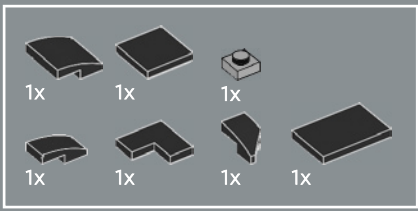

231

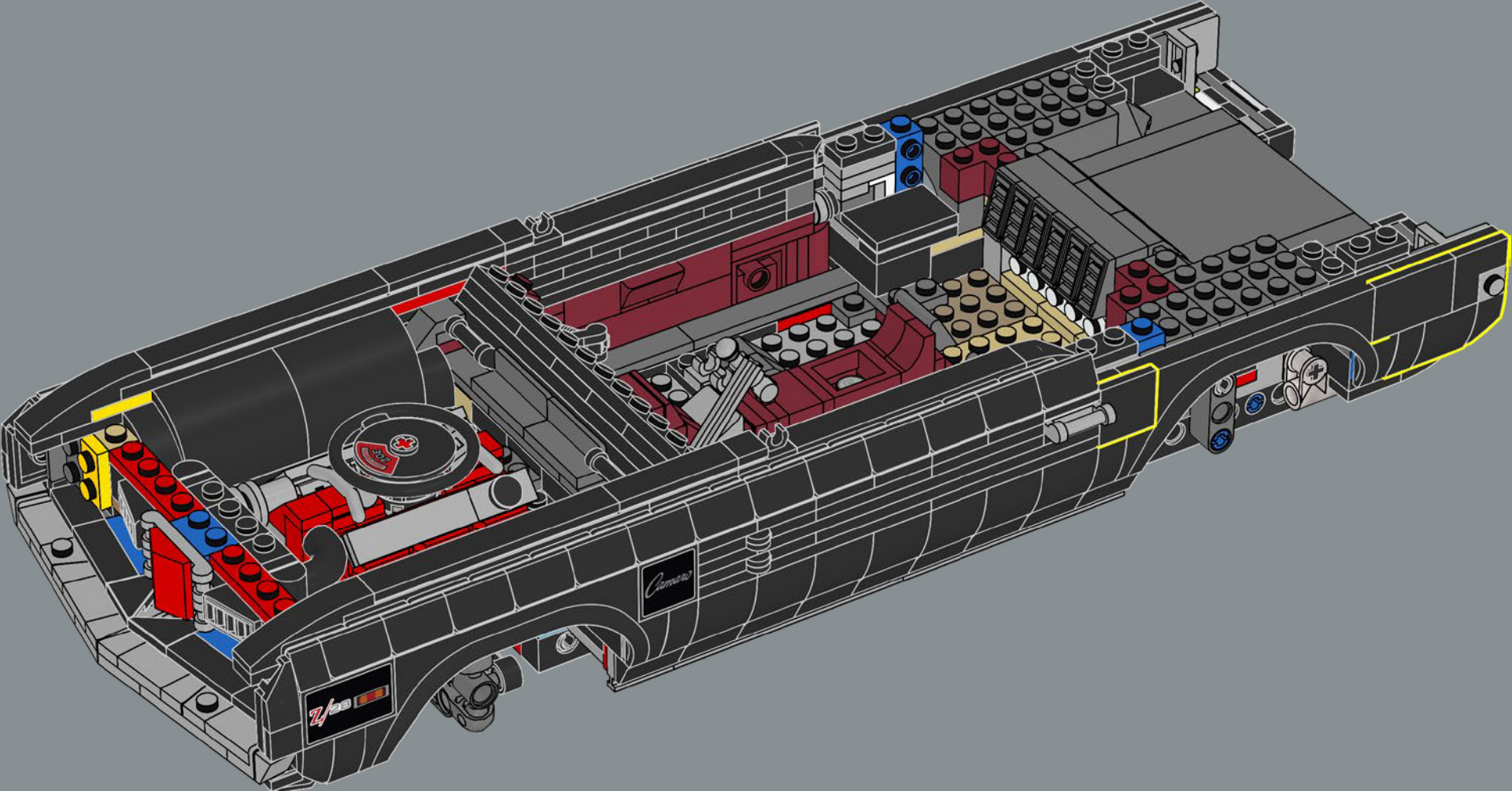



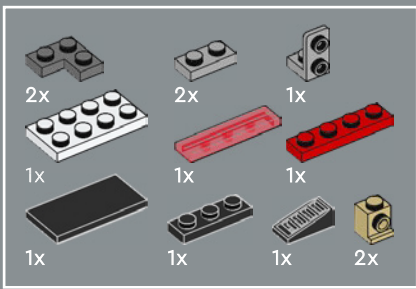

# 233

1



2



3

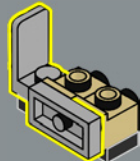

4

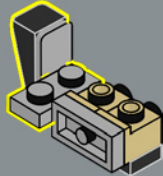

5

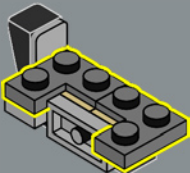

6

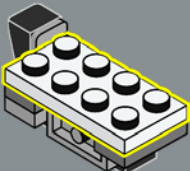

7

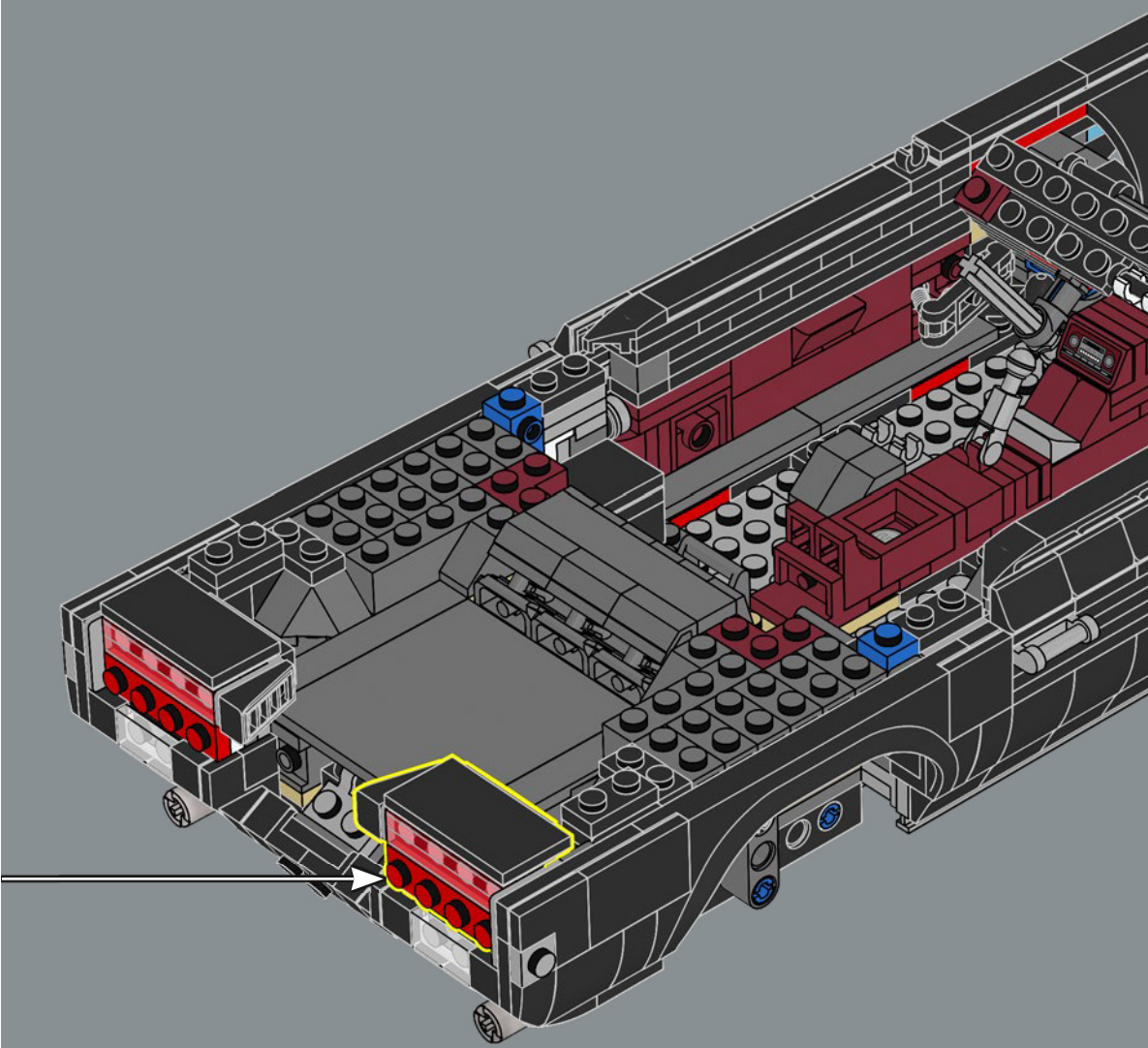
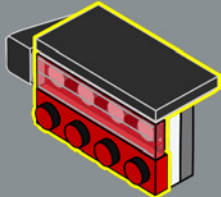

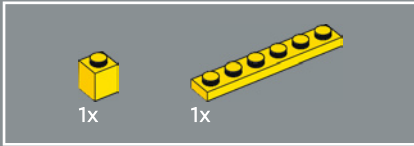
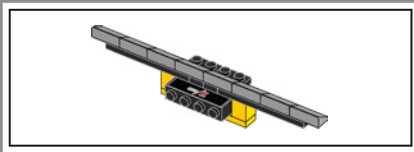

234

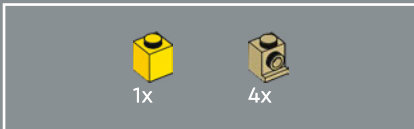
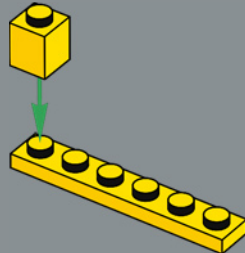

235

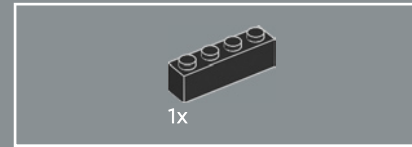
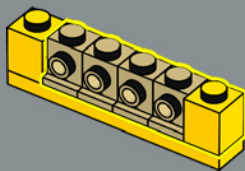

236

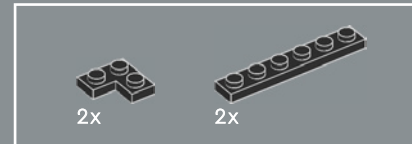
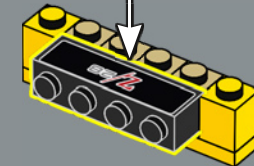
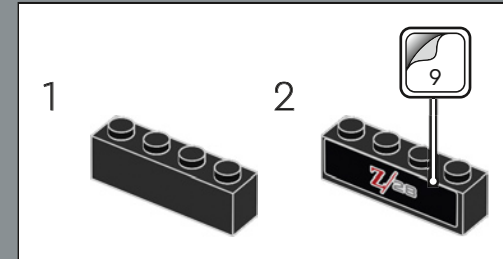

237

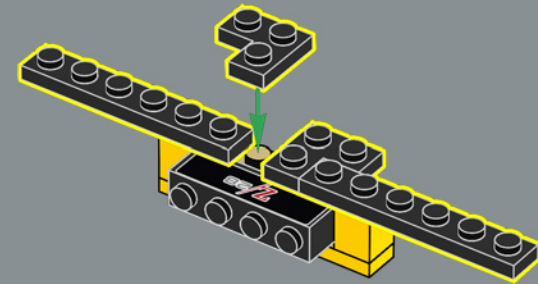



2x

238

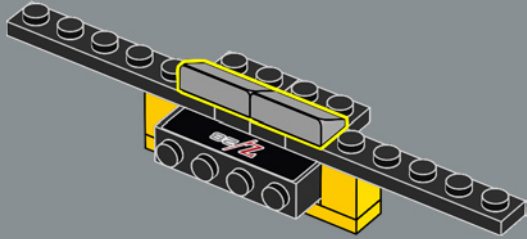

6x

239

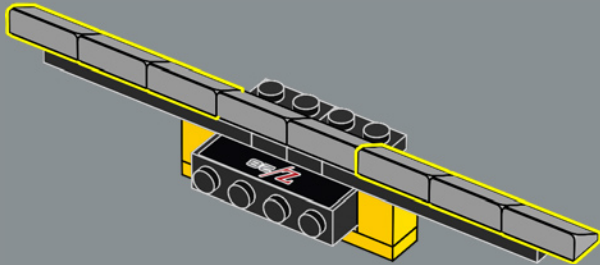

240

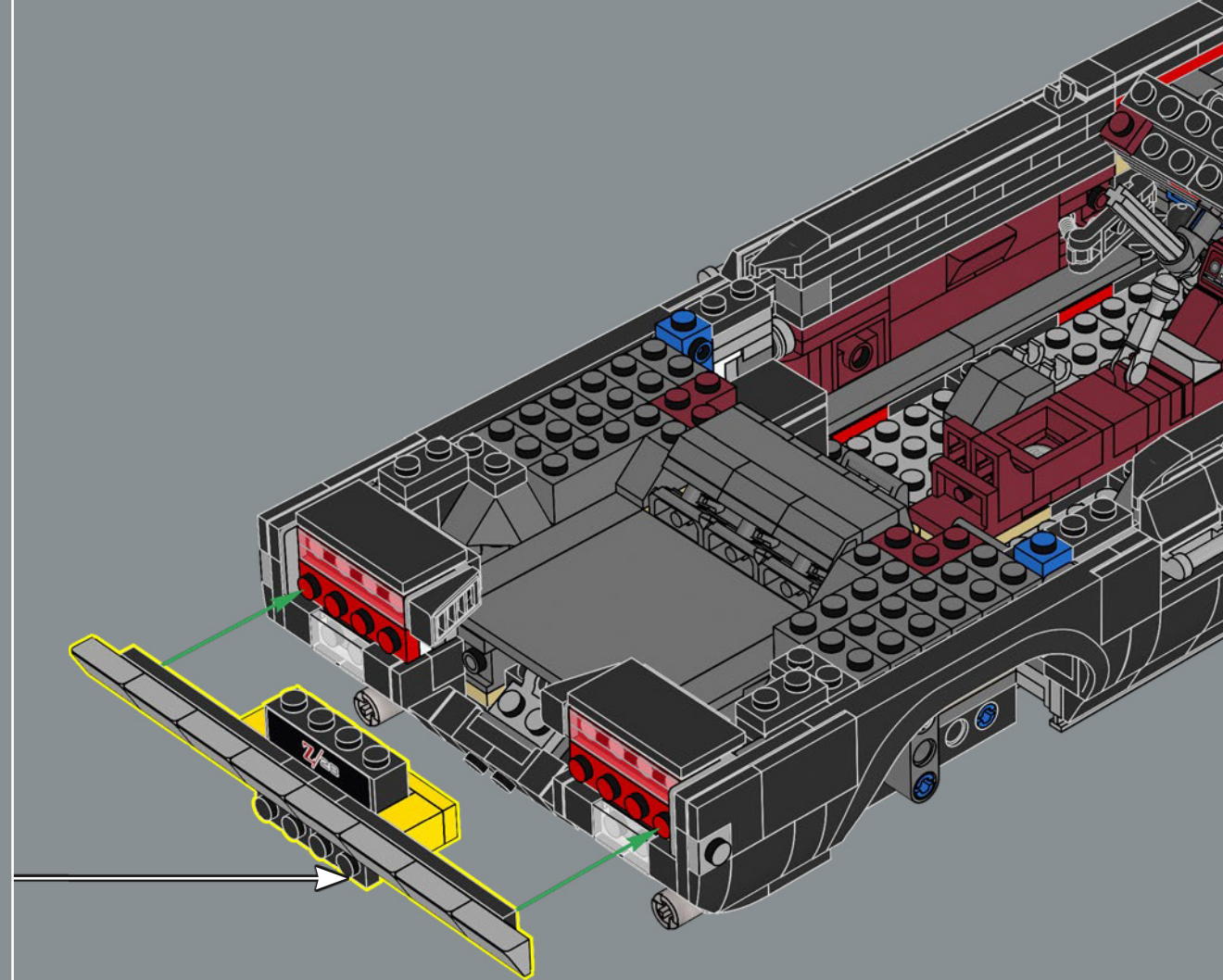

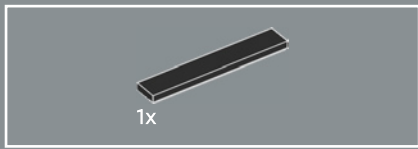

241

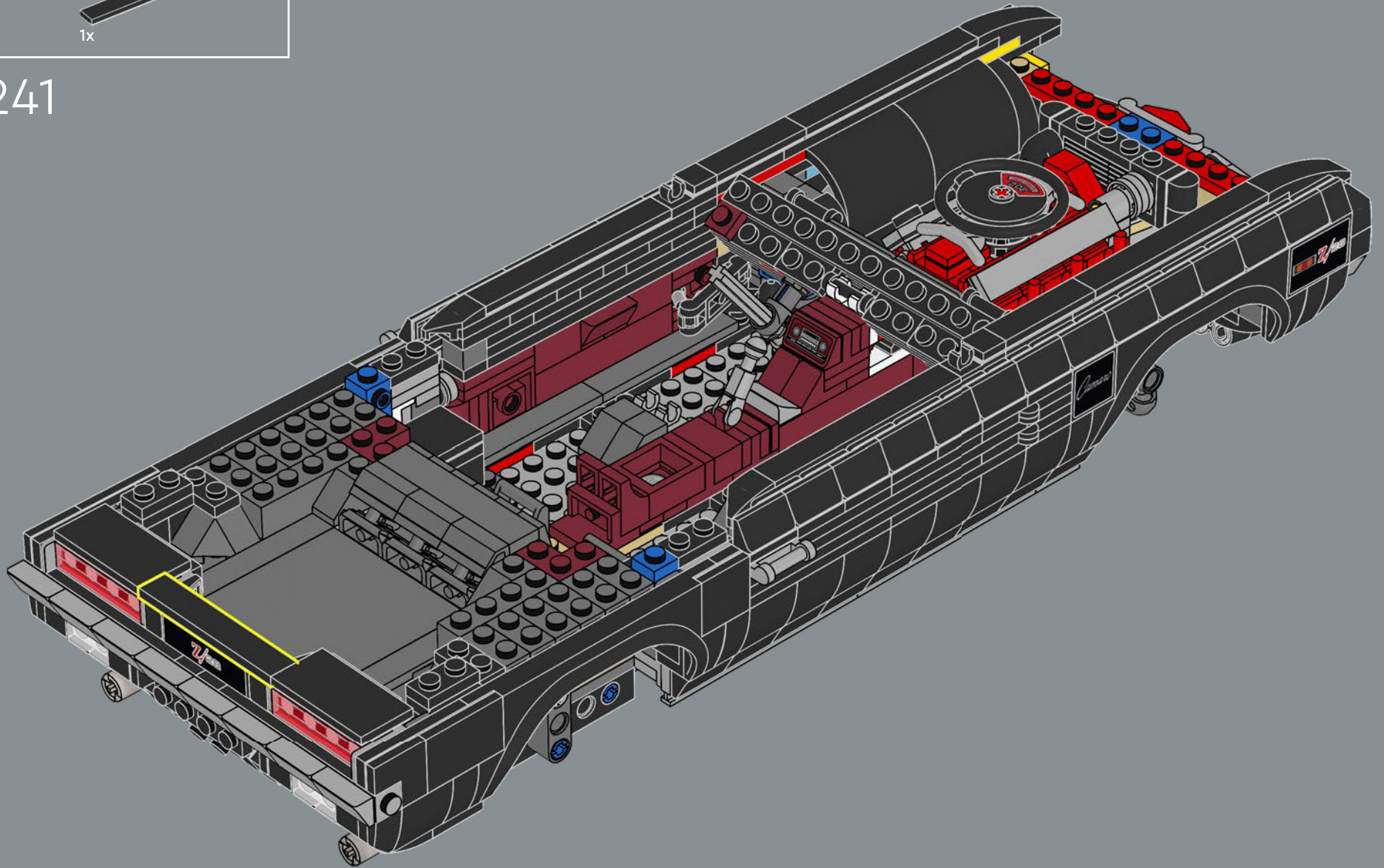

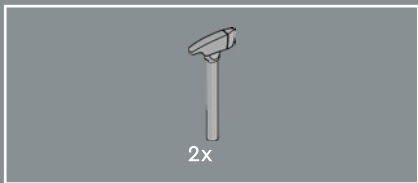

242

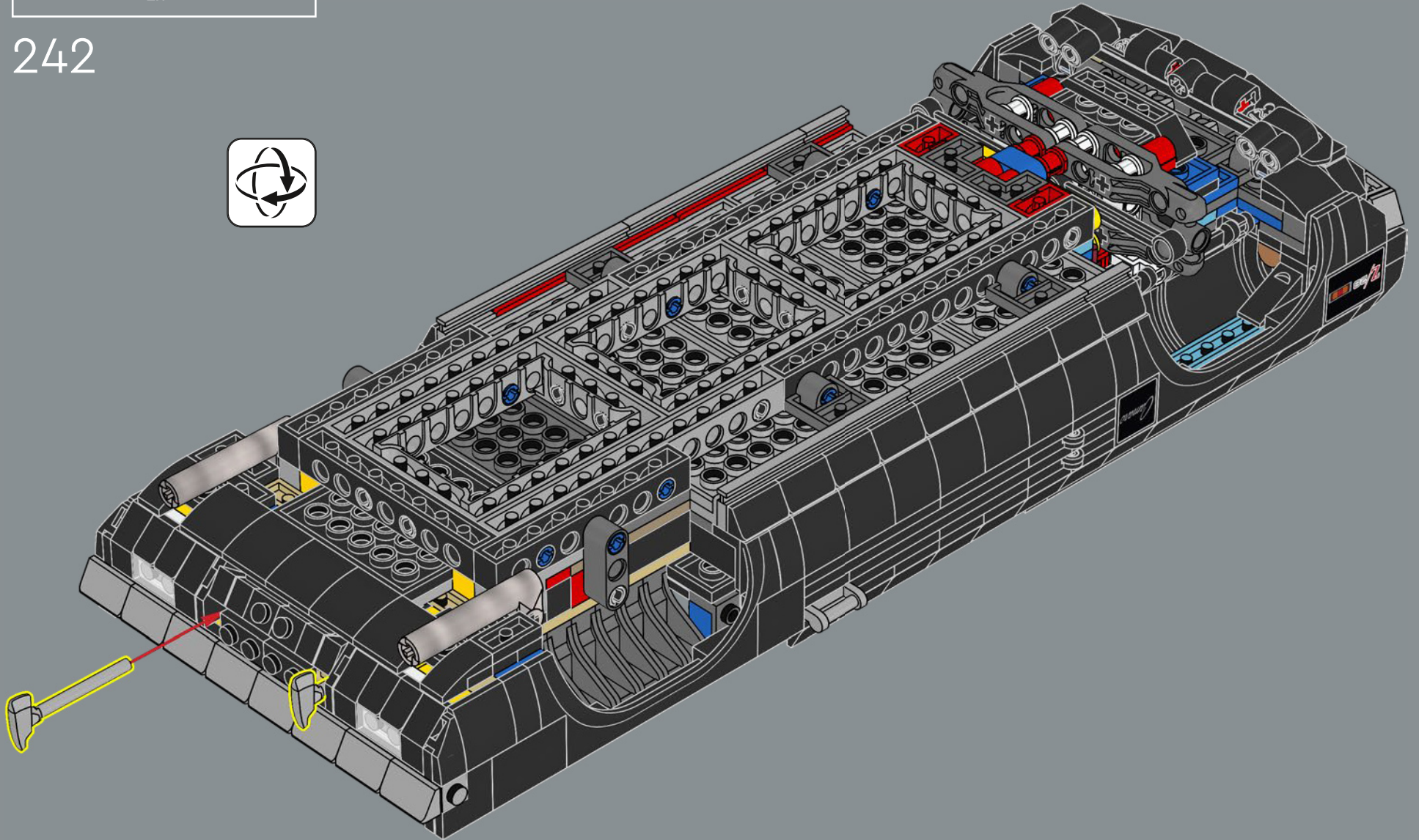



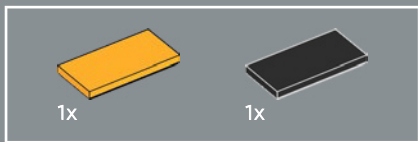

与大多数雪佛兰不同, 前 3 代 Camaro 并非在底特律制造, 而是在俄亥俄州诺伍德和加利福尼亚州凡奈斯的工厂制造。

243

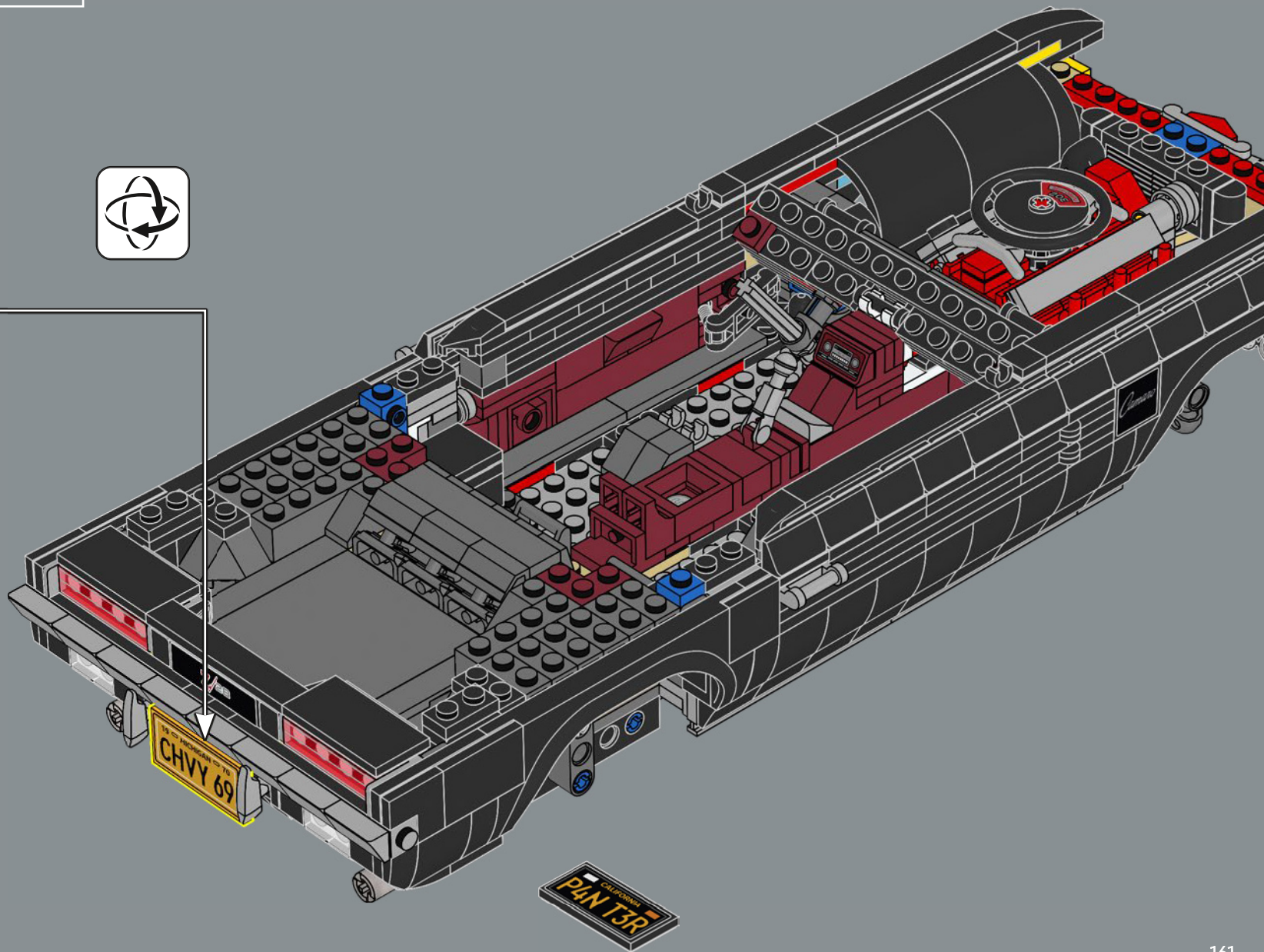
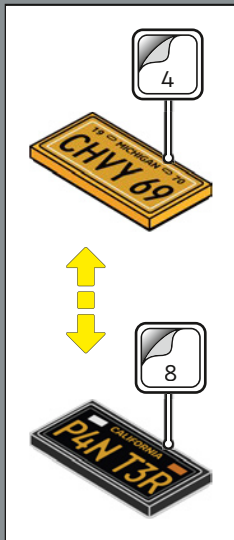

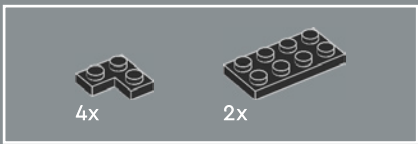

244

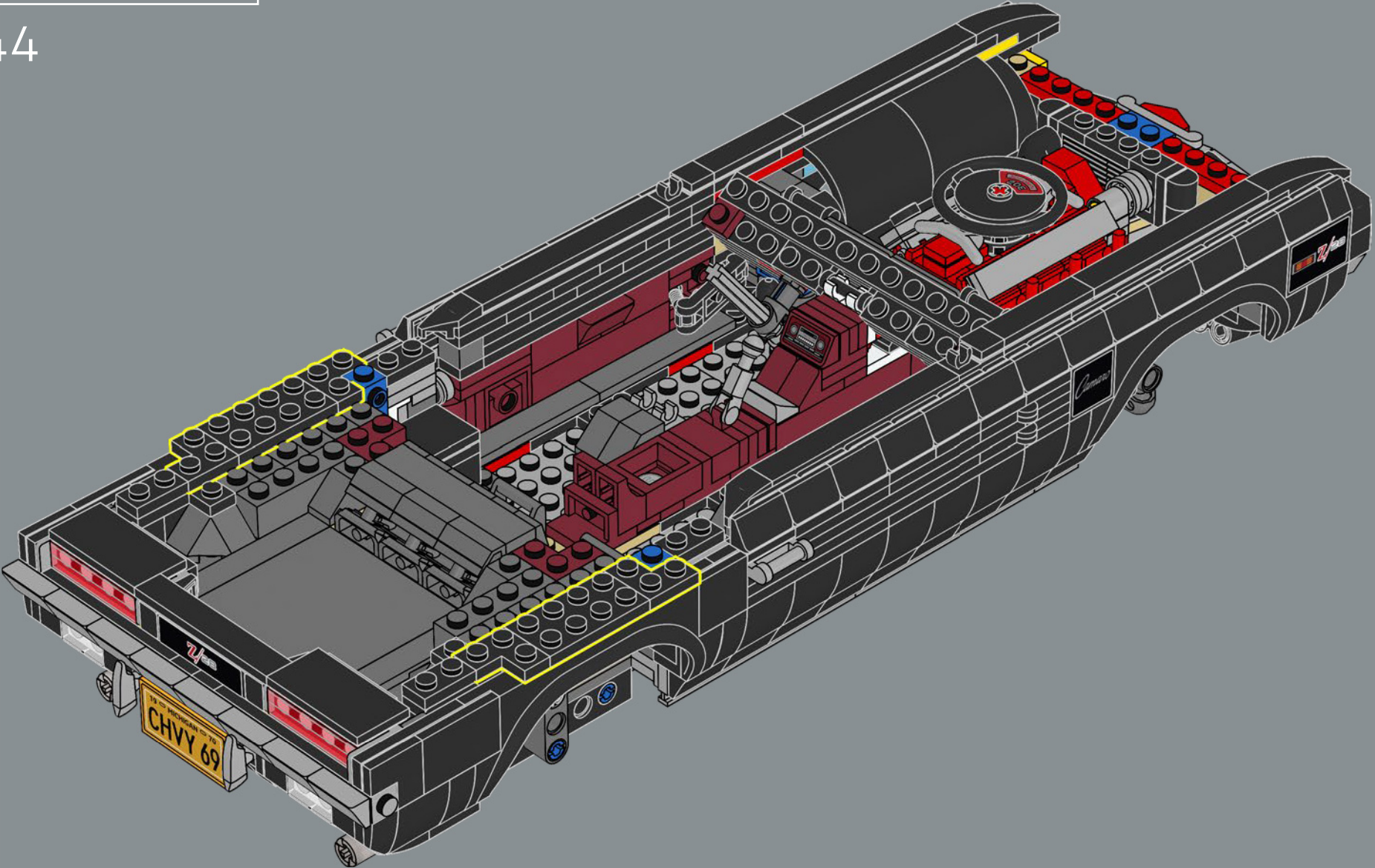

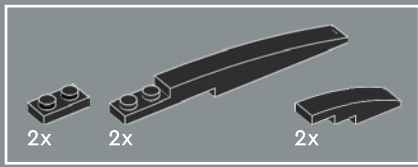

245

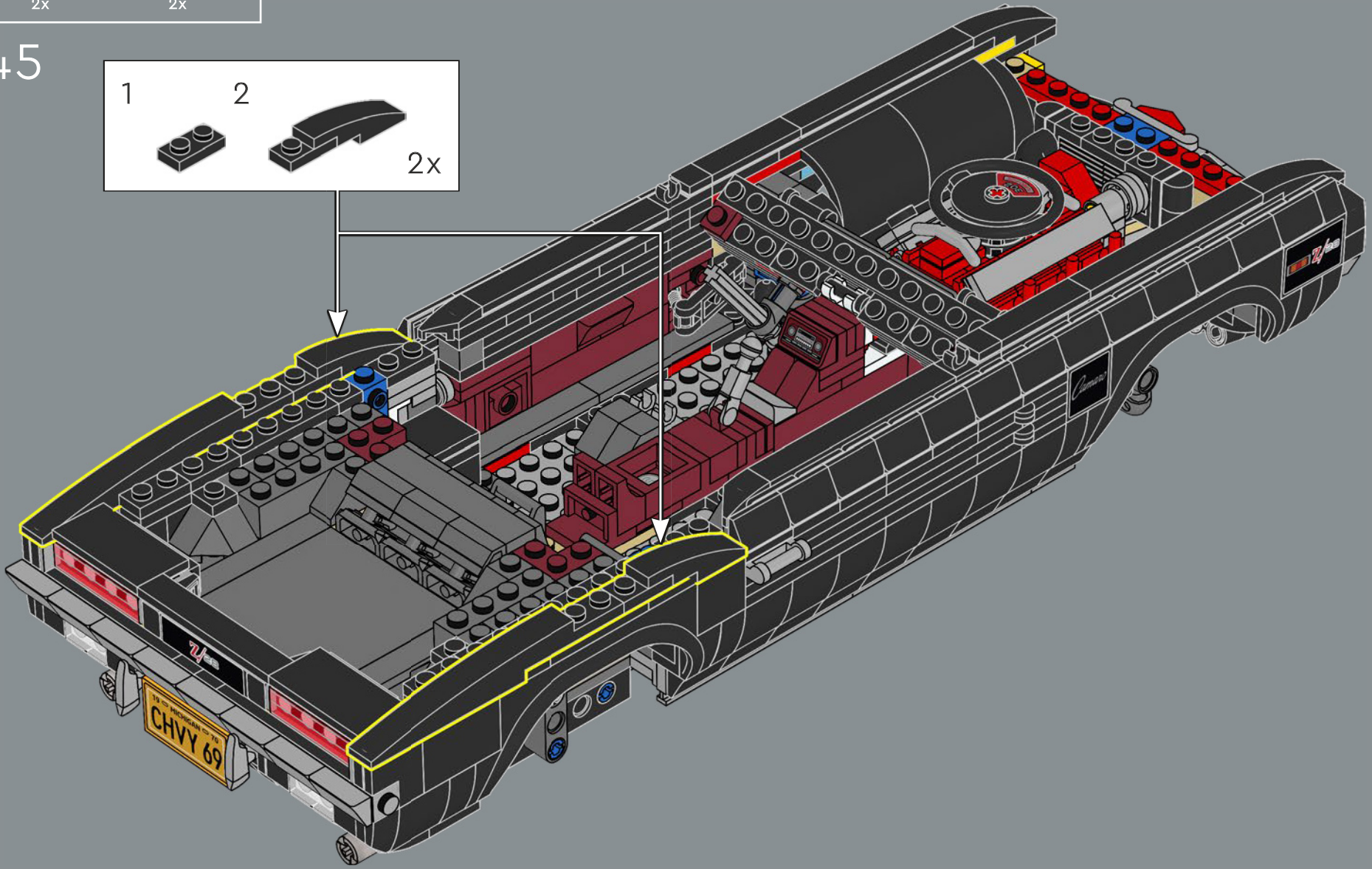
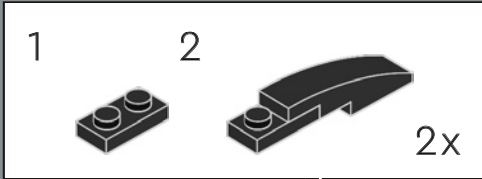

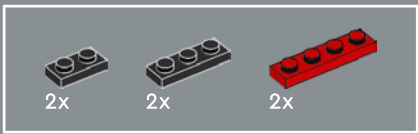

246

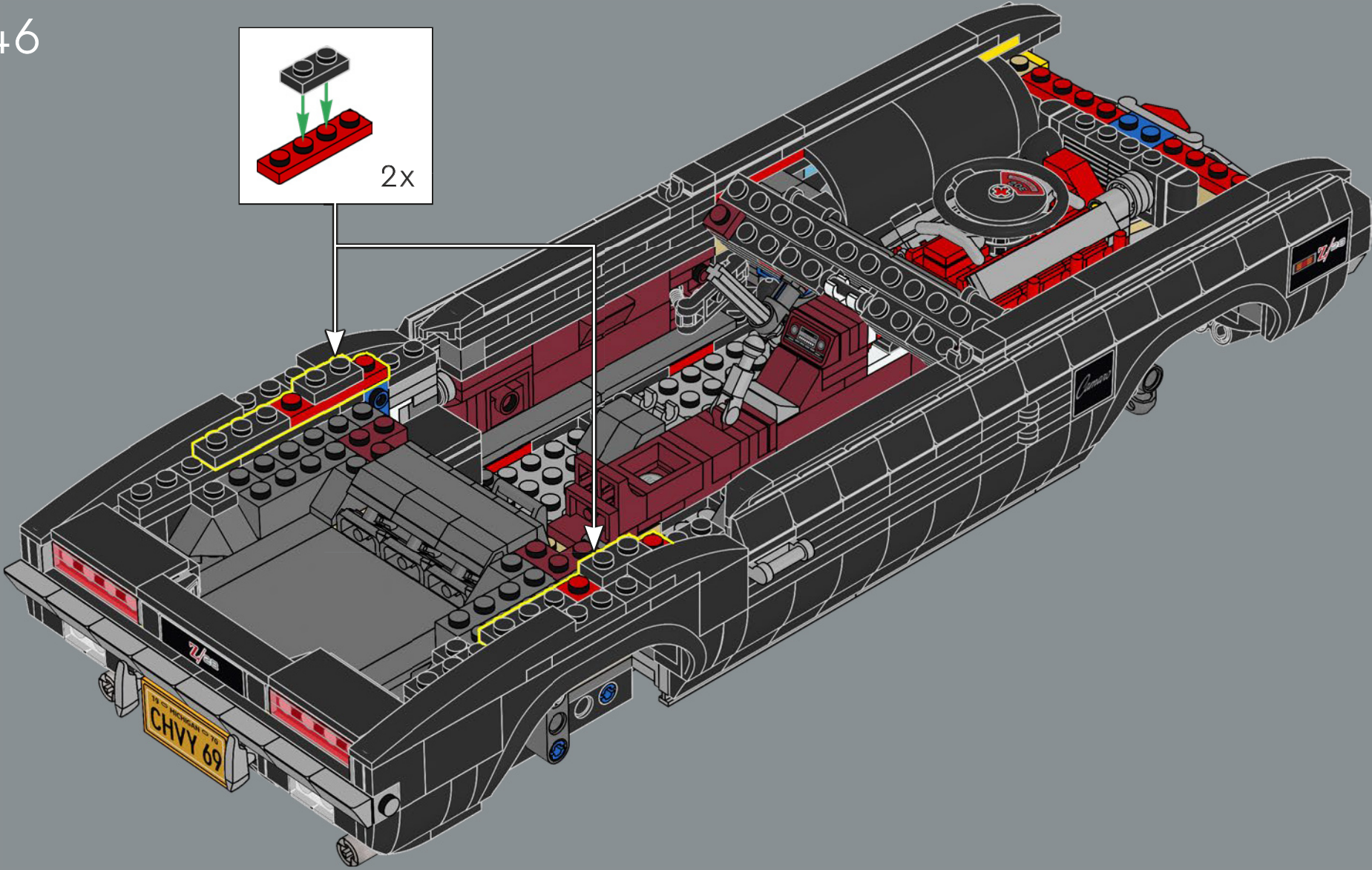
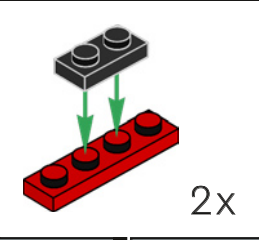

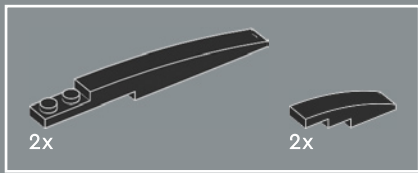

247

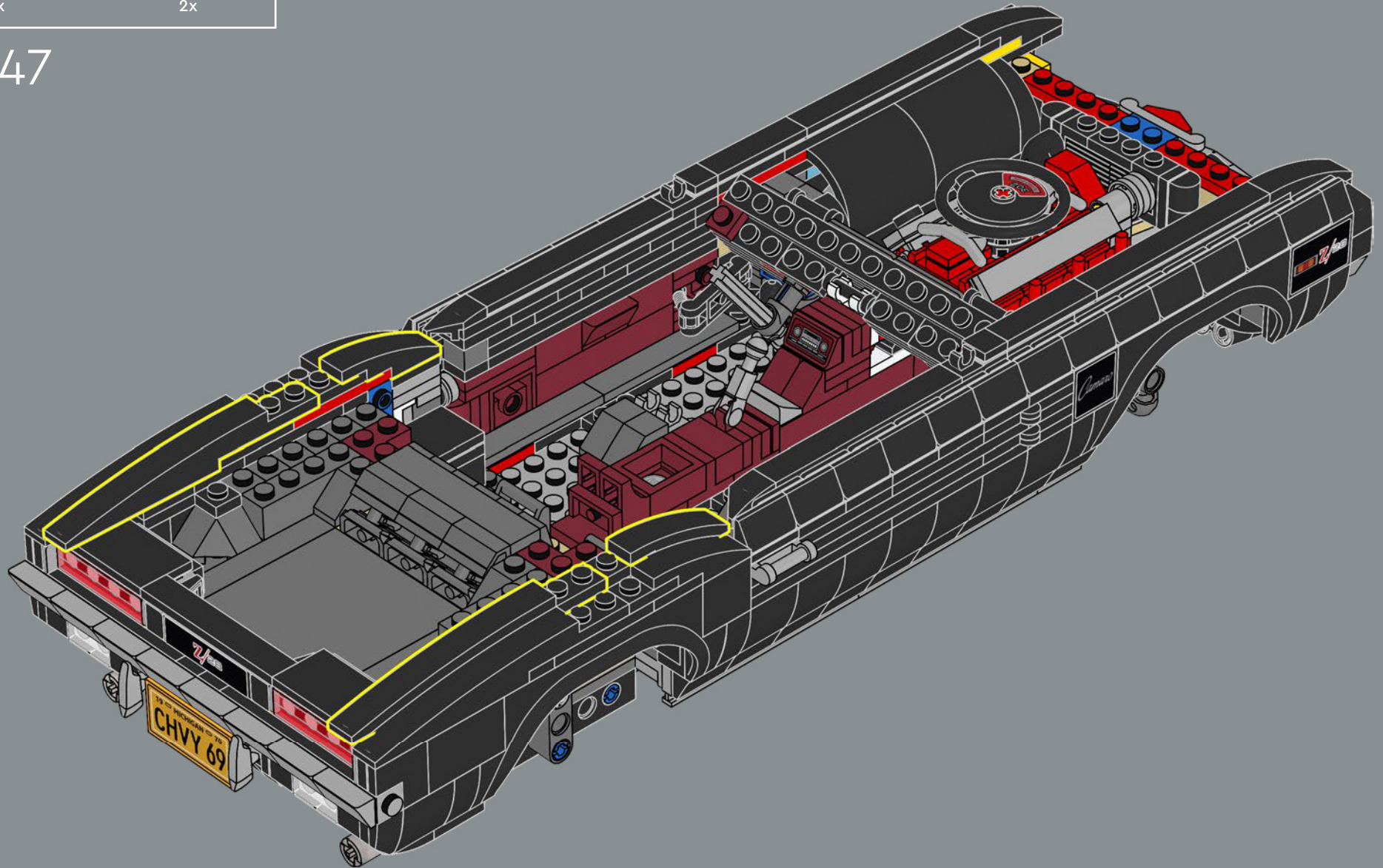

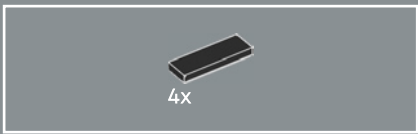

248

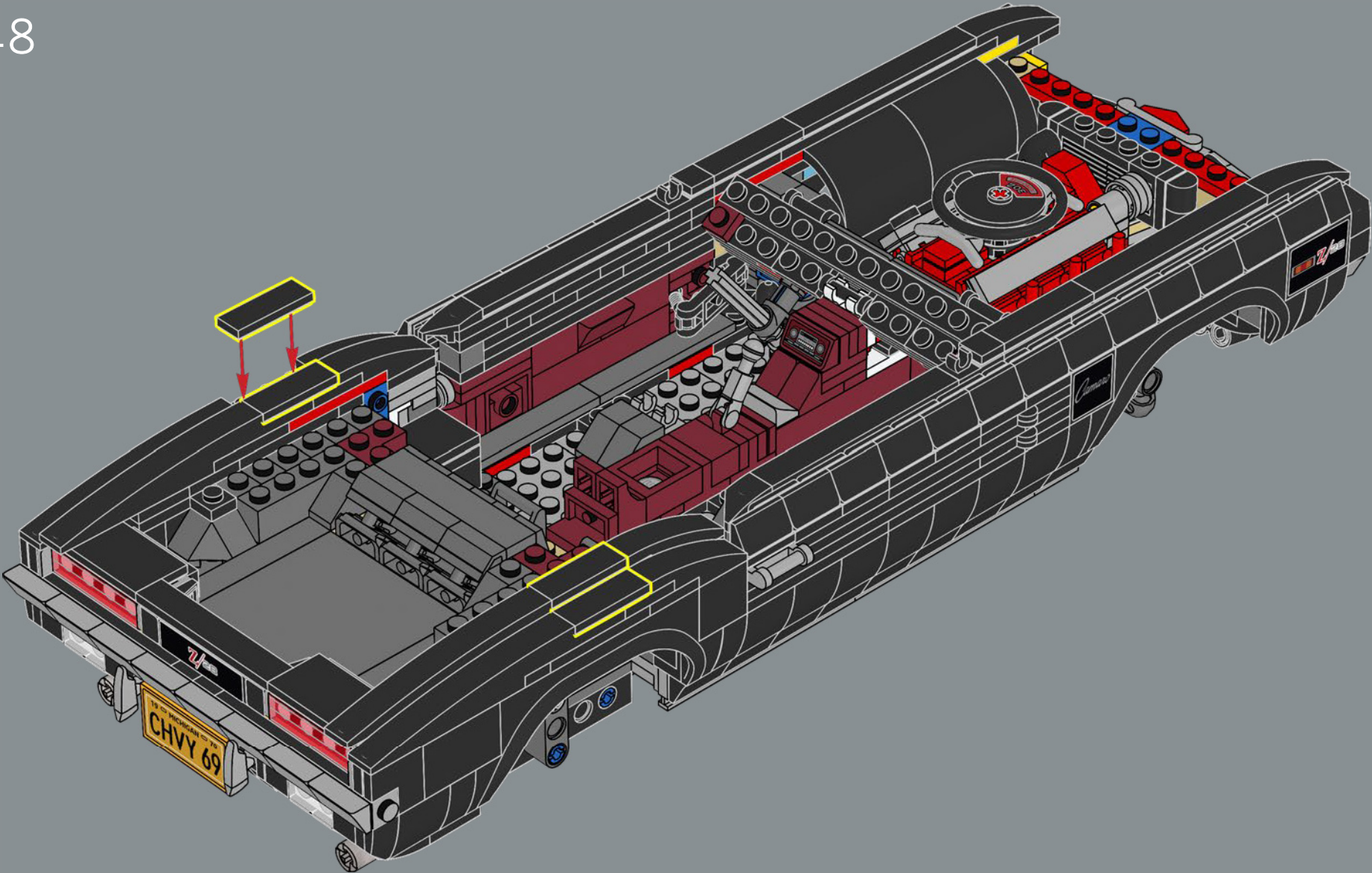

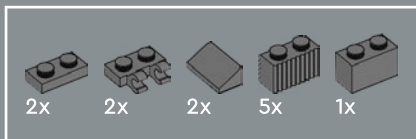

249

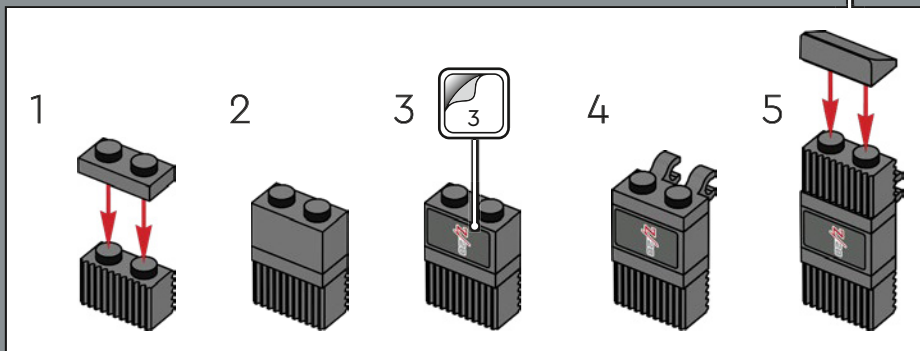
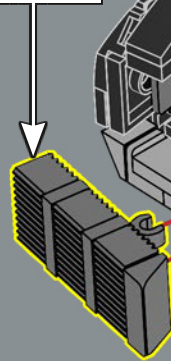
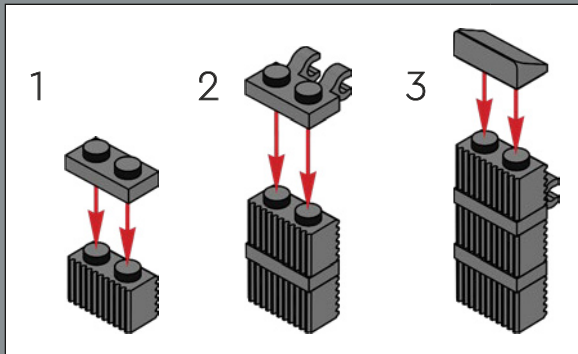

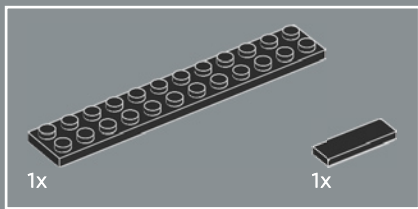

250

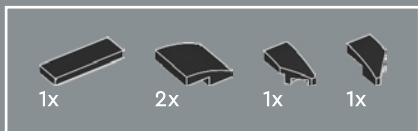
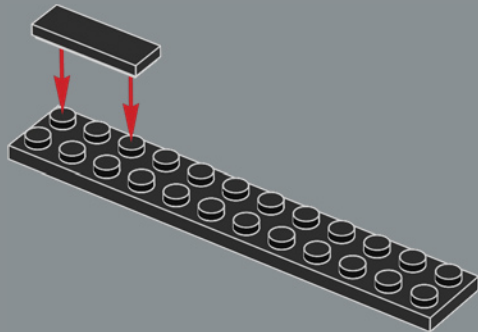

251

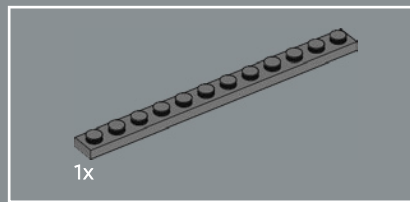
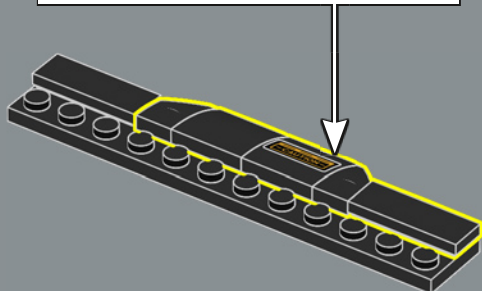
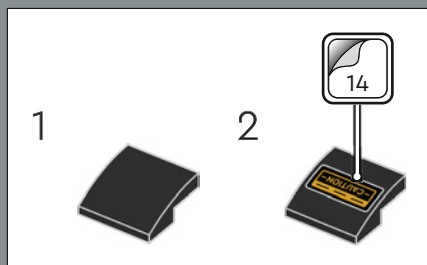

252

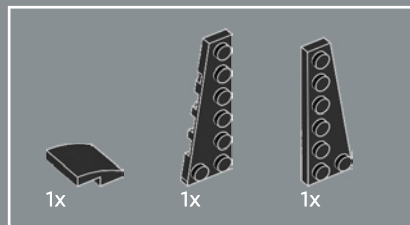
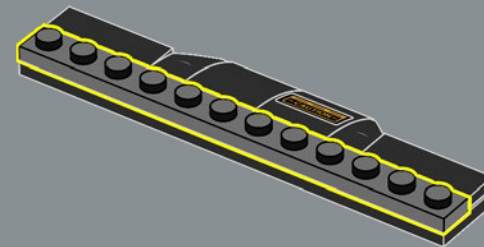

253

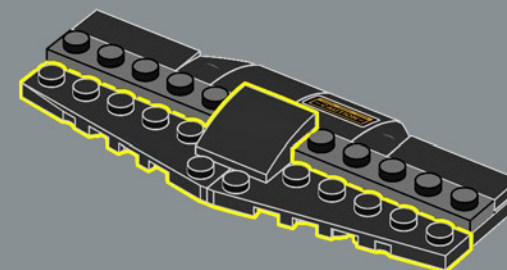





254

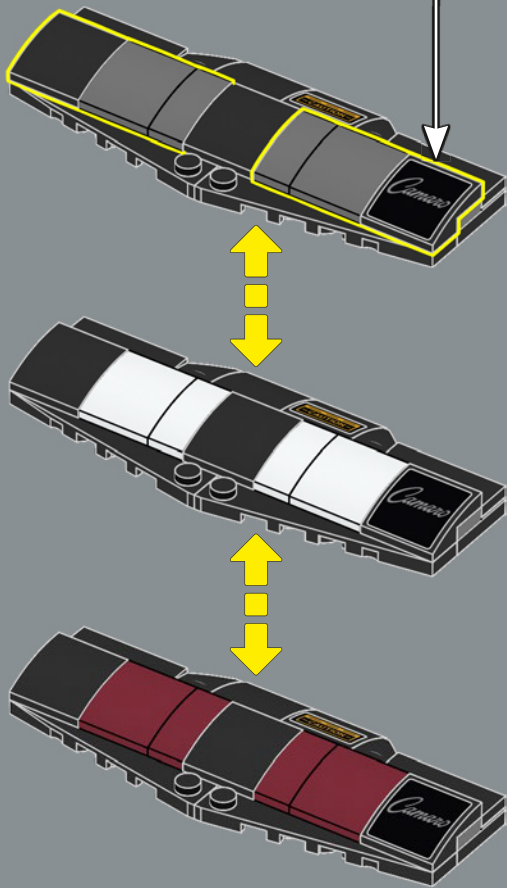
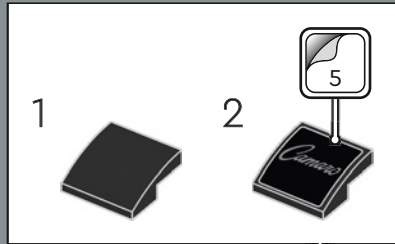

255

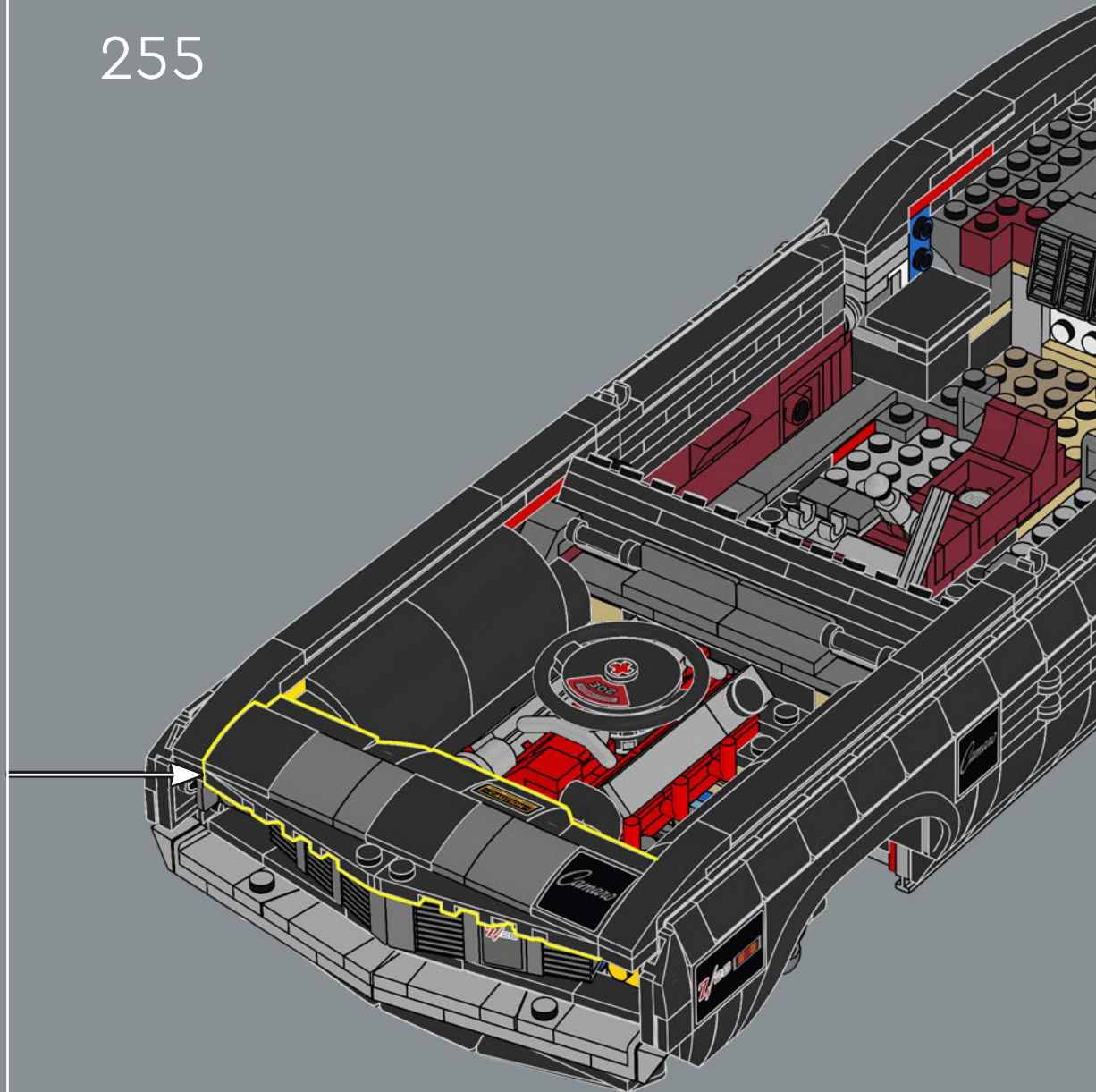

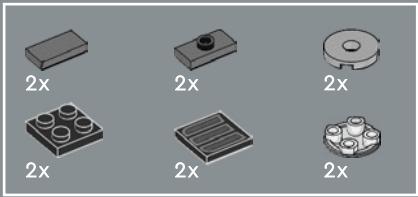

256

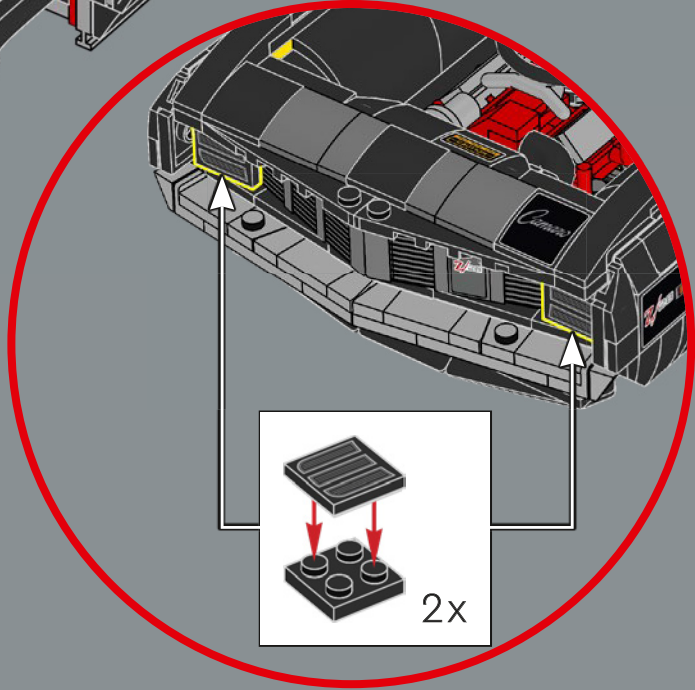
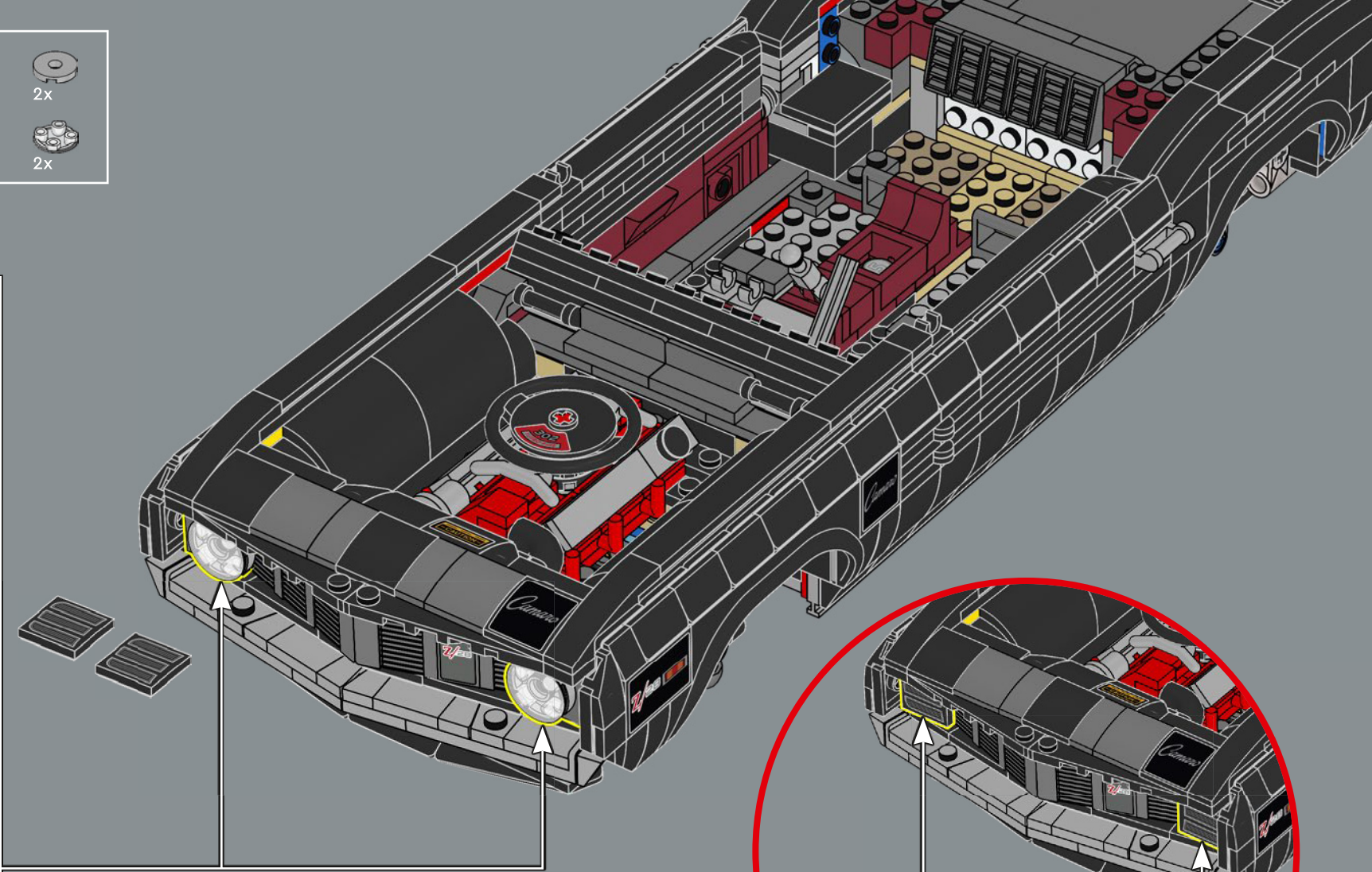
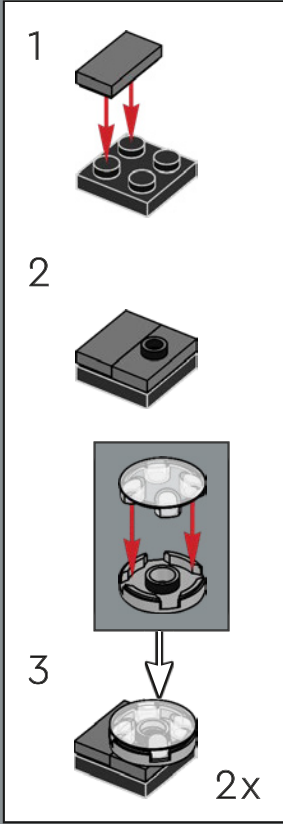

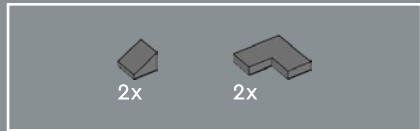

257

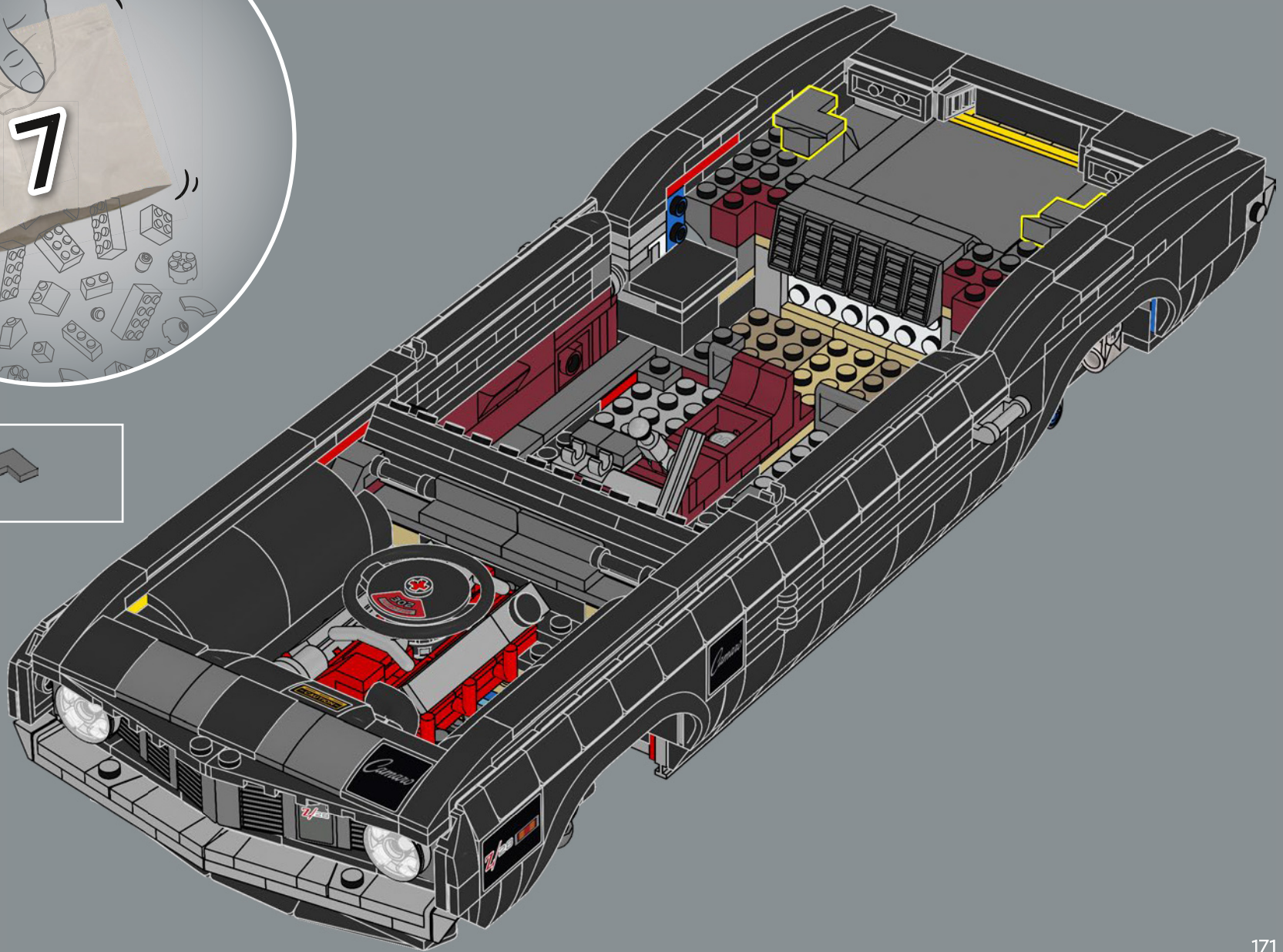

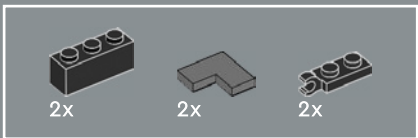

258

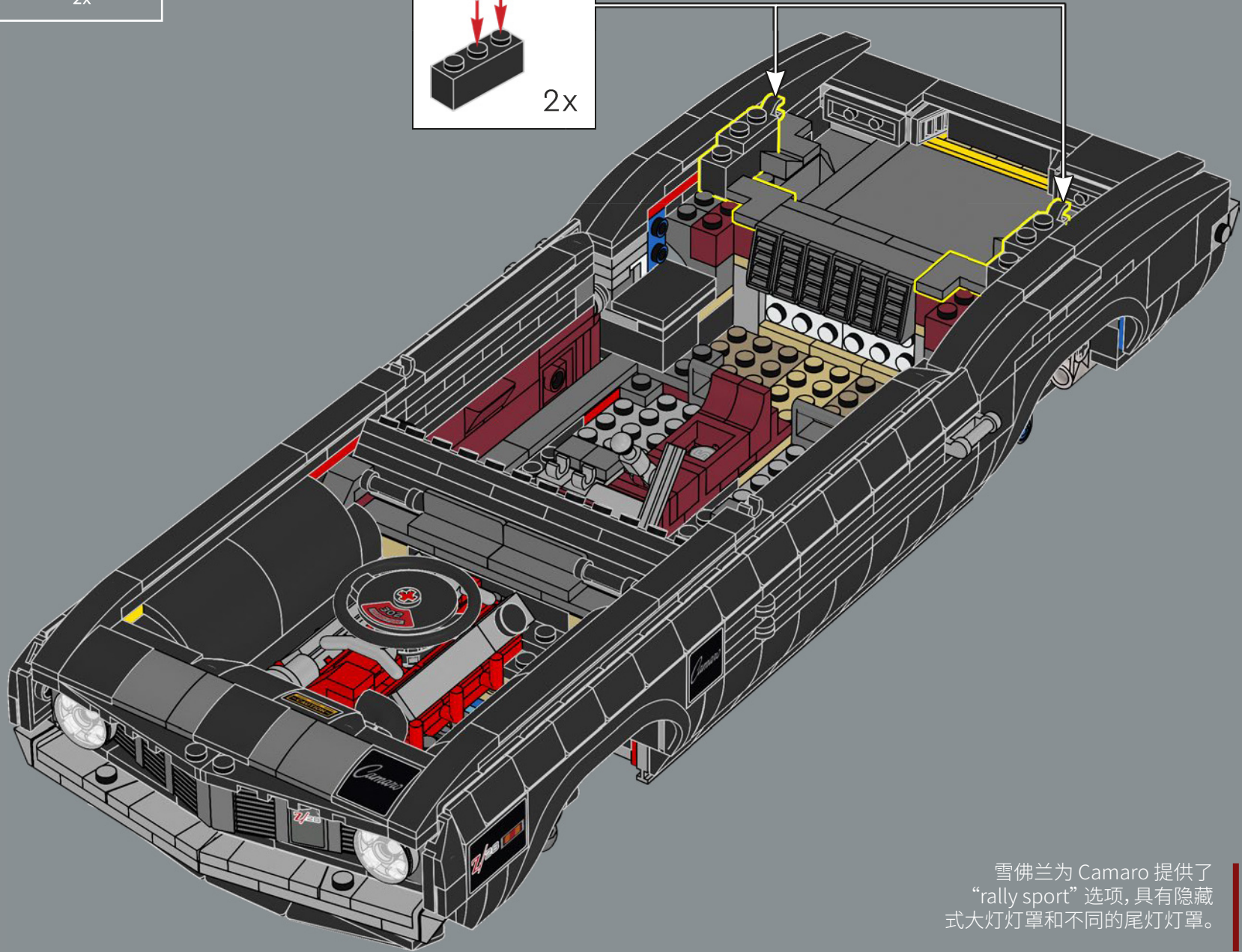
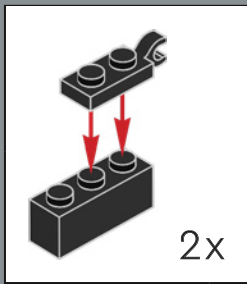

雪佛兰为 Camaro 提供了“rally sport”选项，具有隐藏式大灯灯罩和不同的尾灯灯罩。

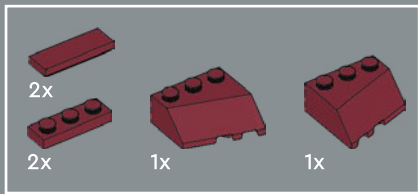

259

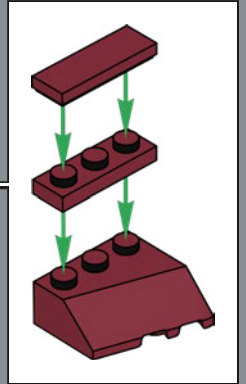
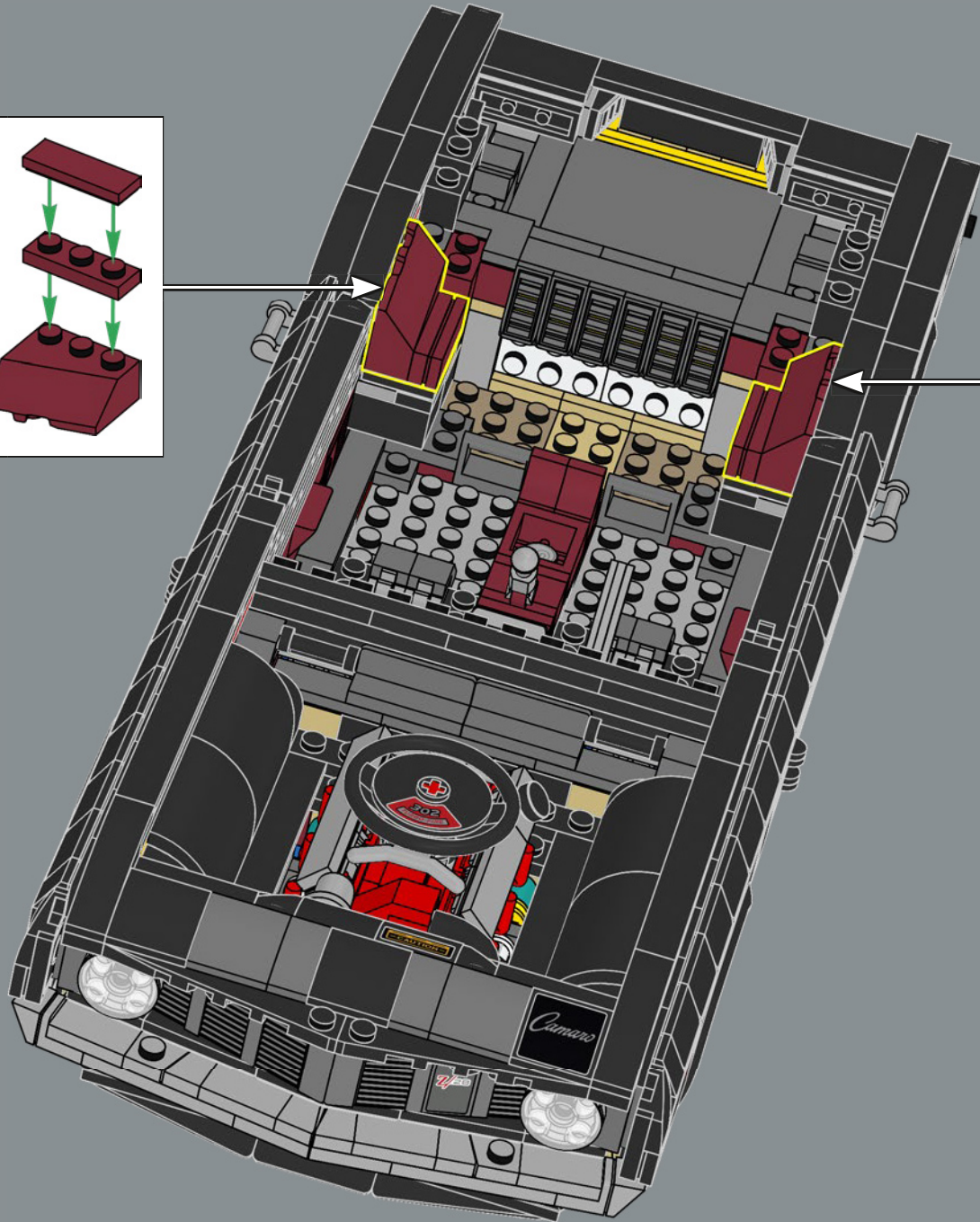
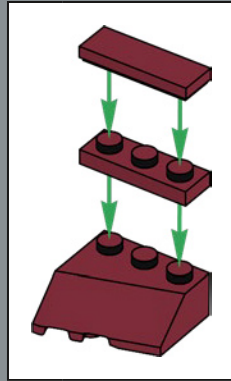

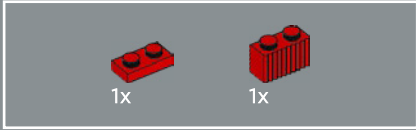

260



261

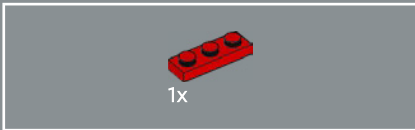
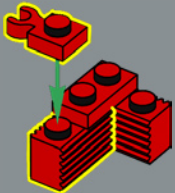

262

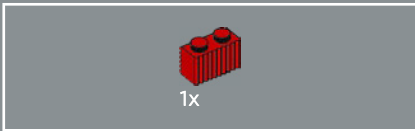
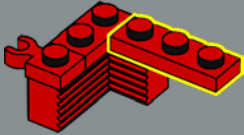

263

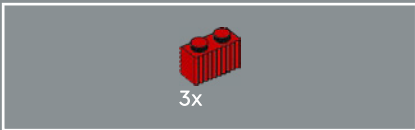
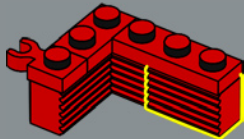

264

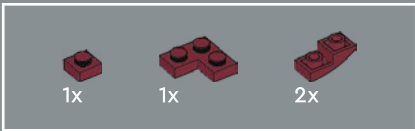
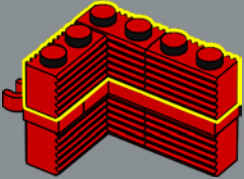

265

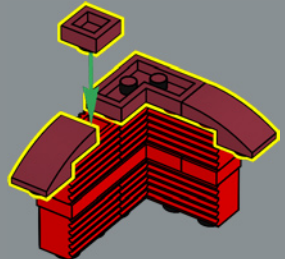

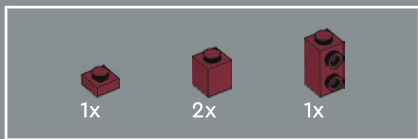

266

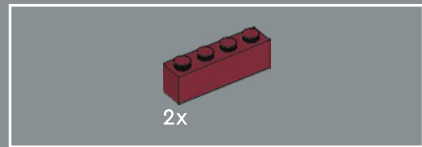
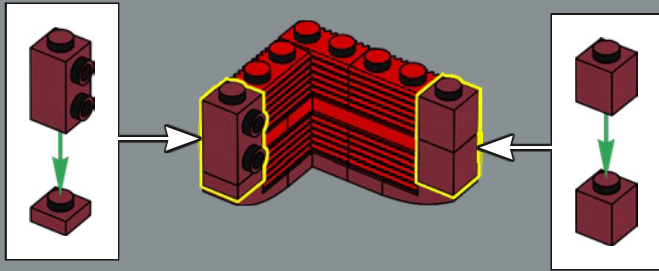

267

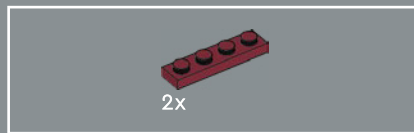
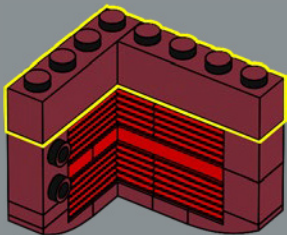

268

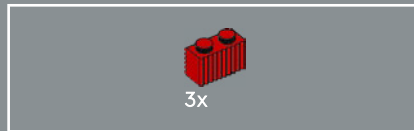
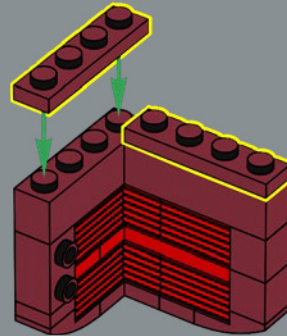

269

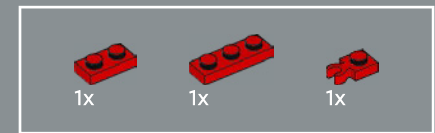
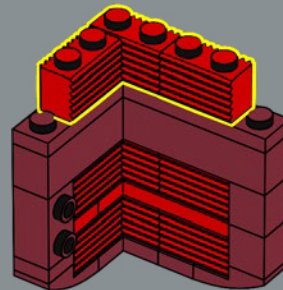

270

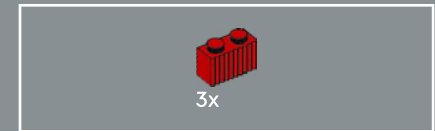
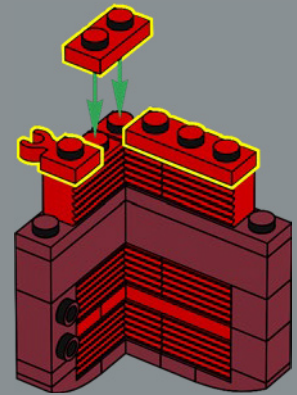

271

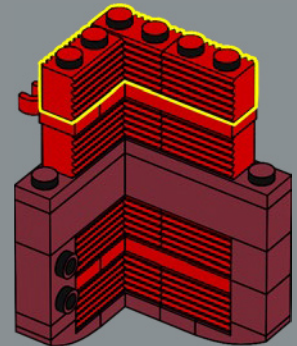



4x

272

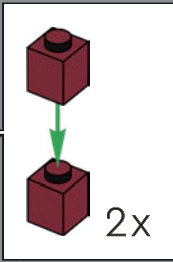
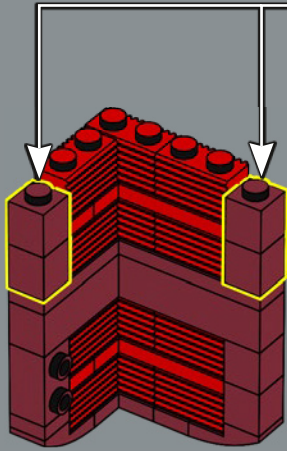

2x



1x



2x



1x

273

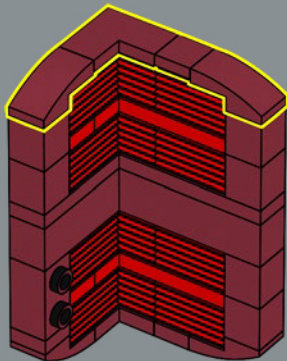

1x

274



15

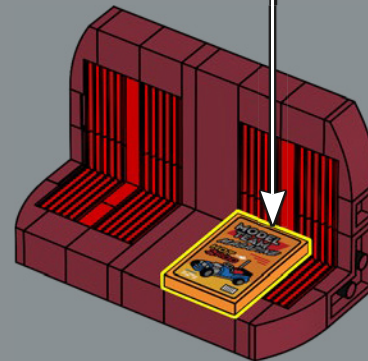



275

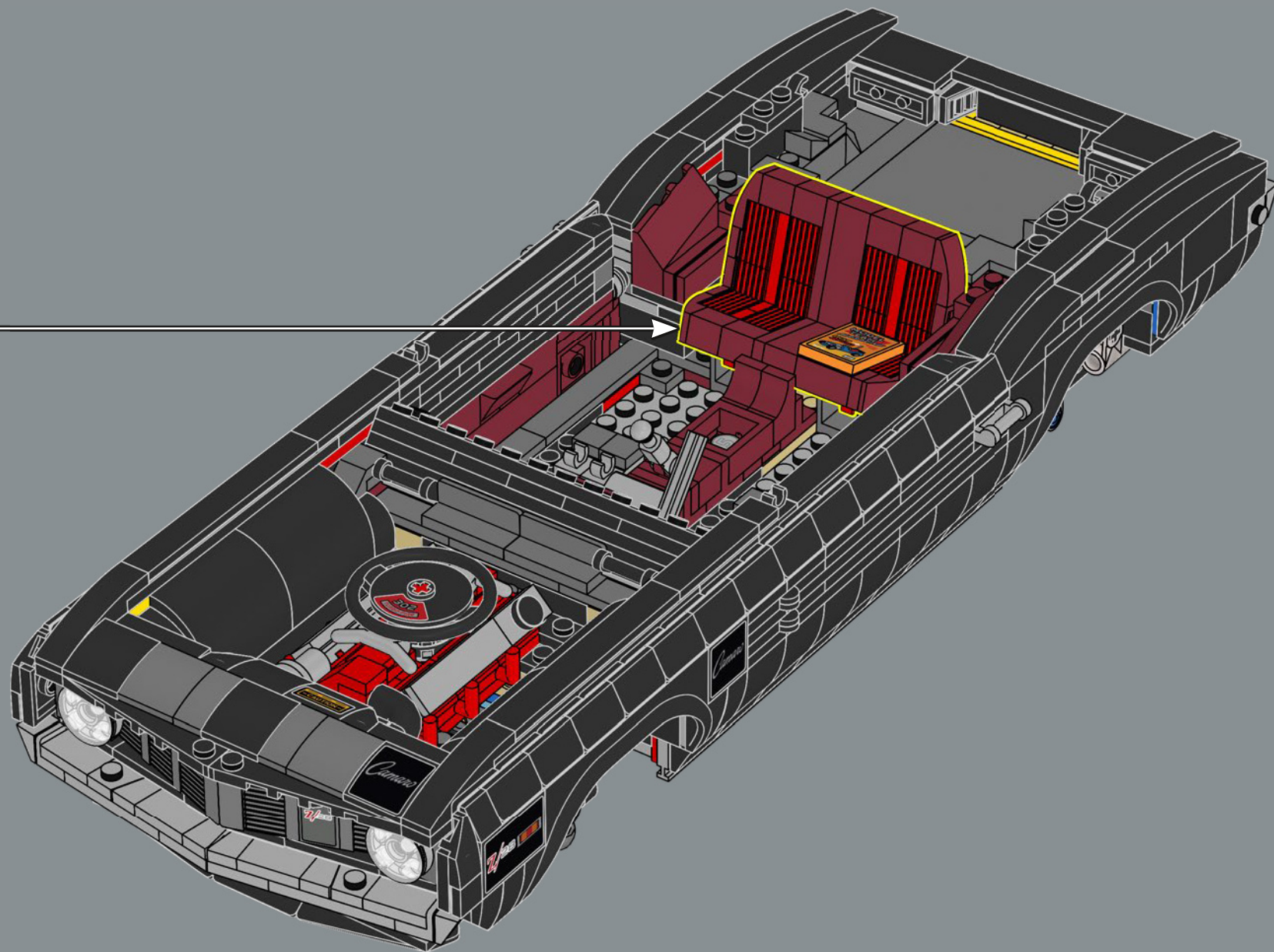

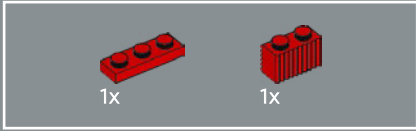

276

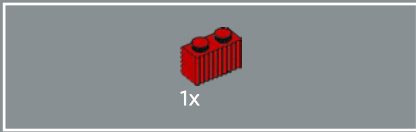
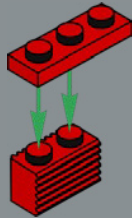

277

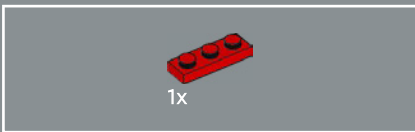
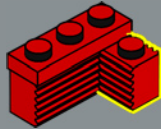

278

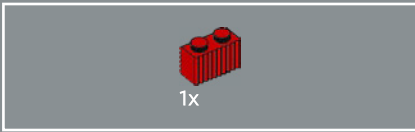
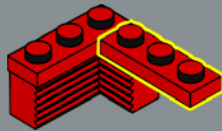

279

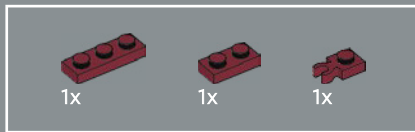
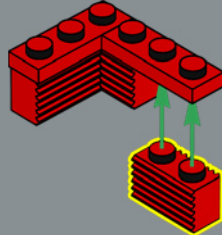

280

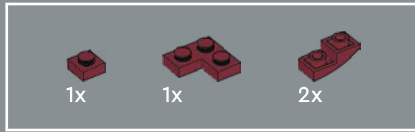
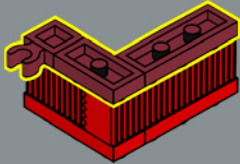

281

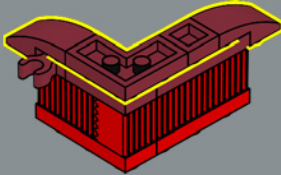



282

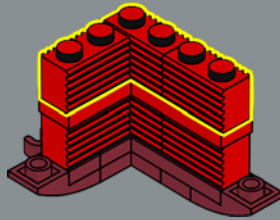

283

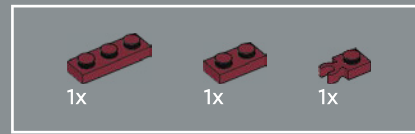
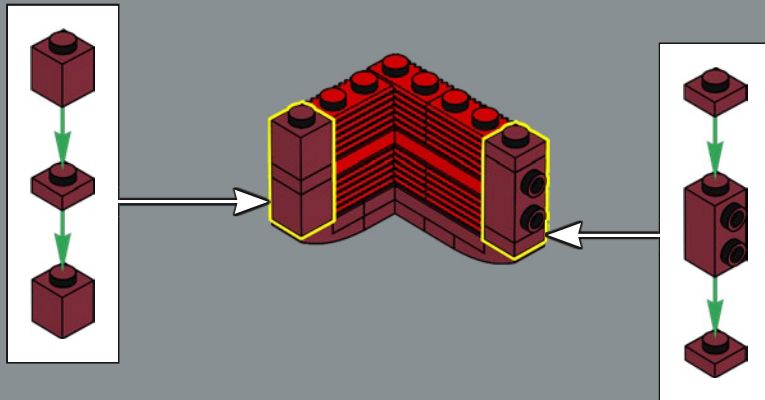

284

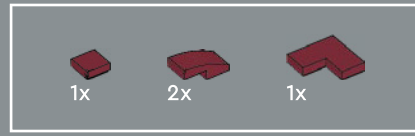
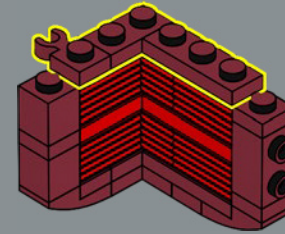

285

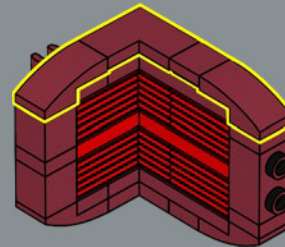



1x

286

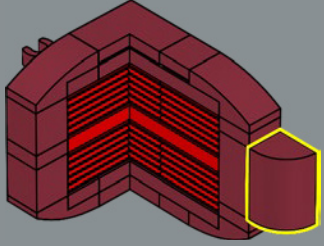

1x

287

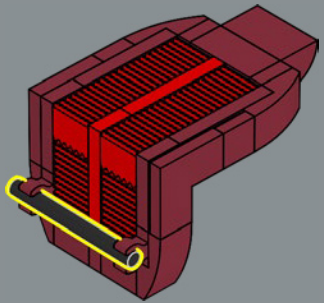

288

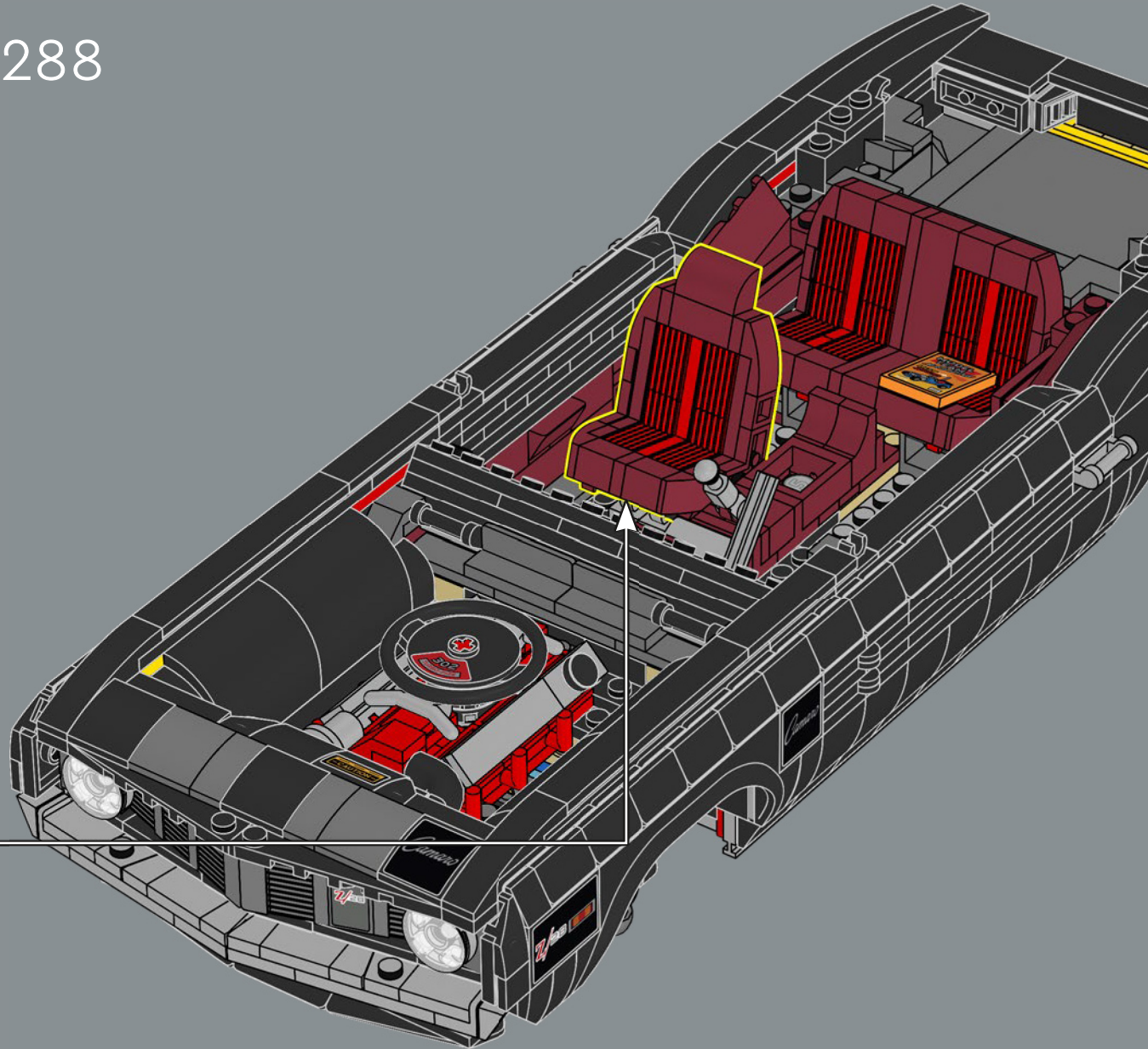

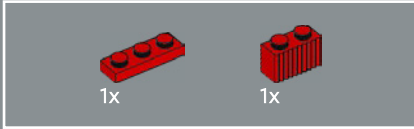
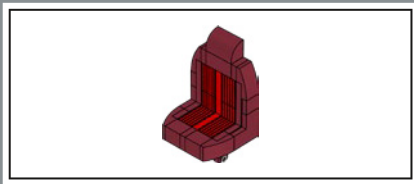

289

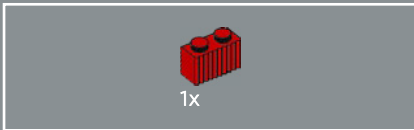
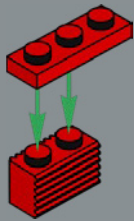

290

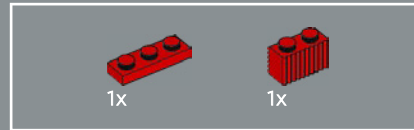
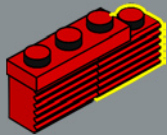

291

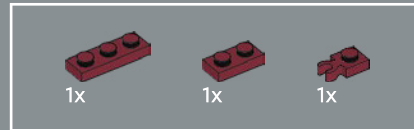
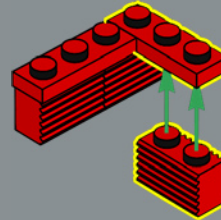

292

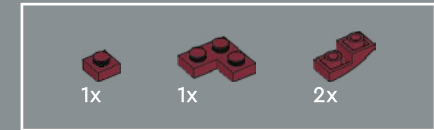
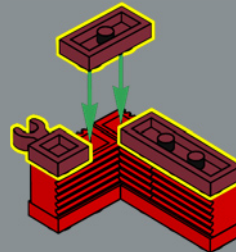

293

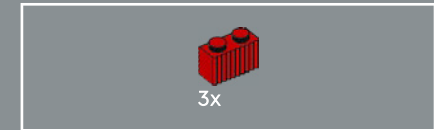
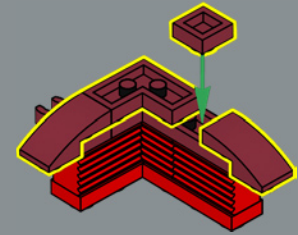

294

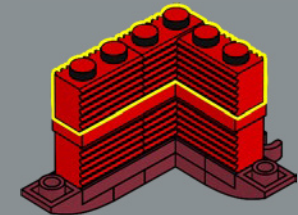



295

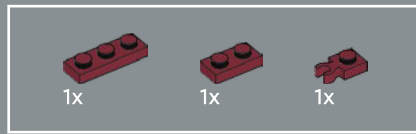
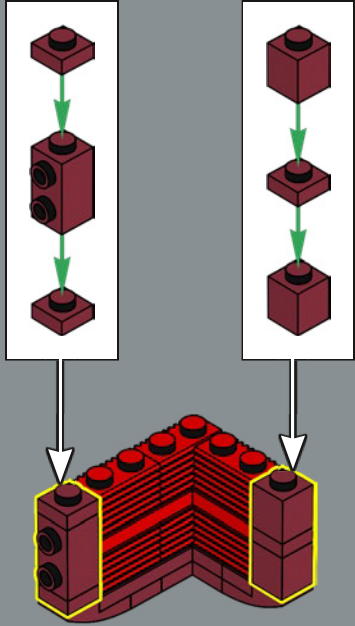

296

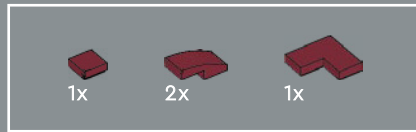
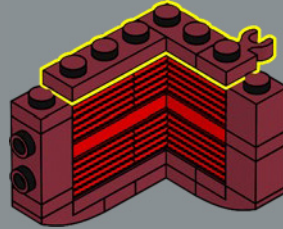

297

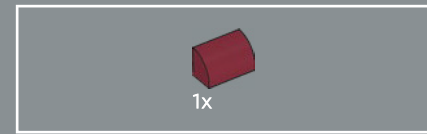
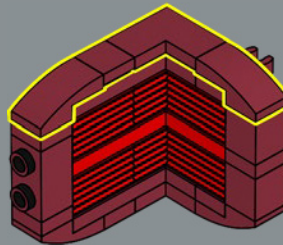

298

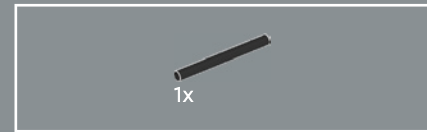
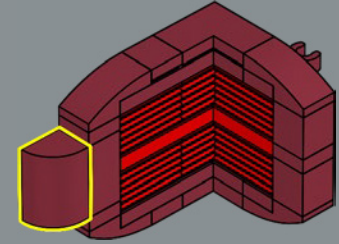

299

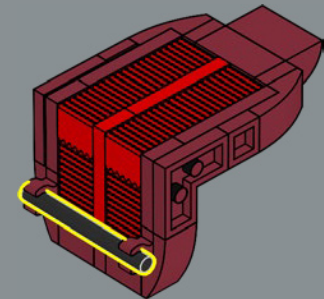

300

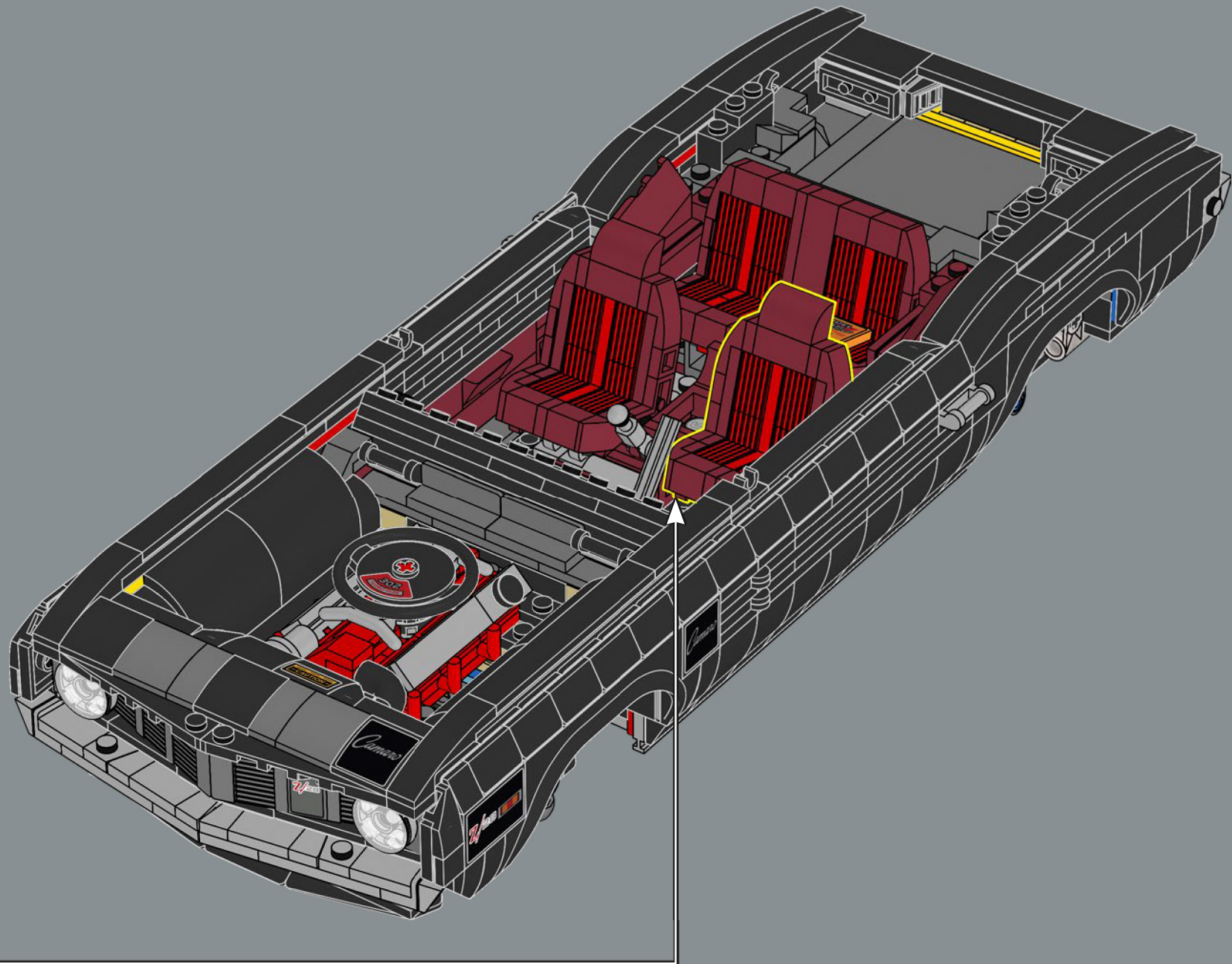

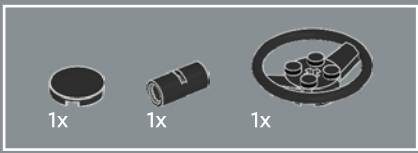

301

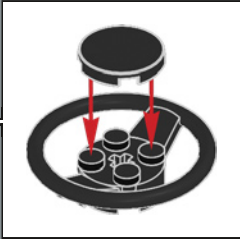
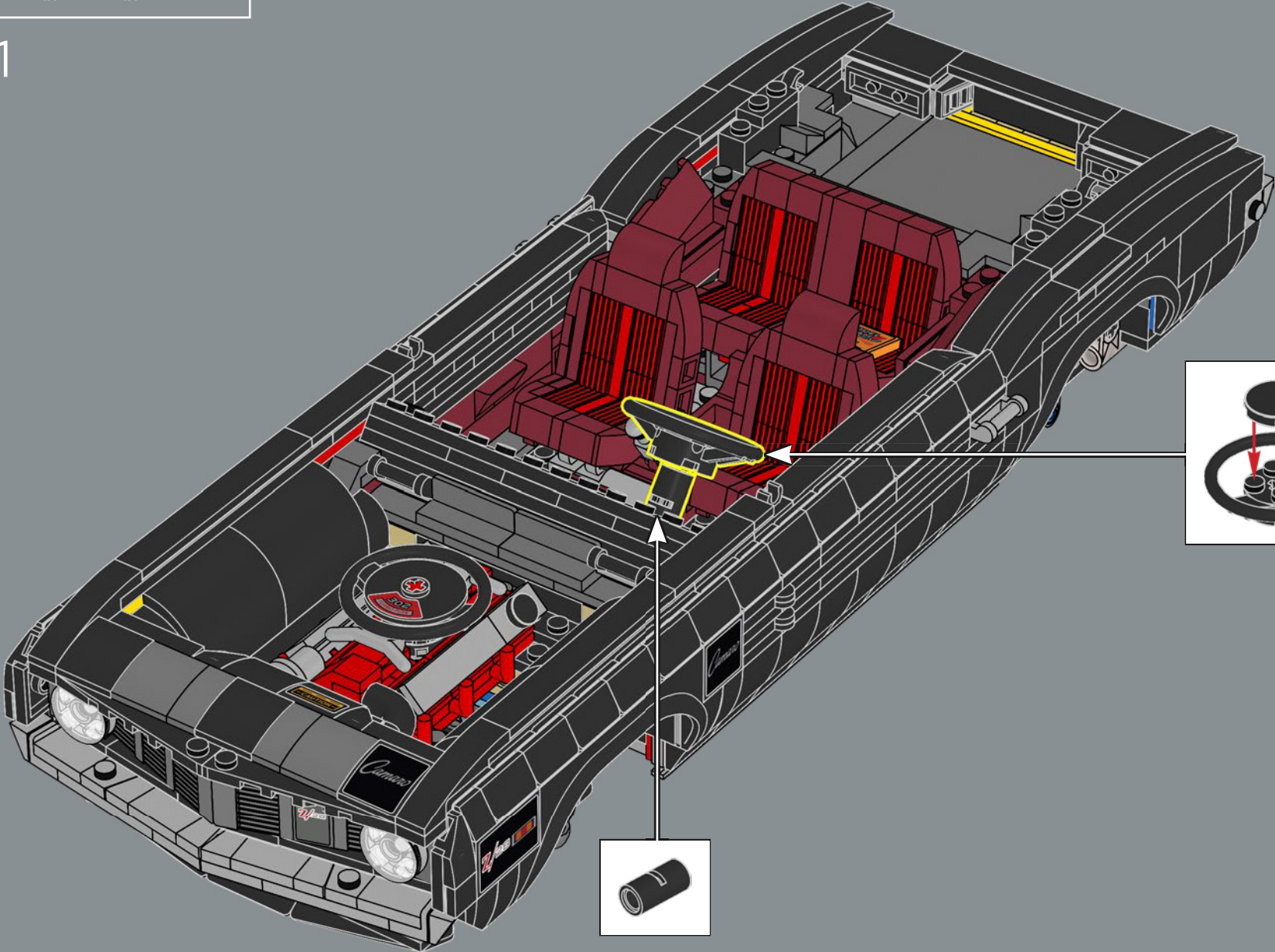



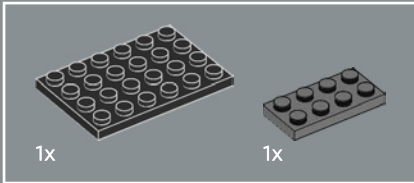
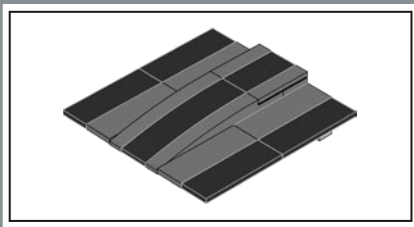

302

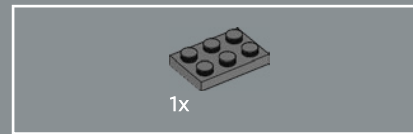
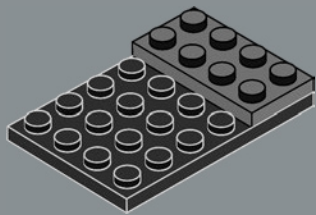

303

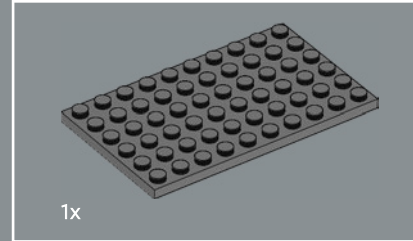
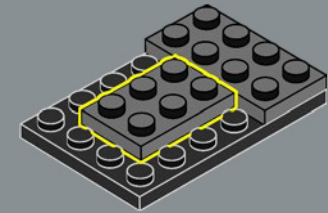

304

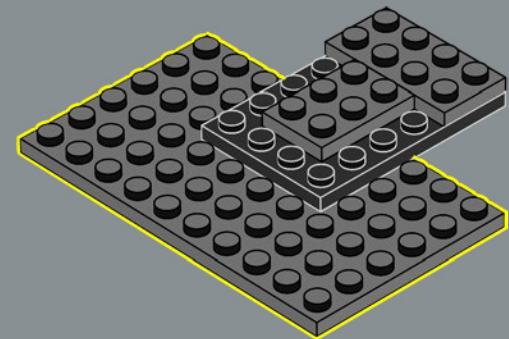

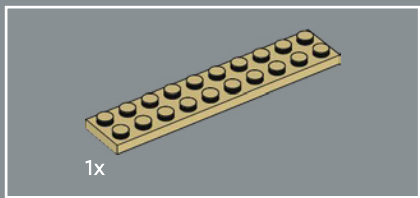

305

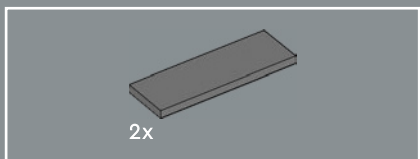
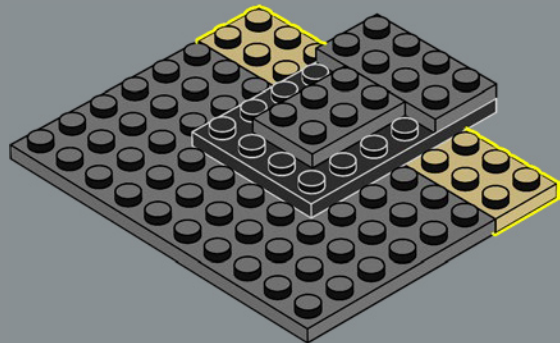

306

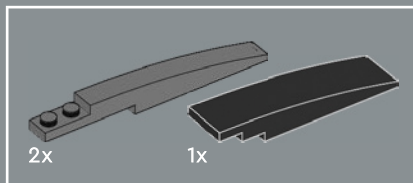
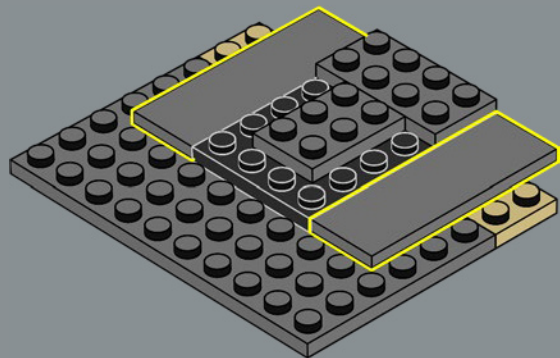

307

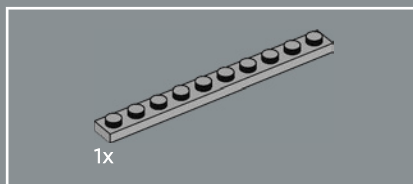
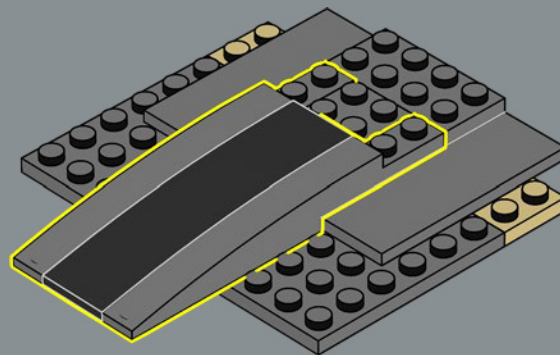

308

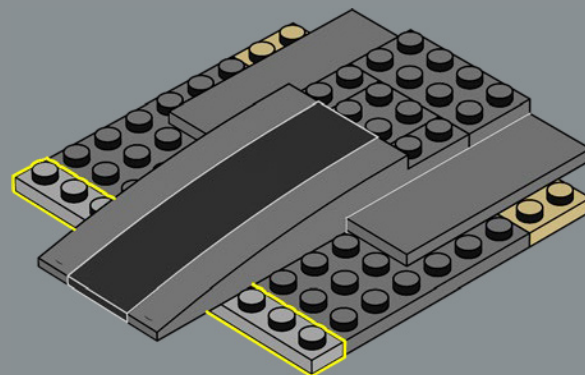

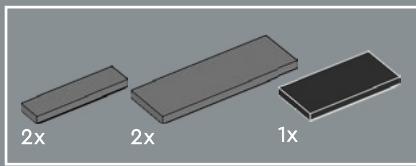

309

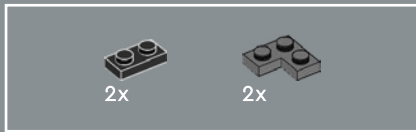
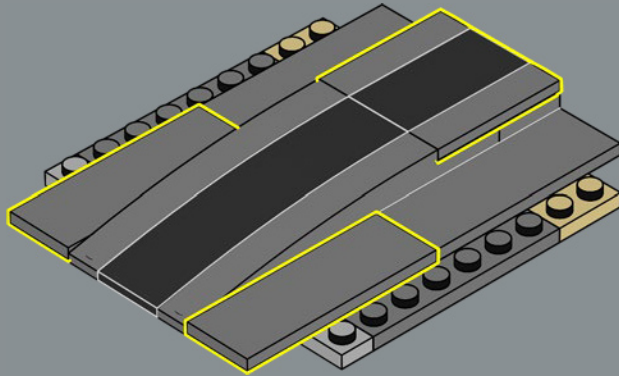

310

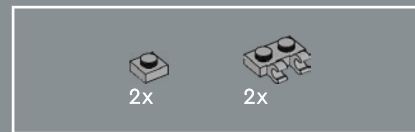
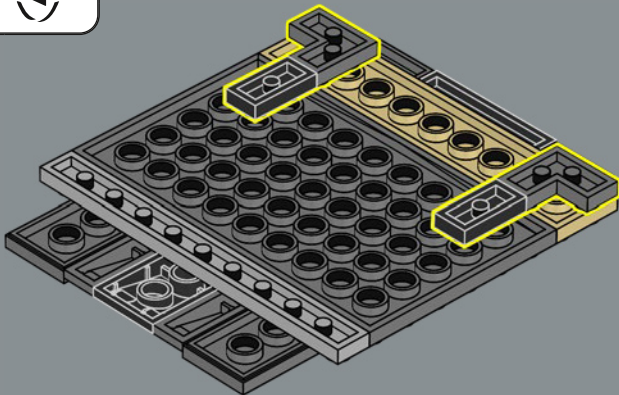

311

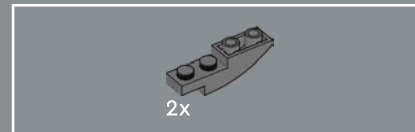
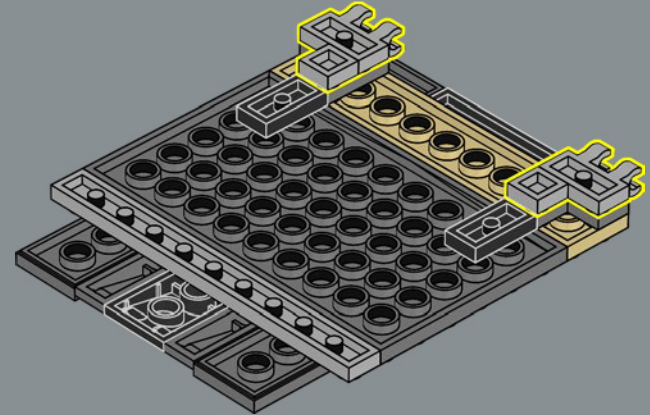

312

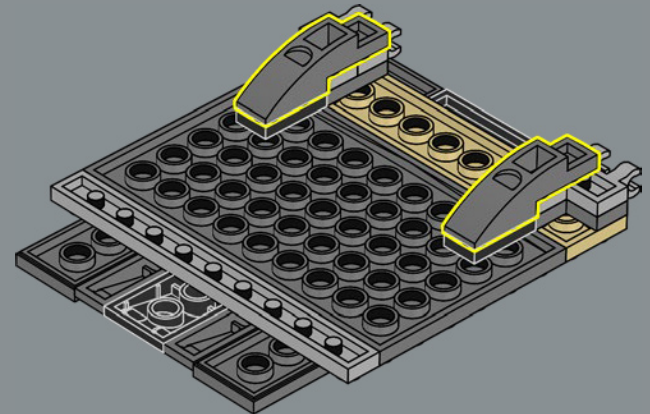

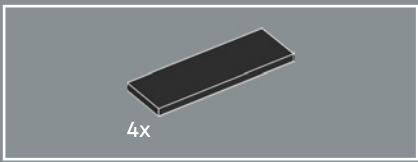

313

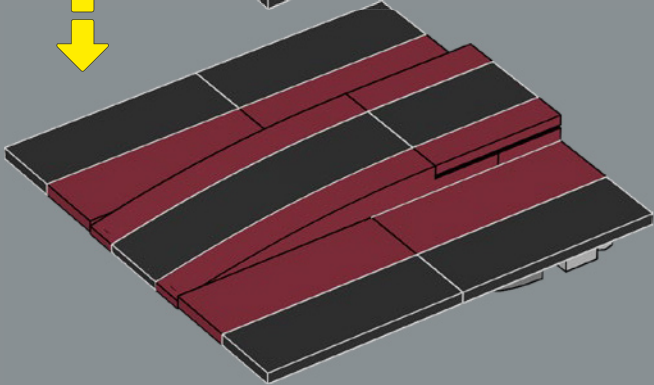
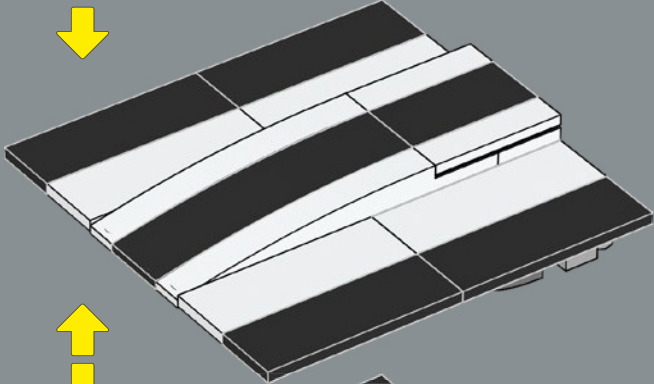
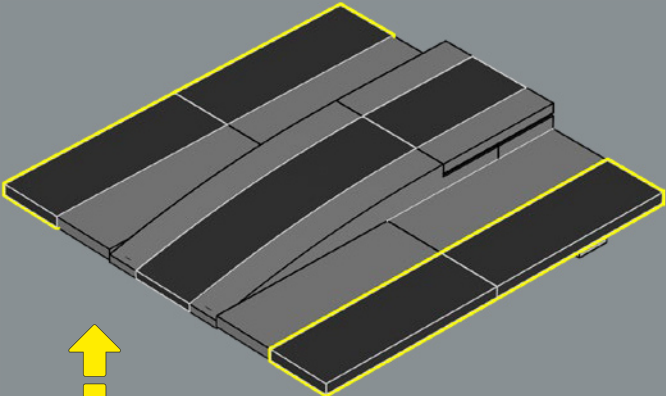

314

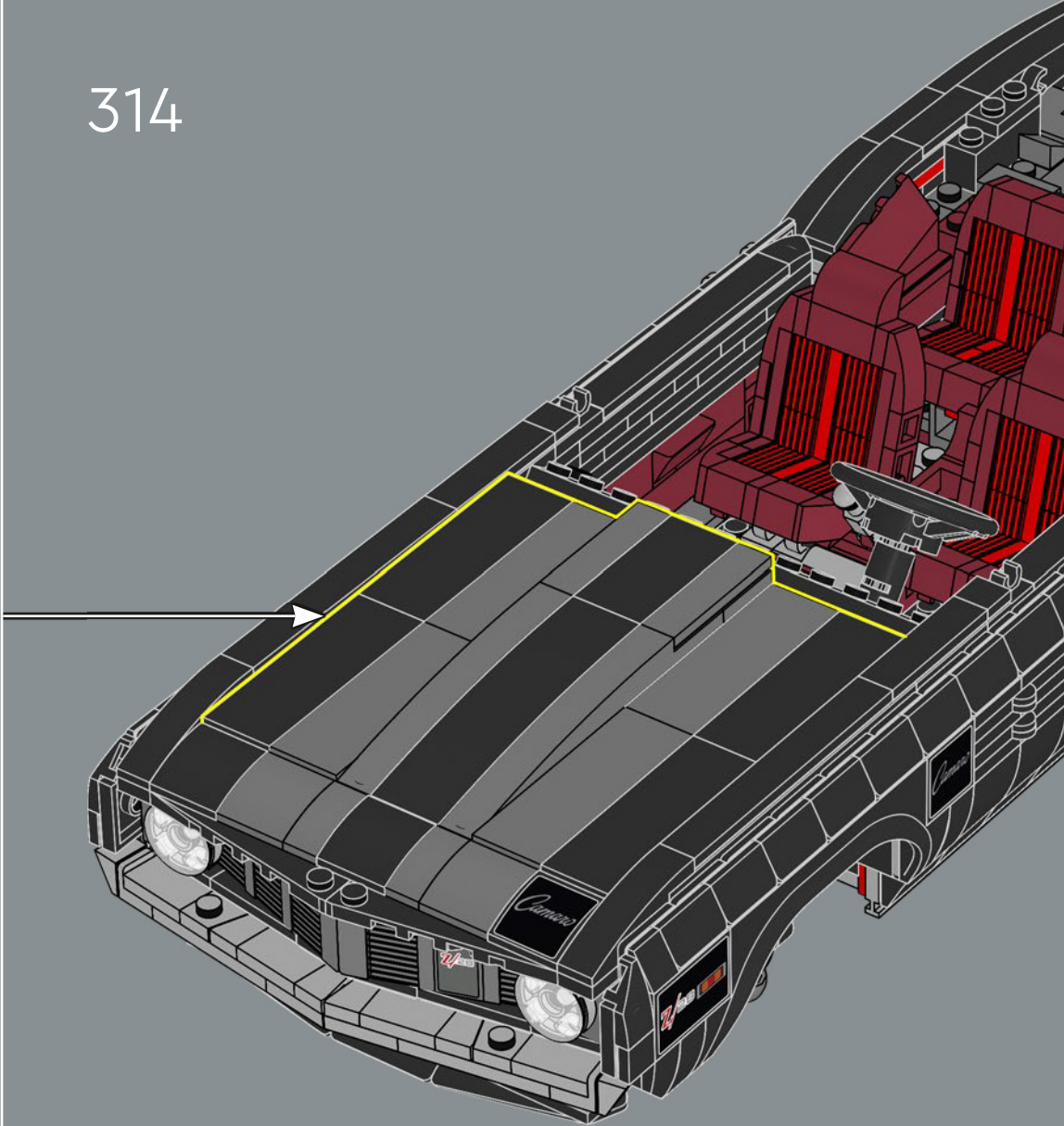

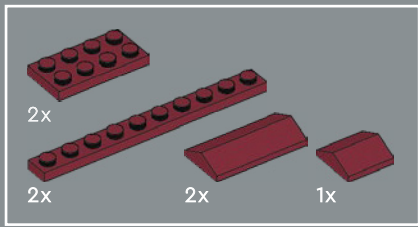

315

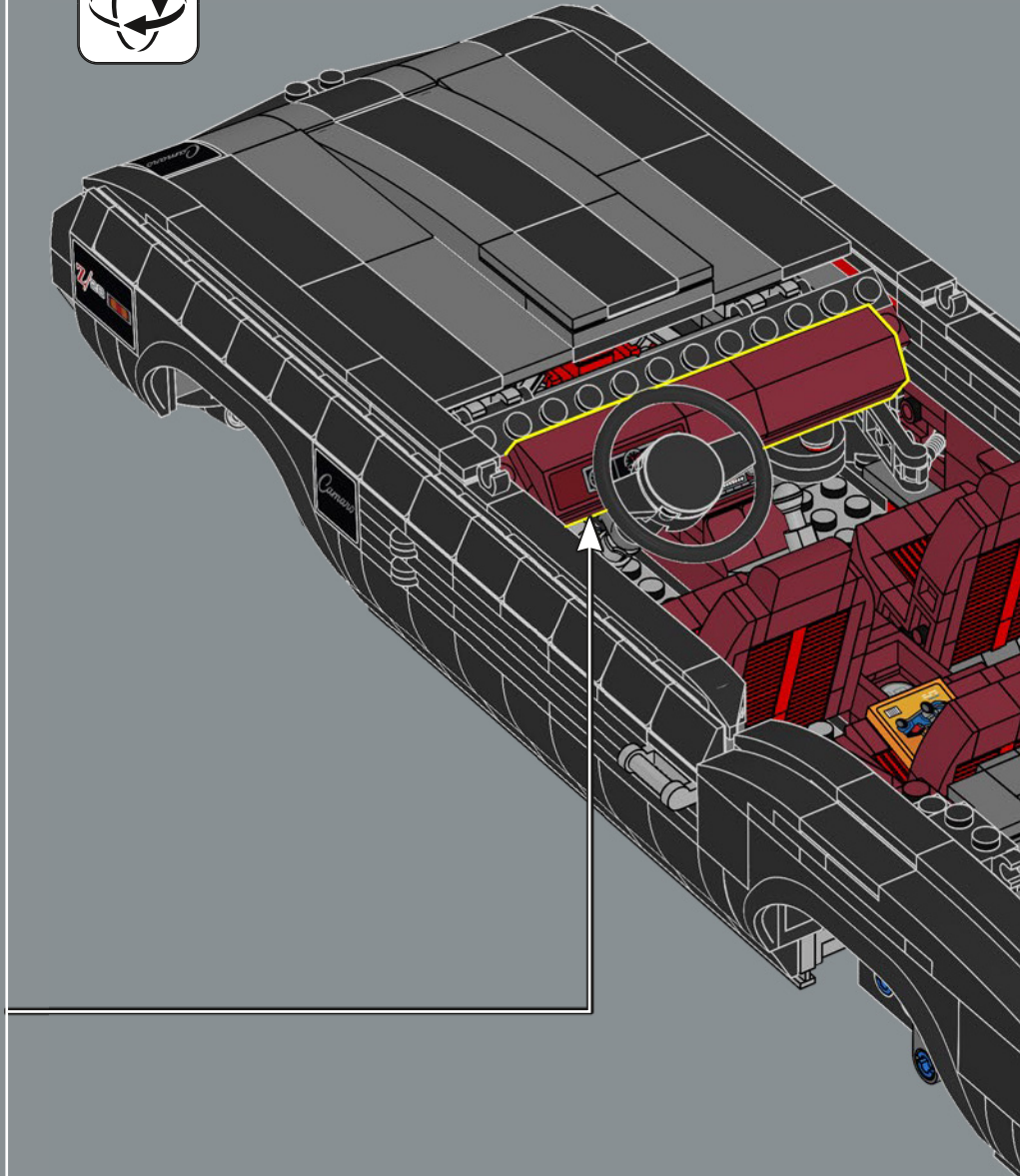
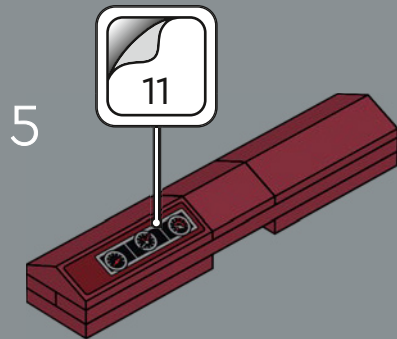
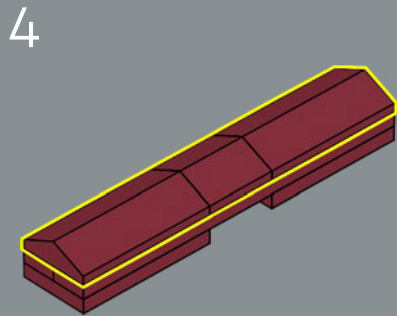
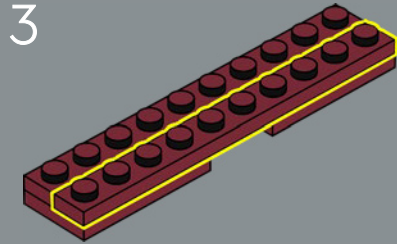
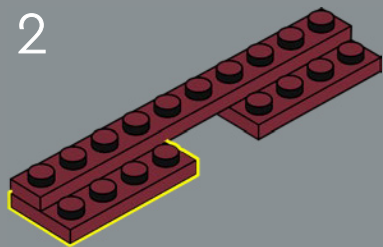
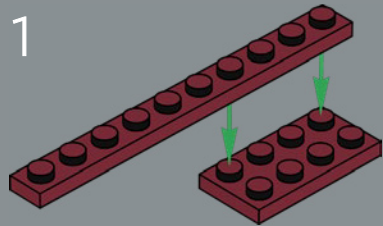

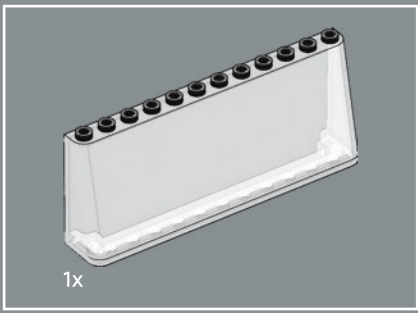

316

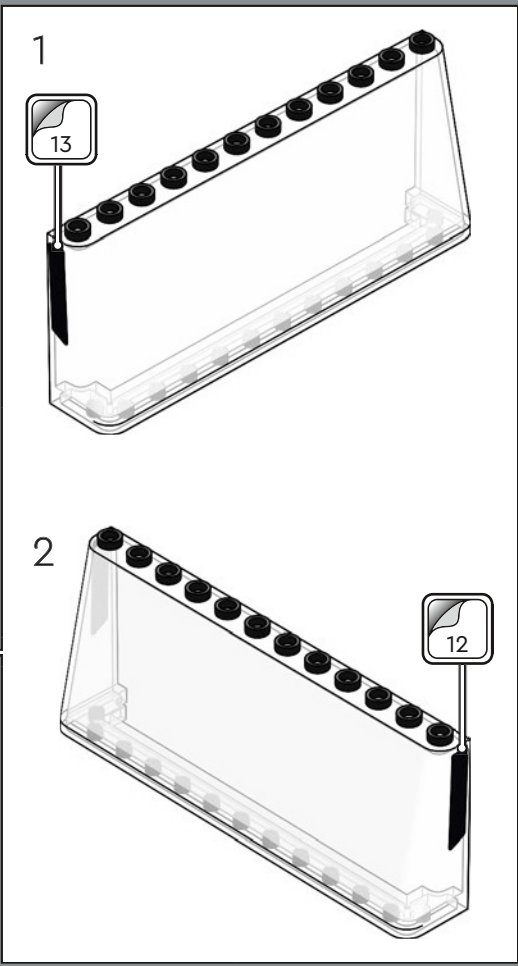
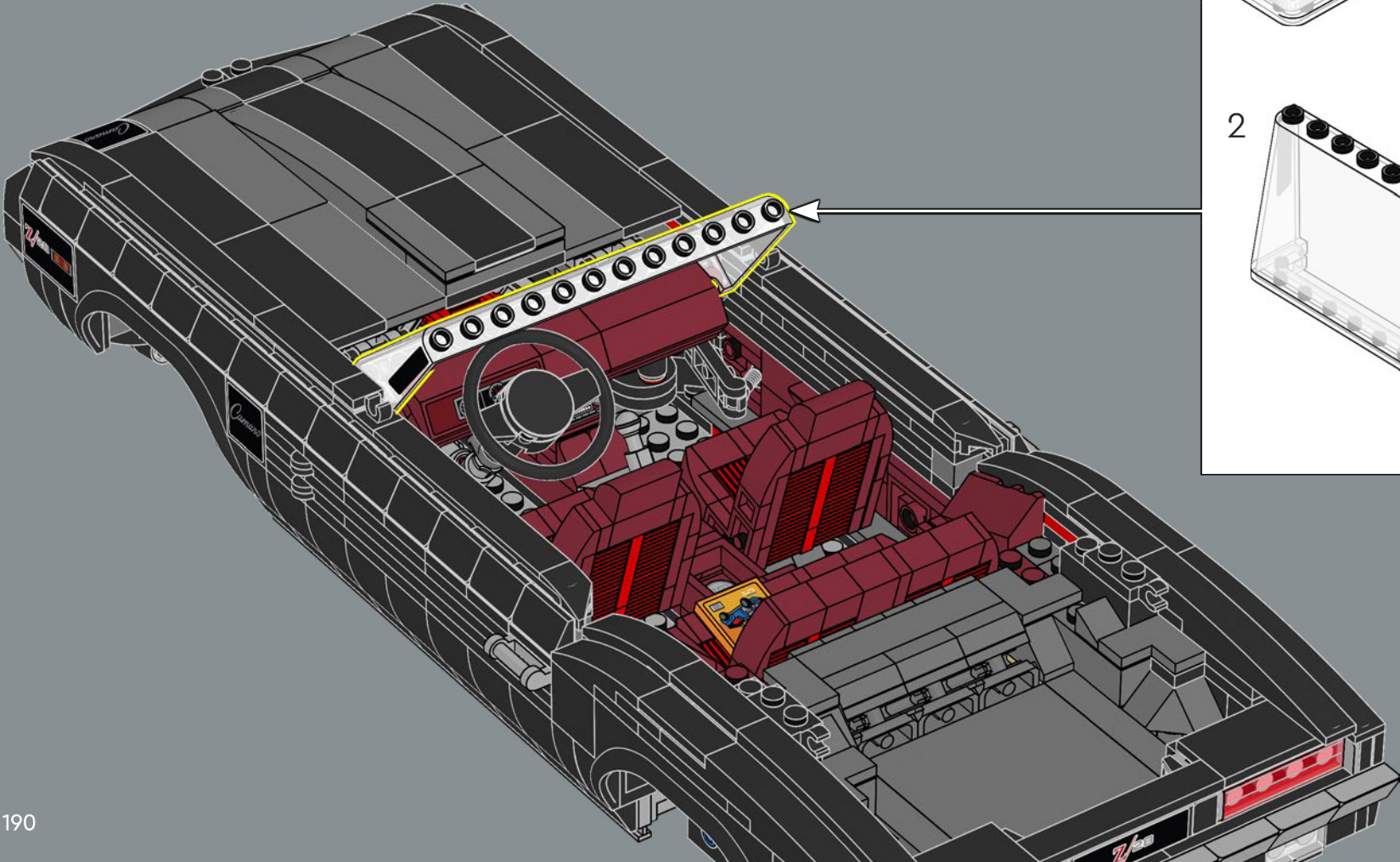

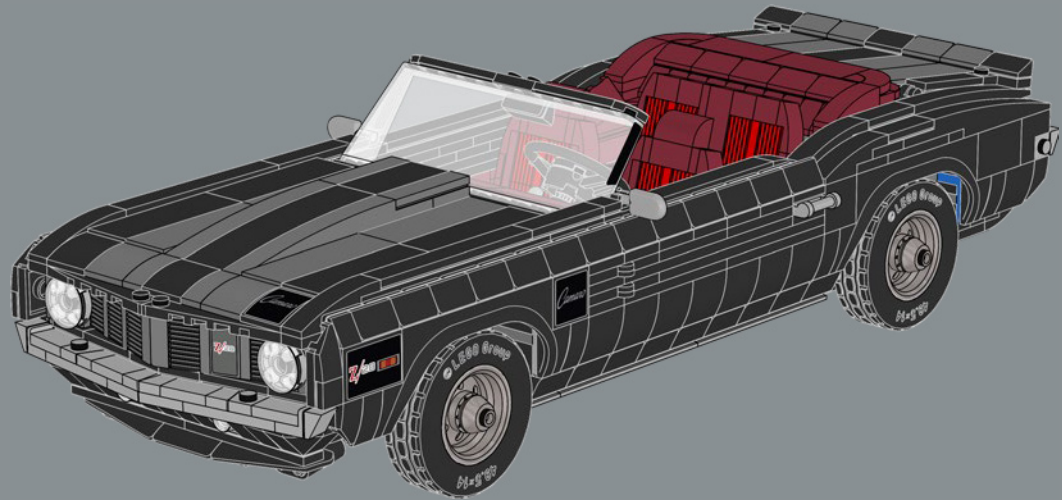
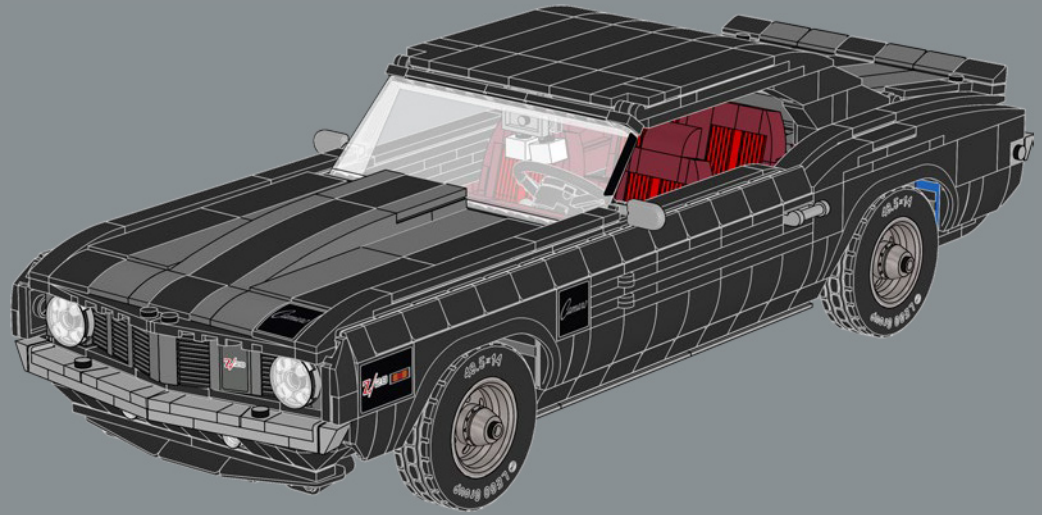

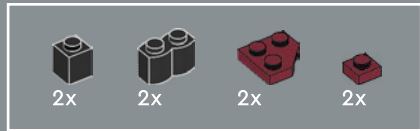
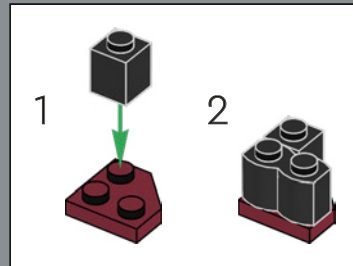

317

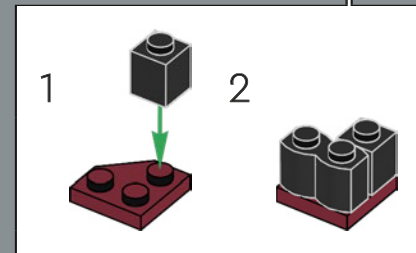
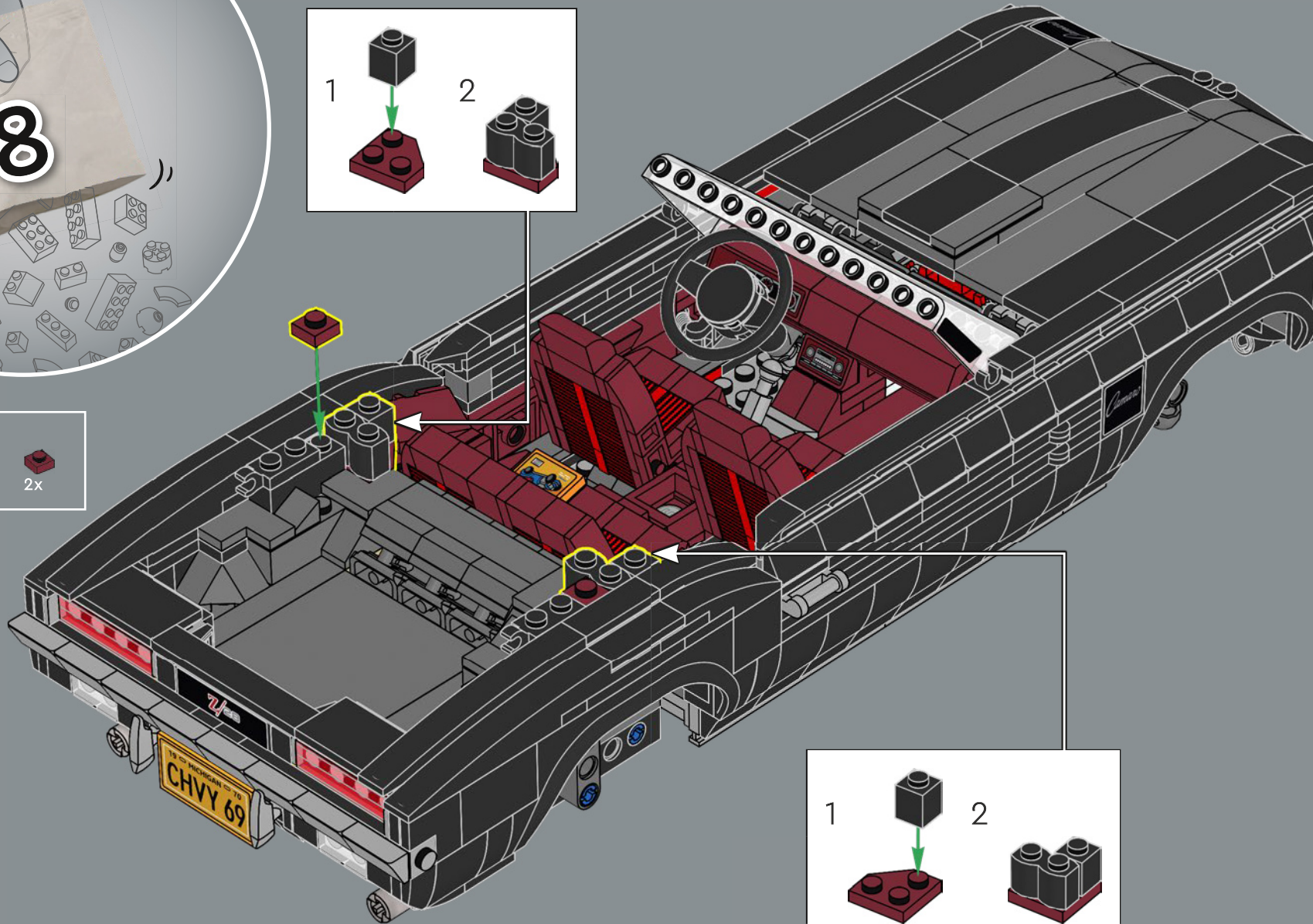



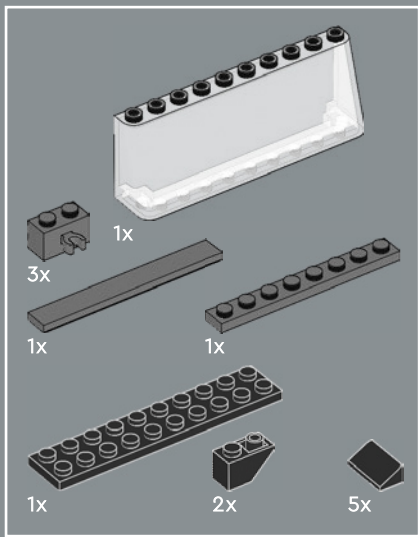

318

1

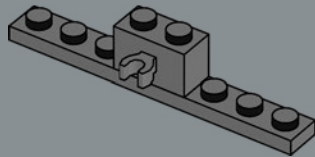

2

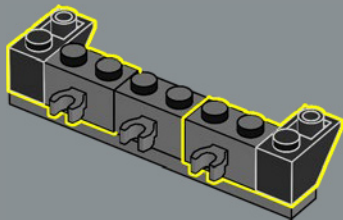

3

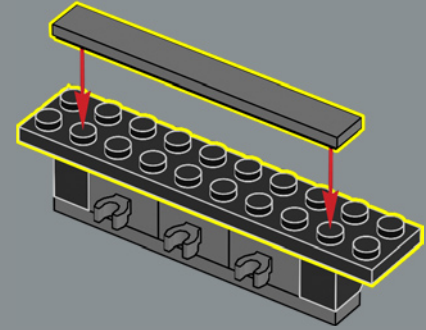

4

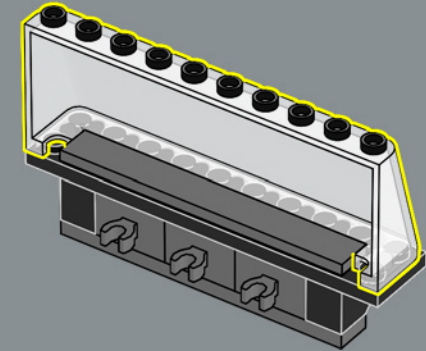

5

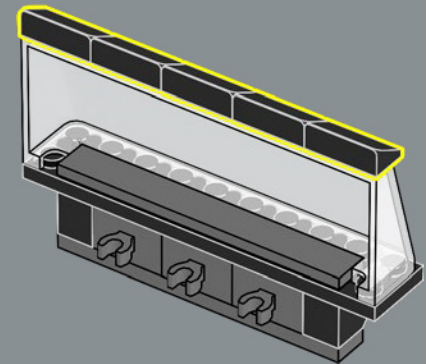

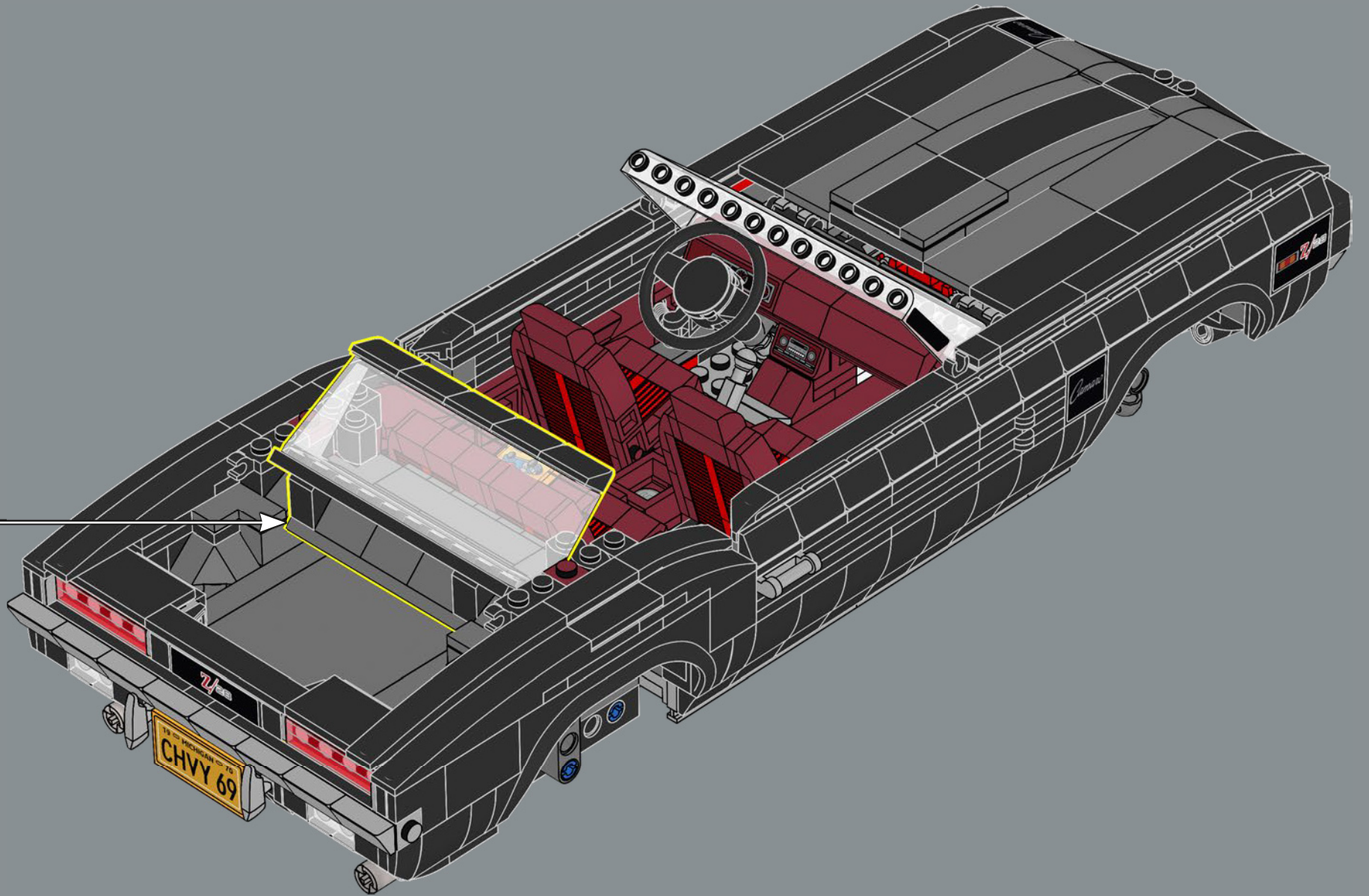

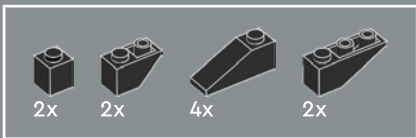

319

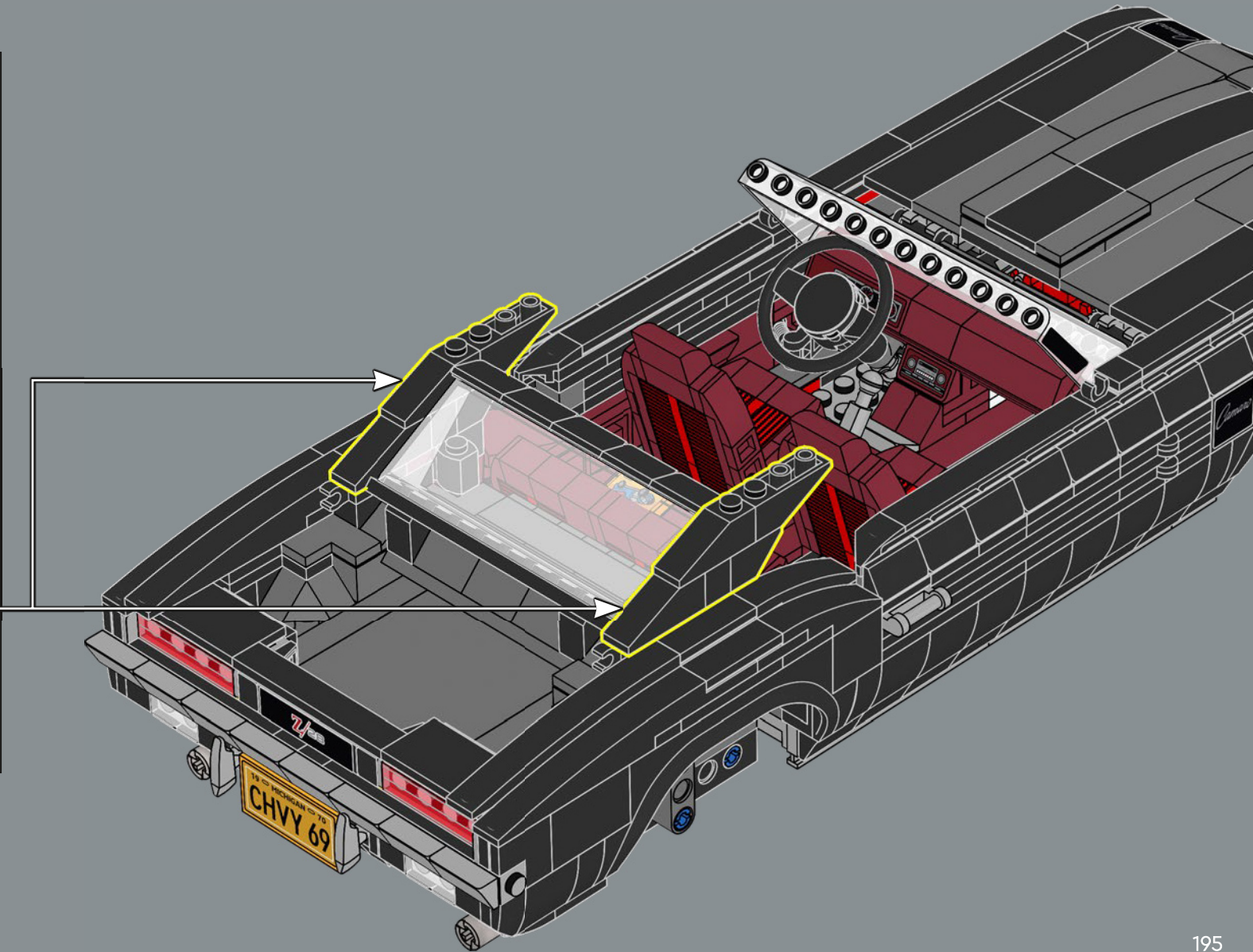
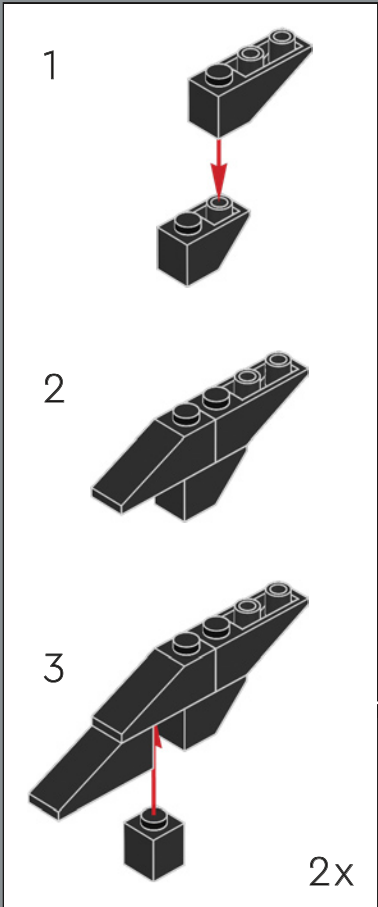

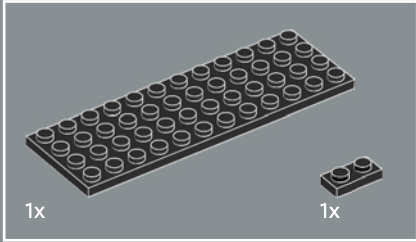
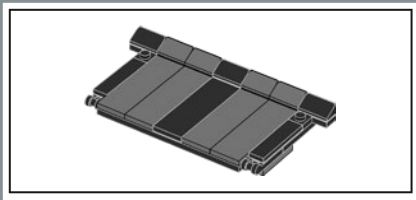

320

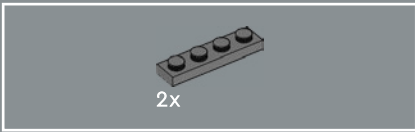
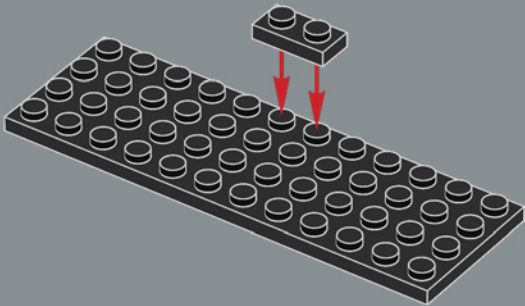

321

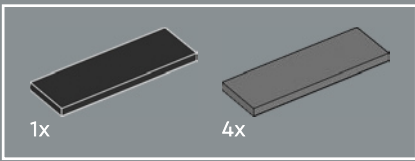
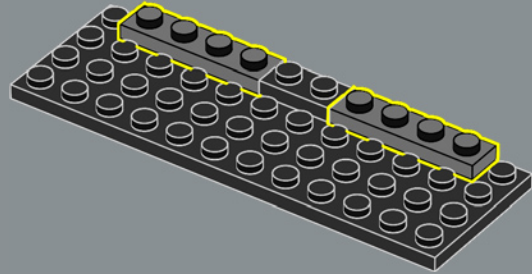

322

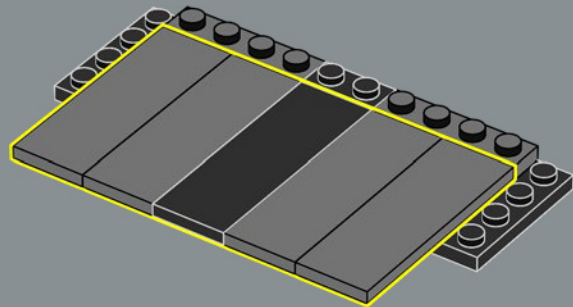

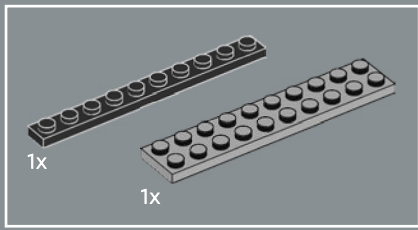

323

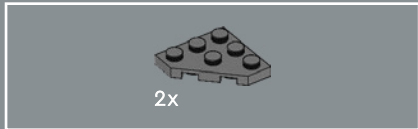
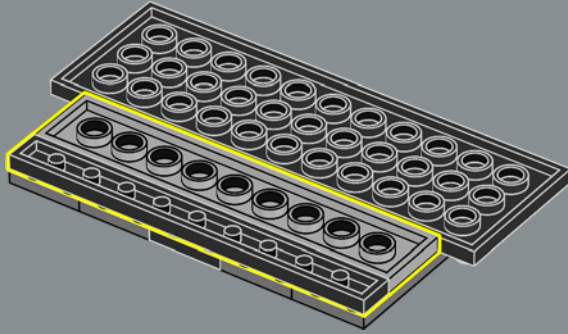

324

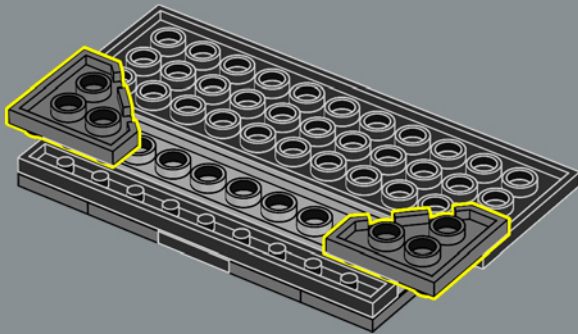

325

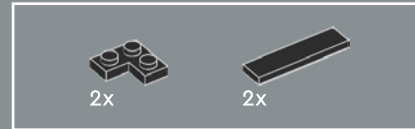
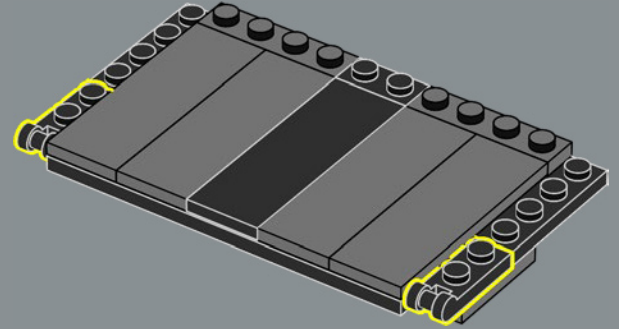

326

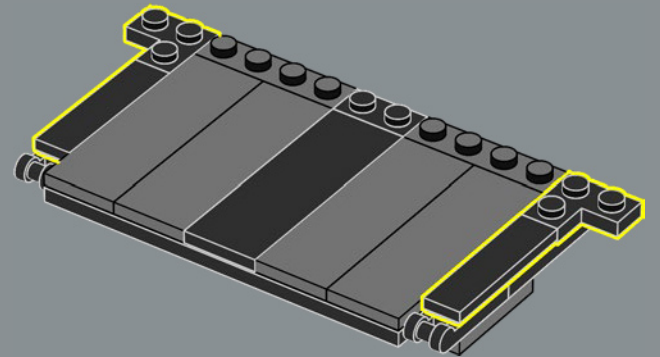

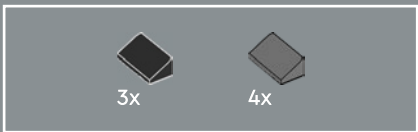

327

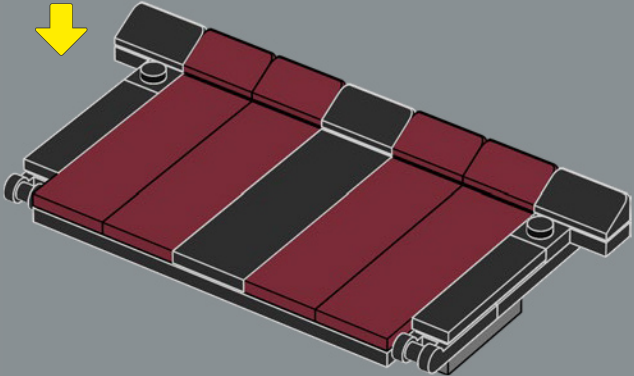
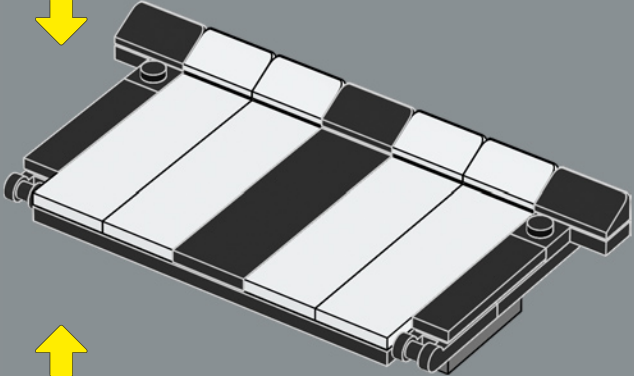
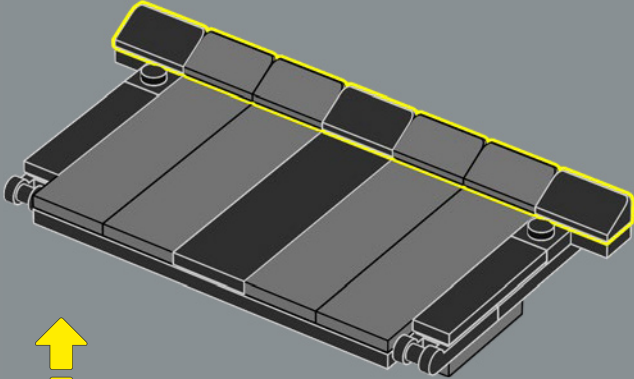

328

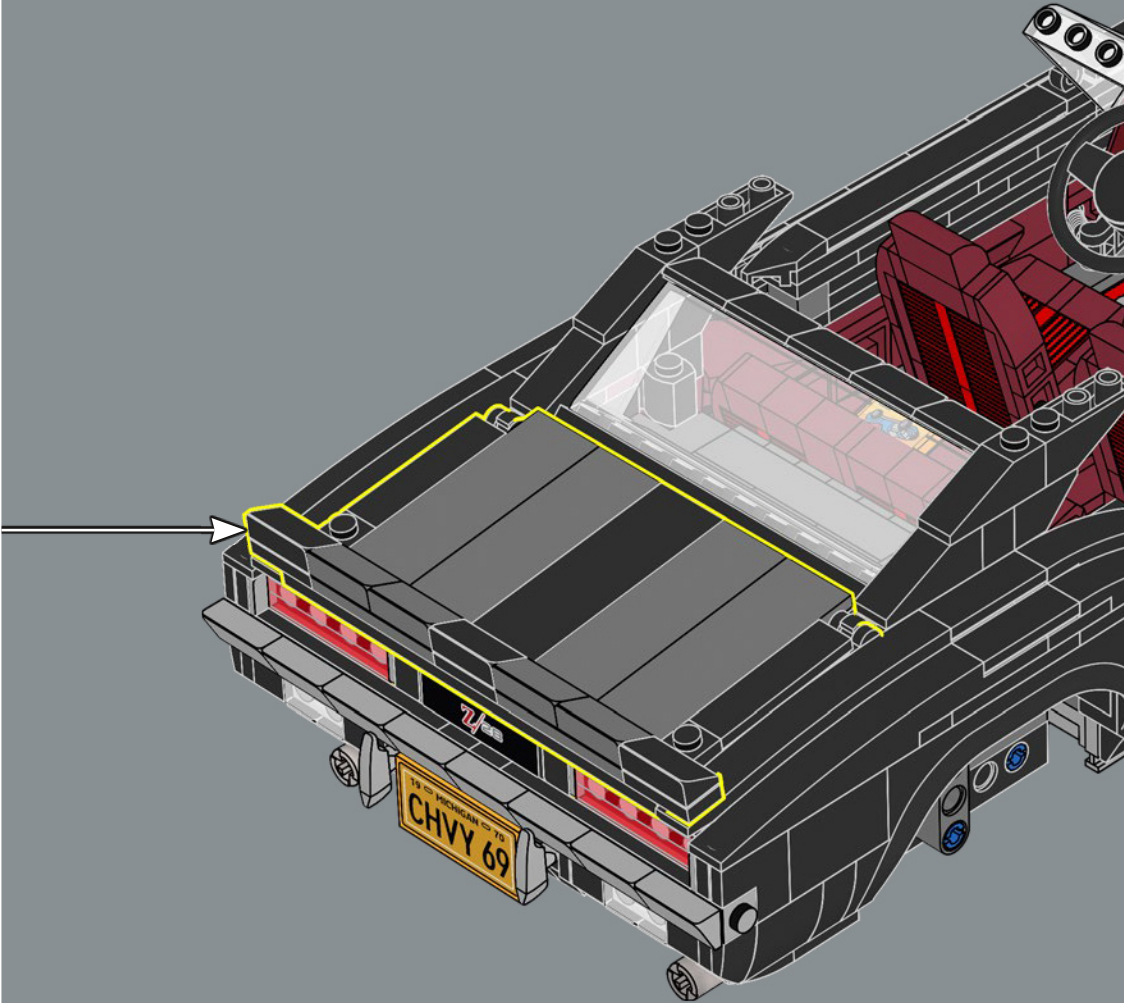

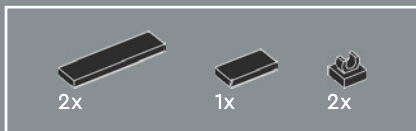

329

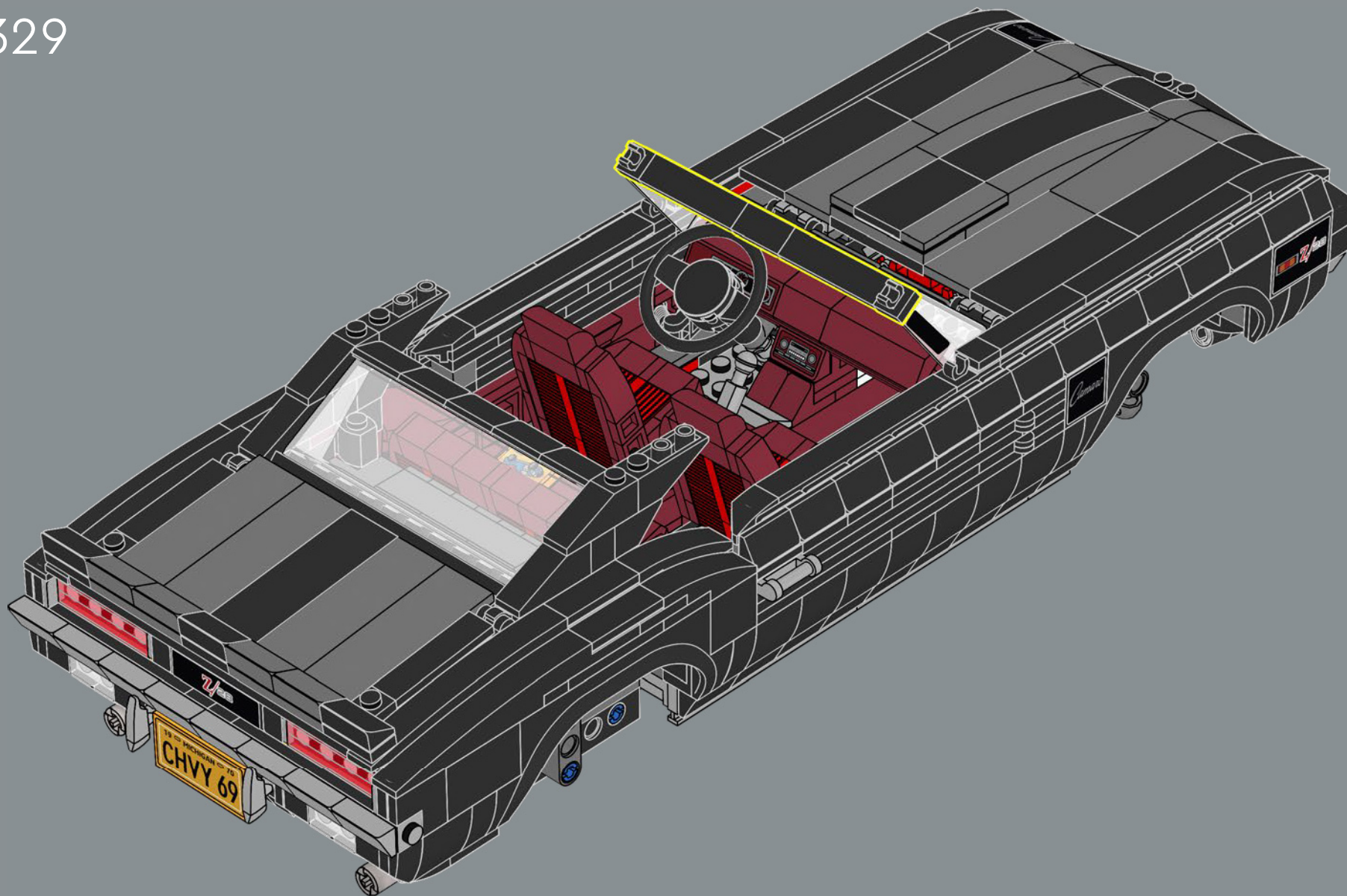

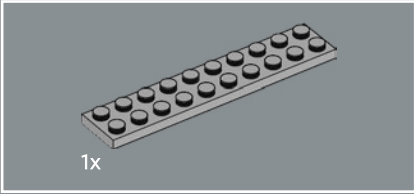
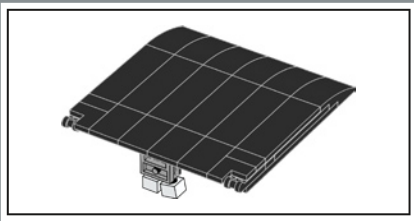

330

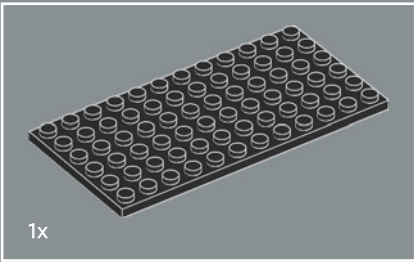
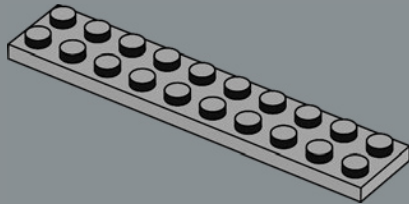

331

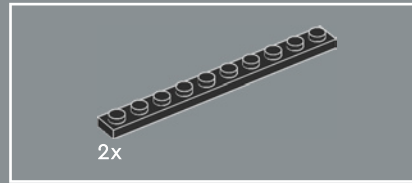
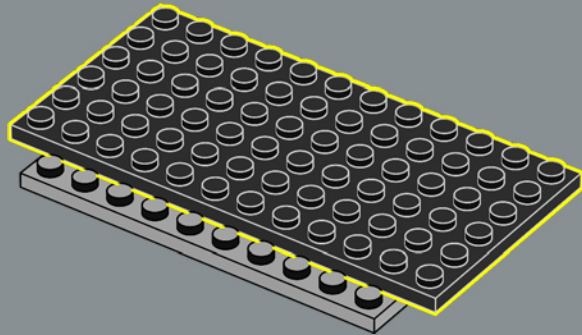

2x

332

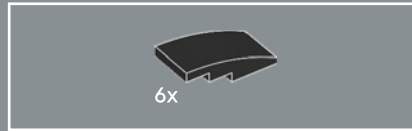
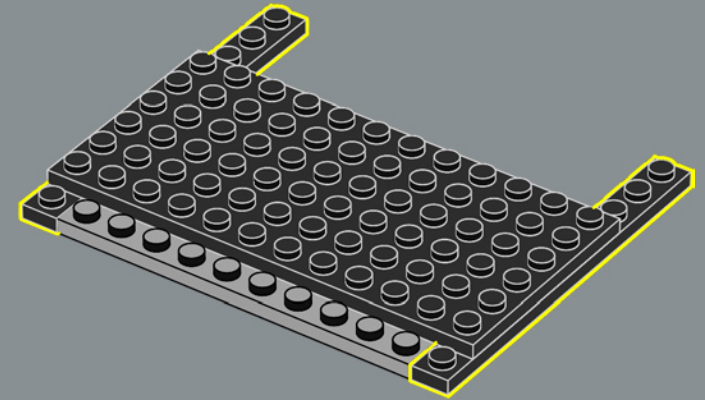

6x

333

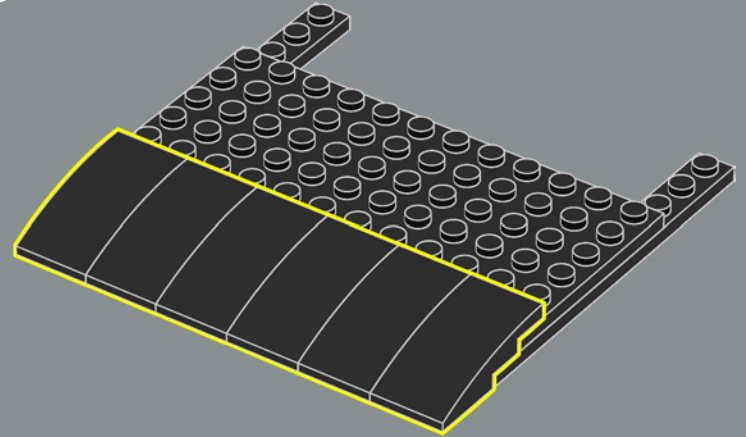



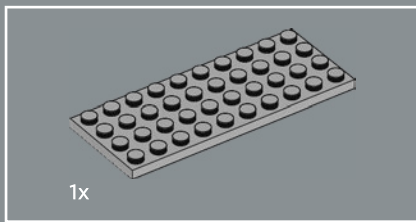

334

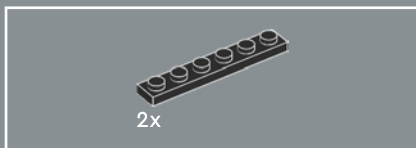
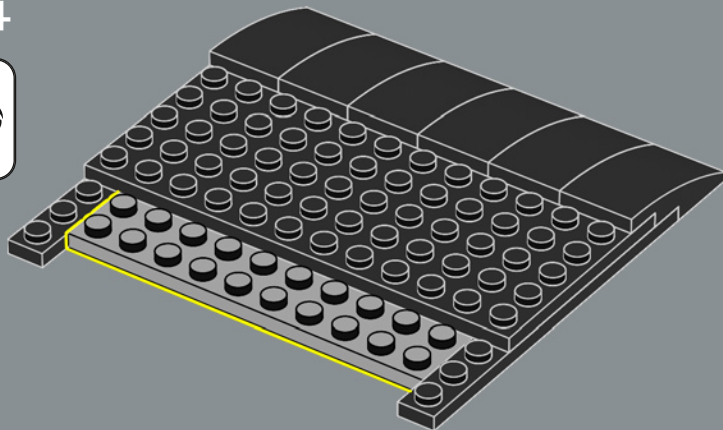

335

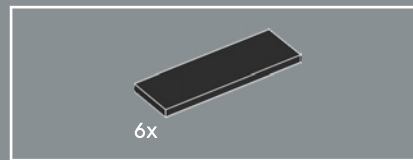
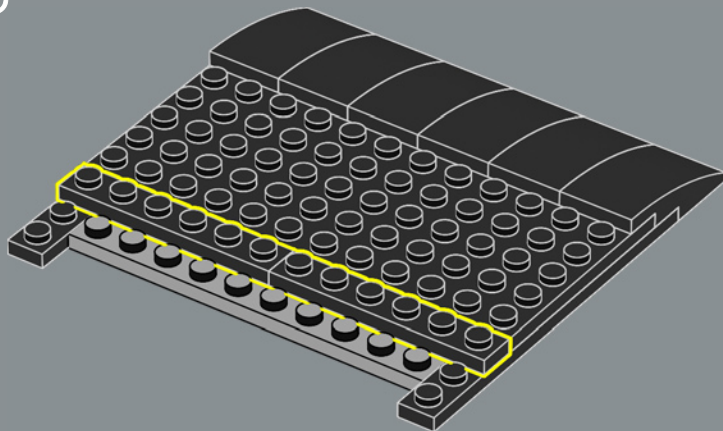

336

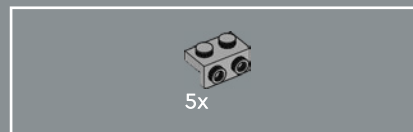
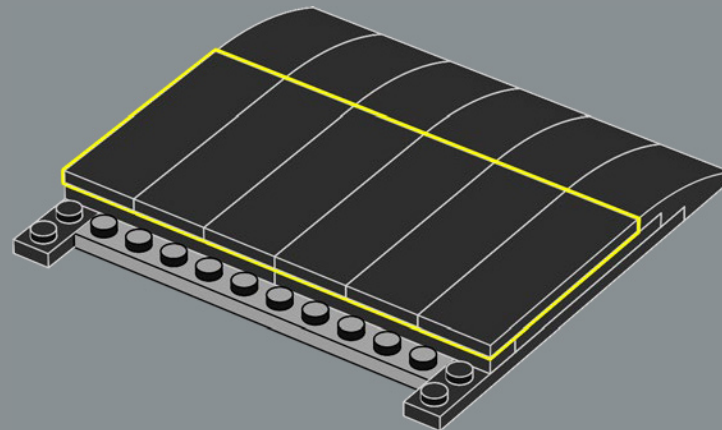

337

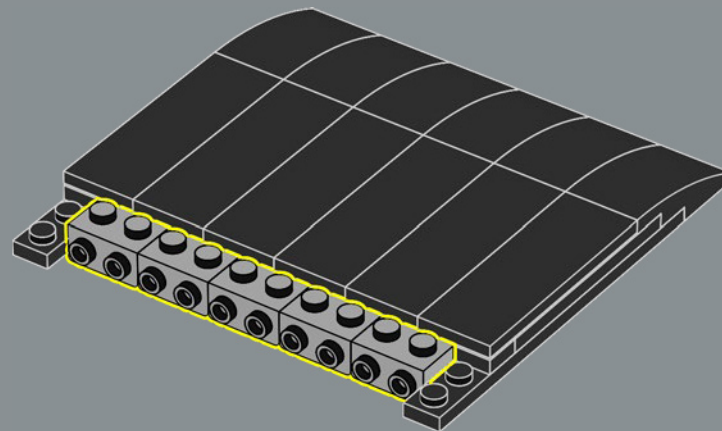

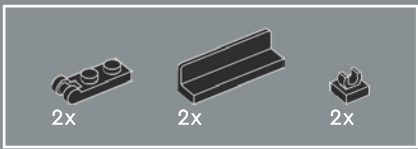

338

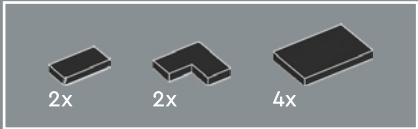
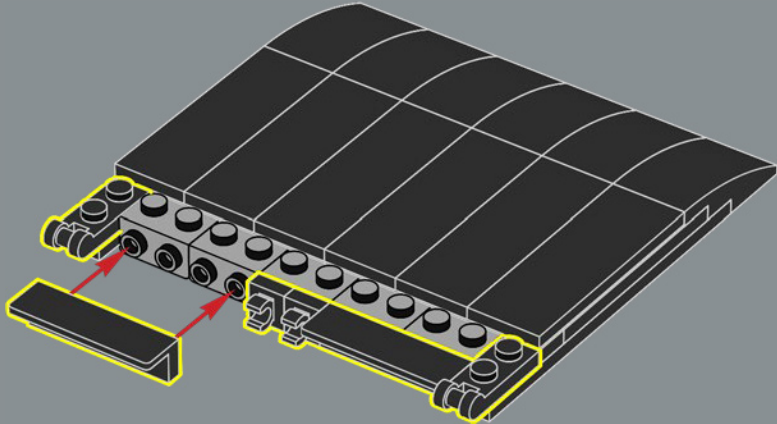

339

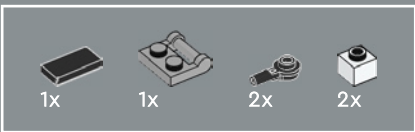
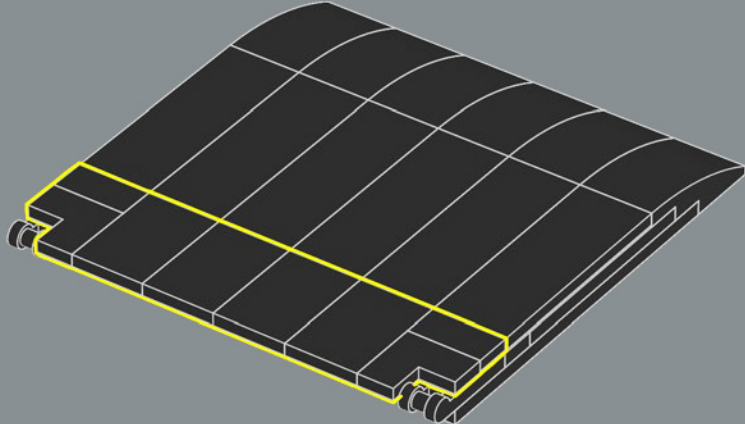

340

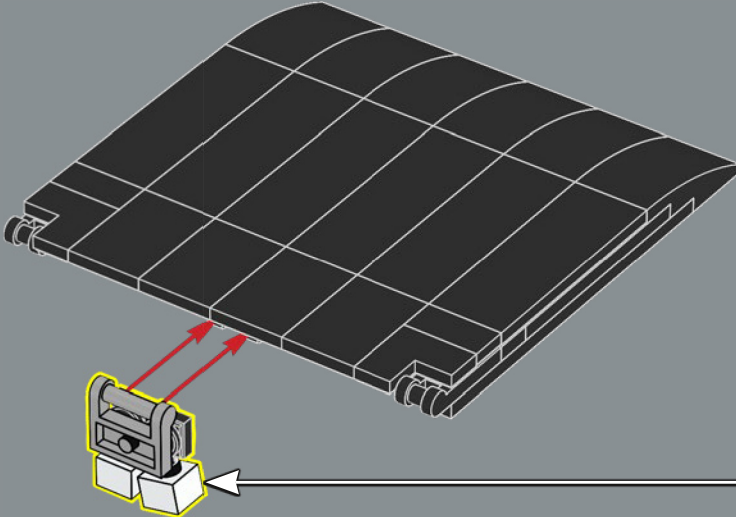
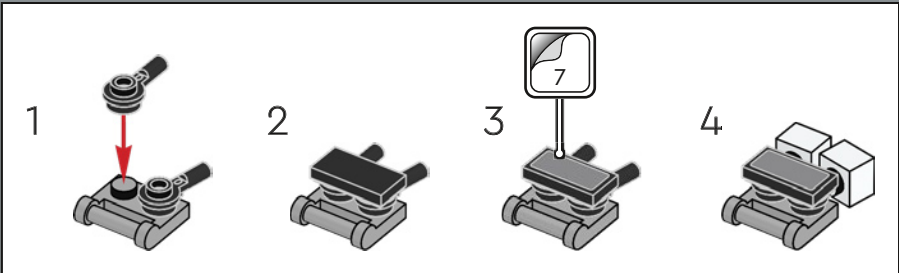

341

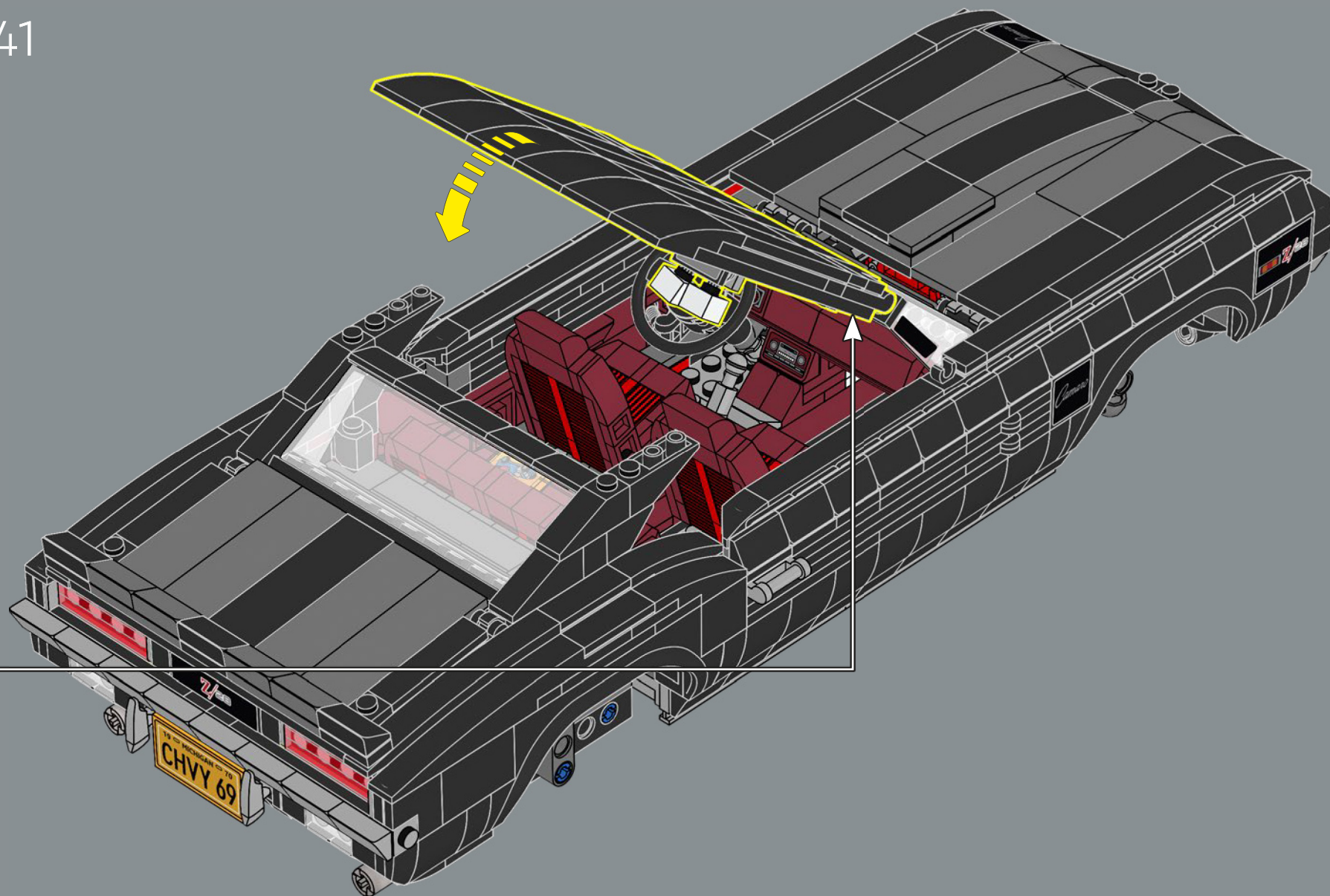

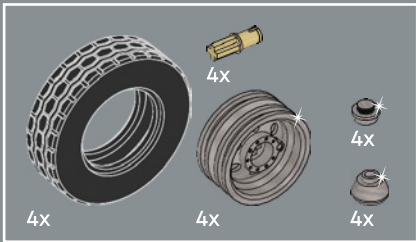
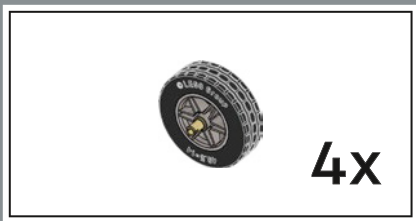

342

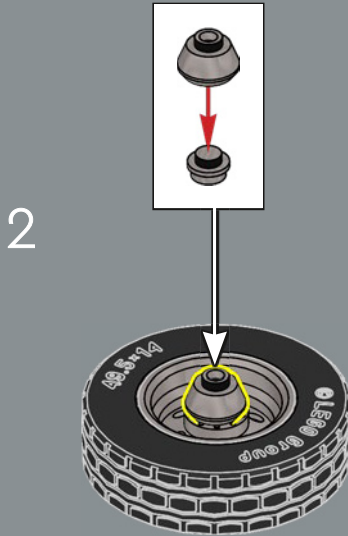
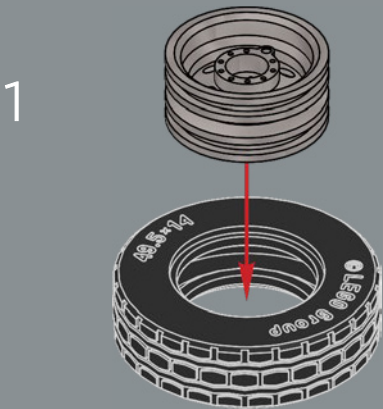

4x

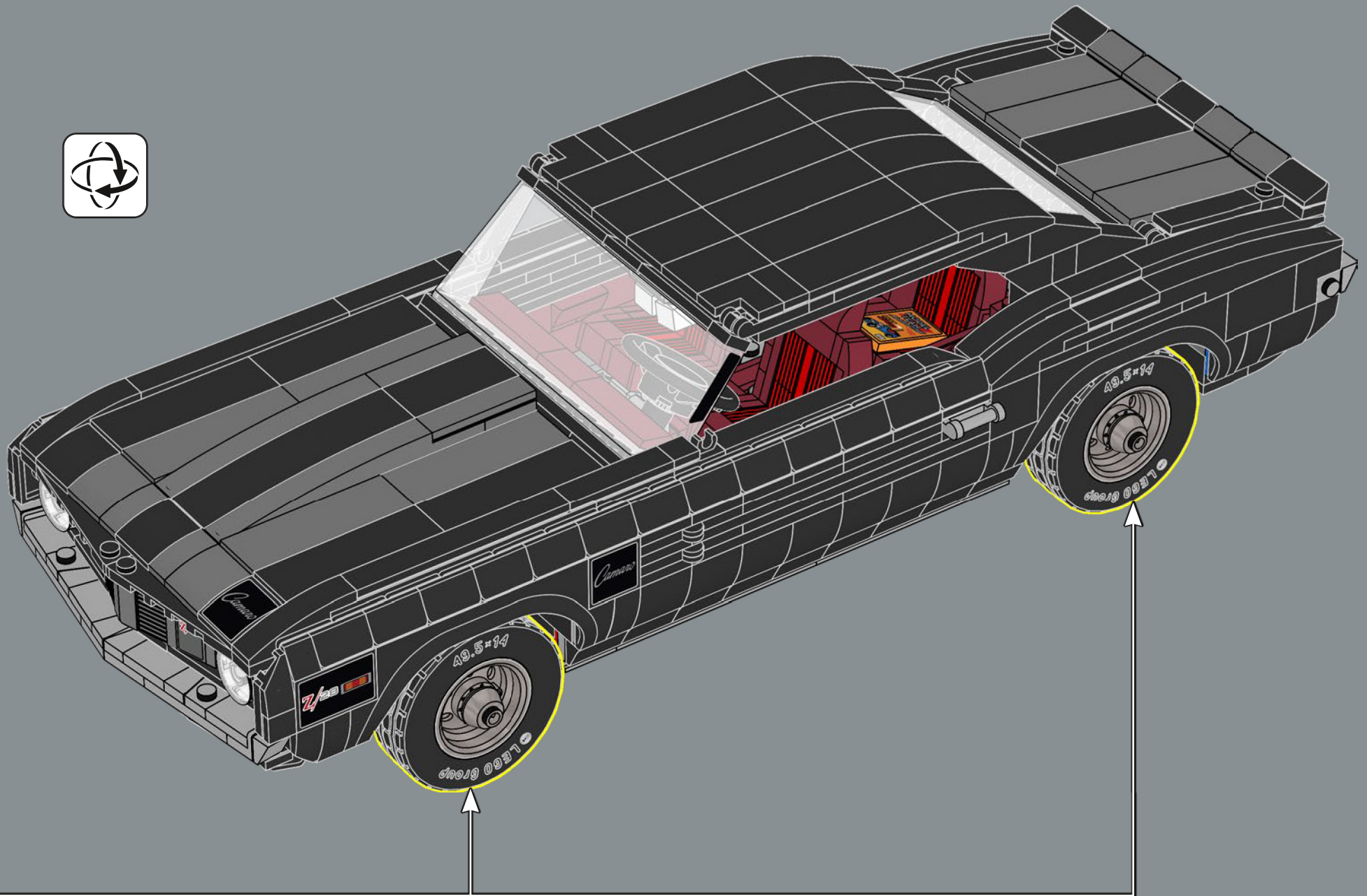



2x

343

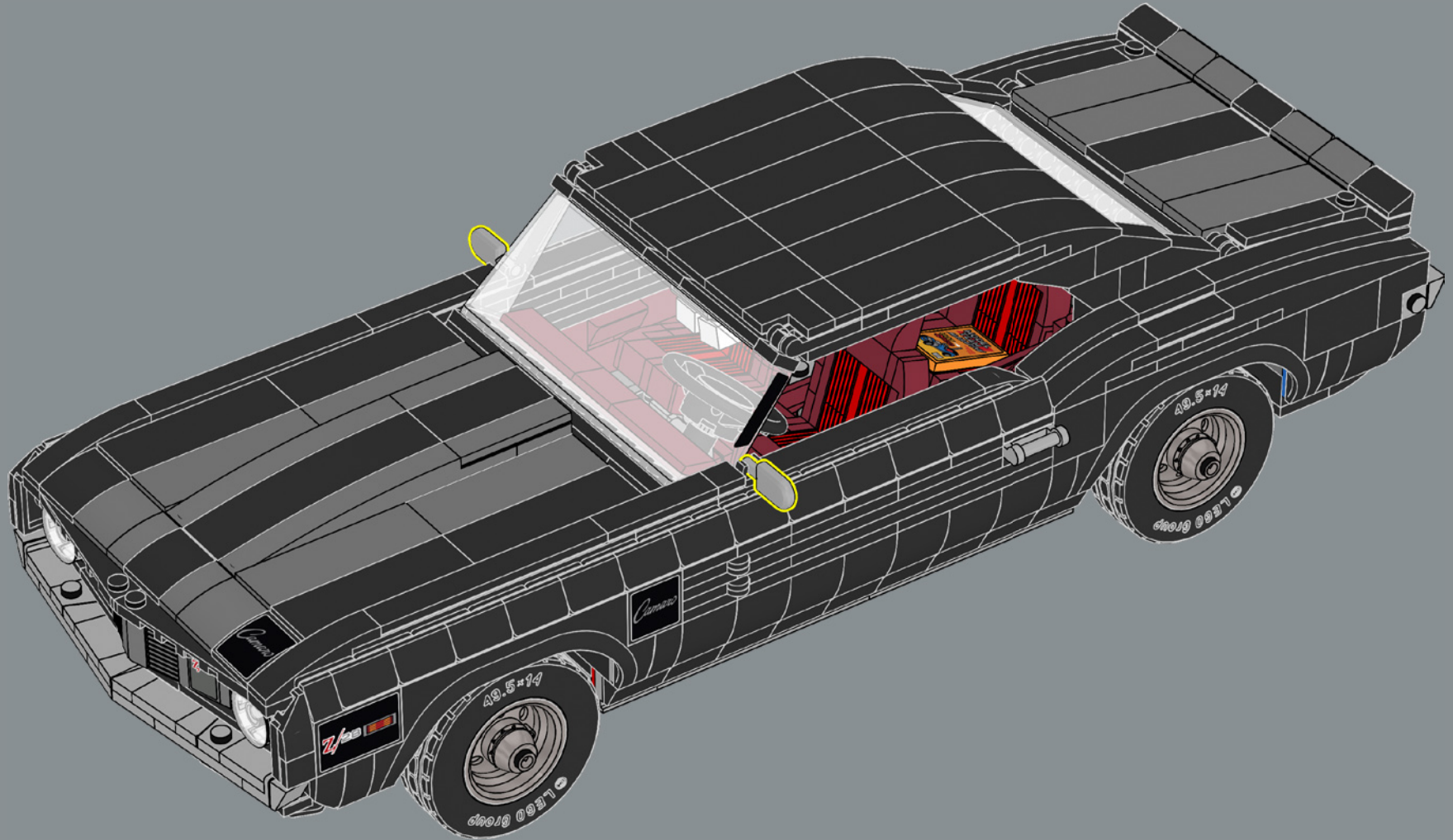

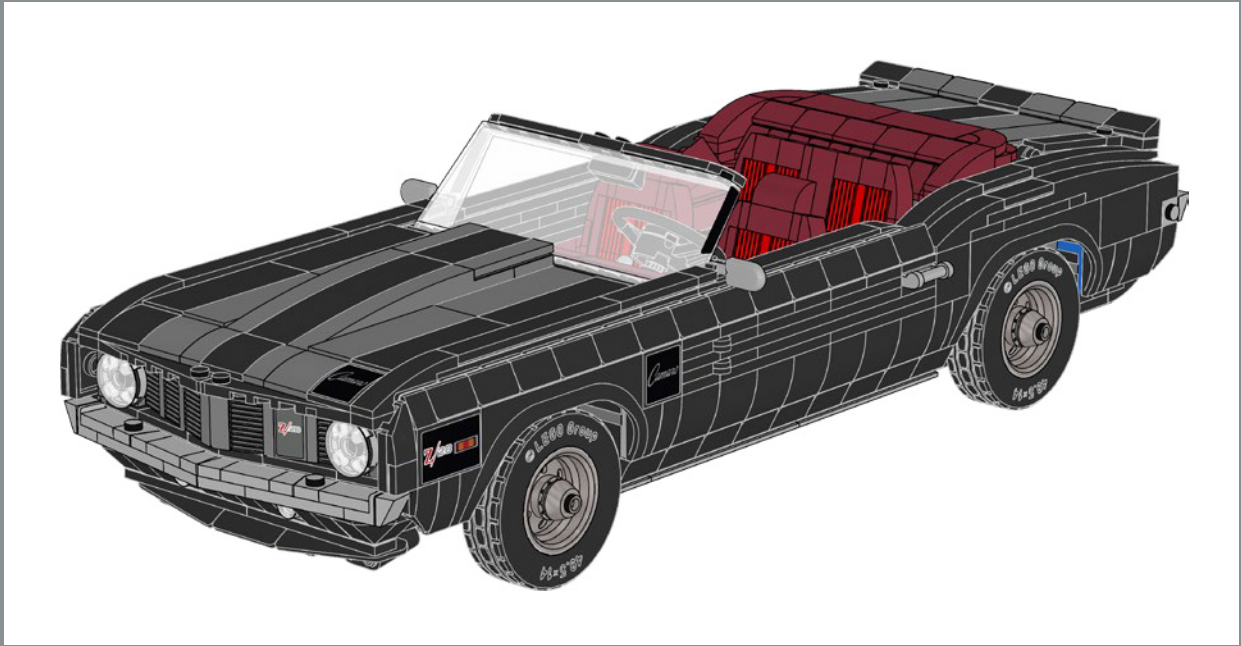

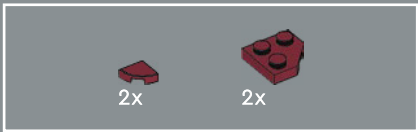

317

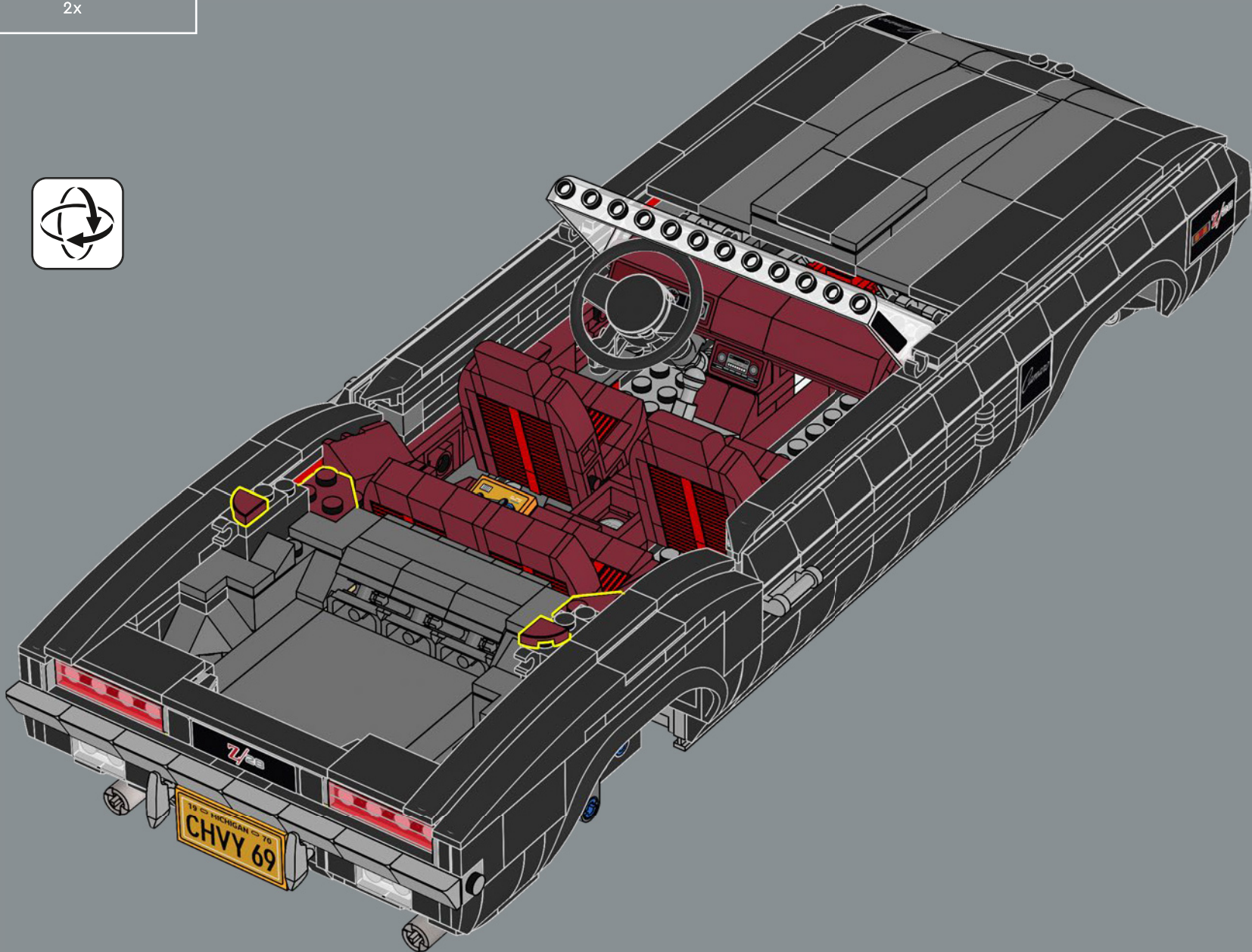



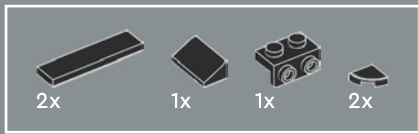

318

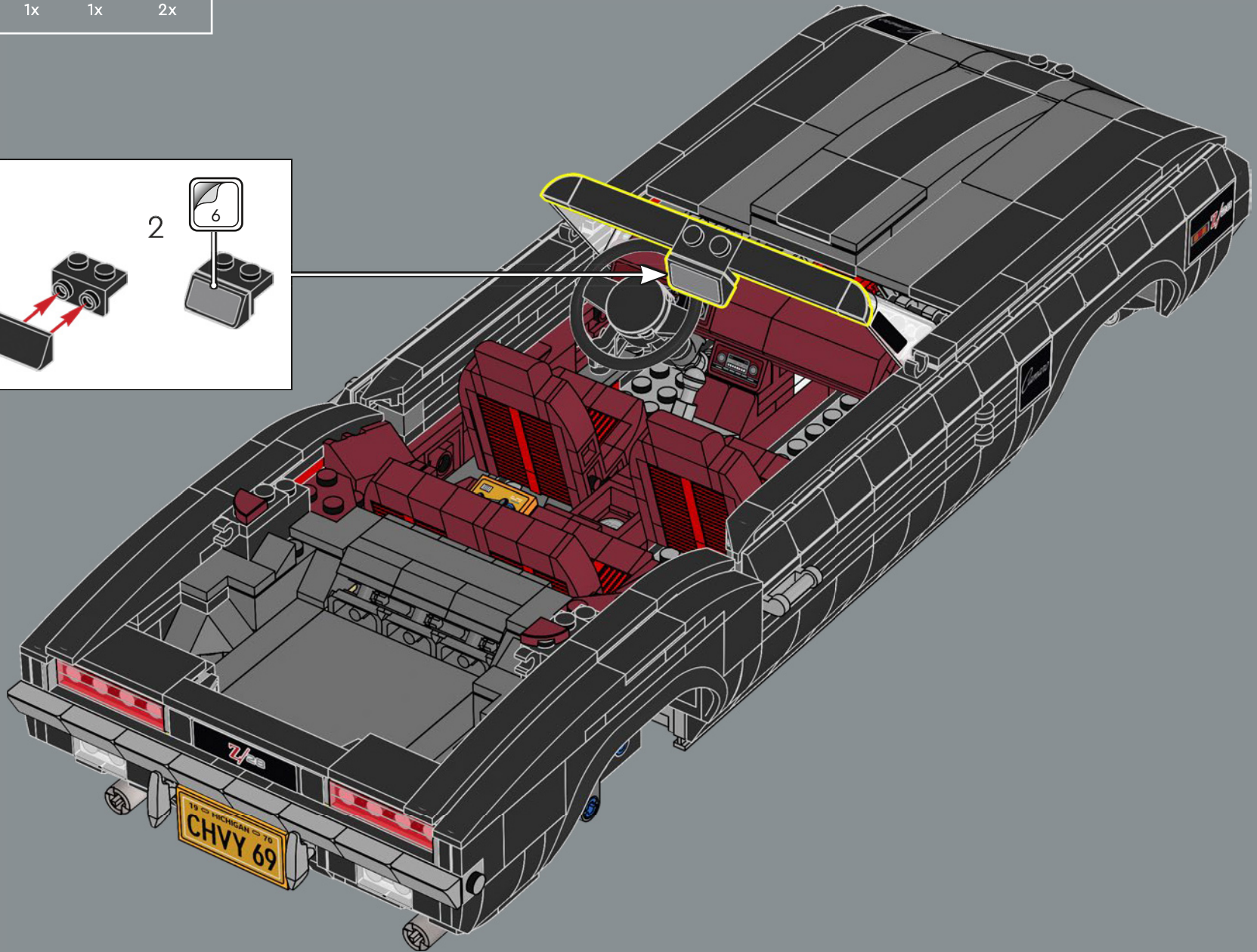
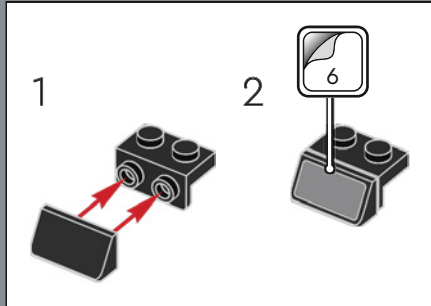

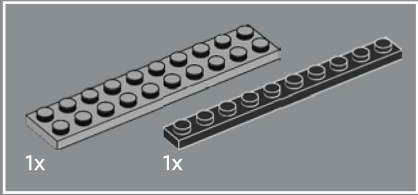

319

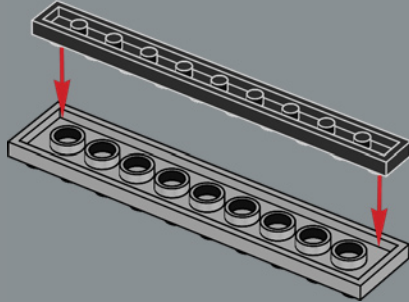

10x

320

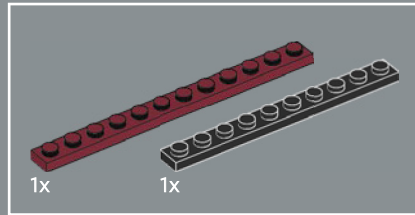
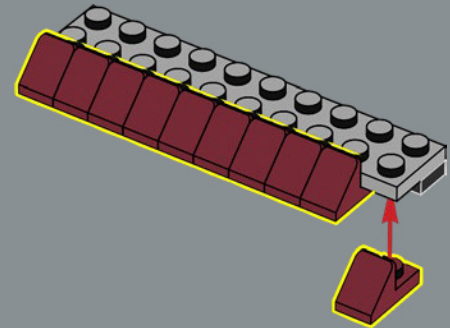

321

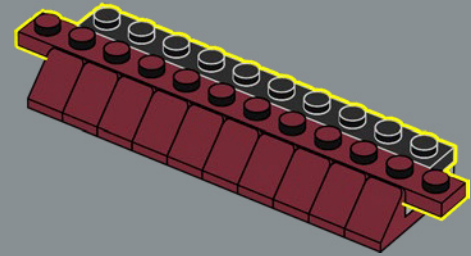

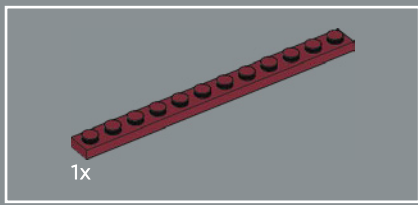

322

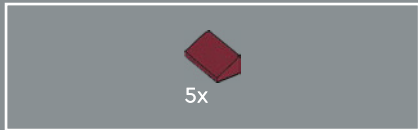
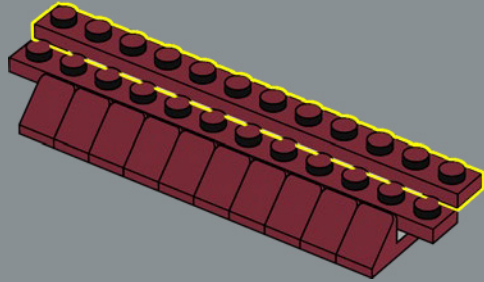

323

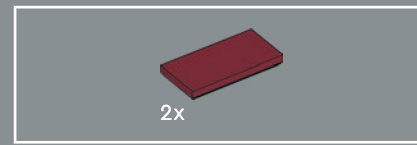
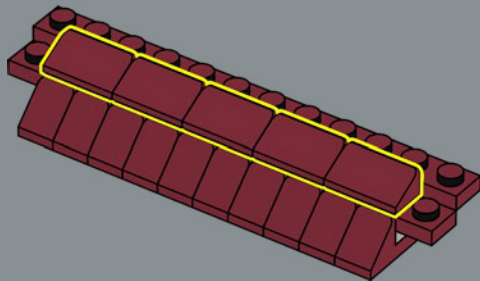

324

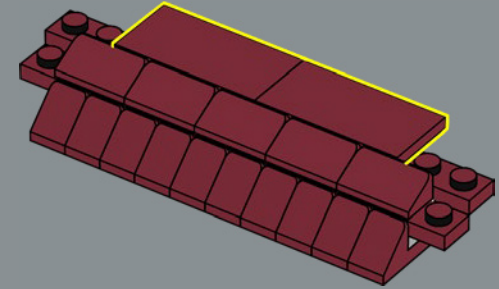

325

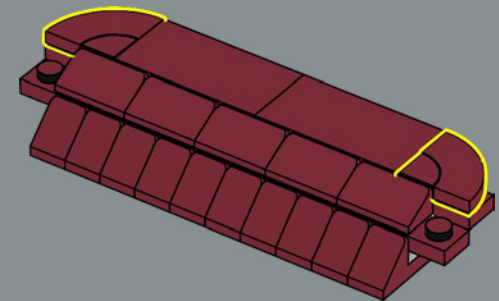

326

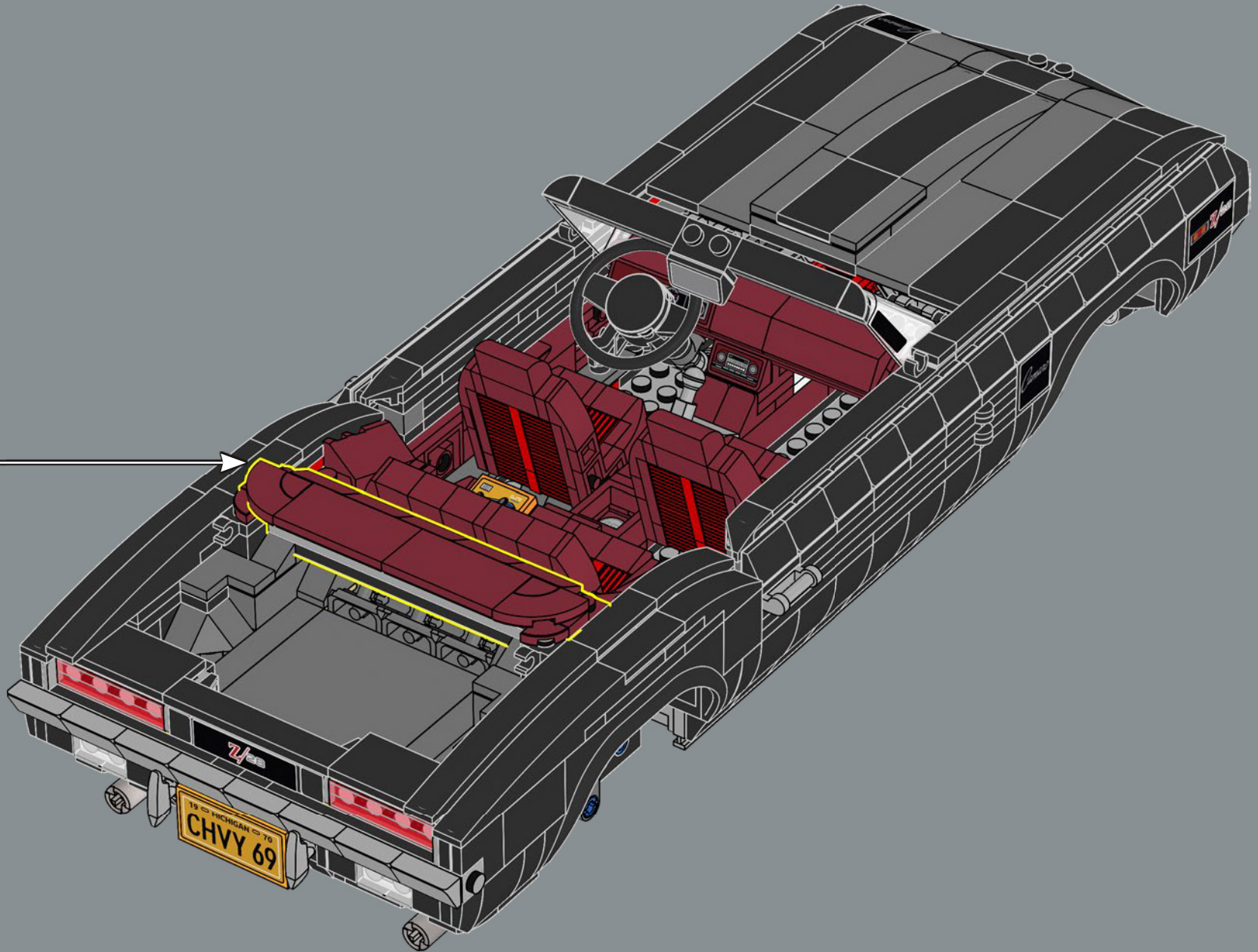

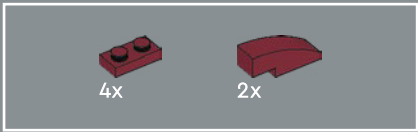

327

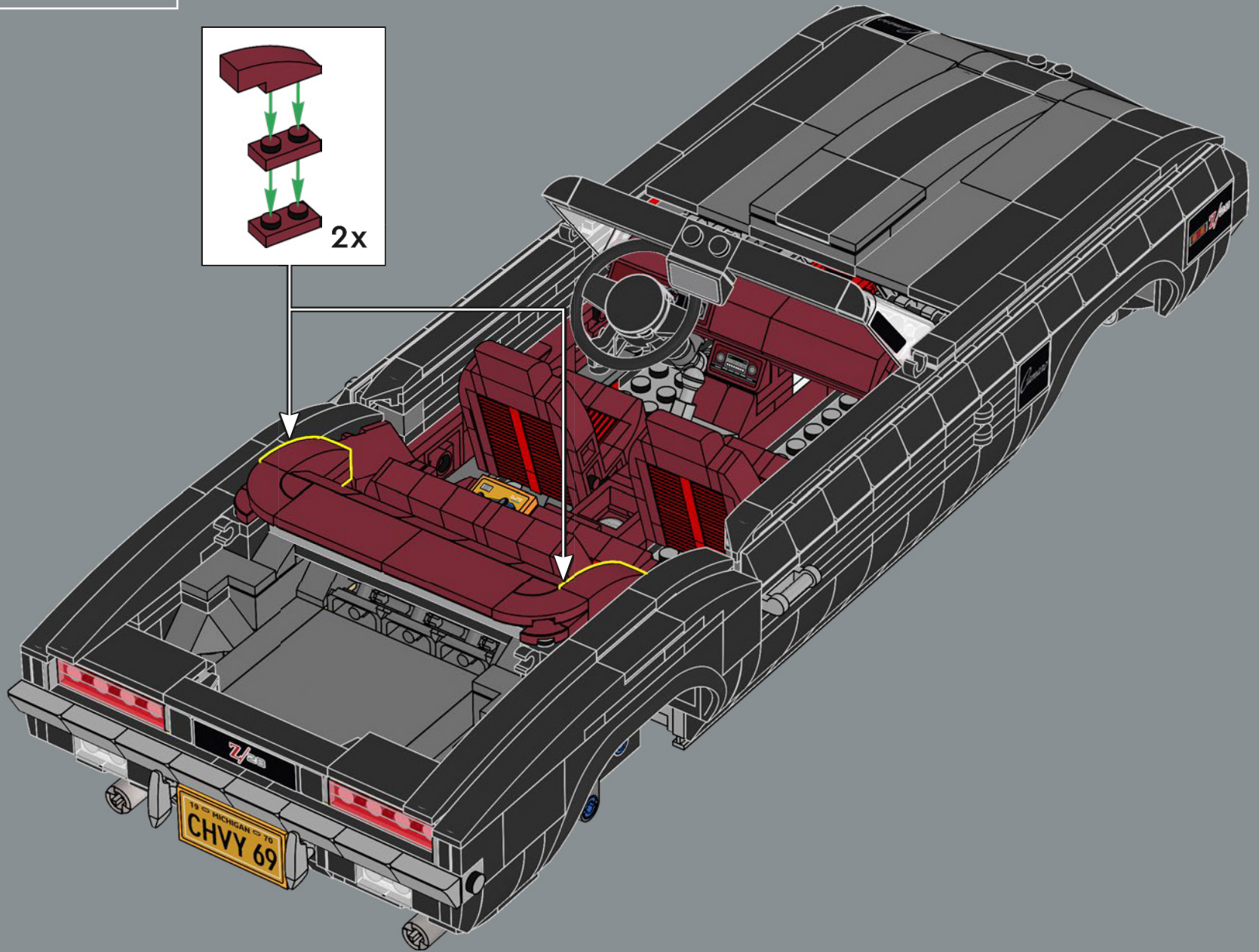
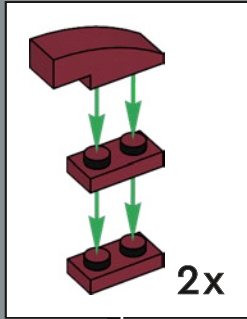

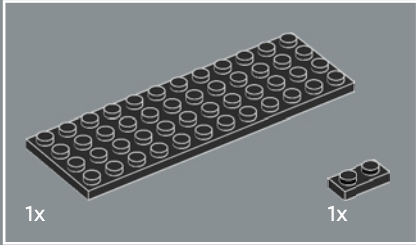
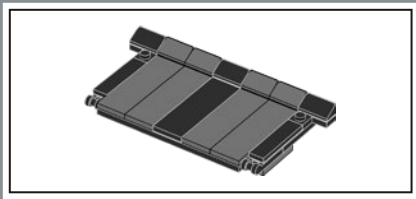

328

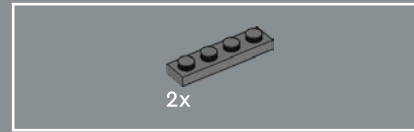
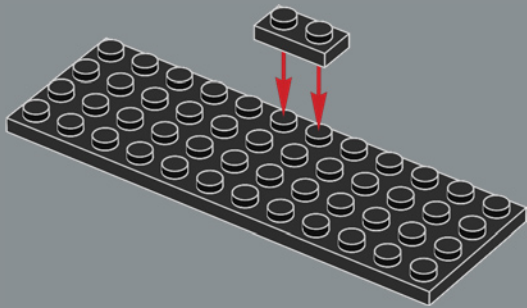

329

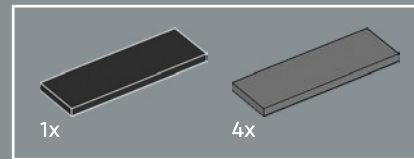
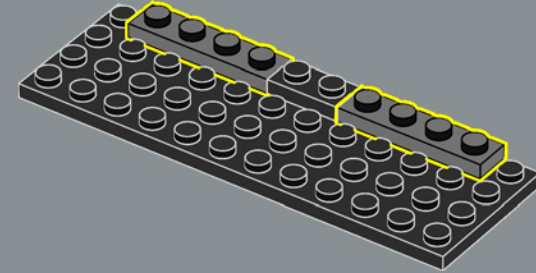

330

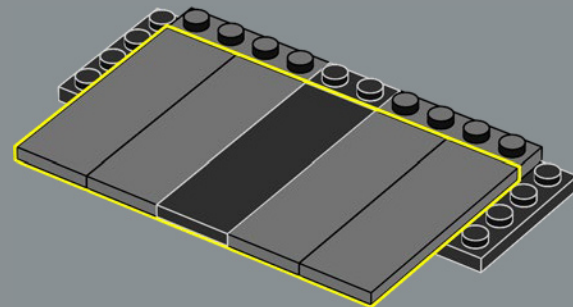

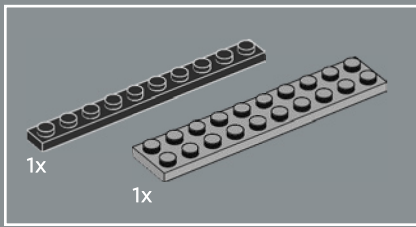

331

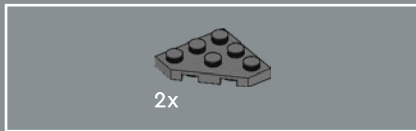
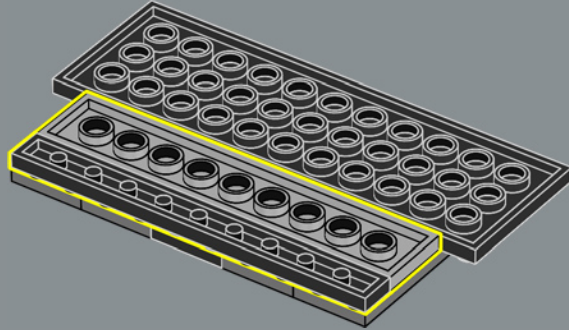

332

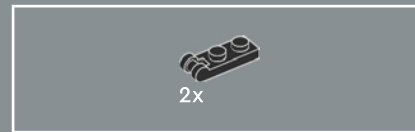
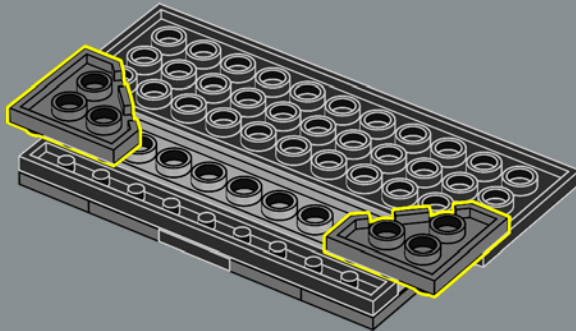

333

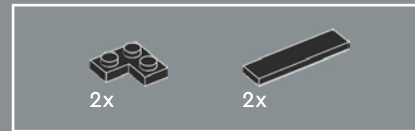
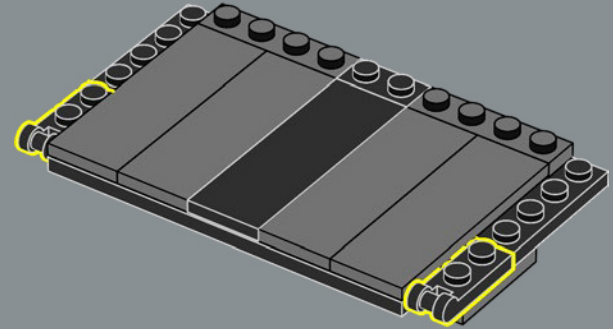

334

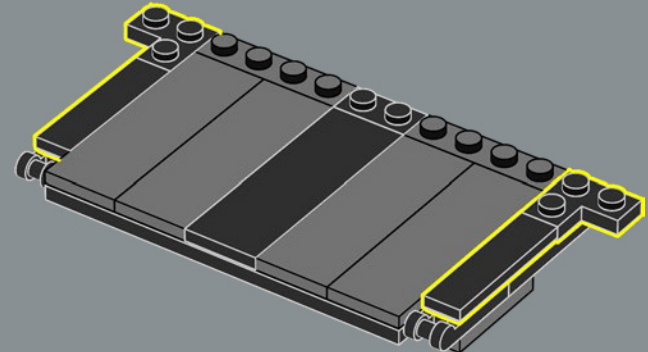



335

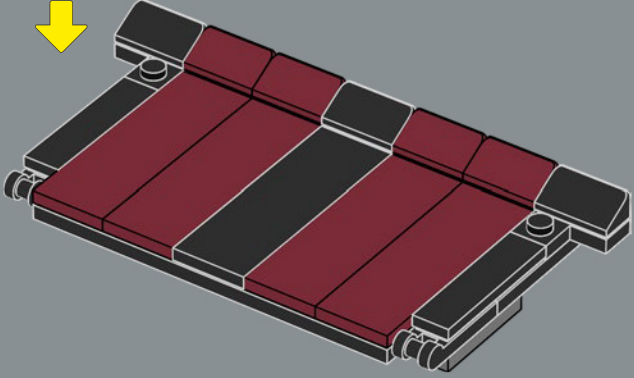
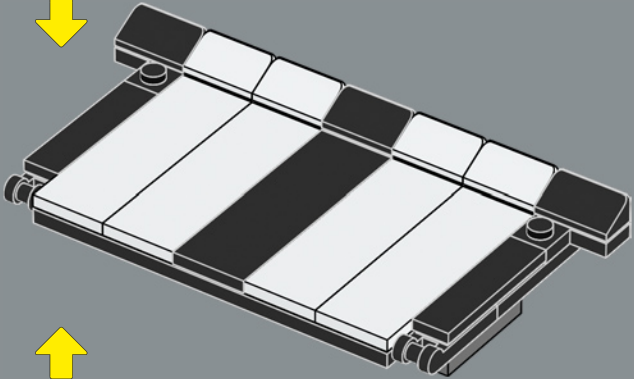
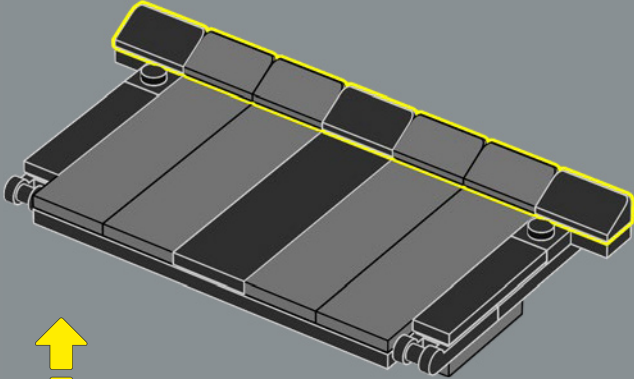

336

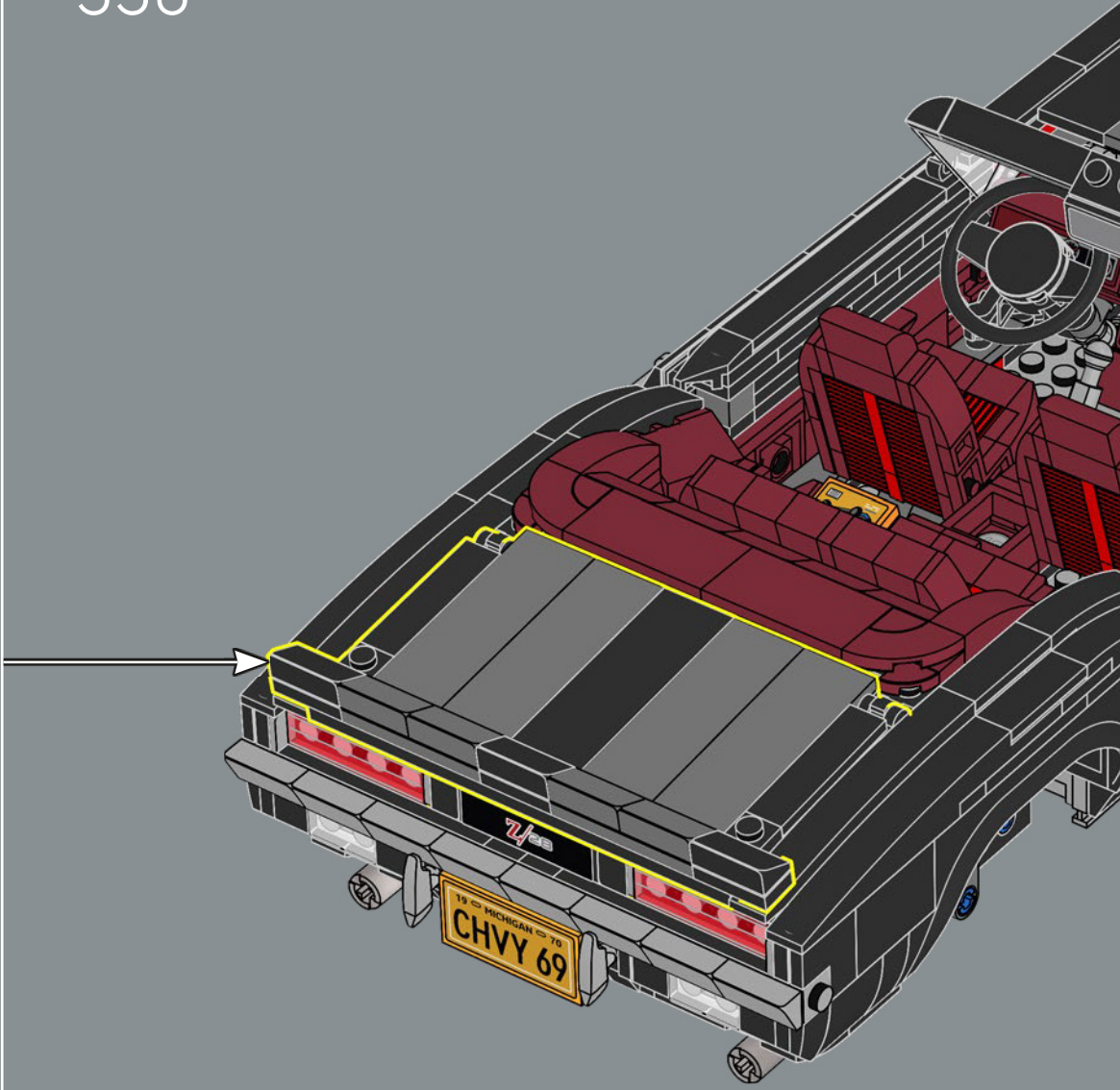



1969 年印第安纳波利斯 500 英里大奖赛 Camaro Z11 安全车的限量版复制品仍然是最受欢迎的 Camaro 车型之一。

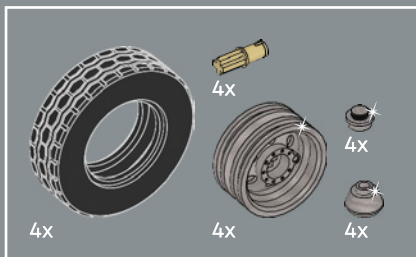
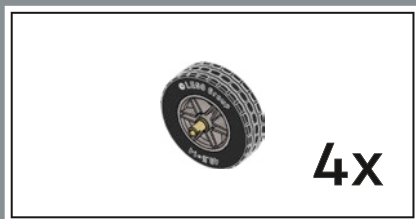

337

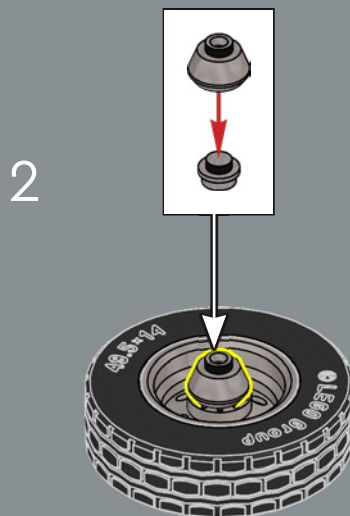
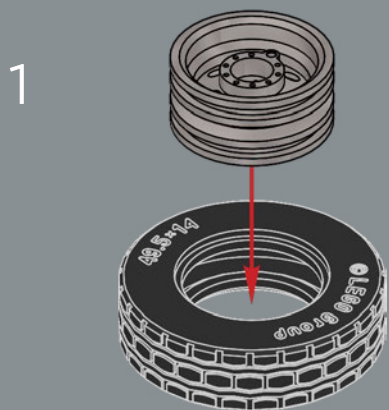

4x

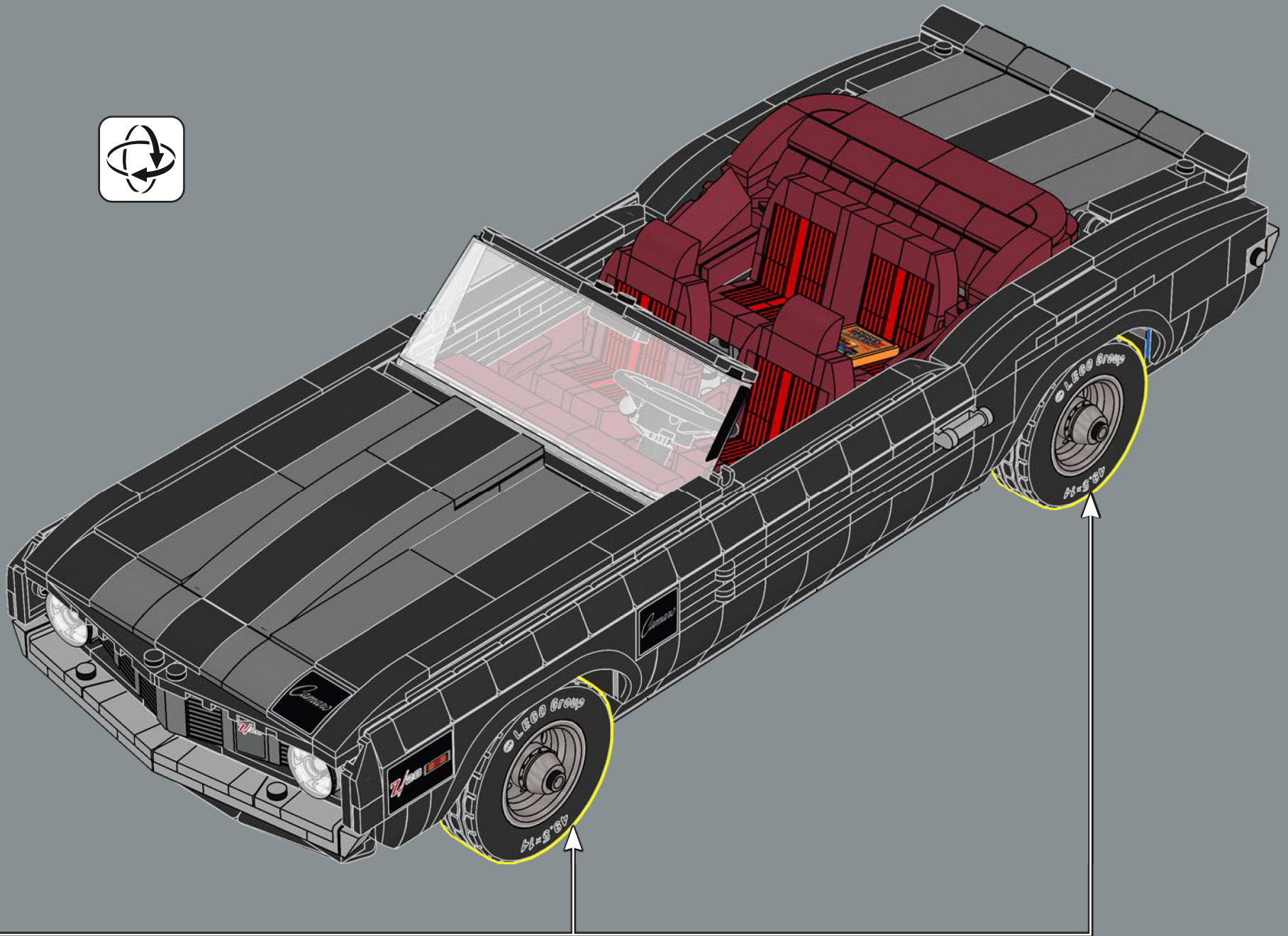



338

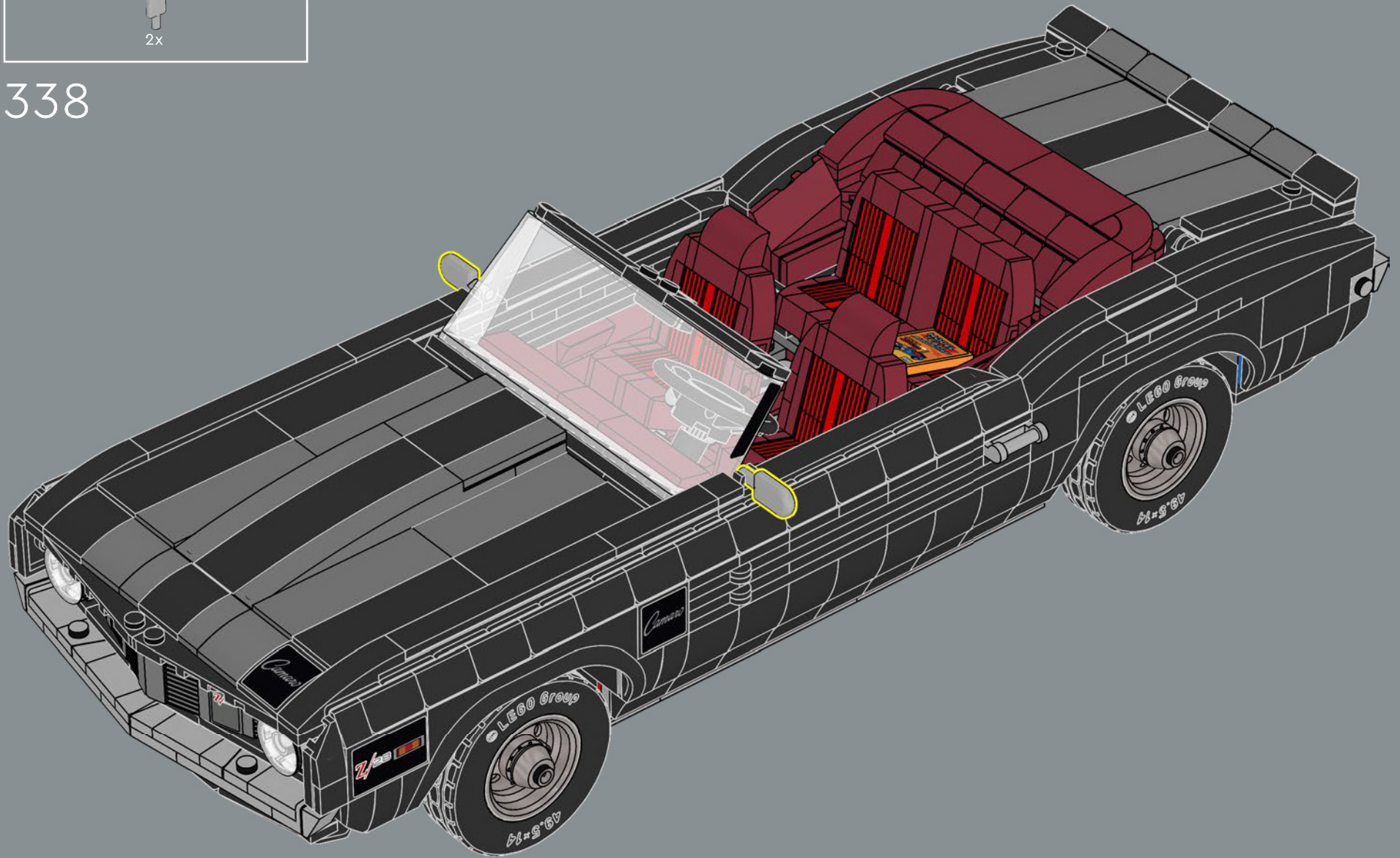

- 4x 4547489
- 2x 6034044
- 2x 6047220
- 4x 6276981
- 2x 6383985
- 4x 302201
- 2x 243101
- 2x 371001
- 2x 6104805
- 3x 302001
- 8x 6332042
- 2x 6035405
- 2x 6242241
- 3x 6347287
- 1x 6265740
- 2x 6146525
- 2x 614101
- 1x 6371416
- 1x 6289797
- 2x 4162465
- 8x 4118793
- 2x 6360037
- 8x 6024495
- 6x 4523145
- 8x 4121921
- 3x 4143409
- 3x 4249019
- 6x 6253003
- 2x 6013938
- 4x 4666579
- 2x 6416525
- 24x 6219677
- 2x 300321
- 2x 4558886
- 1x 654121
- 2x 370021
- 2x 6385920
- 1x 6275178
- 1x 330021
- 2x 307021
- 2x 302321
- 4x 6092565
- 2x 306921
- 6x 362321
- 2x 6378120
- 12x 371021
- 1x 303221
- 1x 303421
- 2x 6337002
- 2x 6347308
- 6x 6261351
- 5x 6168634
- 1x 6266205
- 8x 6168619
- 1x 6271820
- 3x 4142865
- 4x 6347789
- 1x 6130002
- 6x 393721
- 2x 300223
- 6x 6290531
- 1x 4212411
- 1x 6171063
- 2x 6057802
- 2x 306923
- 4x 6252060
- 2x 6196596
- 3x 303423
- 3x 6117968
- 4x 4206482
- 10x 6299413
- 2x 393723
- 2x 300524
- 2x 235724
- 2x 654124
- 14x 302324
- 2x 6195183
- 2x 6271167
- 1x 6170294
- 1x 6331822
- 2x 366624
- 6x 6248833
- 10x 300526
- 2x 4644456
- 4x 300426
- 6x 362226
- 2x 300226
- 5x 301026
- 2x 4584274
- 3x 370226
- 4x 4504382
- 53x 4548180
- 2x 4121966
- 4x 6267487
- 6x 366526
- 12x 6069000
- 1x 303926
- 2x 6176768
- 4x 428626
- 6x 428726
- 1x 6064228
- 5x 6181720
- 4x 6273589
- 2x 4107558
- 4x 302426
- 2x 6388352
- 6x 307026
- 44x 302326
- 8x 306926
- 2x 6214807
- 14x 6192346
- 4x 306826
- 2x 6312724
- 10x 302226
- 6x 242026
- 4x 6133722
- 4x 6195271
- 1x 403226
- 5x 6181713
- 2x 6184784
- 10x 6047276
- 26x 6053077
- 2x 6211476
- 2x 4618880
- 2x 6280394
- 1x 6319983
- 1x 6316923
- 1x 6331026
- 6x 6037746
- 6x 4647286
- 1x 6296083
- 4x 6037664
- 6x 243126
- 6x 371026
- 7x 302026
- 4x 4560182
- 2x 6350415
- 3x 663626
- 12x 366626
- 11x 6318582
- 6x 416226
- 1x 303226
- 1x 395826
- 14x 447726

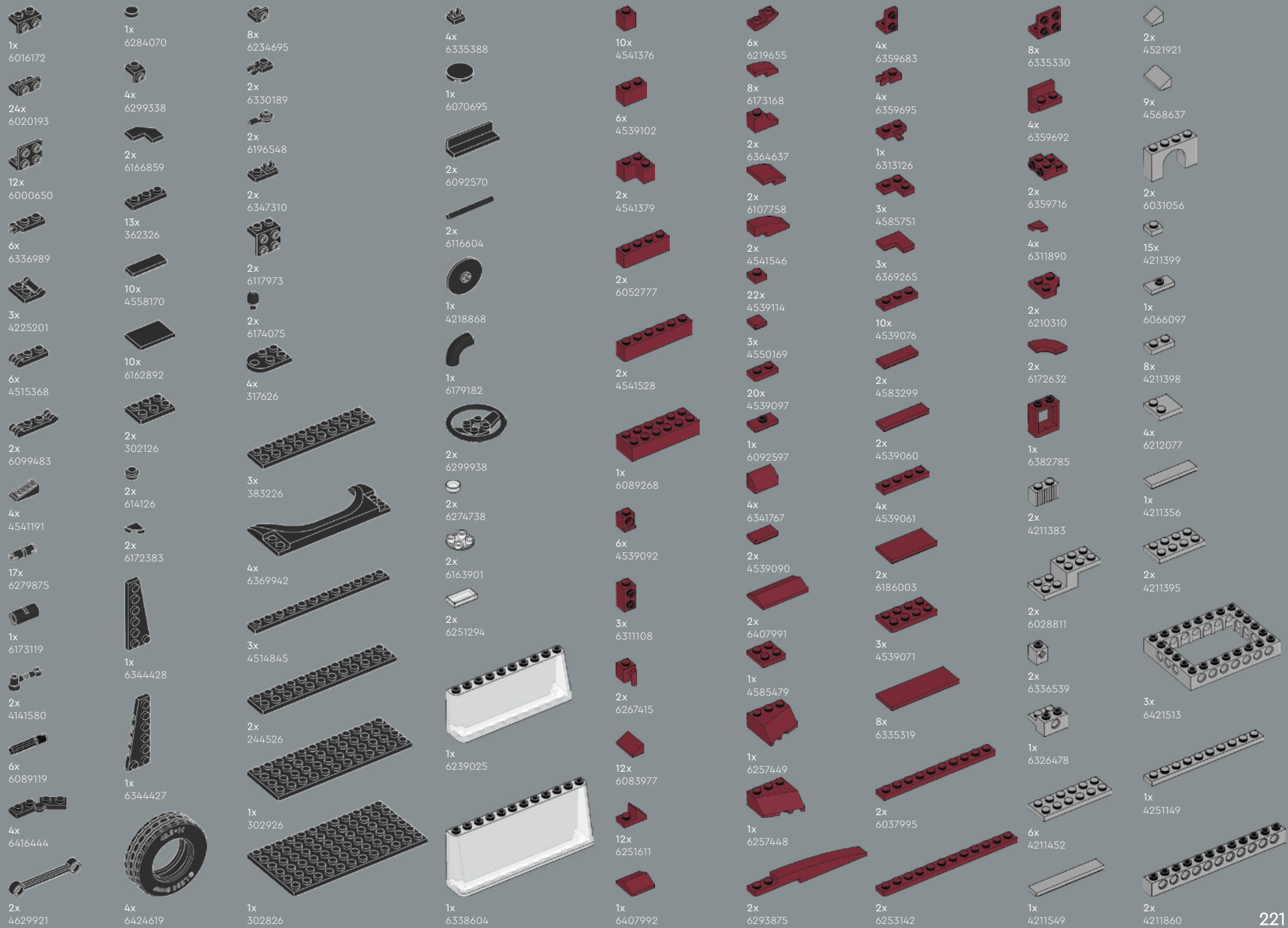

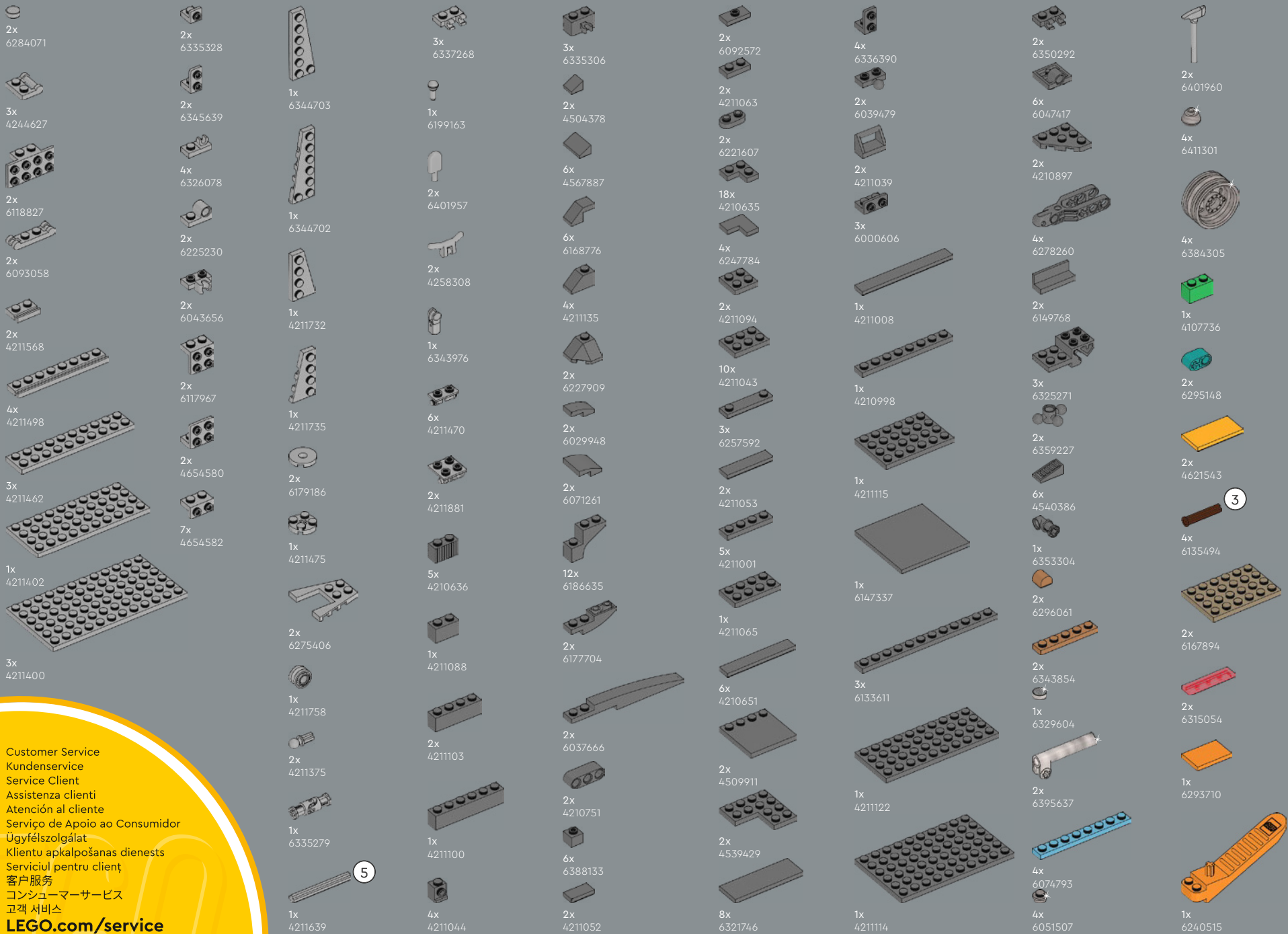

Customer Service  
 Kundenservice  
 Service Client  
 Assistenza clienti  
 Atención al cliente  
 Serviço de Apoio ao Consumidor  
 Ügyfélszolgálat  
 Klientu apkalpošanas dienests  
 Serviciul pentru clienț  
 客户服务  
 コンシューマーサービス  
 고객 서비스  
**LEGO.com/service**

5

3



# FEEDBACK AND WIN



## FEEDBACK AND WIN

Your feedback will help shape the future development of this product series.

Please visit:

## FEEDBACK UND GEWINNEN

Dein Feedback trägt zur Weiterentwicklung dieser Produktreihe bei.

Geh auf:

## COMMENTEZ ET GAGNEZ

Vos commentaires nous aideront à concevoir les futurs produits de cette gamme.

Rendez-vous sur :

## COMENTA Y GANA

Tu opinión nos ayudará a dar forma al desarrollo de esta serie de productos en el futuro.

Visita:

## 反馈有奖

您的反馈将有助于我们在今后改进本系列产品。

请访问：

[LEGO.com/productfeedback](https://www.lego.com/productfeedback)

By completing, you will automatically enter a drawing to win a LEGO® set.

Terms & Conditions apply.

Durch Ausfüllen nimmst du automatisch an der Verlosung eines LEGO® Preises teil.

Es gelten die Teilnahmebedingungen.

En envoyant vos commentaires, vous serez automatiquement inscrit(e) à un tirage au sort qui vous permettra de remporter un prix LEGO®.

Offre soumise à conditions.

Al contestar, participarás automáticamente en el sorteo y podrás ganar un set LEGO®.

Sujeto a Términos y Condiciones.

完成我们的反馈调查，即可自动进入抽奖环节，赢取乐高®套装。

适用《条款和条件》。



LEGO and the LEGO logo are trademarks of the LEGO Group. ©2022 The LEGO Group.

General Motors trademarks used under license to the LEGO Group.