

Book 2

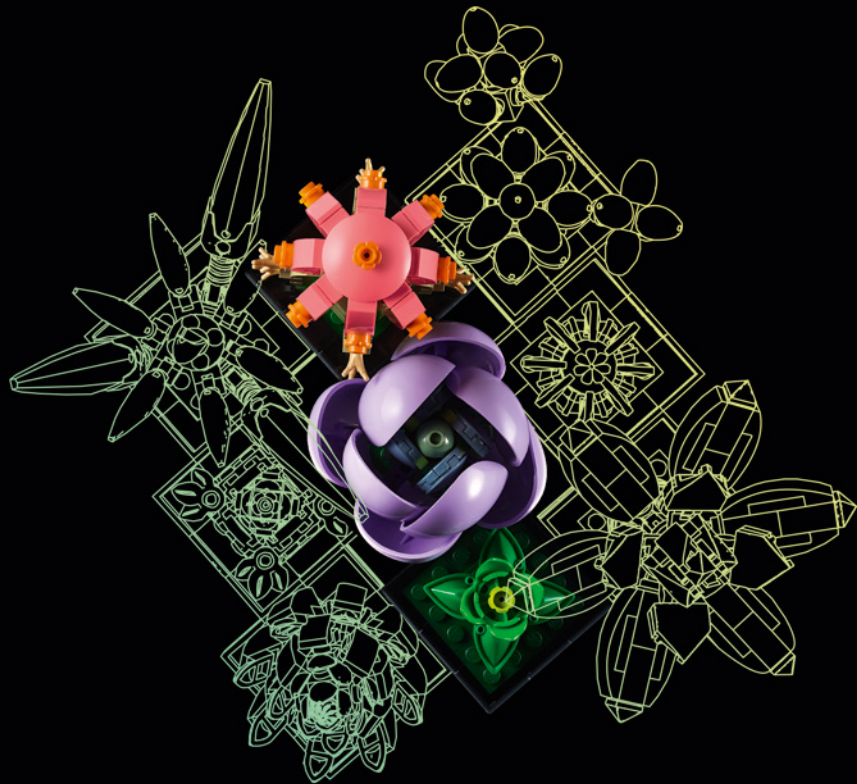

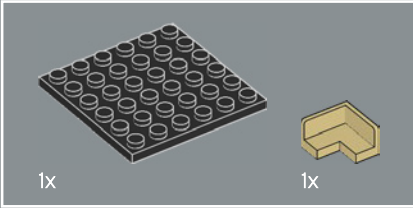

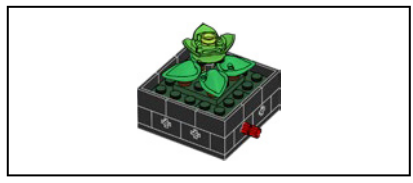

1

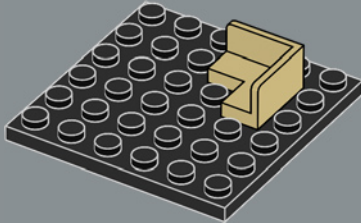

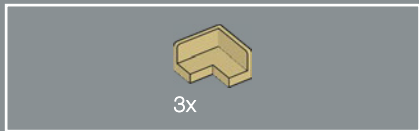

2

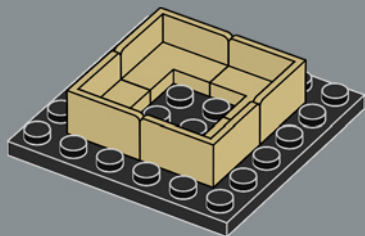

4

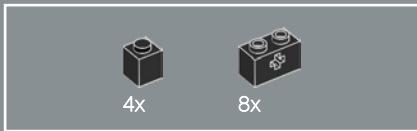

3

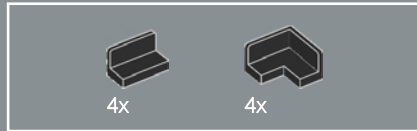
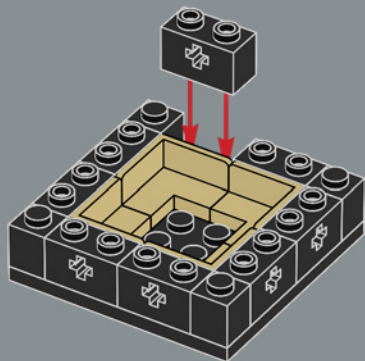

4

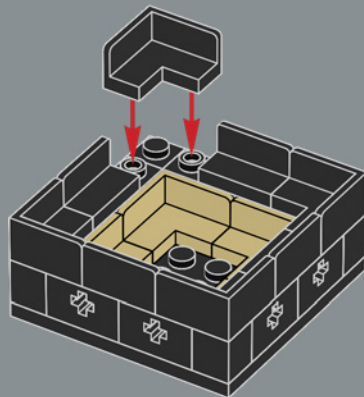

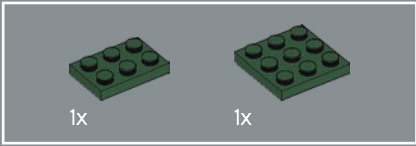

5

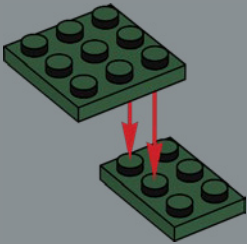

6

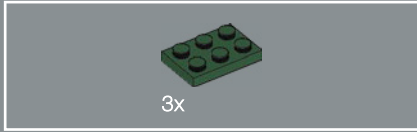

6

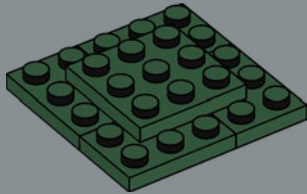

7

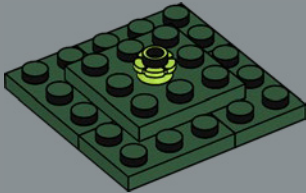



8

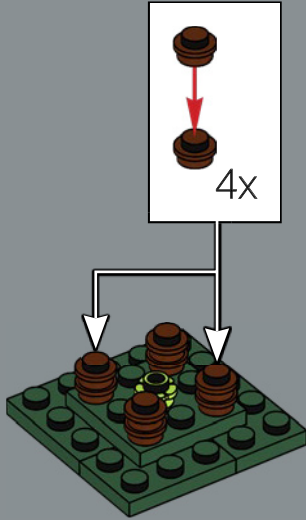

9

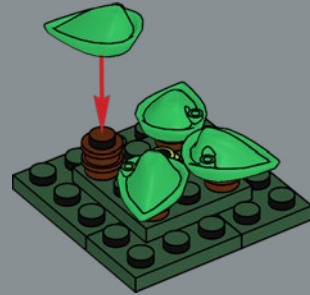



10

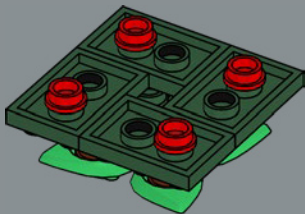

11

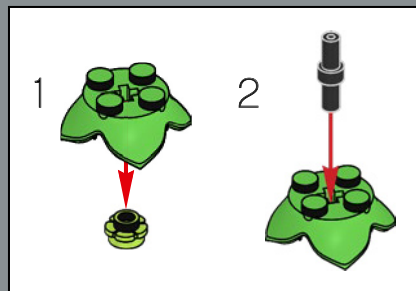

12

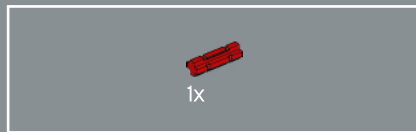
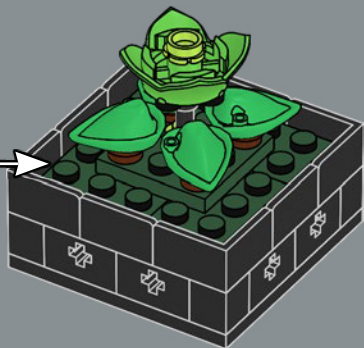

13

Existen cerca de 10.000 tipos de suculentas que puedes cultivar. Las divertidas Suculentas LEGO® son una excelente forma de empezar tu colección.

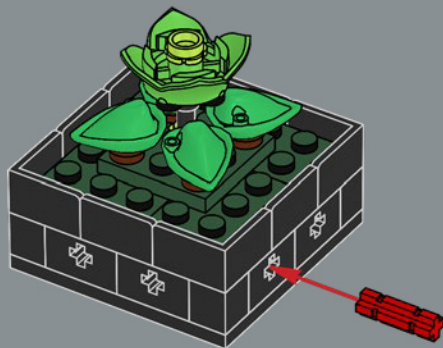

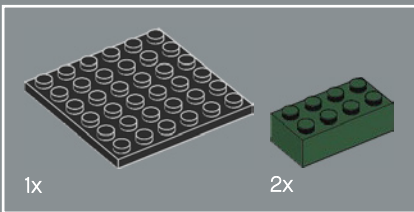
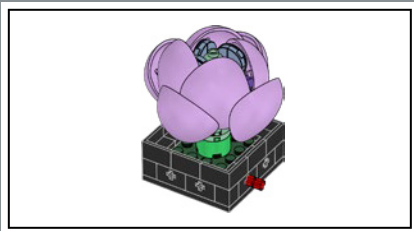

1

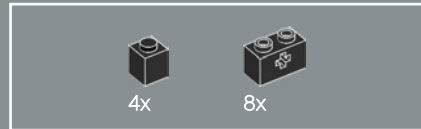
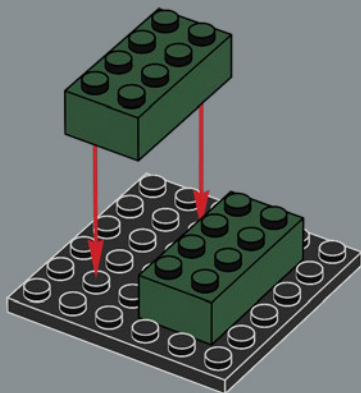

2

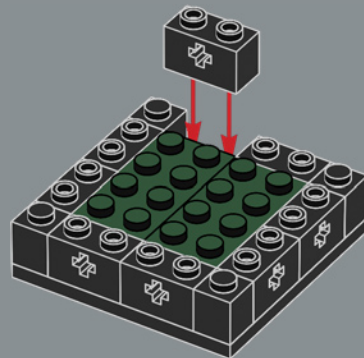

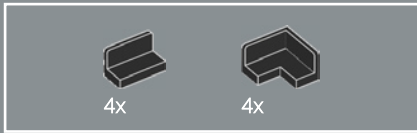

3

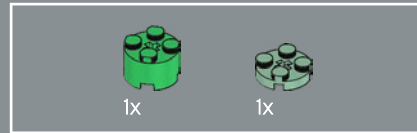
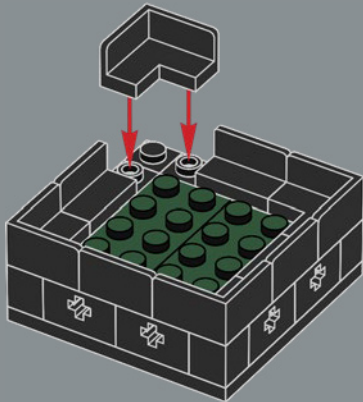

4

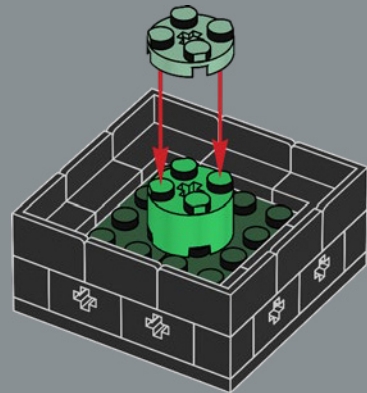

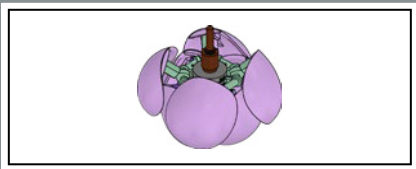

5

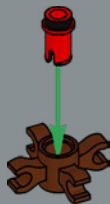

12

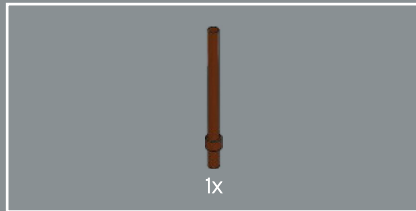

6

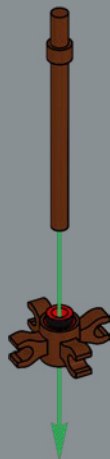

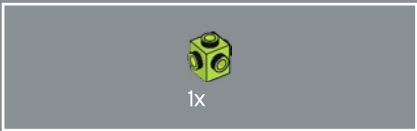

7

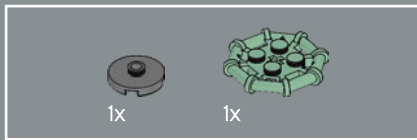

8

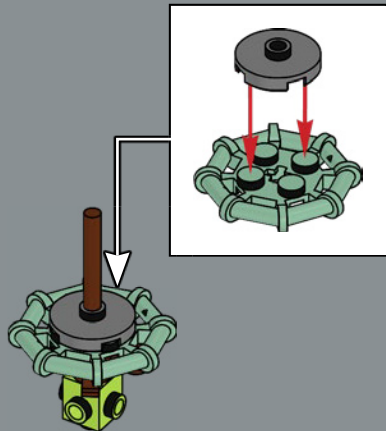



9

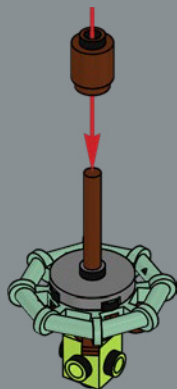

10

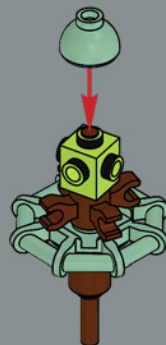



11

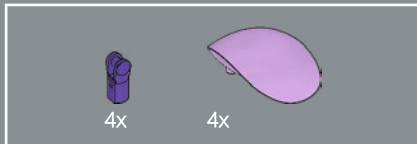
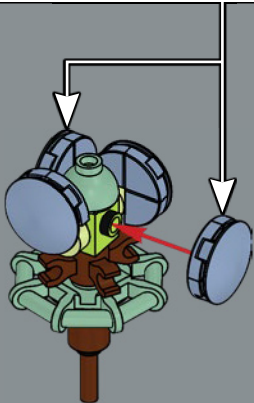
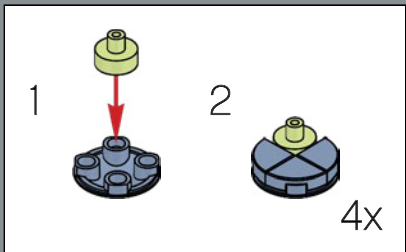

12

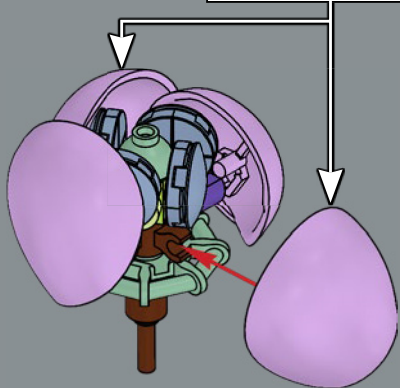
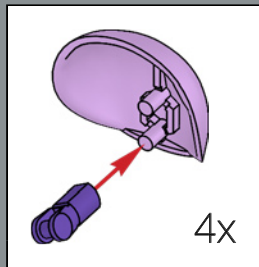

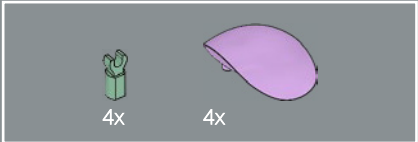

13

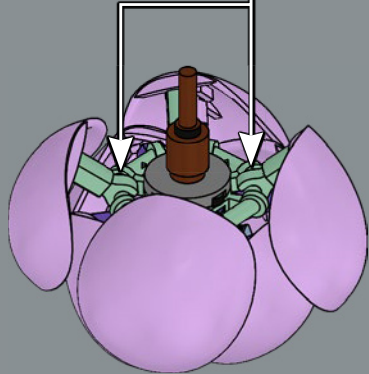
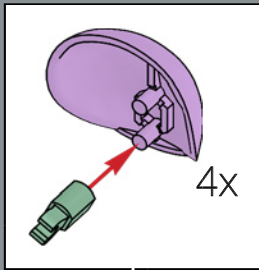

Echeveria lavanda
Las variedades lavanda de echeveria tienen nombres curiosos, como *resplandor crepuscular* y *escarcha cúbica*. ¿Cómo llamarías a la tuya?

14

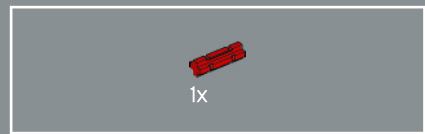
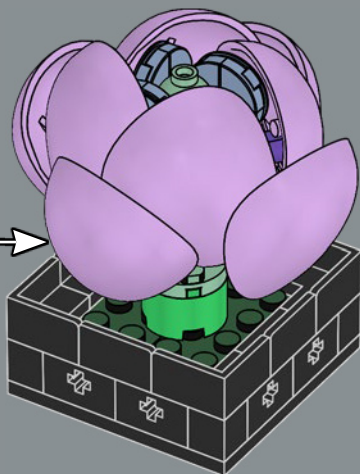

15

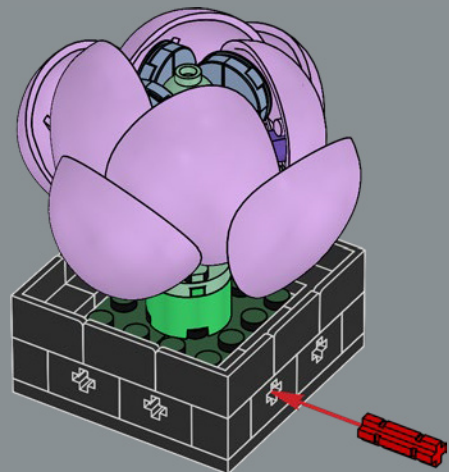

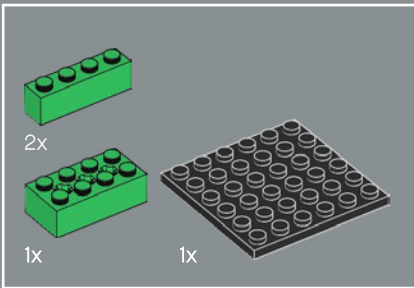
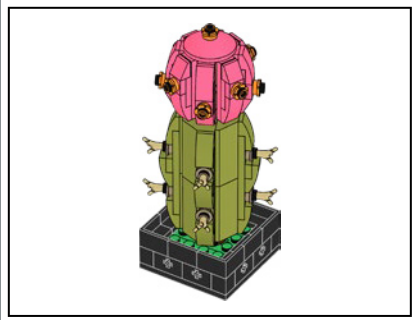

1

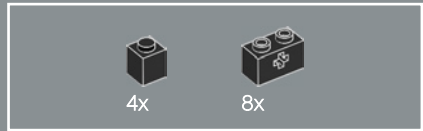
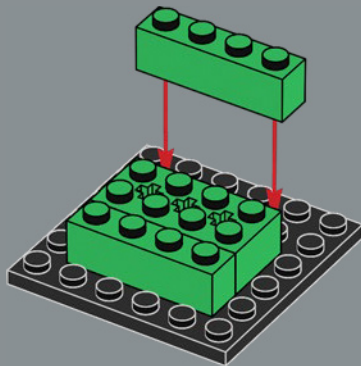

2

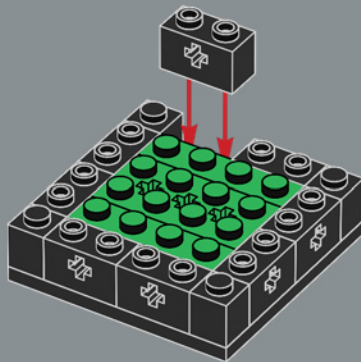

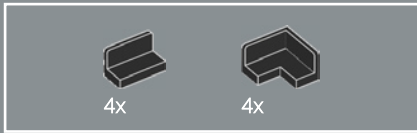

3

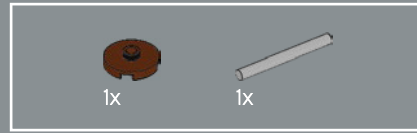
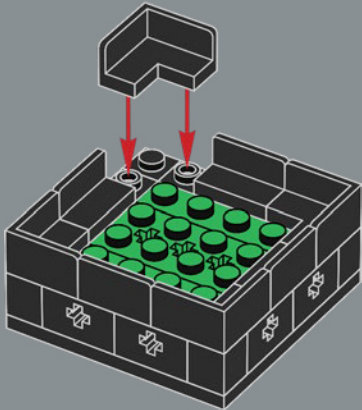

4

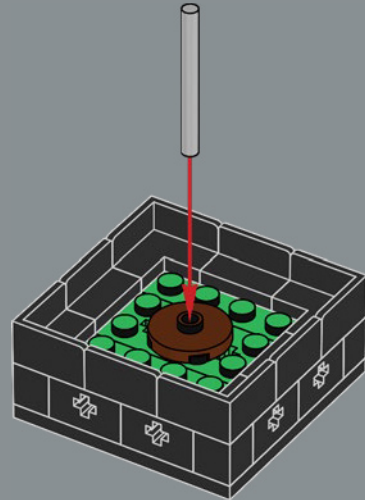

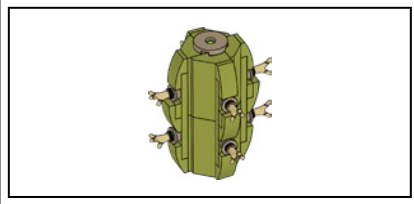

1x

1x

5

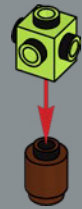

2x

6

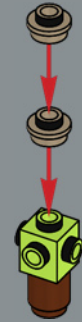



7



8



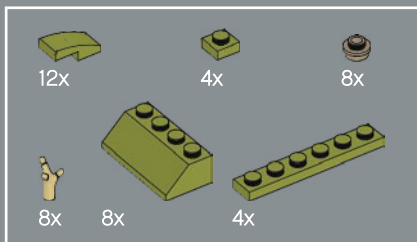
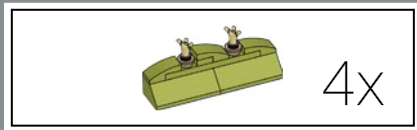

9

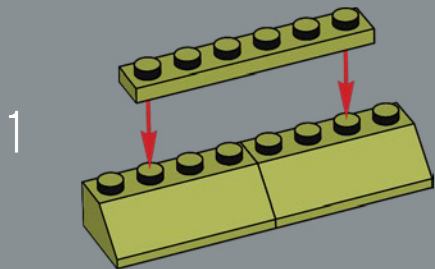

2

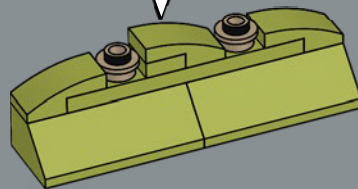

3

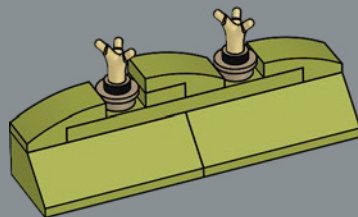

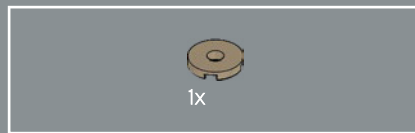
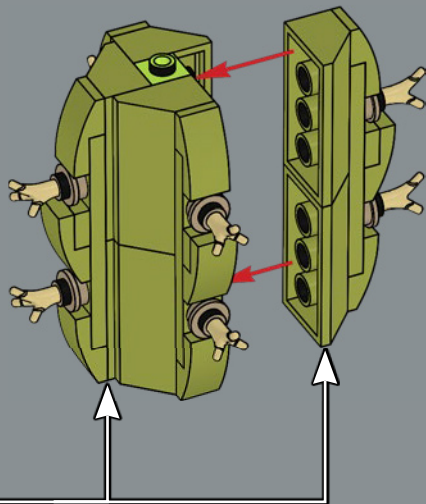

10

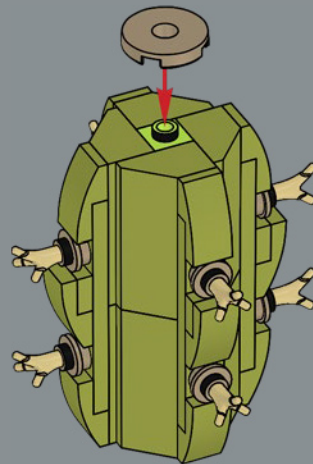

11

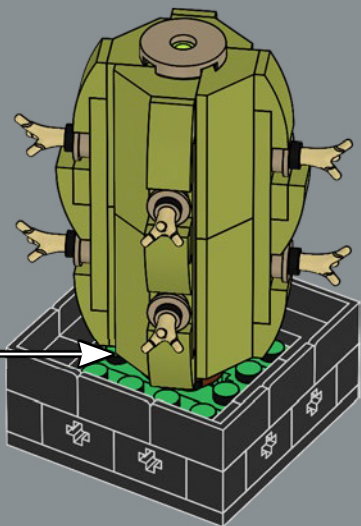

24

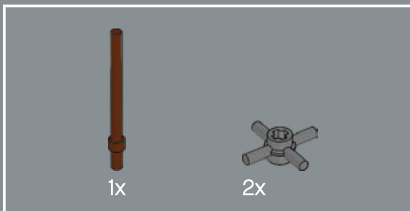
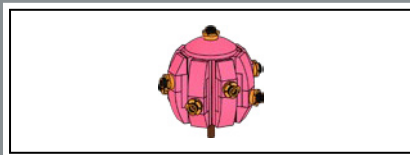

12

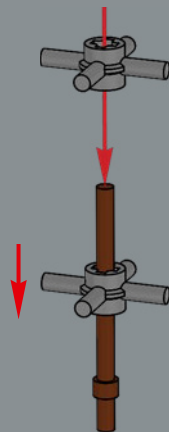



13

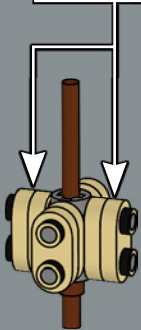
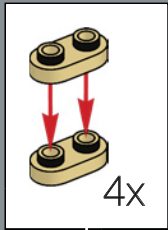

14

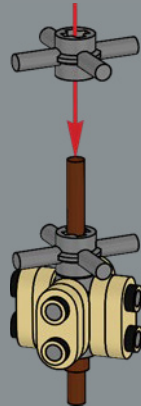

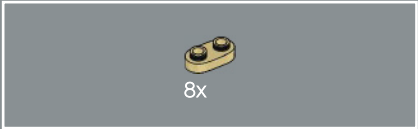

15

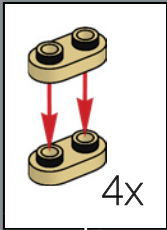

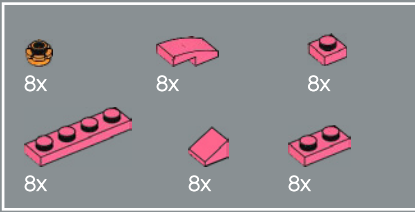

16

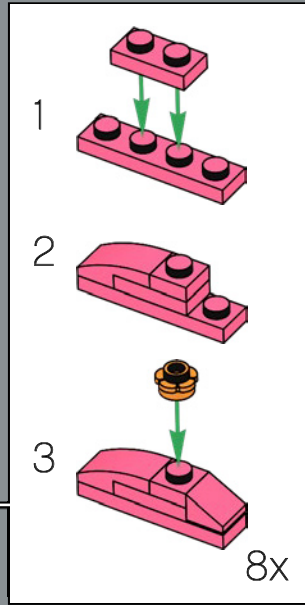
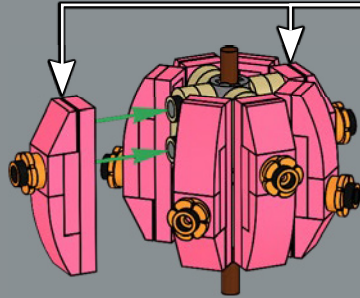



17

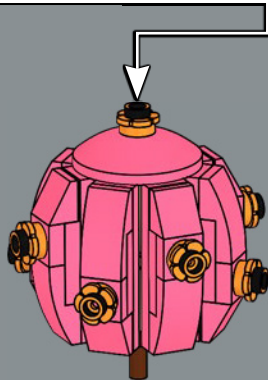
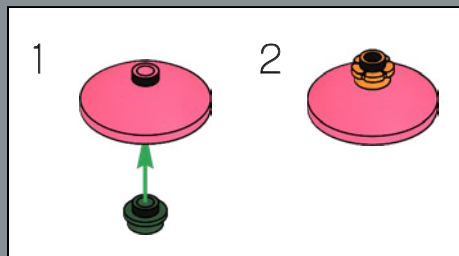

El cactus bola de rubí es de color rojo brillante debido a que no puede producir clorofila y, por tal motivo, es necesario injertarlo en otra cactácea para que sobreviva.

18

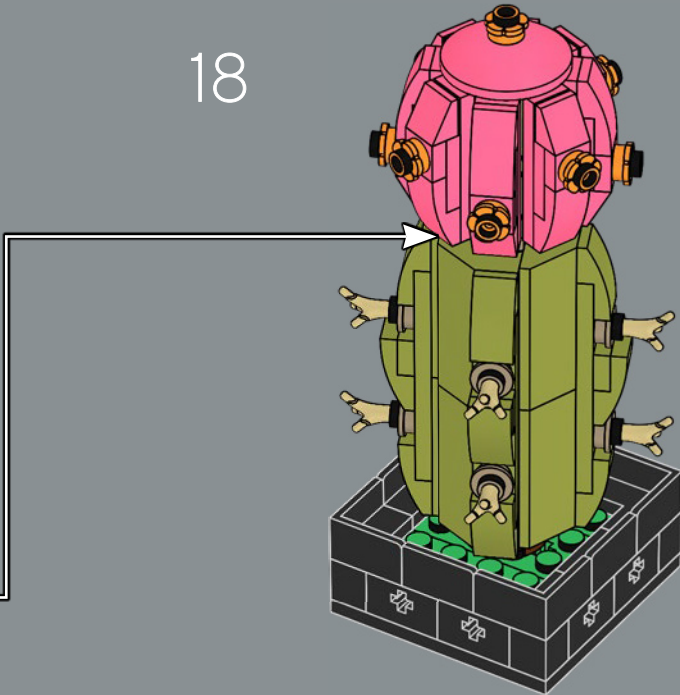

19

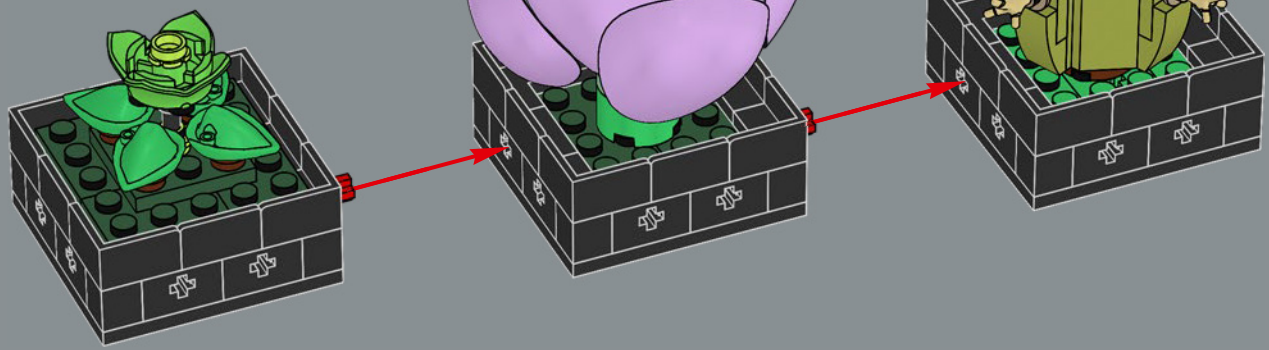



2x

20

