



Disney

10776



2



WARNING: CHOKING HAZARD.
Small parts. Not for children under 3 years.

Check for compatibility
Kompatibilität prüfen
Vérifier la compatibilité
Controlla la compatibilità
Comprueba tu compatibilidad
Verificar a compatibilidade
Ellenőrizd a kompatibilitást
Pārbaudīt saderību
检查兼容性

LEGO.com/devicecheck



乐高®拼搭指引



LEGO® Building Instructions



Download on the
App Store



GET IT ON
Google Play



腾讯应用宝
安卓应用商店



Apple and the Apple logo are trademarks of Apple Inc.
Google Play and the Google Play logo are trademarks of Google LLC.
Tencent and the Tencent logo are trademarks of Tencent Inc.



AVERTISSEMENT :

RISQUE D'ÉTOUFFEMENT.

Contient des petites pièces. Ne convient pas aux enfants de moins de 3 ans.



ADVERTENCIA:

PELIGRO DE ASFIXIA.

No recomendado para niños menores de 3 años. Contiene piezas pequeñas.



+

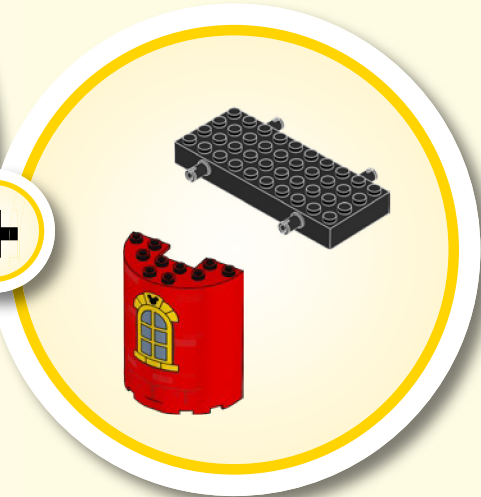

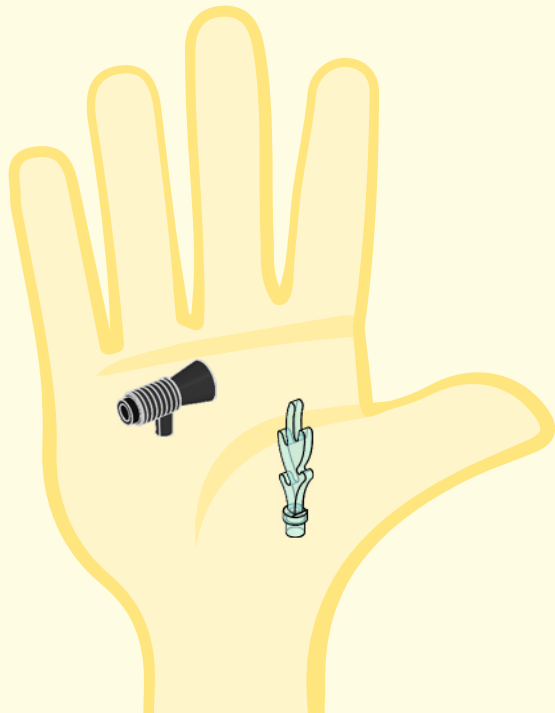

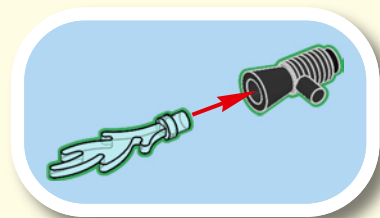
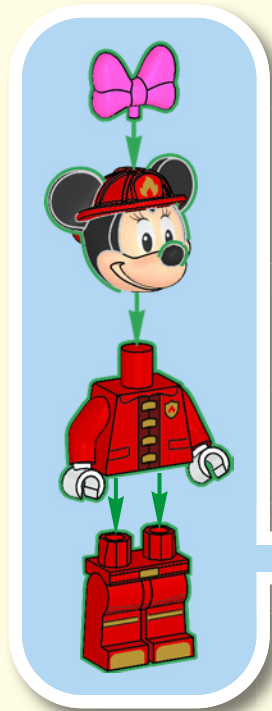

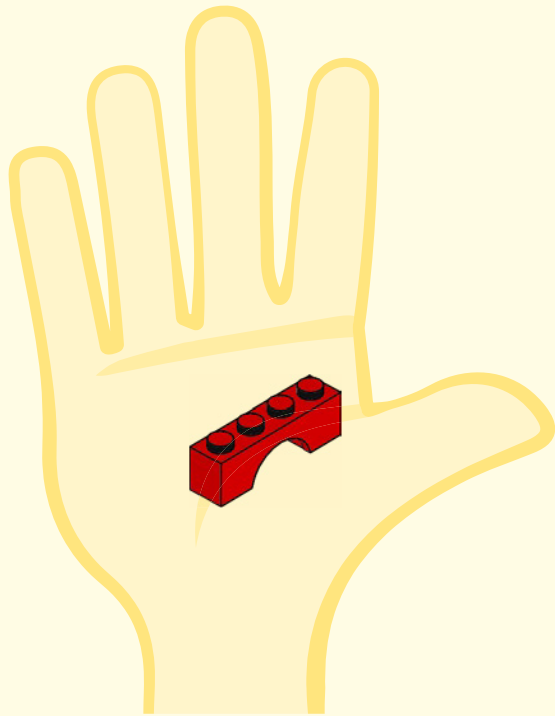
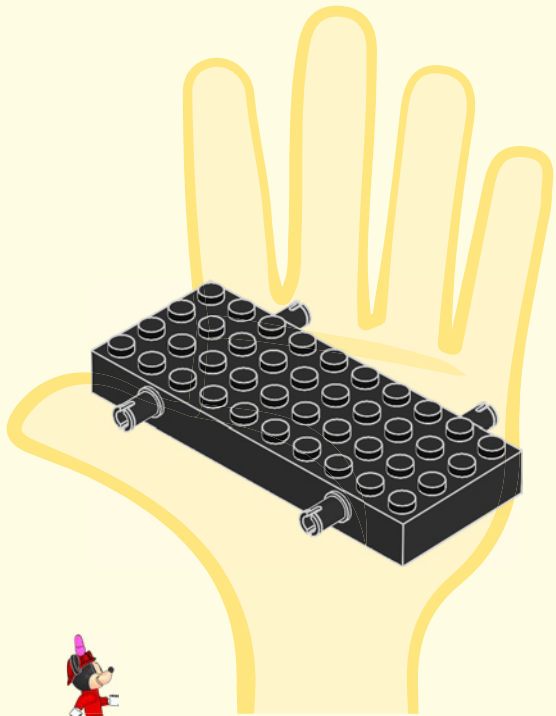

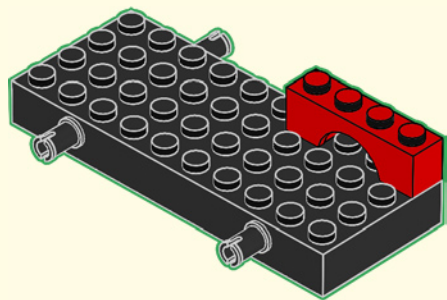

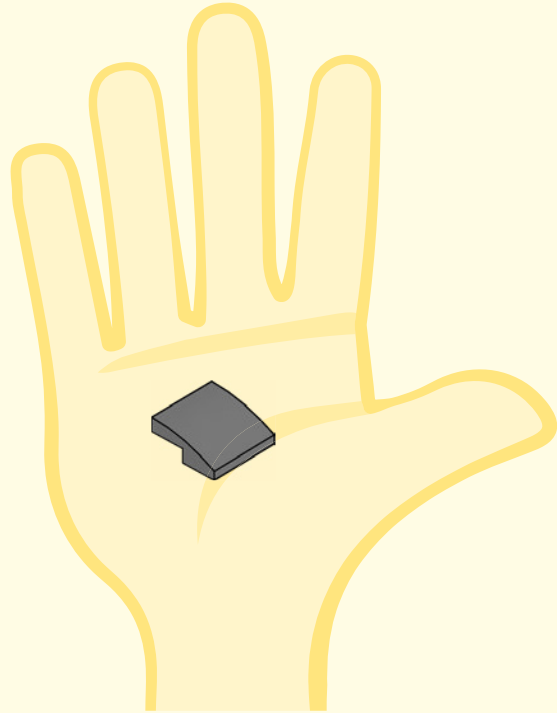
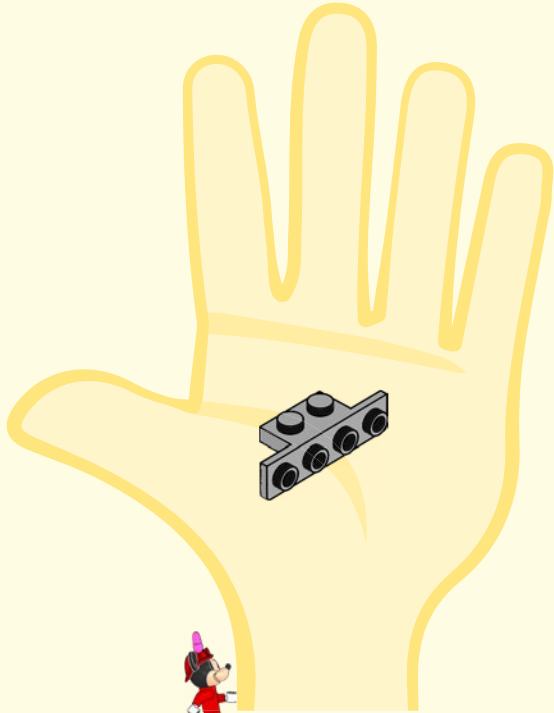

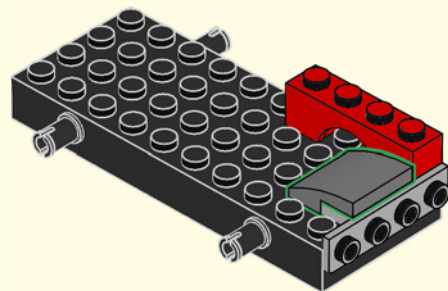
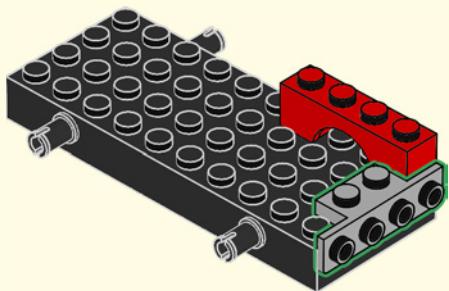

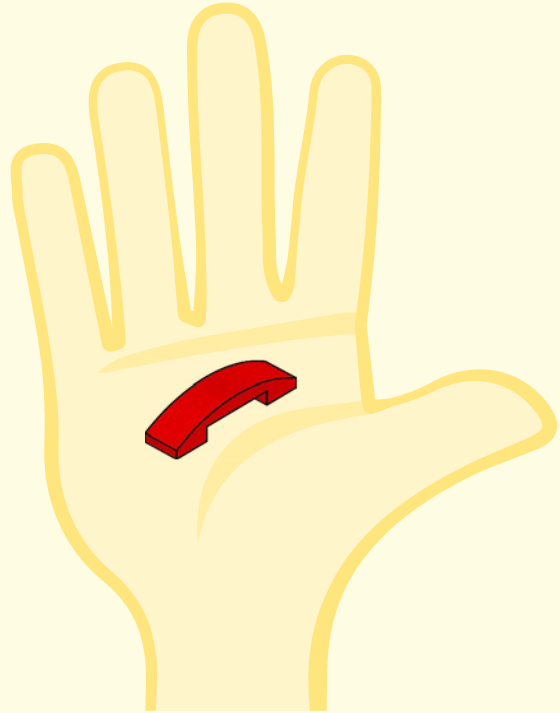
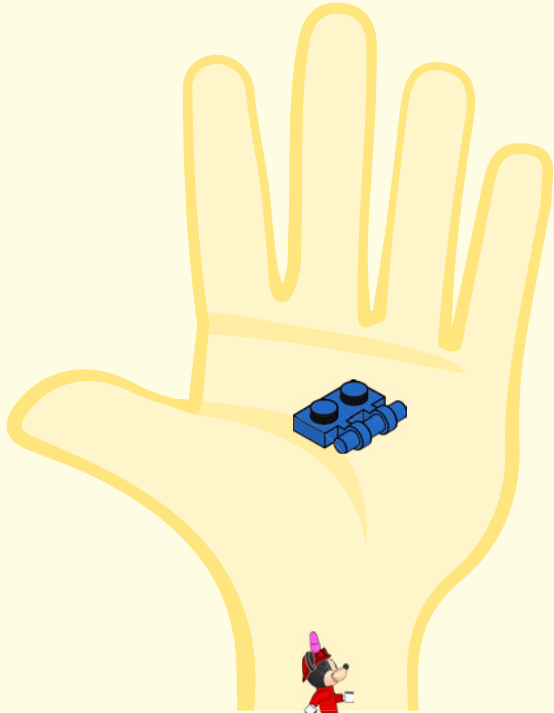

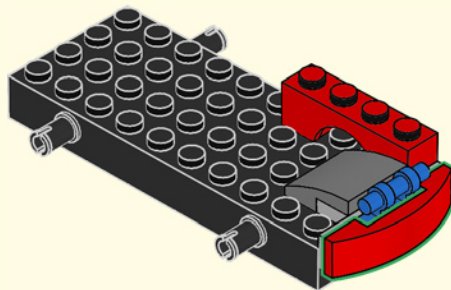
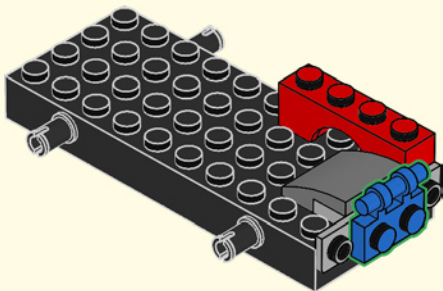

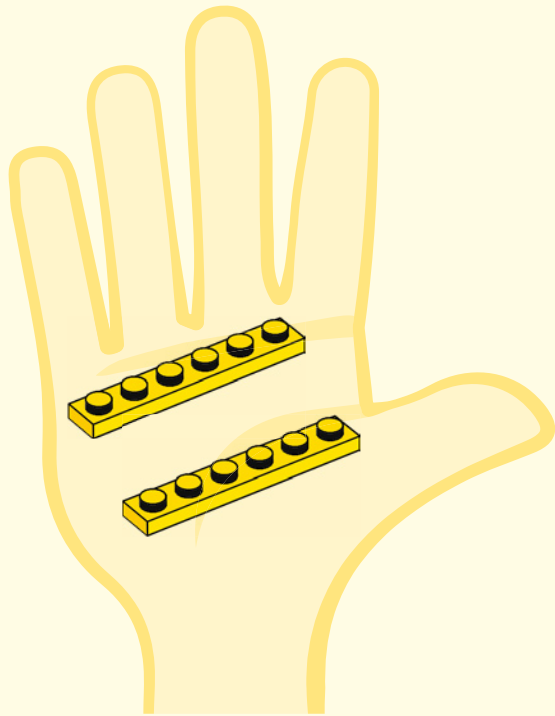
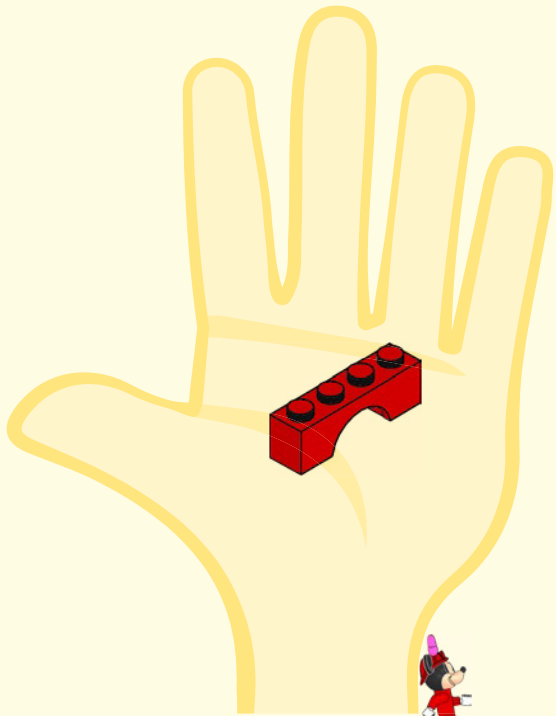

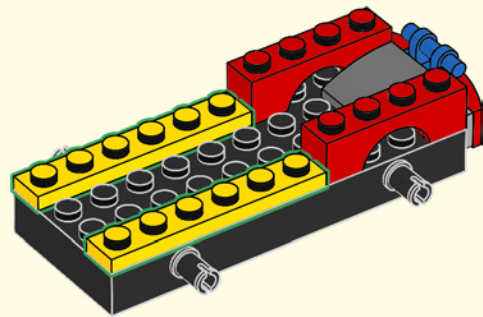
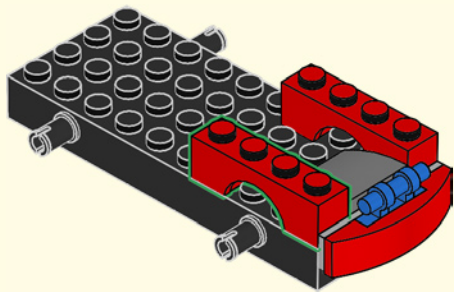

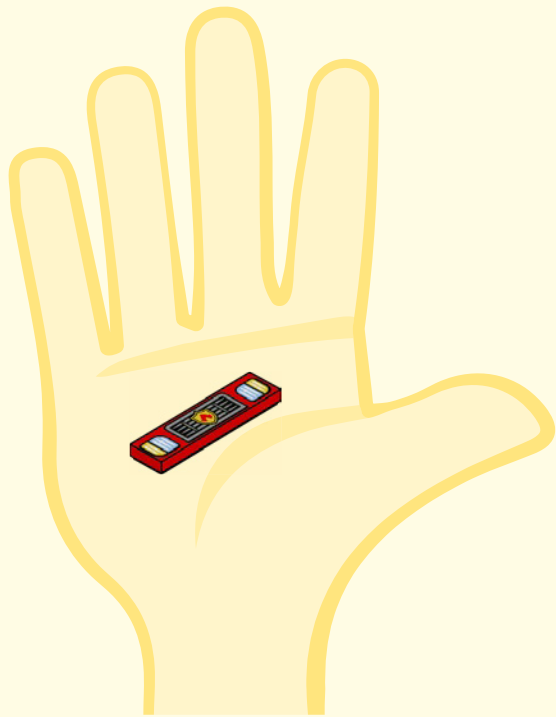
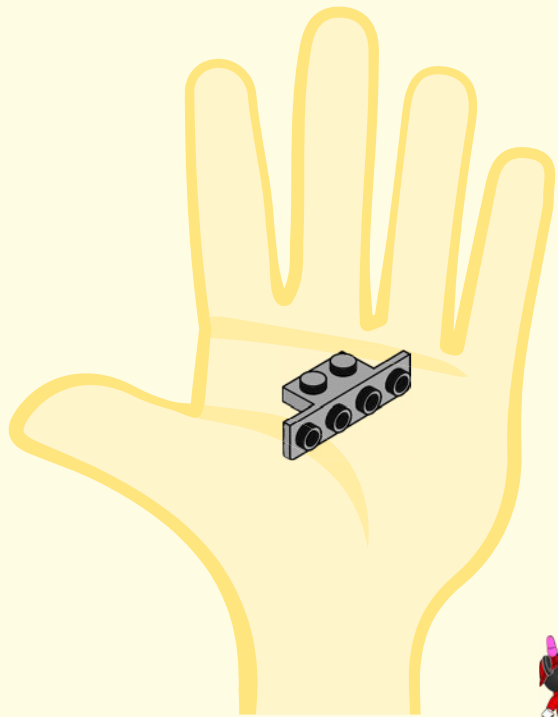

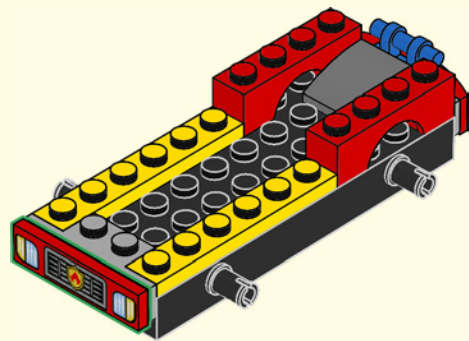
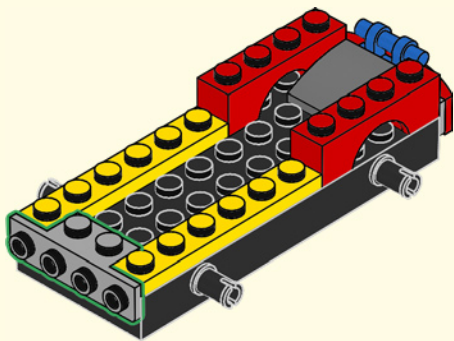

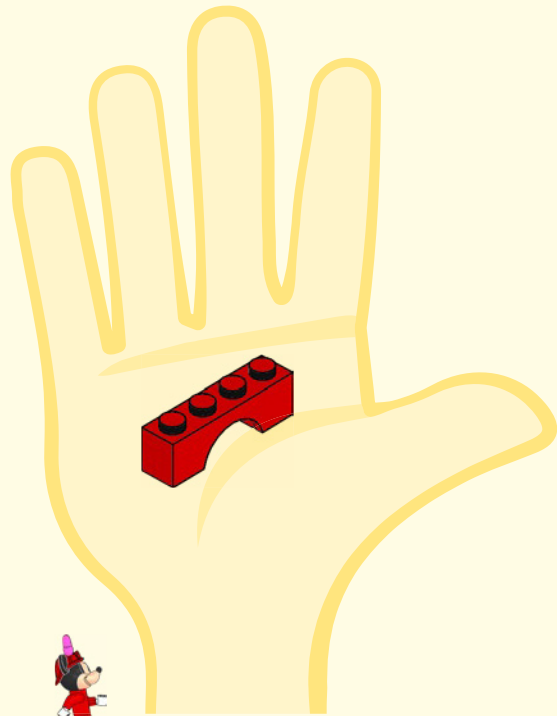
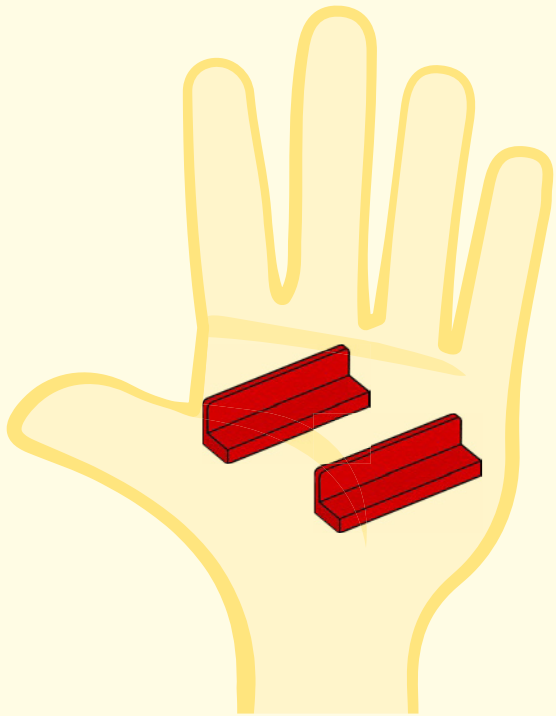

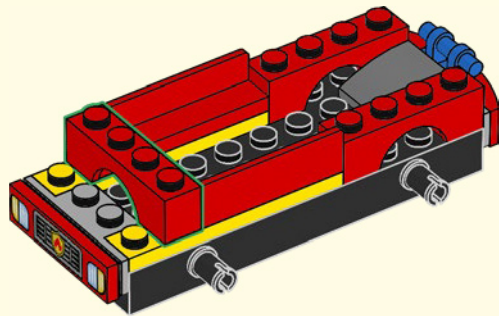
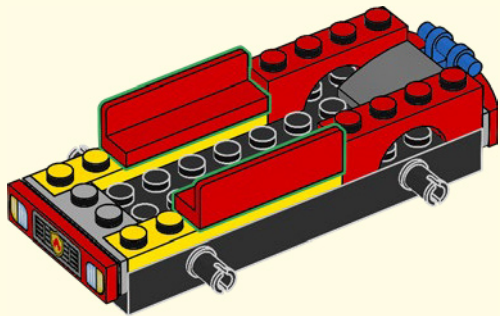

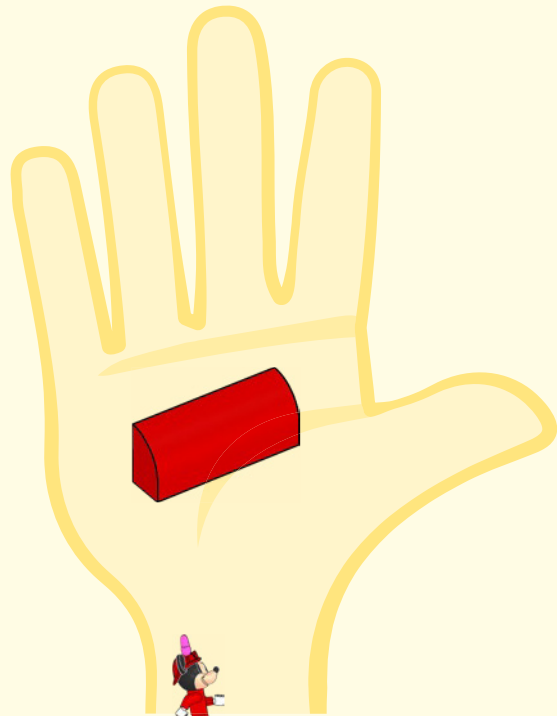

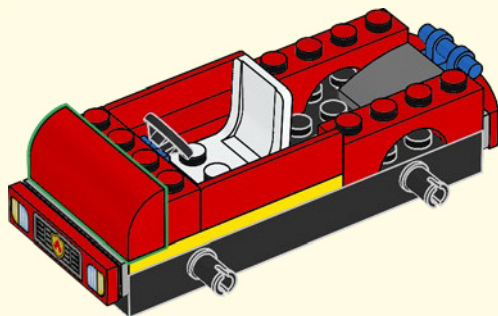
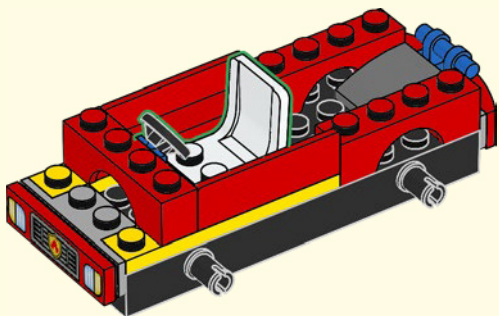
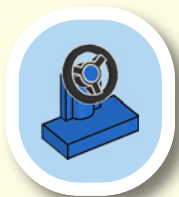

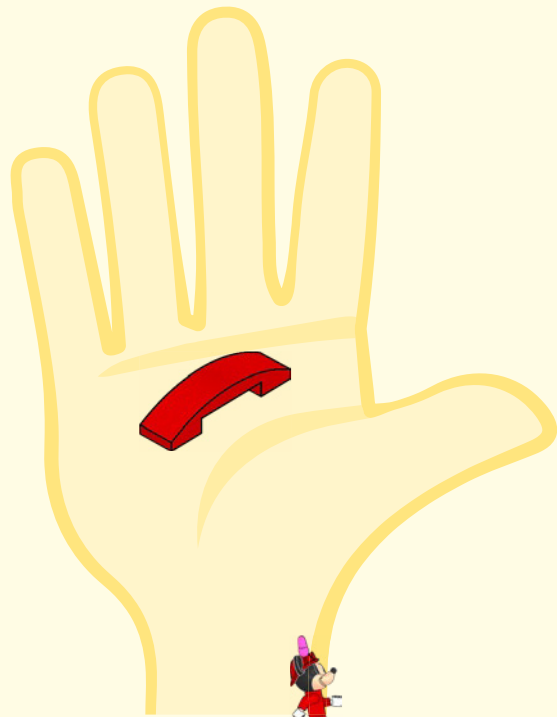
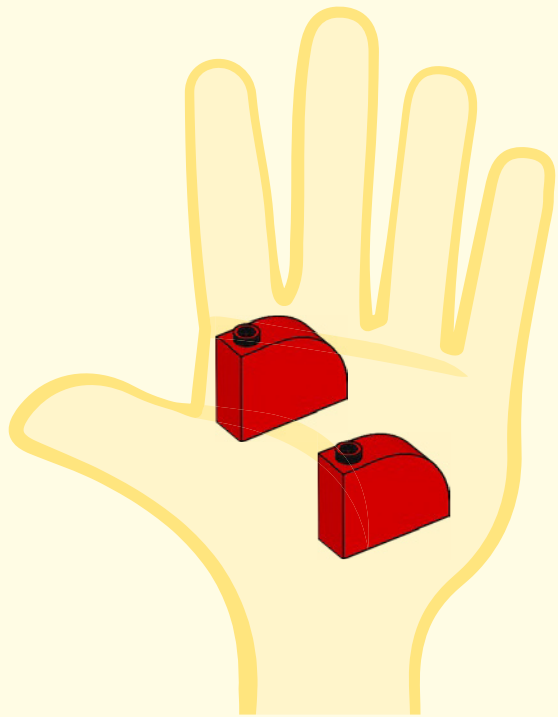

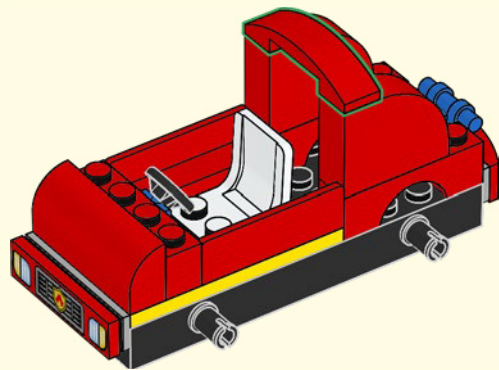
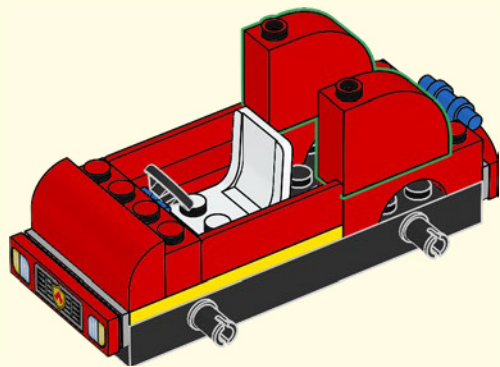

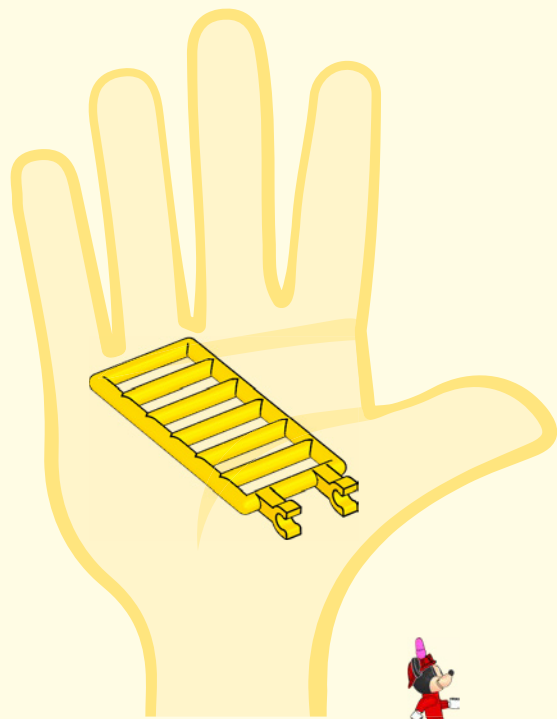

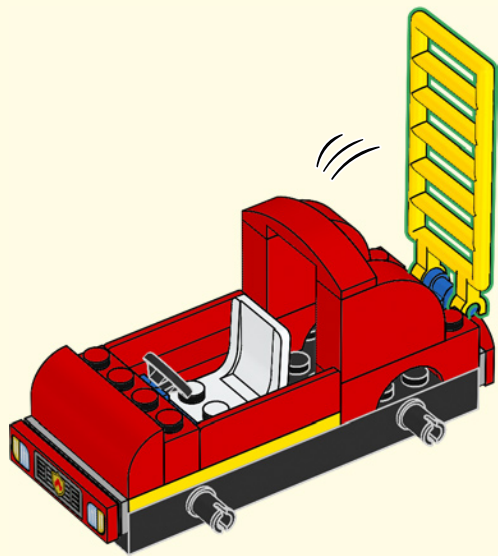

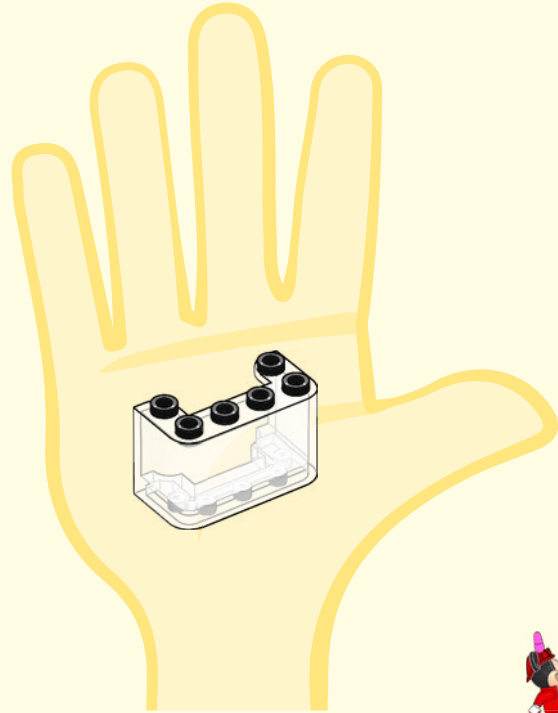

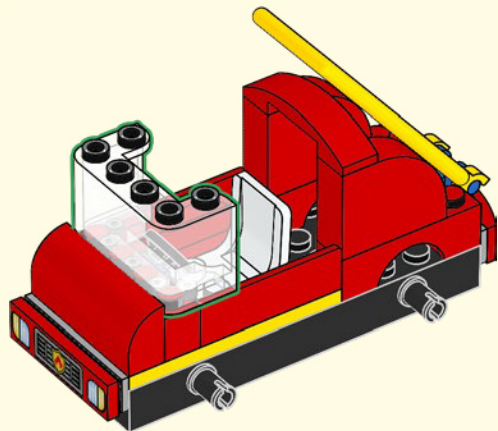

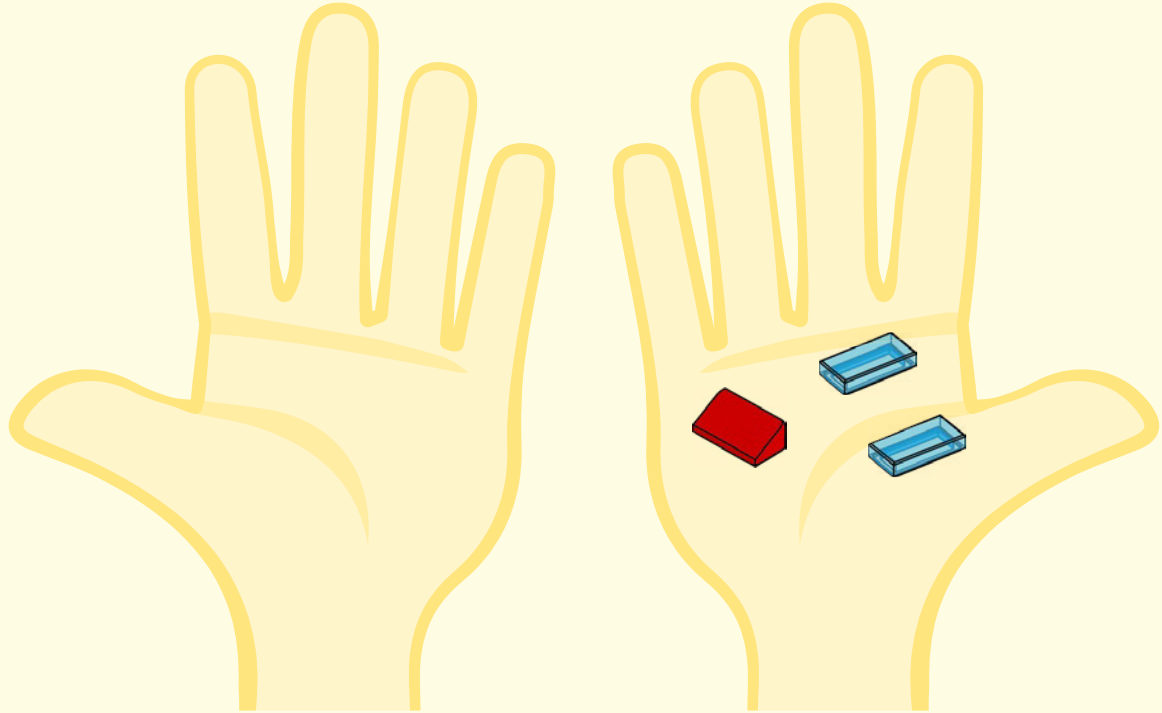

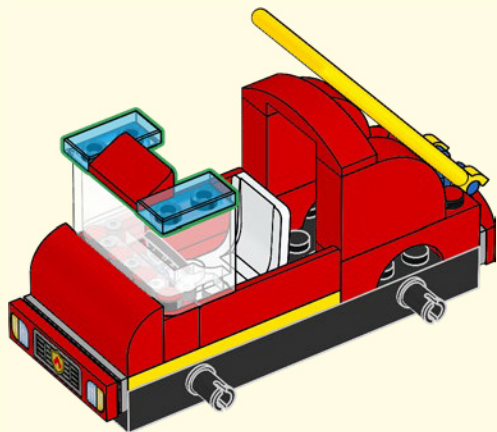

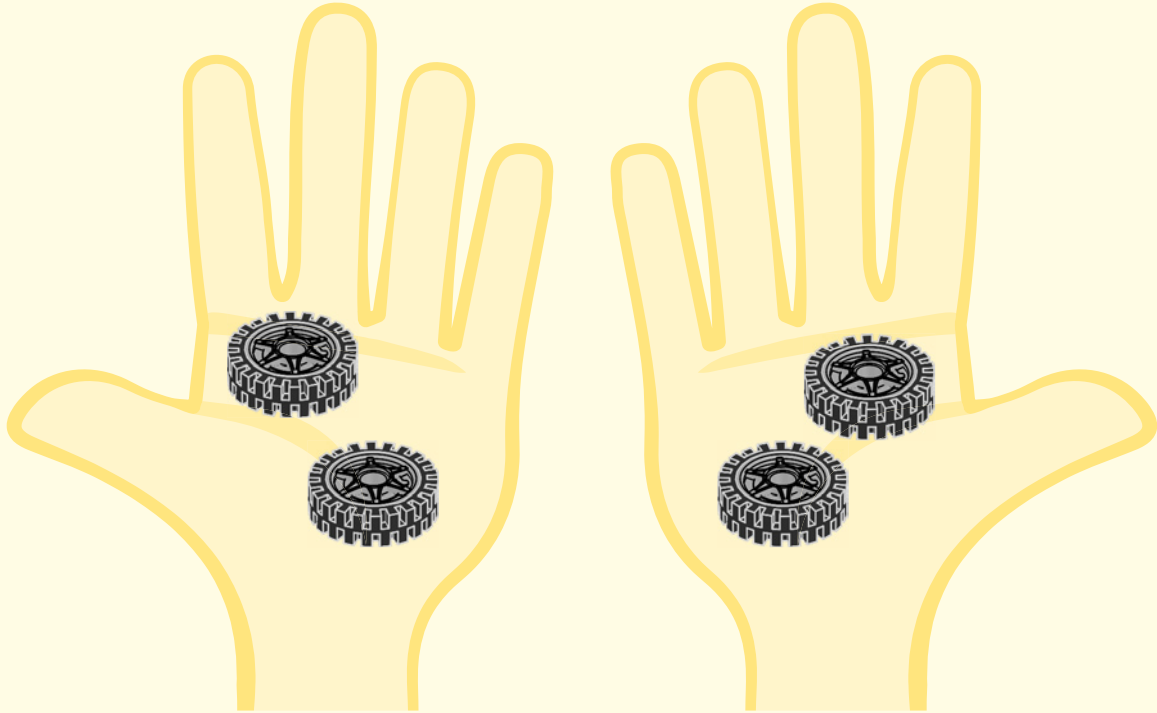

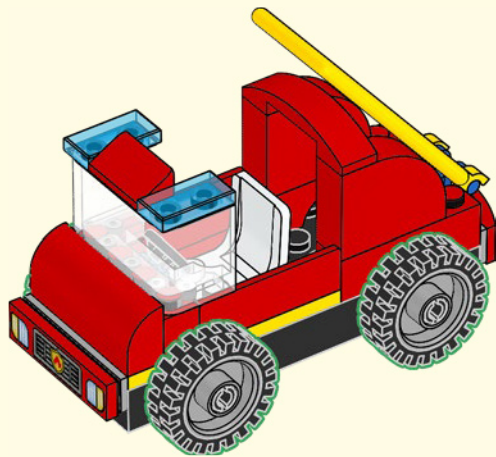

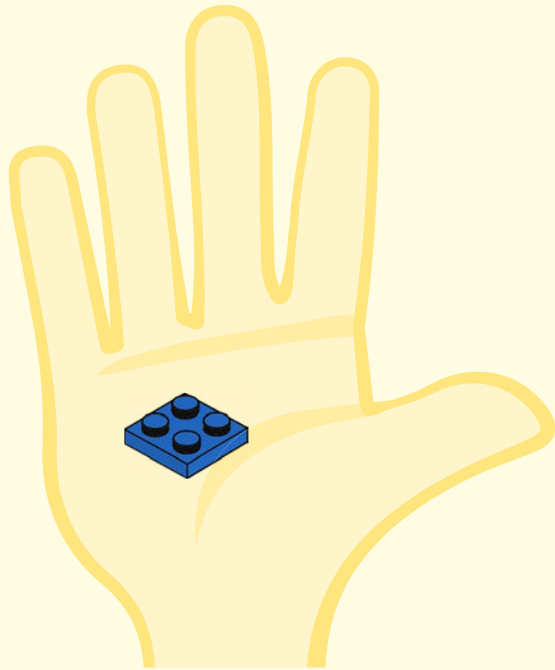

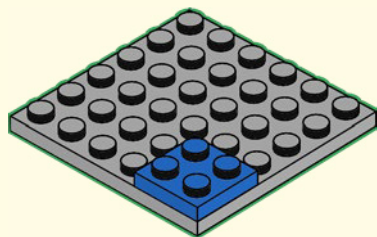

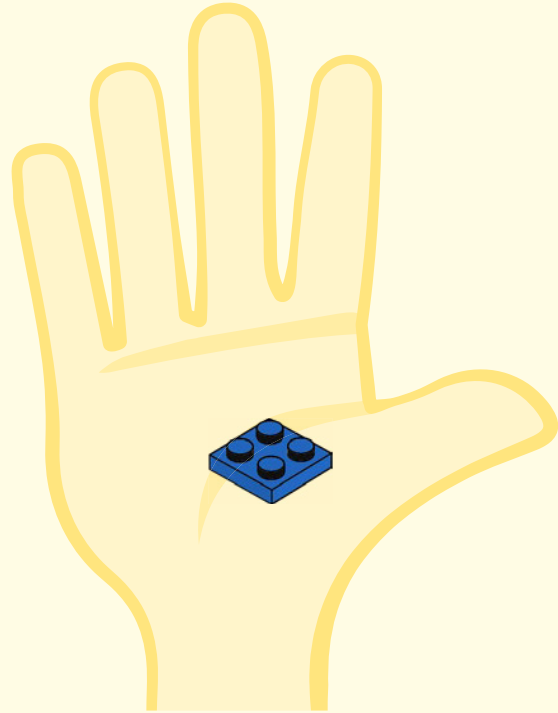
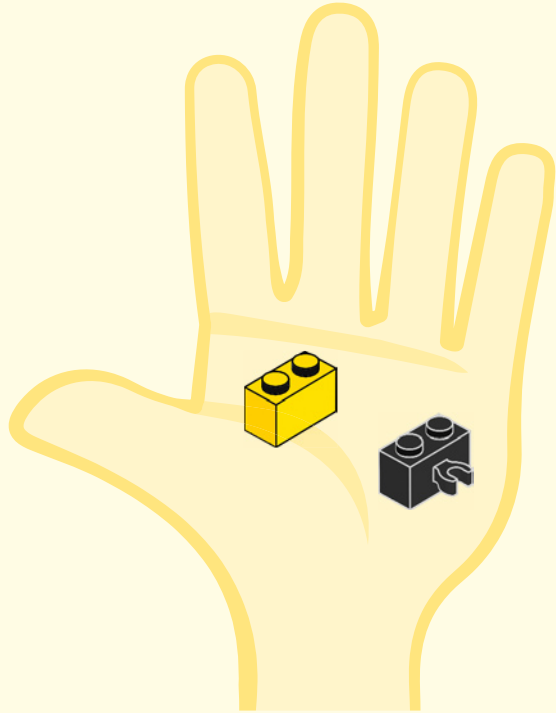

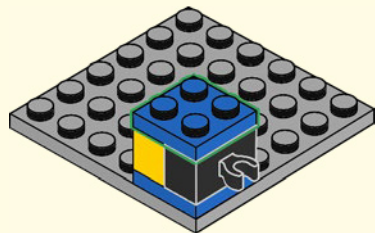
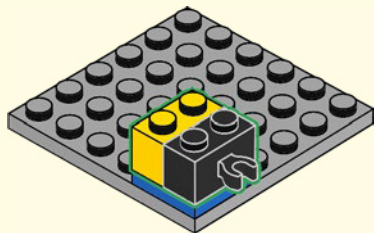

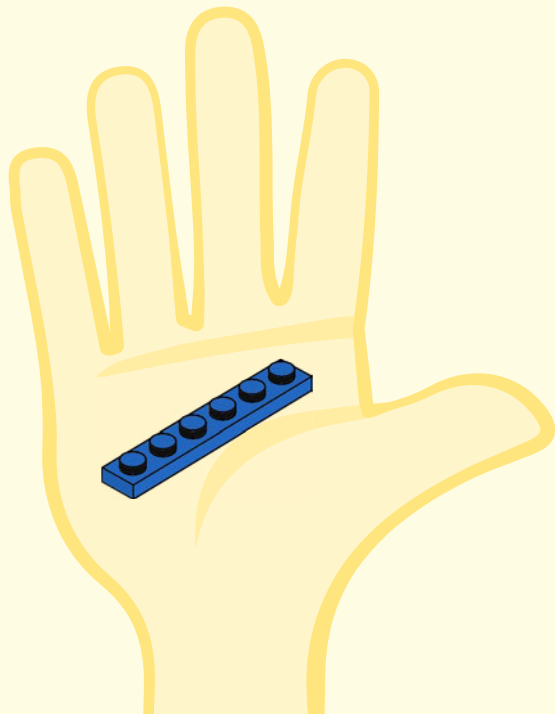
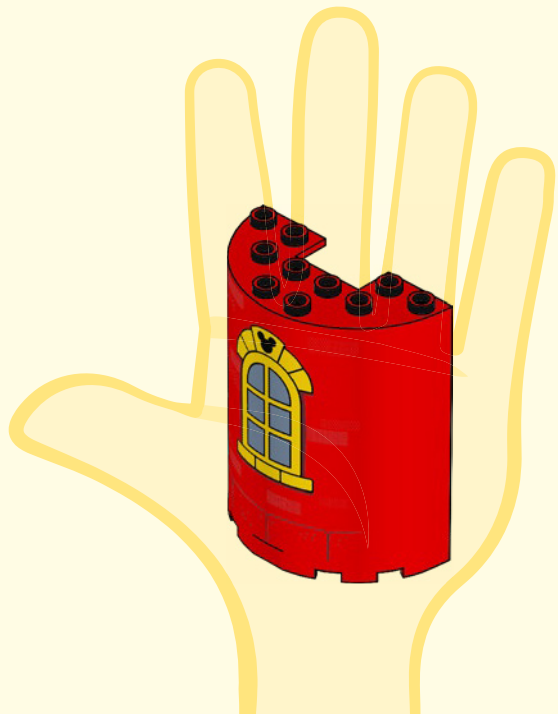

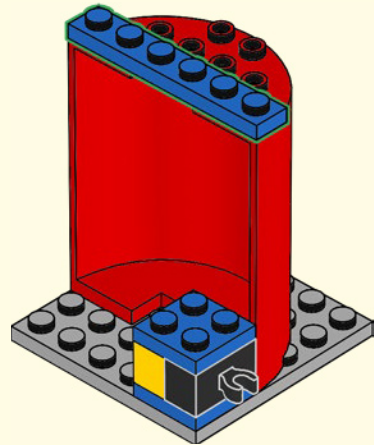
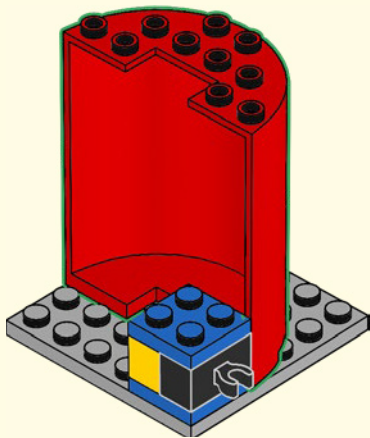

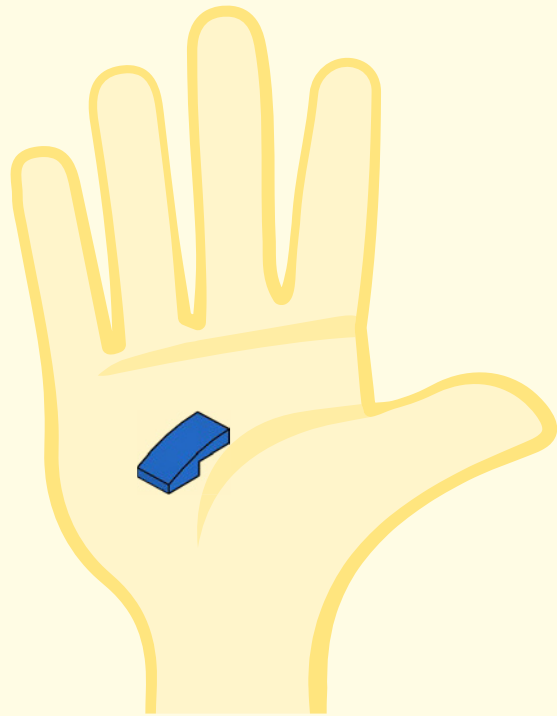
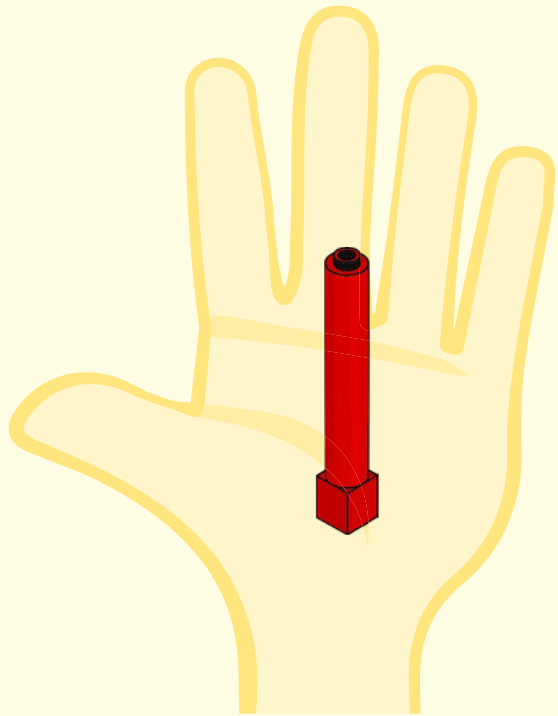

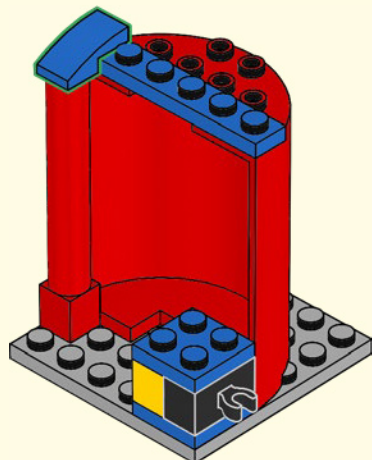
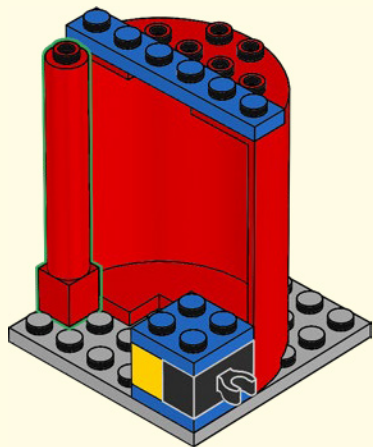

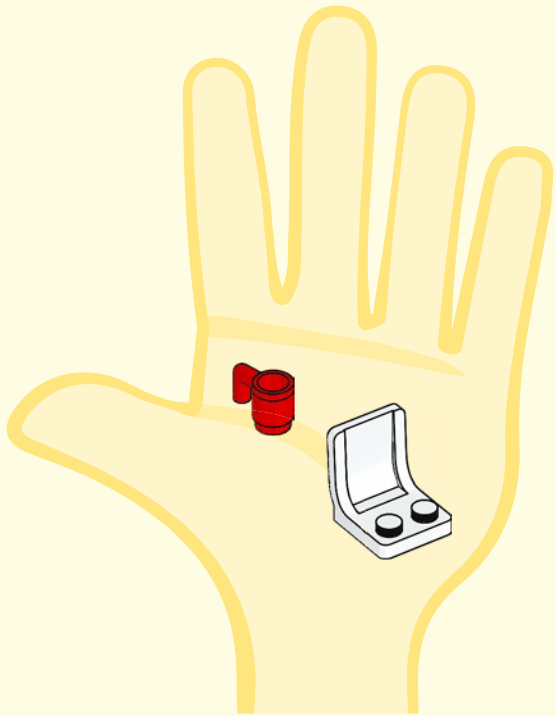

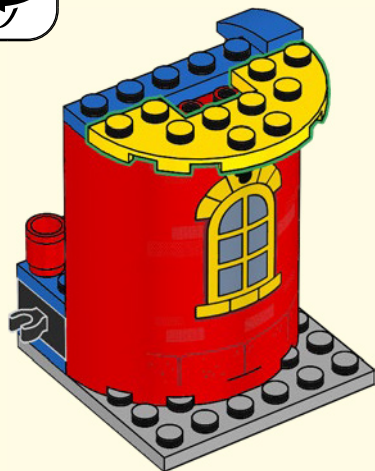
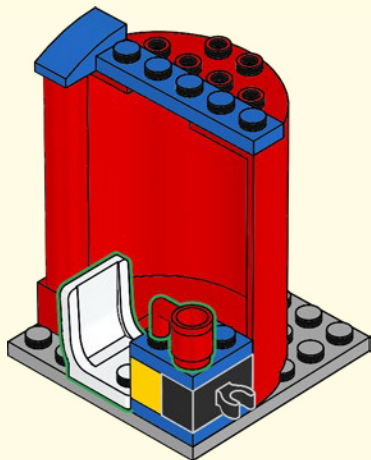

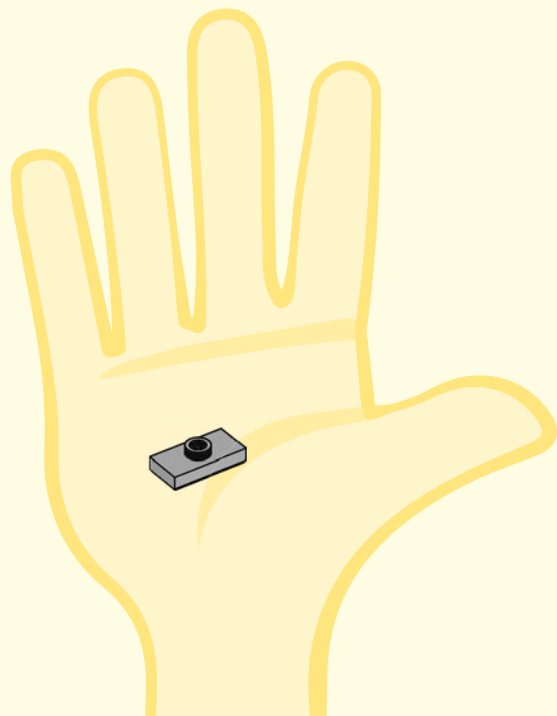
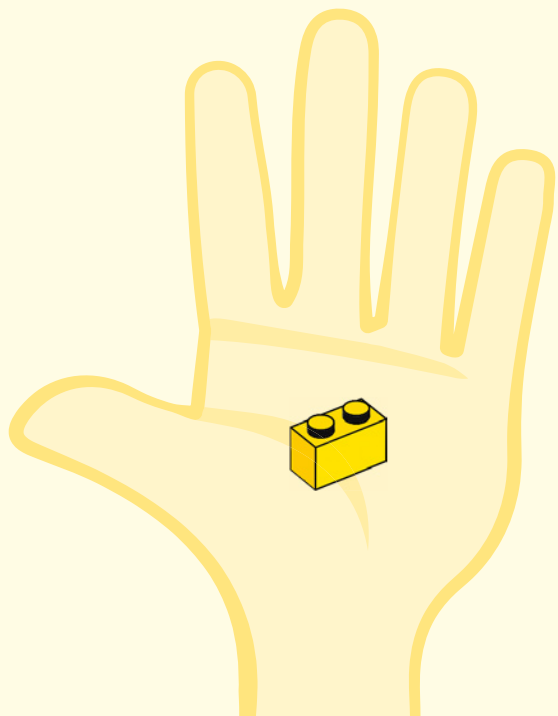

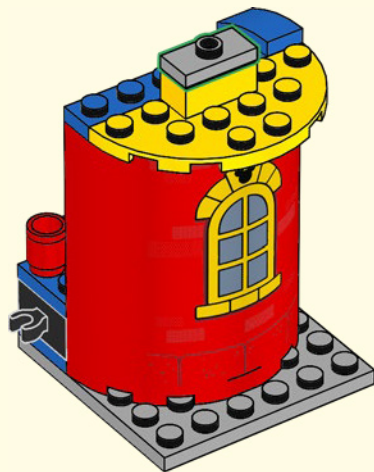
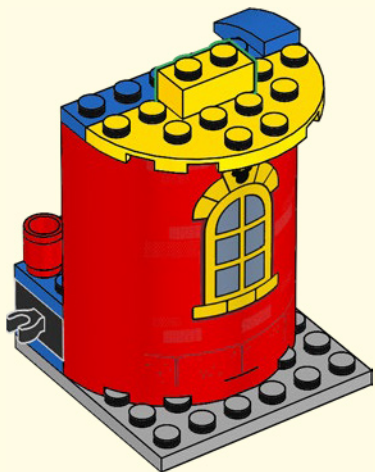

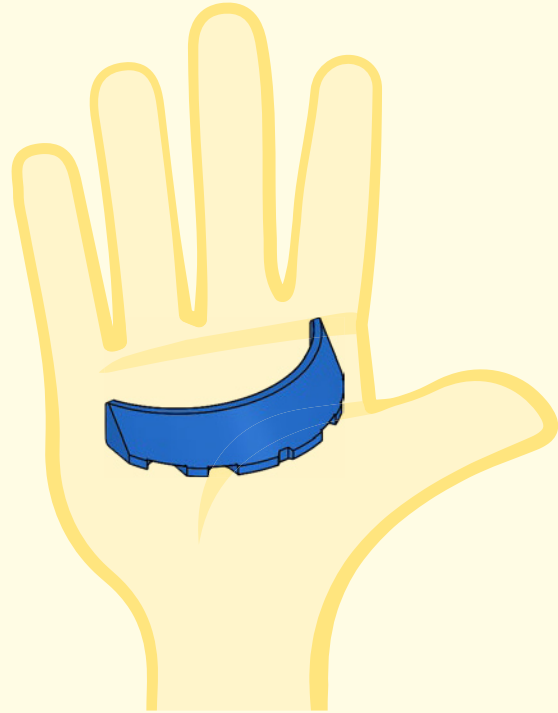

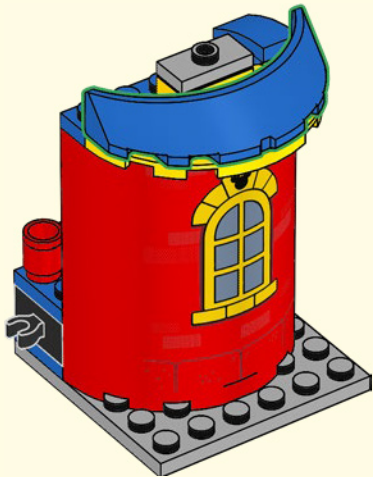

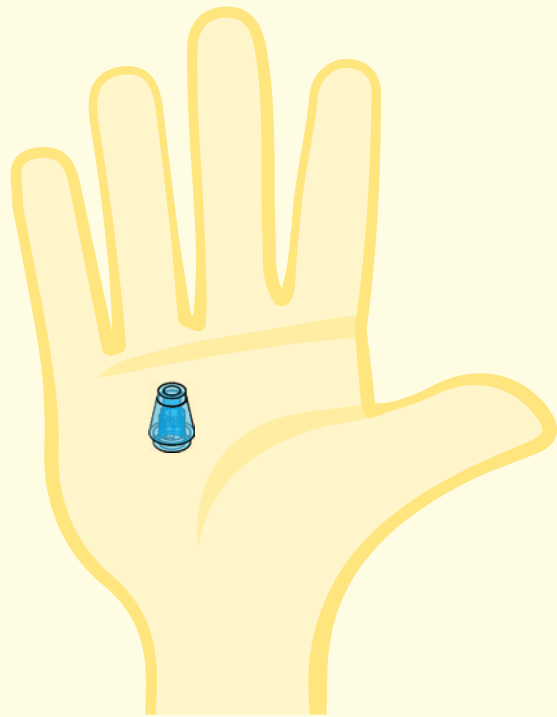
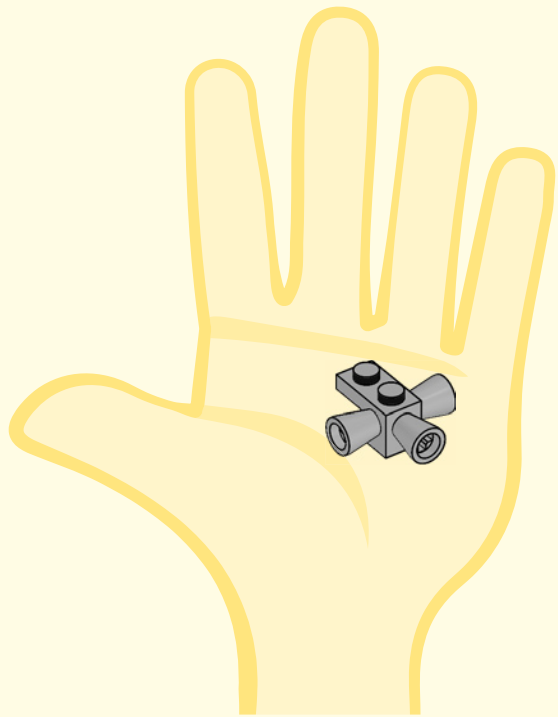

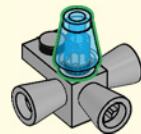
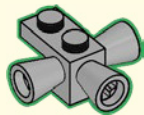

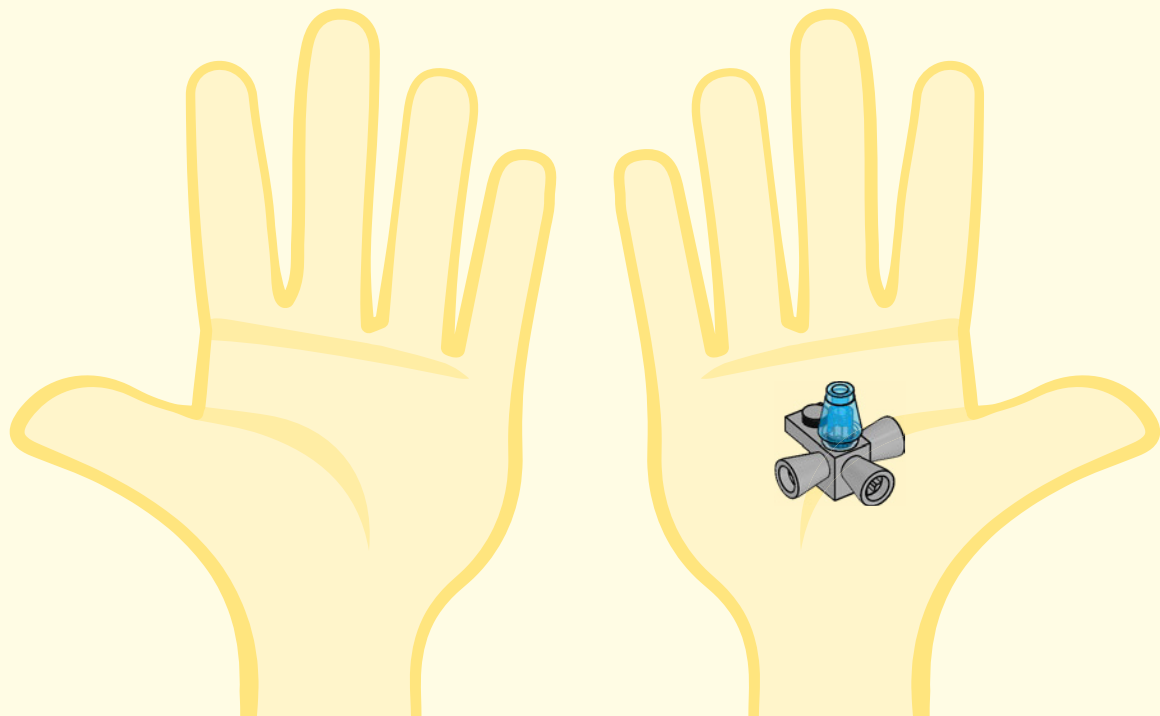

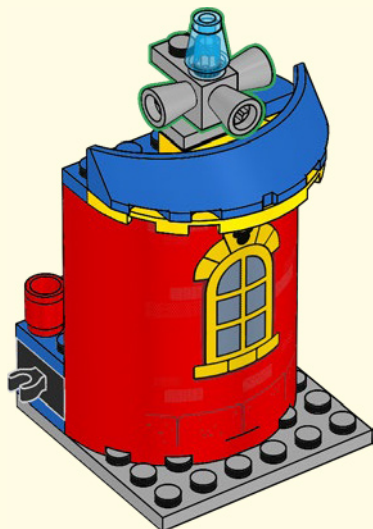

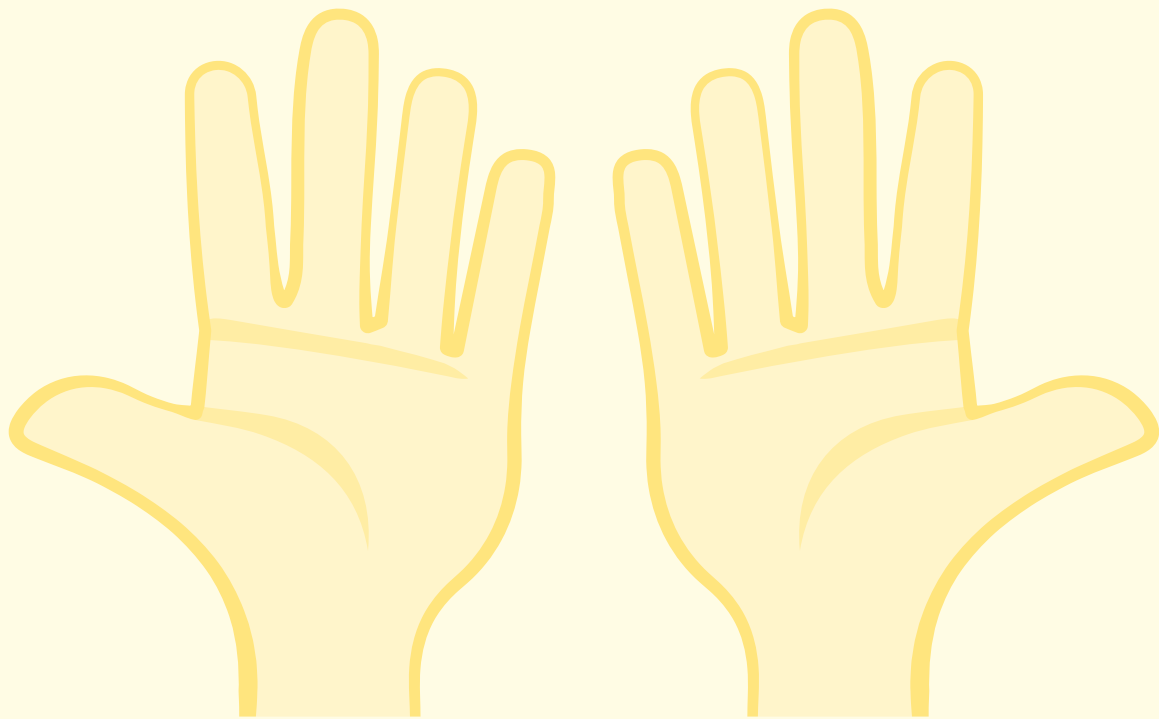

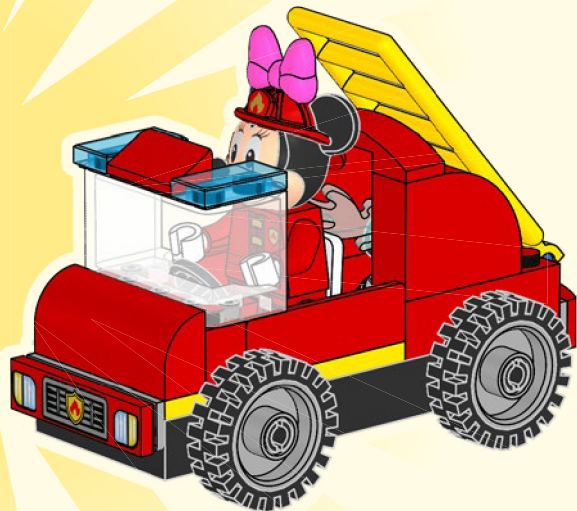
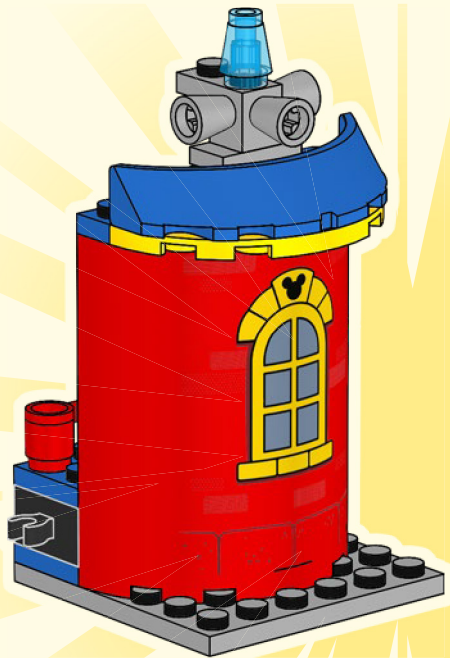



Disney

©Disney
www.disney.com

LEGO and the LEGO logo are trademarks of the/sont des marques de commerce du/son marcas registradas de LEGO Group.
©2021 The LEGO Group.
6370284



10776



10774



10772

10775



10773



4+

Disney
MICKEY
AND FRIENDS

