

**LEGO**

**duplo**

Disney  
**JUNIOR**

**MICKEY  
AND THE  
ROADSTER  
RACERS**



**BOAT  
FLOATS**

**LE BATEAU  
FLOTTE**

**EL BARCO  
FLOTA**



**10881**

LEGO.com/DUPL0



**duplo**

**FUN & PLAYFUL  
LEARNING**

**UN APPRENTISSAGE  
LUDIQUE  
ET AMUSANT**

**APRENDIZAJE  
CON DIVERSION  
Y JUEGOS**

Disney  
**JUNIOR**  
**MICKEY  
AND THE  
ROADSTER  
RACERS**



**10861**  
**Âges 1½-3**



**10881**  
**Âges 2-5**

Âges/edades

**1½**



**10863**  
**Âges 1½-3**

© Disney



**10871**  
**Âges 2-5**

**10875**  
**Âges 2-5**



**5**



**10880**  
**Âges 2-5**

Jurassic World is a trademark and copyright of Universal Studios and Amblin Entertainment, Inc. Licensed by Universal Studios Licensing LLC. All Rights Reserved.

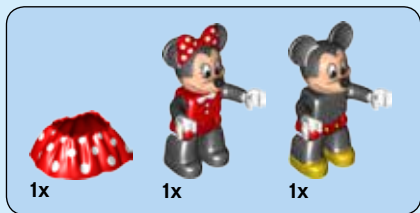

1



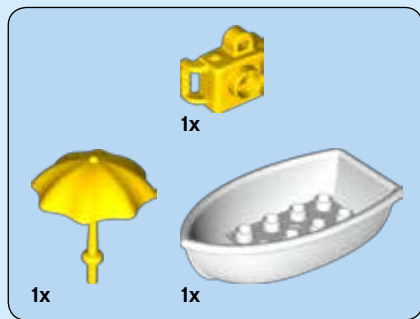

2



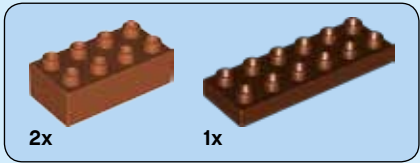

**1**



**6**

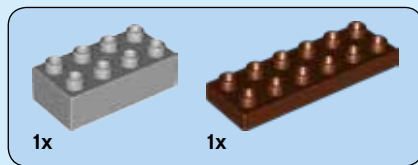

2

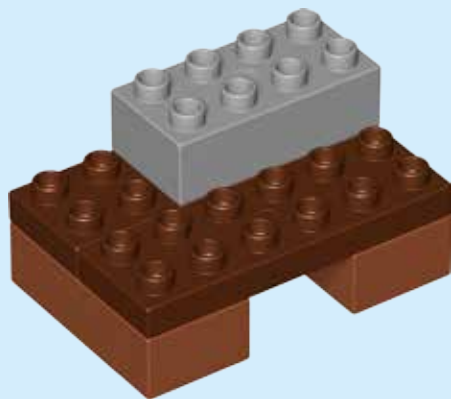

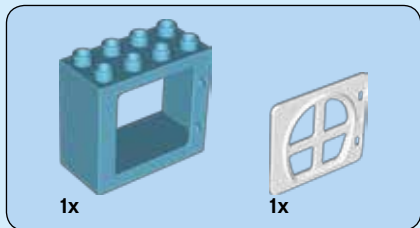

3

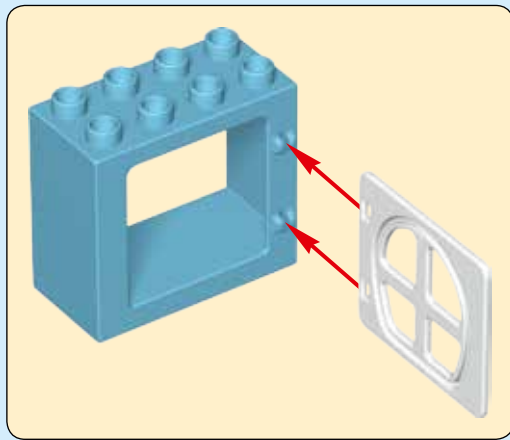
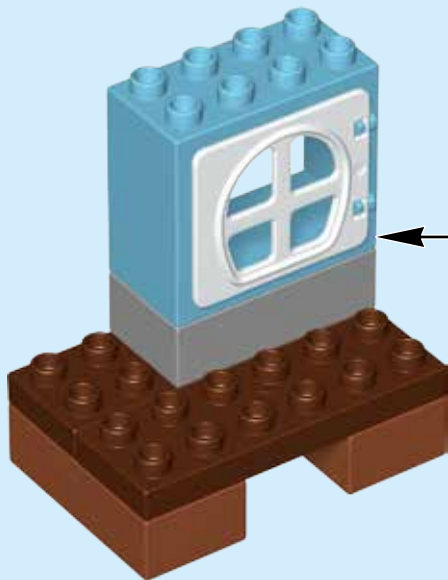



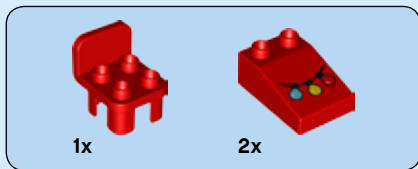

4





1

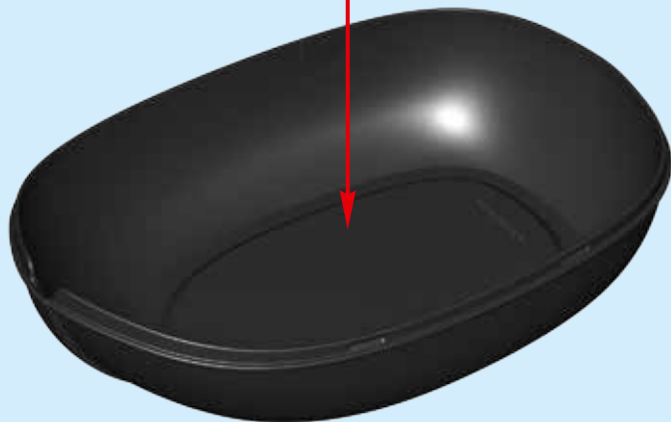

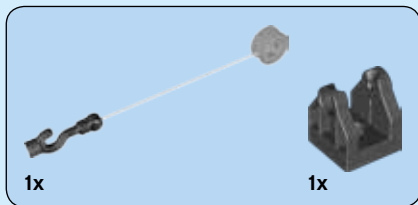

2

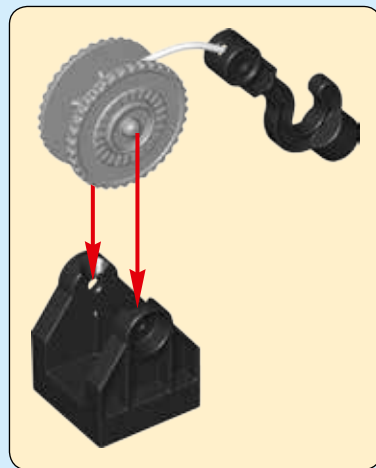



1x

3

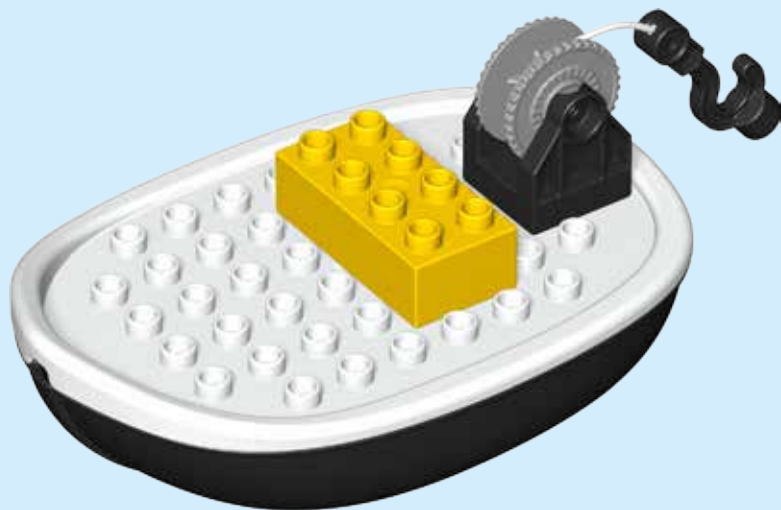

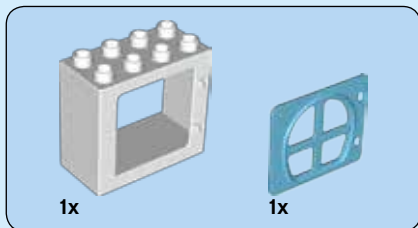

4

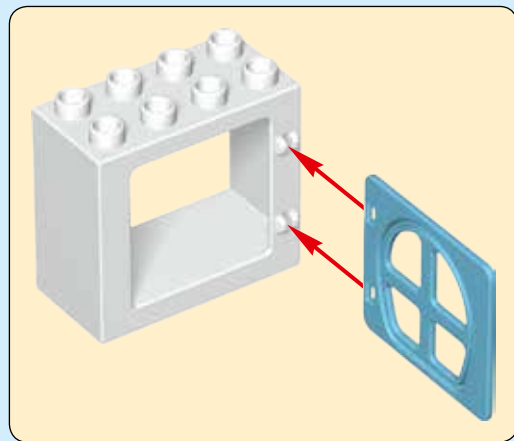
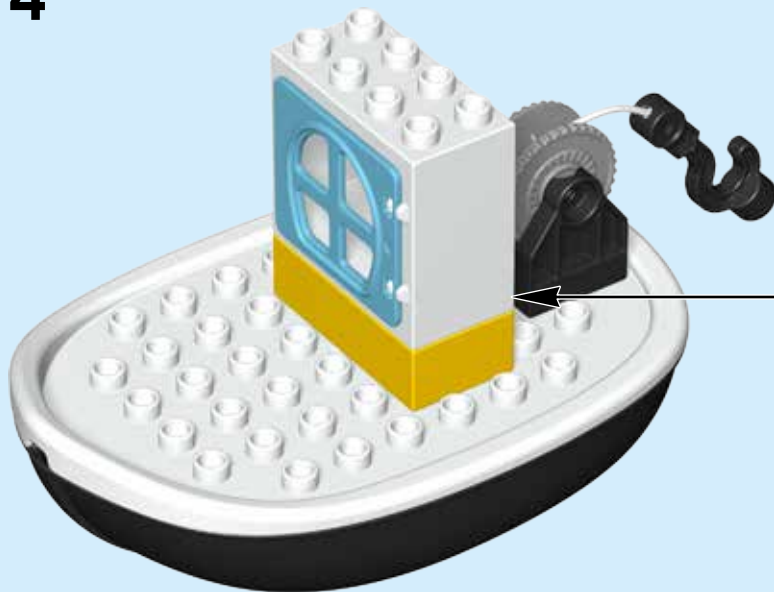

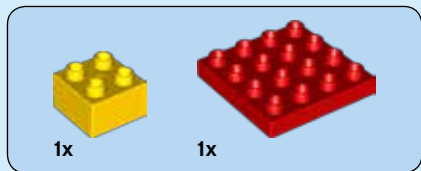

5

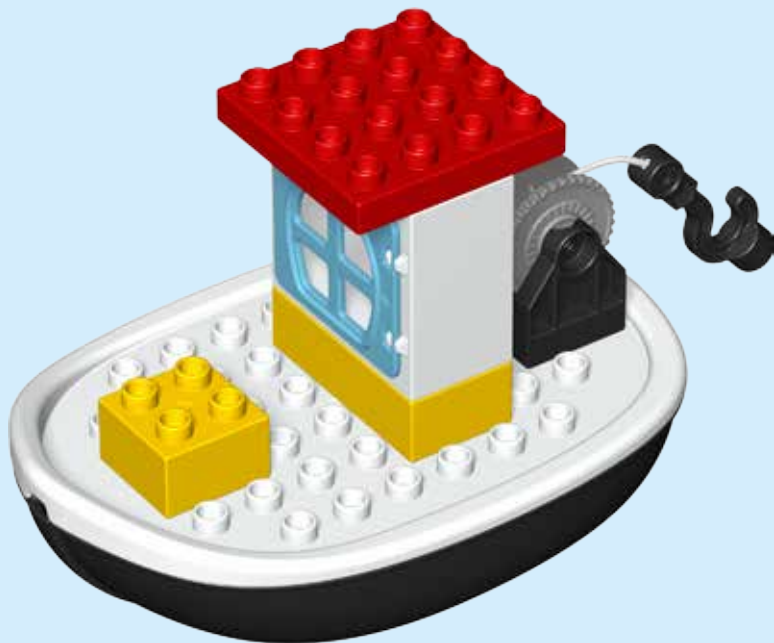



6











 duplo

The word "duplo" is written in a large, yellow, rounded font with a white outline and a red shadow. A small red fish icon is positioned above the letter 'o'.



**LEGO**

**duplo**



Disney Junior  
**MICKEY**  
AND THE  
**ROADSTER**  
**RACERS**



**FINE MOTOR  
SKILLS**

**MOTRICITÉ  
FINE**

**HABILIDADES  
MOTRICES**



**IMAGINATION  
& CREATIVITY**

**IMAGINATION  
ET CRÉATIVITÉ**

**IMAGINACIÓN  
Y CREATIVIDAD**



# duplo

Parents >

## FREE APPS APPLIS GRATUITES APPS GRATIS

The LEGO Group



Our games are available for download for both Android and iOS.

Nos jeux peuvent être téléchargés sur les appareils Android et iOS.

Nuestros juegos están disponibles para dispositivos Android e iOS.

The LEGO® DUPLO® train app is free and only compatible with LEGO DUPLO Trains 10874 and 10875. L'application LEGO® DUPLO® Train est gratuite et uniquement compatible avec les trains LEGO DUPLO 10874 et 10875. La app gratuita LEGO® DUPLO® Train sólo es compatible con los trenes LEGO DUPLO 10874 y 10875.



Customer Service  
Kundenservice  
Service Consommateurs  
Servicio Al Consumidor

LEGO.com/service or dial



: 00800 5346 5555



: 1-800-422-5346

The fun continues!  
L'amusement continue !  
¡La diversión continúa!

**FACILE À CONSTRUIRE**  
**FÁCIL DE CONSTRUIR**

**EASY TO BUILD**



**4-7**



**1½-5**



# win

Go to  
[www.LEGO.com/productfeedback](http://www.LEGO.com/productfeedback)  
and give us your short  
**feedback** about this LEGO® DUPLO®  
set for a chance to win  
a cool LEGO prize

Terms & Conditions apply



## LEGO.com/productfeedback

### GEWINNE

*Erzähle uns auf  
[www.LEGO.com/productfeedback](http://www.LEGO.com/productfeedback)*

*etwas über die Erfahrungen, die du mit  
diesem LEGO® Set gemacht hast, und  
sichere dir die Chance auf einen coolen  
LEGO Preis!*

*Es gelten die Teilnahmebedingungen*

### GAGNE

*Rends-toi sur  
[www.LEGO.com/productfeedback](http://www.LEGO.com/productfeedback)*

*et donne-nous quelques commentaires sur  
ce produit LEGO® pour avoir une chance  
de gagner un prix LEGO !*

*Voir Conditions Générales*

### GANAN

*Visita  
[www.LEGO.com/productfeedback](http://www.LEGO.com/productfeedback)*

*y envíanos tu opinión acerca de este set  
LEGO®. ¡Participarás en el sorteo de un  
premio LEGO!*

*Términos y Condiciones aplicables*

### 获取奖品

*登录  
[www.LEGO.com/productfeedback](http://www.LEGO.com/productfeedback)*

*给出关于此乐高®套装的简短反馈，  
就有机会获得炫酷乐高高奖品*

*《条款及条件》适用*

LEGO, the LEGO logo, DUPLO and the DUPLO logo are trademarks of the/son des marques de commerce du/son marcas registradas de LEGO Group.

©2018 The LEGO Group.

© Disney

6244995