

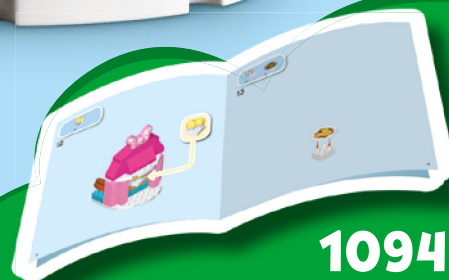

**duplo**

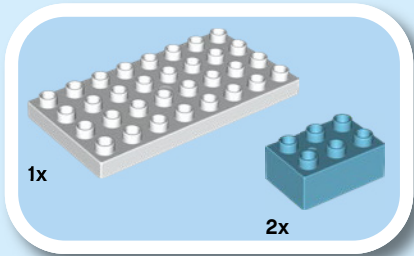

**10942**  
LEGO.com/DUPLO



1

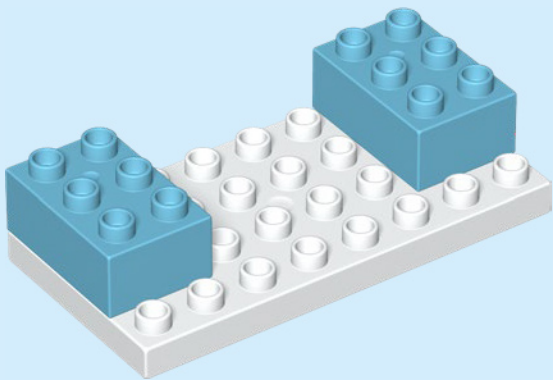

2



2

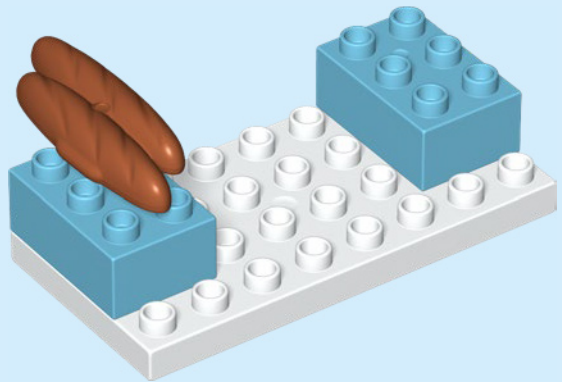

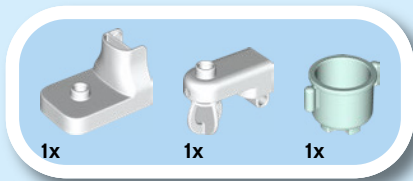

3

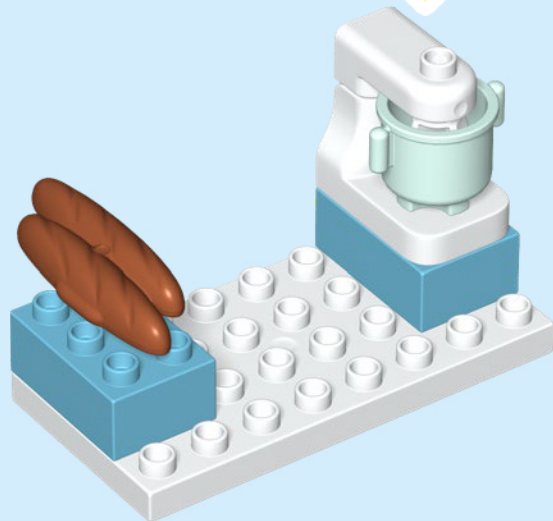
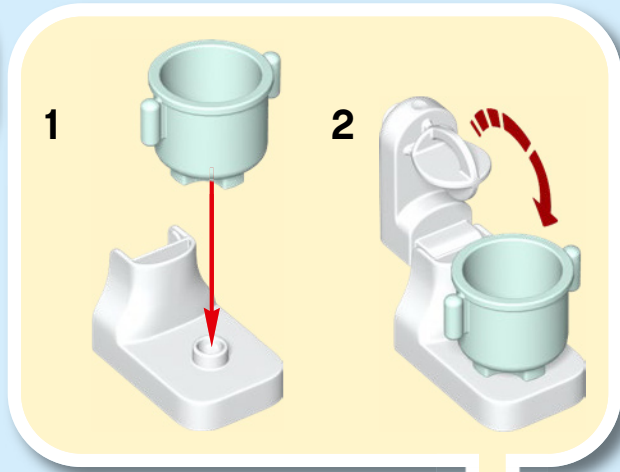

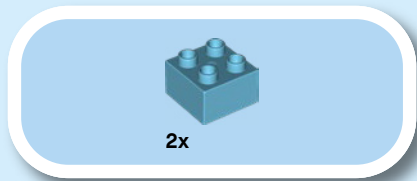

4

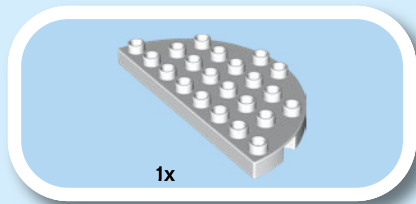
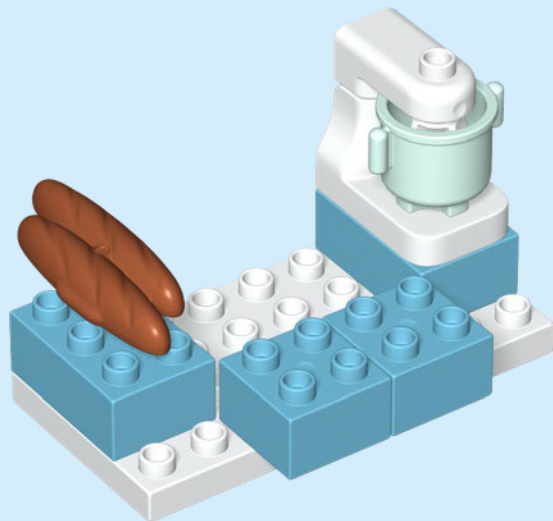

5

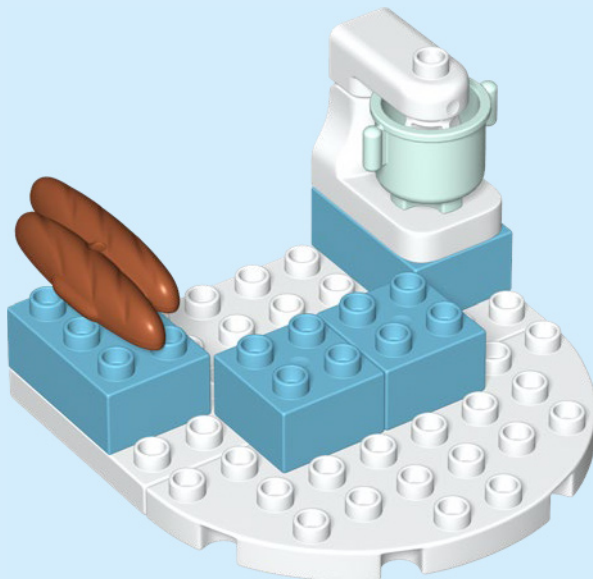

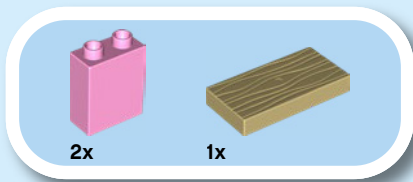

6

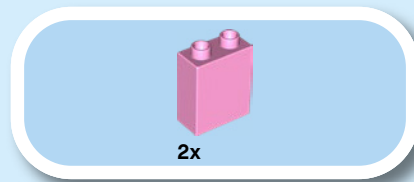
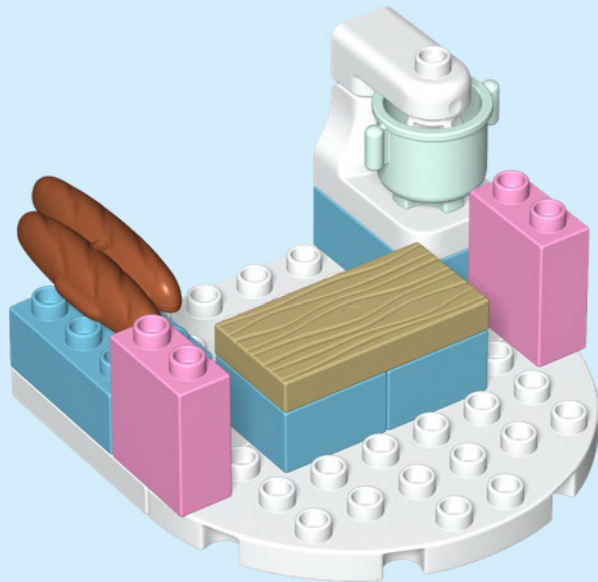

7

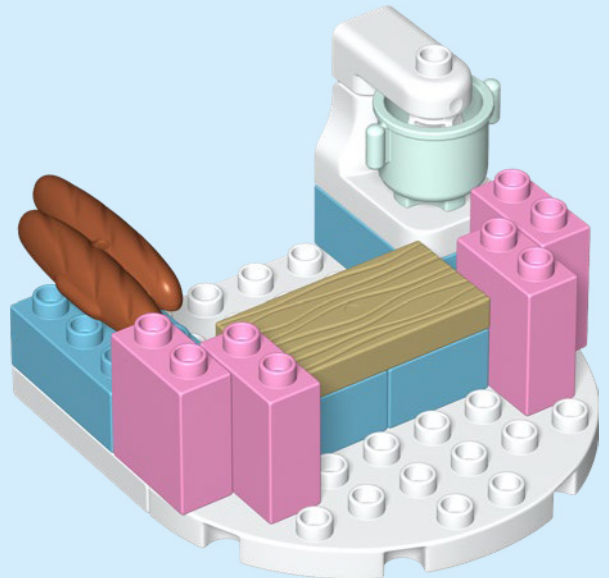

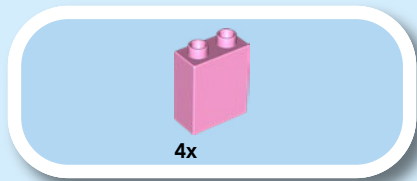

8

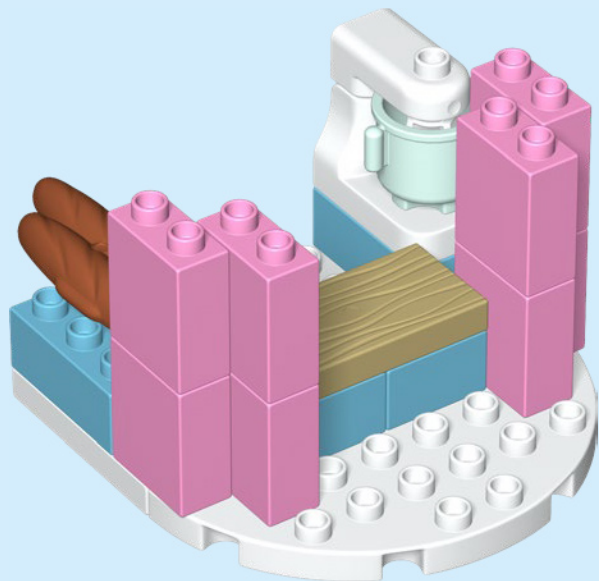

6

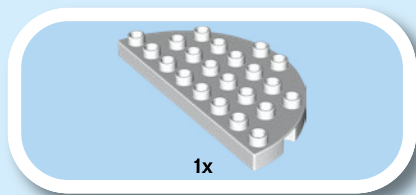

9

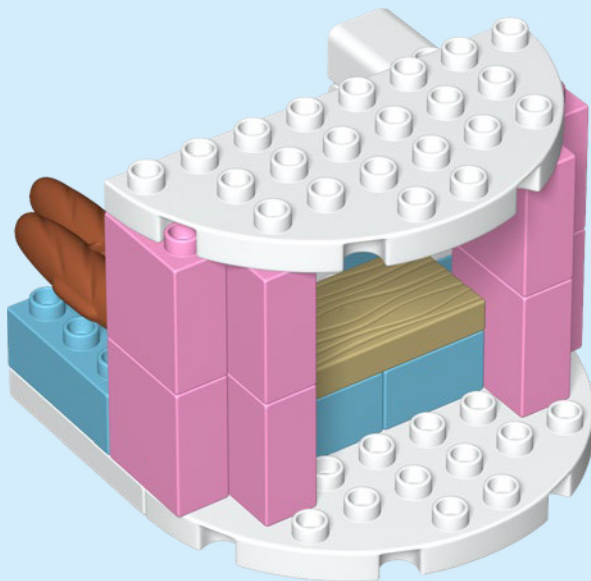



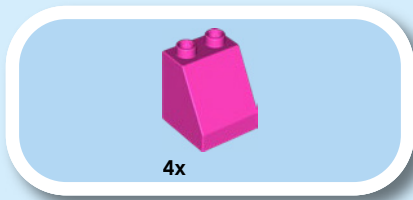

10

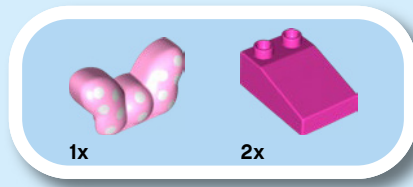

11

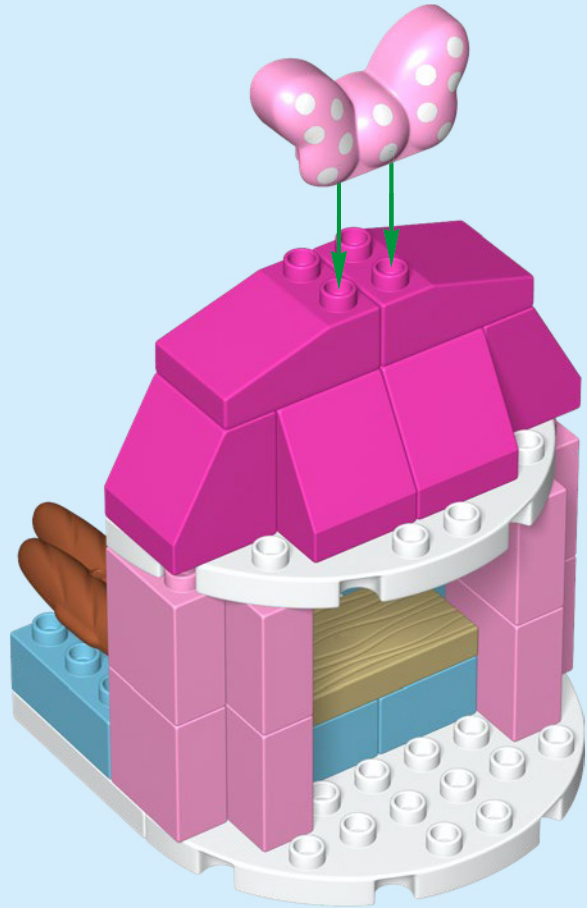

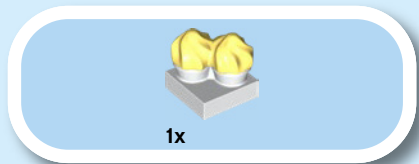

12

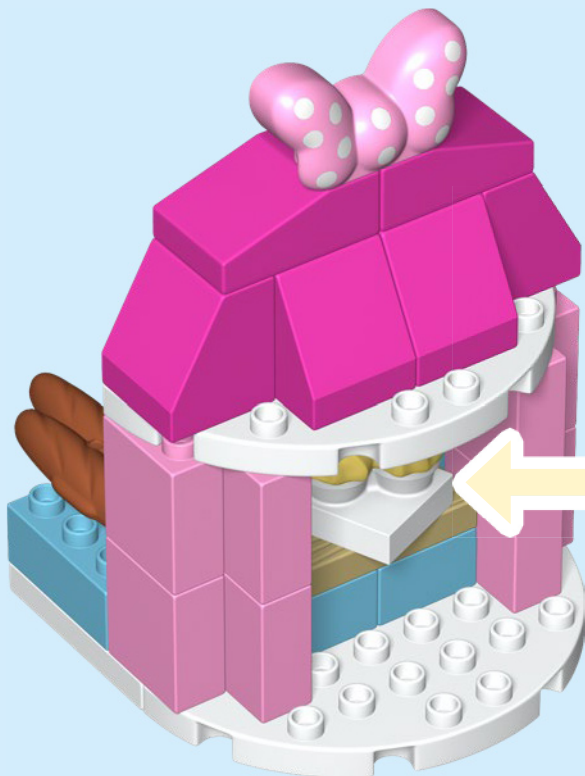



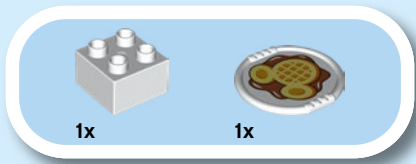

13

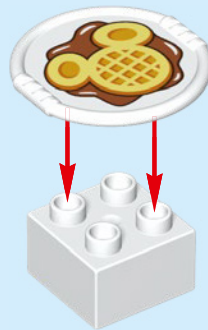



Customer Service

Kundenservice

Service Consommateurs

Servicio Al Consumidor

[LEGO.com/service](http://LEGO.com/service) or dial



00800 5346 5555 :



1-800-422-5346 :





# LEGO duplo



Age **1½** Age **2+**



© 2021 MARVEL  
©Disney



Terms & Conditions apply

## LEGO.com/productfeedback

### GEWINNE

Erzähle uns auf  
[www.LEGO.com/productfeedback](http://www.LEGO.com/productfeedback)

*etwas über die Erfahrungen, die du mit diesem LEGO® Set gemacht hast, und sichere dir die Chance auf einen coolen LEGO Preis!*

*Es gelten die Teilnahmebedingungen*

### GAGNE

Rends-toi sur  
[www.LEGO.com/productfeedback](http://www.LEGO.com/productfeedback)

*et donne-nous quelques commentaires sur ce produit LEGO® pour avoir une chance de gagner un prix LEGO !*

*Voir Conditions Générales*

### GANAN

Visita  
[www.LEGO.com/productfeedback](http://www.LEGO.com/productfeedback)

*y envíanos tu opinión acerca de este set LEGO®. ¡Participarás en el sorteo de un premio LEGO!*

*Términos y Condiciones aplicables*

### 获取奖品

登录  
[www.LEGO.com/productfeedback](http://www.LEGO.com/productfeedback)

*给出关于此乐高®套装的简短反馈，就有机会获得炫酷乐高奖品*

*《条款及条件》适用*

LEGO, the LEGO logo and DUPLO are trademarks of the LEGO Group. ©2021 The LEGO Group.

©Disney

6371732