



classic

11035



WARNING: CHOKING HAZARD.
Small parts. Not for children under 3 years.



Q LEGO® Builder



Get excited about our new packaging!

We're switching from plastic to paper-based packaging. That's why you might find a mix of paper and plastic in our boxes!

Nos nouveaux emballages vous emballeront !

Nous passons des emballages en plastique aux emballages à base de papier. C'est pourquoi vous pourriez trouver un mélange de papier et de plastique dans nos boîtes !

¡Te presentamos nuestros nuevos empaques!

Estamos sustituyendo las bolsas de plástico por bolsas con base de papel. ¡Por eso, puedes encontrar una mezcla de papel y de plástico en nuestras cajas!

LEGO.com/sustainable-packaging

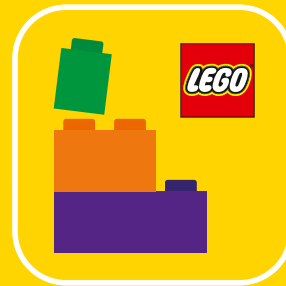

BUILDER



Apple and the Apple logo are trademarks of Apple Inc., registered in the U.S. and other countries and regions. App Store is a service mark of Apple Inc. Google Play and the Google Play logo are trademarks of Google LLC. Tencent and the Tencent logo are trademarks of Tencent Inc.

LEGO.com/devicecheck

EN Ask parents' permission before going online | DE Eltern um Erlaubnis bitten, bevor du online gehst | FR Demande l'autorisation d'un parent avant d'aller en ligne | IT Chiedi il permesso ai tuoi genitori prima di andare online | ES Pídeles permiso a tus papás antes de conectarte a Internet | PT Pede autorização aos pais antes de acederes online | ZH 上网前应先征得父母的同意 | PL Poproś rodziców o zgodę, zanim wejdiesz do Internetu | CS Než půjdeš na internet, požádej rodiče o svolení | SK Skôr než pôjdeš na internet, vypýtaj si povolenie od rodičov | HU Kérj szülői engedélyt, mielőtt online csatlakoznál! | RO Cere permisiunea părinților înainte de a te conecta online | BG Поискайте разрешение от родител, преди да влезете онлайн | LV Pirms došanās tiešsaistē palūdz atļauju vecākiem | ET Enne Interneti kasutamist küsi vanematelt luba | LT Prieš prisijungdami prie interneto, atsilkauskite tėvų



Build

Construire
Construye



Rebuild

Reconstruire
Reconstruye



**Free
Build**

Construction libre
Construye libremente



8

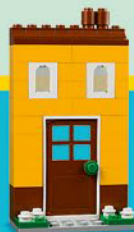

28



42



64



80



100

ideas
included

idées
incluses

incluye
ideas



118

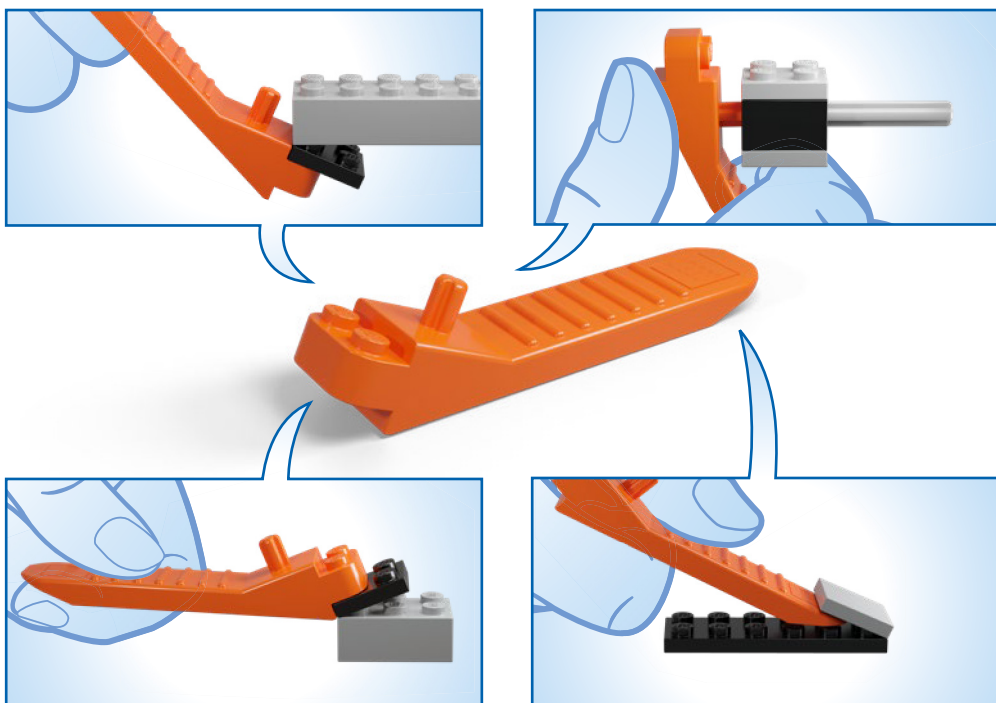

AVERTISSEMENT : RISQUE D'ÉTOUFFEMENT.
Contient des petites pièces. Ne convient pas aux enfants de moins de 3 ans.



ADVERTENCIA: PELIGRO DE ASFIXIA.
No recomendado para niños menores de 3 años. Contiene piezas pequeñas.



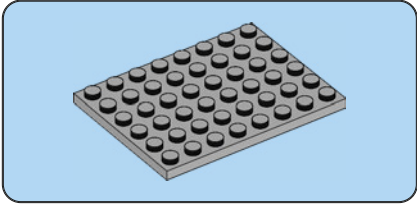
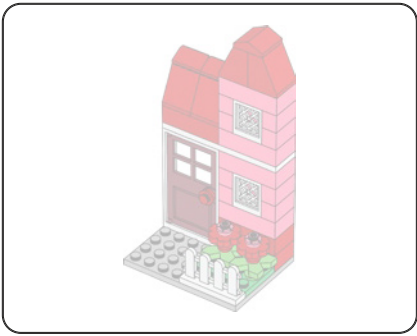

1

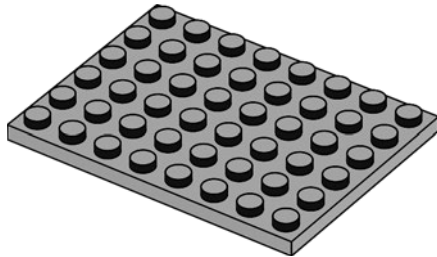

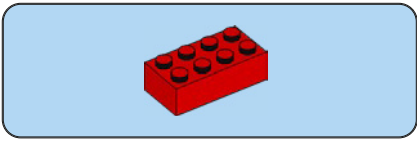

2

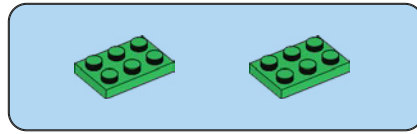
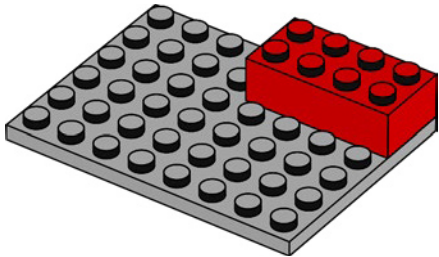

3

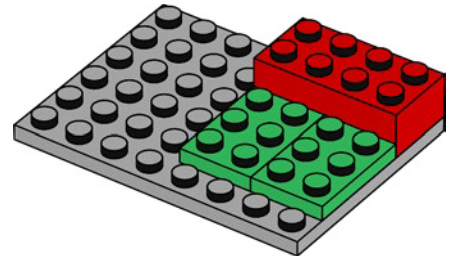

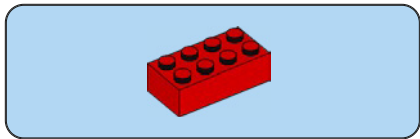

4

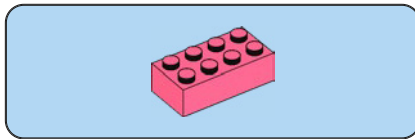
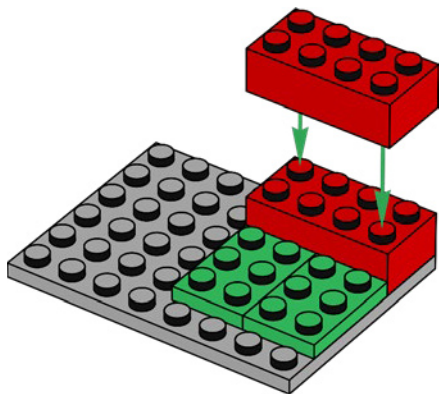

5

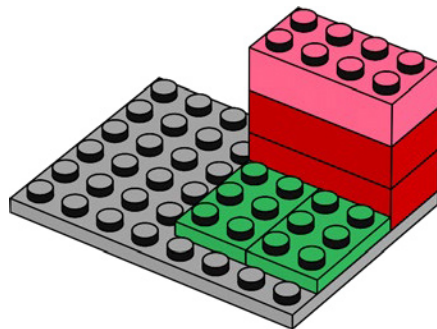

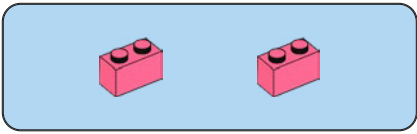

6

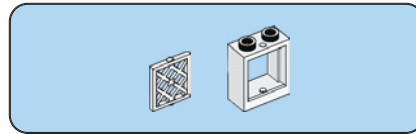
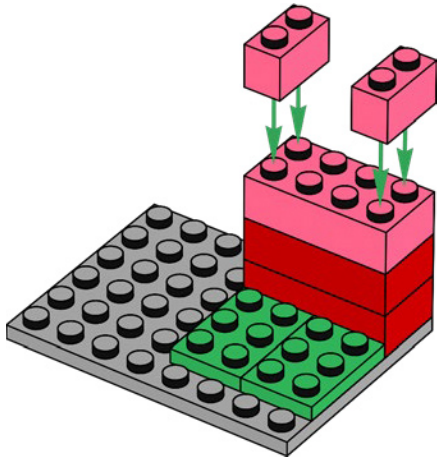

7

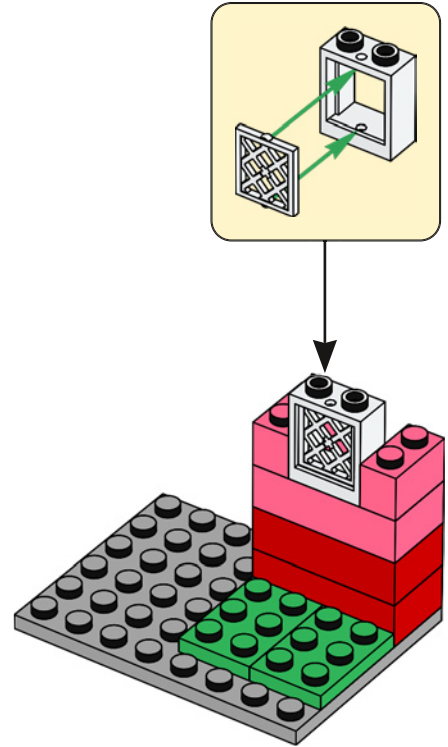

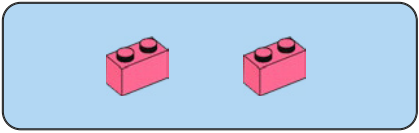

8

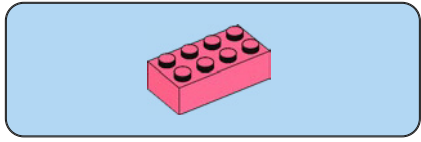
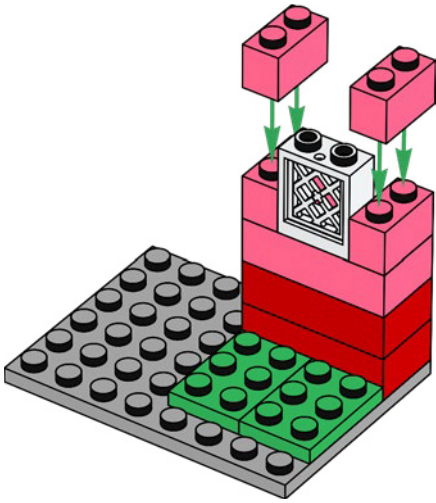

9

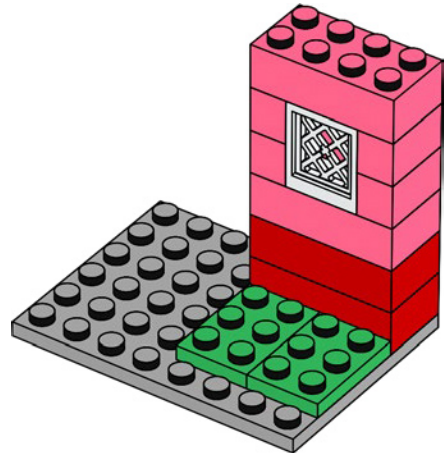

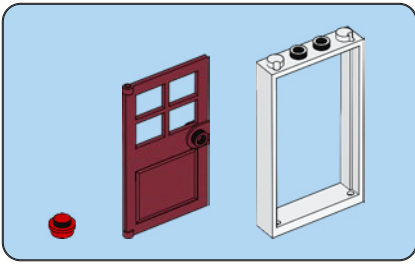

10

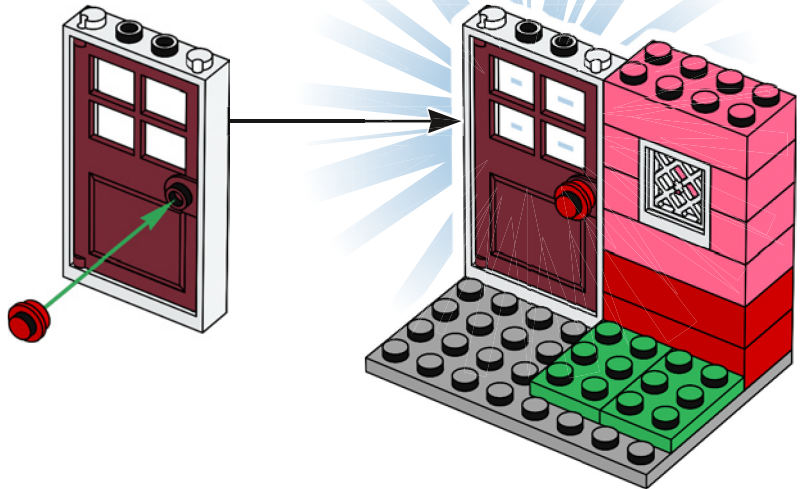
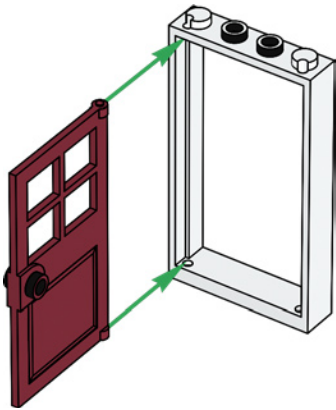

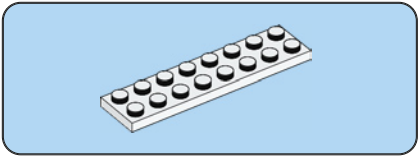

11

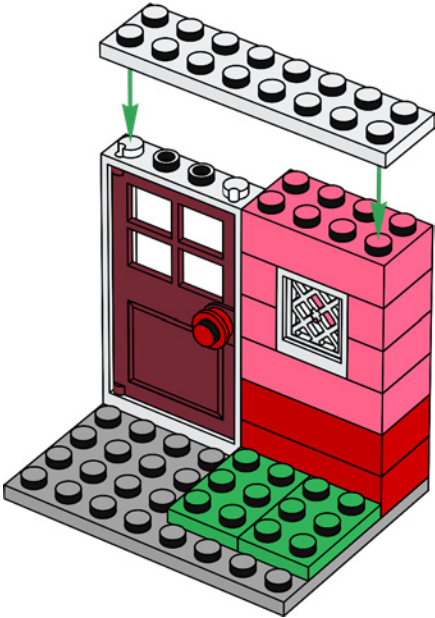

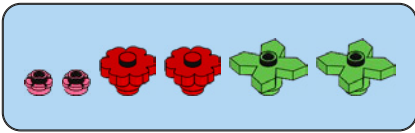

12

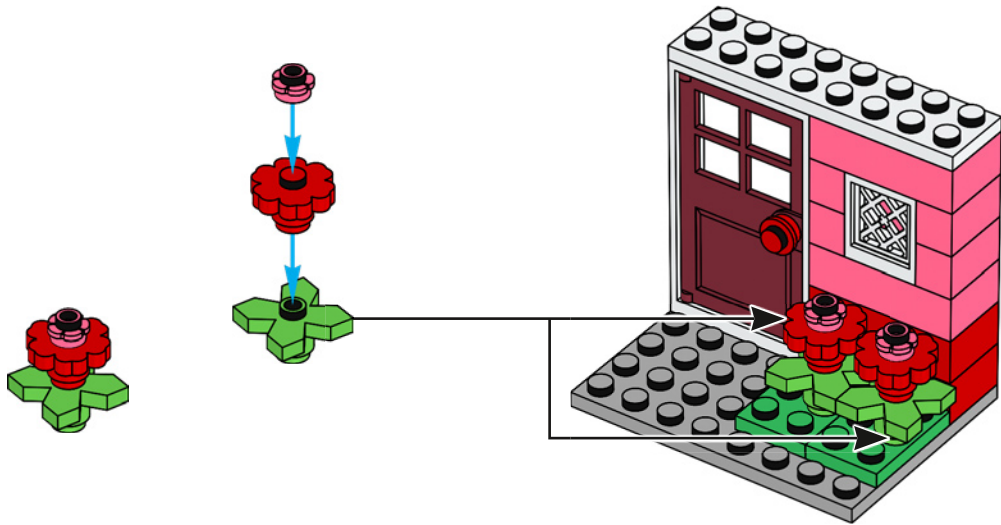

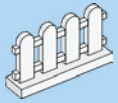

13

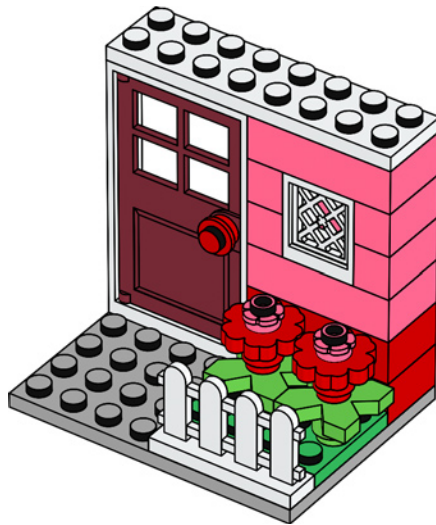

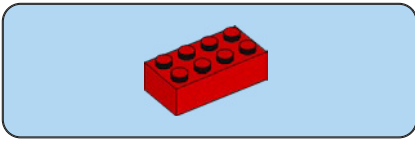

14

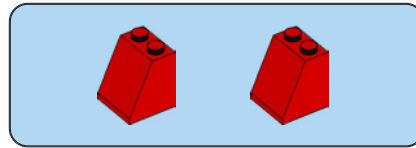

15

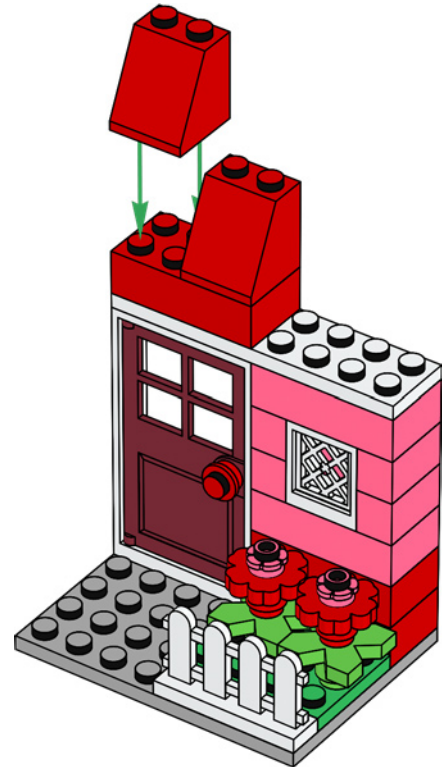

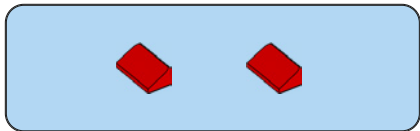

16

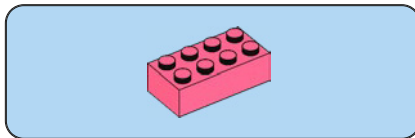
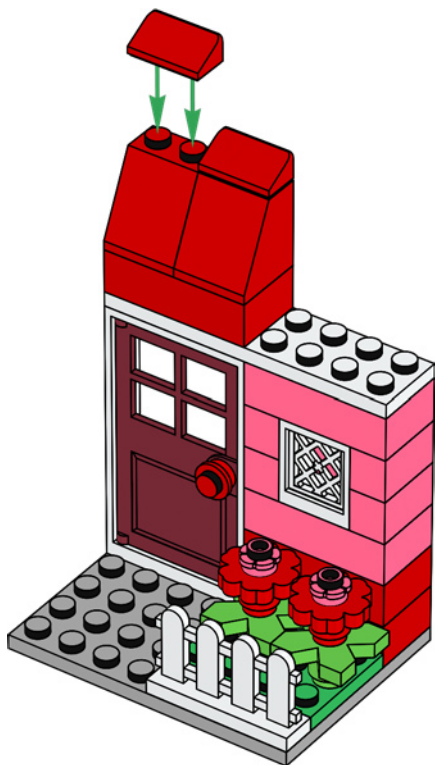

17

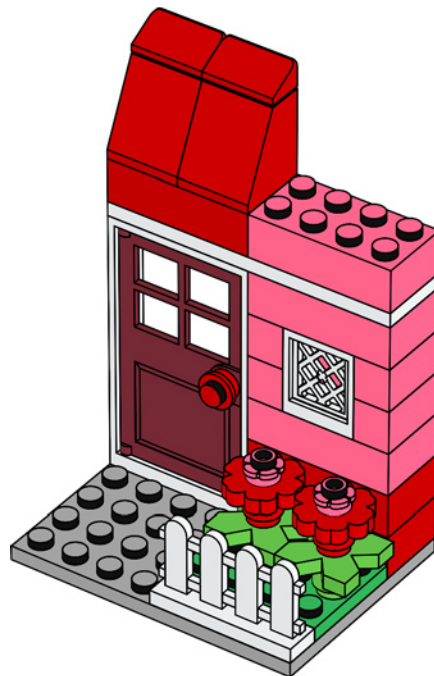

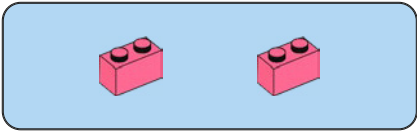

18

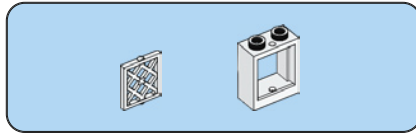
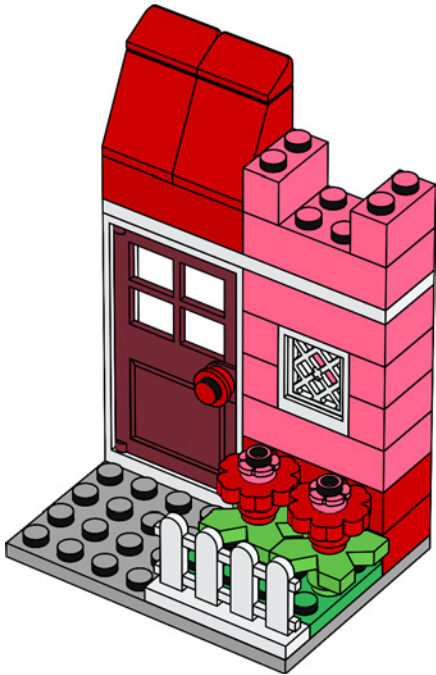

19

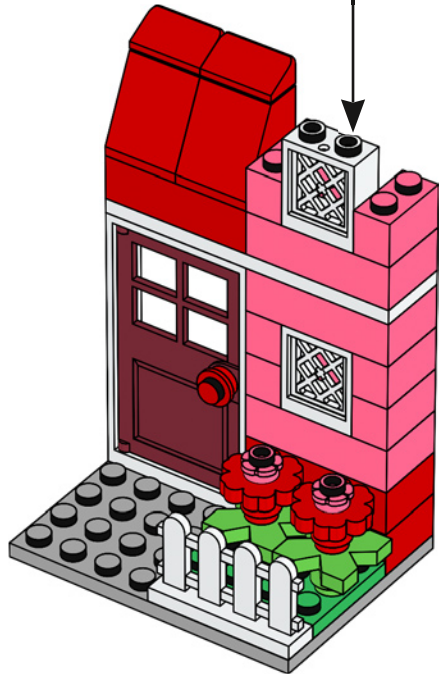
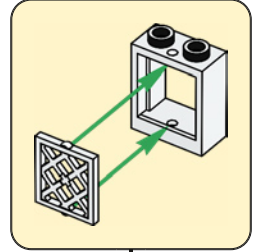

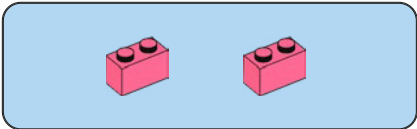

20

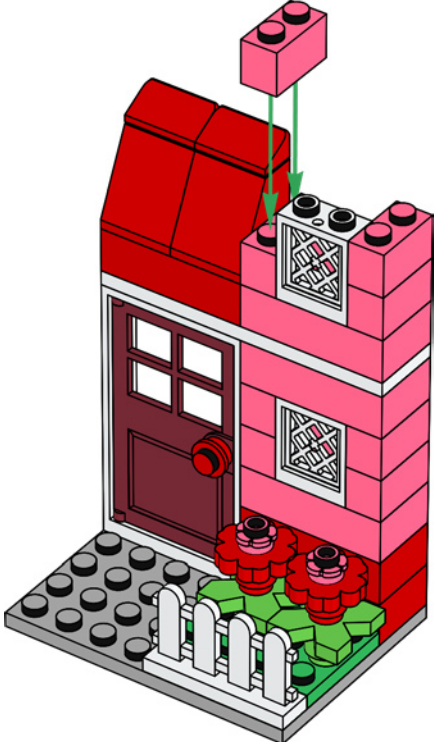

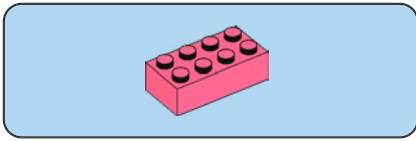

21

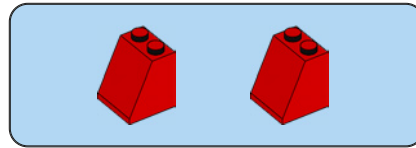
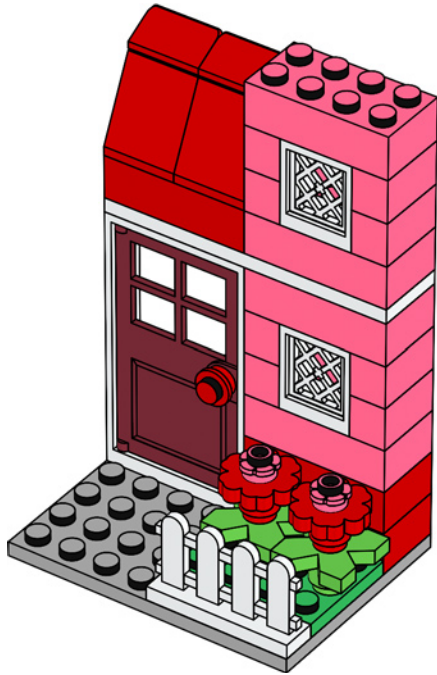

22



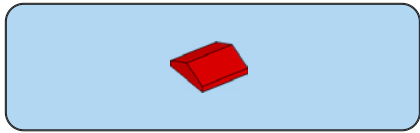

23

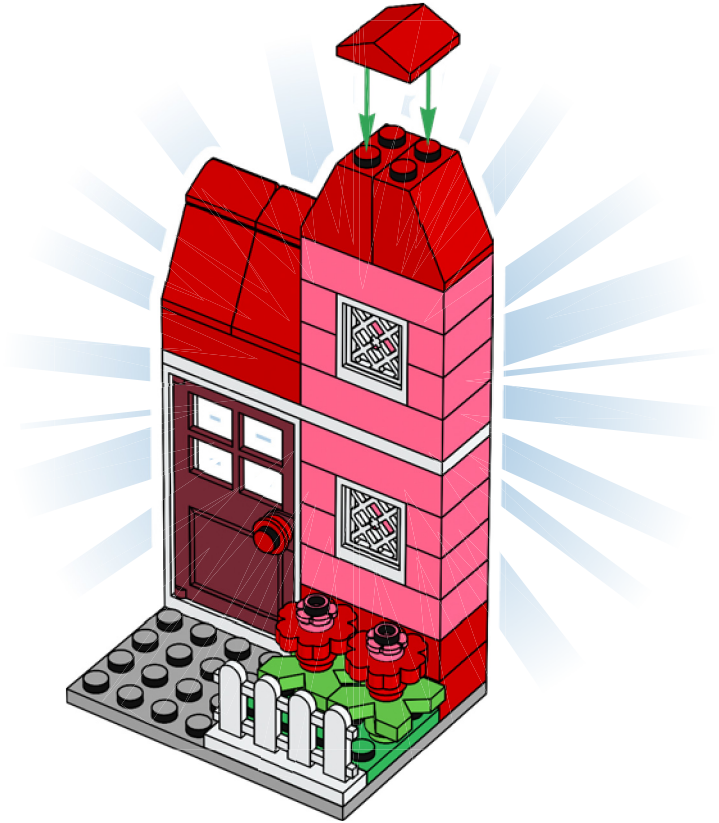

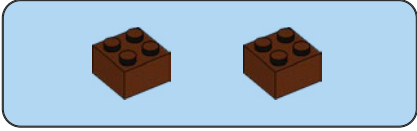
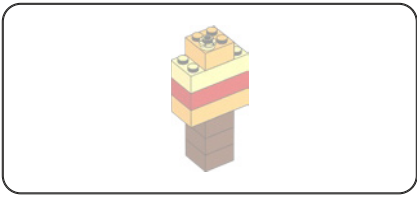

24

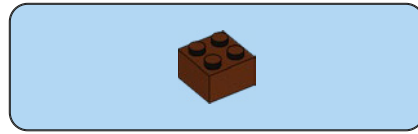
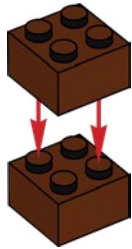

25

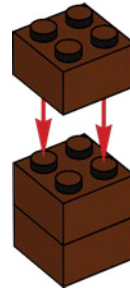

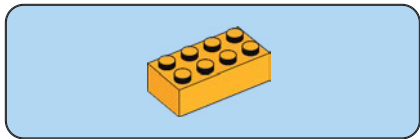

26

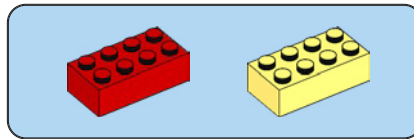
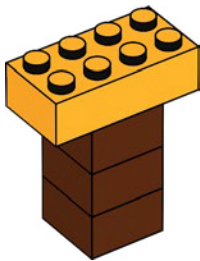

27

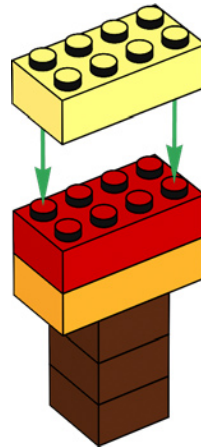

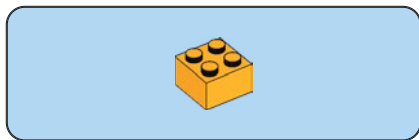

28

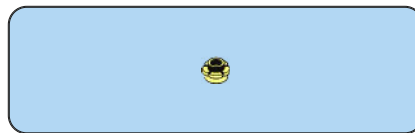
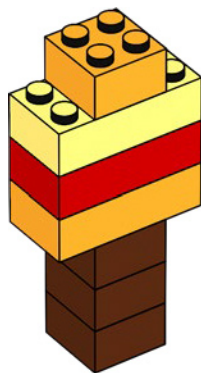

29

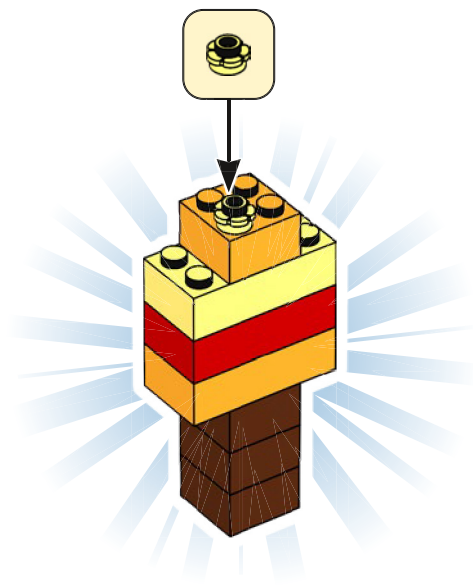

Rebuild

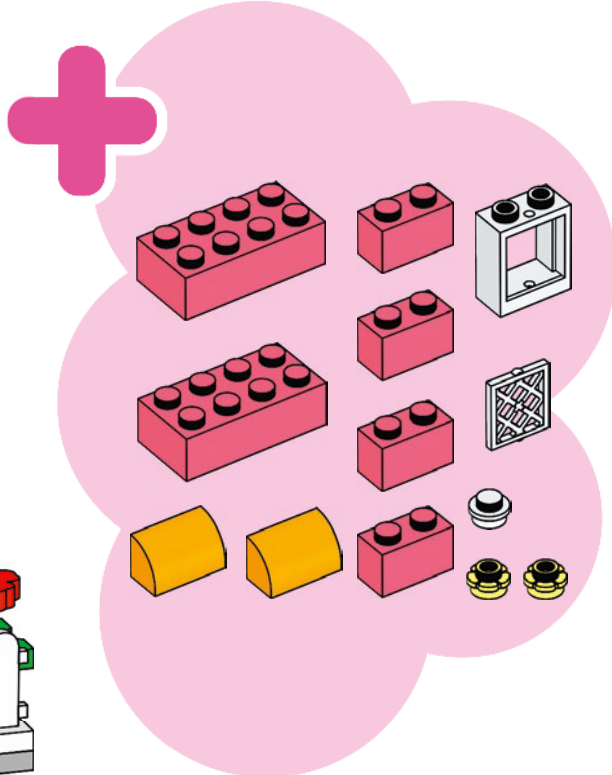
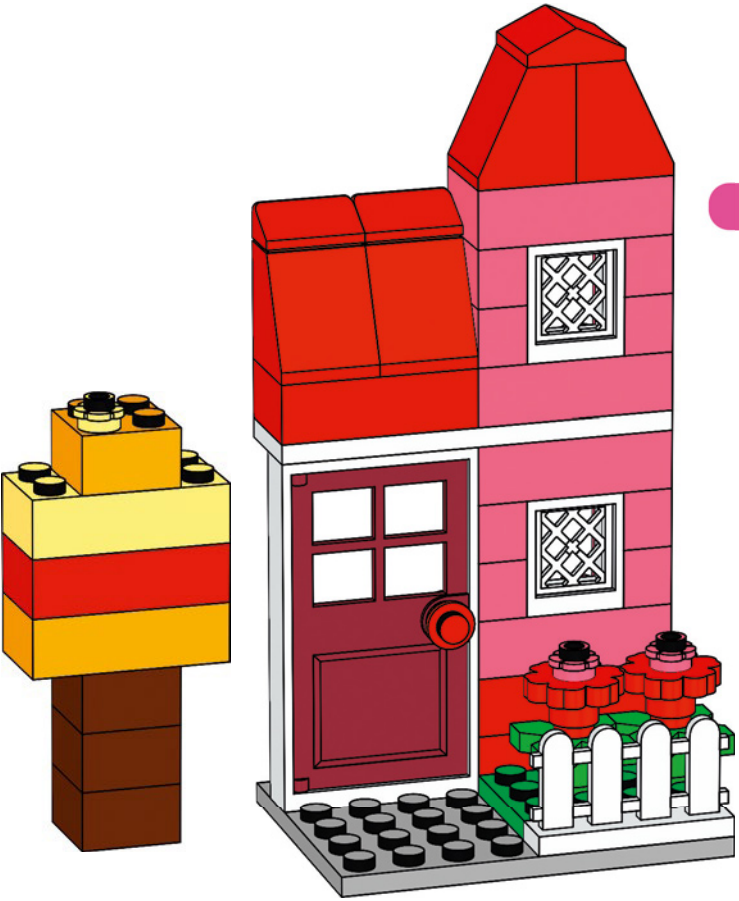

Reconstruire
Reconstruye

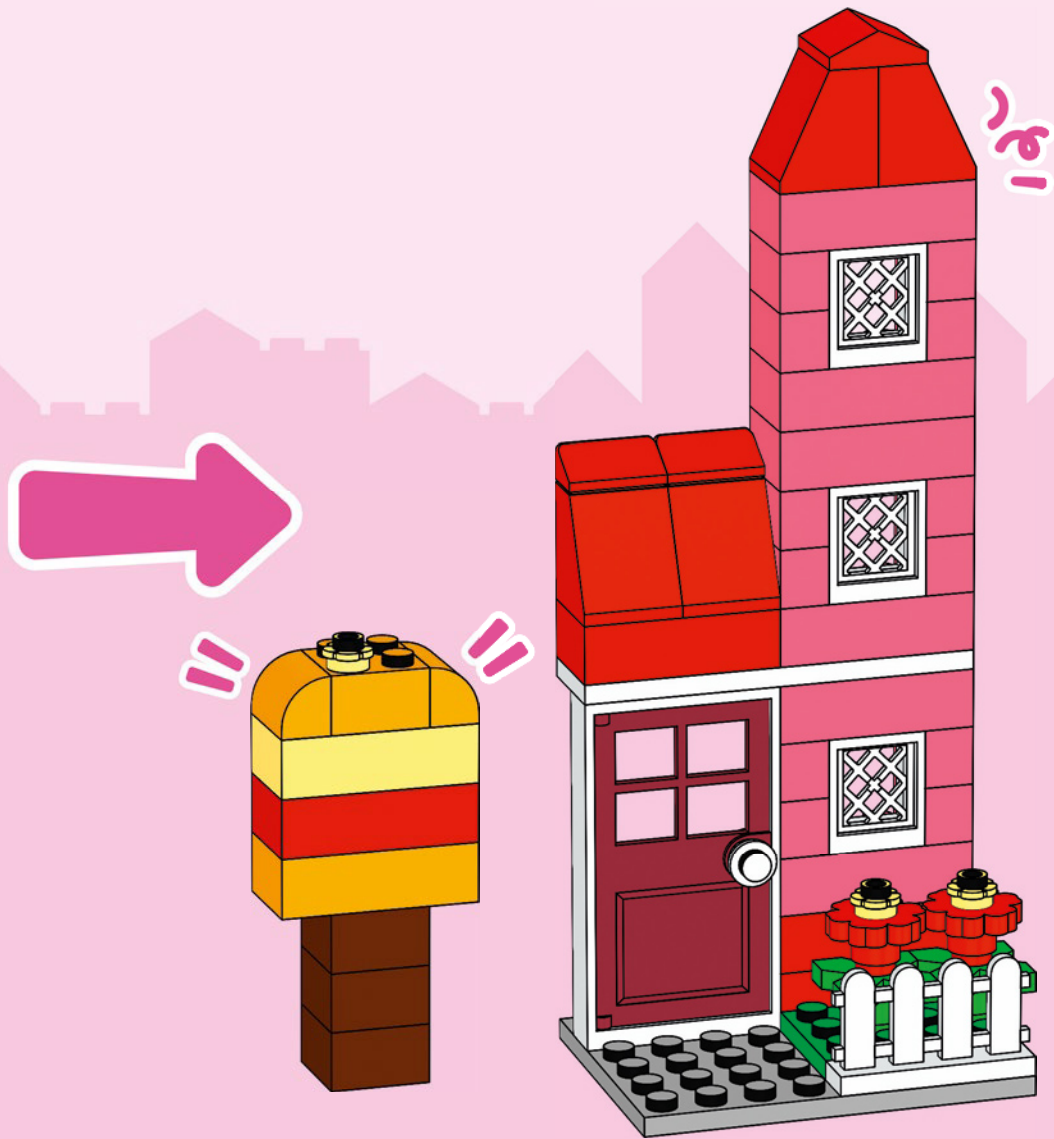

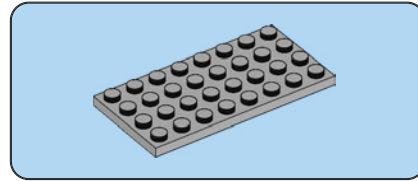
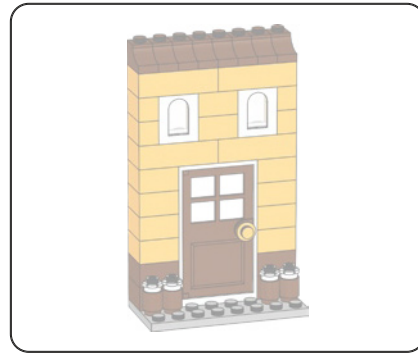

1

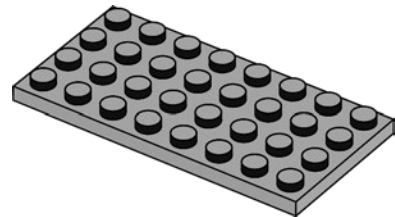

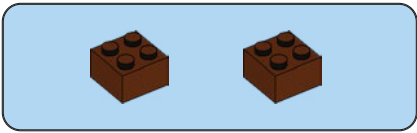

2

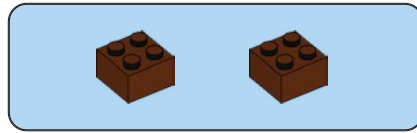
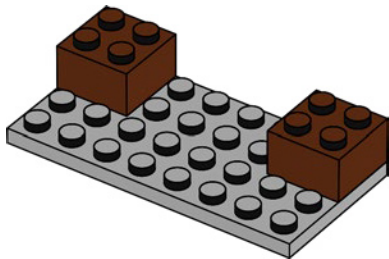

3

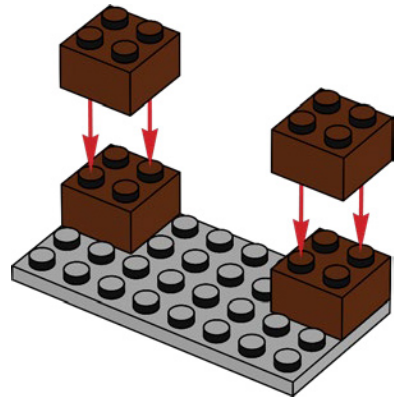

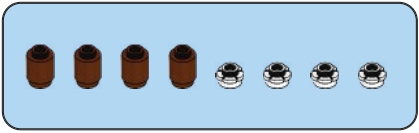

4

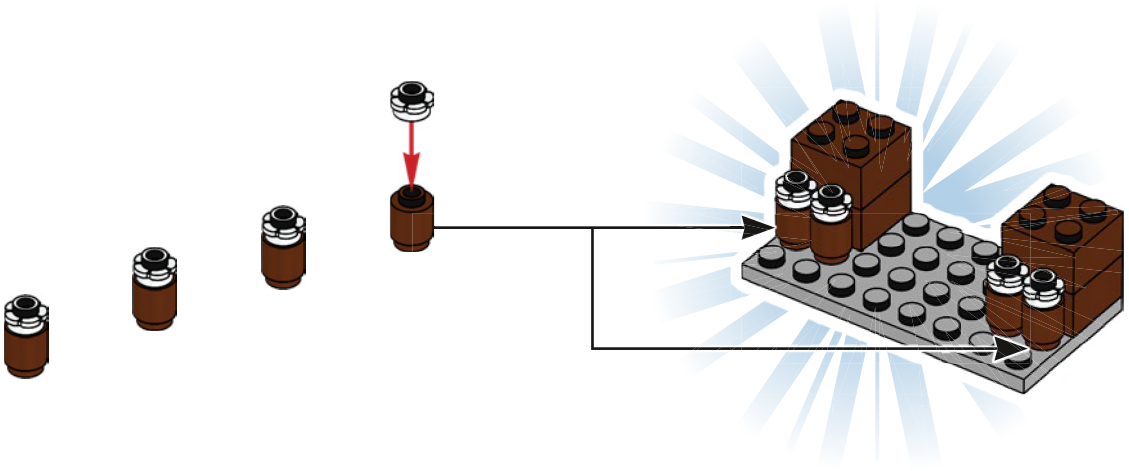

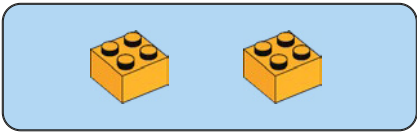

5

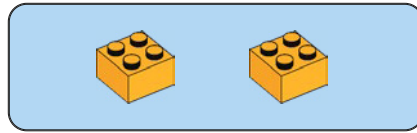
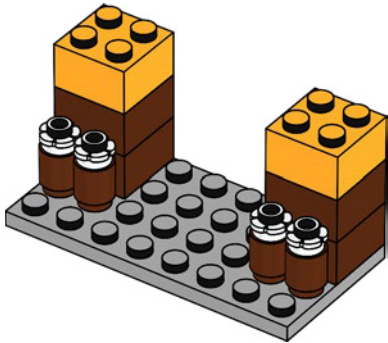

6

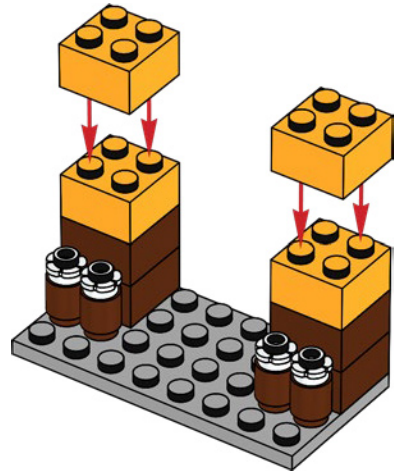

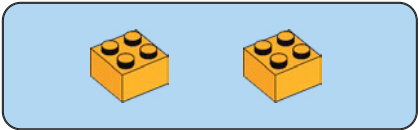

7

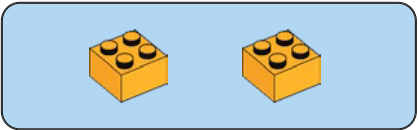
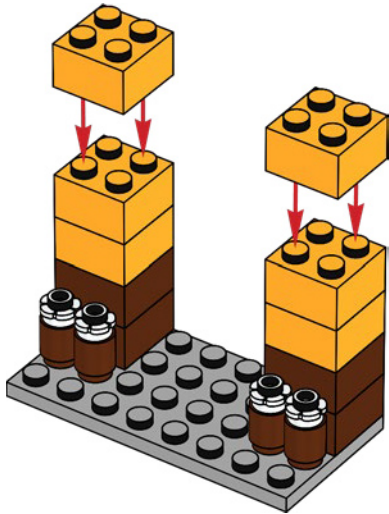

8

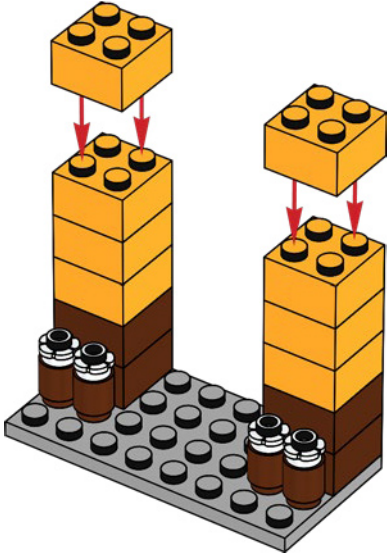

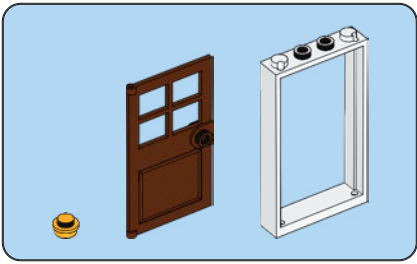

9

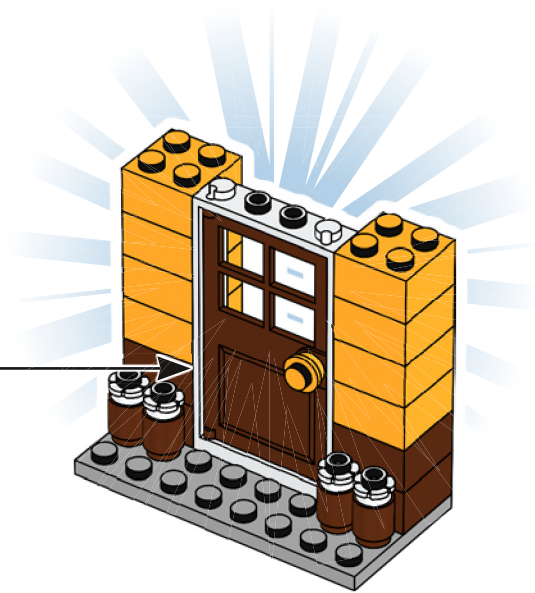
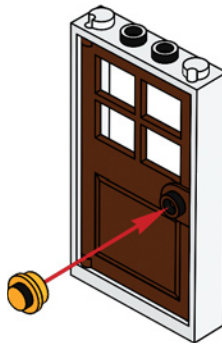
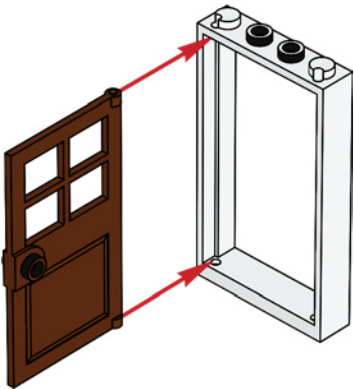

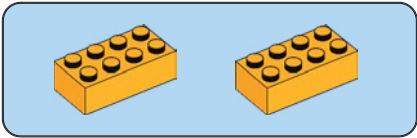

10



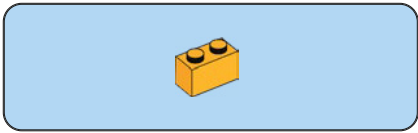

11

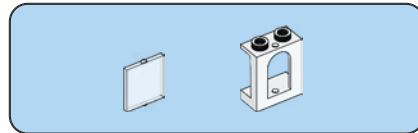

12

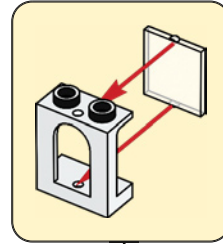



13



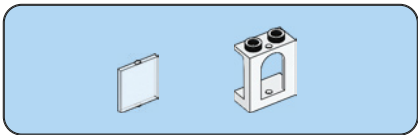

14

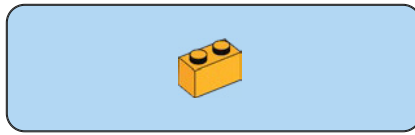
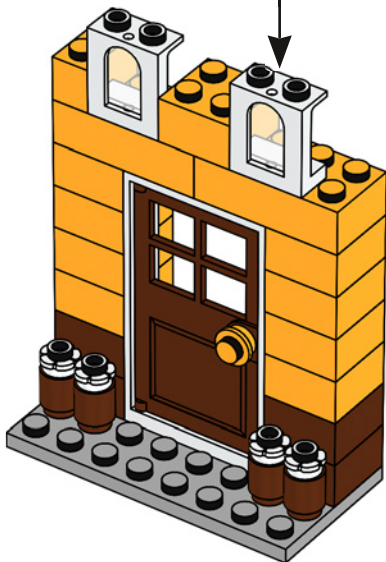
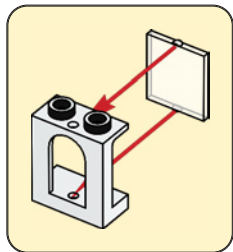

15



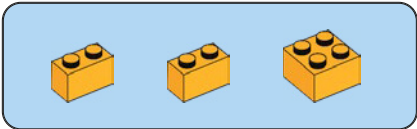

16



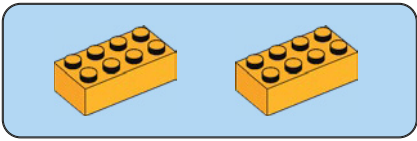

17

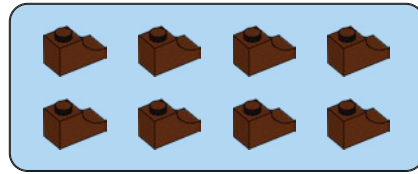

18



Rebuild

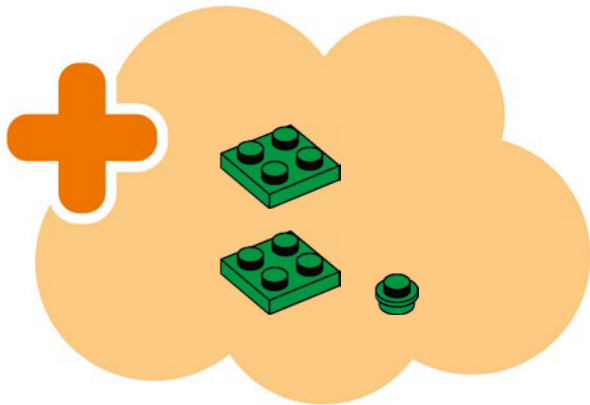
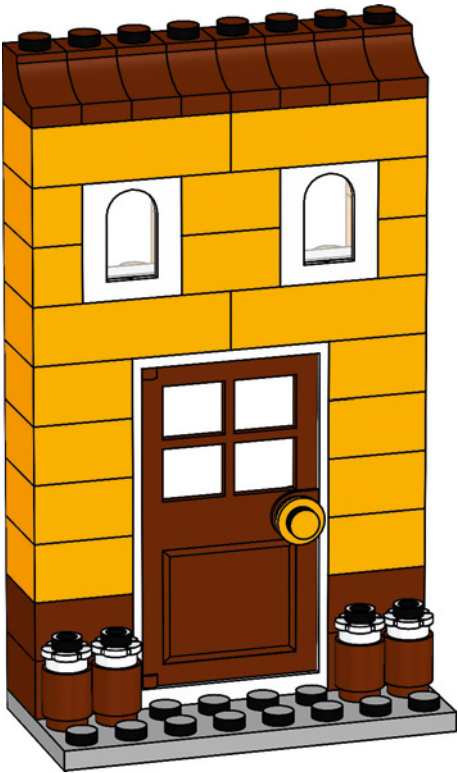

**Reconstruire
Reconstruye**



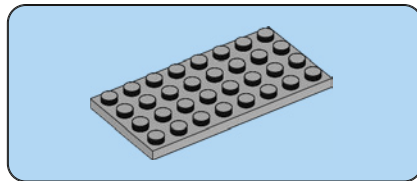
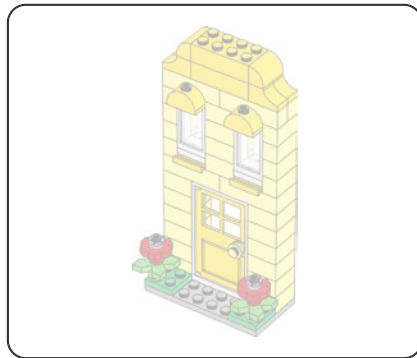

1

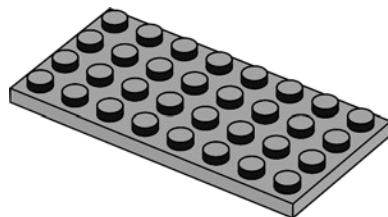

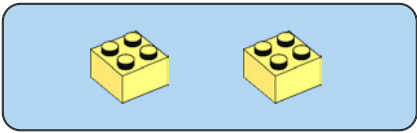

2

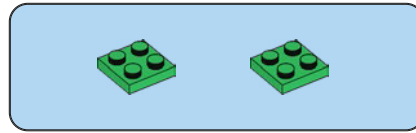
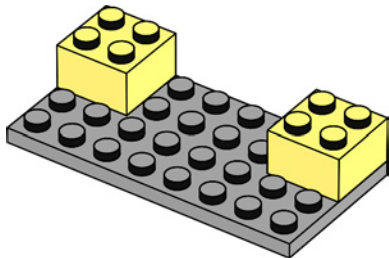

3

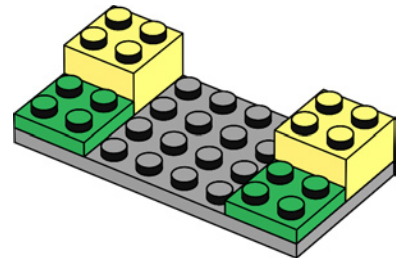

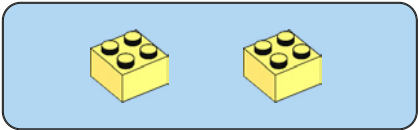

4

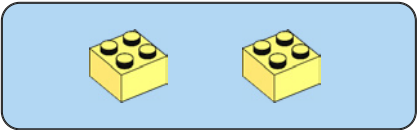
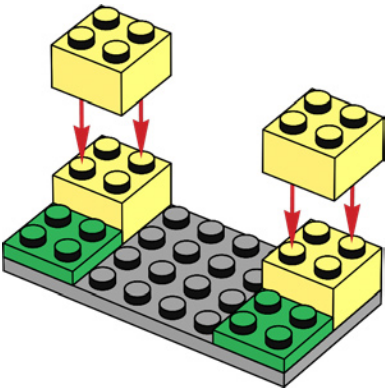

5

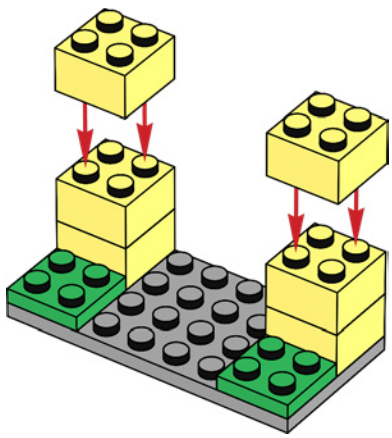

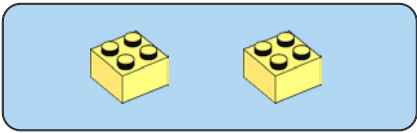

6

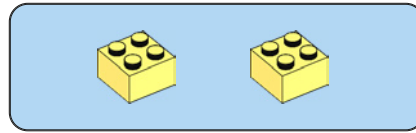
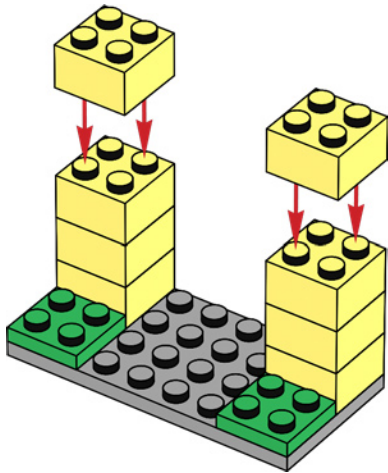

7

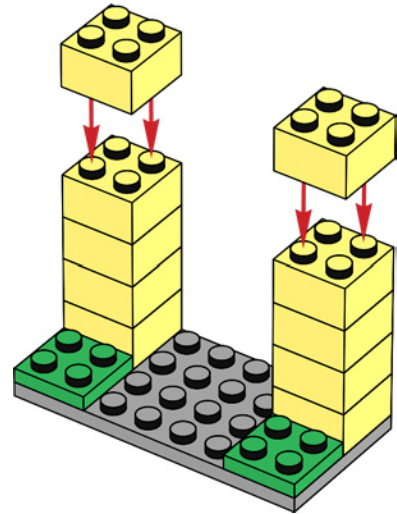

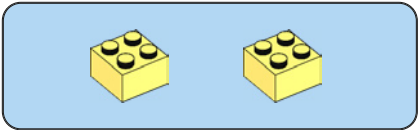

8

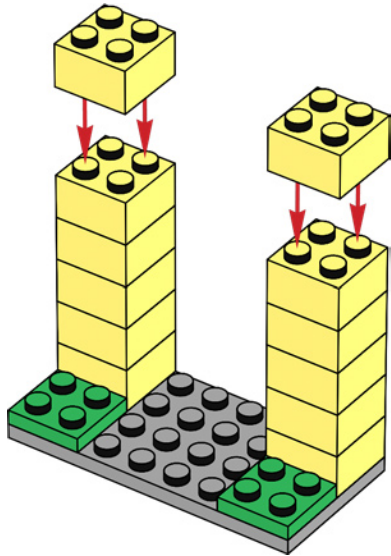

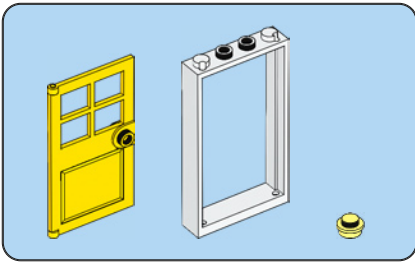

9

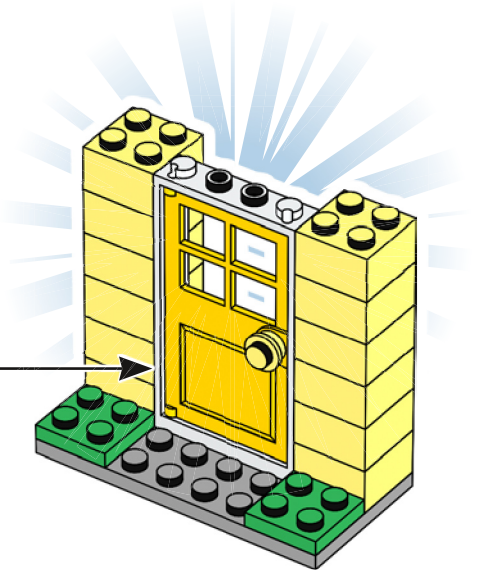
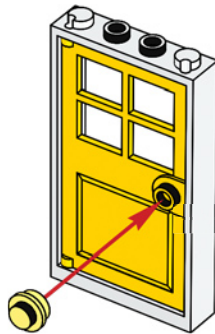
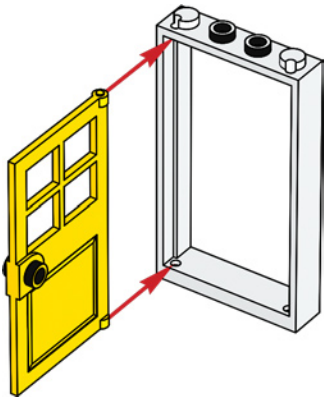

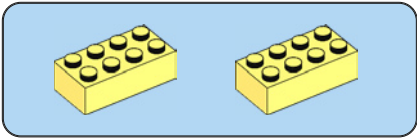

10

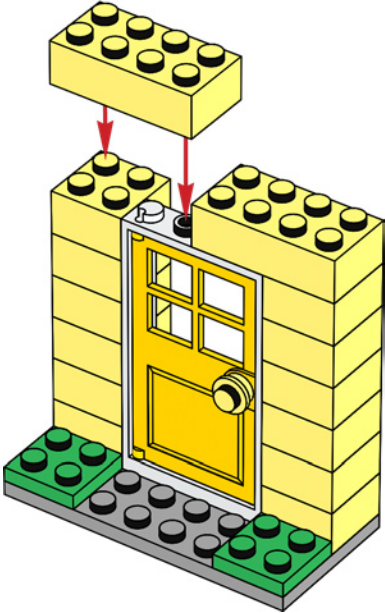

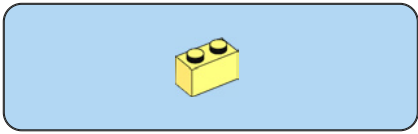

11

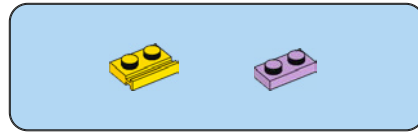
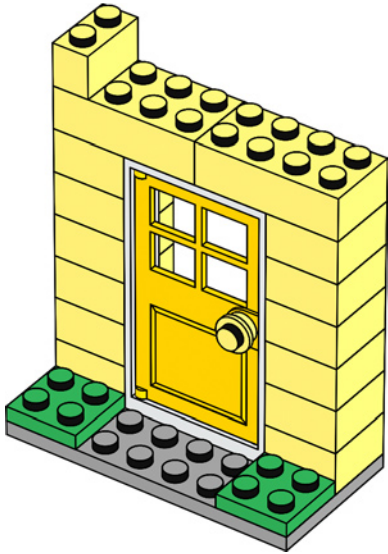

12

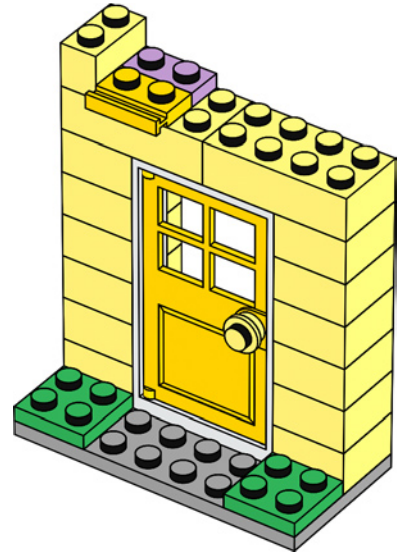



13

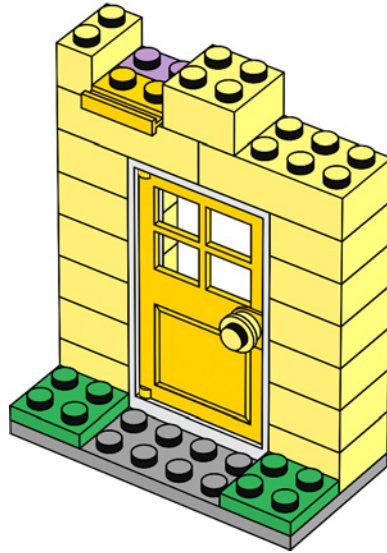

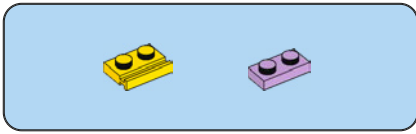

14

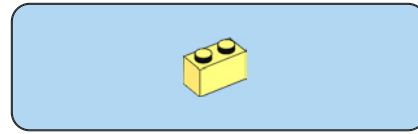
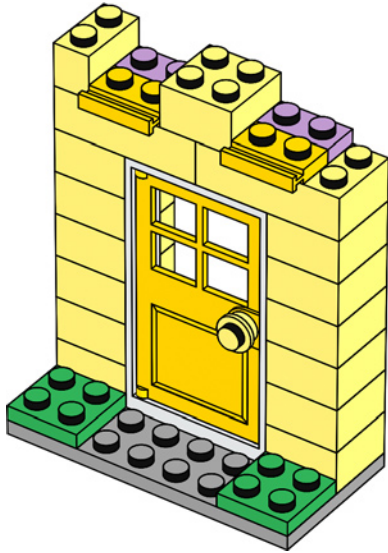

15

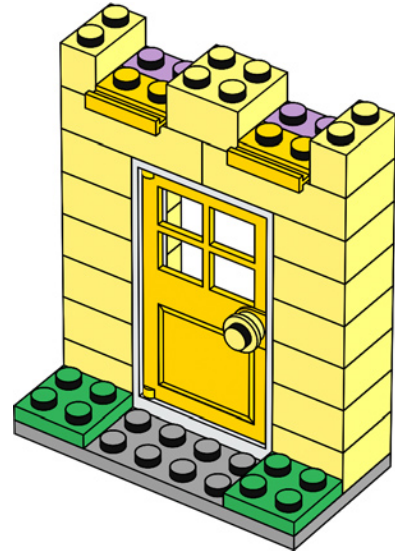

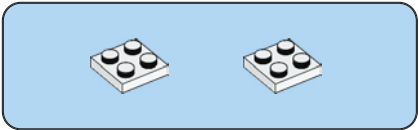

16

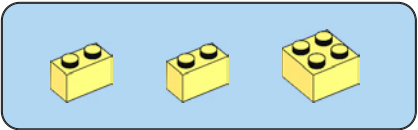
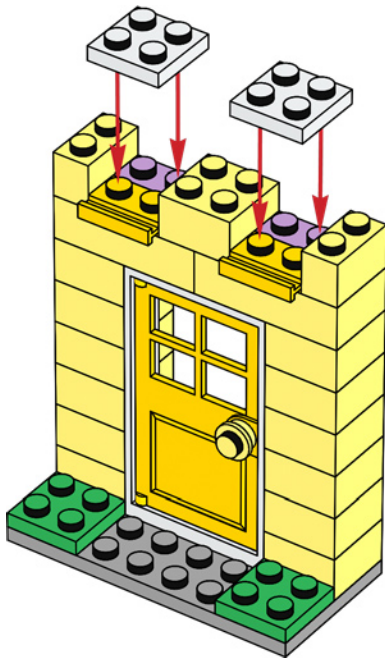

17

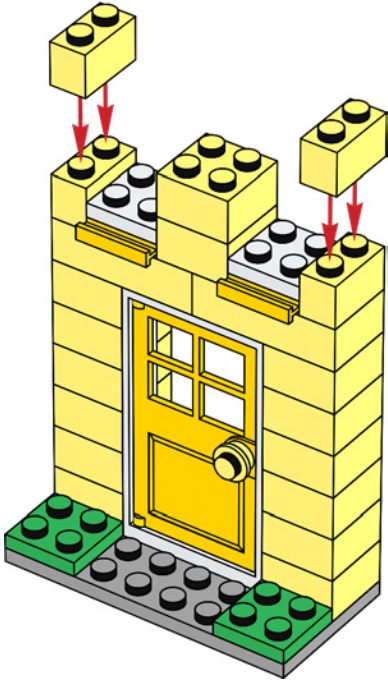

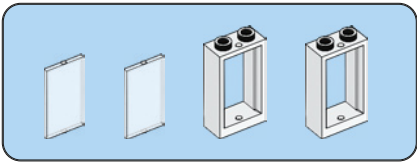

18

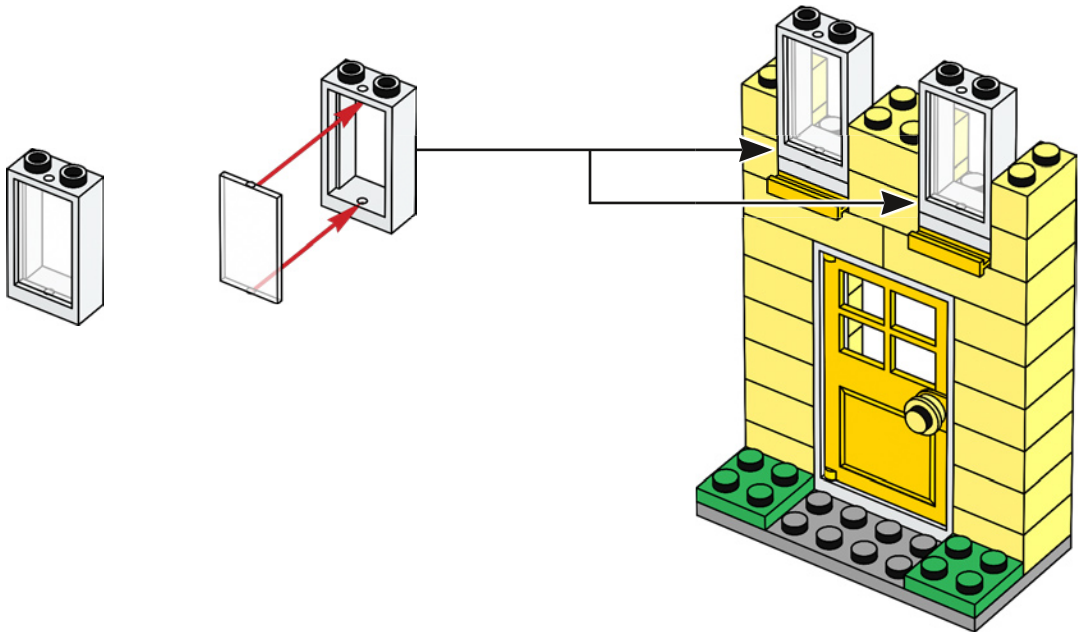

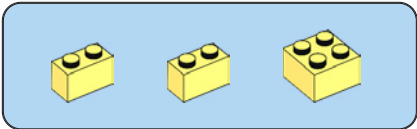

19

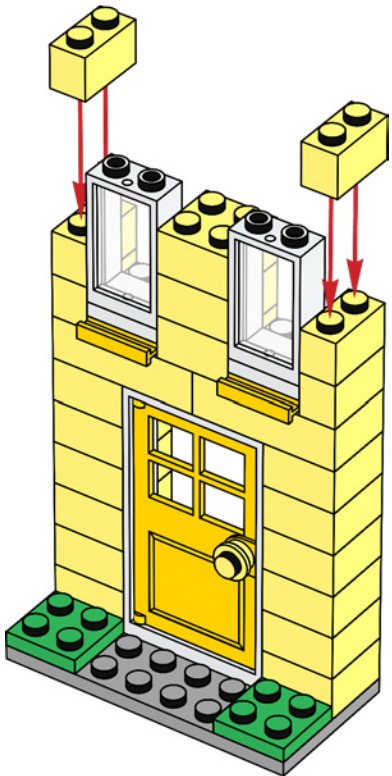

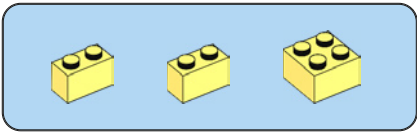

20

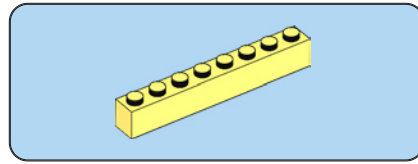
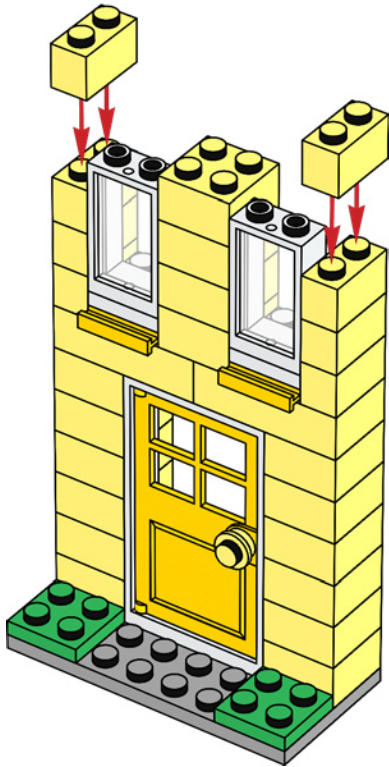

21

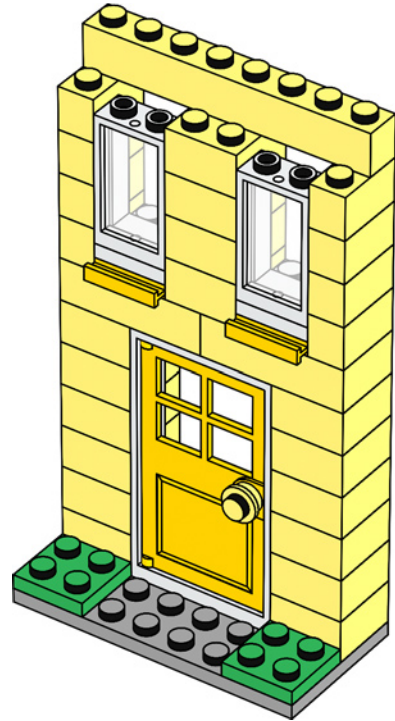

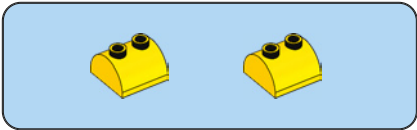

22

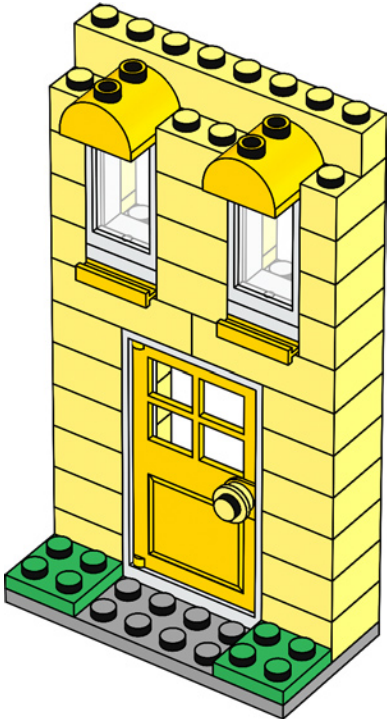

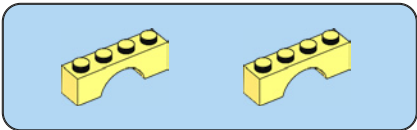

23

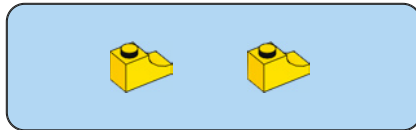
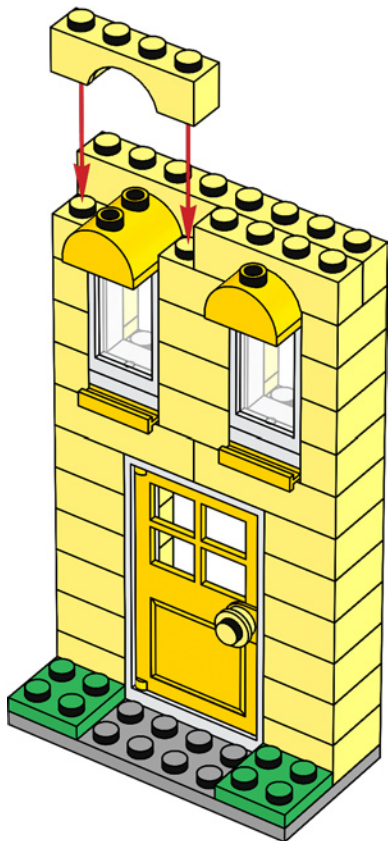

24

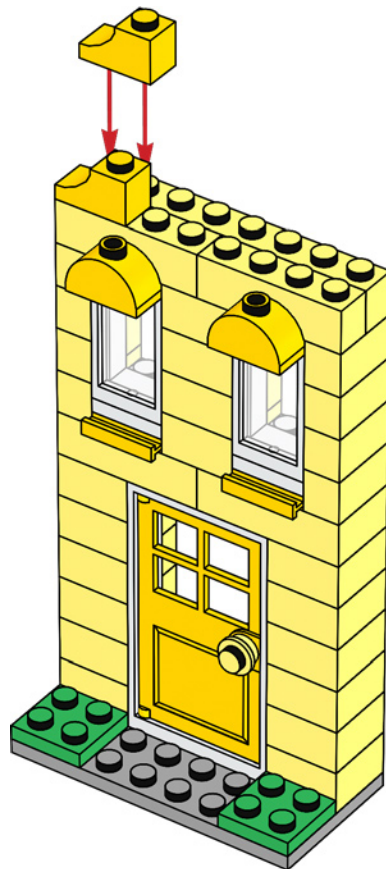

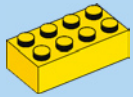

25

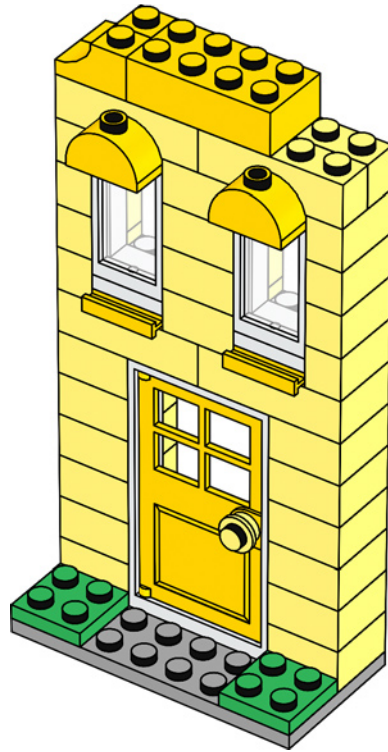

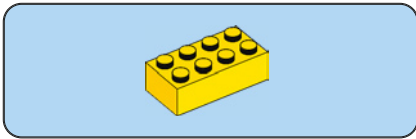

26

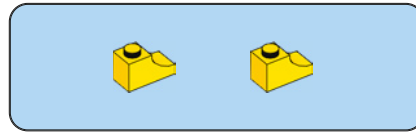
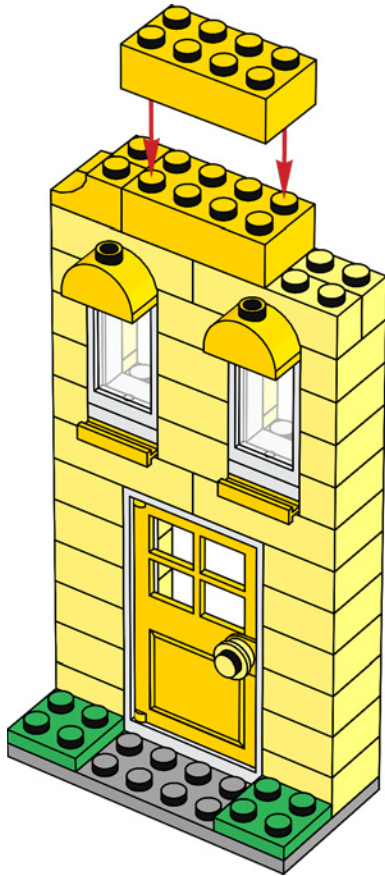

27

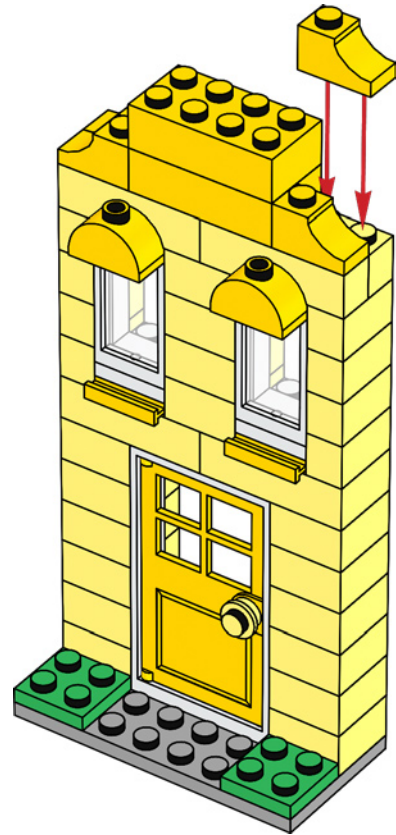

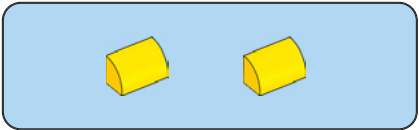

28

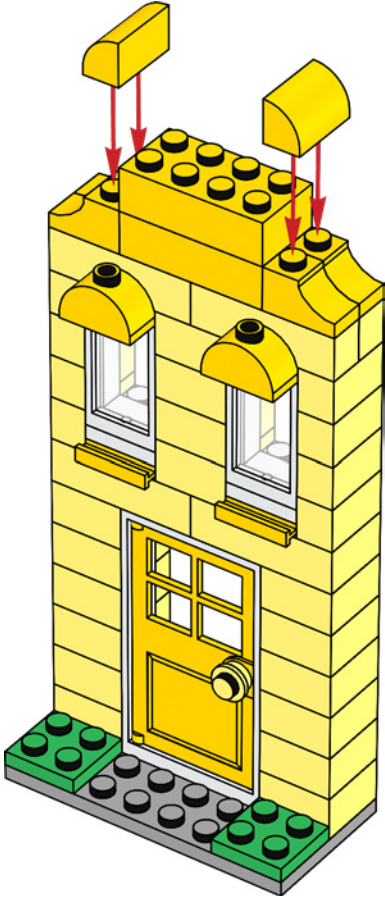

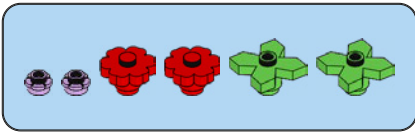

29

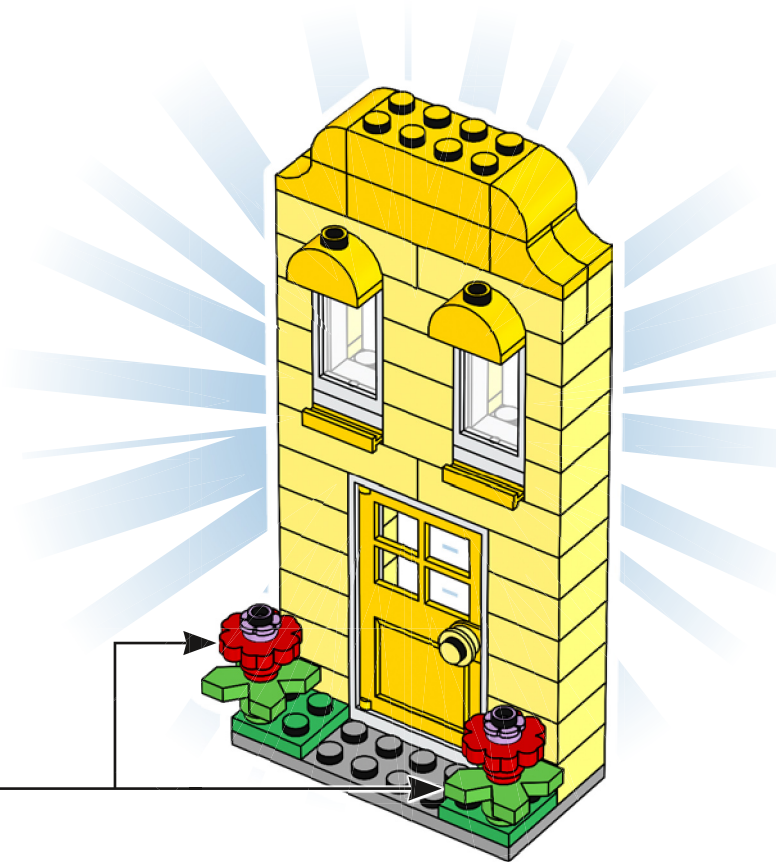
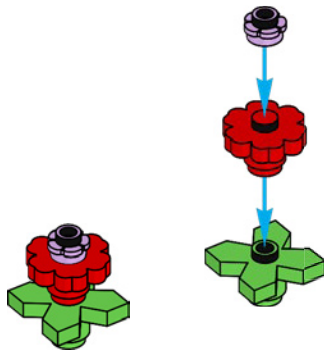

Rebuild

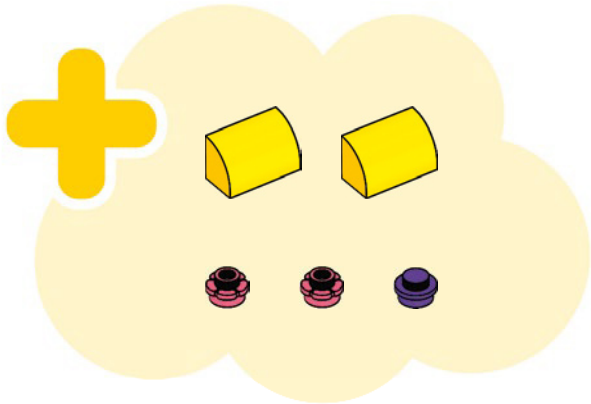
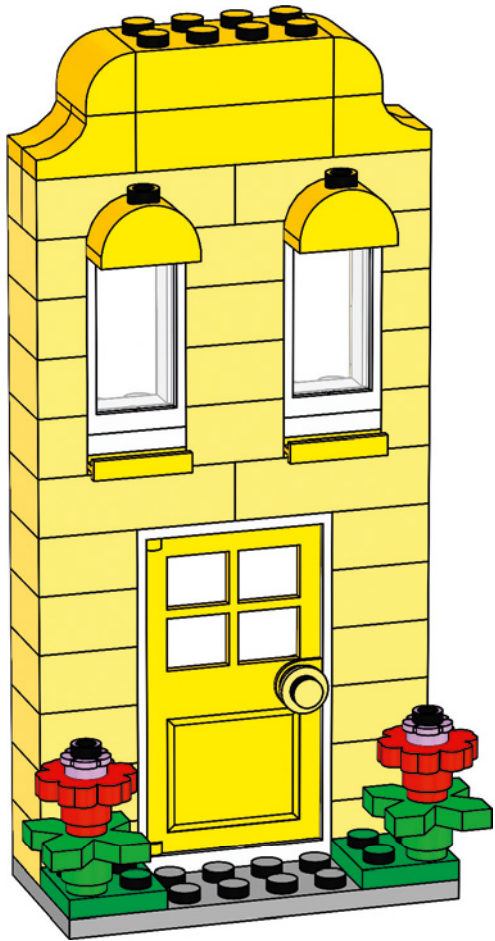

**Reconstruire
Reconstruye**

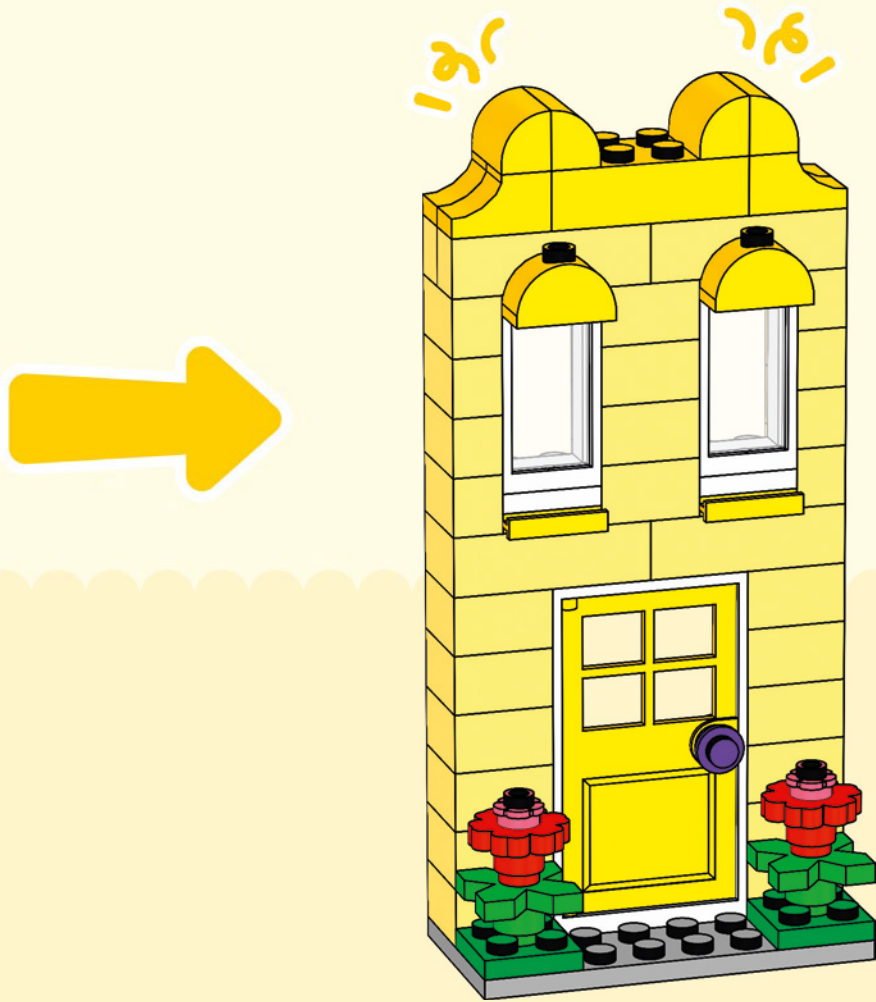

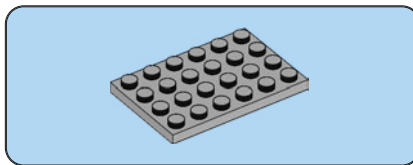

1

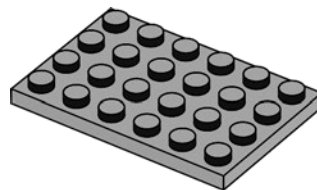

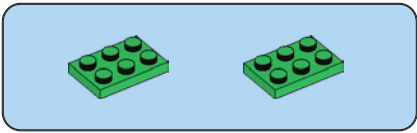

2

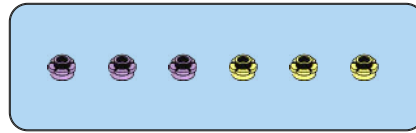
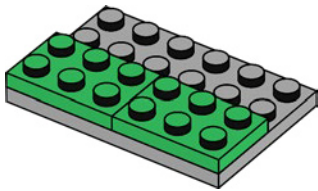

3

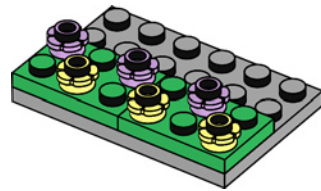

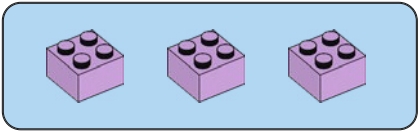

4

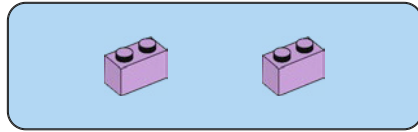
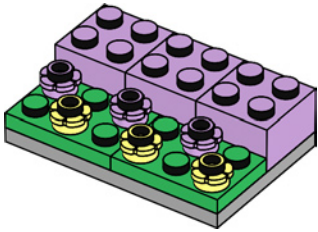

5

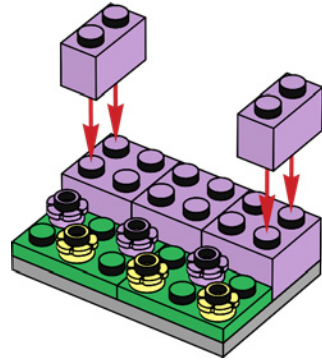

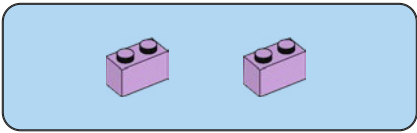

6

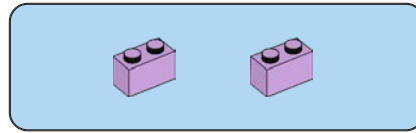
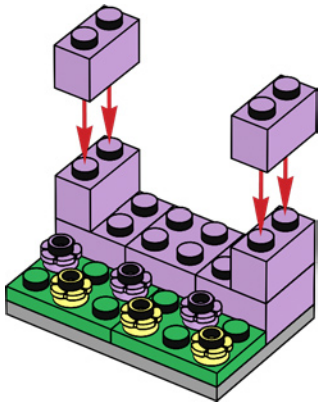

7

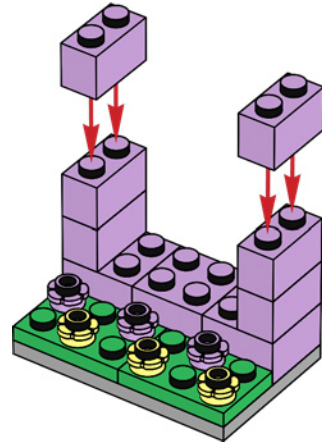

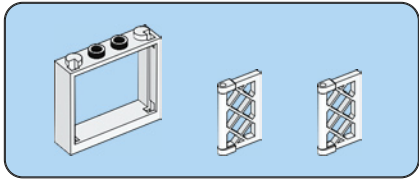

8

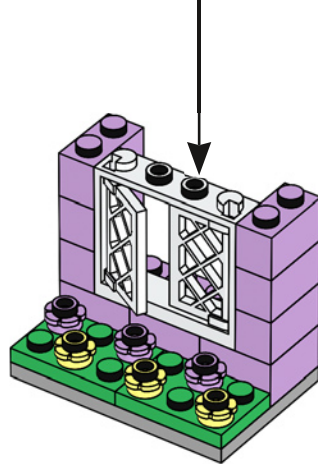
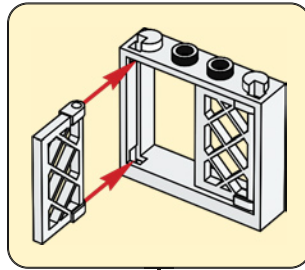

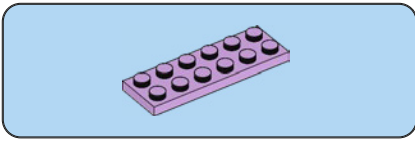

9

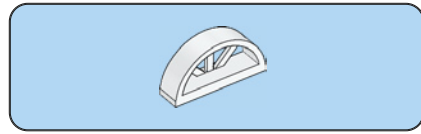
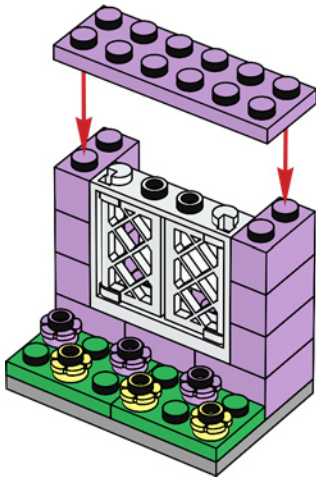

10

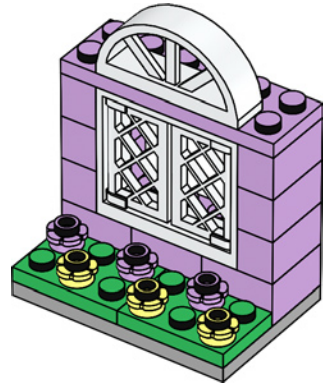

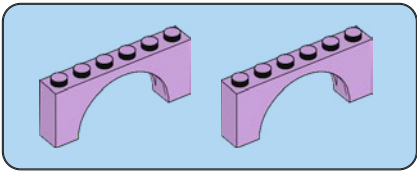

11

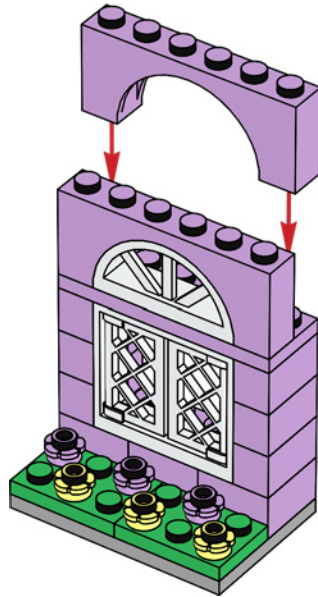

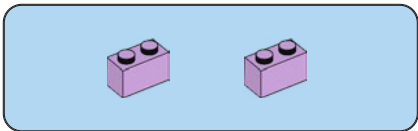

12

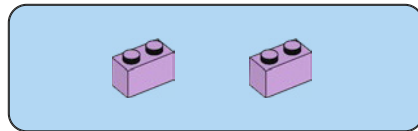
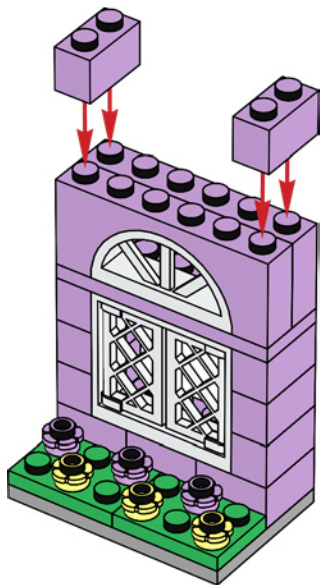

13

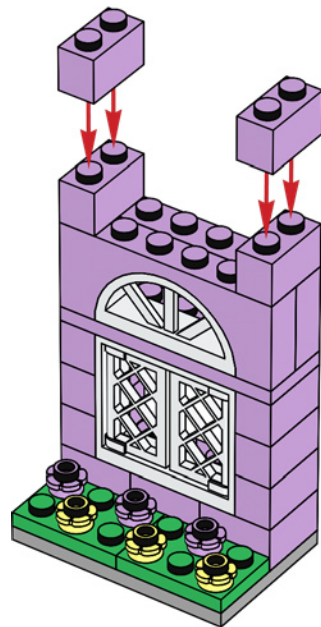

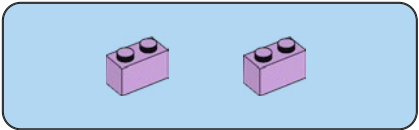

14

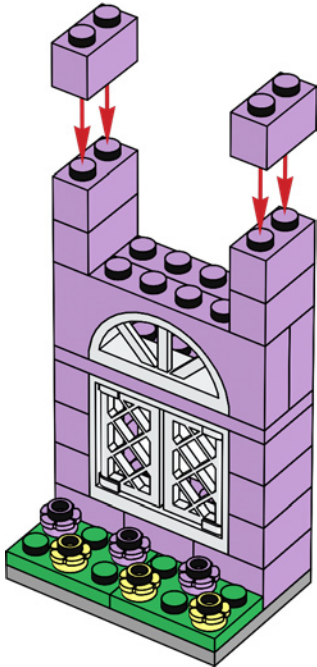

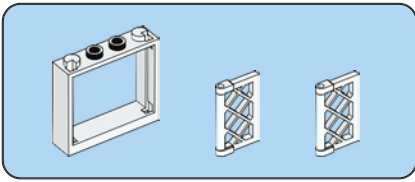

15

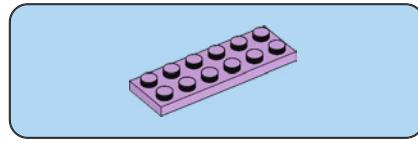
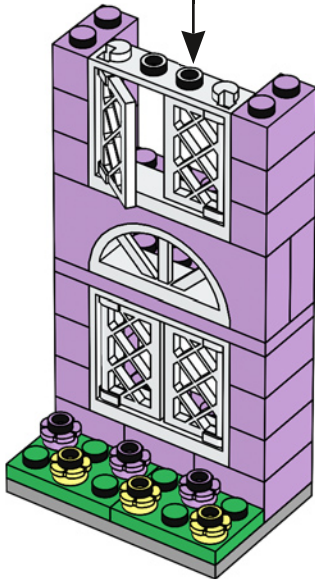
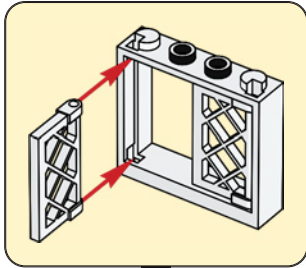

16

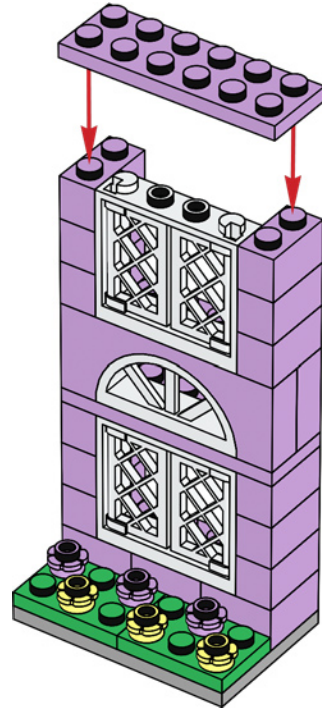

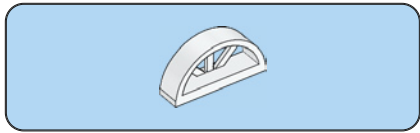

17

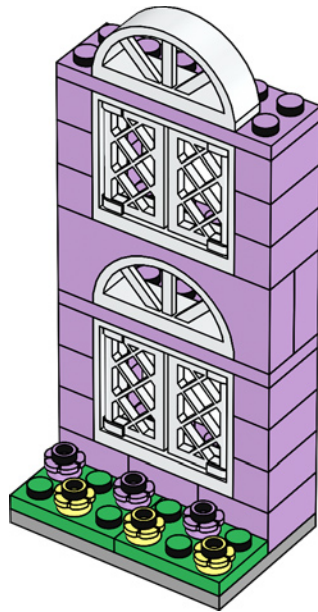

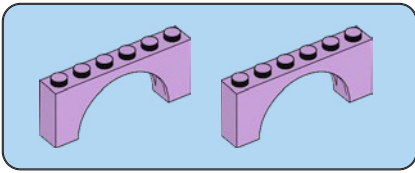

18

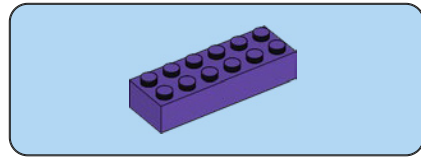
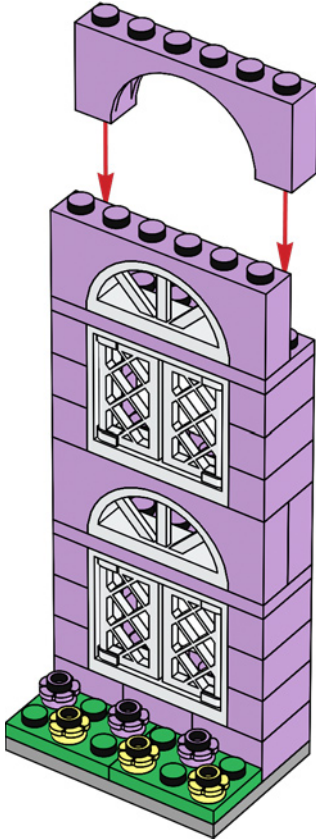

19

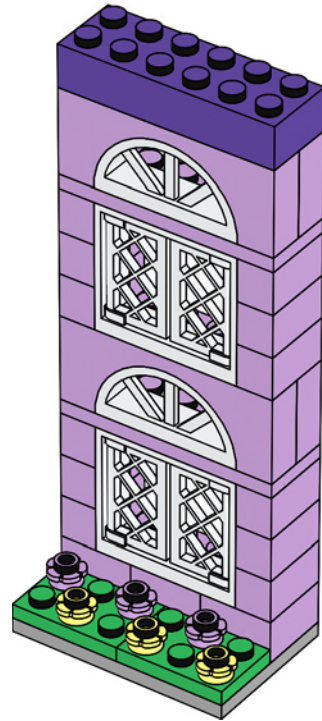

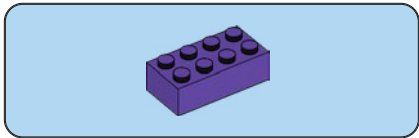

20

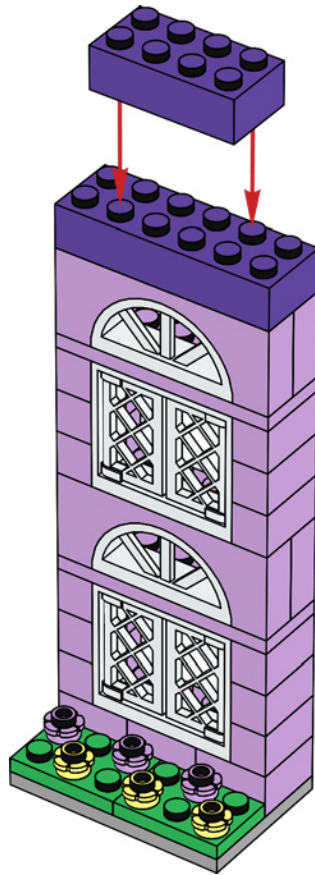

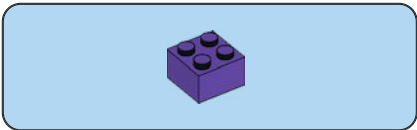

21

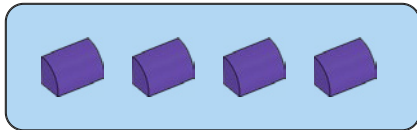
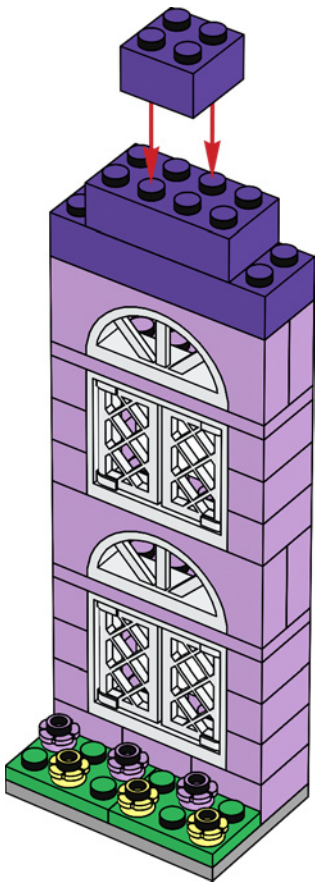

22

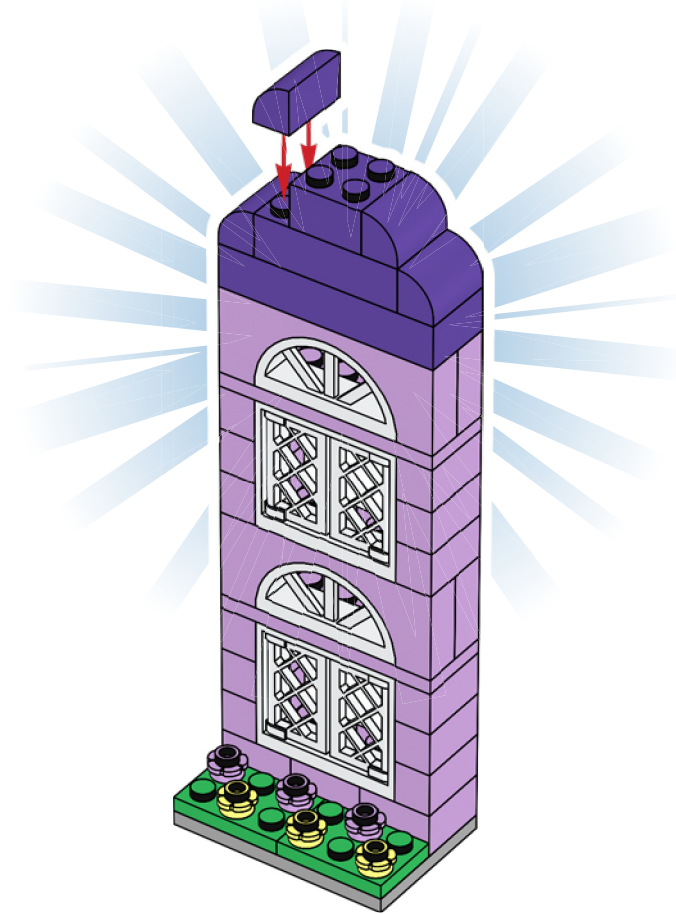

Rebuild

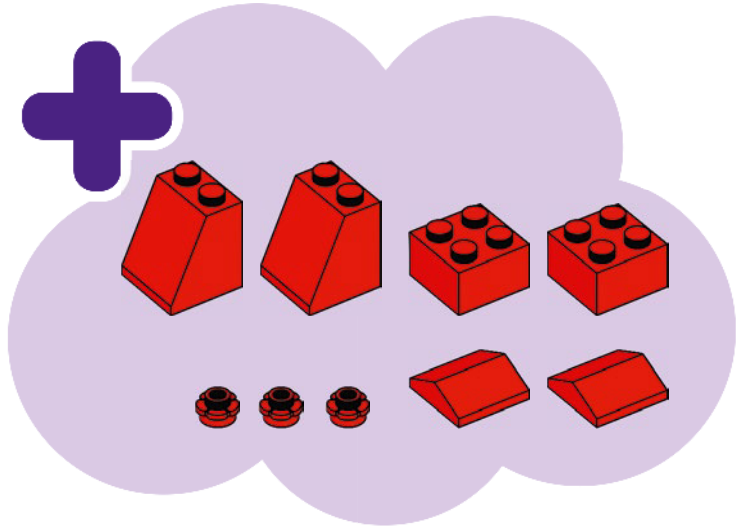
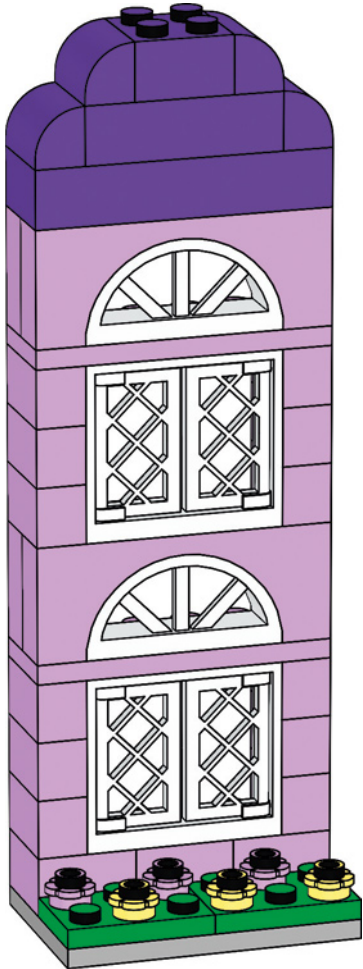

**Reconstruire
Reconstruye**



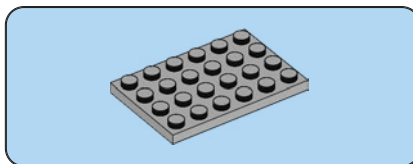
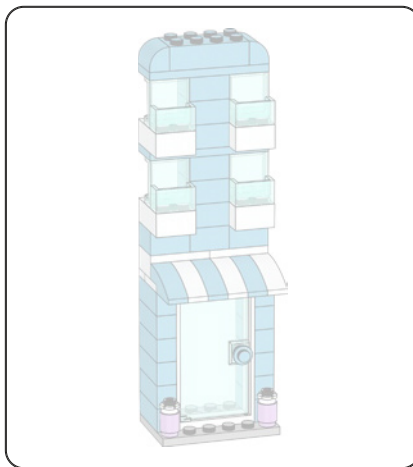

1

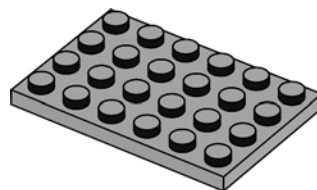

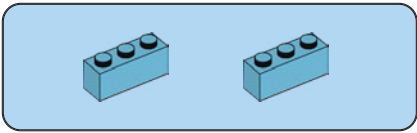

2

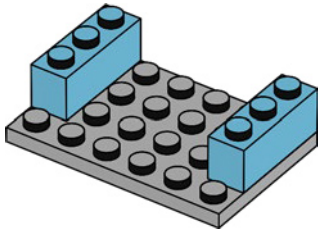

3

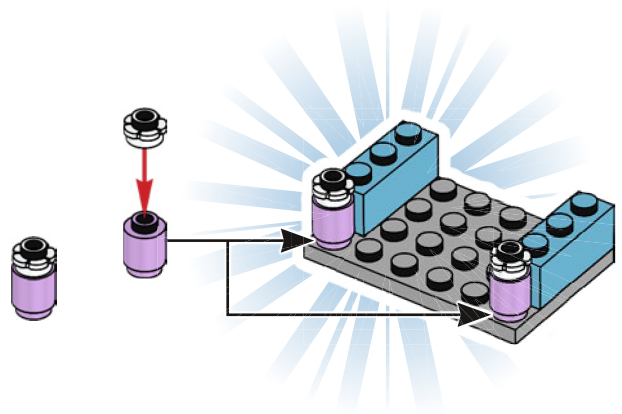

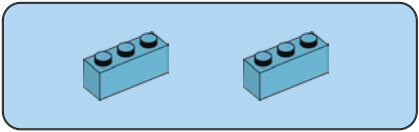

4

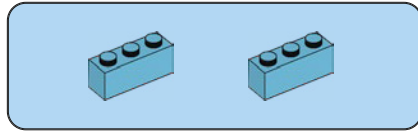
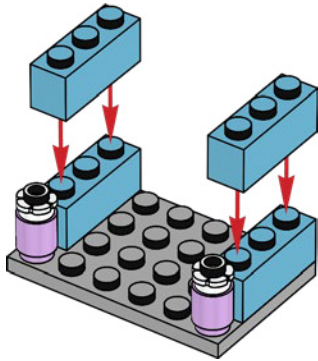

5

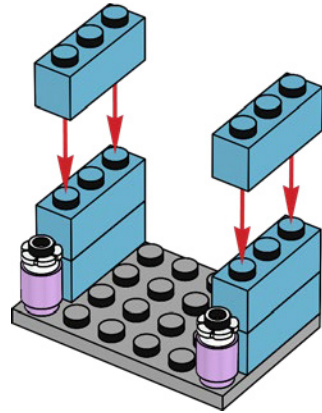

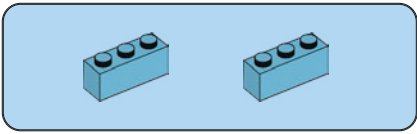

6

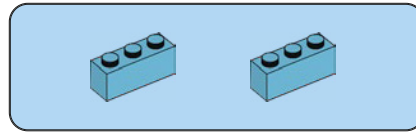
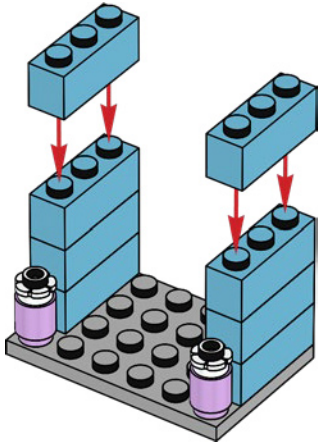

7

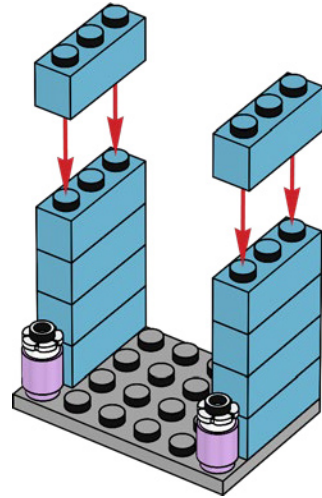

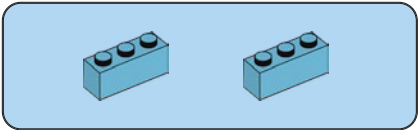

8

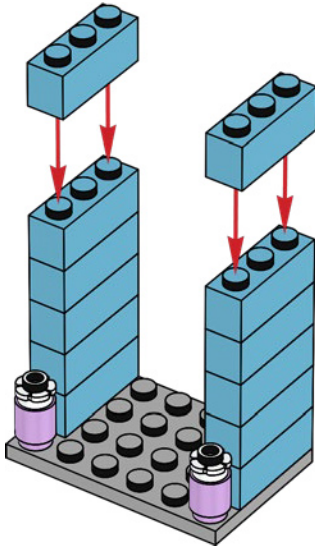

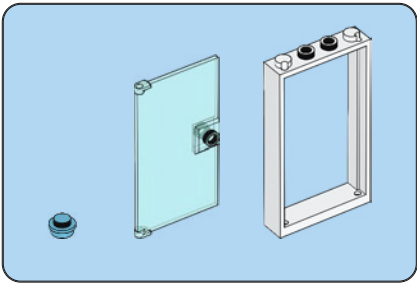

9

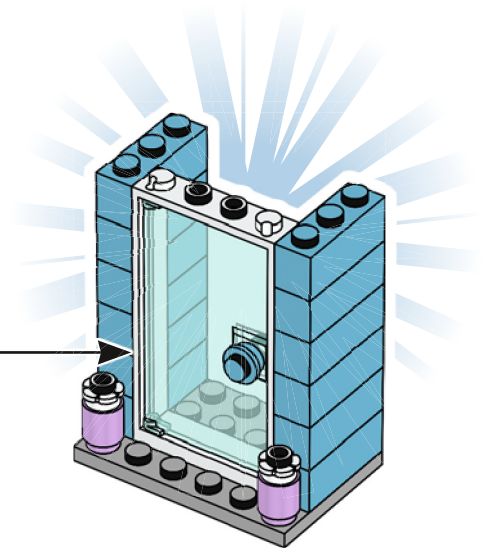
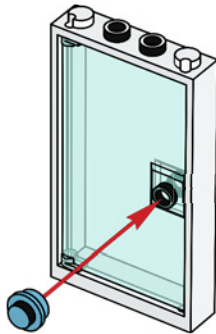
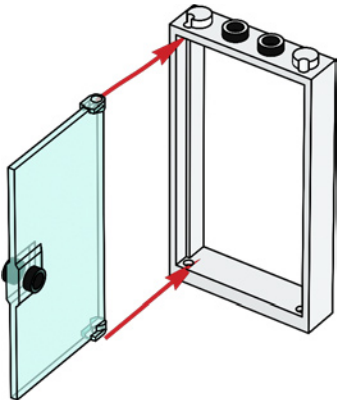

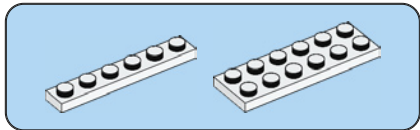

10

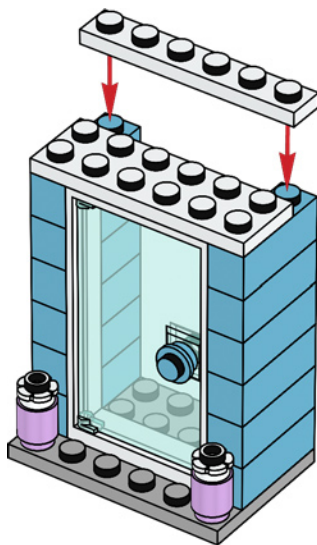

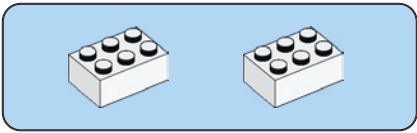

11

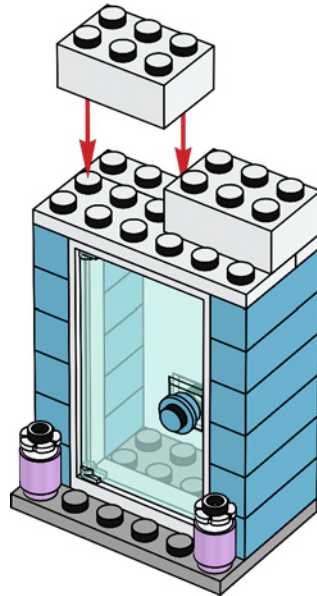

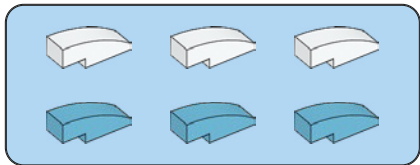

12

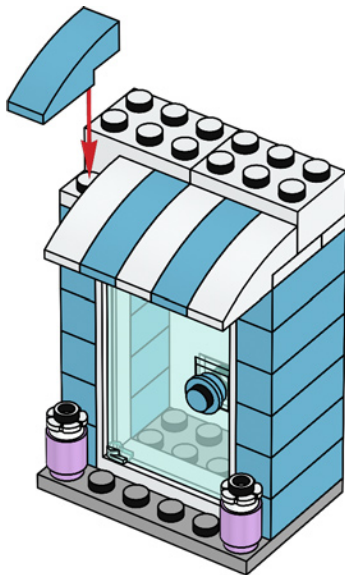

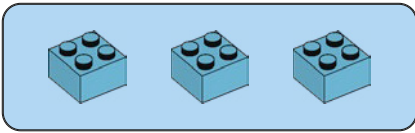

13

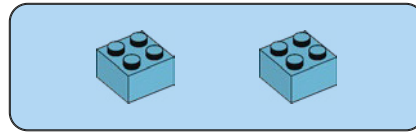
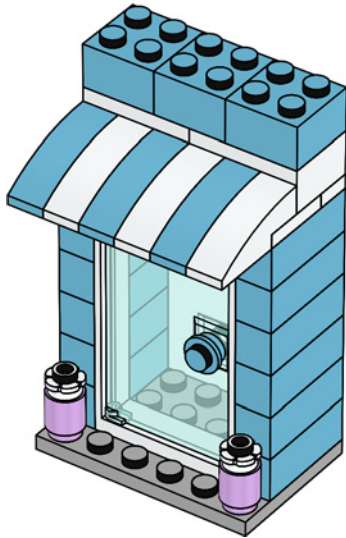

14

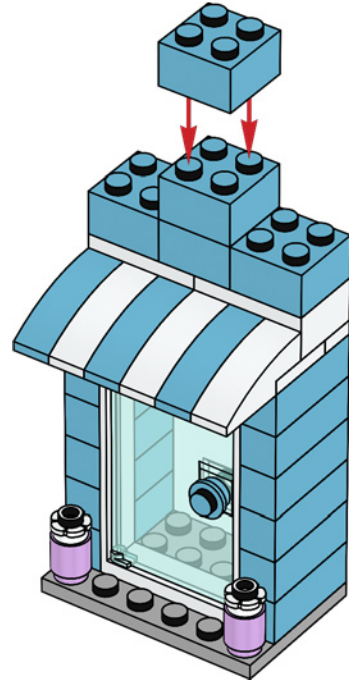

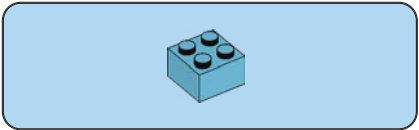

15

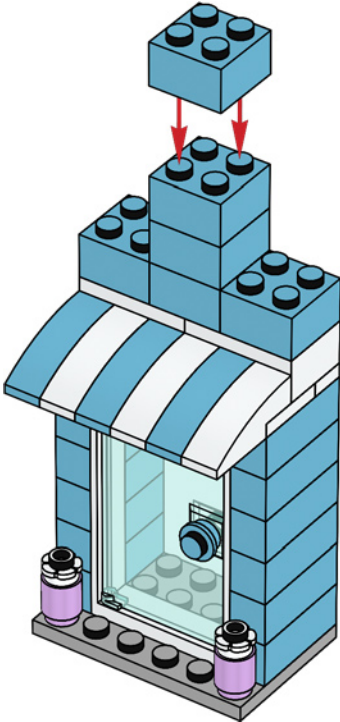

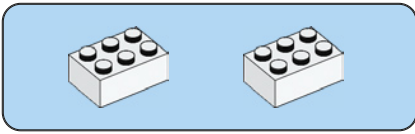

16

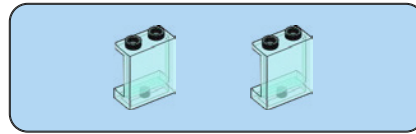
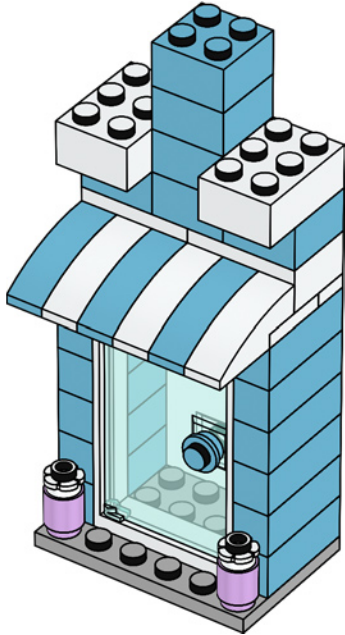

17

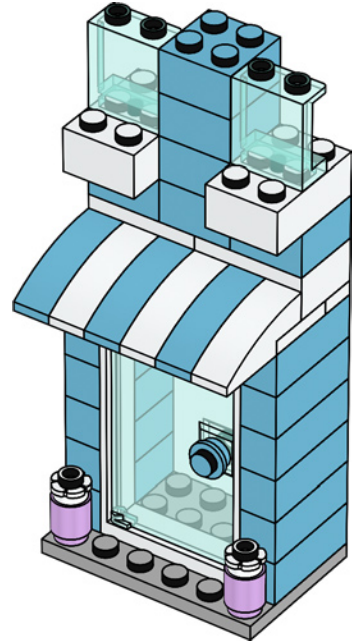

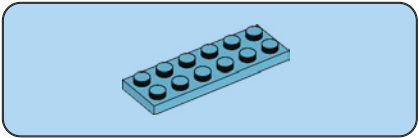

18

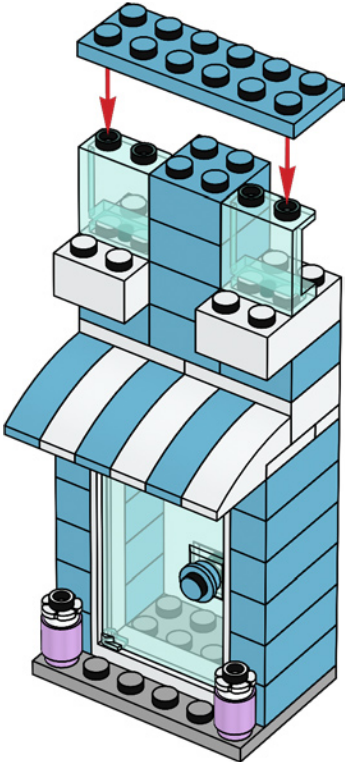

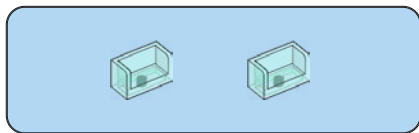

19

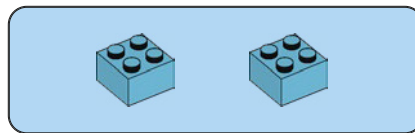
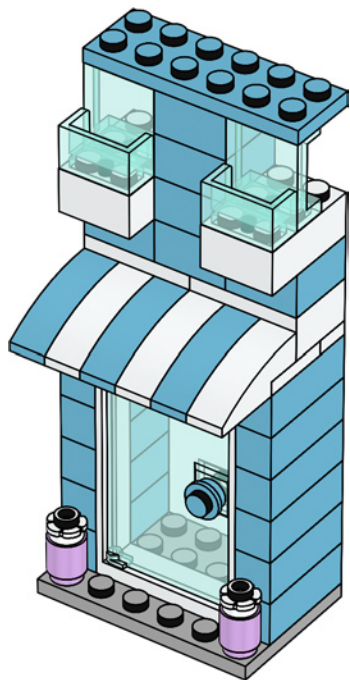

20

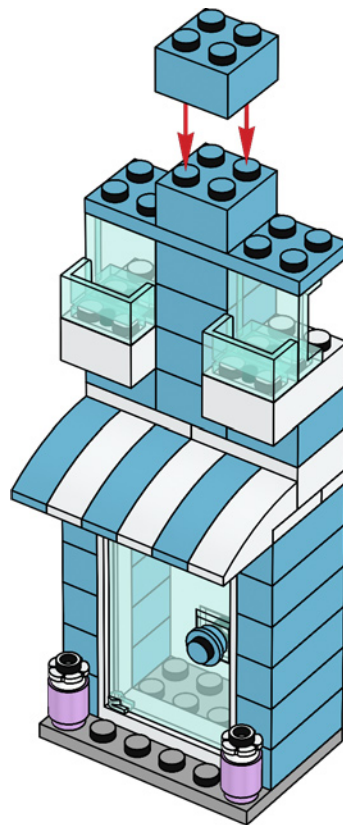



21

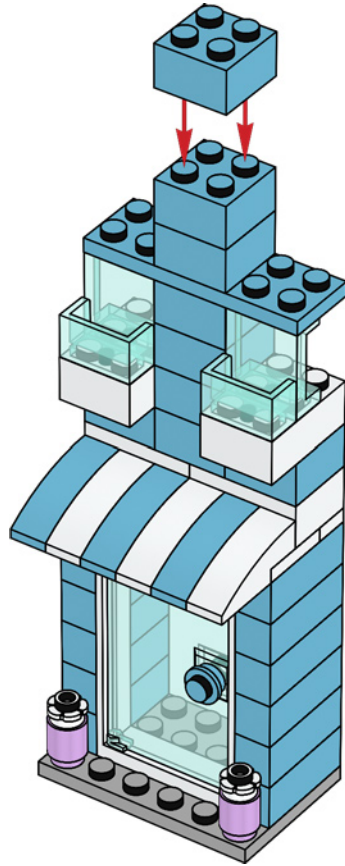

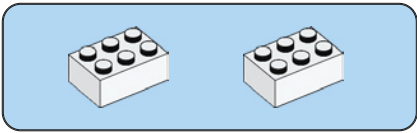

22

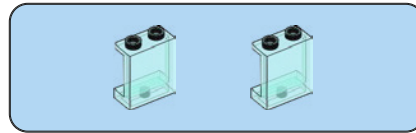
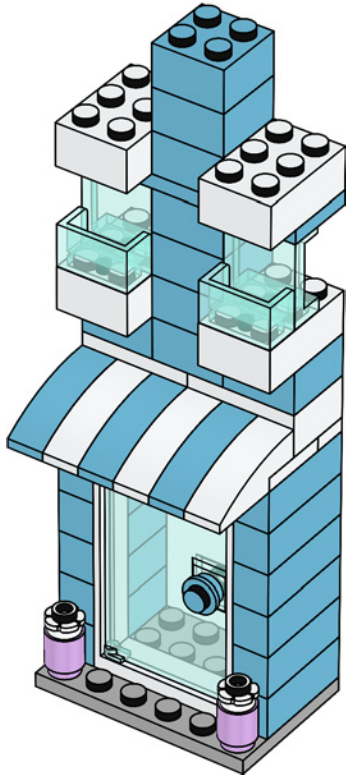

23

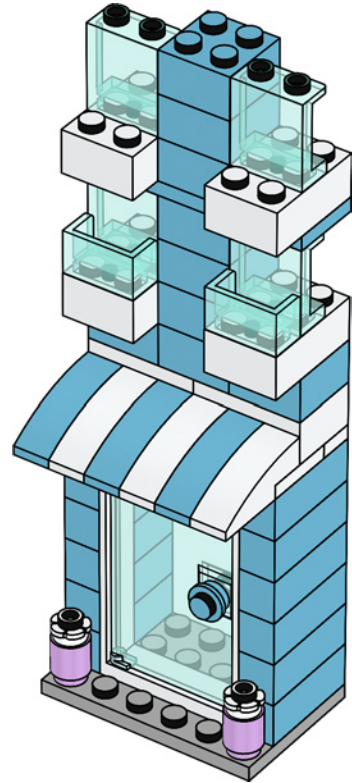

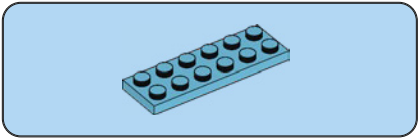

24

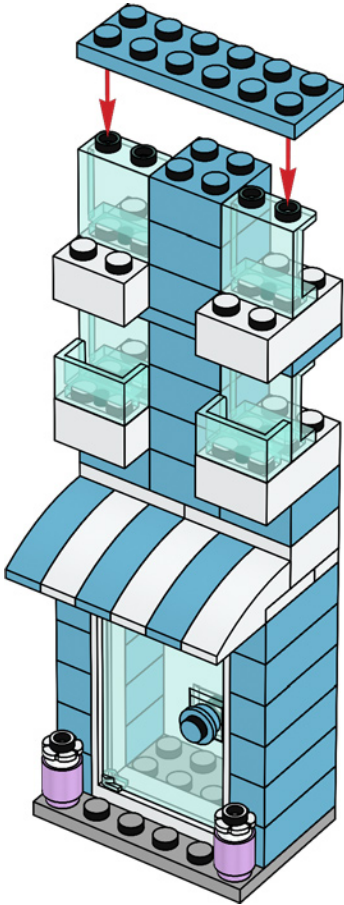

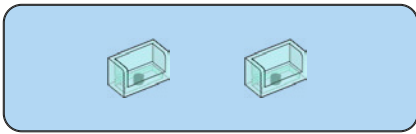

25

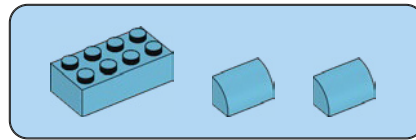
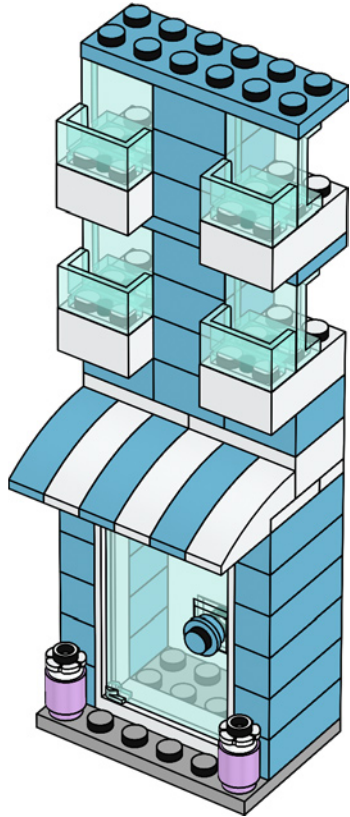

26

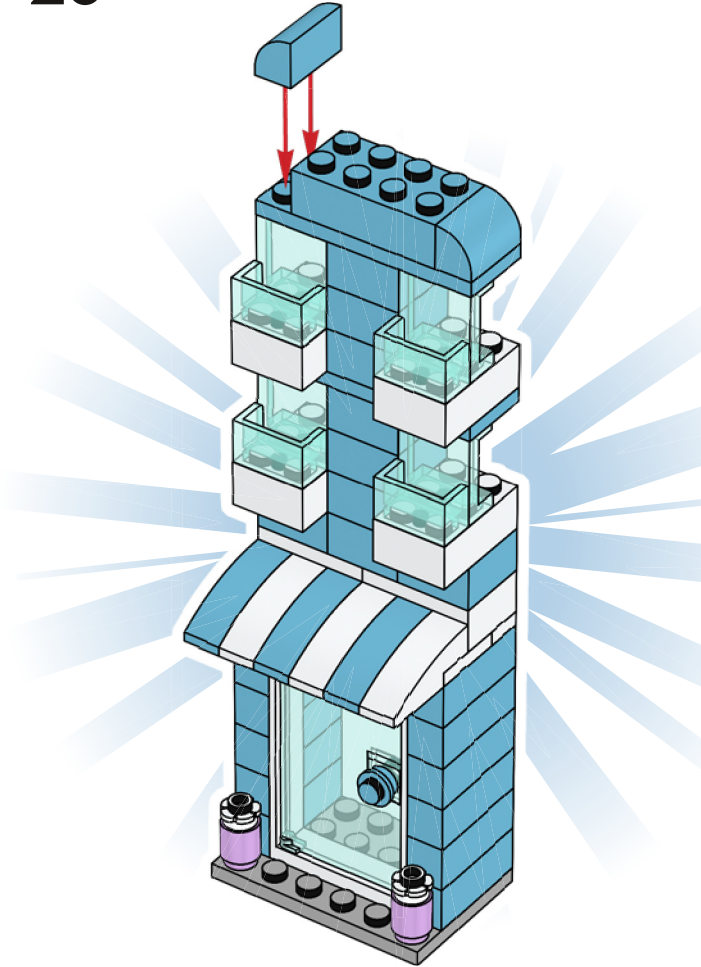

Rebuild

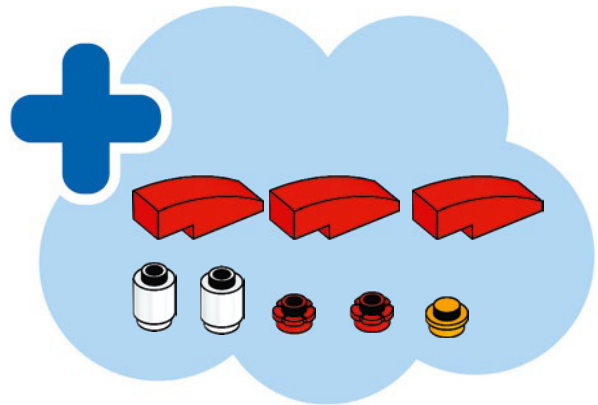
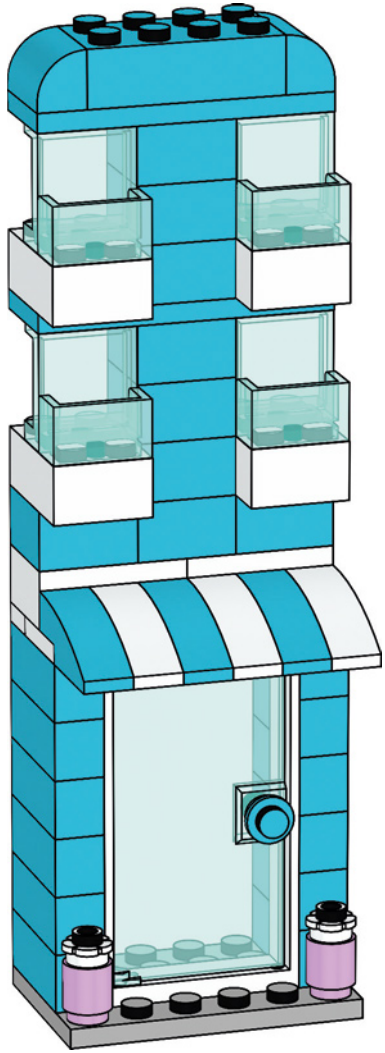

**Reconstruire
Reconstruye**

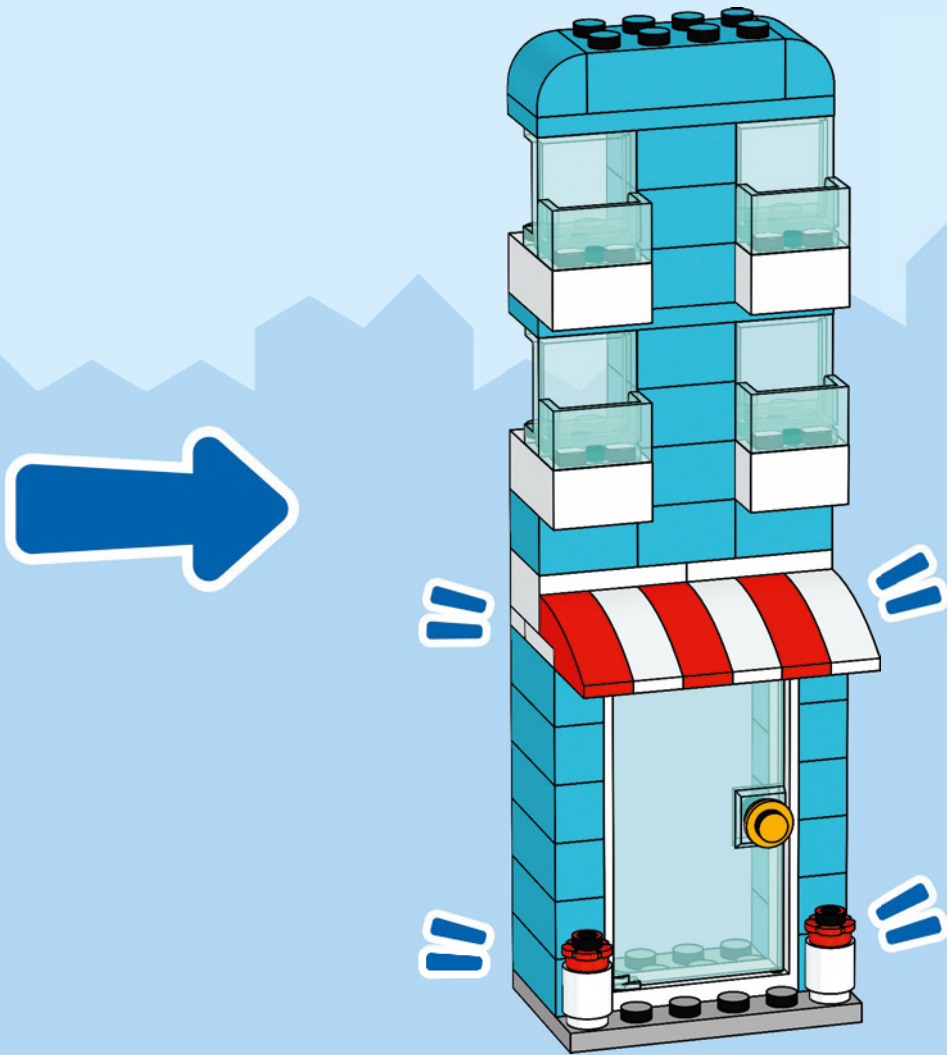

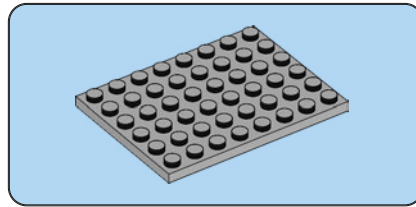
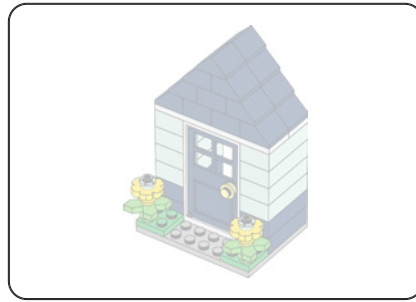

1

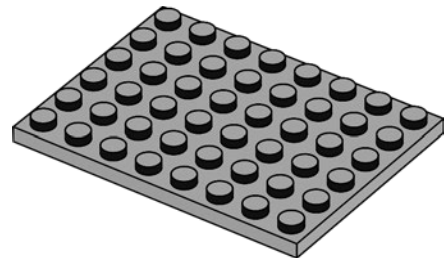

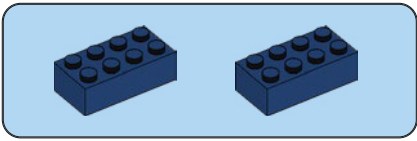

2

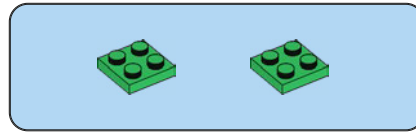
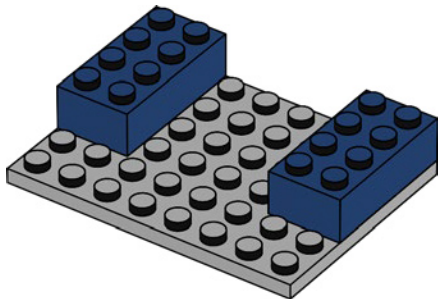

3

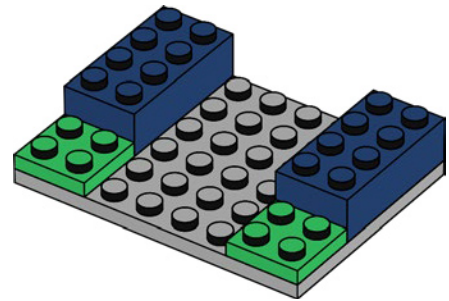

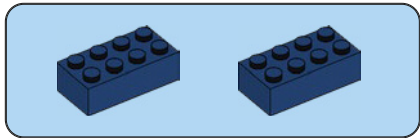

4

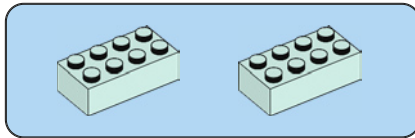
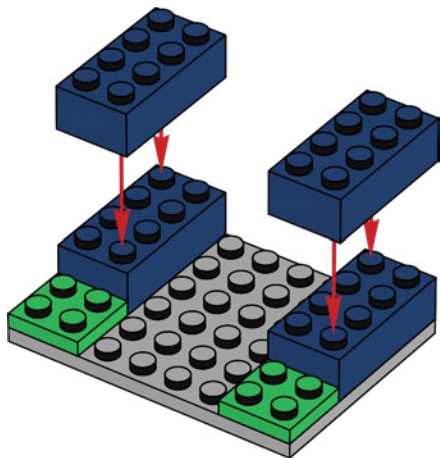

5

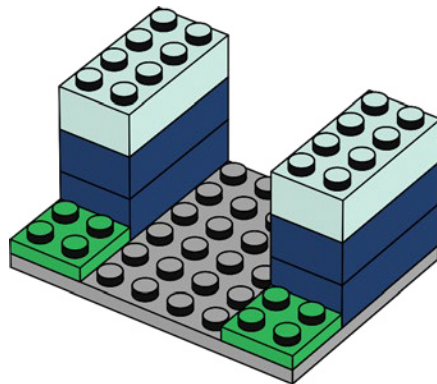

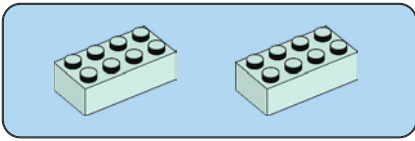

6

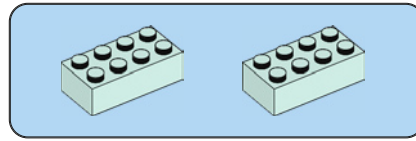
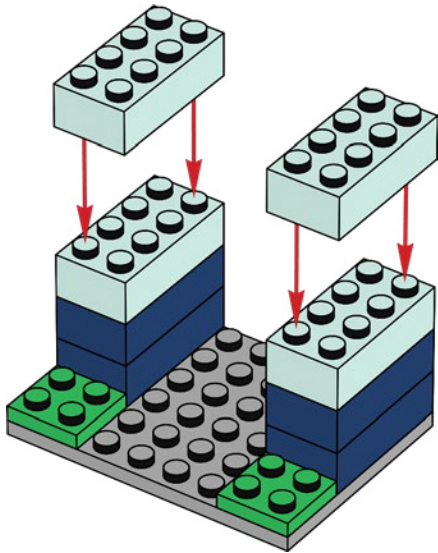

7

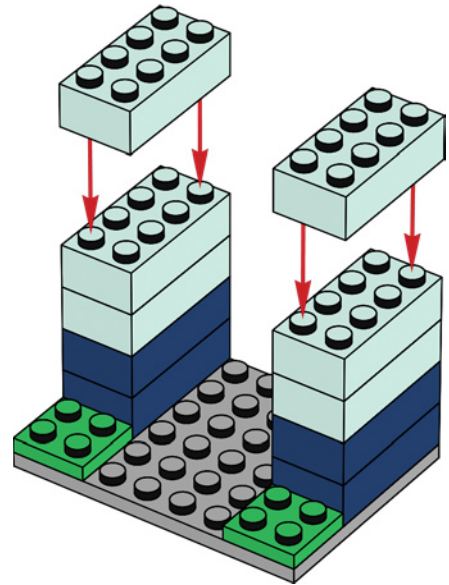

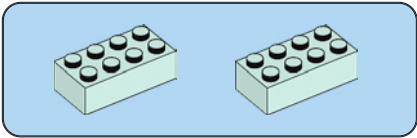

8

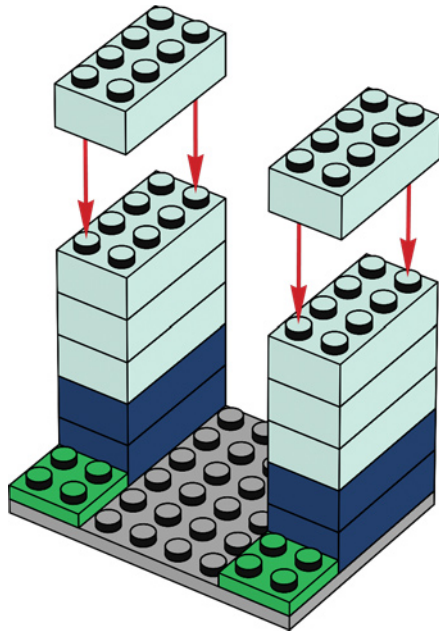

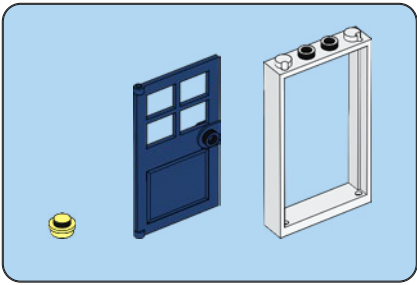

9

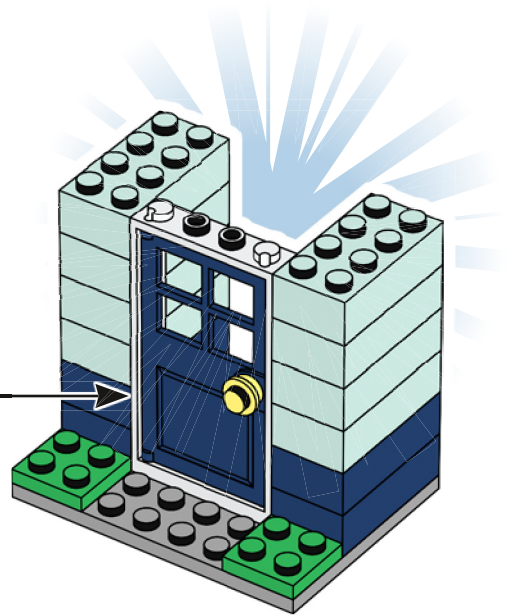
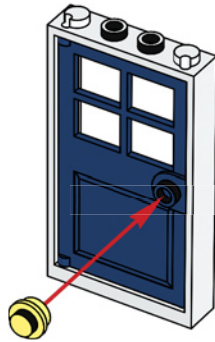
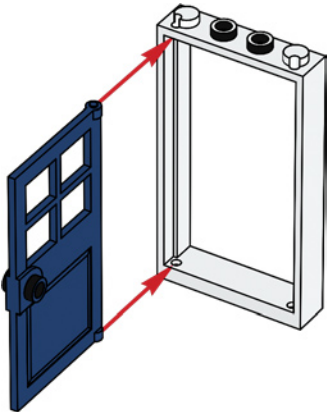

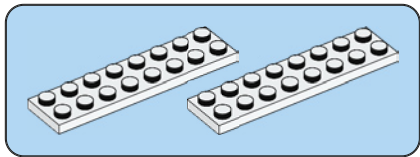

10

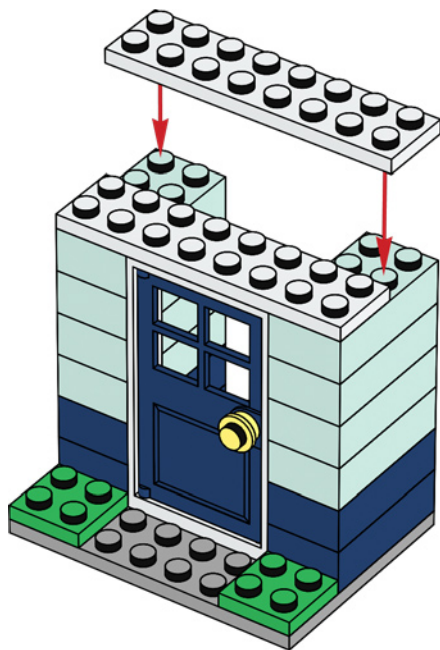

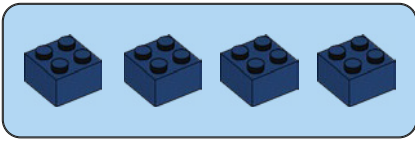

11

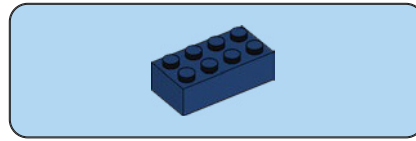
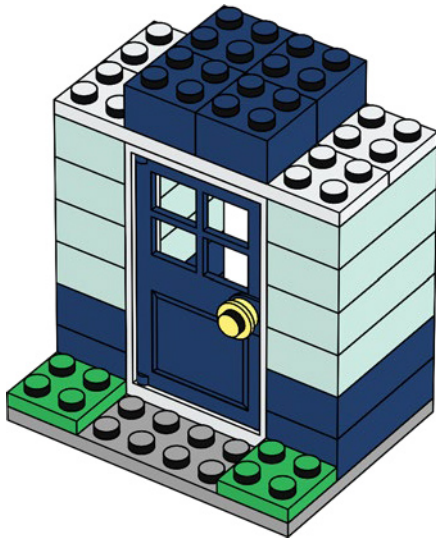

12

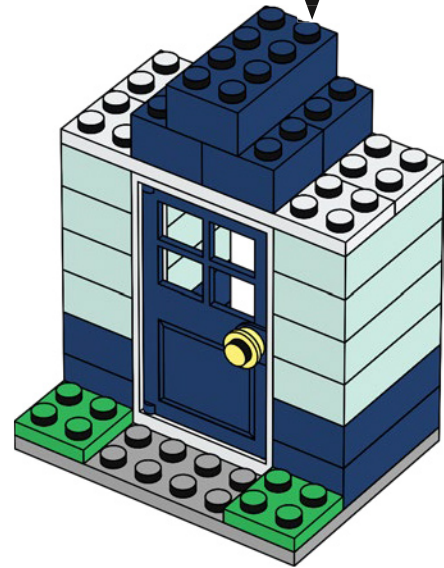
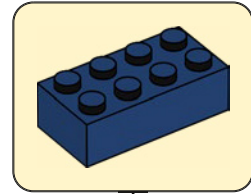

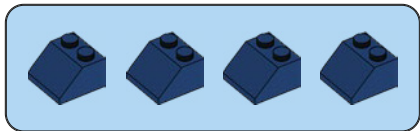

13

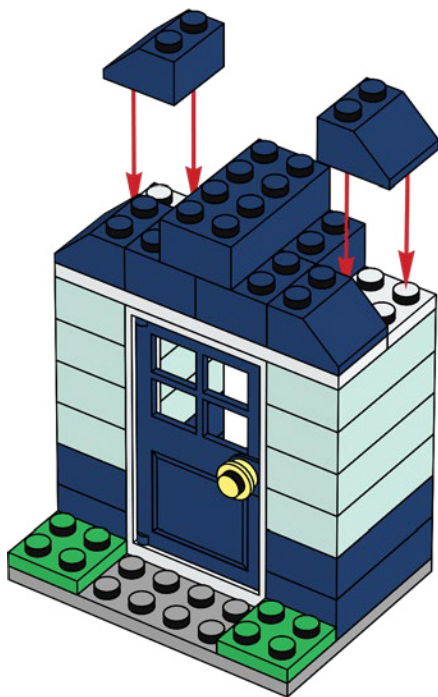

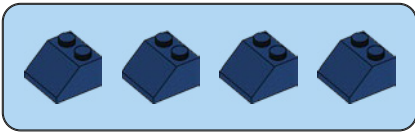

14

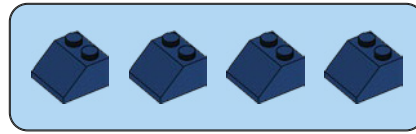
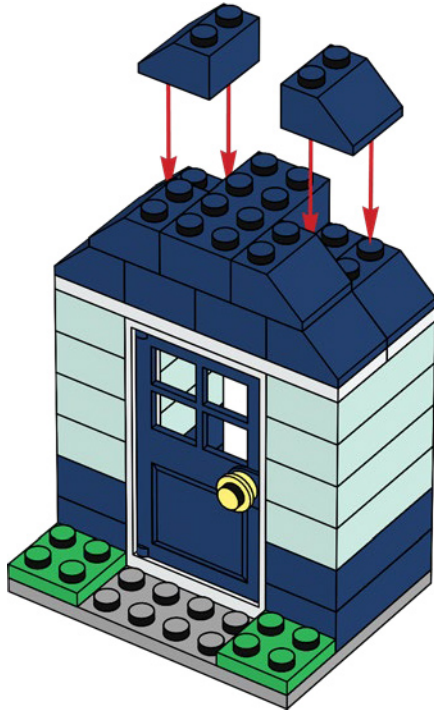

15

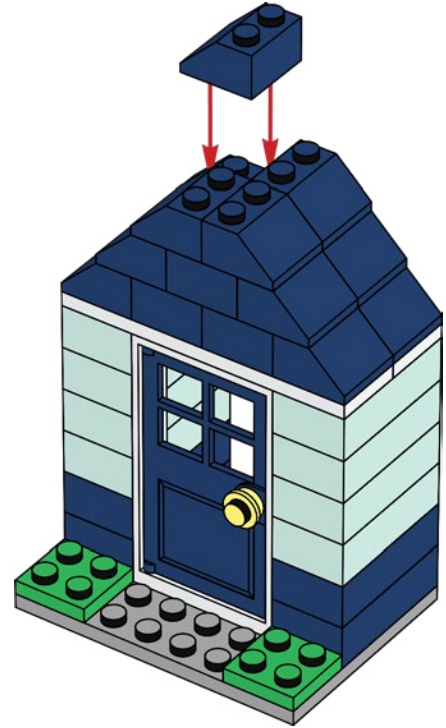

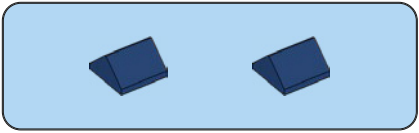

16

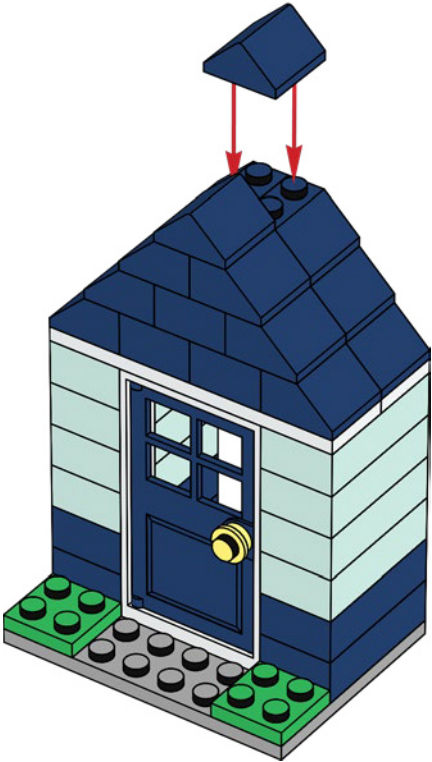

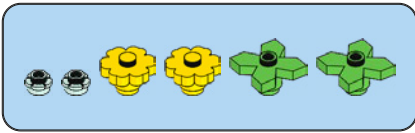

17

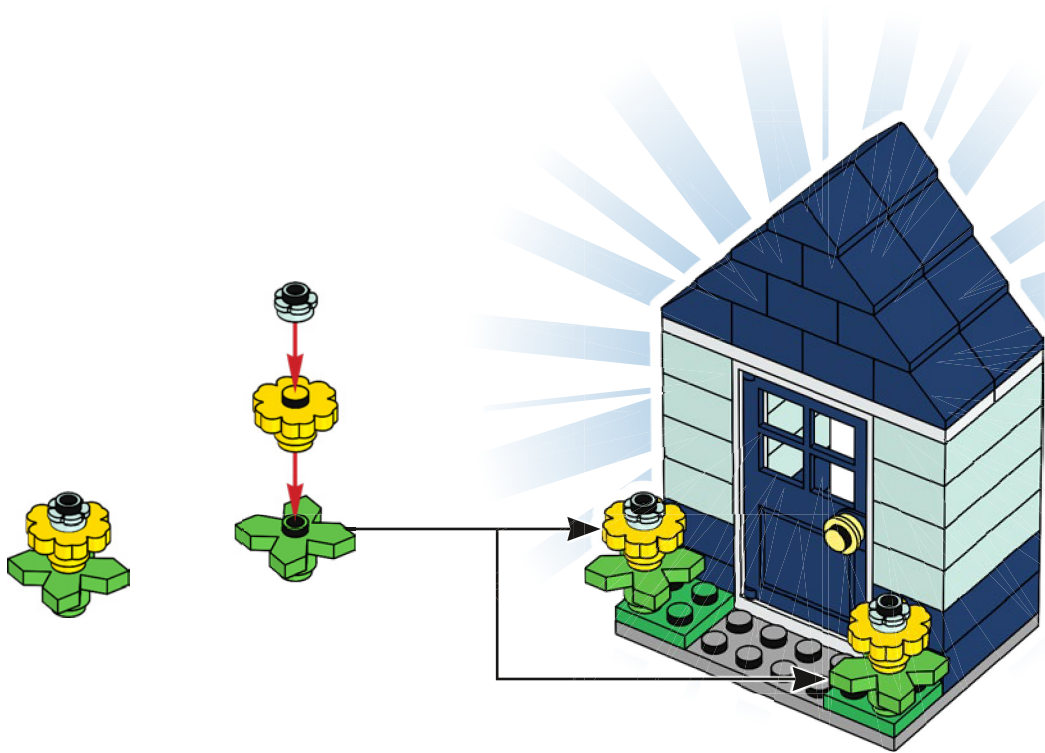

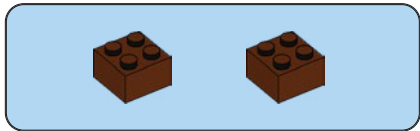
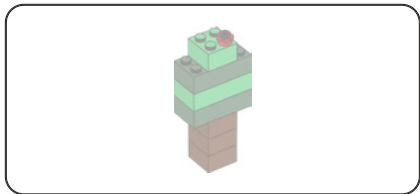

18

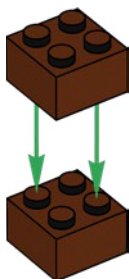

19

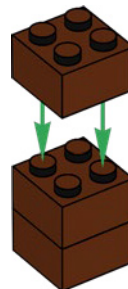

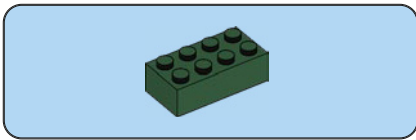

20

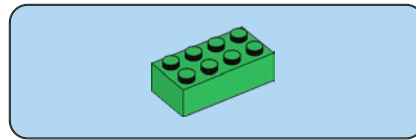
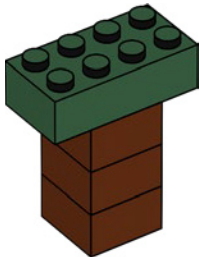

21

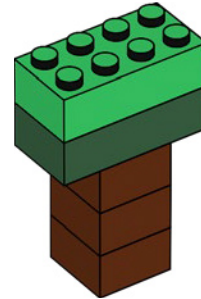

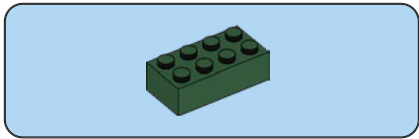

22

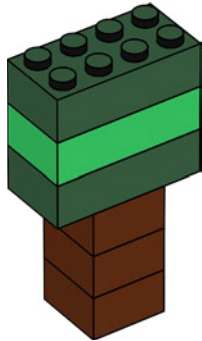

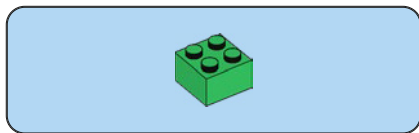

23

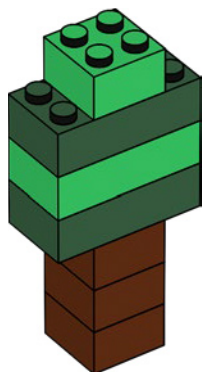

24

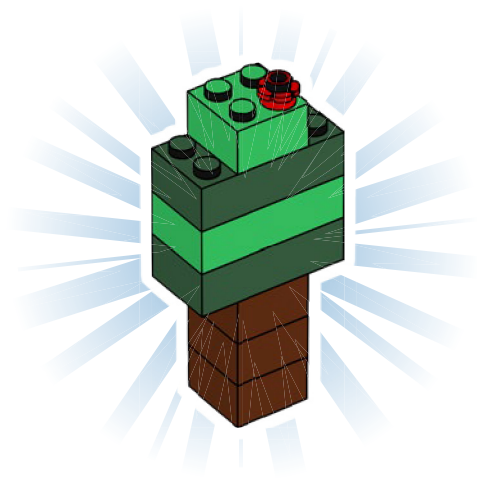

Rebuild

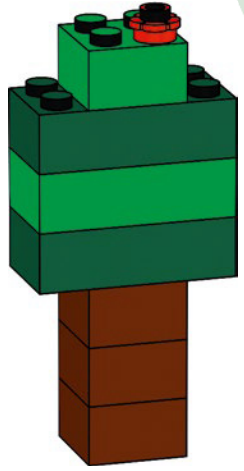
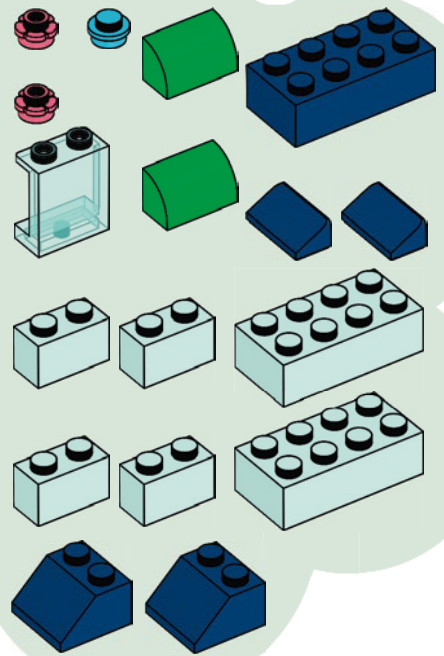

Reconstruire
Reconstruye

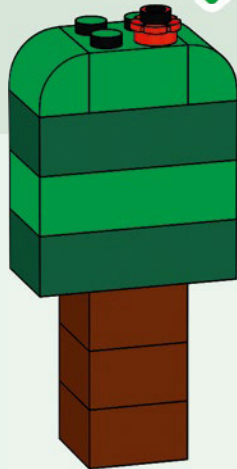
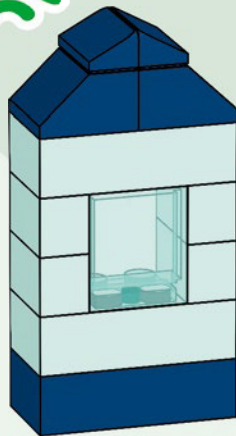



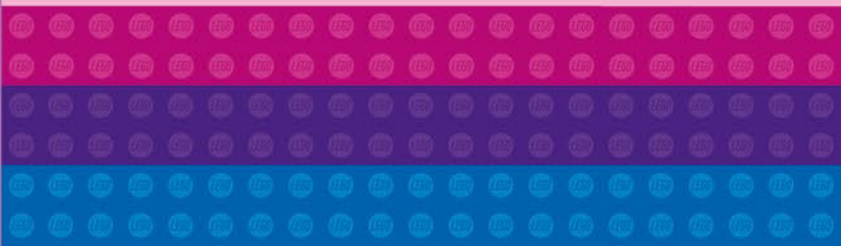

Free
Build





11034



11036



11035



11037



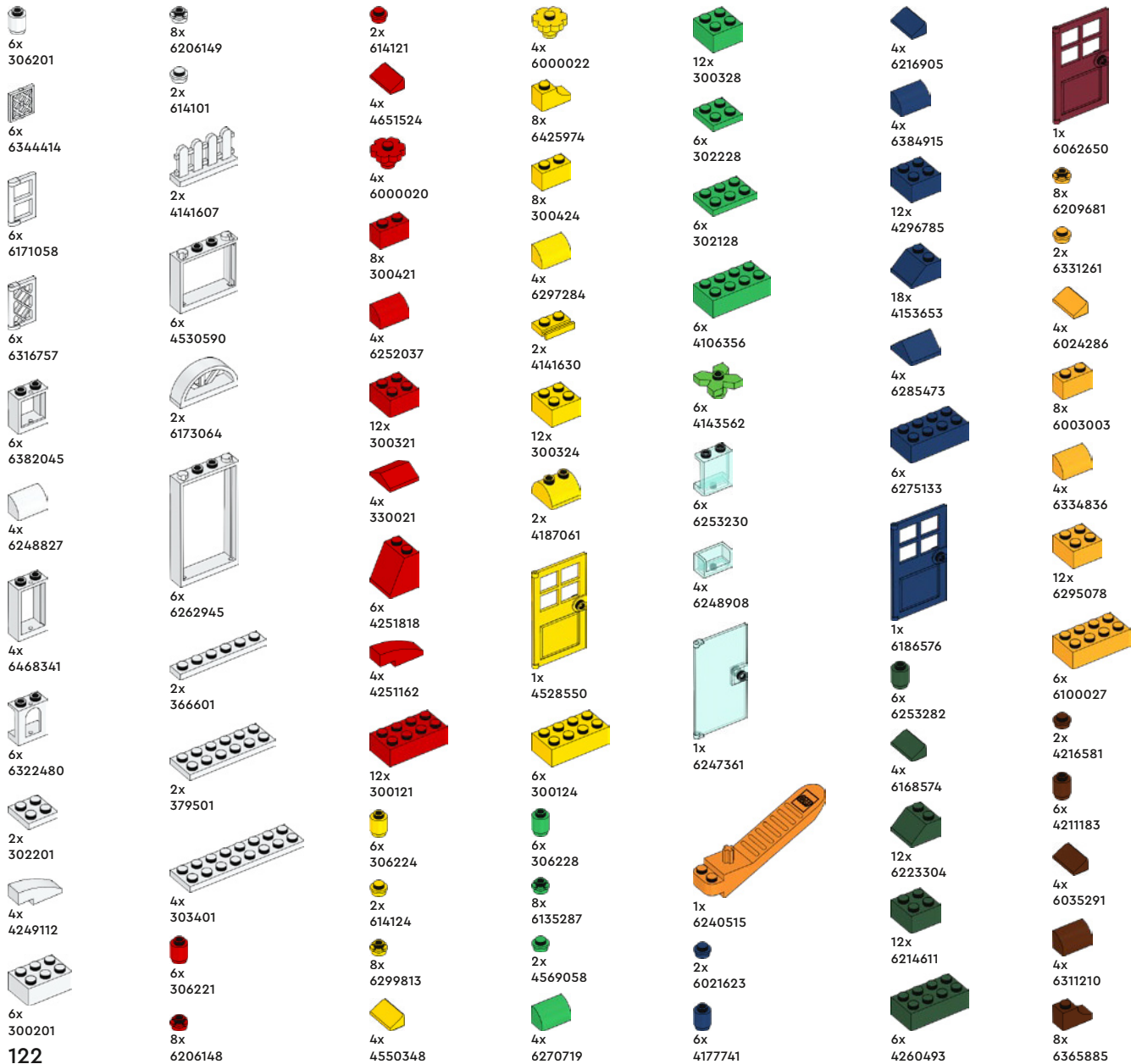



12x
4211202



12x
4211210



1x
6103769



6x
4211201



4x
4211404



4x
4211407

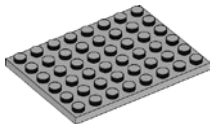

2x
4211408

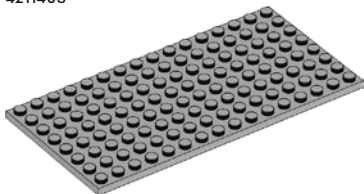

1x
4598522



8x
6426463



2x
6319958



4x
6296510



4x
6296494



8x
6022083



16x
6212064



2x
6250076



6x
6373312

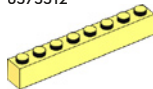

2x
6117315



2x
4566522



6x
6070305



4x
4566607



4x
6264050



6x
6107200



12x
4653960



6x
4626935

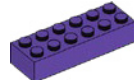

2x
6147004



6x
4620909



2x
6102986



4x
6097444



4x
6236578



12x
4653970



12x
6173655



4x
6035598



12x
6223734



1x
6212462



6x
4625629



2x
6146926



8x
6251854



6x
6335549



2x
6382504



4x
4616211



12x
6022032



4x
6236575



12x
6426720



12x
6426721



6x
6209673



8x
6214235



2x
6099190



12x
6099352



4x
6252258



6x
6254552



6x
6172518



12x
6099349



6x
6426723



4x
6133906

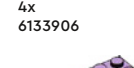

2x
6334047



8x
6295242



4x
6261293



12x
6258572



12x
6422920



6x
6422921



2x
6057898



12x
6104578



[LEGO.com/service](https://www.LEGO.com/service)

YOU COULD **WIN**



Scan this QR code or go to **LEGO.COM/PRODUCTFEEDBACK** and give us your short feedback about this LEGO® set for a chance to win a cool LEGO prize.

Terms and Conditions apply*

EN: YOU COULD WIN. Terms and Conditions apply* **DE: Du könntest GEWINNEN.** Es gelten die Teilnahmebedingungen* **FR: Tu pourrais GAGNER.** Des conditions s'appliquent* **IT: Potresti VINCERE tu.** Termini e condizioni sono applicabili* **ES: Puedes GANAR.** Aplican términos y condiciones* **PT: Poderá GANHAR.** Aplicam-se termos e condições* **ZH: 轻松获奖. 条款和条件适用*** **PL: Szansa na WYGRANĄ.** Obowiązują warunki korzystania* **CS: Máte šanci VYHRÁT.** Platí všeobecné smluvní podmínky* **SK: Máte šancu VYHRAŤ.** Platia všeobecné zmluvné podmienky* **HU: TE IS NYERHETSZ.** Felhasználási feltételek érvényesek* **RO: Ai putea CÂȘTIGA.** Se aplică termeni și condiții* **BG: Можете да СПЕЧЕЛИТЕ.** Има определени правила и условия* **LV: Tu vari LAIMĒT.** Ir spēkā noteikumi un nosacījumi.* **ET: Sul on võimalus VÕITA.** Kehtivad tingimused* **LT: Jūs galite LAIMĖTI.** Taikomos sąlygos*

*[LEGO.com/productfeedback-terms](https://www.lego.com/productfeedback-terms)