



# classic

11036



LEGO® Builder



LEGO.com/sustainable-packaging



FR

**DONNEZ**  
OU  
**RECYCLEZ**



OU



OU



ASSOCIATION

MAGASIN

DÉCHÈTERIE

Adresses sur [quefairedemesdechets.fr](http://quefairedemesdechets.fr)

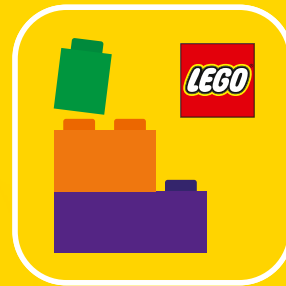

# BUILDER



Apple and the Apple logo are trademarks of Apple Inc., registered in the U.S. and other countries and regions. App Store is a service mark of Apple Inc. Google Play and the Google Play logo are trademarks of Google LLC. Tencent and the Tencent logo are trademarks of Tencent Inc.

LEGO.com/devicecheck

EN Ask parents' permission before going online | DE Eltern um Erlaubnis bitten, bevor du online gehst | FR Demande l'autorisation d'un parent avant d'aller en ligne | IT Chiedi il permesso ai tuoi genitori prima di andare online | ES Pídeles permiso a tus papás antes de conectarte a Internet | PT pede autorização aos pais antes de acederes online | ZH 上网前应先征得父母的同意 | PL Poproś rodziców o zgodę, zanim wejdiesz do Internetu | CS Než půjdeš na internet, požádej rodiče o svolení | SK Skôr než pôjdeš na internet, vypýtaj si povolenie od rodičov | HU Kérj szülői engedélyt, mielőtt online csatlakoznál! | RO Cere permisiunea părinților înainte de a te conecta online | BG Поискайте разрешение от родител, преди да влезете онлайн | LV Pirms došanās tiešsaistē palūdz atļauju vecākiem | ET Enne Interneti kasutamist küsi vanematelt luba | LT Prieš prisijungdami prie interneto, atsklauskite tėvų

A LEGO truck with a white cab and a teal cargo box. It has yellow headlights and large black tires.

**Build**

Build  
Bauen  
Construire  
Costruisci  
Construye  
Construa  
拼搭  
Buduj

Stavěj  
Stavaj  
Építsd meg!  
Construiește  
Стройте  
Būvē  
Ehita  
Konstruoti

The same LEGO truck as above, but with a white cylindrical tank on top and a blue stripe on the side. There are some white scribbles above it.

**Rebuild**

A LEGO Formula 1 car with a pink body and teal base. It has black tires and a black rear wing.

**Free Build**

Rebuild  
Umbauen  
Reconstruire  
Ricostruisci  
Reconstruye  
Reconstrói  
重新拼搭  
Przebuduj

Přestavuj  
Prestavaj  
Újjáépítés  
Reconstruiește  
Възможност за промяна  
Pārbūvē  
Ehita ūmber  
Perkonstruokite

Free Build  
Kreatives Bauen  
Construire en toute liberté  
Modello gratuito  
Construye libremente  
Construção Livre  
自由拼搭  
Buduj swobodnie

Stavěj podle vlastní fantazie  
Stavaj podľa vlastnej fantázie  
Kötetlen építés  
Construiește liber  
Свободна конструкция  
Brīva būvēšana  
Vabalt ehitamine  
Nevaržomas konstravimas



**ideas**  
included

Ideas included  
Mit Bauideen  
Idées incluses  
Idee include  
Incluye ideas  
Ideias incluídas  
内含拼搭创意  
Pomysły w zestawie

Obsahuje tipy na stavění  
Obsahuje tipy na stavanie  
Ötletek a dobozban  
Idei include  
Съдържа примерни идеи  
Iekļautas idejas  
Kaasas ideed  
Priedamos idėjos



**108**

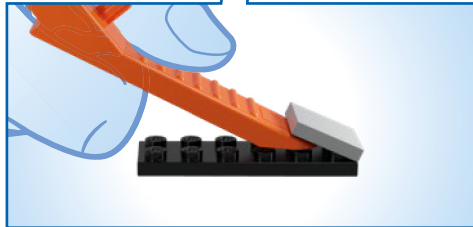
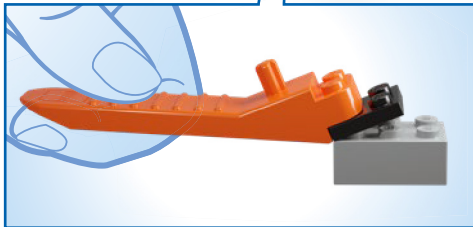
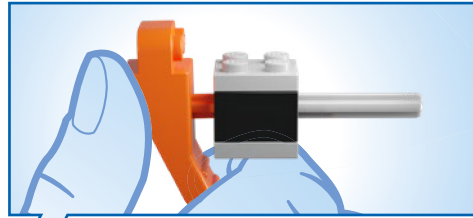
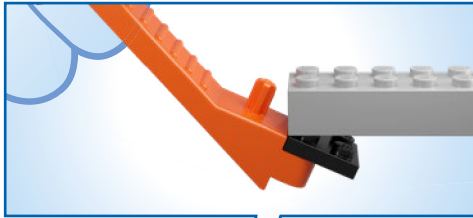

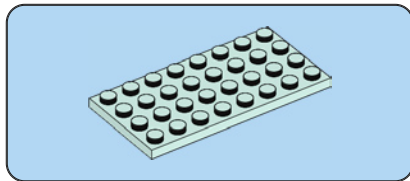

1

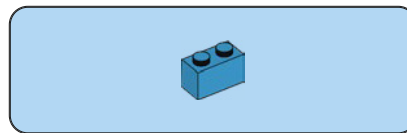
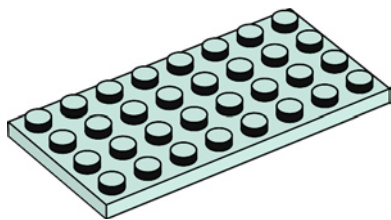

2

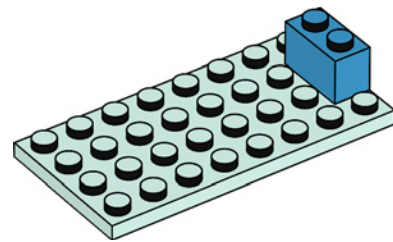

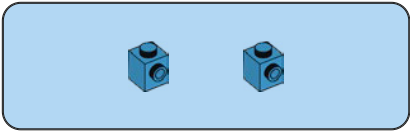

3

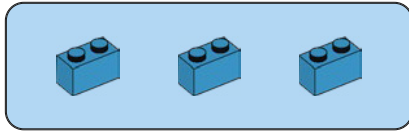
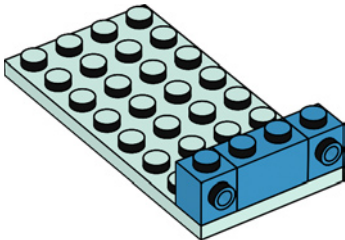

4

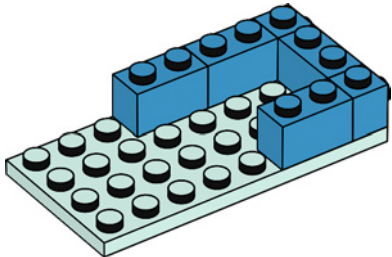



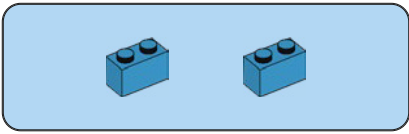

5

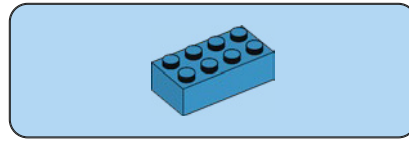
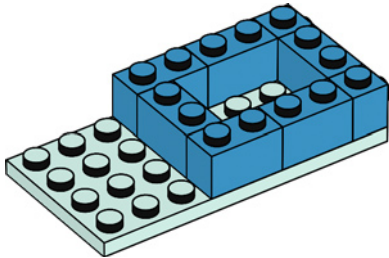

6

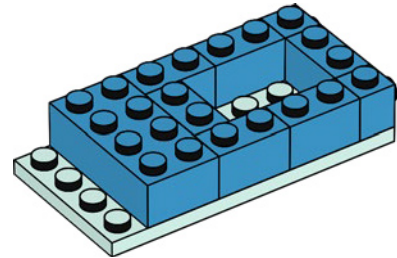

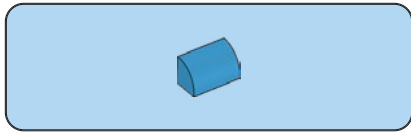

7

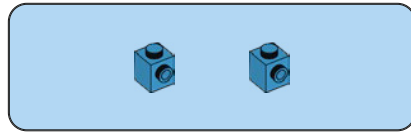
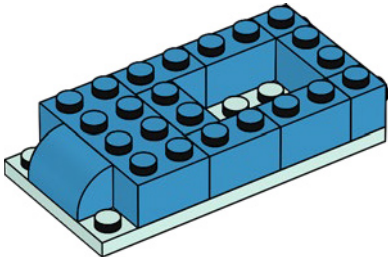

8

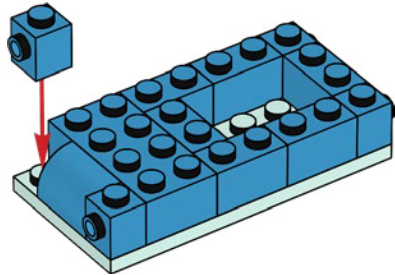

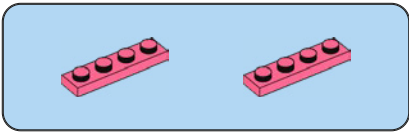

9

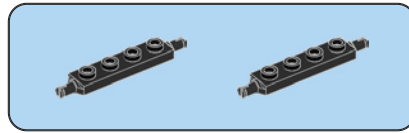
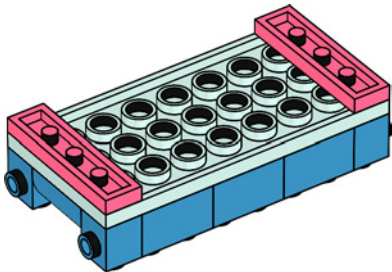

10

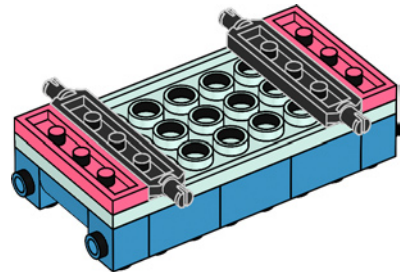

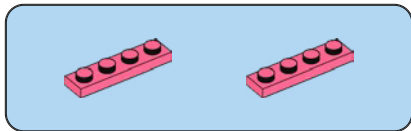

11

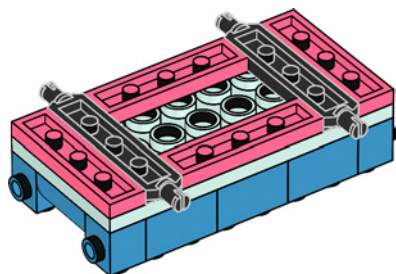

12

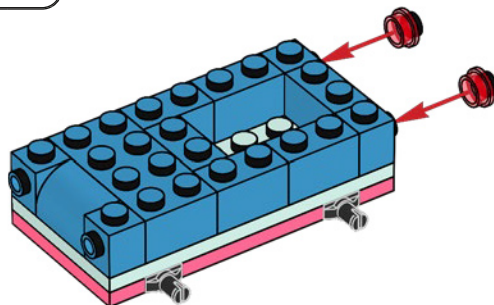

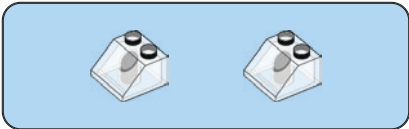

13

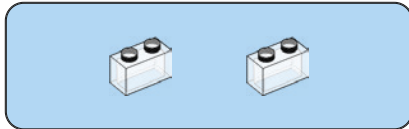
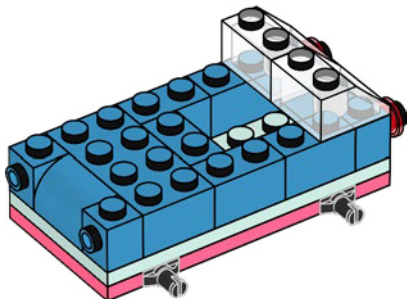

14

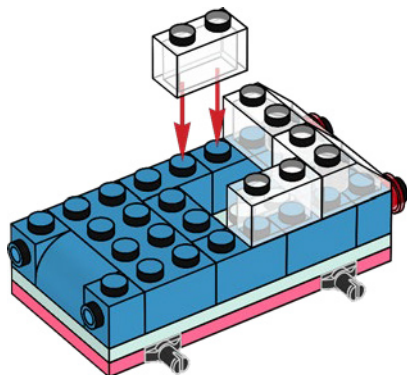



15

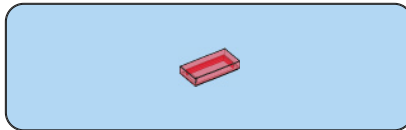
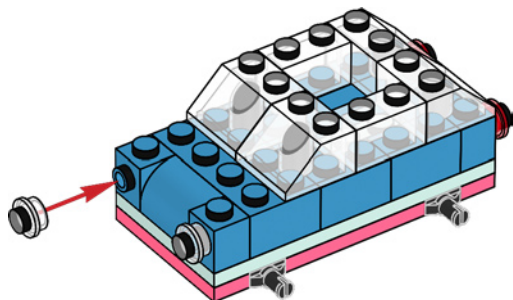

16

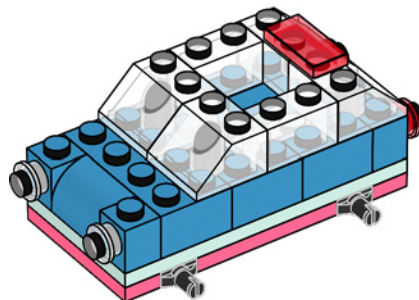

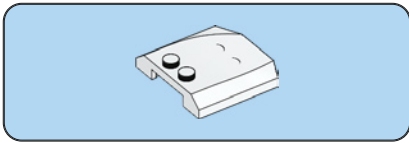

17

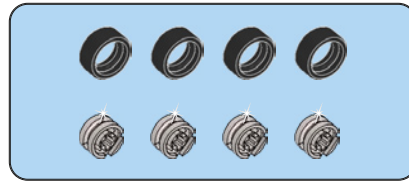
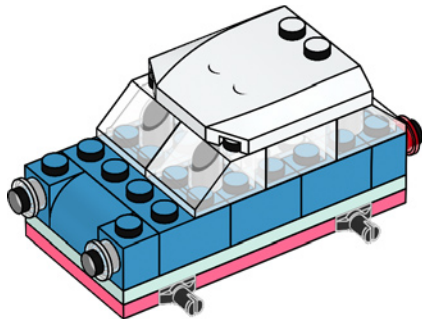

18

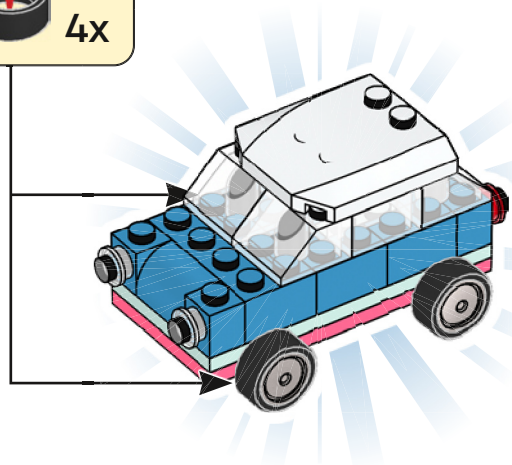
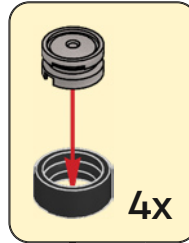

# Rebuild

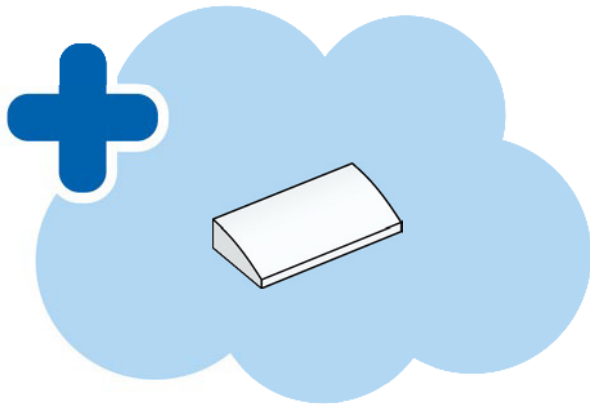
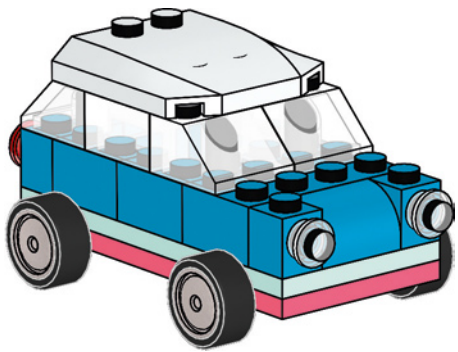





14

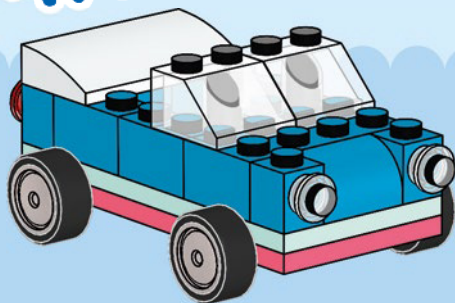

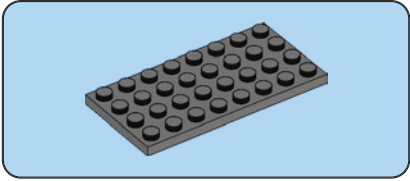
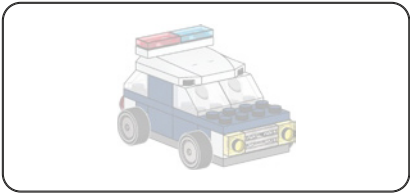

1

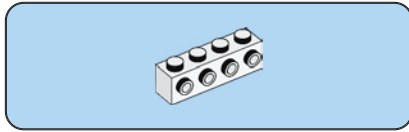
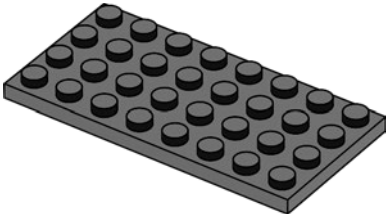

2

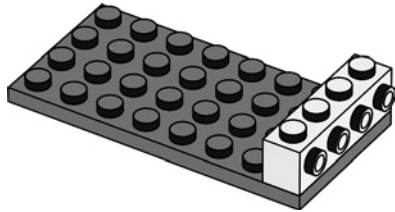

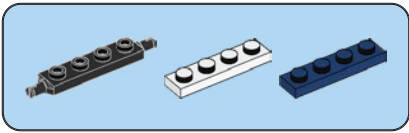

3

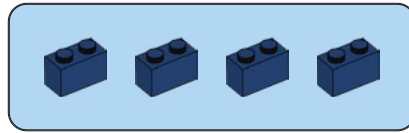
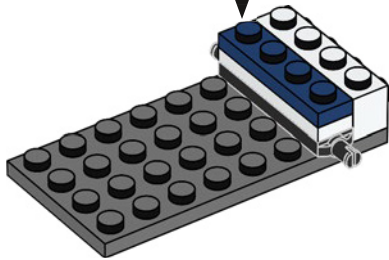
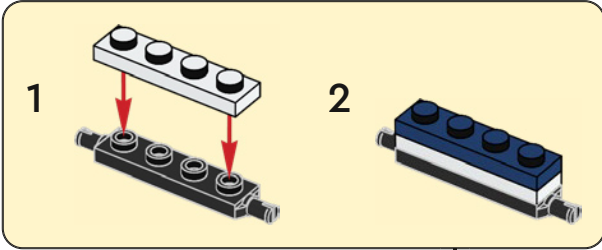

4

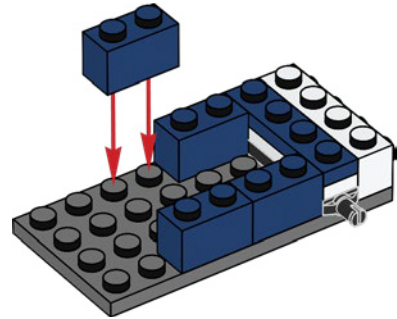

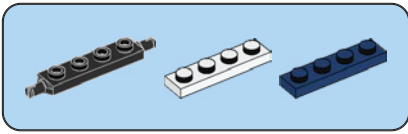

5

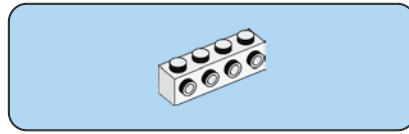
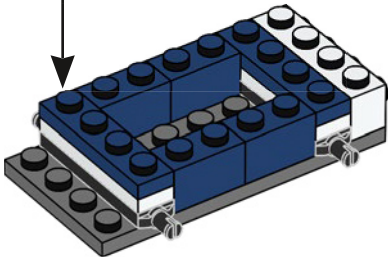
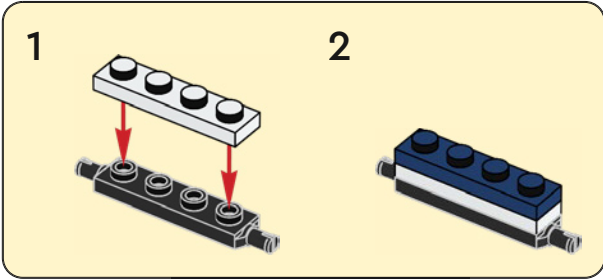

6

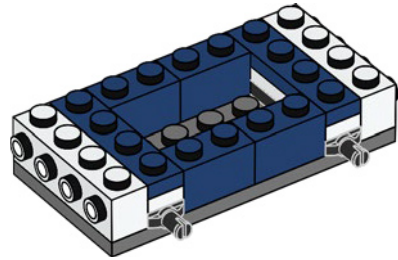

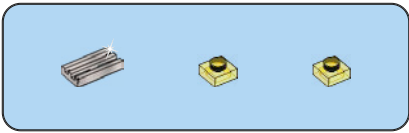

7

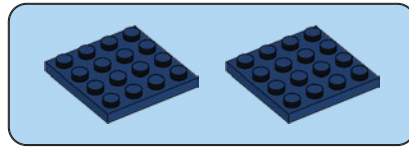
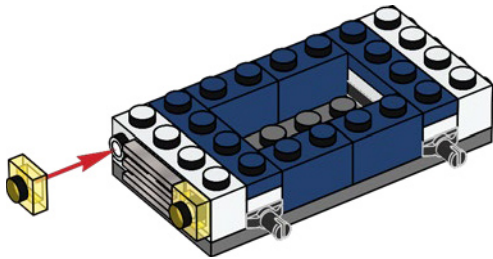

8

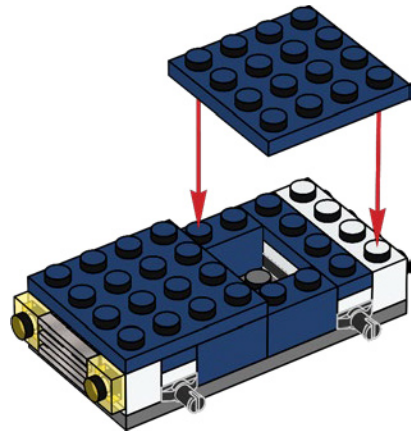

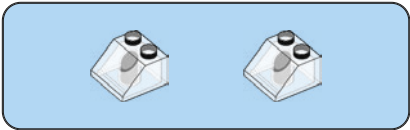

9

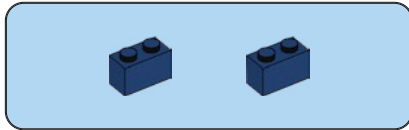
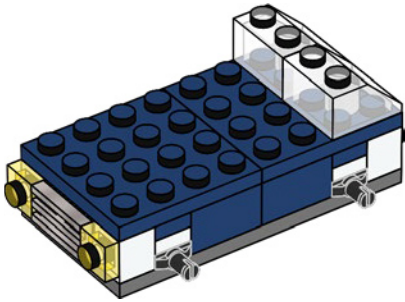

10

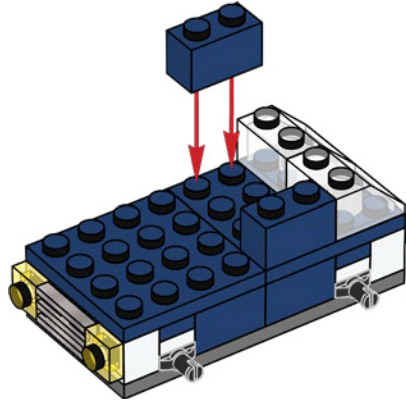

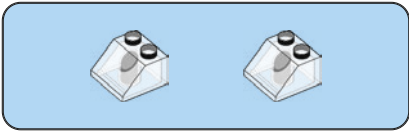

11

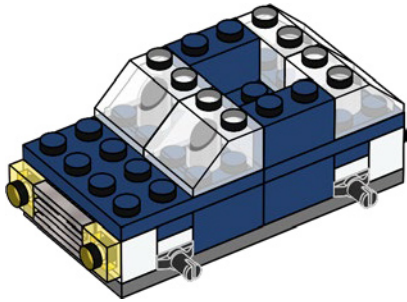

12

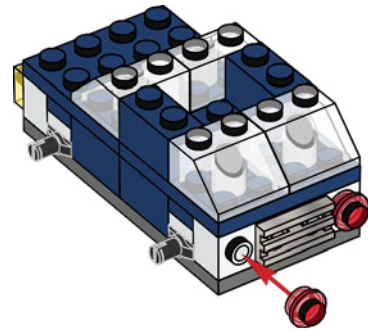
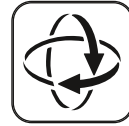

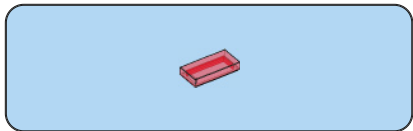

13

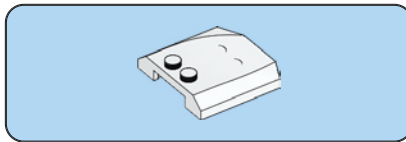

14

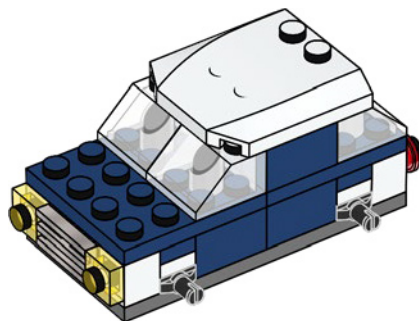
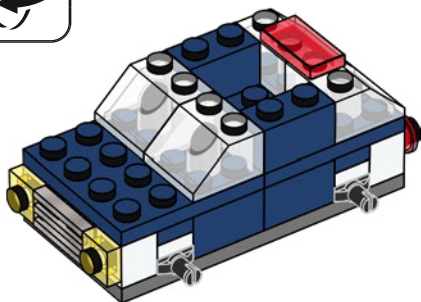



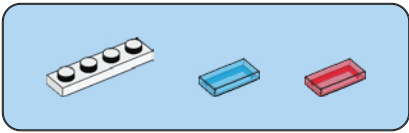

15

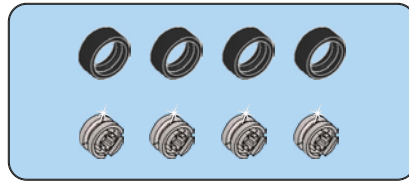
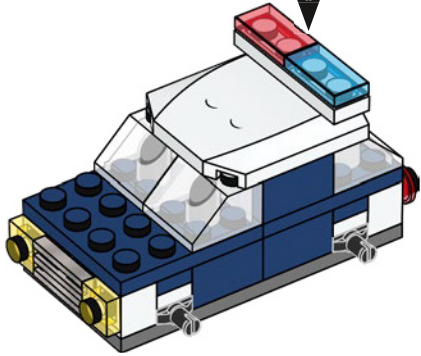
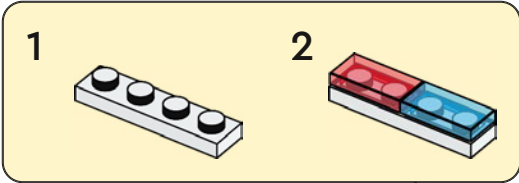

16

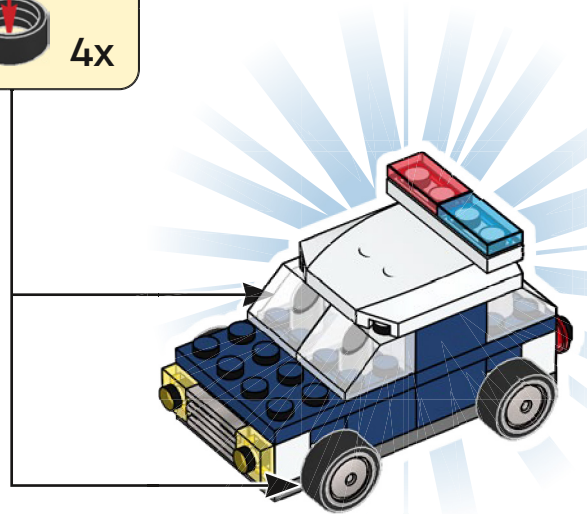
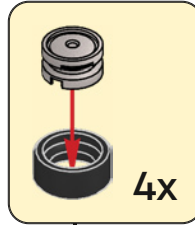

# Rebuild

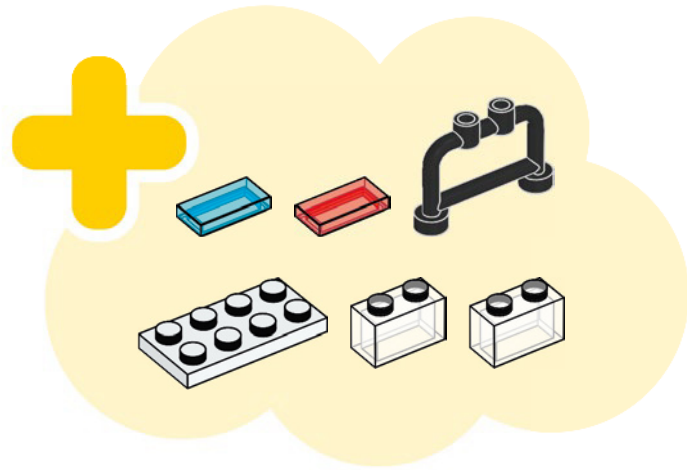
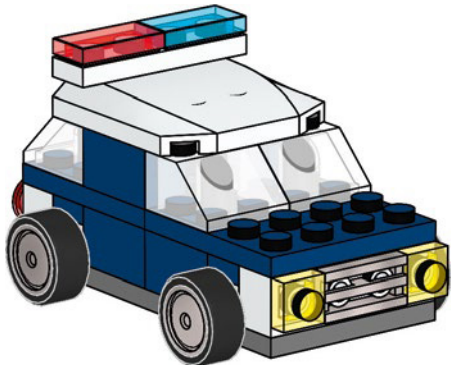

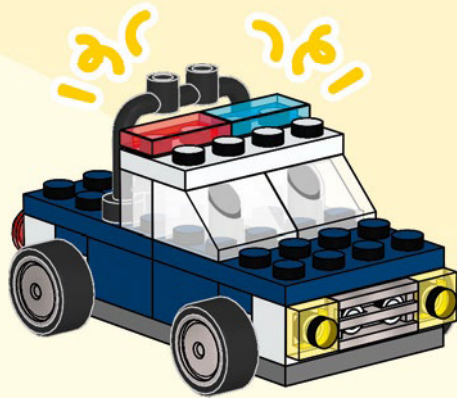

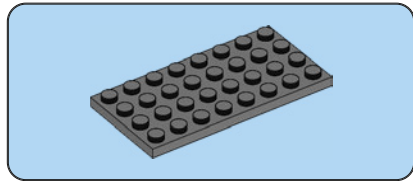
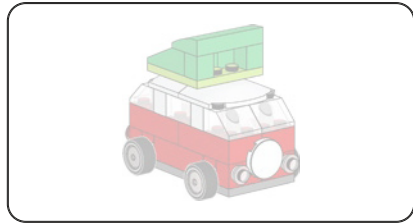

1

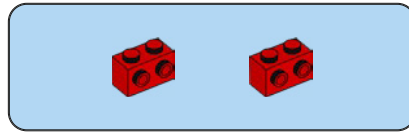
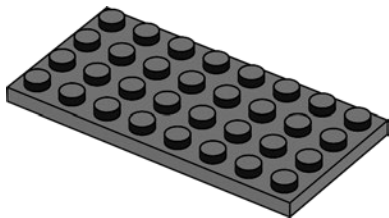

2

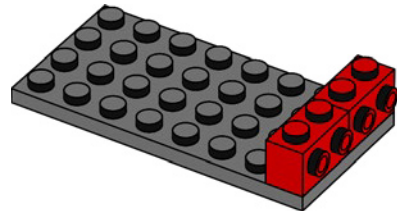

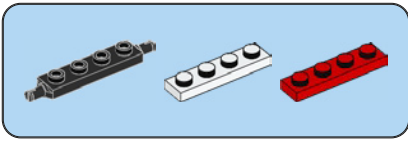

3

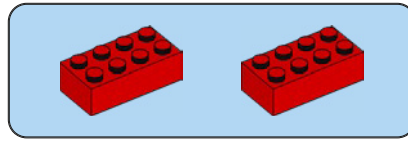
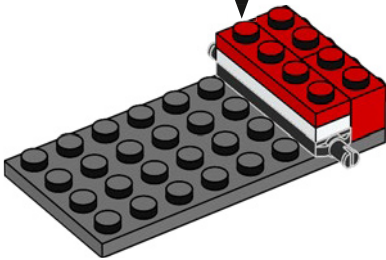
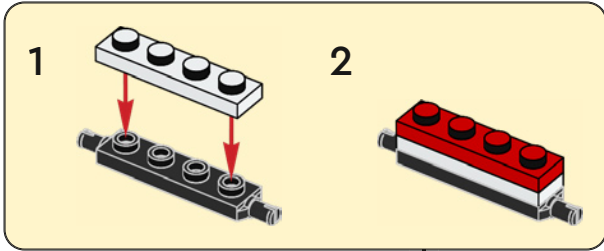

4

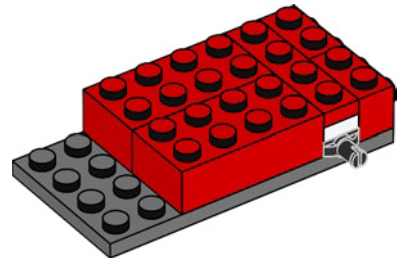

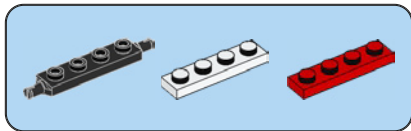

5

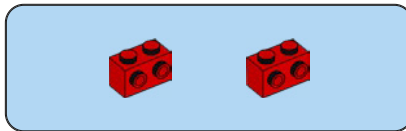
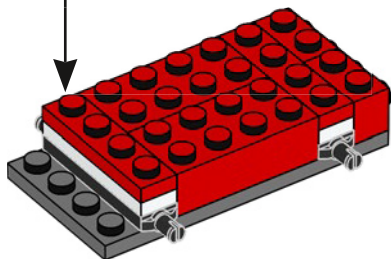
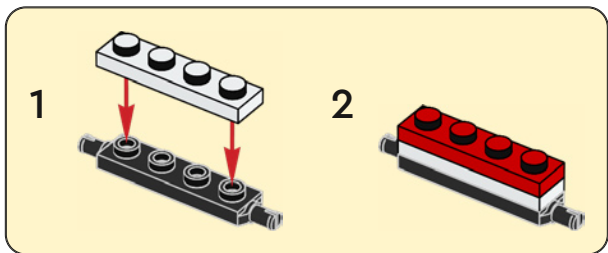

6

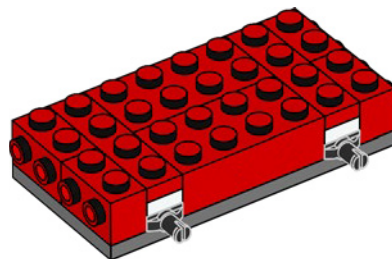

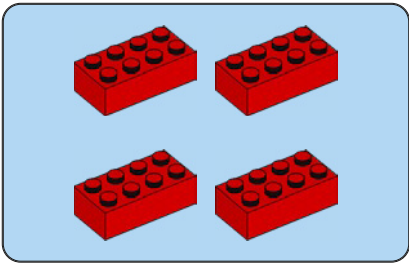

7

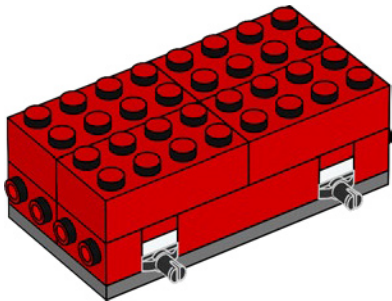

8

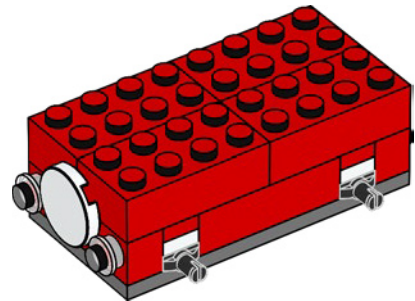

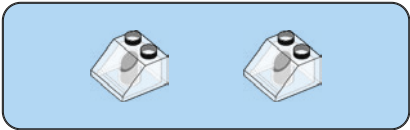

9

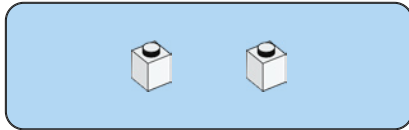
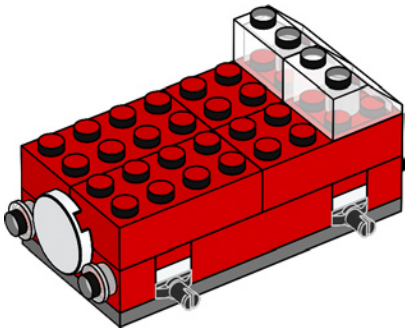

10

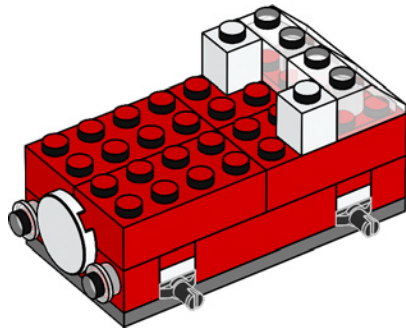



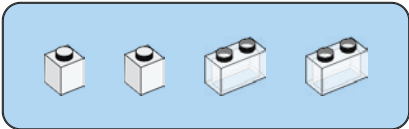

11

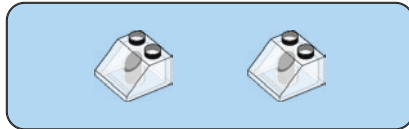
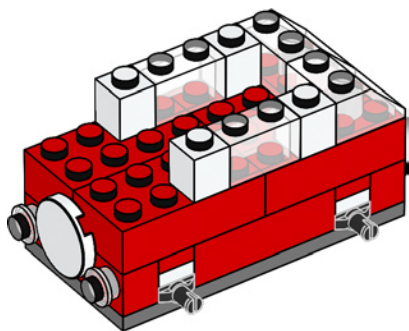

12

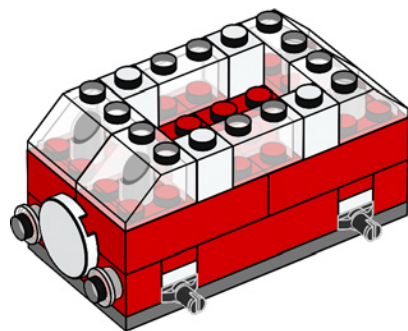



13

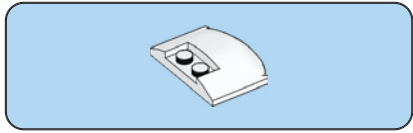
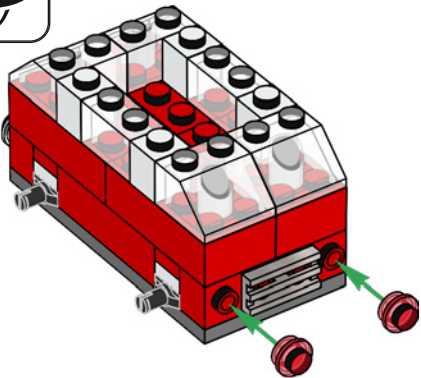

14

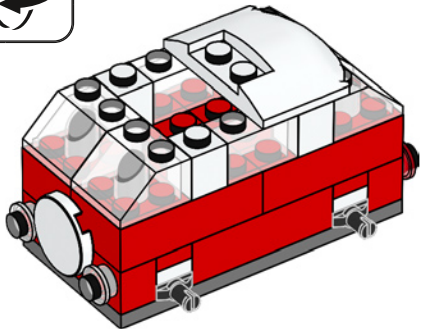

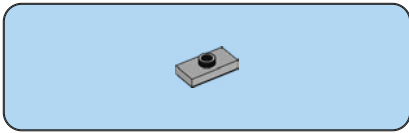

15

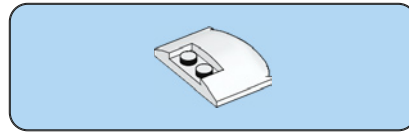
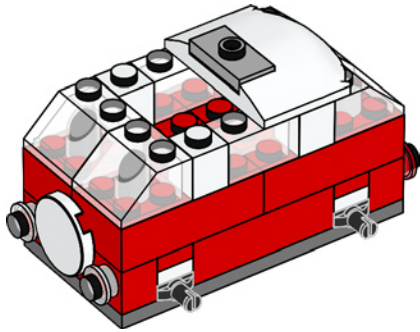

16

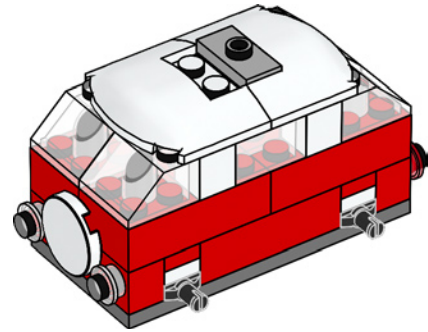

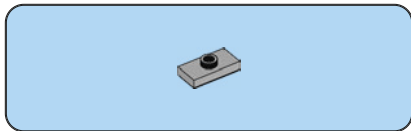

17

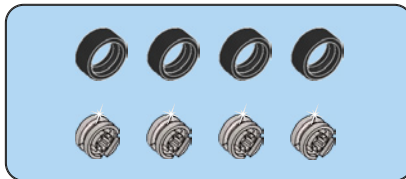
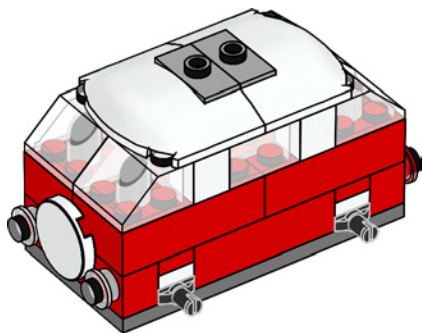

18

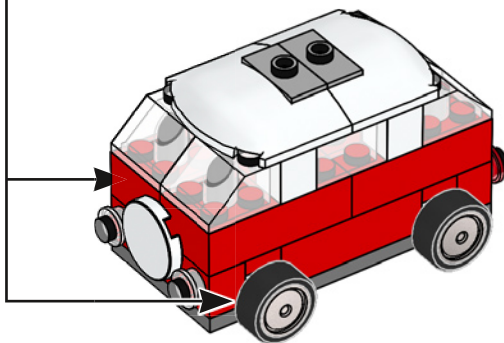
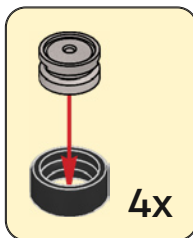

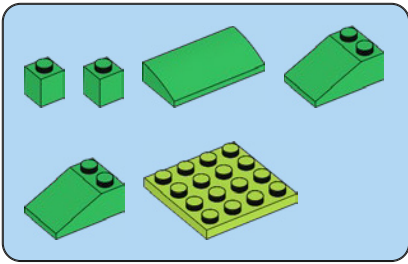

19

1

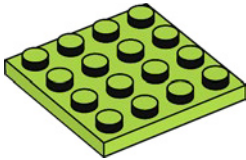

2

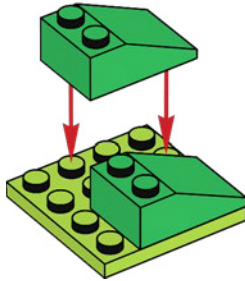

3

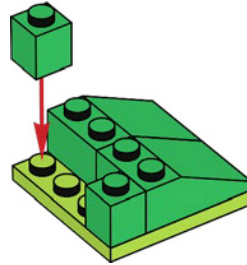

4

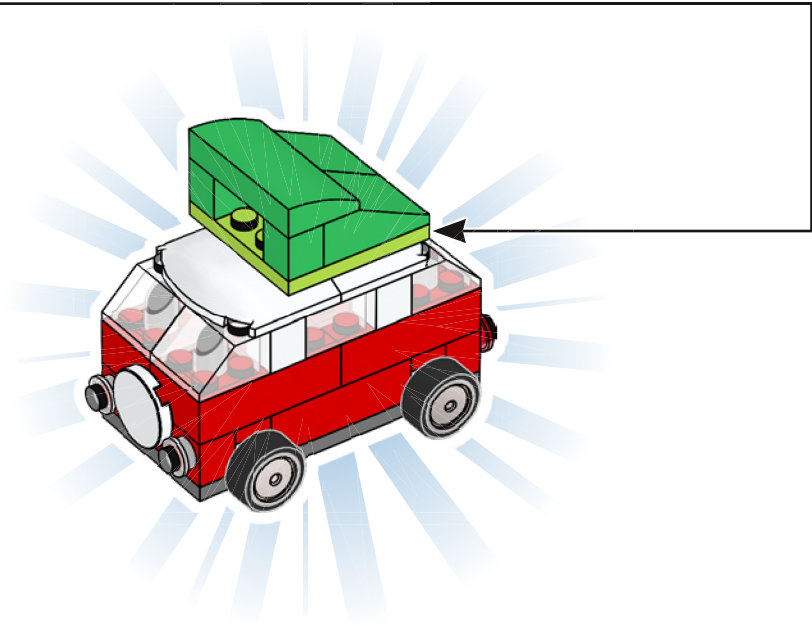
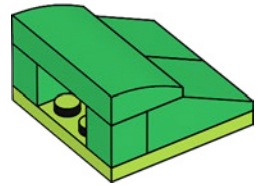

# Rebuild

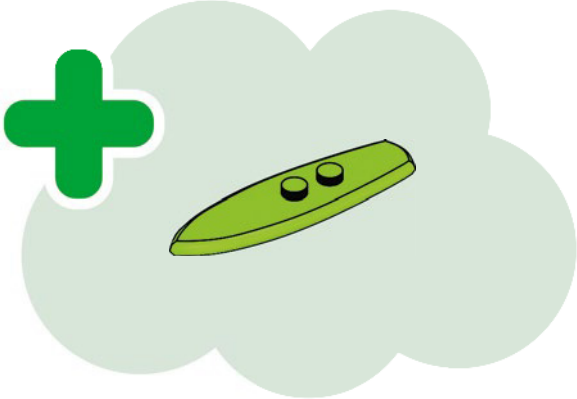
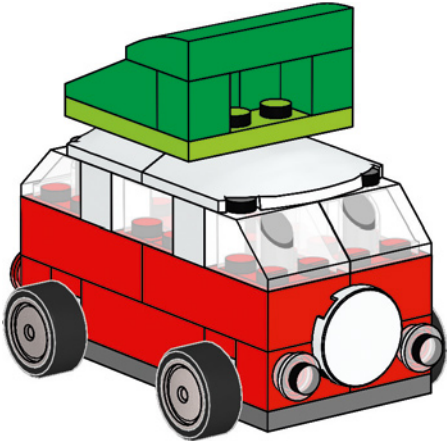



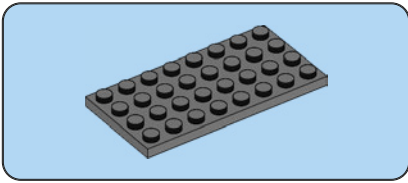
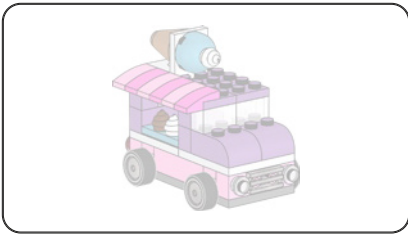

1

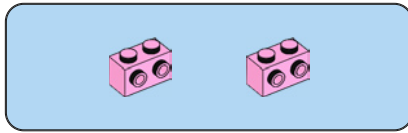
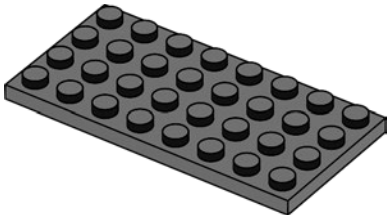

2

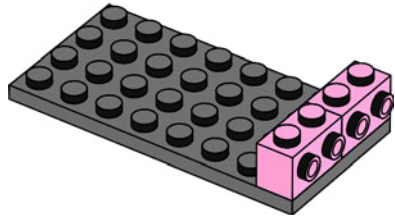



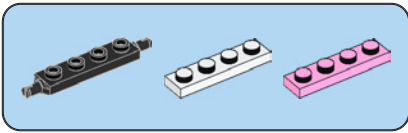

3

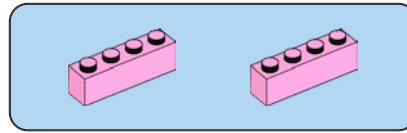
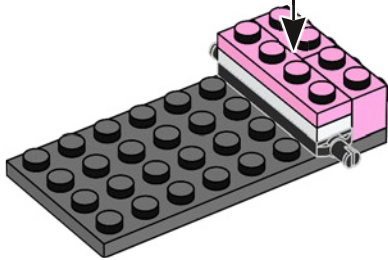
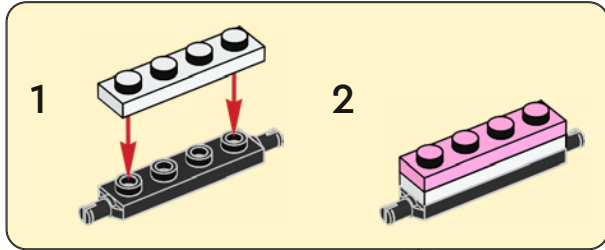

4

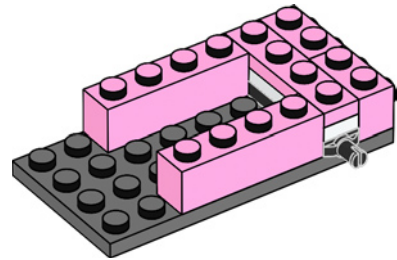

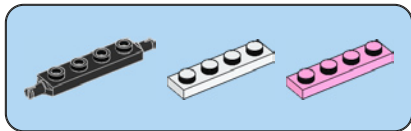

5

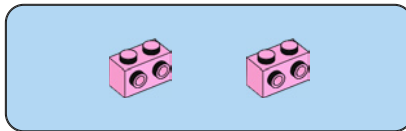
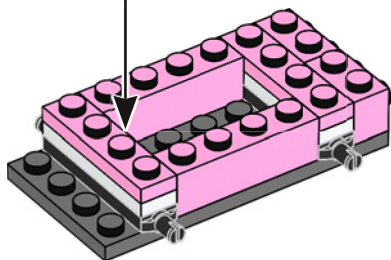
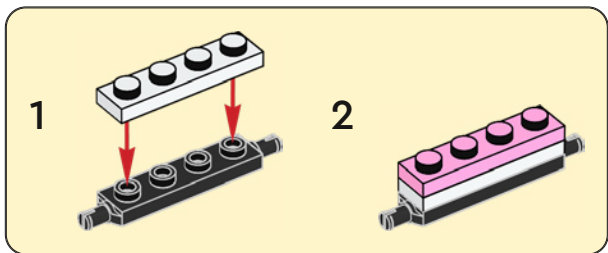

6

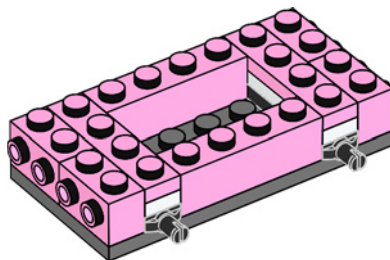



7

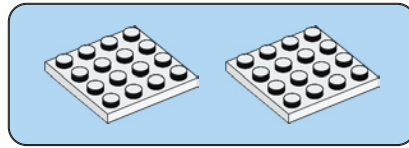
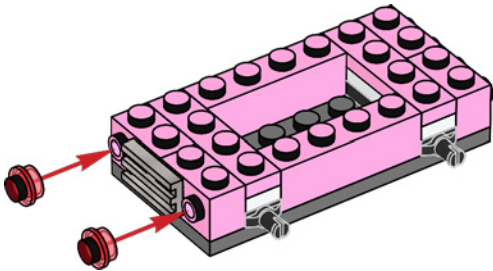

8

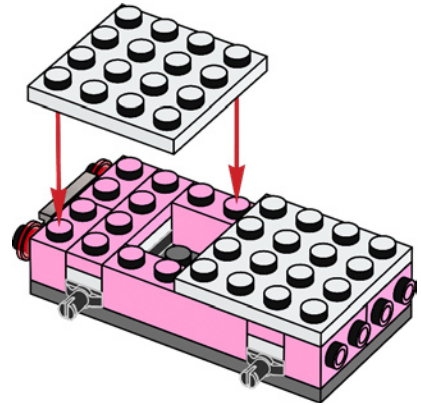

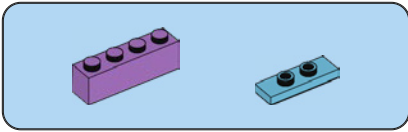

9

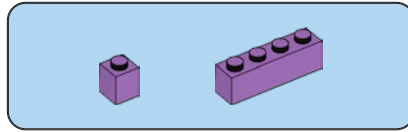
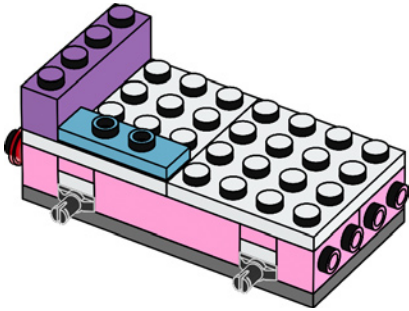

10

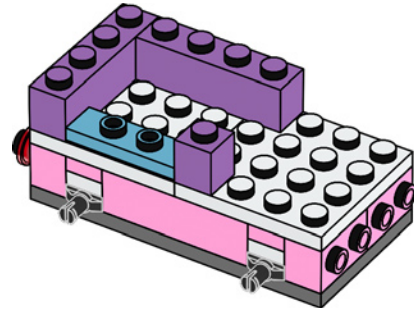

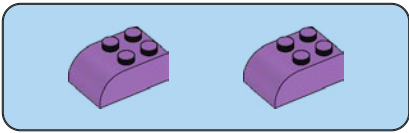

11

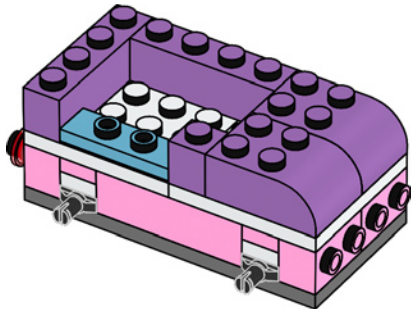

12

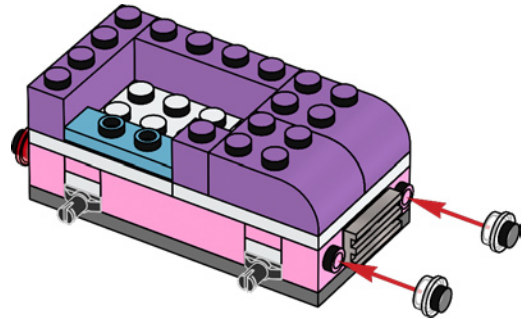

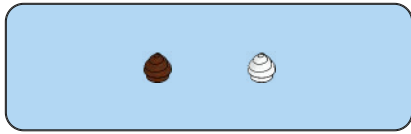

13

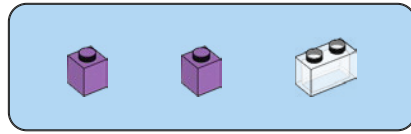
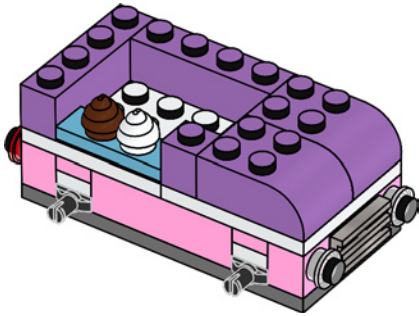

14

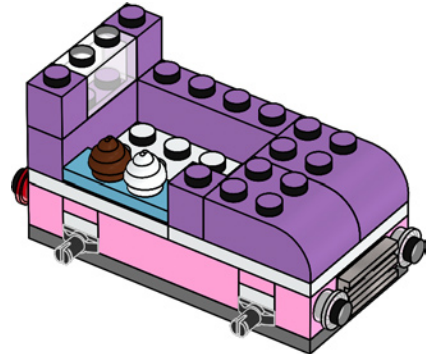

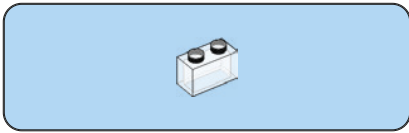

15

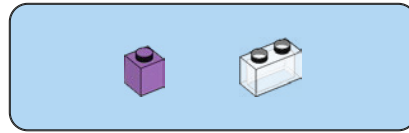
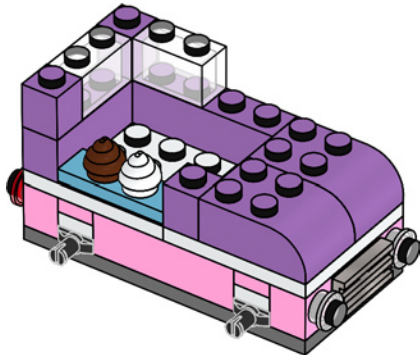

16

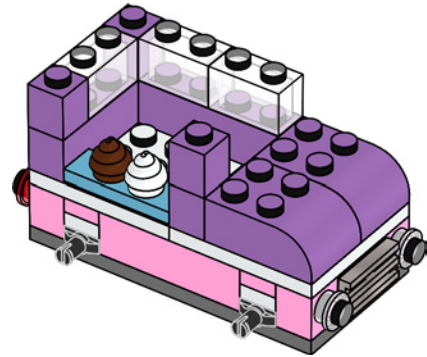

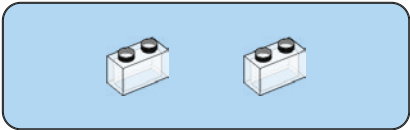

17

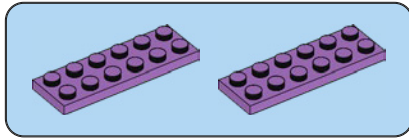
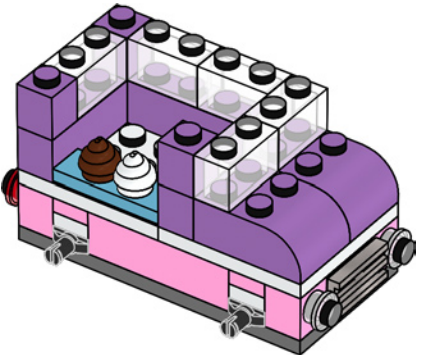

18

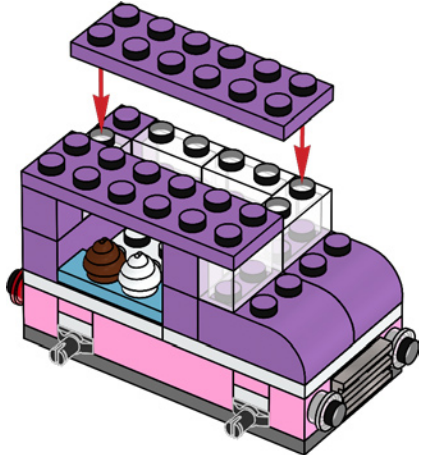



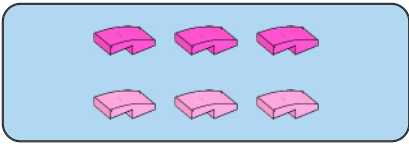

19

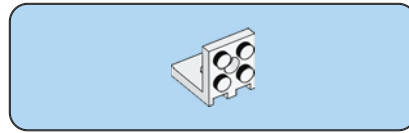
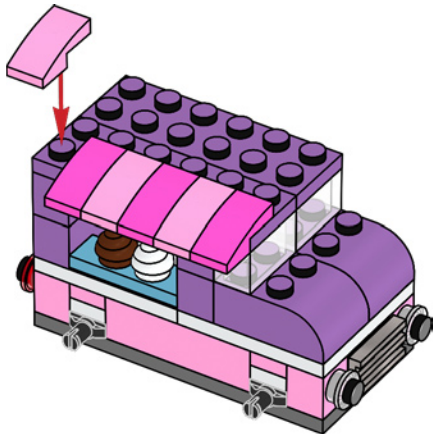

20

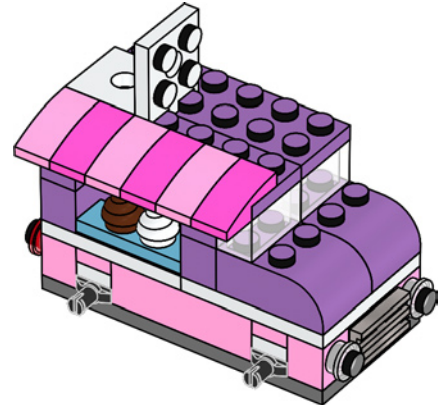

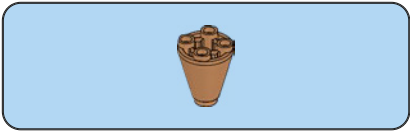

21

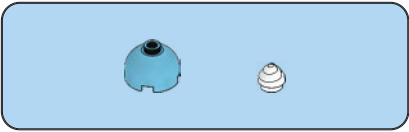
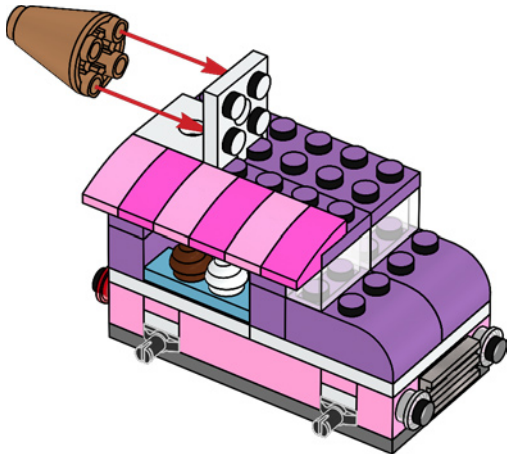

22

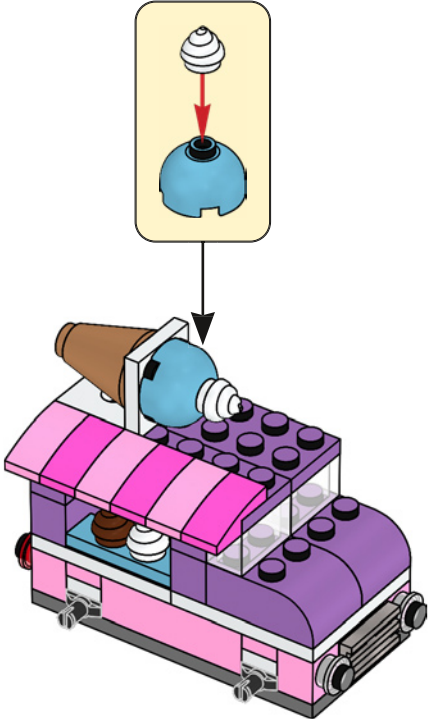

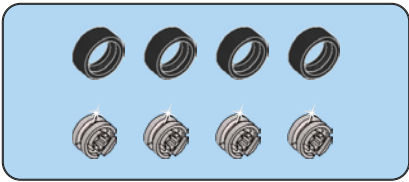

23

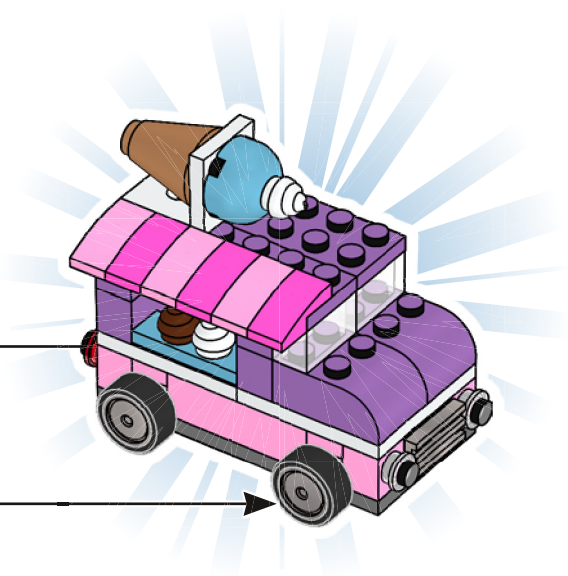
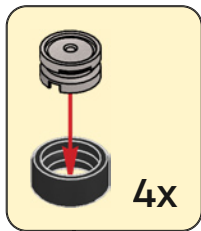

# Rebuild

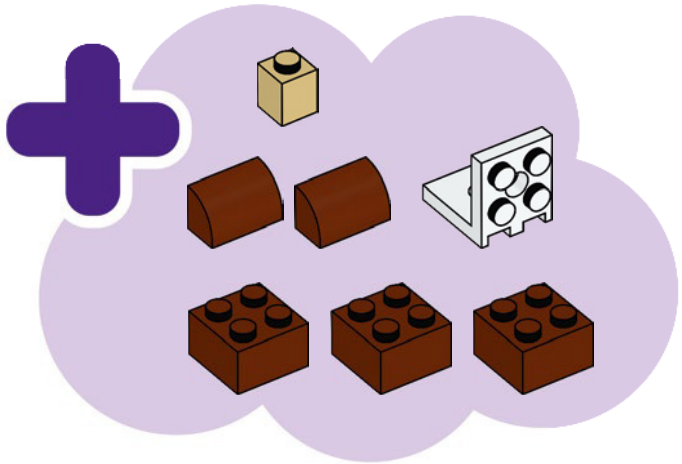
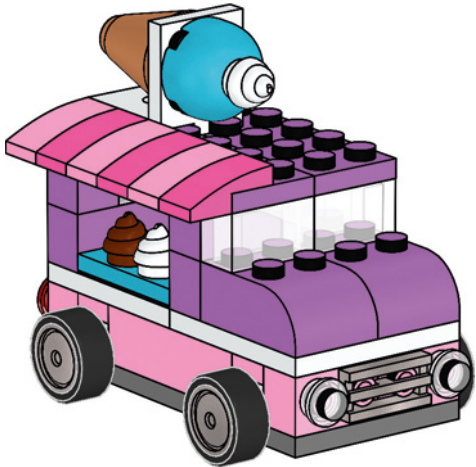

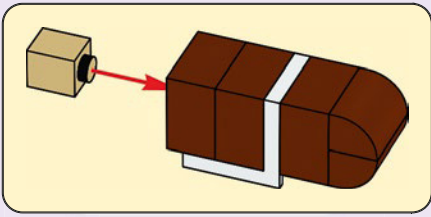

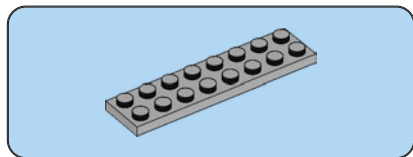
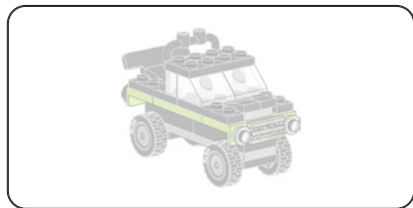

1

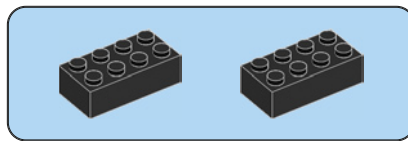
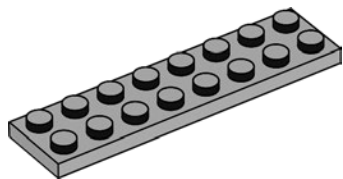

2

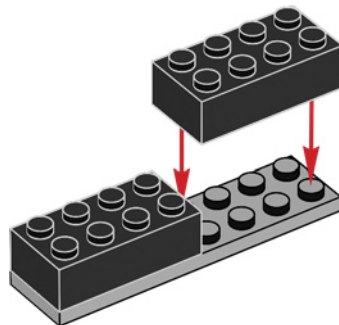

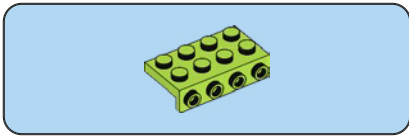

3

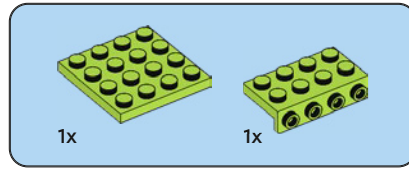
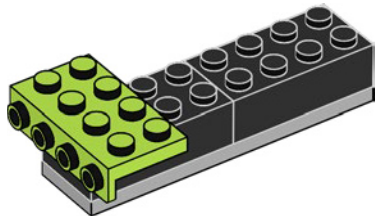

4

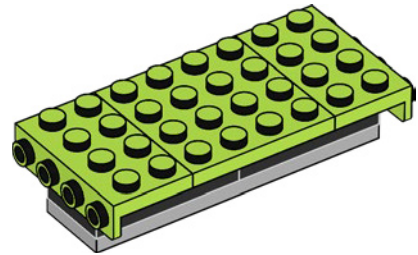

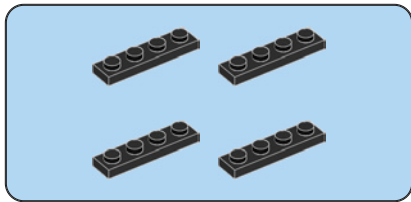

5

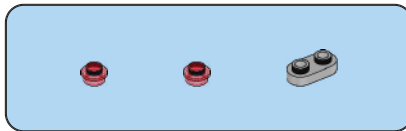
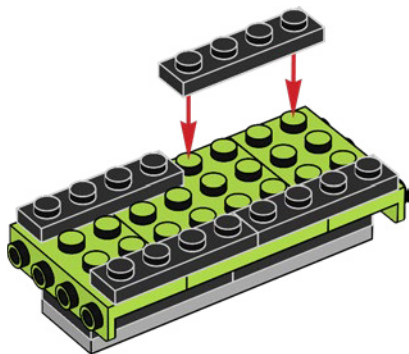

6

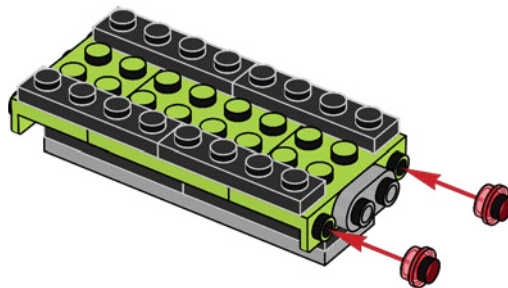



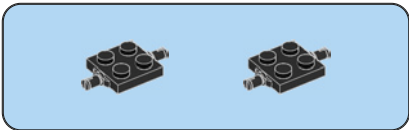

7

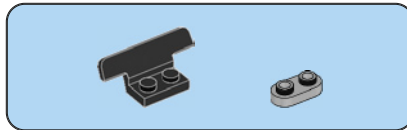
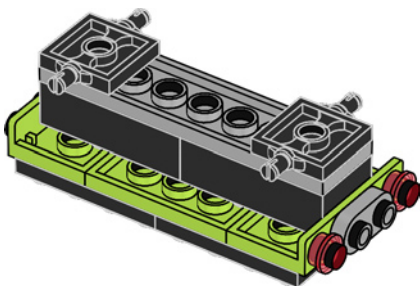

8

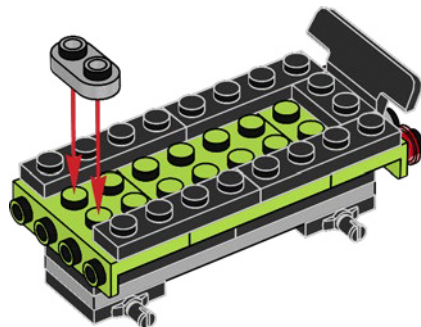

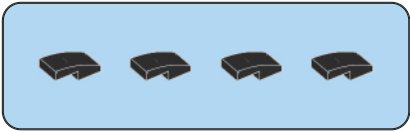

9

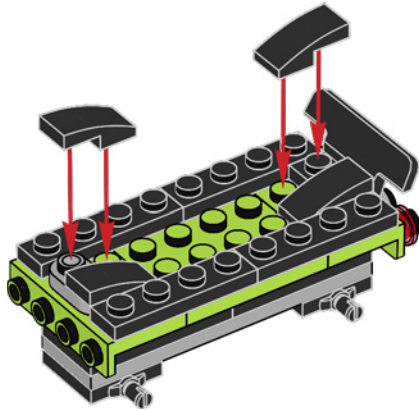



10

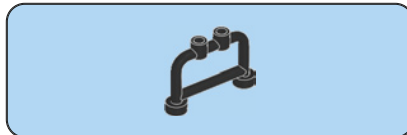
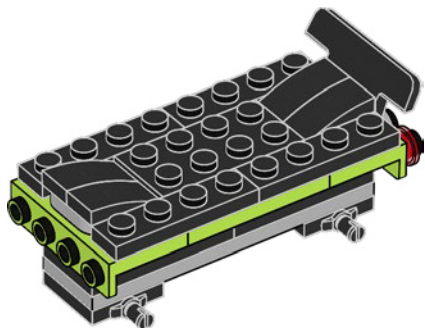

11

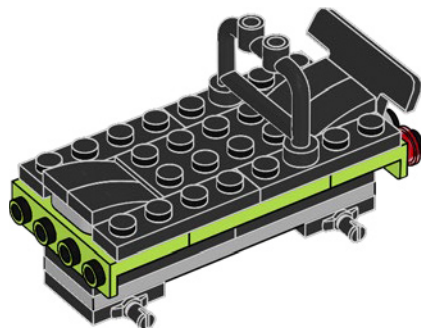

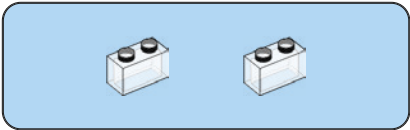

12

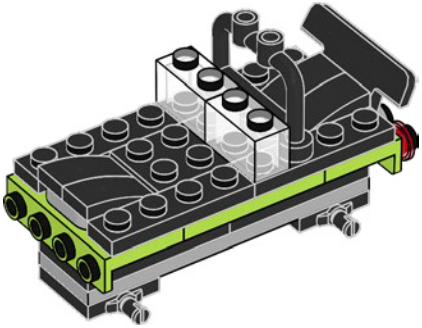

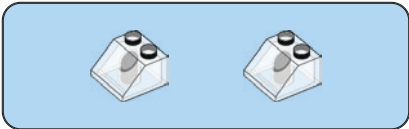

13

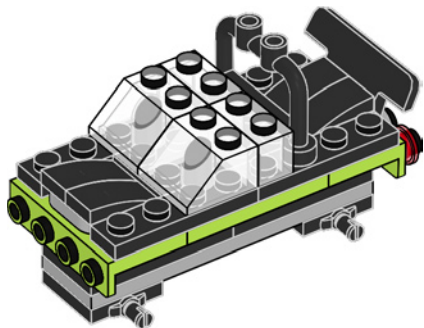

14

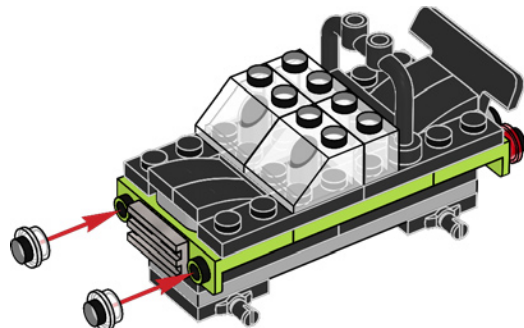

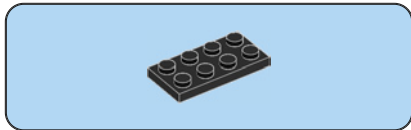

15

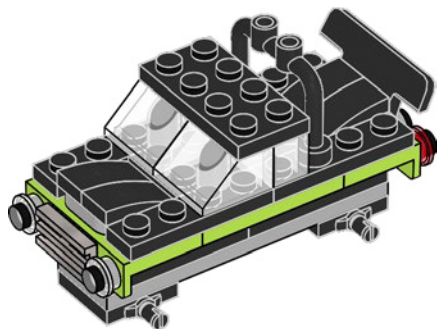

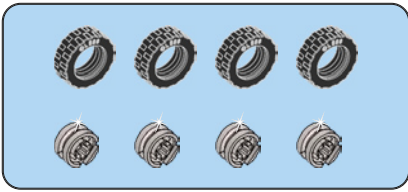

16

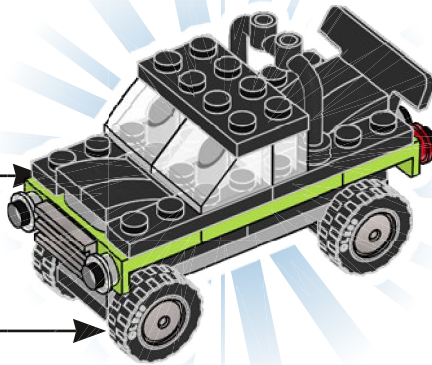
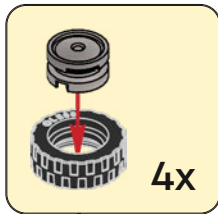

# Rebuild

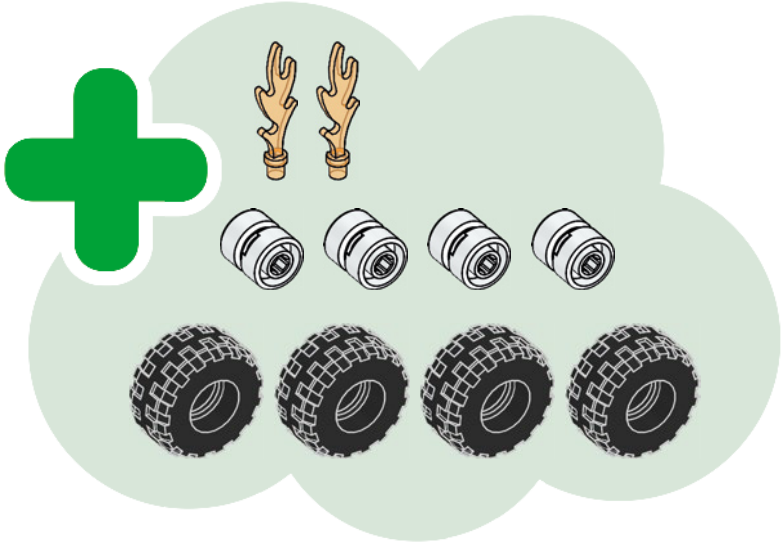
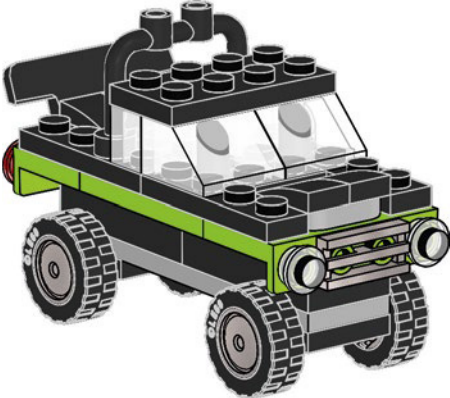



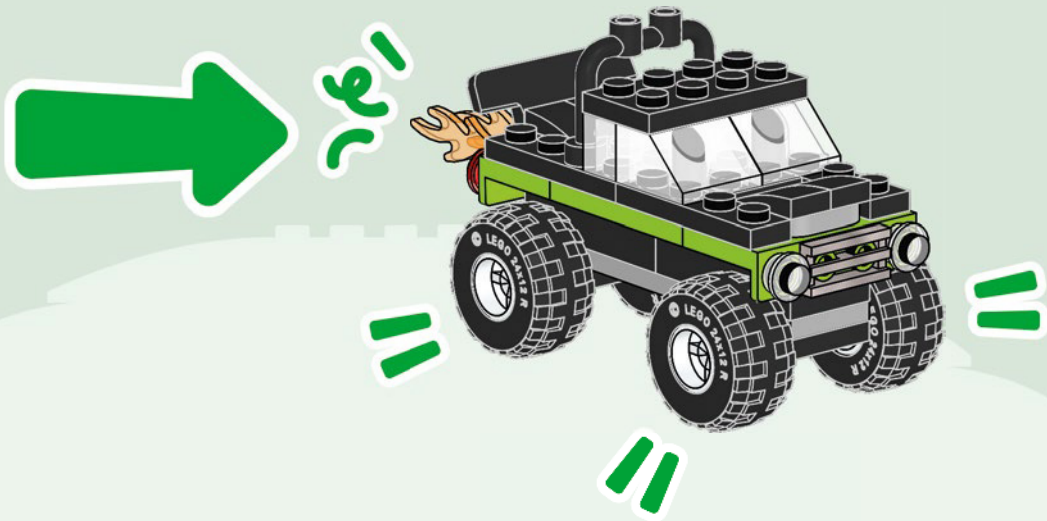

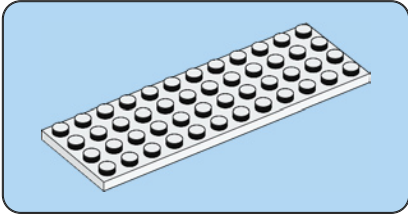
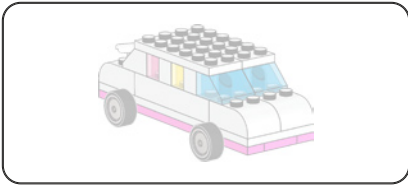

1

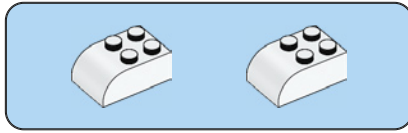
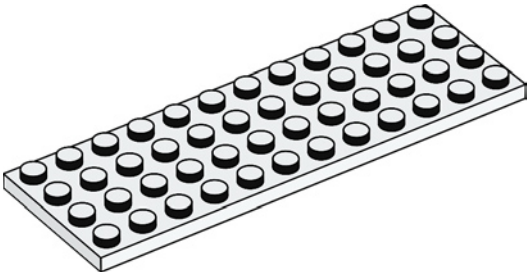

2

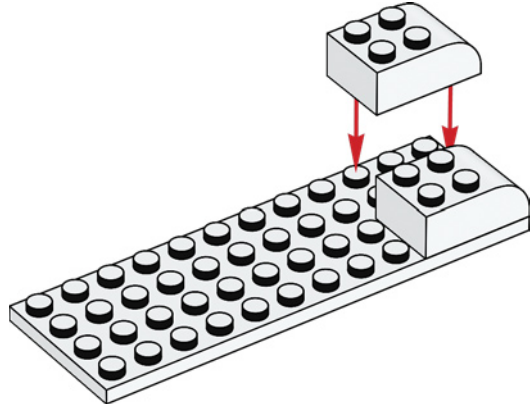

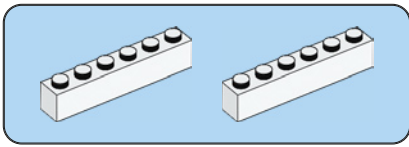

3

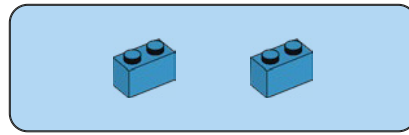
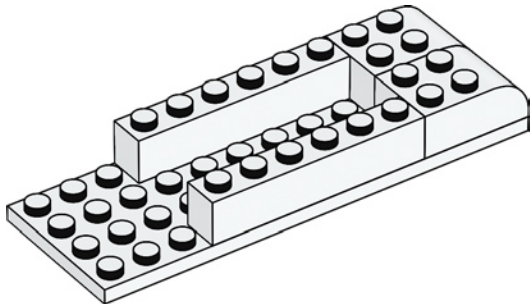

4

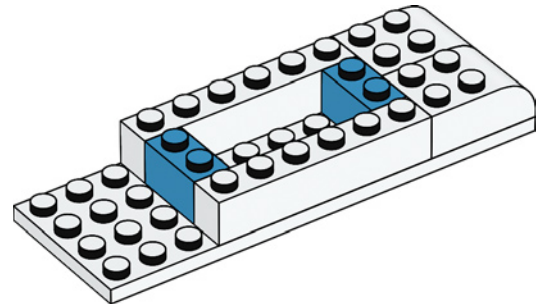

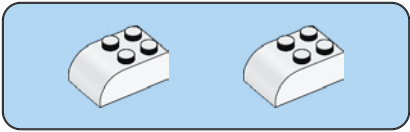

5

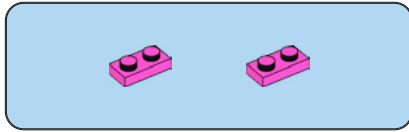
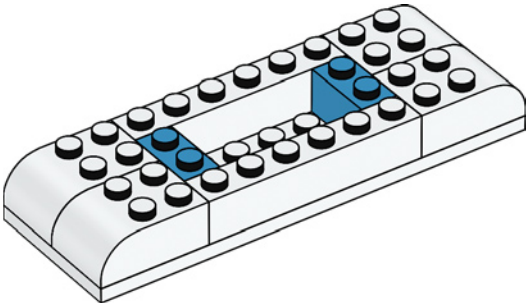

6

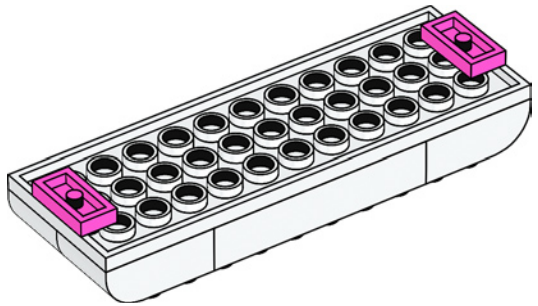

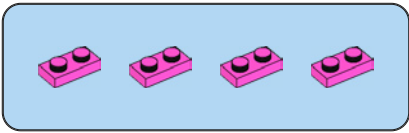

7

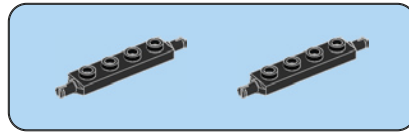
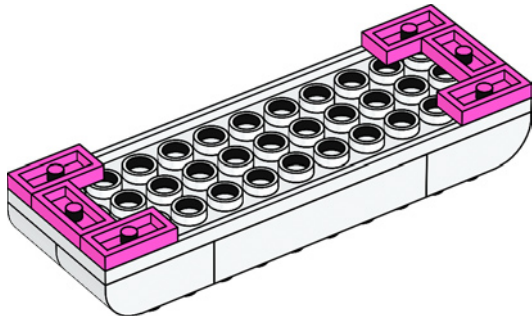

8

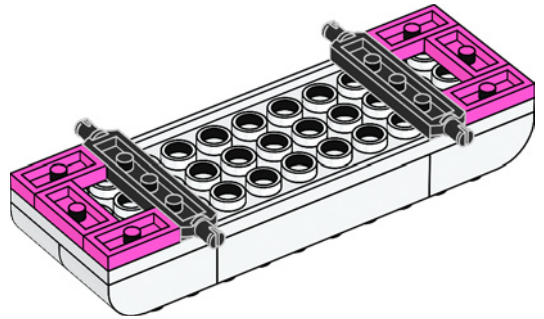

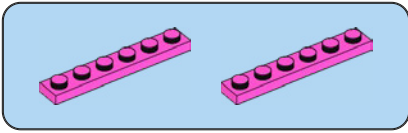

9

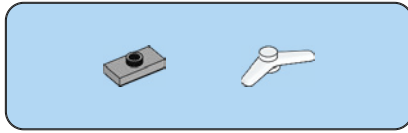
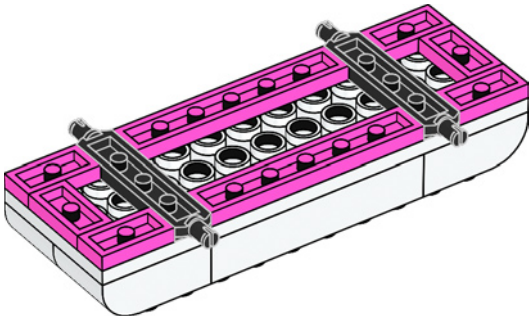

10

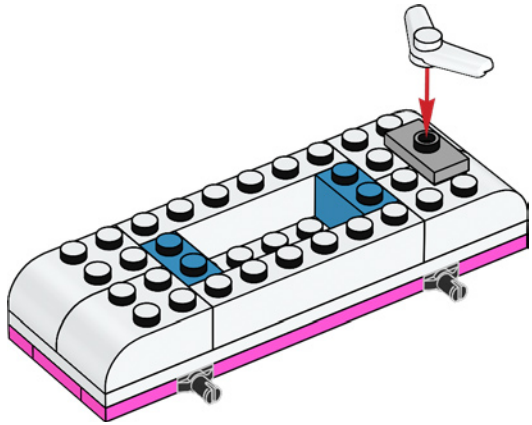



11

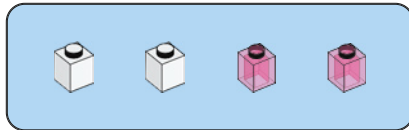
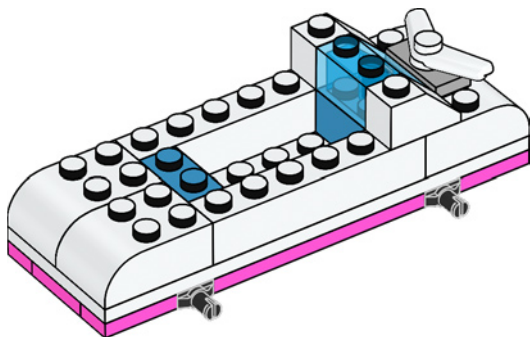

12

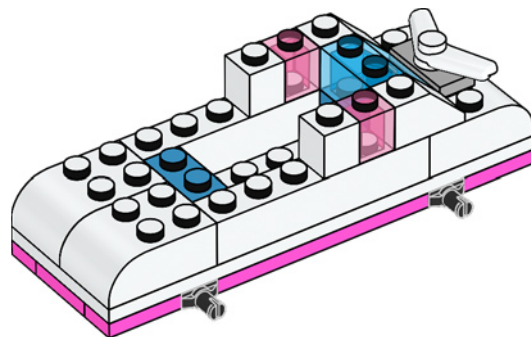

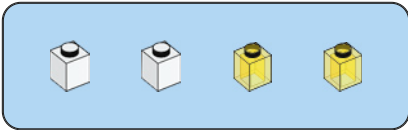

13

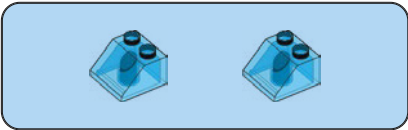
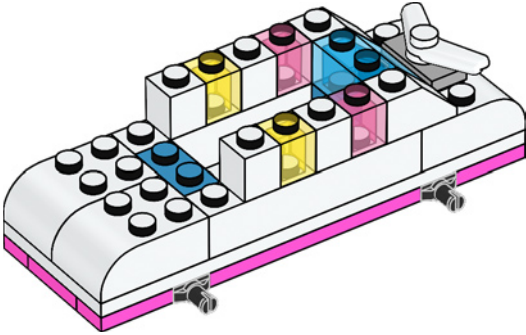

14

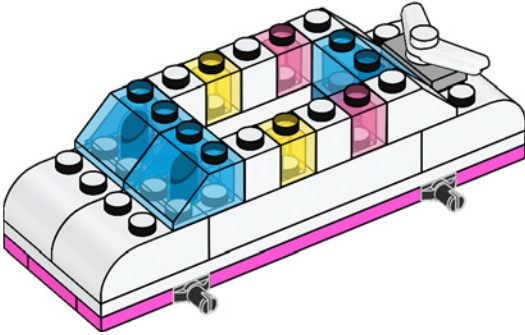



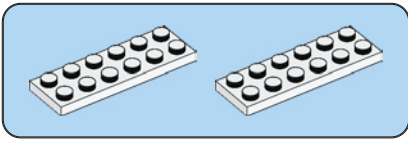

15

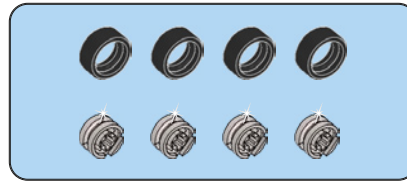
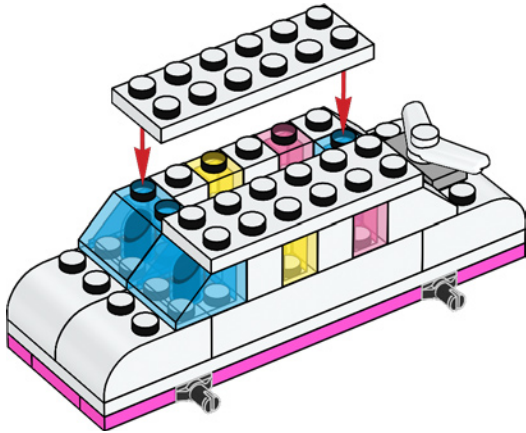

16

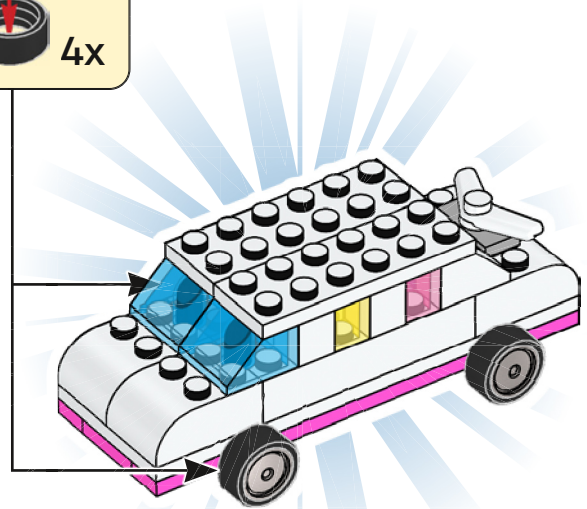
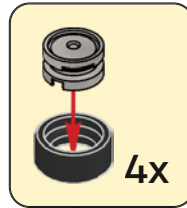

# Rebuild

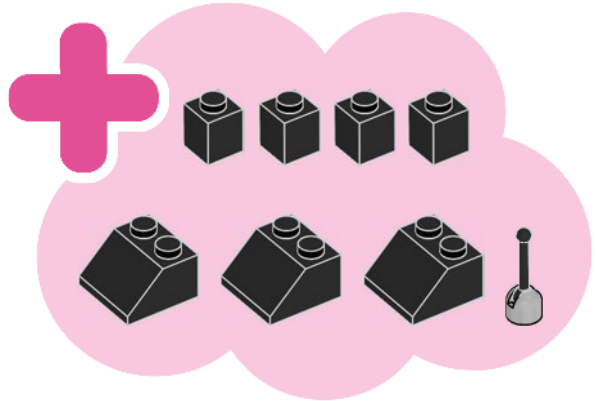

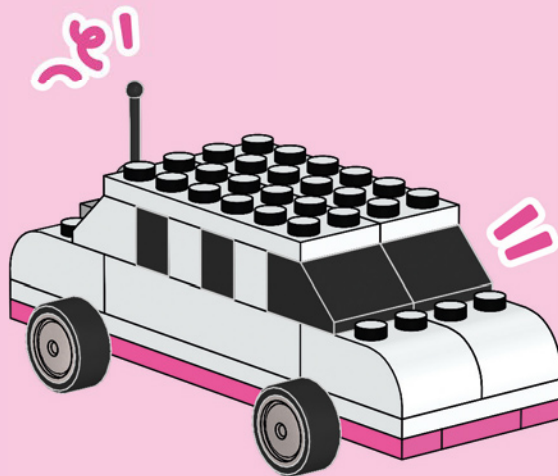

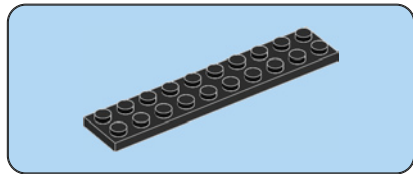
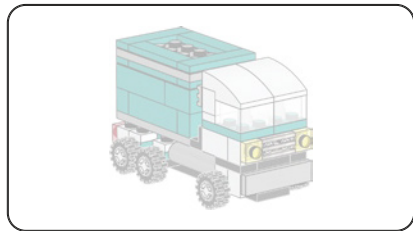

1

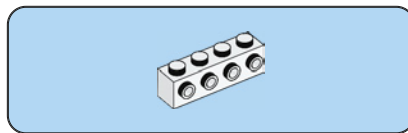
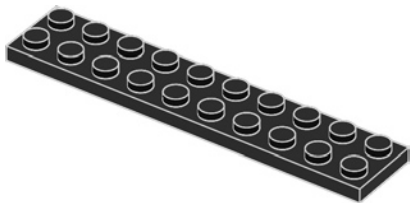

2

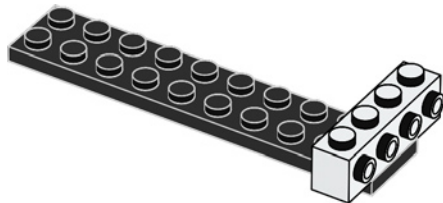

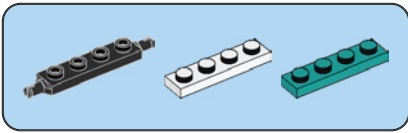

3

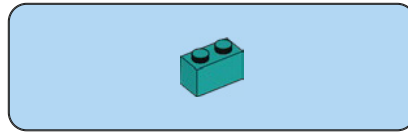
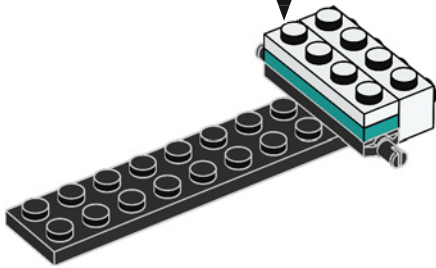
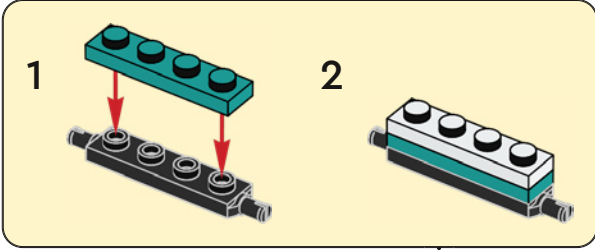

4

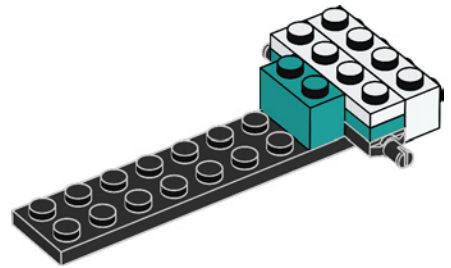

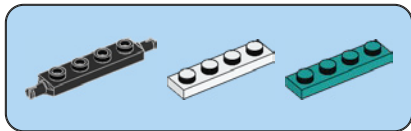

5

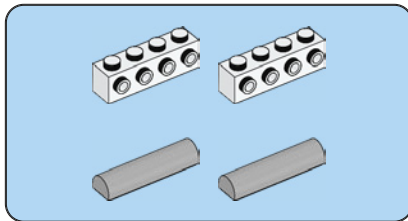
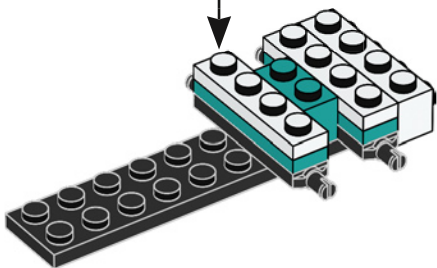
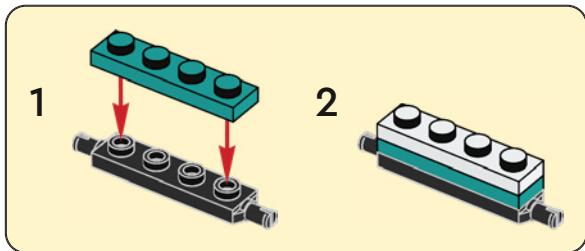

6

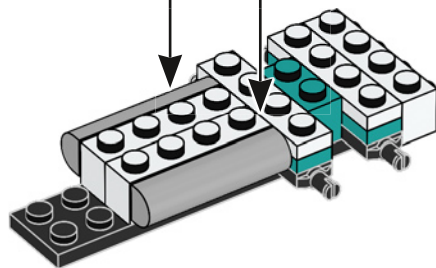
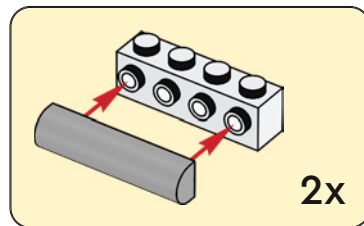

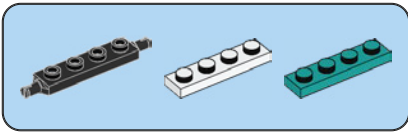

7

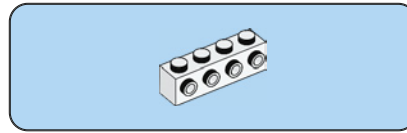
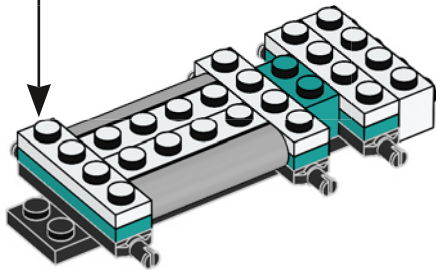
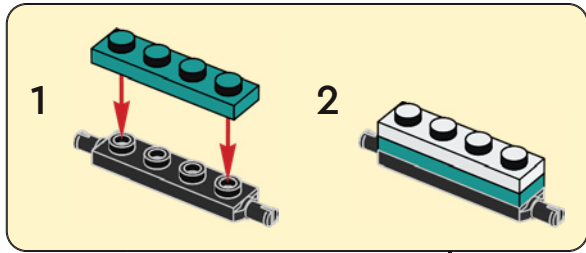

8

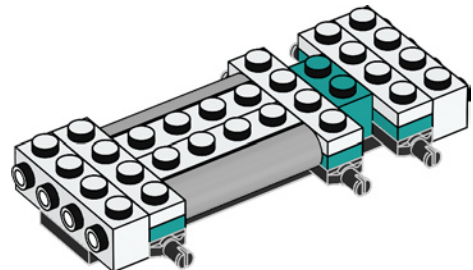

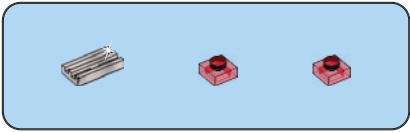

9

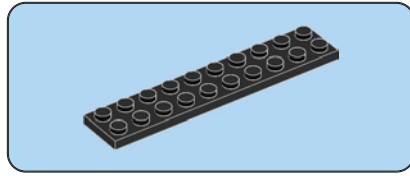
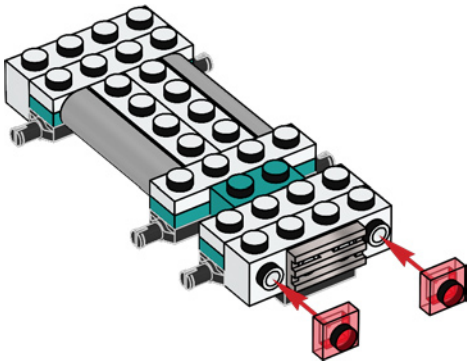

10

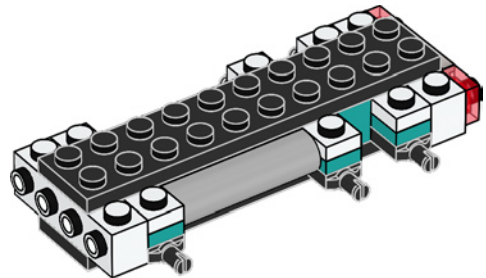



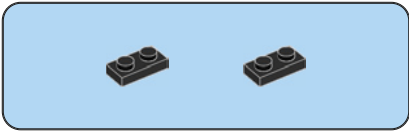

11

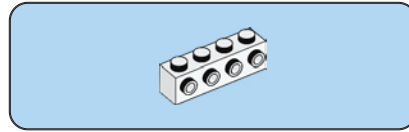
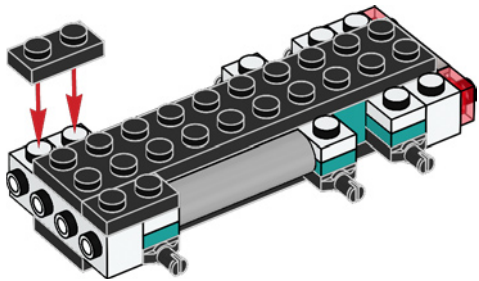

12

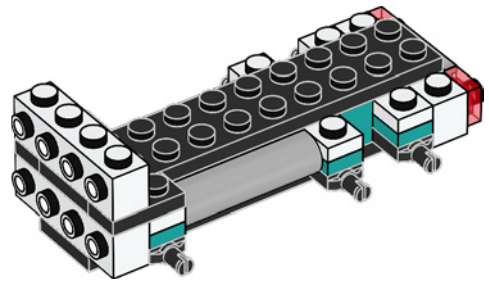

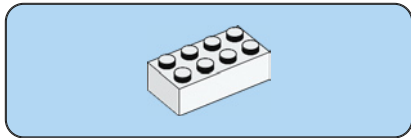

13

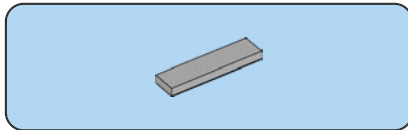
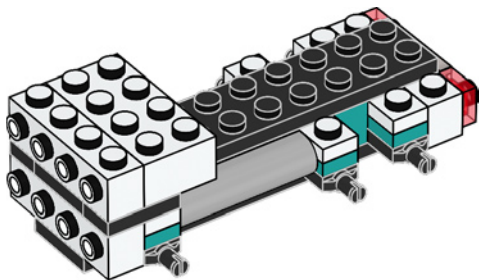

14

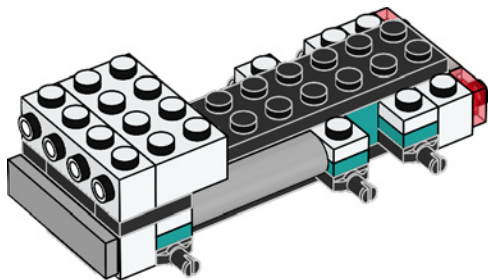

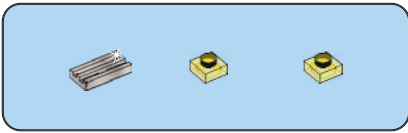

15

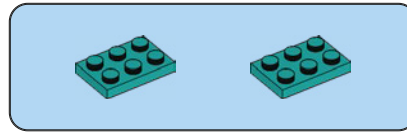
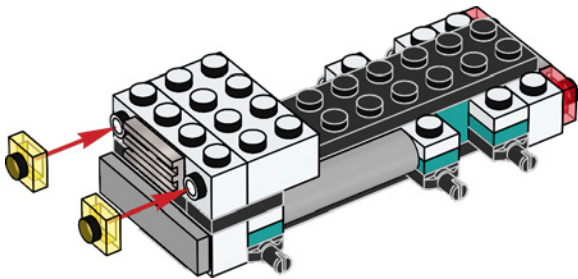

16

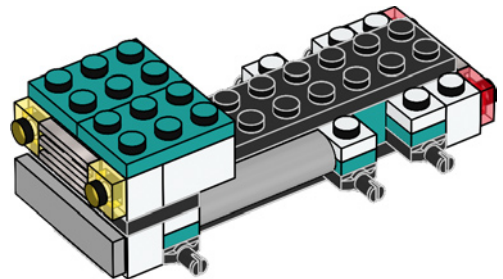

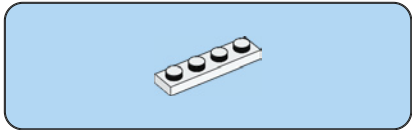

17

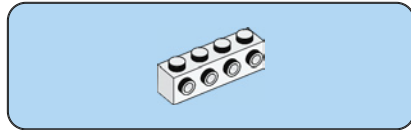
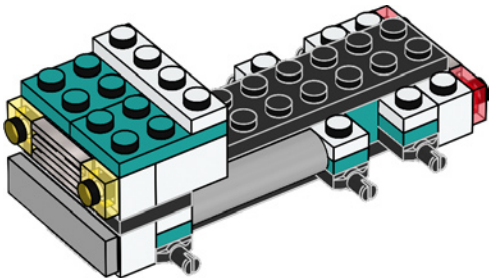

18

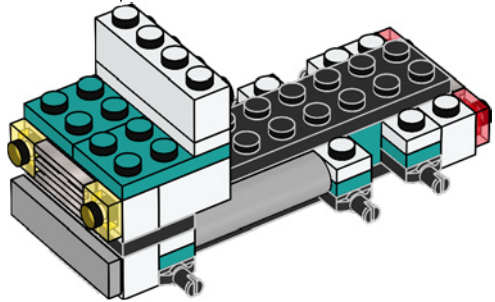
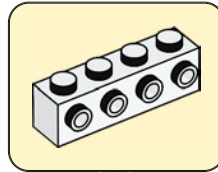

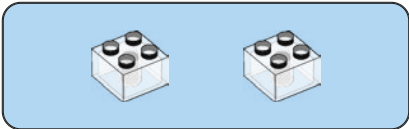

19

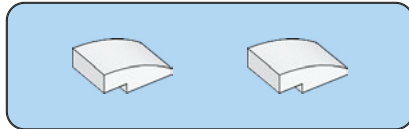
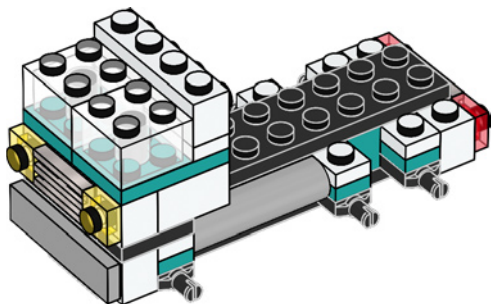

20

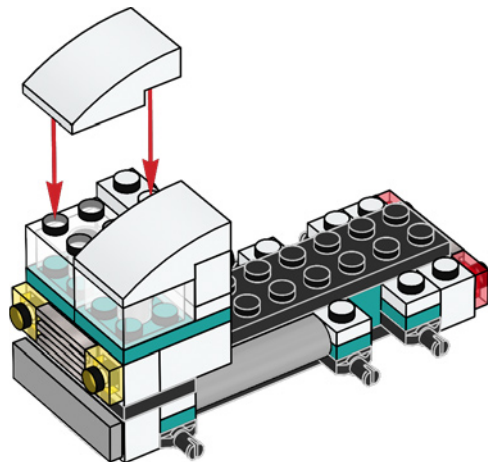

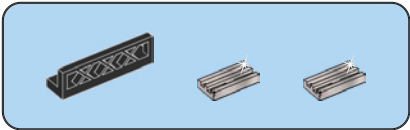

21

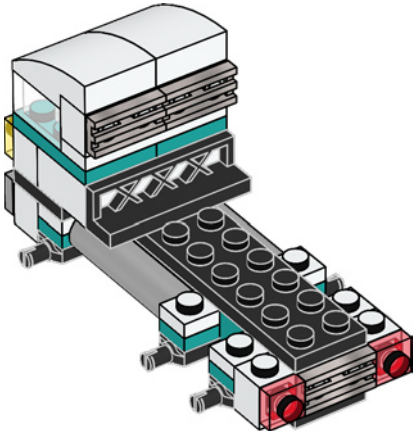

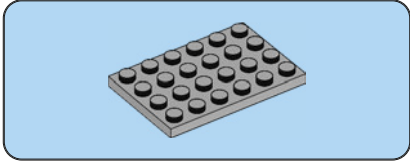
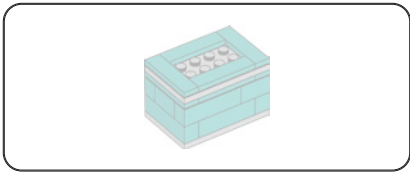

22

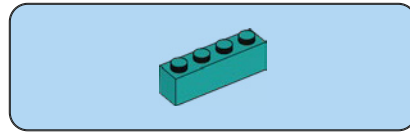
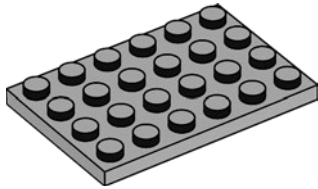

23

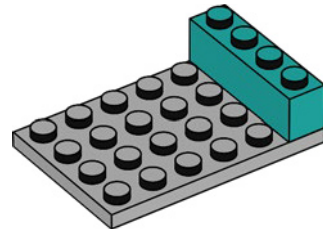





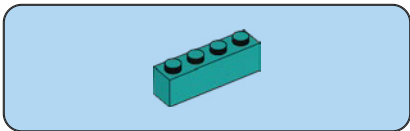

26

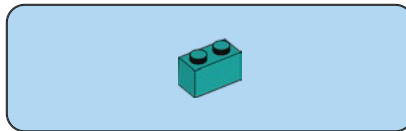
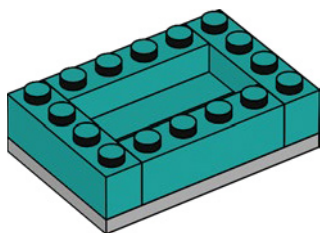

27

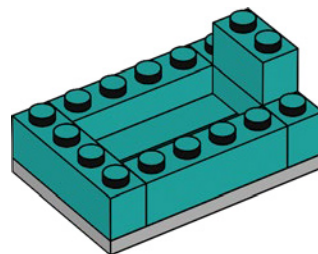



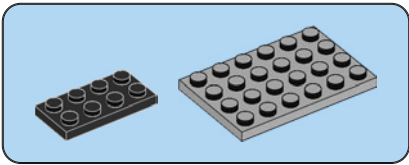

31

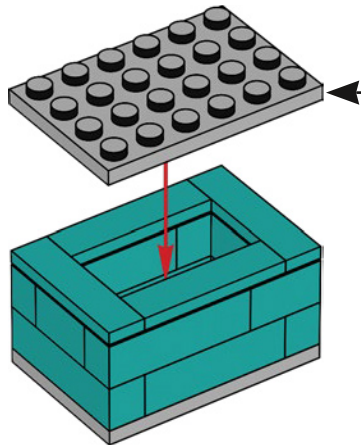
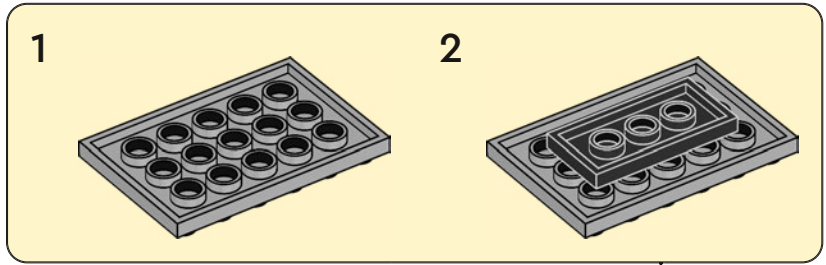

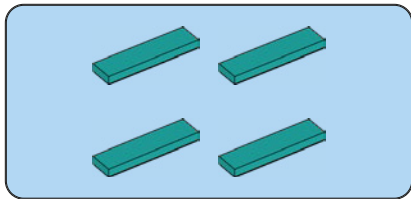

32

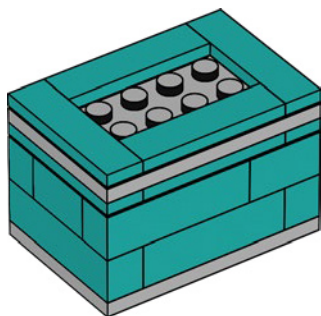

33

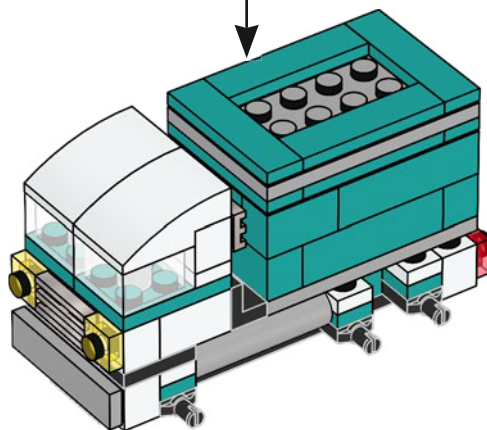

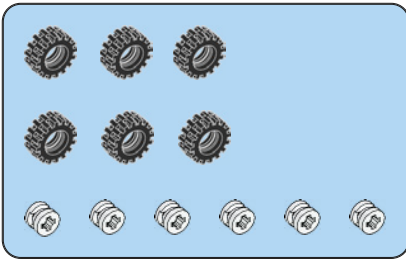

34

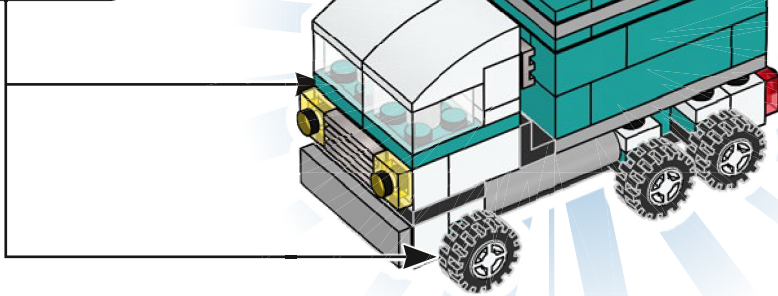
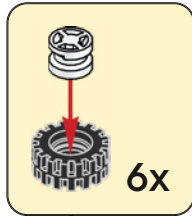

# Rebuild

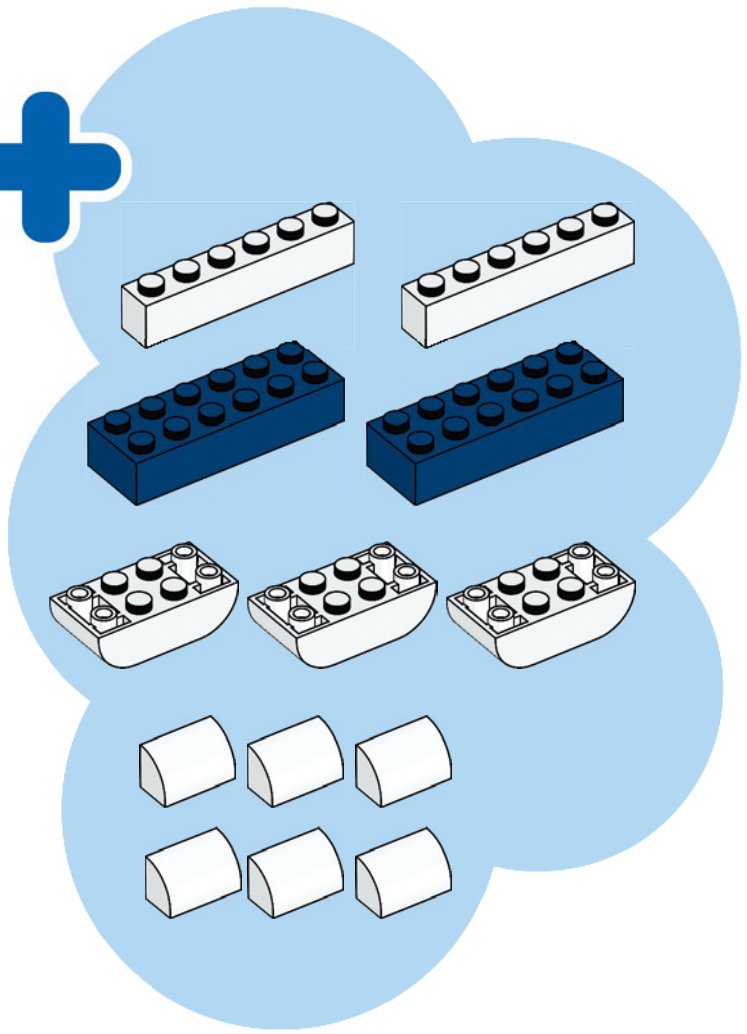
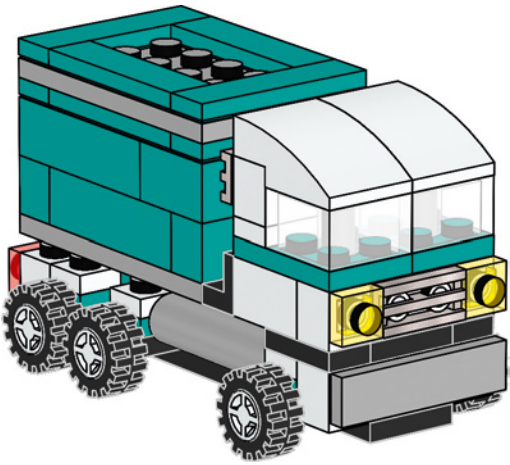

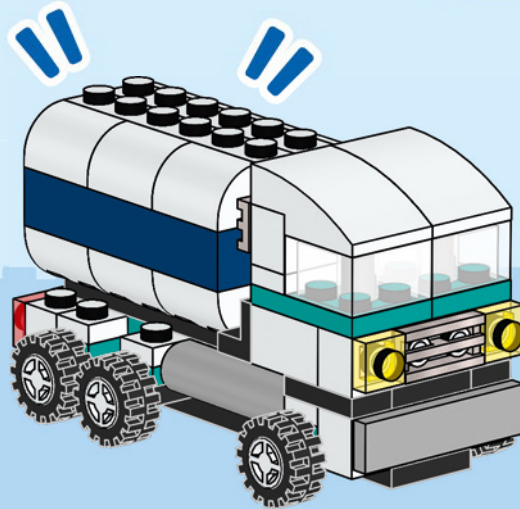
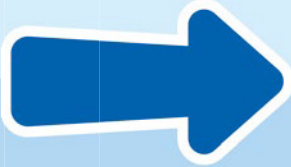
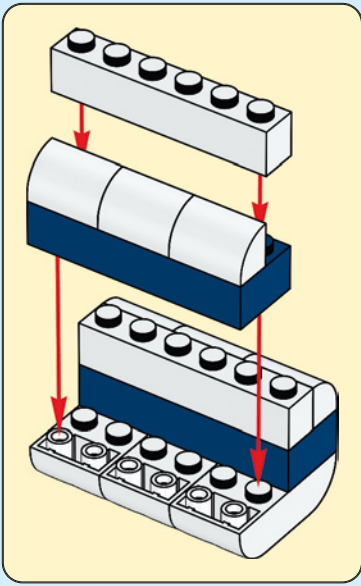

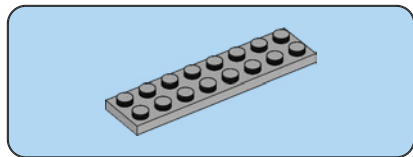
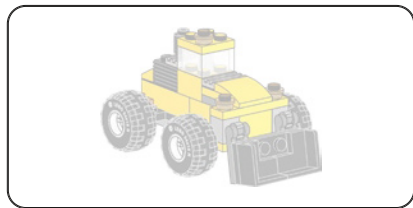

1

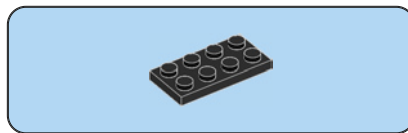
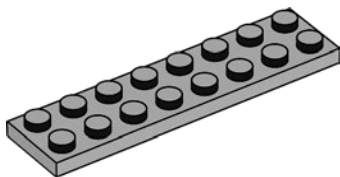

2





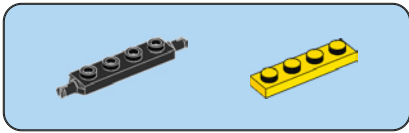

3

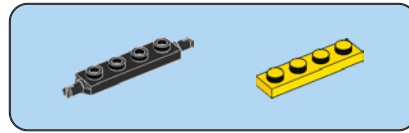
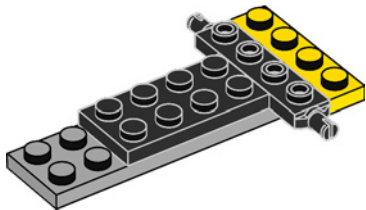

4

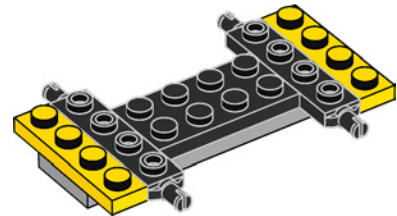

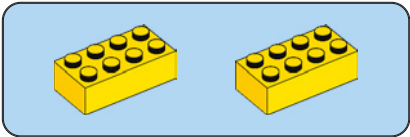

5

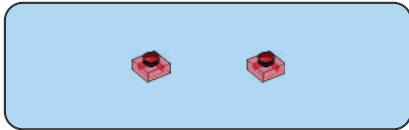
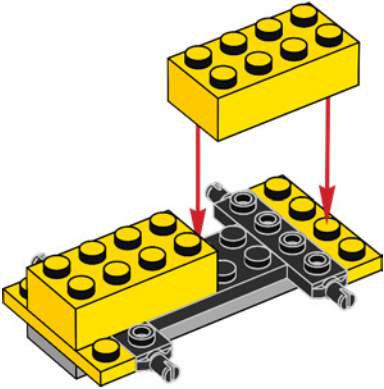

6

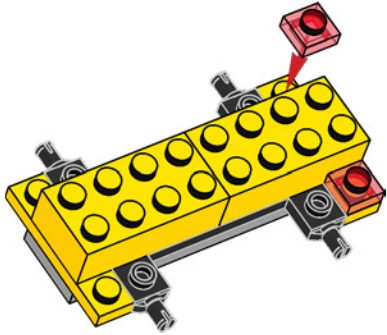

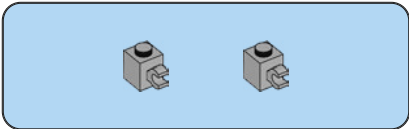

7

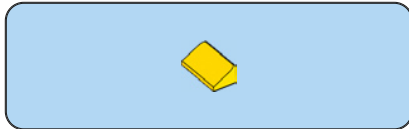
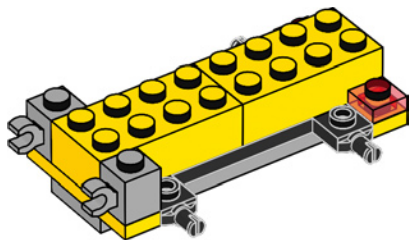

8

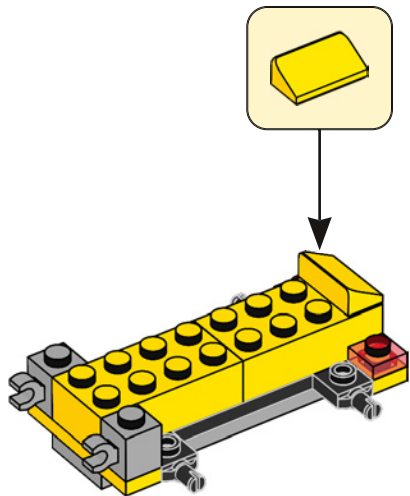

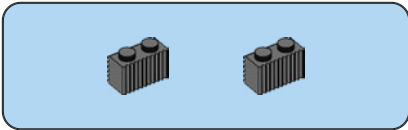

9

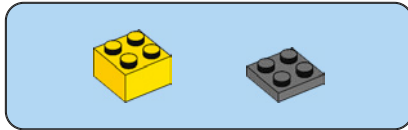
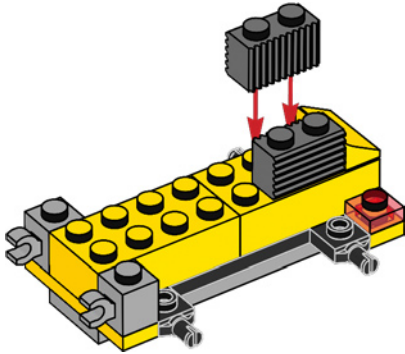

10

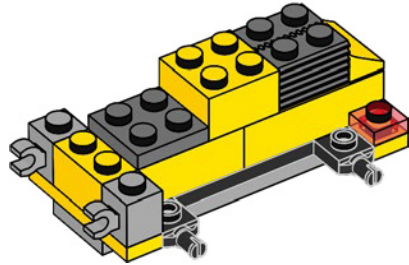

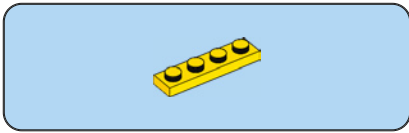

11

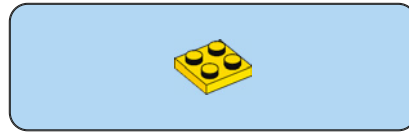
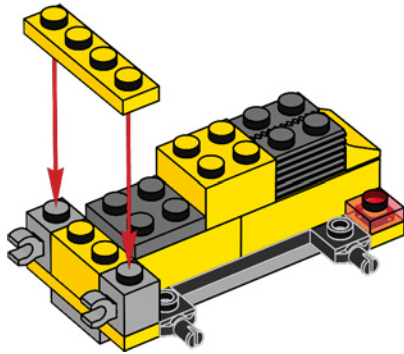

12

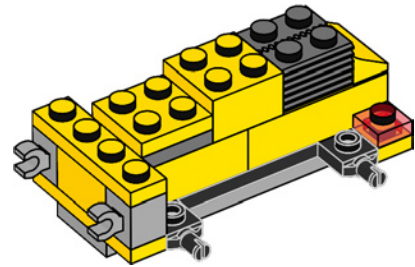

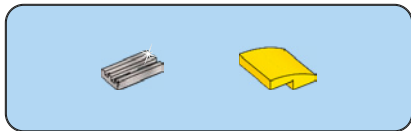

13

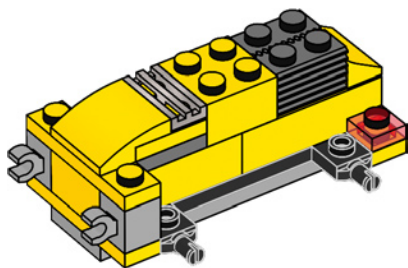

14

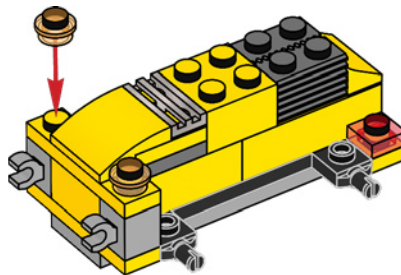

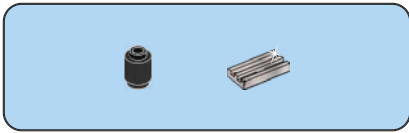

15

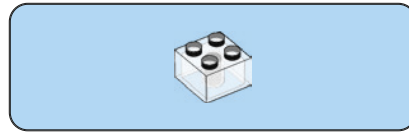
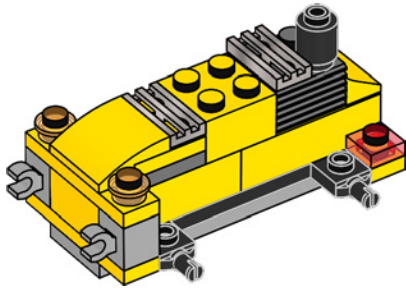

16

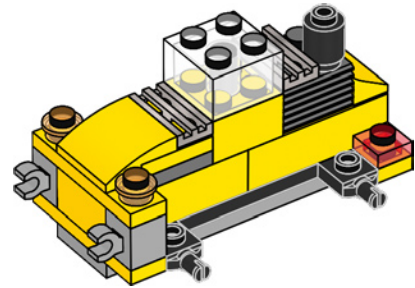

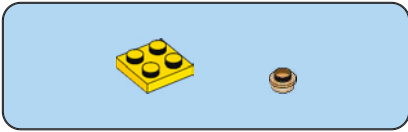

17

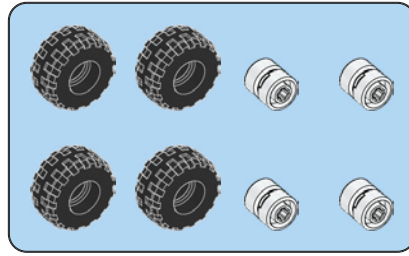
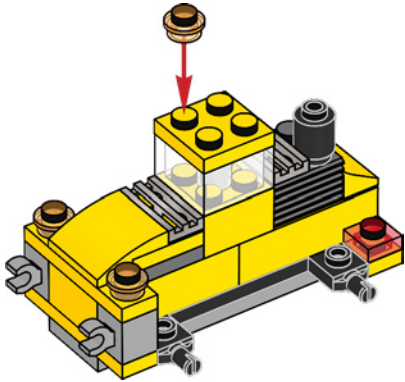

18

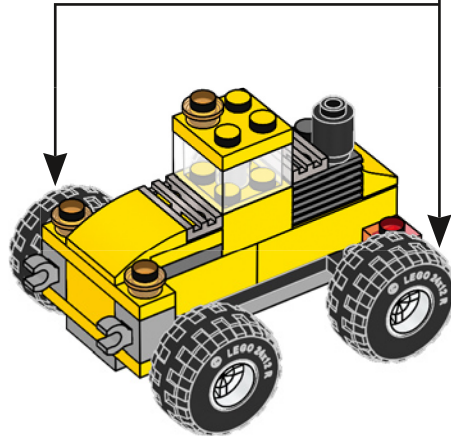
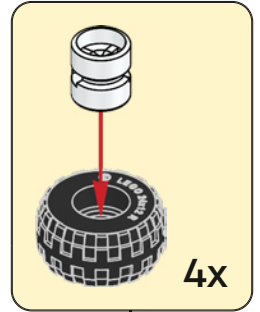



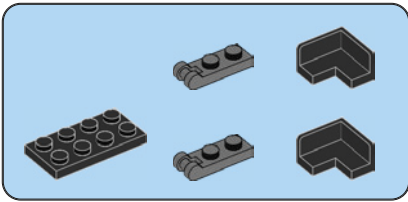

19

1

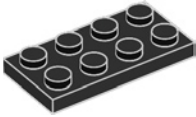

2

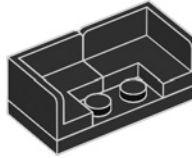

3

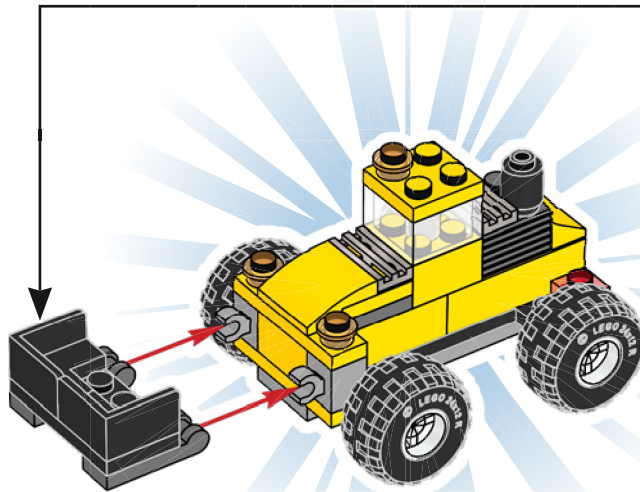
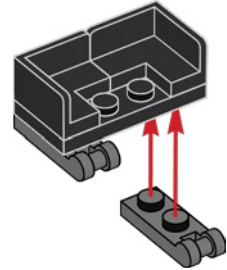

# Rebuild

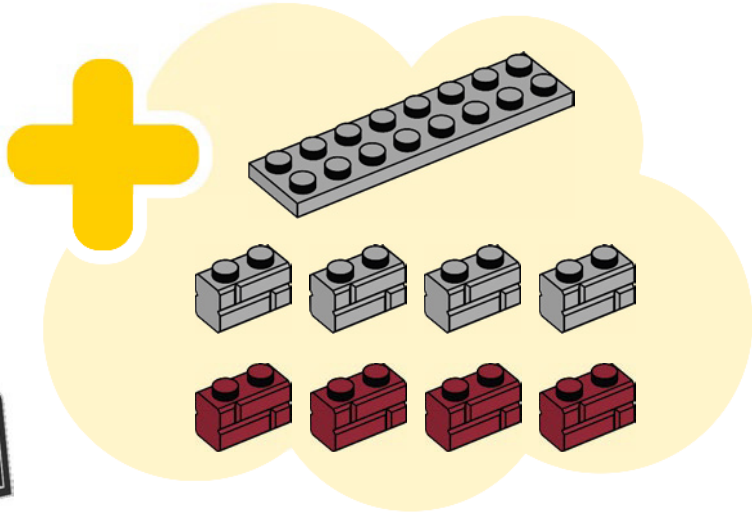
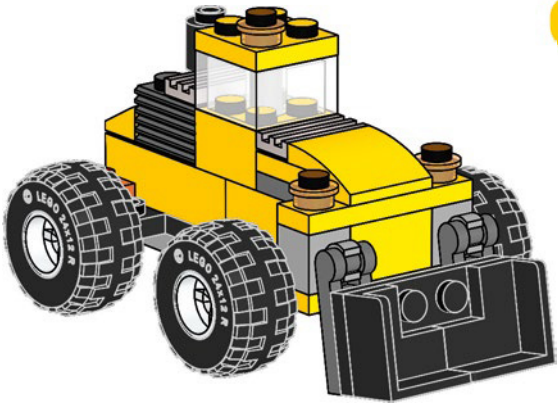

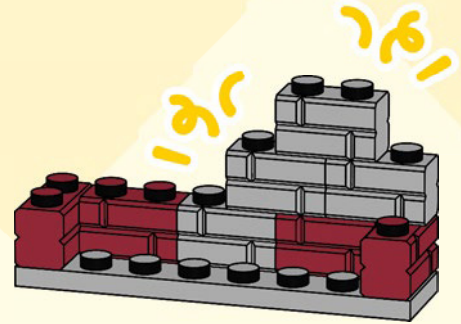
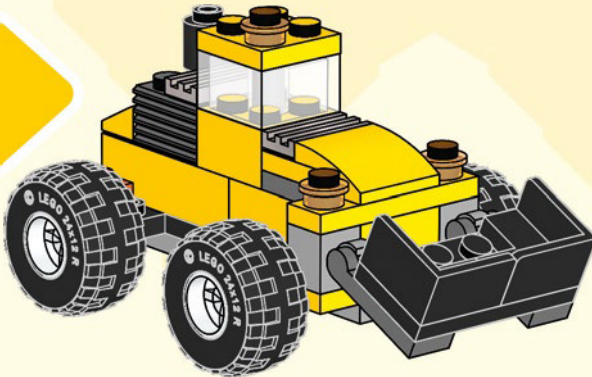
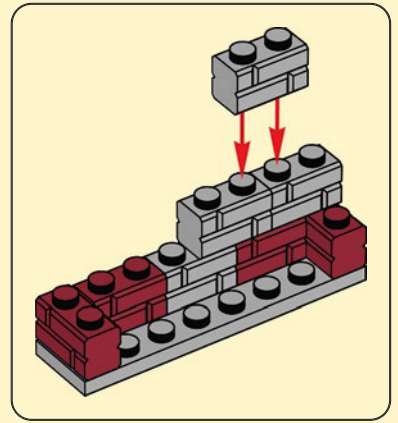



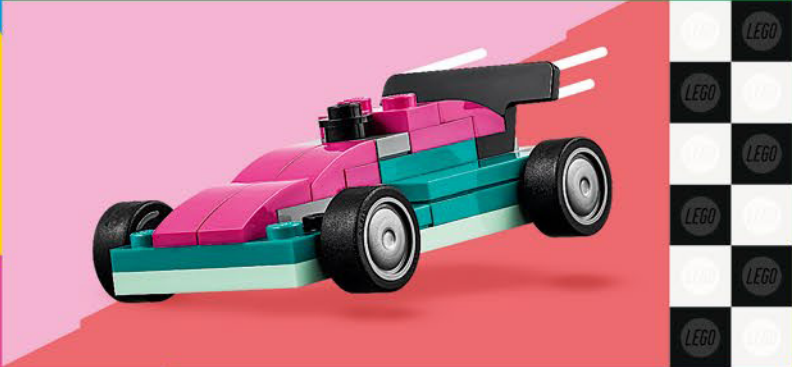















































Free  
Build





						
4x 6438901	10x 4143254	1x 4168072	4x 6438899	4x 4550348	8x 6004938	24x 6240030
						
16x 6194809		2x 6311210	2x 6311210	4x 6119197	6x 4653988	23x 6244904
	2x 6018101					
16x 300501		2x 383226	6x 4211210		14x 6004943	8x 6239418
	4x 6461062					
8x 4170457	6x 300101	2x 6218700	14x 306226	2x 6079007	4x 6254306	
		2x 4187209	6x 614126		4x 6213272	22x 6244886
2x 6044691	2x 4583297	8x 371026		5x 302224	4x 6213272	
	6x 300401	2x 300126	12x 300526		4x 6213272	16x 6208450
	2x 366501	8x 300126		4x 302124	4x 4655172	10x 6252042
	8x 6248827	2x 302001		9x 371024	2x 6151657	6x 6251290
	2x 4121932	2x 6461067	16x 4578677		12x 6057387	6x 6251289
	2x 6211335	8x 302026		6x 300124	6x 6132918	4x 6244887
	2x 4193068	24x 6338416	24x 4246901	2x 4597902	4x 6097094	14x 6252045
	2x 6313593	8x 6162541		8x 4617848	8x 6353192	4x 6277483
	4x 621501	2x 6371406	4x 6047276	8x 302326	6x 6443844	12x 6240227
	4x 6132212	2x 6371406	8x 302326	2x 6146220	2x 6097094	
	21x 371001	2x 408326	8x 302326	4x 6107188	8x 6353192	4x 6167741
	4x 379501		2x 6146220	2x 6146220	6x 6002148	4x 6240553
			4x 303926	4x 6107188	4x 4518890	
			4x 6344005	2x 4625027		



28x  
4624473



24x  
4619636



1x  
6259706



6x  
4113915



4x  
300528



4x  
4107736



2x  
6226928



2x  
6401819



4x  
6093908



6x  
4249891



6x  
4502089



2x  
6027625



2x  
6100239



10x  
6217659



4x  
6249417



14x  
6292786



10x  
6350418



8x  
6217660



8x  
6019155



2x  
6252037



6x  
371021



6x  
301021



12x  
300121



4x  
302021

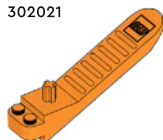

1x  
6240515



4x  
4221775



4x  
6320306



8x  
6248890



4x  
6000066



10x  
6066097



4x  
4211356



4x  
6402876



2x  
4211404



3x  
4211406



4x  
6022032



4x  
6141592



1x  
6421475



1x  
6429058



2x  
6465291



8x  
6258095



2x  
6464975



2x  
6470230



8x  
4187743



2x  
4504850



1x  
6102906



8x  
4210636



4x  
4211094



6x  
4521187



5x  
4211061



YOU COULD **WIN**

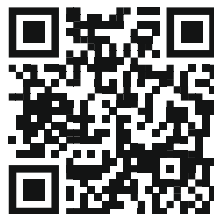

Scan this QR code or go to **LEGO.COM/PRODUCTFEEDBACK** and give us your short feedback about this LEGO® set for a chance to win a cool LEGO prize.

Terms and Conditions apply\*

**EN: YOU COULD WIN.** Terms and Conditions apply\* **DE: Du könntest GEWINNEN.** Es gelten die Teilnahmebedingungen\* **FR: Tu pourrais GAGNER.** Des conditions s'appliquent\* **IT: Potresti VINCERE tu.** Termini e condizioni sono applicabili\* **ES: Puedes GANAR.** Aplican términos y condiciones\* **PT: Poderá GANHAR.** Aplicam-se termos e condições\* **ZH: 轻松获奖. 条款和条件适用\*** **PL: Szansa na WYGRANĄ.** Obowiązują warunki korzystania\* **CS: Máte šanci VYHRÁT.** Platí všeobecné smluvní podmínky\* **SK: Máte šancu VYHRAŤ.** Platia všeobecné zmluvné podmienky\* **HU: TE IS NYERHETSZ.** Felhasználási feltételek érvényesek\* **RO: Ai putea CÂȘTIGA.** Se aplică termeni și condiții\* **BG: Можете да СПЕЧЕЛИТЕ.** Има определени правила и условия\* **LV: Tu vari LAIMĒT.** Ir spēkā noteikumi un nosacījumi.\* **ET: Sul on võimalus VÕITA.** Kehtivad tingimused\* **LT: Jūs galite LAIMĖTI.** Taikomos sąlygos\*

\*[LEGO.com/productfeedback-terms](https://www.lego.com/productfeedback-terms)