

1

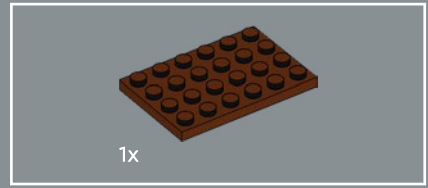

2

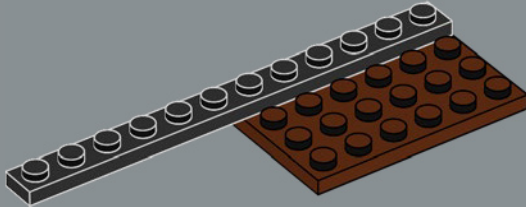

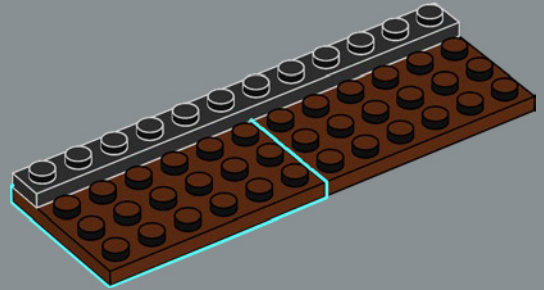

3

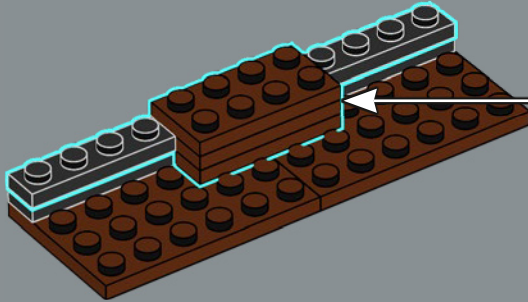
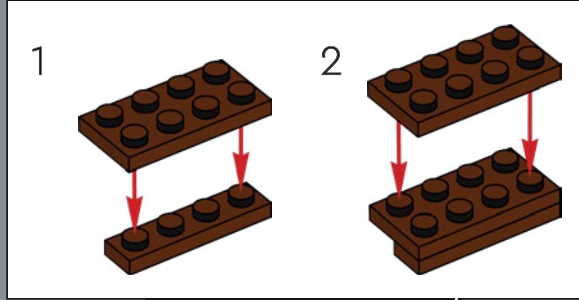

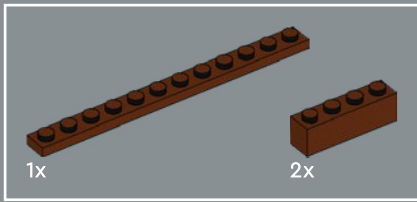

4

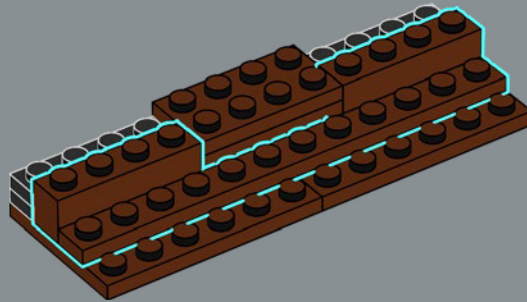
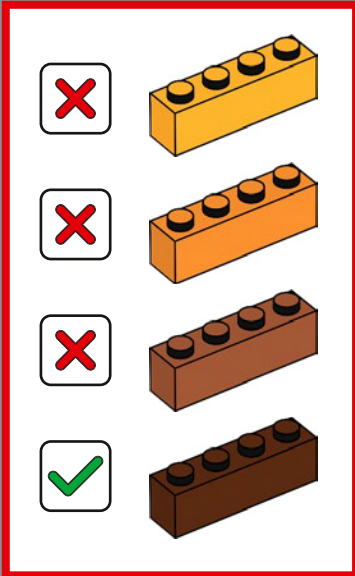



2x



4x

5

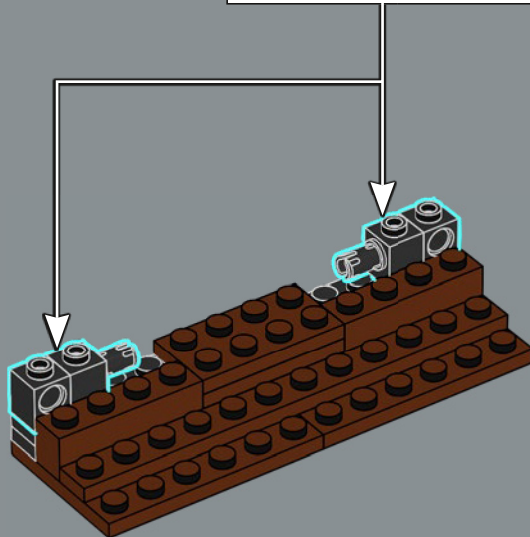
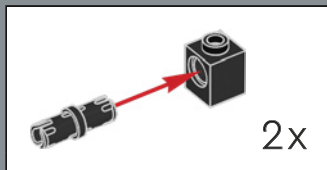

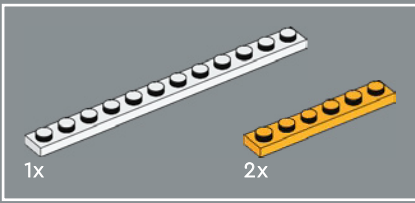

6

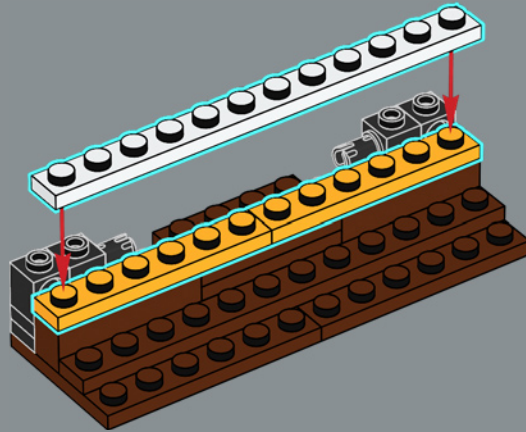
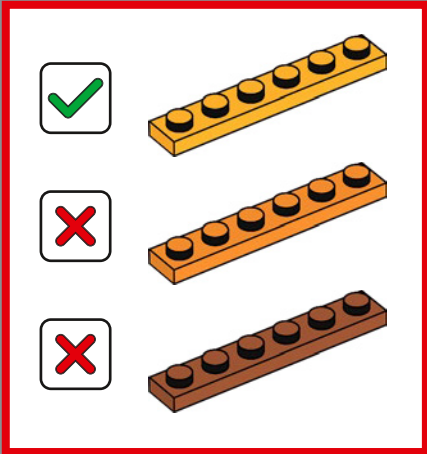

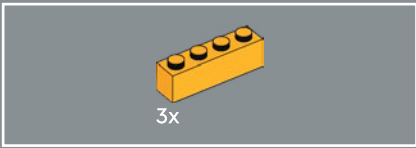

7

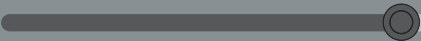
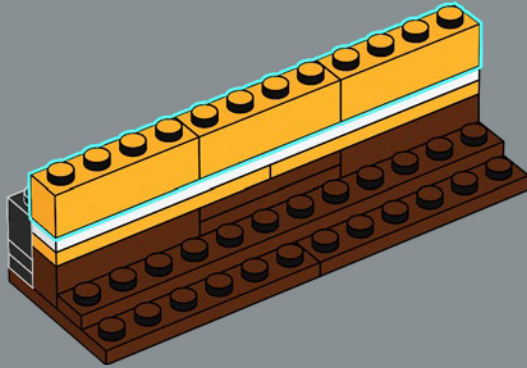
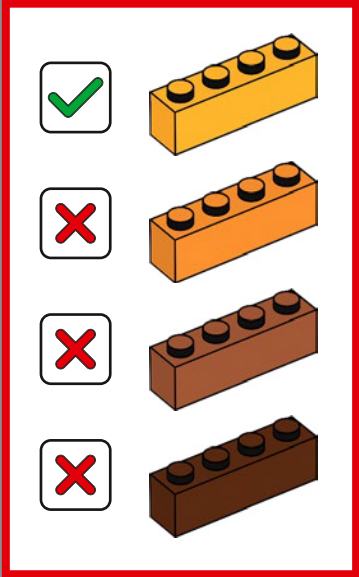



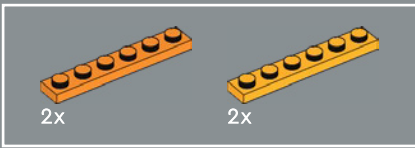

8

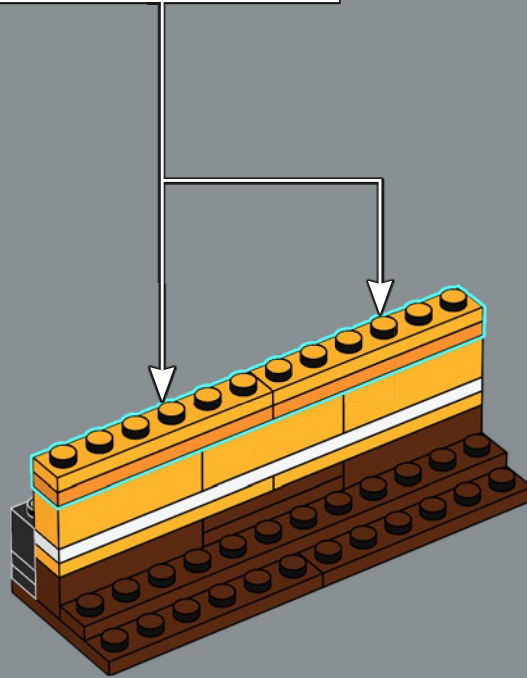
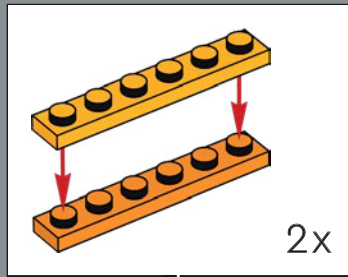
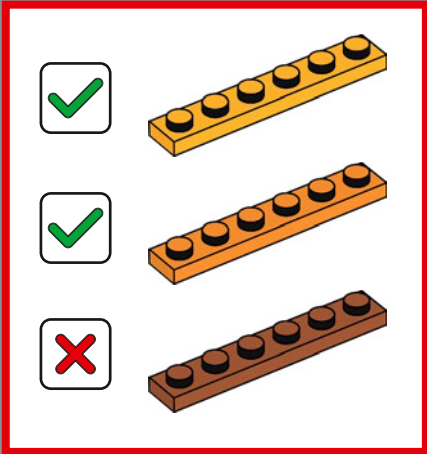

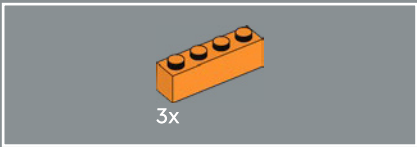

9

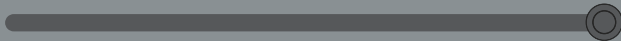
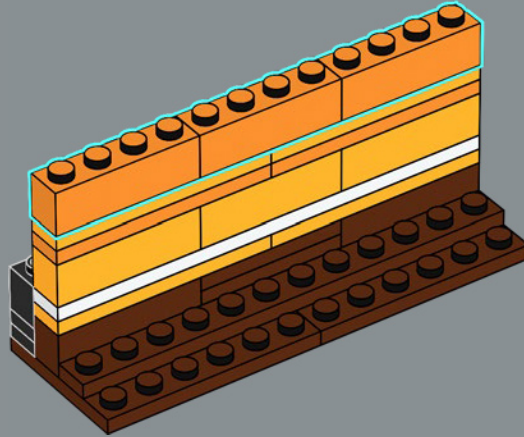
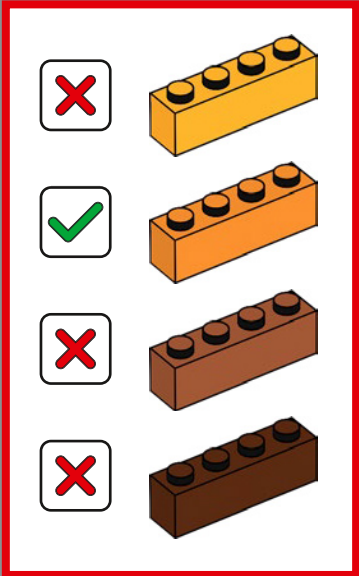

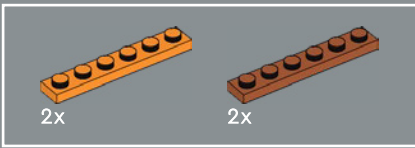

10

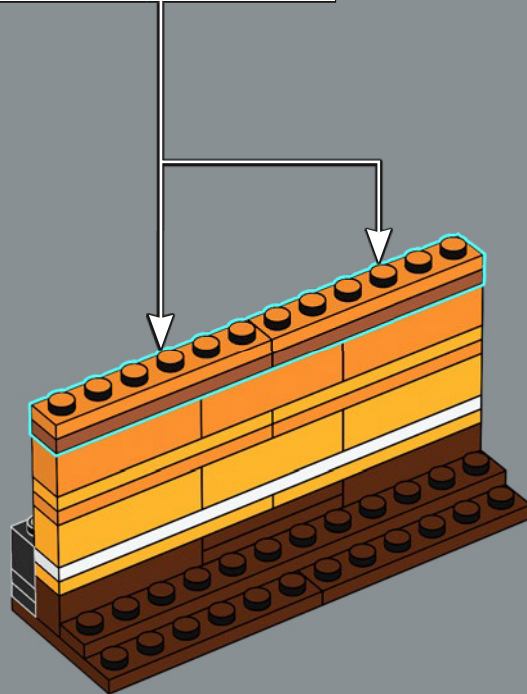
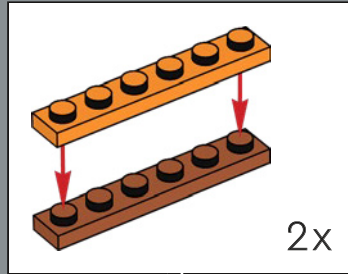
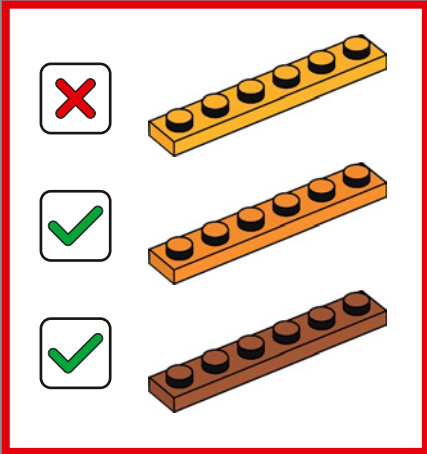

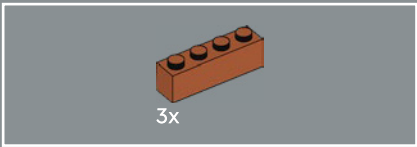

11

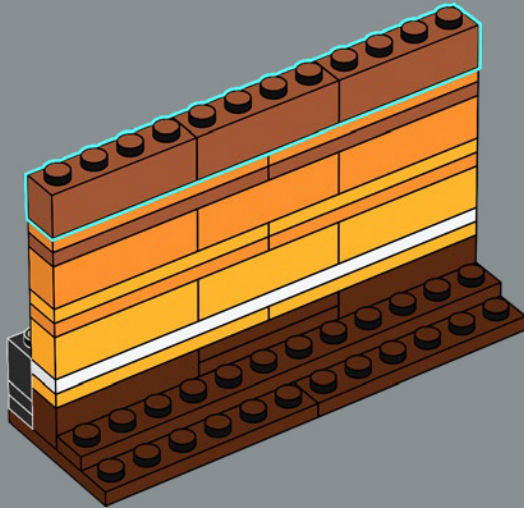
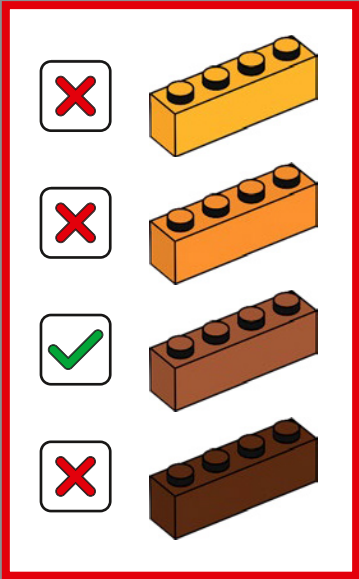

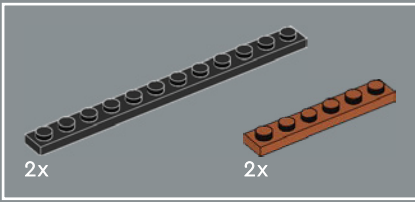

12

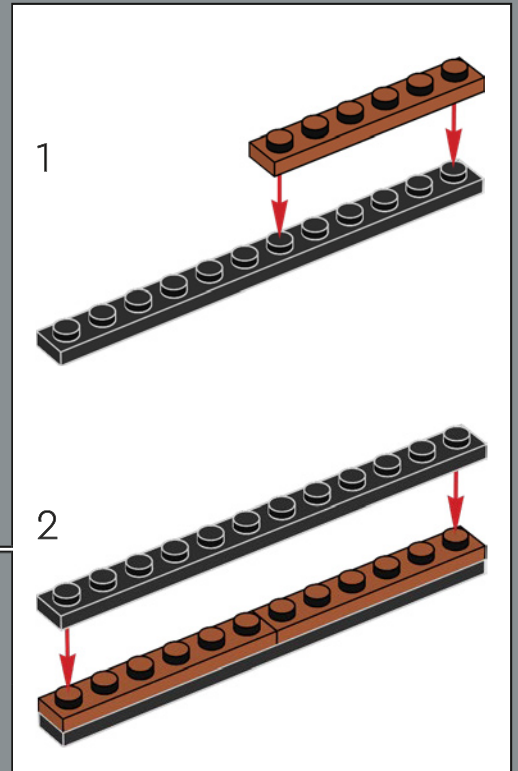
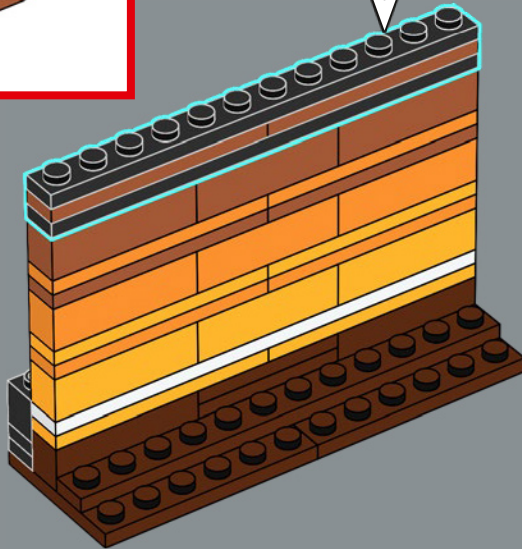
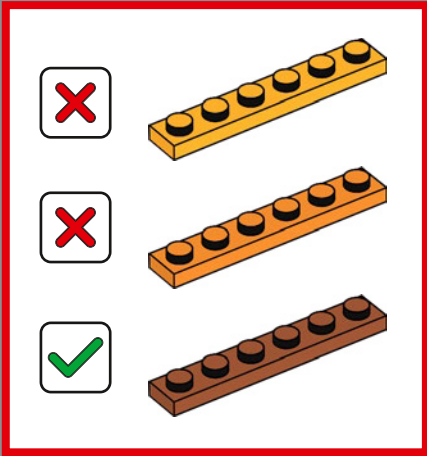

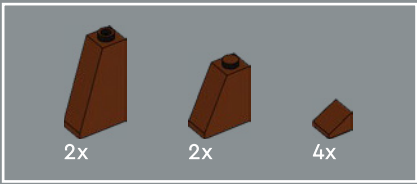

13

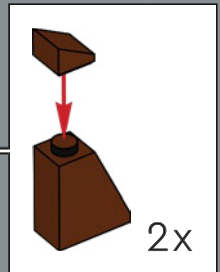
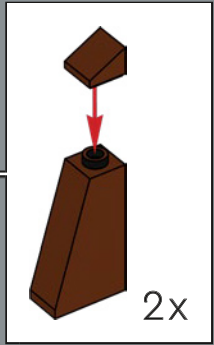
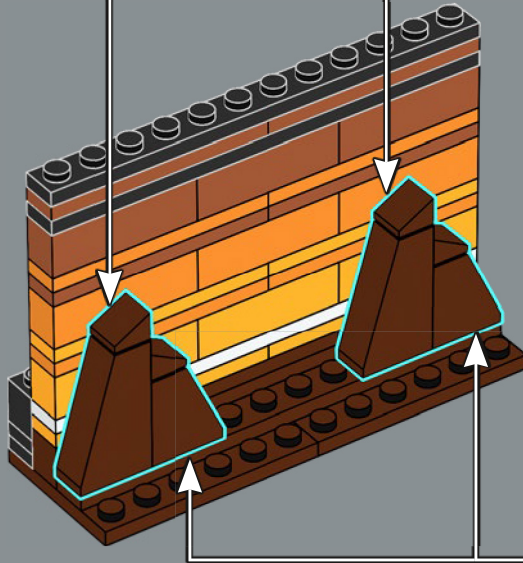



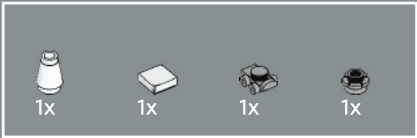

15

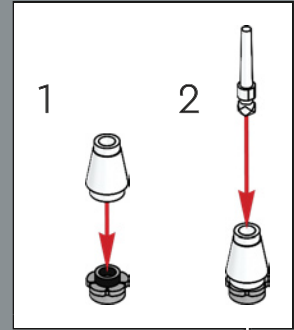
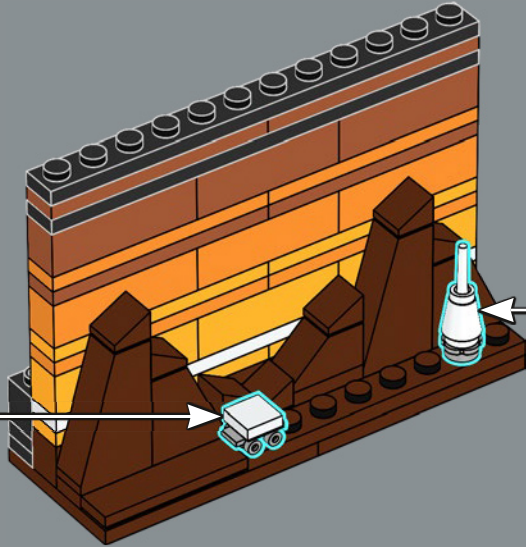
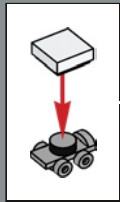



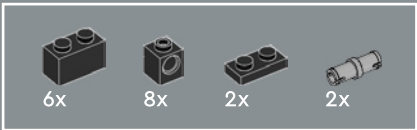

16

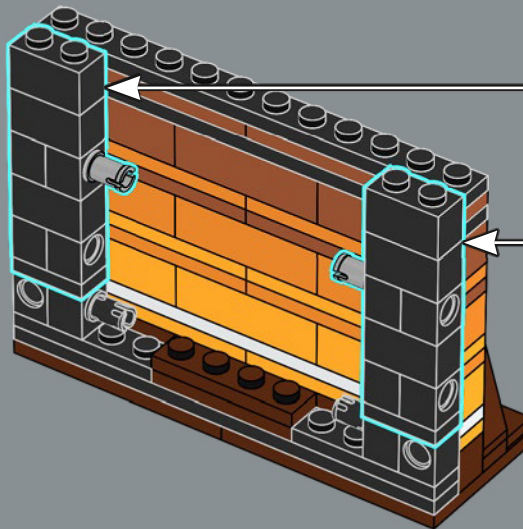
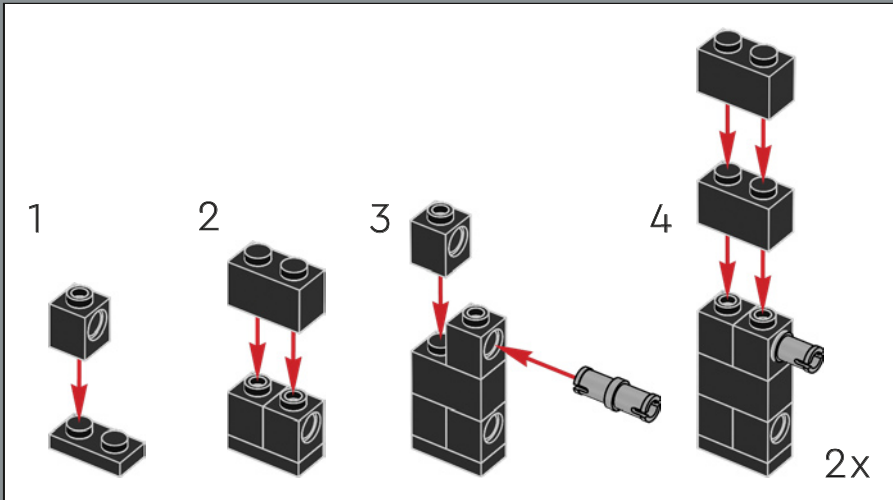

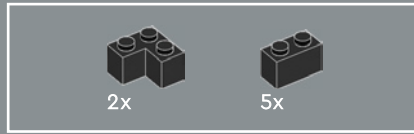

17

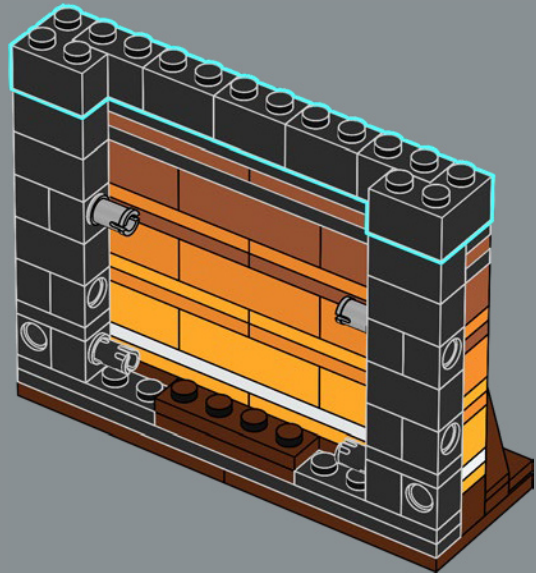



2x



4x

18

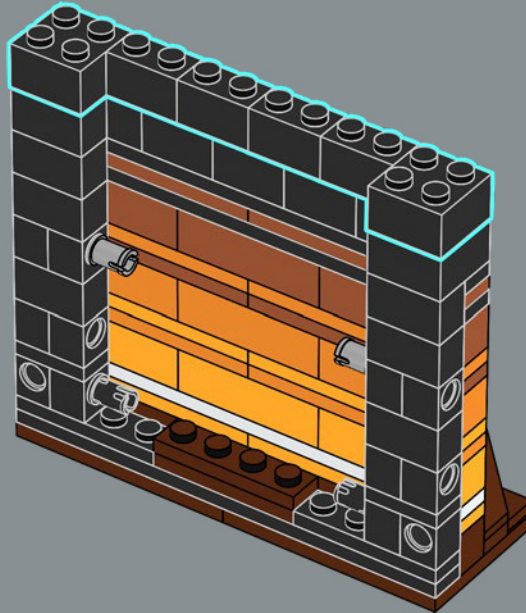

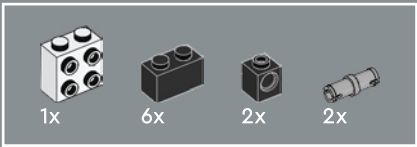

19

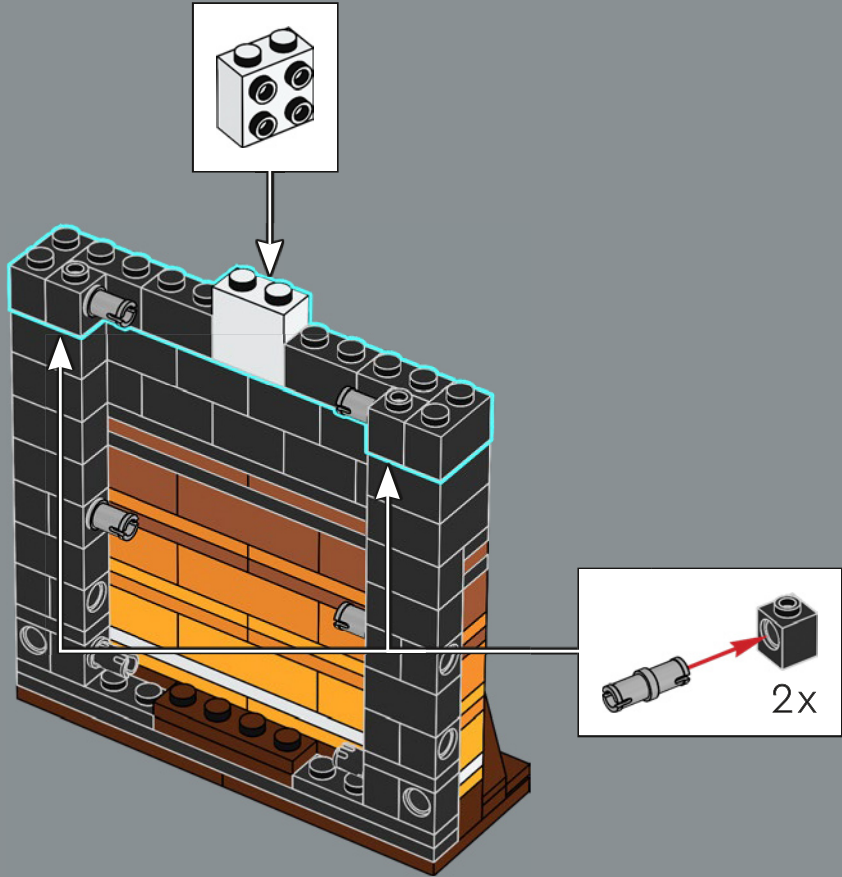

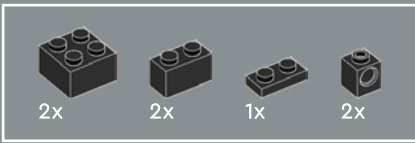

20

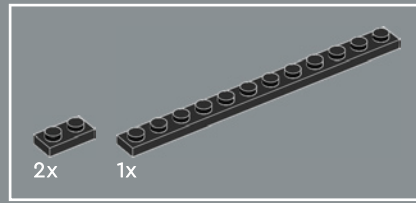
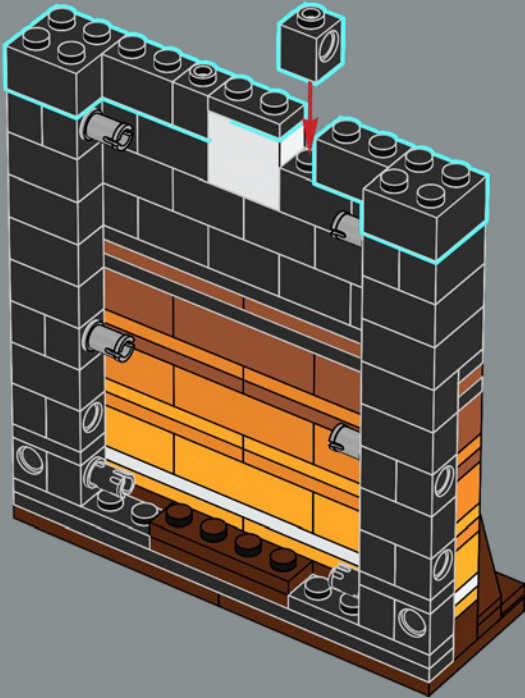

21

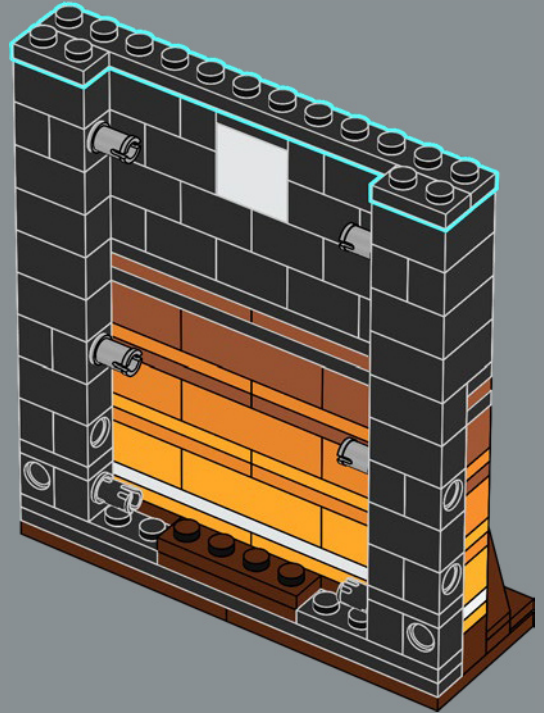

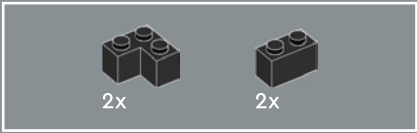

22

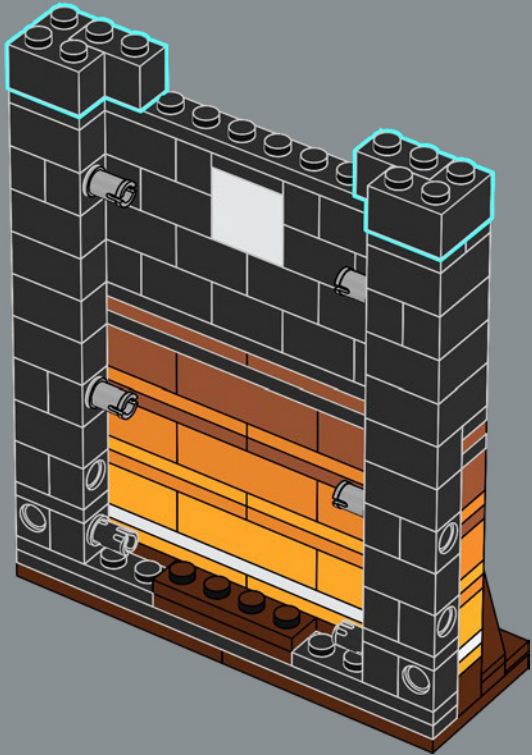

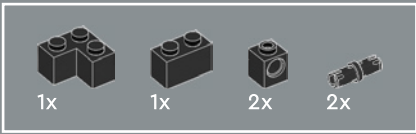

23

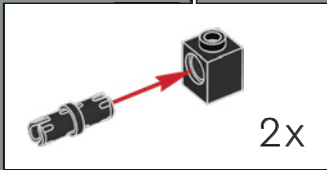
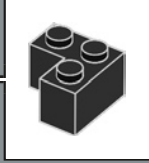
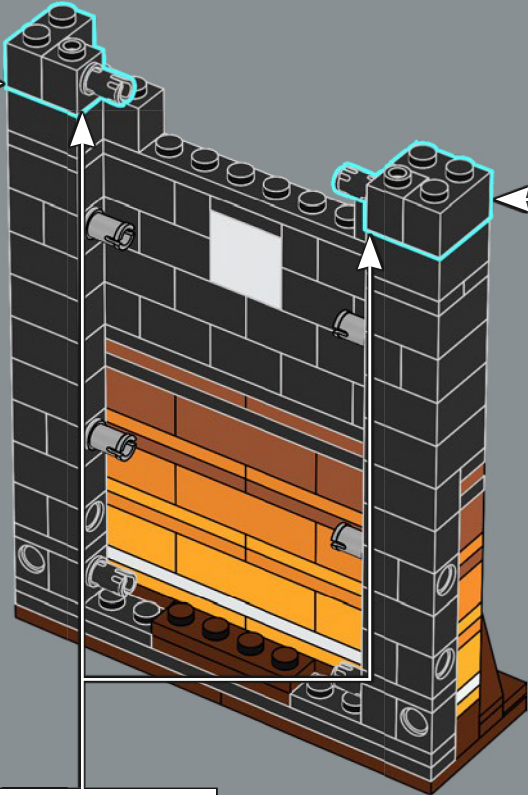
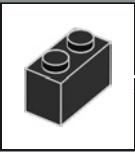



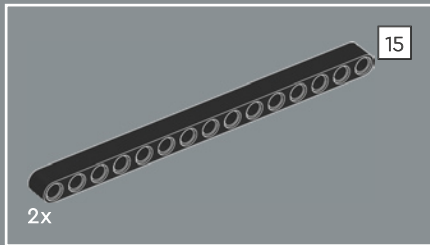

24

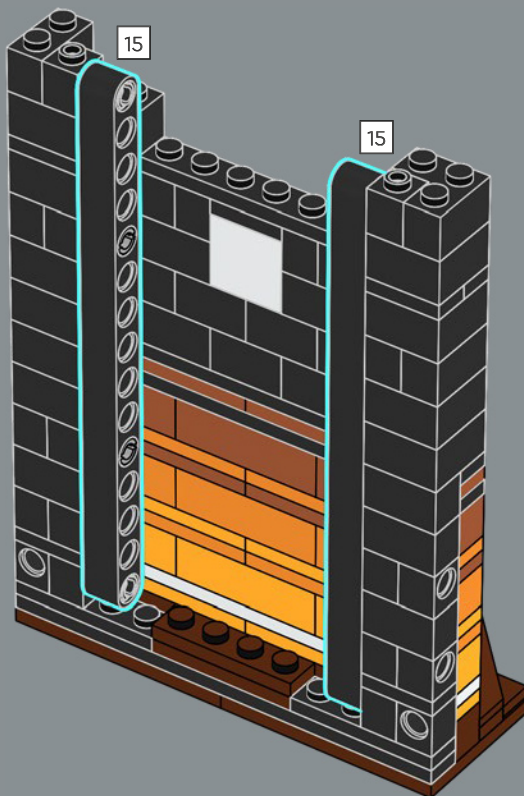



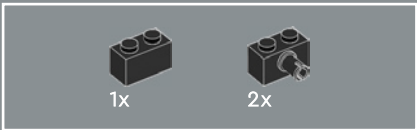

25

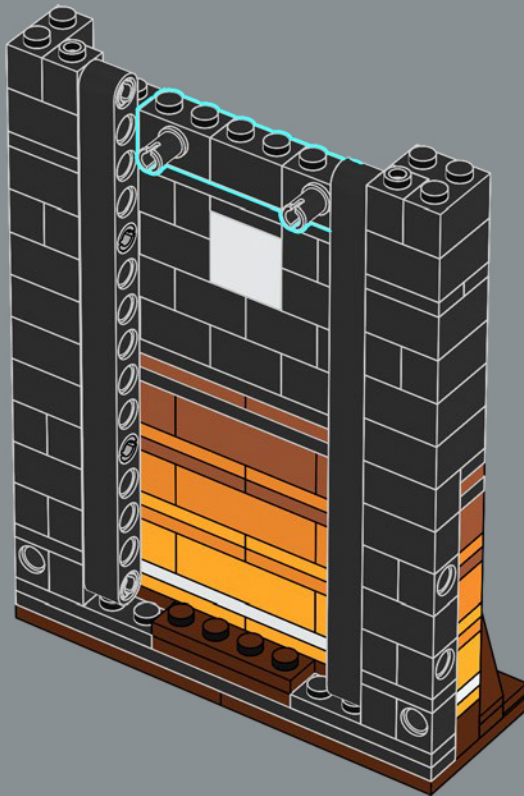



26

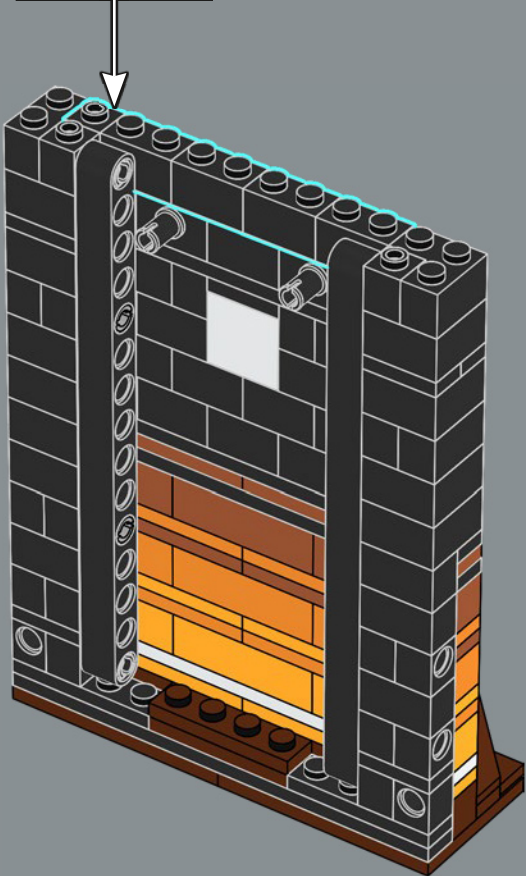
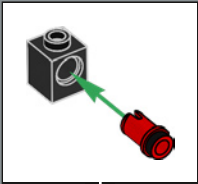

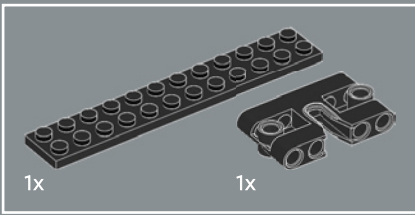

27

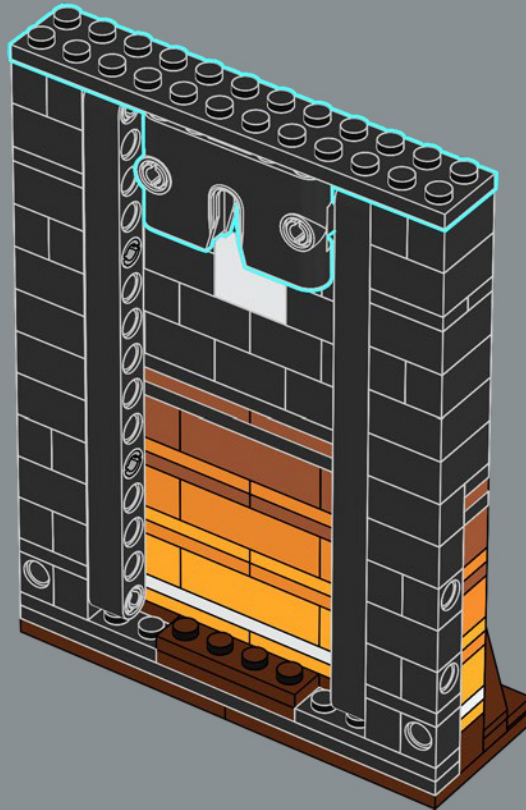

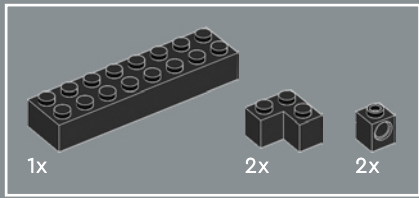

28

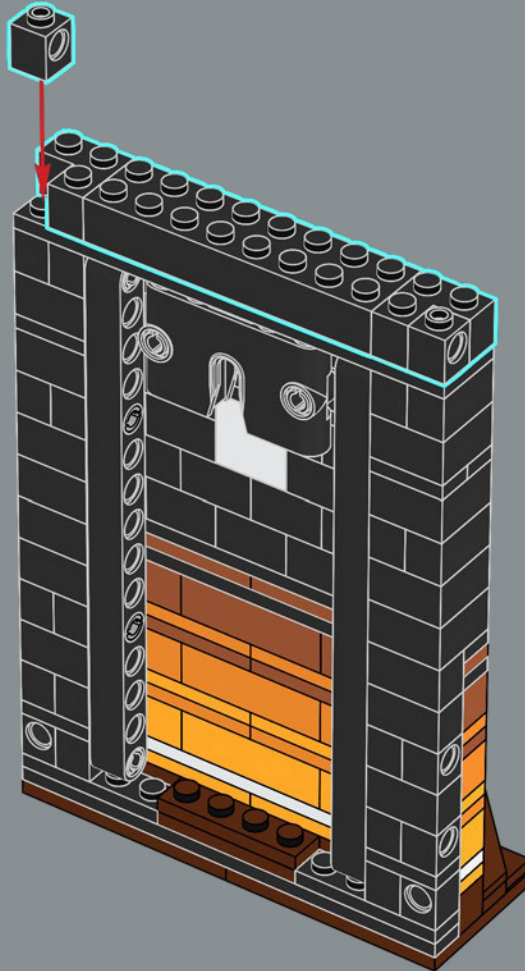

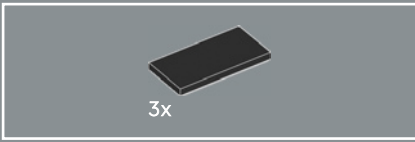

29

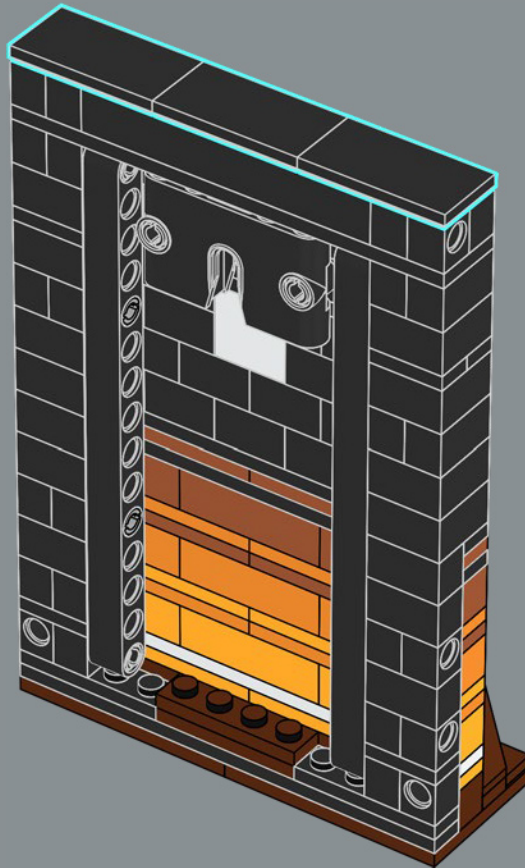

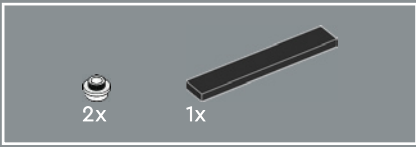

30

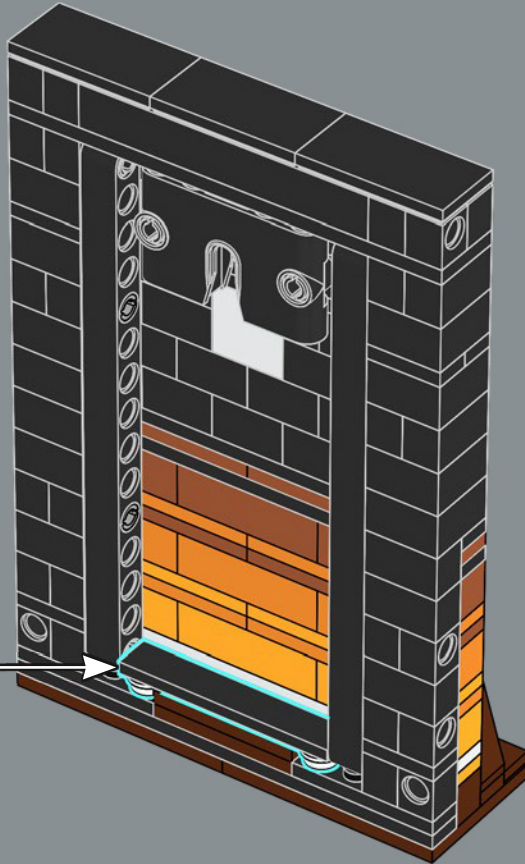
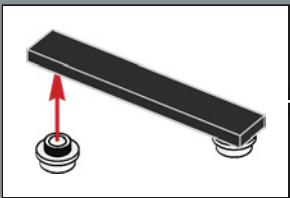

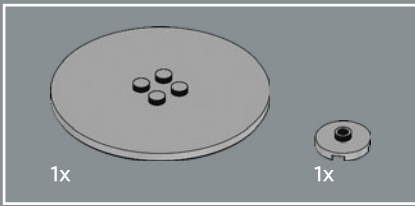

31

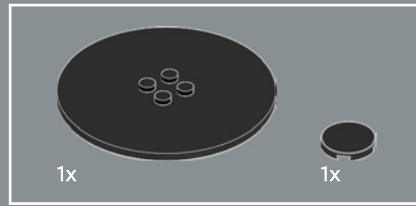

32





