



21348

1



Booklet available in English on
Livret disponible en français sur
Folleto disponible en español en



LEGO® Builder



WE'RE MAKING OUR PACKAGING MORE SUSTAINABLE

We're transitioning from single-use plastic to paper-based packaging. As we progress, you may find a mix of paper and plastic in our boxes.

NOUS RENDONS NOS EMBALLAGES PLUS DURABLES

Nous passons des emballages en plastique à usage unique aux emballages à base de papier. Durant la transition, vous pourriez trouver un mélange de papier et de plastique dans nos boîtes.

QUEREMOS HACER MÁS SUSTENTABLES NUESTROS MATERIALES DE EMBALAJE

Estamos cambiando las bolsas de plástico desechables por bolsas con base de papel. Conforme avanzamos en este propósito, puedes encontrar una mezcla de papel y de plástico en nuestras cajas.

LEGO.com/sustainable-packaging



BUILDER



Apple and the Apple logo are trademarks of Apple Inc., registered in the U.S. and other countries and regions. App Store is a service mark of Apple Inc. Google Play and the Google Play logo are trademarks of Google LLC. Tencent and the Tencent logo are trademarks of Tencent Inc.

LEGO.com/devicecheck



LEGO® Builder

Exclusive DUNGEONS & DRAGONS® Adventure

In 1974, with the roll of a die, a groundbreaking new role-playing game opened the portal to an immersive fantasy world unlike any other game before. The lure of endless adventures beckoned players to explore their imagination, create their own stories, games, characters and rules in the real world, and form alliances and friendships with new species as they battle monsters in strange realms in the game world. **DUNGEONS & DRAGONS®** invited players of all ages to embrace their inner adventurer, warrior or imaginary creature. In this spirit of creativity and collaboration, Wizards of the Coast has developed a thrilling adventure that takes place in this LEGO® Ideas model.

Une aventure exclusive de DUNGEONS & DRAGONS®

En 1974, les dés sont jetés et un nouveau jeu de rôle révolutionnaire ouvre les portes d'un monde fantastique immersif comme aucun autre jeu ne l'avait fait auparavant. La promesse d'aventures sans fin incite les joueurs à découvrir leur imagination, à créer leurs propres histoires, jeux, personnages et règles dans le monde réel, et à former des alliances et des amitiés avec de nouvelles espèces en combattant des monstres dans d'étranges royaumes dans le monde du jeu. **DUNGEONS & DRAGONS®** invite les joueurs de tous âges à découvrir l'aventurier, le guerrier ou la créature imaginaire qui sommeille en eux. Dans cet esprit de créativité et de collaboration, Wizards of the Coast a développé une aventure palpitante qui se déroule dans ce modèle LEGO® Ideas.

Una exclusiva aventura de DUNGEONS & DRAGONS®

En 1974, con la tirada de un dado, un nuevo y revolucionario juego de roles distinto de todos los que se habían lanzado al mercado hasta entonces abrió el portal a un inmersivo mundo de fantasía. Las aventuras sin fin fueron el señuelo que atrajo a jugadores sedientos de explorar su imaginación, crear sus propias historias, juegos, personajes y reglas en el mundo real, así como formar alianzas y amistades con nuevas especies mientras se enfrentaban a poderosos monstruos en los extraños reinos del mundo del juego. **DUNGEONS & DRAGONS®** animó a jugadores de todas las edades a abrazar al aventurero, guerrero o criatura imaginaria que llevaban dentro. Con el mismo espíritu de creatividad y colaboración, Wizards of the Coast desarrolló una emocionante trama que tiene lugar en este modelo LEGO® Ideas.



Before you start playing, scan the QR code to download your copy of the exclusive adventure from our website.

Avant de commencer à jouer, scannez le code QR pour télécharger votre exemplaire de l'aventure exclusive sur notre site Web.

Antes de empezar a jugar, escanea el código QR para descargar tu copia de la exclusiva aventura desde nuestro sitio web.



50 years of DUNGEONS & DRAGONS®

50 years on, the game is still afoot, and these intricately detailed realms have grown to include millions of players in loyal communities around the world.

50 años de DUNGEONS & DRAGONS®

50 años después, el juego sigue en pie y sus reinos intrincadamente detallados se han ampliado hasta incluir a millones de jugadores organizados en leales comunidades por todo el mundo.

A tribute for players, by players

“In the fall of 2022, we launched a challenge on ideas.LEGO.com and invited fans to recreate their favorite D&D® storylines, monsters, characters, heroes or locations, using LEGO® bricks, elements and accessories. After a fierce fan vote, this model was selected as the winner to represent the fans’ tribute to 50 years of DUNGEONS & DRAGONS®. Partnering with game developer Wizards of the Coast, we are proud to share with you a bespoke adventure module specifically tailored to this LEGO DUNGEONS & DRAGONS set! Available on LEGO.com through the LEGO Insiders program, DUNGEONS & DRAGONS: A Red Dragon’s Tale takes you on an epic journey full of monsters, magic and merriment, blending the creativity of both worlds to offer a truly unique LEGO DUNGEONS & DRAGONS experience. We hope you will enjoy the creative storytelling as you build and play through the exclusive adventure with your party. Be inspired to display your passion for LEGO building and D&D, and create your own adventures with the set and its characters.”

Monica Pedersen, Marketing Director, LEGO® Ideas

50 ans de DUNGEONS & DRAGONS®

Cinquante ans plus tard, le jeu est toujours aussi populaire, et ces royaumes aux détails complexes comptent aujourd’hui des millions de joueurs répartis dans des communautés fidèles à travers le monde.

Un hommage pour les joueurs, par les joueurs

« À l’automne 2022, nous avons lancé un défi sur ideas.LEGO.com et invité les amateurs à recréer leurs intrigues, monstres, personnages, héros ou lieux D&D® préférés à l’aide de briques, d’éléments et d’accessoires LEGO®. Après un vote très intense, ce modèle a été choisi comme gagnant pour représenter l’hommage des amateurs aux 50 ans de DUNGEONS & DRAGONS®. En partenariat avec le développeur de jeux Wizards of the Coast, nous sommes fiers de partager avec vous un module d’aventure spécialement conçu pour cet ensemble LEGO DUNGEONS & DRAGONS ! Disponible sur LEGO.com grâce au programme LEGO Insiders, DUNGEONS & DRAGONS : L’histoire du dragon rouge vous entraîne dans une épopée pleine de monstres, de magie et de joie, mêlant la créativité des deux mondes pour offrir une expérience LEGO DUNGEONS & DRAGONS vraiment unique. Nous espérons que vous prendrez plaisir à découvrir cette histoire créative en construisant et en jouant l’aventure exclusive avec votre groupe. Exposez votre passion pour la construction LEGO et D&D, et créez vos propres aventures avec l’ensemble et ses personnages. »

Monica Pedersen, directrice du marketing, LEGO® Ideas



Un homenaje de los jugadores para los jugadores

“En otoño de 2022, lanzamos un desafío en ideas.LEGO.com invitando a los fans a recrear sus historias, monstruos, personajes, héroes o lugares favoritos de D&D® usando bricks, elementos y accesorios LEGO®. Luego de una feroz votación de los fans, este modelo fue seleccionado como el ganador para representar el homenaje de los fans a los 50 años de DUNGEONS & DRAGONS®. En colaboración con el desarrollador del juego, Wizards of the Coast, inos enorgullece compartirte un módulo de aventura hecho a la medida y específicamente adaptado a este set LEGO DUNGEONS & DRAGONS! Disponible en LEGO.com a través del programa LEGO Insiders, el set DUNGEONS & DRAGONS: Aventura del Dragón Rojo te embarca en un épico viaje lleno de monstruos, magia y regocijo que combina la creatividad de ambos mundos para ofrecer una experiencia LEGO DUNGEONS & DRAGONS verdaderamente única. Esperamos que disfrutes de la ingeniosa narrativa mientras construyes y compartes esta exclusiva aventura de juego con tu grupo de amigos. Tener la posibilidad de exhibir tu pasión por construir con LEGO y D&D y crear tus propias aventuras con el set y sus personajes es un regalo inigualable para tu inspiración”.

Monica Pedersen, directora de mercadotecnia de LEGO® Ideas

Meet the model design winner

Lucas Bolt (LEGO® Ideas name BoltBuilds) lives in Amsterdam, The Netherlands, and is no stranger to games. He studied game development and now creates 3D environments for video games.

"This challenge matched my love of LEGO building, classic fantasy, castle architecture, and games. The story is based on typical aspects of a **DUNGEONS & DRAGONS®** adventure; a dungeon full of challenges and loot, a roaring dragon to defend it, and a tavern where these stories are told by the adventurers who lived through them. It's also a layout for challenges that could unfold in multiple ways, with some of my favorite creatures from the *D&D® Monster Manual*. The dragon in the original submission was done as an homage to the classic LEGOLAND® dragon and the LEGO Castle Dragon Knights theme from 1993. Seeing how the LEGO Ideas designers helped the idea evolve was super rewarding, and it shows how much work really goes into developing a set. To get a look inside the LEGO 'kitchen' has been a wonderful opportunity that I'm very grateful for, and it's all thanks to the fans who helped this set become a reality. Thank you all, and may all your quests be successful!"

Conoce al modelista ganador

Lucas Bolt (conocido en LEGO® Ideas como BoltBuilds) vive en Ámsterdam (Países Bajos), y no es ajeno a la cultura del juego. Estudió desarrollo de juegos, y ahora se dedica a crear entornos en 3D para videojuegos.

"Este desafío combinaba todas las cosas que me apasionan: construir con LEGO, las fantasías de estilo clásico, la arquitectura de castillos y los juegos. La historia se basa en aspectos típicos de una aventura de **DUNGEONS & DRAGONS®**: un calabozo repleto de desafíos y botines, un dragón rugiente que dará su vida para defenderlo y una taberna donde los aventureros cuentan sus vivencias. También ofrece una estructura que podría servir de base para desarrollar una infinidad de desafíos con algunas de mis criaturas favoritas de *D&D® Monster Manual*. El dragón de la propuesta original se creó como tributo al dragón clásico de LEGOLAND® y al tema LEGO Castle de 1993, que dio origen a los Caballeros del Dragón. Ver a los diseñadores de LEGO Ideas colaborar para que la idea evolucionara fue algo muy gratificante. Además, me hizo entender mejor todo el trabajo que conlleva desarrollar un set. Dar un vistazo al interior de la 'cocina' de LEGO fue una maravillosa oportunidad que agradezco infinitamente, y todo gracias a los fans que ayudaron a hacer realidad este set. Gracias a todos, ¡y que todas sus misiones lleguen a buen puerto!"

Rencontre avec le concepteur du modèle

Lucas Bolt (pseudonyme LEGO® Ideas : BoltBuilds) vit à Amsterdam, aux Pays-Bas, et s'y connaît bien en jeux. Il a étudié le développement de jeux et crée aujourd'hui des environnements 3D pour les jeux vidéo.

« Ce défi répondait à mon amour de la construction LEGO, de la fantaisie classique, de l'architecture des châteaux et des jeux. L'histoire est basée sur les aspects typiques d'une aventure de **DUNGEONS & DRAGONS®** : un donjon plein de défis qui renferme un butin, un dragon grondant pour le défendre et une taverne où les histoires sont racontées par les aventuriers qui les ont vécues. C'est aussi une ébauche pour des défis qui peuvent se dérouler de plusieurs façons, avec certaines de mes créatures préférées du *Manuel des monstres* de D&D®. Le dragon de la contribution originale était un hommage au dragon LEGOLAND® classique et au thème des Chevaliers du dragon LEGO Castle de 1993. Voir la façon dont les concepteurs LEGO Ideas ont fait évoluer l'idée était très gratifiant, et cela montre tout le travail que représente le développement d'un ensemble. Pouvoir jeter un coup d'œil dans la "cuisine" LEGO a été une expérience extraordinaire dont je suis très reconnaissant, et je la dois aux amateurs qui ont aidé à faire de cet ensemble une réalité. Merci à tous, et que toutes vos quêtes soient couronnées de succès ! »



Lucas with his original fan submission
Lucas avec sa contribution originale
Lucas con su propuesta original



Meet the Building Instructions cover design winner

Yu Chun-Te (LEGO® Ideas name chainsaw yu 電鋸鋸鋸鋸) from Taiwan is a Creative Director at an advertising agency and a talented illustrator. His beautiful artwork won the contest to be featured on the cover of this booklet.

"I thoroughly relish the creative process, brainstorming and experimenting with various possibilities. I often keep an eye on contests on the LEGO Ideas platform, where astonishing creations truly captivate me. I spent a considerable amount of time researching various D&D® artwork to decide on a theme and decided to adopt a relief-like form. Given the nature of this style, I had to balance between avoiding excessive realism and maintaining a clean and concise appearance. I also needed to create an overall sense of antiquity and weathered texture, which wasn't my strong suit. Additionally, recreating the well-known antagonist character posed a difficulty as it required staying faithful to the original design. I hope fans will enjoy the result as well as the model!"

Conoce al autor de la propuesta ganadora para la portada de las instrucciones de construcción

Yu Chun-Te (conocido en LEGO® Ideas como "chainsaw yu 電鋸鋸鋸鋸", residente de Taiwán, es director creativo en una agencia de publicidad y un talentoso ilustrador. Su impresionante creación artística ganó el concurso para aparecer en la portada de este folleto. "El proceso creativo, las lluvias de ideas y experimentar con distintas posibilidades son de las cosas que más disfruto. Me mantengo atento a los concursos de la plataforma LEGO Ideas, y suelo quedarme sin aliento ante el ingenio de muchas de las creaciones que allí se publican. Pasé mucho tiempo investigando la producción artística de D&D® para decidirme por un tema y, al final, decidí adoptar una forma en relieve. Dada la naturaleza de este estilo, tuve que encontrar el equilibrio entre el realismo excesivo y mantener una apariencia limpia y concisa. Otra cosa que resultaba muy necesaria era inspirar una sensación general de antigüedad y texturas desgastadas, algo que no era mi fuerte. Además, recrear al conocido personaje antagonista planteaba una dificultad particular, ya que exigía mantenerse fiel al diseño original. ¡Espero que el resultado deje a los fans tan satisfechos como el modelo!"

Rencontre avec le concepteur de la couverture des instructions de montage

Yu Chun-Te (pseudonyme LEGO® Ideas : chainsaw yu 電鋸鋸鋸鋸), originaire de Taïwan, est directeur de la création dans une agence de publicité et illustrateur de talent. Son magnifique dessin a remporté le concours pour figurer sur la couverture de ce livret.

« J'adore le processus créatif, le remue-méninges et l'expérimentation de diverses possibilités. Je surveille souvent les concours organisés sur la plateforme LEGO Ideas, où les créations étonnantes me fascinent. J'ai passé beaucoup de temps à étudier diverses œuvres d'art de D&D® pour choisir un thème et j'ai décidé d'adopter une forme en relief. Vu la nature de ce style, j'ai dû trouver un équilibre entre éviter un réalisme excessif et conserver une apparence nette et concise. Je devais également créer une impression de vétusté et de texture usée, ce qui n'est pas mon point fort. De plus, recréer le célèbre antagoniste m'a donné du fil à retordre, car il fallait rester fidèle au concept original. J'espère que les amateurs apprécieront le résultat ainsi que le modèle ! »



Yu Chun-Te with his original cover submission

Yu Chun-Te avec sa contribution originale

Yu Chun-Te con su propuesta original para la portada





Gather your party and venture forth

It's late when you arrive at the half-empty tavern. The heat from the fireplace soothes your aching bones. A group of your fellow travelers is already seated at the corner table. You're the one they have been waiting for. This is it – your adventure is about to begin.

To understand why **DUNGEONS & DRAGONS**[®] has become the global phenomenon it is today, let's start at the beginning. Playing games together as a family, a group of friends, or in tournaments has been part of every known culture for thousands of years. Even now, with millions of digital games available, a fun game night is still a welcome chance to immerse ourselves in a playful activity and connect with each other. But when game developers Gary Gygax and David Arneson released their first version of **DUNGEONS & DRAGONS** in 1974, they entered uncharted territory in the tabletop games category.

Rassemblez votre groupe et partez à l'aventure

Il est tard lorsque vous entrez dans la taverne à moitié vide. La chaleur de la cheminée apaise vos os endoloris. Un groupe de voyageurs est déjà assis à la table du coin. Ils attendent votre arrivée depuis un moment. Ça y est : votre aventure est sur le point de commencer.

Pour comprendre pourquoi **DUNGEONS & DRAGONS**[®] est devenu le phénomène mondial qu'il est aujourd'hui, commençons par le commencement. Jouer à des jeux en famille, entre amis ou dans le cadre de tournois est une pratique qui existe depuis des milliers d'années dans toutes les cultures connues. Même aujourd'hui, alors que des millions de jeux numériques sont disponibles, une soirée jeux de société est toujours une belle occasion de partager un moment ludique avec d'autres personnes. Mais lorsque les développeurs de jeux Gary Gygax et David Arneson ont lancé leur première version de **DUNGEONS & DRAGONS** en 1974, le domaine des jeux de table était encore inexploré.

Reúne a tu grupo de amigos y emprendan una aventura

Ya se ha hecho tarde cuando llegas a la taberna, que encuentras medio vacía. El calor de la chimenea alivia un poco el dolor de tus huesos. Un grupo de viajeros como tú ya está sentado en la mesa de la esquina. Eres tú a quien han estado esperando. El momento es ahora: tu aventura está a punto de comenzar.

Para entender por qué **DUNGEONS & DRAGONS**[®] se ha convertido en el fenómeno de proporciones globales que es hoy en día, debemos empezar por el principio. Los juegos en familia, con grupos de amigos o en competencias han formado parte de todas las culturas conocidas desde hace miles de años. Incluso ahora, cuando los juegos digitales disponibles se cuentan por millones, una divertida noche de juegos sigue siendo una grata oportunidad para sumergirnos en una actividad lúdica y conectar unos con otros. Pero cuando los desarrolladores de juegos Gary Gygax y David Arneson decidieron lanzar su primera versión de **DUNGEONS & DRAGONS** en 1974, se adentraron en un territorio inexplorado en la categoría de los juegos de mesa.



Roll for initiative

The original D&D® system was inspired by the epic scope of fantasy literature and the detailed miniatures of tabletop wargames. These passions were combined to make a revolutionary “tabletop role-playing game” where players imagined themselves as adventurers questing through fantastical lands. As their characters met challenges – such as monsters or dungeons – they consulted rules and rolled dice to determine the outcome of their actions. Dice added unpredictability to the story, meaning that no two D&D games could ever be the same. Throughout every iteration over its fifty-year history, D&D’s spirit of collaboration and creativity has remained at the core: there are no winners or losers, just players telling an epic story together. The possibilities remain endless.

Lancez un jet d’initiative

Le système D&D® original a été inspiré par la portée épique de la littérature fantastique et les figurines détaillées des jeux de guerre sur table. Ces passions ont été combinées pour créer un « jeu de rôle sur table » révolutionnaire dans lequel les joueurs s’imaginent être des aventuriers en quête dans des contrées fantastiques. Lorsque leurs personnages rencontrent des défis (tels que des monstres ou des donjons) ils consultent les règles et lancent des dés pour déterminer l’issue de leurs actions. Les dés ajoutent de l’imprévisibilité à l’histoire, ce qui signifie que chaque partie de D&D est unique. Au fil des cinquante ans d’histoire de D&D, l’esprit de collaboration et de créativité est resté au cœur du jeu. Il n’y a ni gagnants ni perdants ; seulement des joueurs qui racontent ensemble une histoire épique. Les possibilités restent infinies.

Tirada de iniciativa

El sistema original de D&D® estaba inspirado en el tono épico de la literatura de fantasía y en las detalladas figuras en miniatura de los juegos de mesa con temática bélica. De la combinación de estas pasiones, nació un revolucionario “juego de roles de mesa” en el que los jugadores se imaginaban a sí mismos como aventureros viviendo periplos por tierras fantásticas. Cuando sus personajes se enfrentaban a desafíos en forma de monstruos o calabozos, debían consultar las reglas y lanzar los dados para determinar el resultado de sus acciones. Los dados añadían un importante componente de imprevisibilidad a la trama, lo que significaba que no podía haber dos juegos de D&D iguales. A lo largo de sus cincuenta años de historia, el espíritu de colaboración y creatividad de D&D ha permanecido en el centro de cada una de sus iteraciones: no hay ganadores ni perdedores, solo jugadores que cuentan juntos una historia épica. Las posibilidades siguen siendo infinitas.

Meet your monsters

Some of the most iconic denizens in the worlds of **DUNGEONS & DRAGONS**® are the monsters. From minuscule to magnificent, they take skill, cunning and collaboration to beat. Meet some of the monsters you will encounter in your LEGO® Ideas D&D® adventure – and be inspired to expand with more!

Conoce a los monstruos

Entre los habitantes más icónicos de los mundos de **DUNGEONS & DRAGONS**® se encuentran los monstruos. Ya sean minúsculos o magníficos, vencerlos requerirá habilidad, astucia y colaboración en grandes dosis. Conoce a algunos de los monstruos que encontrarás en tu aventura de D&D® LEGO® Ideas, ¡y animate a ampliarla con otros más!

Rencontrez vos monstres

Certains des habitants les plus emblématiques des mondes de **DUNGEONS & DRAGONS**® sont les monstres. Qu'ils soient minuscules ou imposants, il faut de l'habileté, de la ruse et de la collaboration pour les vaincre. Rencontrez quelques-uns des monstres que vous croiserez dans votre aventure LEGO® Ideas D&D®, et n'hésitez pas à en ajouter d'autres!



Skeleton

A solid staple in any D&D campaign, the skeleton may seem simple at first glance, with its limited capacity for independent thought or battle skills, but with a creative Dungeon Master, there is no limit to the fun you can have with these spindly creatures.

Squelette

Un élément fondamental de toute campagne D&D, le squelette peut à première vue sembler banal avec ses capacités limitées de pensée libre et de combat, mais un maître de donjon créatif saura exploiter le plein potentiel de cette créature chétive.

Esqueleto

Imprescindibles en cualquier campaña de D&D y con grandes limitaciones para pensar por sí mismos y un desempeño poco notable en el campo de batalla, los esqueletos pueden parecer bastante simples. Pero bajo la guía de un Amo del Calabozo lo suficientemente creativo, la diversión que pueden brindar estas enjutas criaturas no tendrá fin.





Gelatinous Cube

Usually found filling corridors or blocking any escape from dungeons, these slow-moving, mindless, amoeba-like beings are completely transparent and difficult to spot. A reflection of light on its surface may give away its position. They can absorb and dissolve most organic matter that gets in their way.

Cube gélatineux

Cet être lent et sans cervelle qui ressemble à une amibe est complètement transparent et difficile à repérer. On le trouve généralement dans les couloirs ou à la sortie des donjons. Le reflet de la lumière sur sa surface peut indiquer sa position. Il peut absorber et dissoudre la plupart des matières organiques qui se trouvent sur son chemin.

Cubo Gelatinoso

Comúnmente encontrados llenando pasillos u obstruyendo cualquier escapatoria de los calabozos, estos seres de movimiento lento, descerebrados y con apariencia de amibas son completamente transparentes y difíciles de detectar. La luz reflejada en su superficie puede delatar su posición. Pueden absorber y disolver la mayor parte de las materias orgánicas que encuentren en su camino.



Owlbear

Living up to its name in terms of both looks and behavior, the owlbear is one of the most feared predators of the wilderness. With senses as sharp as its talons, and a heightened sense of smell, this unnatural creature is a volatile fighter who likes to hunt its prey for sport.

Ours-hibou

Fidèle à son nom, tant par son apparence que par son comportement, l'ours-hibou est l'un des prédateurs les plus redoutés dans la nature. Dotée de sens aussi aiguisés que ses serres et d'un sens de l'odorat très développé, cette créature insolite est un combattant impétueux qui aime chasser ses proies pour le plaisir.

Oso Lechuza

Haciendo honor a su nombre, tanto por su aspecto como por su comportamiento, el Oso Lechuza es uno de los depredadores más temidos de las tierras en estado salvaje. Con unos sentidos tan agudos como sus garras y dotada de un olfato sobresaliente, esta antinatural criatura disfruta de golpear desde el aire y caza a sus presas solo por deporte.

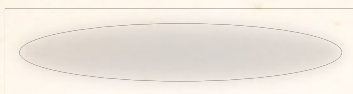

Beholder

Feeling watched? Feared by adventurers for its unpredictability and power, this floating spherical creature emits different magical rays from each of its eye stalks to inflict perilous harm on its enemies. The beholder is highly intelligent, ruthless, a fierce opponent and a true test of a party's mettle.

Scrutateur

Vous sentez qu'on vous observe ? Craint par les aventuriers pour son imprévisibilité et sa puissance, cette créature sphérique flottante émet différents rayons magiques par chacun de ses yeux pour infliger à ses ennemis de lourds dégâts. Le tyranneuil est extrêmement intelligent, impitoyable, féroce et capable de mettre le courage d'un groupe à rude épreuve.

Observador

¿Sientes que alguien te observa? Temida por los aventureros por su imprevisibilidad y poder, esta criatura flotante de forma esférica emite rayos mágicos por cada uno de sus pedúnculos oculares para infligir un profundo daño a sus enemigos. El Observador es muy inteligente y despiadado, además de un feroz oponente y una verdadera prueba para el temple de un grupo.



Displacer Beast

This six-legged, tentacled, feline-like beast sometimes hunts in packs but is just as often seen on its own, attacking lone travelers. A displacer beast can bend light to appear to be several feet away from its actual location, allowing it to take enemies by surprise. It is a popular guardian among wizards and others who use magic.

Bête éclipseante

Cette bête féline dotée à la fois de six pattes et de tentacules chasse parfois en meute, mais on la voit tout aussi souvent attaquer seule des voyageurs isolés. Une bête éclipseante peut courber la lumière pour donner l'impression d'être à plusieurs mètres de son emplacement réel, ce qui lui permet de prendre ses ennemis par surprise. C'est un gardien populaire parmi les sorciers et autres utilisateurs de la magie.

Bestia Trémula

Esta bestia de seis patas con tentáculos y aspecto felino a veces caza en manada, aunque con la misma frecuencia se la ve atacando por sí sola a los viajeros que se han alejado de sus grupos. Como la mayoría de los de su especie, puede torcer la luz para dar la apariencia de que se encuentra a varios metros de su verdadera ubicación, lo que le permite tomar por sorpresa a sus enemigos. Los magos y otros usuarios de magia suelen darle uso como guardiana.



Mimic

While some mimics are more intelligent than others, they are tough, complex creatures. A fun favorite among Dungeon Masters, the mimic's natural shapes can vary, often resembling a treasure chest of wood or a rock, and they can flawlessly take on any appearance to suit their needs – maybe even a bed!

Mimique

Bien que certaines mimiques soient plus intelligentes que d'autres, ce sont des créatures coriaces et complexes. Très appréciées des maîtres de donjon, les mimiques prennent plusieurs formes, notamment celle d'un coffre au trésor en bois ou d'un rocher, et elles peuvent adopter n'importe quelle apparence (peut-être même celle d'un lit !) pour répondre à leurs besoins.

Mimeto

Aunque algunos mimetos son más inteligentes que otros, todos son criaturas bastante resistentes y complejas. Divertidas y muy apreciadas por los Amos del Calabozo, estas criaturas no tienen una forma definida, aunque suelen mostrarse como cofres de madera o rocas. Si lo requieren, pueden adoptar cualquier aspecto que les resulte conveniente, ¡incluso el de una cama!



Cinderhowl the Red Dragon

Dragons are powerful spellcasters and more intelligent than any human. A frightful presence, this almighty foe is one of the most daunting monsters you will encounter. Just a beat of its wing can cause calamitous damage, not to mention its claws, bite and devastating fire-spewing. Defeating Cinderhowl the Red Dragon requires a group of highly-trained adventurers. Good luck!

Cinderhowl le dragon rouge

Les dragons sont de puissants lanceurs de sorts et sont plus intelligents que n'importe quel humain. Un puissant ennemi, le dragon est l'un des monstres les plus redoutables que vous puissiez rencontrer. Un simple battement de ses ailes peut causer des dégâts catastrophiques, sans parler de ses griffes, de sa morsure et de ses flammes dévastatrices. Seul un groupe d'aventuriers bien aguerris saura vaincre Cinderhowl le dragon rouge. Bonne chance !

Rugido de Ceniza, el dragón rojo

Los dragones son hechiceros poderosos y más inteligentes que cualquier humano. De presencia aterradora, este omnipotente enemigo es uno de los monstruos más impresionantes que podrás encontrar. Con solo agitar una de sus alas puede causar un daño calamitoso, por no hablar de sus garras, mordiscos y devastadores bocanadas de fuego. Para vencer a Rugido de Ceniza, el dragón rojo, se requiere un grupo de aventureros altamente entrenados. ¡Buena suerte!

Chapters from the first 50 years

From its early predecessor to modern editions, the **DUNGEONS & DRAGONS** Player's Handbook® provides everything players need to create and navigate intriguing campaigns and role-playing adventures.

After the quite complex and equation-heavy rules in the early editions, later updates became more refined and welcoming to new players.



1974, **DUNGEONS & DRAGONS**
By Gary Gygax
and Dave Arneson, TSR

1974, **DUNGEONS & DRAGONS**
Par Gary Gygax
et Dave Arneson, TSR

1974, **DUNGEONS & DRAGONS**
Por Gary Gygax y Dave Arneson (TSR)

With *Rules for Fantastic Medieval Wargames Campaigns Playable with Paper and Pencil and Miniature Figures*, **DUNGEONS & DRAGONS** consisted of *Volume 1: Men & Magic*, *Volume 2: Monsters & Treasure* and *Volume 3: The Underworld & Wilderness Adventures*.

DUNGEONS & DRAGONS: Rules for Fantastic Medieval Wargames Campaigns Playable with Paper and Pencil and Miniature Figures se compose du *Volume 1 : Men & Magic* (Hommes et magie), du *Volume 2 : Monsters & Treasure* (Monstres et trésors) et du *Volume 3 : The Underworld & Wilderness Adventures* (Aventures dans le monde souterrain et la nature sauvage).

DUNGEONS & DRAGONS: Rules for Fantastic Medieval Wargames Campaigns Playable with Paper and Pencil and Miniature Figures constaba de *Volume 1: Men & Magic*, *Volume 2: Monsters & Treasure* y *Volume 3: The Underworld & Wilderness Adventures*.

Chapitres des 50 premières années

Depuis sa première version jusqu'aux éditions modernes, le *Manuel des joueurs* de **DUNGEONS & DRAGONS**® contient tout ce dont les joueurs ont besoin pour créer et vivre des campagnes et des aventures de jeu de rôle captivantes.

Contrairement aux premières éditions, dont les règles étaient complexes et lourdes d'équations, les versions ultérieures sont plus affinées et plus accessibles aux nouveaux joueurs.

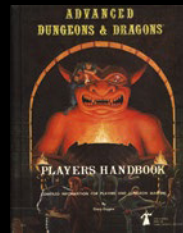

1983, **DUNGEONS & DRAGONS Set 1:**
Basic Rules

1983, **DUNGEONS & DRAGONS Ensemble 1 :**
Règles de base

1983, **DUNGEONS & DRAGONS Set 1:**
Basic Rules

This iconic rule set included a simpler, clearer version of the rules and story universe to ease in new players. Even today, it remains a popular introduction to the game that new players can study to familiarize themselves with D&D lore.

Cet ensemble de règles emblématique comprend des versions plus simples et plus claires des règles et de l'univers narratif afin de faciliter les débuts des nouveaux joueurs. Aujourd'hui encore, il reste une entrée en matière populaire que les nouveaux joueurs peuvent étudier pour se familiariser avec l'univers de D&D.

Este emblemático conjunto de reglas incluía una versión más sencilla y clara de las pautas y del universo de la historia para facilitar la entrada a los nuevos jugadores. Incluso hoy en día, sigue siendo una popular introducción al juego que los nuevos jugadores pueden estudiar para familiarizarse con la tradición de D&D.

Capítulos de los primeros 50 años

Desde su predecesor hasta las ediciones modernas, **DUNGEONS & DRAGONS** Player's Handbook® proporciona todo lo que los jugadores necesitan para crear intrigantes campañas y aventuras en el famoso juego de roles.

Luego de unas primeras ediciones sobrecargadas de reglas complejas, las actualizaciones se refinaron e hicieron más amigables hacia los nuevos jugadores.



1989, *Player's Handbook*®
Second Edition

1989, *Manuel des joueurs :*
deuxième édition

1989, *Player's Handbook*®
(2.ª edición)

The Second Edition saw the rise of new, iconic settings including the Forgotten Realms, Planescape, Dark Sun and Spelljammer. The *Monster Manual* was relaunched as the *Monstrous Compendium*.

La deuxième édition marque la naissance de nouveaux environnements emblématiques tels que les Royaumes oubliés, Planescape, Dark Sun et Spelljammer. Le *Manuel des monstres* est relancé sous le nom de *Compendium des monstres*.

La 2.ª edición vio el surgimiento de nuevos entornos icónicos, como los Reinos Olvidados, Planescape, Sol Oscuro y Spelljammer. *Monster Manual* se relanzó posteriormente como *Monstrous Compendium*.



2000, *Player's Handbook*®
Third Edition

2000, *Manuel des joueurs* : troisième édition

2000, *Player's Handbook*®
(3.ª edición)

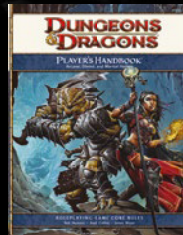

2008, *Player's Handbook*®
Fourth Edition

2008, *Manuel des joueurs* :
quatrième édition

2008, *Player's Handbook*®
(4.ª edición)



2014, *Player's Handbook*® Fifth Edition

2014, *Manuel des joueurs* : cinquième édition

2014, *Player's Handbook*® (5.ª edición)

The first edition produced under new owners Wizards of the Coast featured more details of the universe, mechanics and rules. The introduction of the 20-sided dice (d20 System) added more depth and story arcs to the gaming experience. It was later revised, based on player feedback, and released as version 3.5. This version still remains popular among fans.

La première édition produite par Wizards of the Coast, le nouveau propriétaire du jeu, contient plus de détails sur l'univers, les mécanismes et les règles. L'introduction des dés à 20 faces (système d20) ajoute plus de profondeur et d'arcs scénaristiques à l'expérience de jeu. Le jeu est ensuite revu, en fonction des commentaires des joueurs, et lancé en version 3.5. Cette version est toujours populaire auprès des amateurs.

La primera edición producida bajo los nuevos propietarios, Wizards of the Coast, incluía más detalles sobre el universo, las mecánicas y las reglas. La introducción de los dados de 20 caras (sistema d20) añadió más profundidad y arcos argumentales a la experiencia de juego. Más tarde se sometió a una revisión con base en los comentarios de los jugadores y se publicó como versión 3.5. Esta versión sigue siendo popular entre los fans.

The Fourth Edition took the game through significant gameplay changes, with new combat mechanics, spell changes and skill challenges. It was the first edition to integrate a digital subscription and although not every change was welcomed by fans, the ground was paved for the immensely popular Fifth Edition.

La quatrième édition apporte des changements significatifs au niveau de la jouabilité, avec de nouveaux mécanismes de combat, des changements de sorts et des défis de compétences. C'est la première édition à intégrer un abonnement numérique et, bien que tous les changements n'aient pas été accueillis favorablement par les amateurs, le terrain était prêt pour l'immensément populaire cinquième édition.

La 4.ª edición introdujo cambios importantes en la experiencia de juego con nuevas mecánicas de combate, cambios en los hechizos y desafíos de habilidad. Fue la primera edición en integrar una suscripción digital y, aunque no todos los cambios fueron bien recibidos por los fans, allanó el terreno para la inmensamente popular 5.ª edición.

This edition has helped enable a massive surge of the game's popularity, with updated mechanics that streamlined play, including modified skills, spells, feats and the "advantage/disadvantage" feature. The power system reverted to a more traditional one, with class features gained on character level.

Cette édition contribue à une augmentation massive de la popularité du jeu, avec des mises à jour mécaniques qui simplifient le jeu, notamment des modifications au niveau des compétences, des sorts, des dons et de la caractéristique « avantage/désavantage ». Le système de puissance revient à un modèle plus traditionnel, avec des caractéristiques de classe qui s'acquiert en fonction du niveau du personnage.

Con mecánicas actualizadas que agilizaron el juego, entre las que se cuentan habilidades, hechizos y proezas, y modificaciones en la característica de "ventaja/desventaja", esta edición ha contribuido a un monumental aumento en la popularidad del juego. Y, con características de clase que se ganan en función del nivel del personaje, el sistema de poderes volvió a su funcionamiento más tradicional.

Meet your heroes

Choose your character and your party wisely, and your riveting adventure can begin!

Rencontrez vos héros

Choisissez judicieusement votre personnage et votre groupe, et votre aventure peut commencer !

Conoce a los héroes

Elige sabiamente a tu personaje y a tu grupo, ¡y empieza tu apasionante aventura!



Dwarf cleric

A cleric channels divine magic from the god they serve. They are powerful healers who can help their party survive any encounter. In battle, clerics wield a holy symbol and a weapon that shines with radiant light.

Clerc nain

Les clercs canalisent la magie divine du dieu qu'ils servent. Ce sont de puissants guérisseurs qui peuvent aider leur groupe à survivre à n'importe quel affrontement. Au combat, les clercs brandissent un symbole sacré et une arme qui brille d'une lumière éclatante.

Clérigo Enano

Un clérigo canaliza la magia divina del dios al que sirve. Son poderosos sanadores que pueden ayudar a su grupo a sobrevivir a cualquier encuentro. En el combate, los clérigos empuñan un símbolo sagrado y un arma que brilla con luz radiante.

Gnome fighter

Practice makes perfect when you're a fighter. These warriors train with a variety of weapons and armor to become masters of combat. They learn to think clearly in battle and to push themselves beyond normal limits to keep their allies safe.

Gnome combattant

La pratique est la clé du succès lorsque l'on est un combattant. Ces guerriers s'entraînent avec une variété d'armes et d'armures pour devenir des maîtres du combat. Ils apprennent à garder leurs esprits au combat et à se dépasser pour assurer la sécurité de leurs alliés.

Guerrero Gnomo

La práctica hace al maestro cuando vives para pelear. Estos guerreros se entrenan con diversas armas y armaduras para convertirse en maestros del combate. Aprenden a pensar con claridad en medio de la batalla y a esforzarse más allá de los límites normales para mantener a salvo a sus aliados.

Orc rogue

Rogues are masters of stealth who can attack from the shadows or sneak past without a sound. Their clever minds and quick fingers are adept at picking locks and disarming traps. If a rogue is watching, you won't know until it's too late!

Orque voyou

Les voleurs sont des maîtres de la furtivité, capables d'attaquer dans l'ombre ou de se faufiler sans bruit. Leur esprit malin et leurs doigts rapides leur permettent de crocheter les serrures et de désamorcer les pièges. Si un voleur vous guette, vous ne le saurez que trop tard !

Pícaro Orco

Los pícaros son maestros del sigilo que pueden atacar desde las sombras o ir de un lado a otro sin hacer ruido. Sus astutas mentes y ágiles dedos son expertos en forzar cerraduras y desactivar trampas. Si un pícaro te está vigilando, ¡no lo sabrás hasta que sea demasiado tarde!

Elf wizard

Wizards study books and scrolls to learn the art of magic. They copy spells into their spellbook, the sum of all their knowledge and their most precious possession. Each wizard specializes in a School of Magic, such as illusion, necromancy or enchantment.

Elfe magicien

Les magiciens étudient les livres et les parchemins pour apprendre l'art de la magie. Ils copient des sorts dans leur livre de sorts, recueil de toutes leurs connaissances et leur bien le plus précieux. Chaque magicien se spécialise dans une discipline, comme l'illusion, la nécromancie ou l'enchantement.

Mago Elfo

Los magos estudian libros y pergaminos para aprender el arte de la magia. Copian hechizos en su libro de conjuros, la suma de todos sus conocimientos y su posesión más preciada. Cada mago se especializa en una escuela de magia, como la ilusión, la nigromancia o los encantamientos.

From niche to global phenomenon

Since the 1970s, the game has spawned tournaments and live-action role-playing events in local and global communities, and the DUNGEONS & DRAGONS® universe has expanded into novels, video games, a TV show and movies. While D&D® was briefly targeted by the moral panics of the 1980s, research has proven that the game can be a successful therapeutic tool for both adults and children, from advancing social skills and empathy to improving creative thinking, language and problem-solving skills. Many schools around the world even facilitate D&D clubs as an after-school activity.

Expand the gaming experience

D&D® has inspired pop culture, a myriad of books, and new franchise games, both tabletop and digital. Since the early 2000s, the evolution of the game by Wizards of the Coast has cemented the legacy of D&D as a global phenomenon. Online tools such as D&D Beyond, podcasts, streaming and social media have helped spread the game's

reach with a strong, collaborative creator community and accessible entry points for new players. Whether you are new to this incredible world, or already an experienced player, we hope this set will inspire endless new ideas for how you can expand the gaming experience.

De producto para un público selecto a fenómeno global

Desde la década de 1970, el juego se ha hecho presente en torneos y eventos en vivo en comunidades locales y a nivel global, y el universo de DUNGEONS & DRAGONS® se ha ampliado para incluir novelas, videojuegos, un programa de televisión y películas. Aunque D&D® estuvo brevemente en el punto de mira del pánico moral de los años 80, los estudios han demostrado que el juego puede ser una herramienta terapéutica eficaz tanto para adultos como para niños. Sus beneficios abarcan desde el fomento de las habilidades sociales y la empatía hasta la mejora del pensamiento creativo, el lenguaje y la capacidad para resolver problemas. Muchas escuelas de todo el mundo incluso promueven los clubes de D&D como actividad extraescolar.

Una experiencia de juego que se amplía

D&D® ha servido de fuente de inspiración en la cultura popular, una infinidad de libros y nuevas franquicias de juegos, tanto de mesa como digitales. Desde principios de la primera década del siglo XXI, la evolución del juego por parte de Wizards of the Coast ha cimentado el legado de D&D como fenómeno global. Herramientas en línea como D&D Beyond, podcasts, transmisiones y redes sociales

han ayudado a ampliar el alcance del juego con una comunidad de creadores fuerte y colaborativa y puntos de entrada accesibles para los nuevos jugadores. Tanto si eres nuevo en este increíble mundo como si ya eres un jugador experimentado, esperamos que este set te inspire un sinfín de nuevas ideas sobre cómo puedes disfrutar de una experiencia aún más amplia.

De niche à phénomène mondial

Depuis les années 1970, le jeu engendre des tournois et des événements de jeu de rôle en direct dans des communautés locales et mondiales, et l'univers de DUNGEONS & DRAGONS® s'est enrichi de romans, de jeux vidéo, d'une série télévisée et de films. Bien que le jeu D&D® ait été brièvement visé par les paniques morales des années 1980, des recherches ont prouvé qu'il peut être un outil thérapeutique efficace pour les adultes et les enfants, qu'il s'agisse de renforcer les compétences sociales et l'empathie ou d'améliorer la pensée créative, le langage et les compétences en matière de résolution de problèmes. De nombreuses écoles à travers le monde organisent même des clubs de D&D en tant qu'activité extrascolaire.

Enrichir l'expérience de jeu

D&D® a influencé la culture populaire et inspiré une myriade de livres et de nouvelles franchises de jeux, tant sur table qu'en version numérique. Depuis le début des années 2000, le développement du jeu par Wizards of the Coast consolide l'héritage de D&D en tant que phénomène mondial. Des outils en ligne tels que D&D Beyond, les balados, la diffusion en continu et les médias sociaux ont favorisé la propagation du jeu grâce à une communauté de créateurs forte et collaborative et à des points d'entrée accessibles pour les nouveaux joueurs.

Que vous découvriez ce monde incroyable pour la première fois ou que vous soyez déjà un joueur expérimenté, nous espérons que cet ensemble vous inspirera de nouvelles idées pour enrichir votre expérience de jeu.



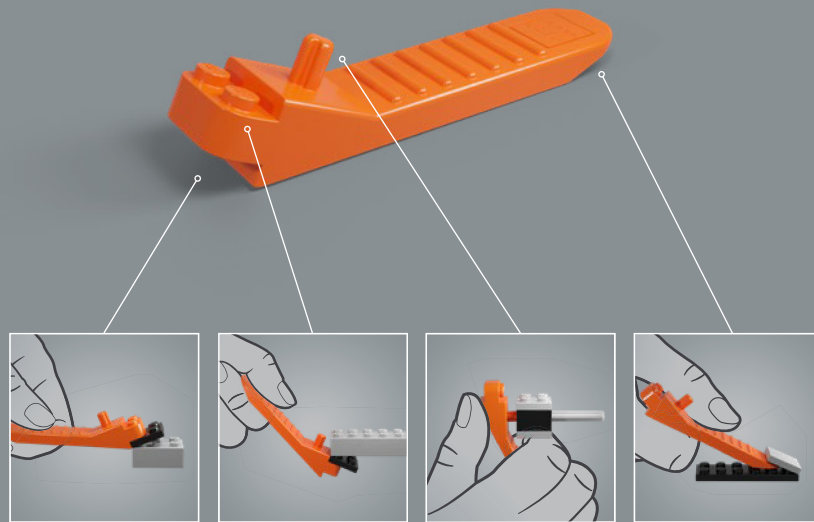

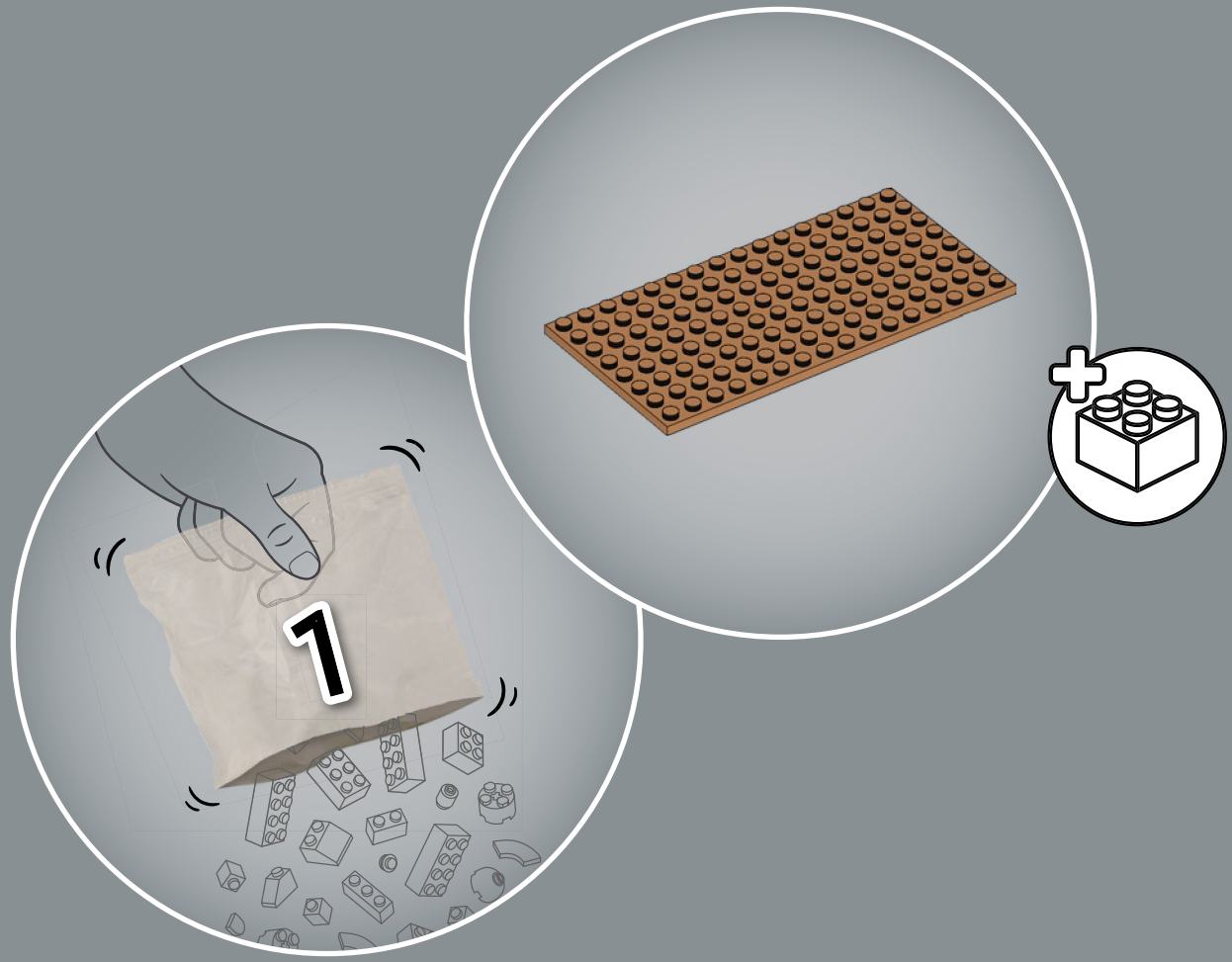

1

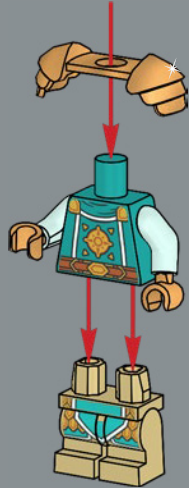

2

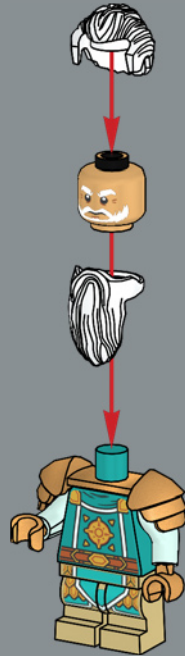

3

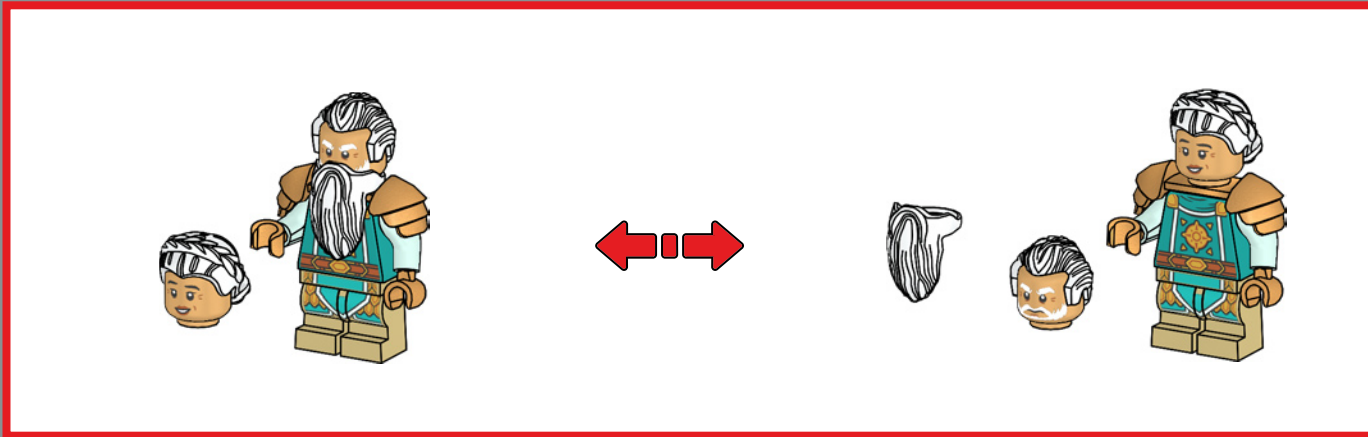
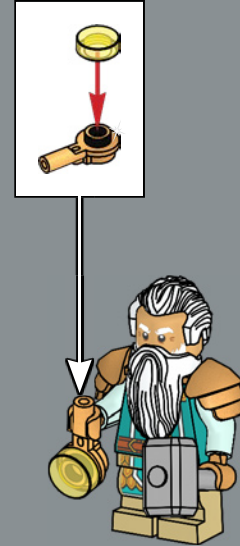

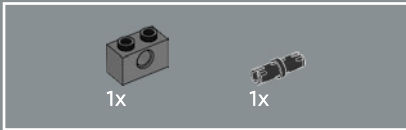
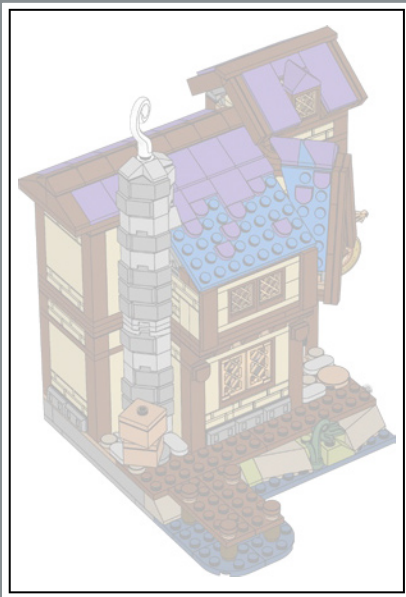

1

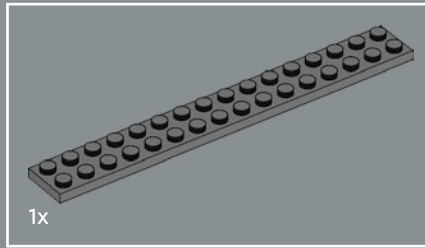
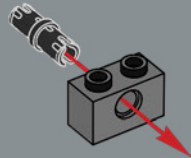

2

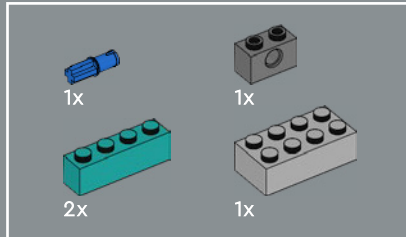
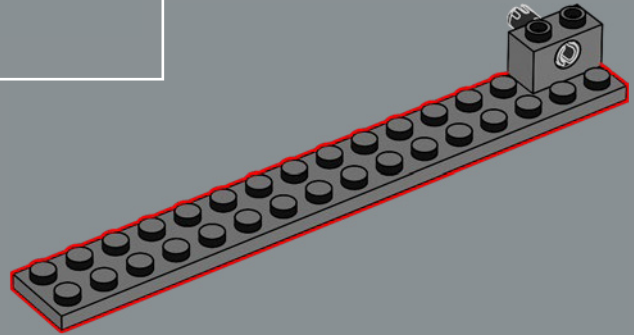

3

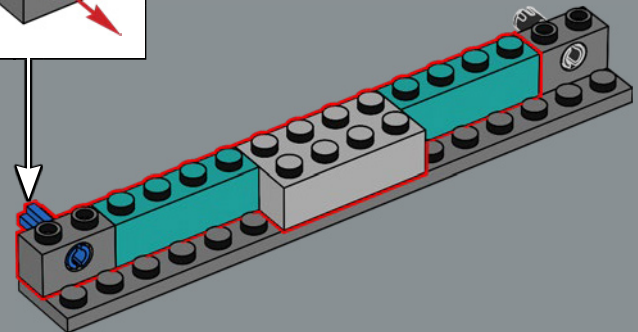
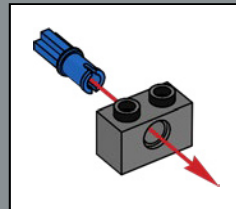

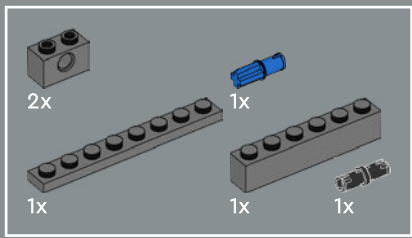

4

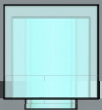
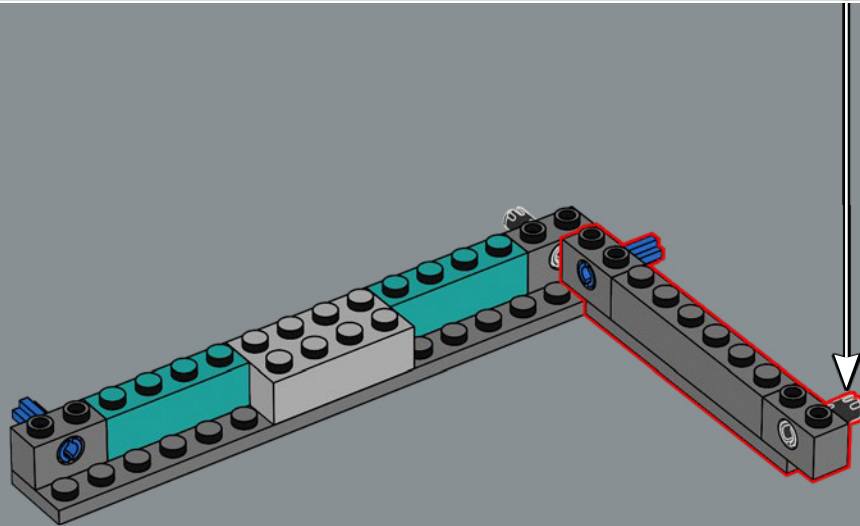
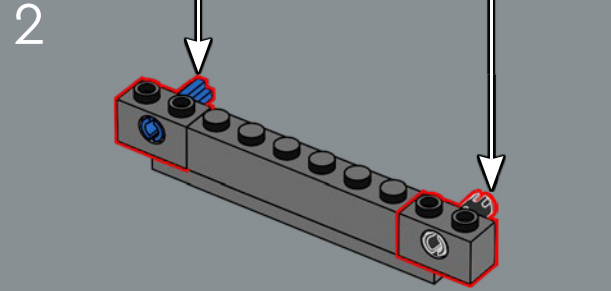
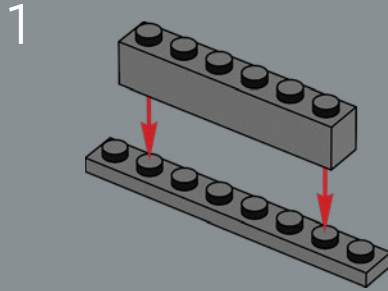

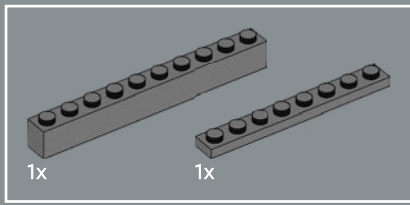

5

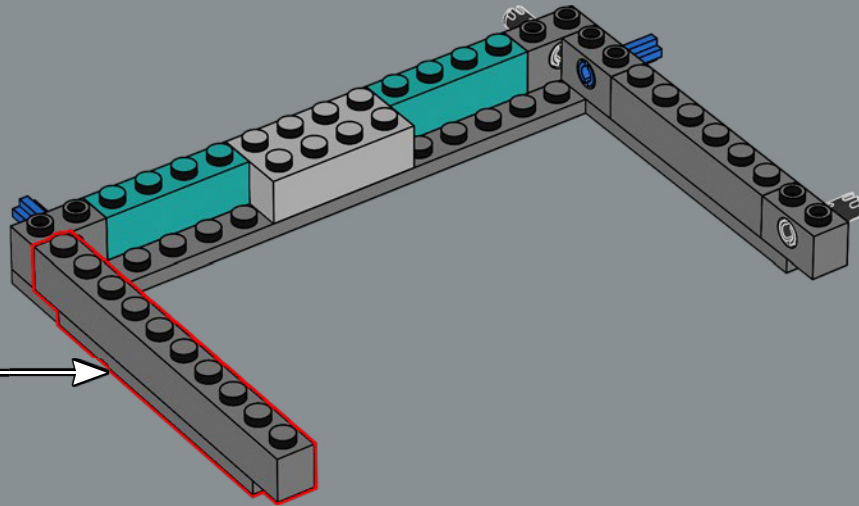
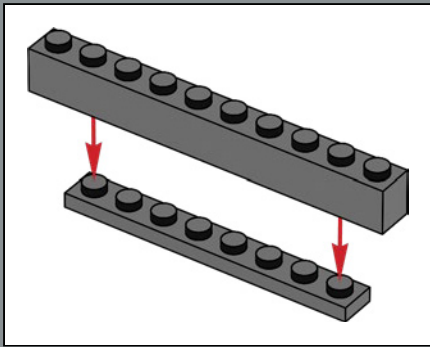

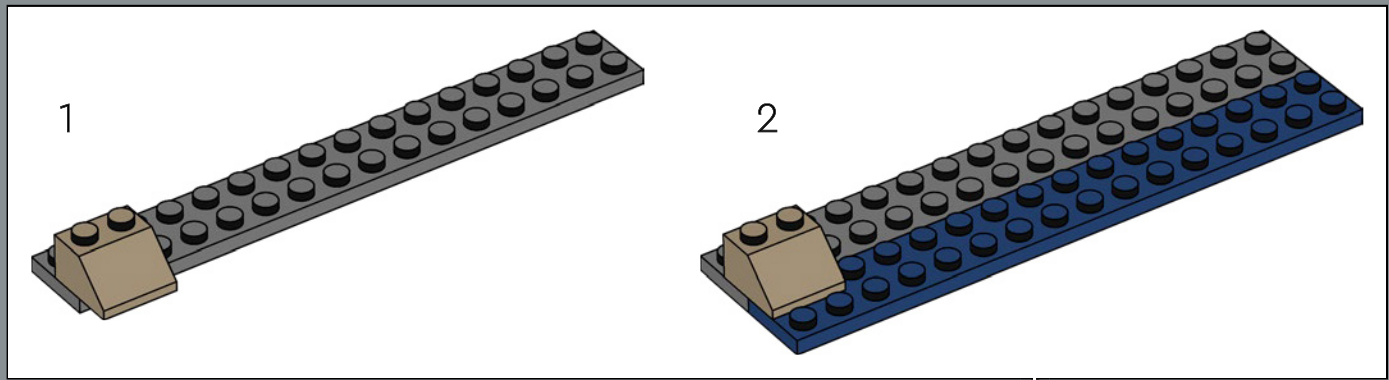
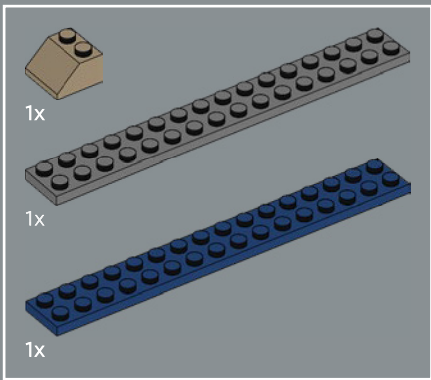

6

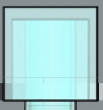
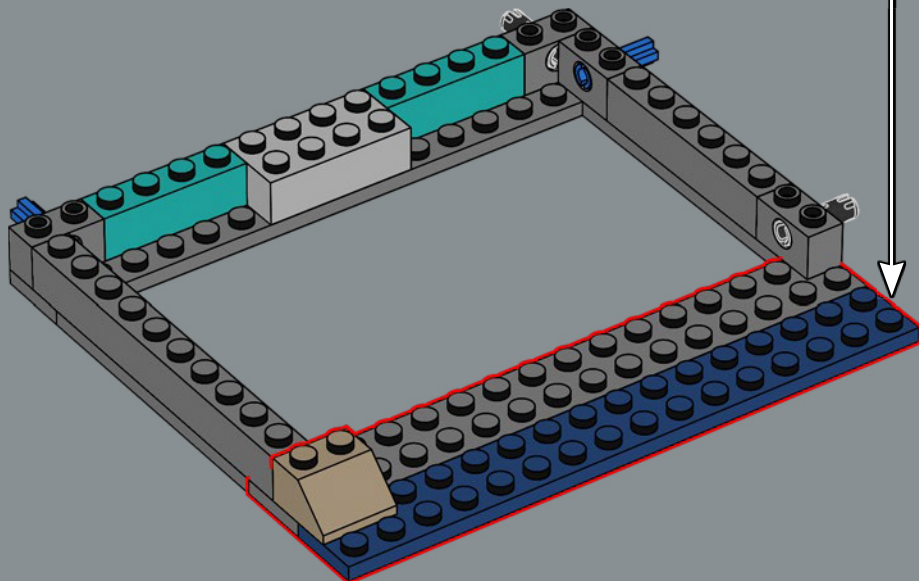

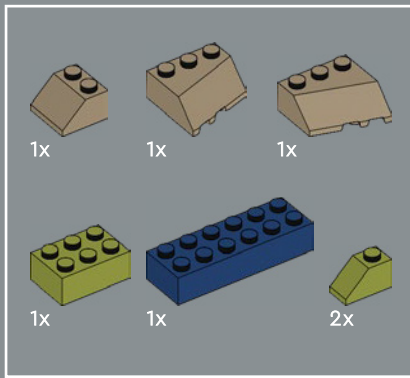

7

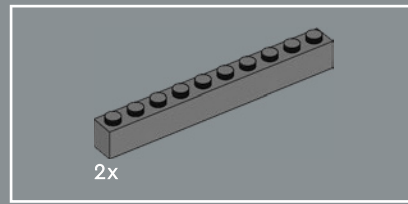
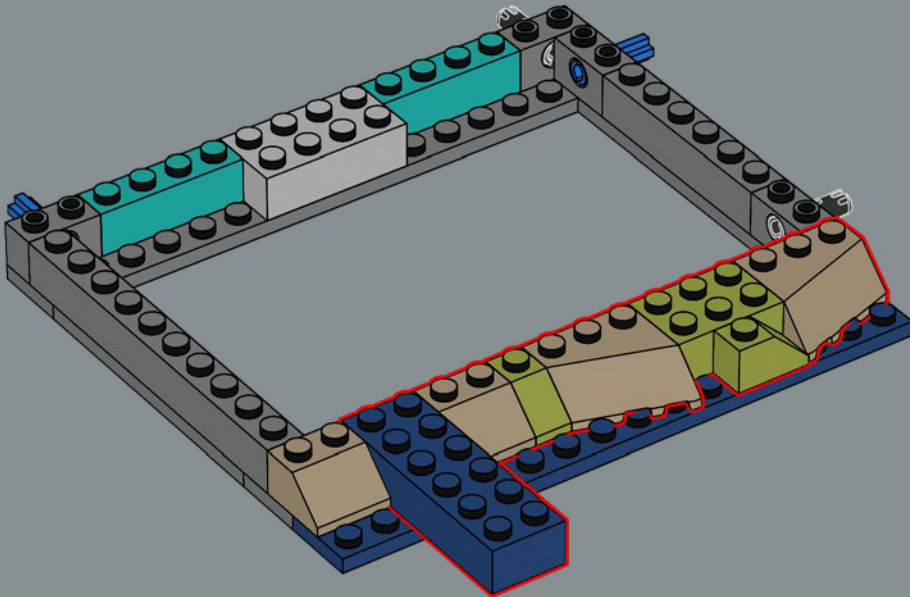

8

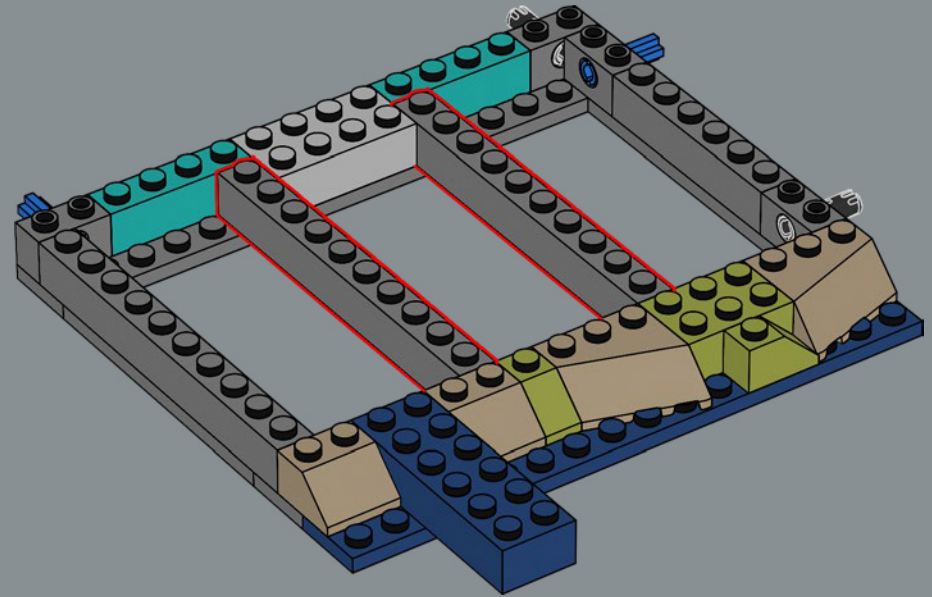

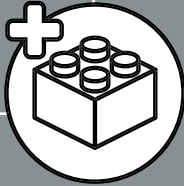
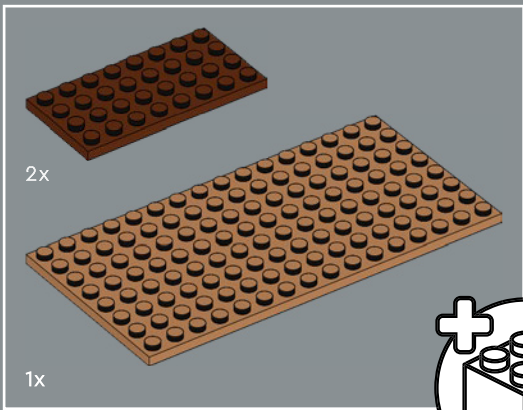

9

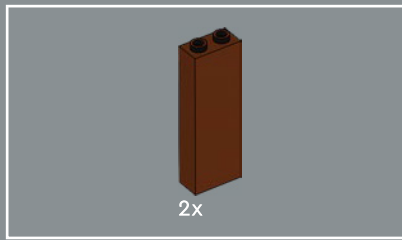
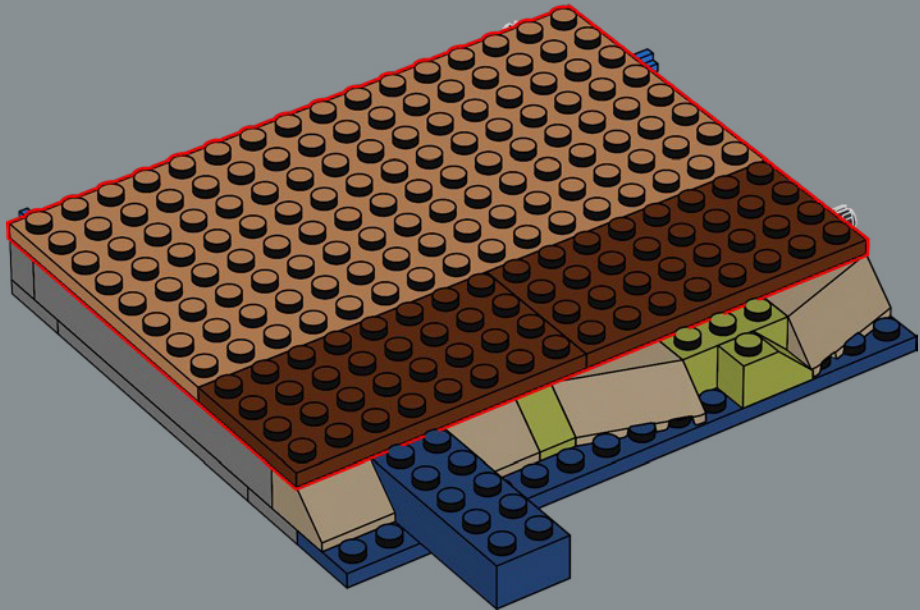

10

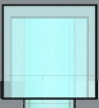
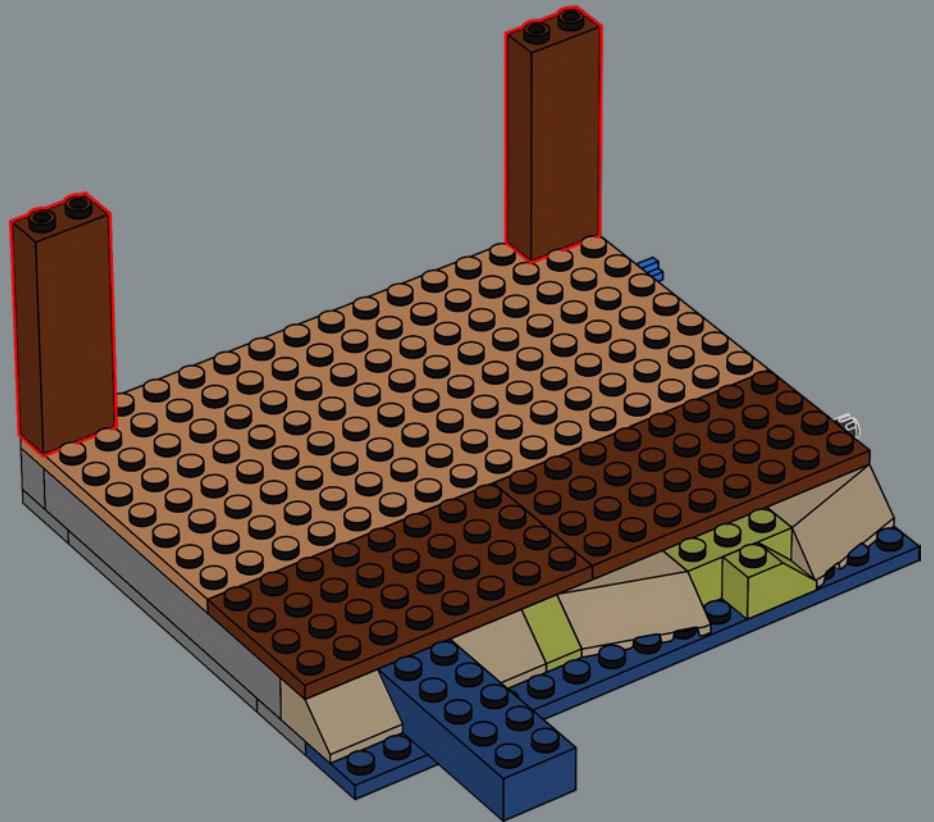

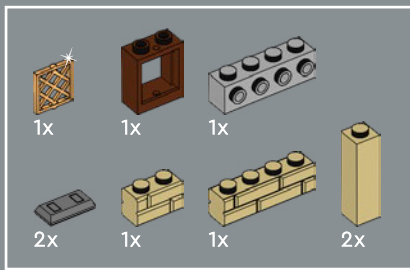

11

1

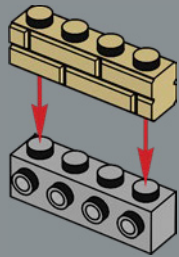

2

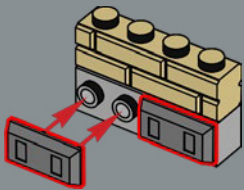

3

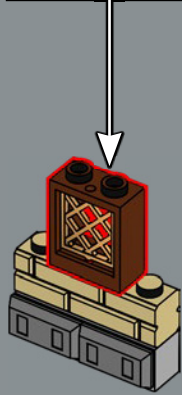
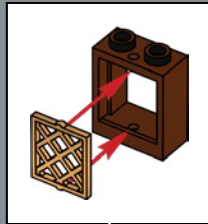

4

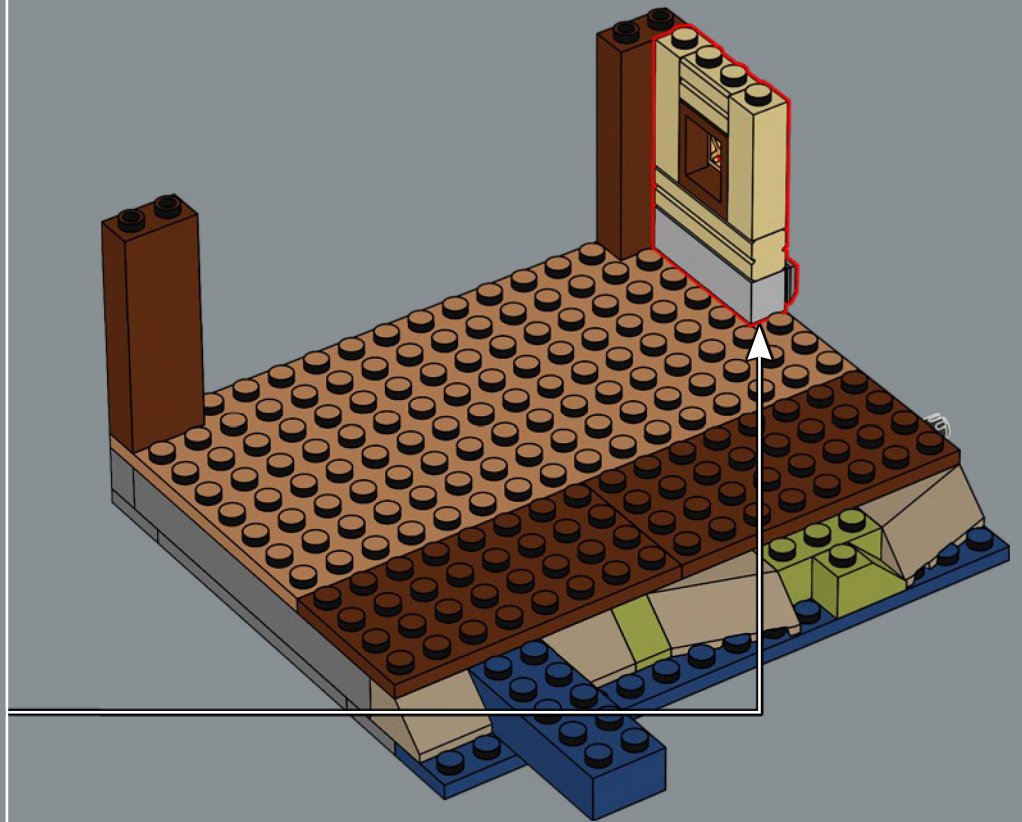

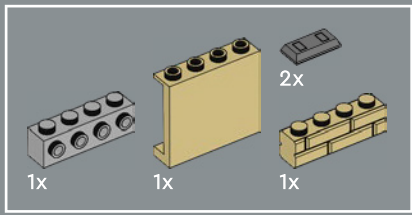

12

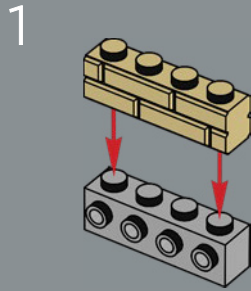

3

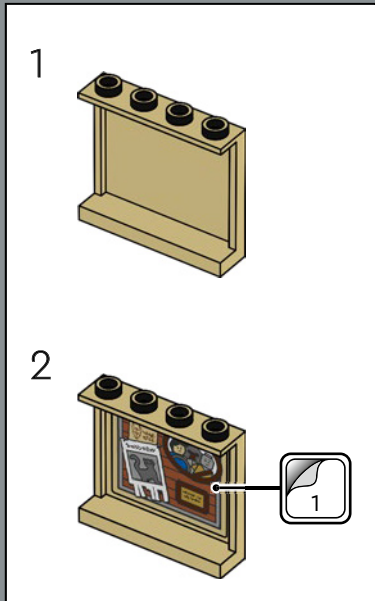
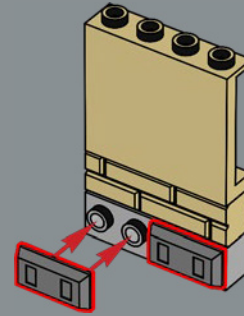

2

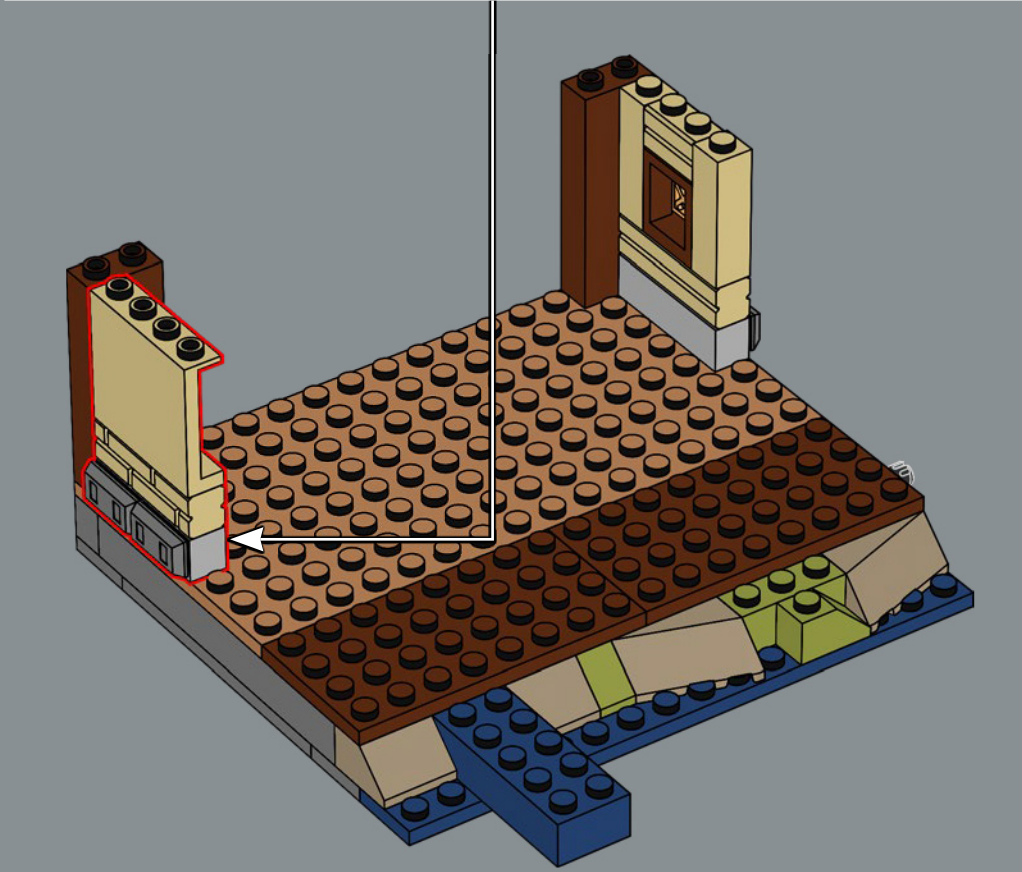
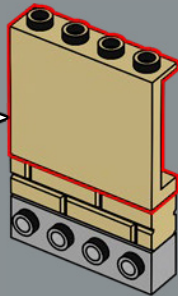



13

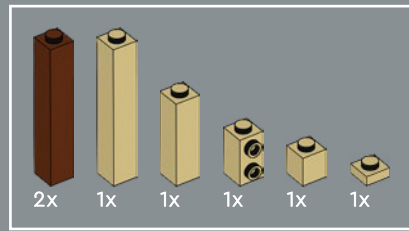
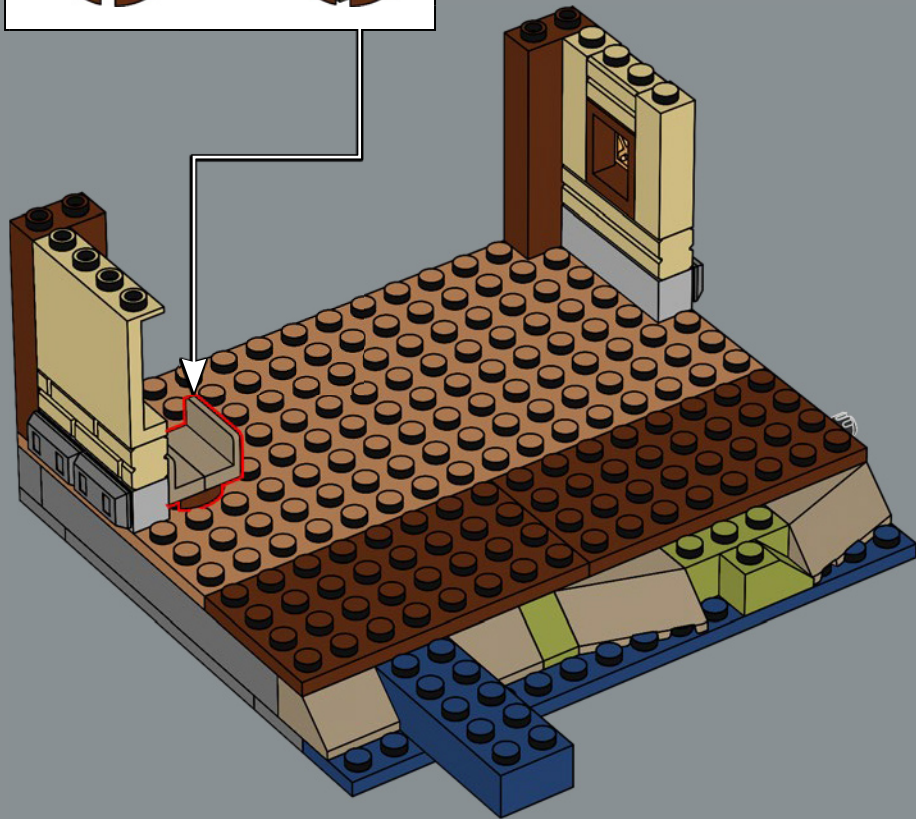
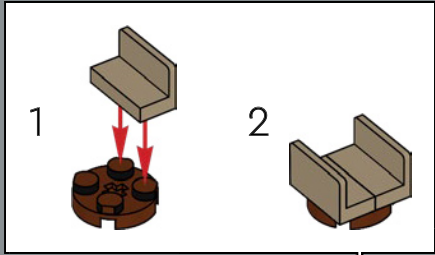

14

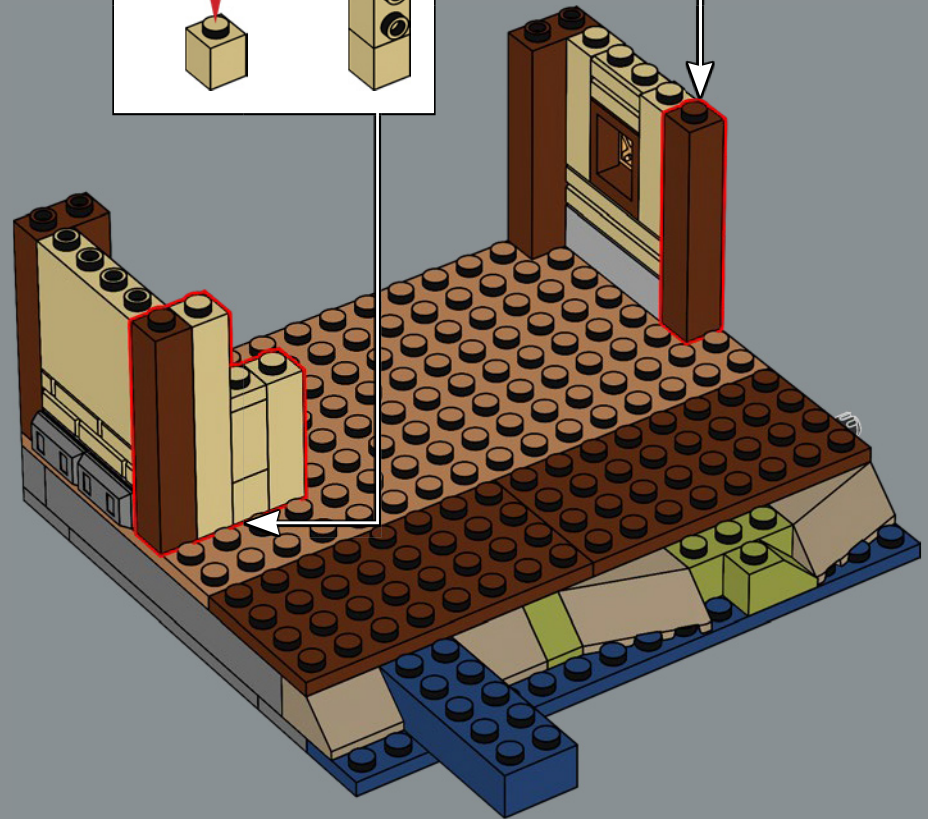
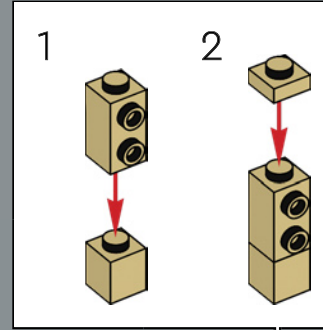

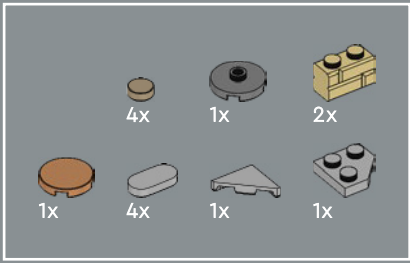

15

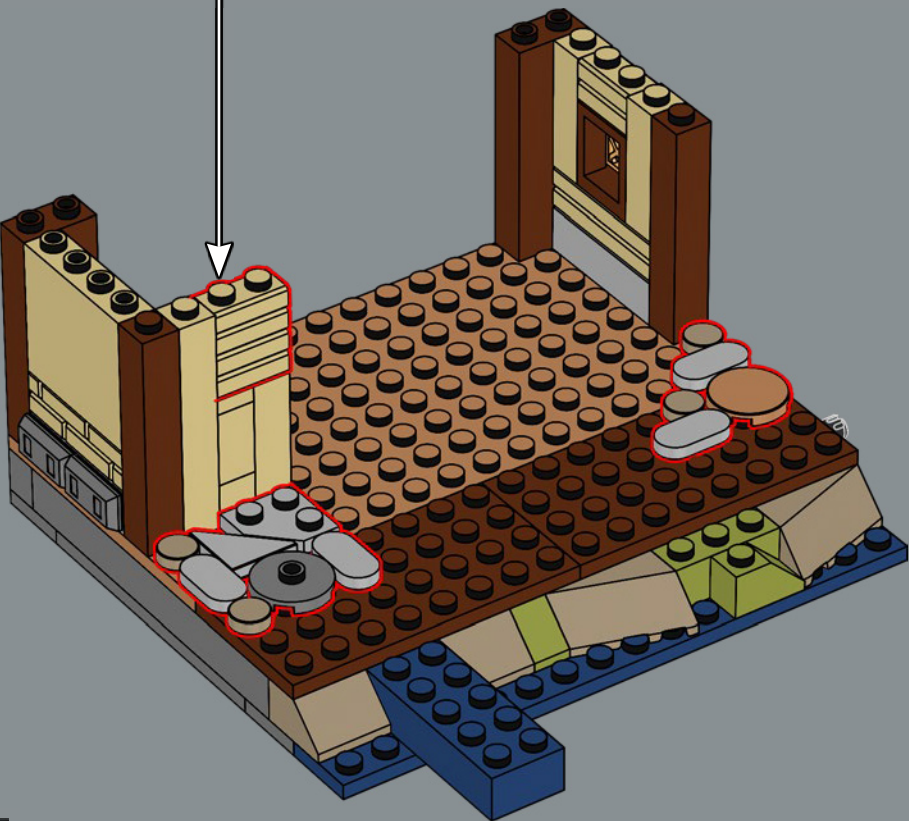
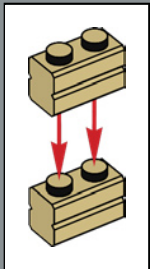

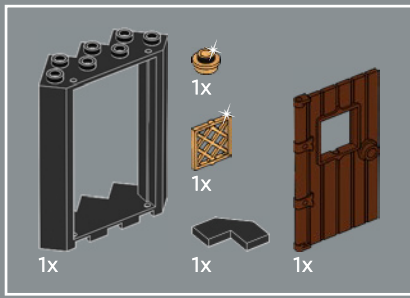

16

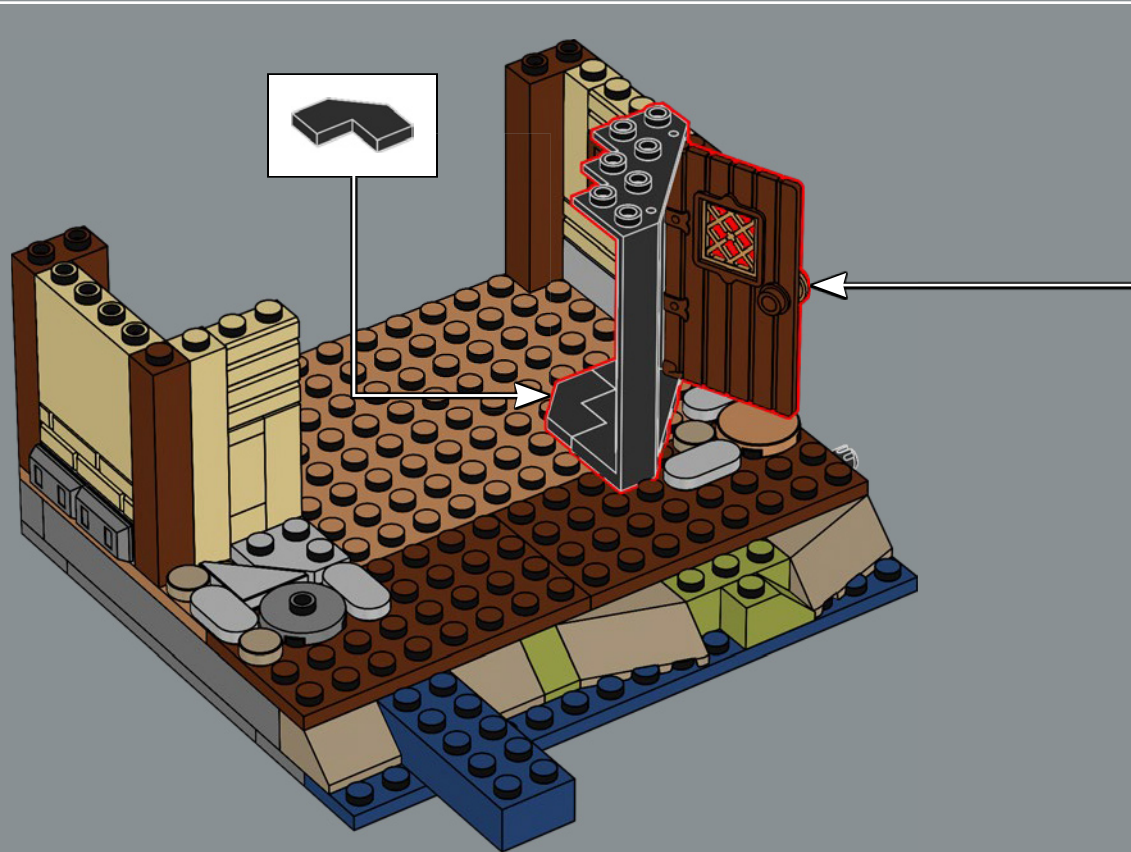
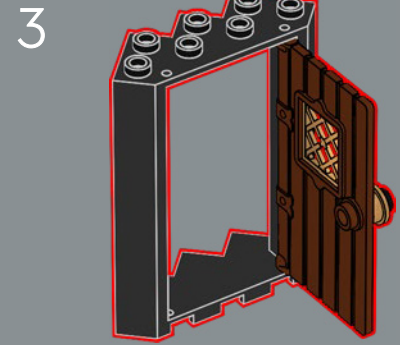
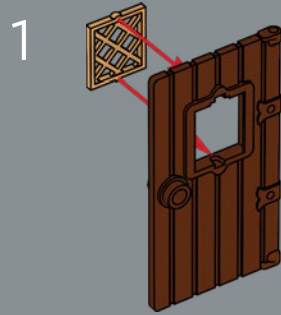

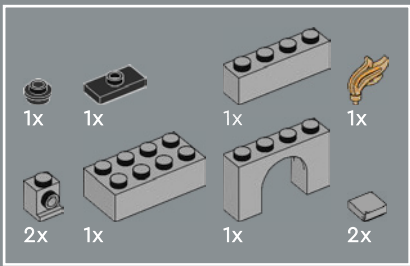

17

1

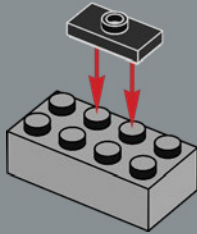

2

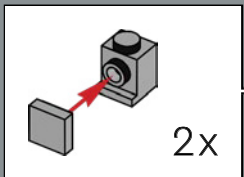
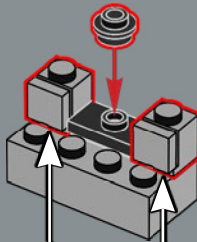

2x

3

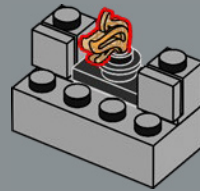

4

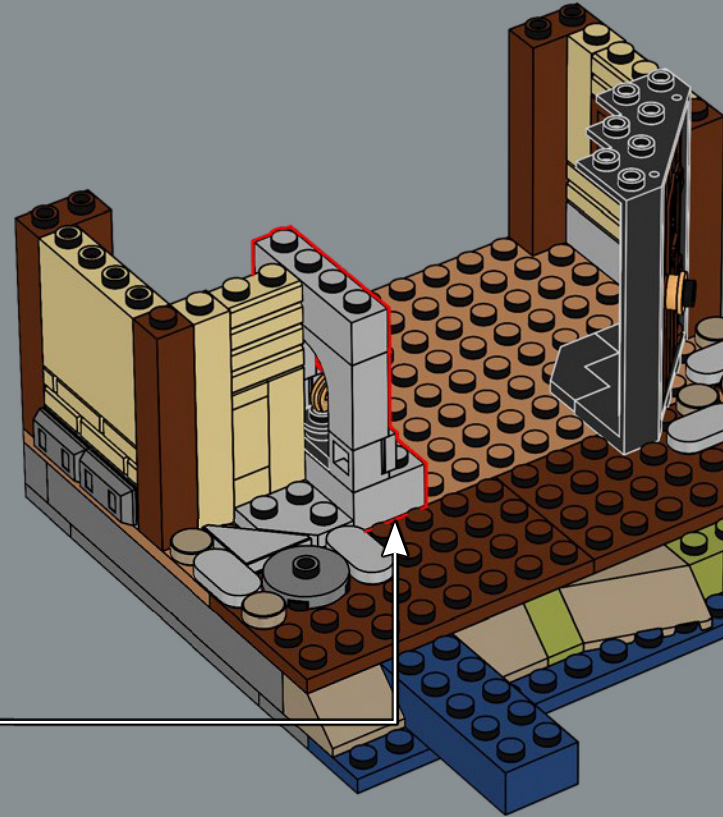
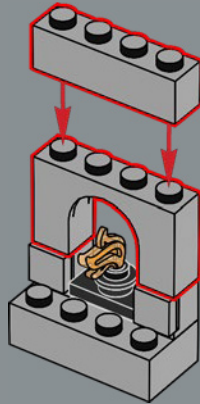

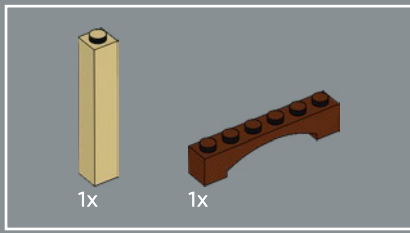

18

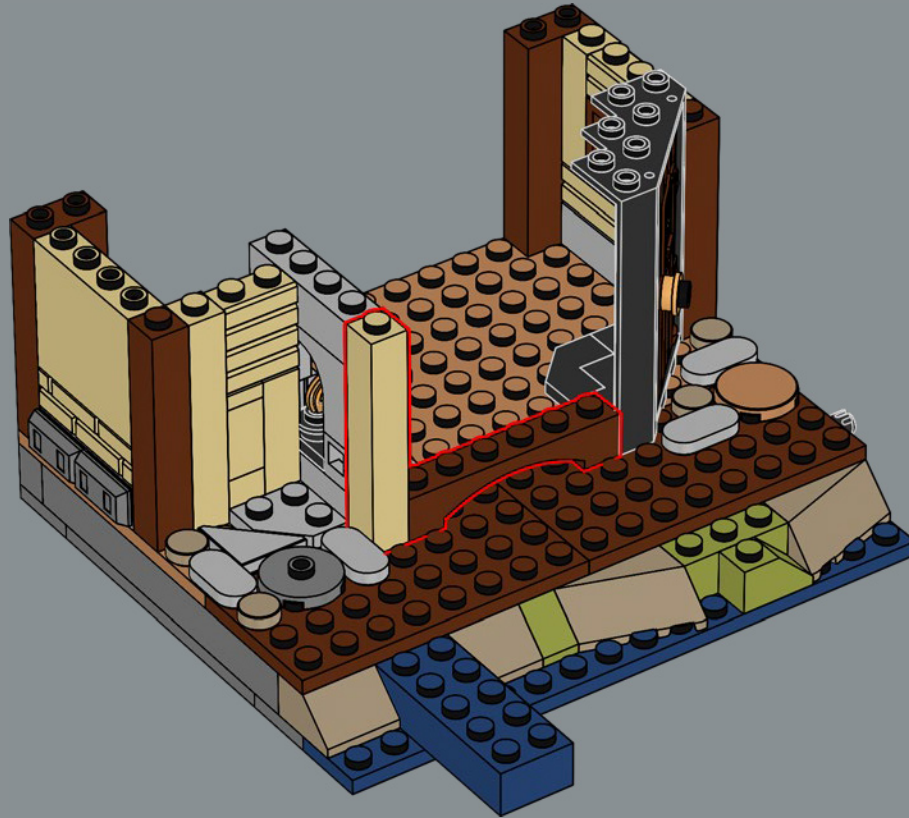

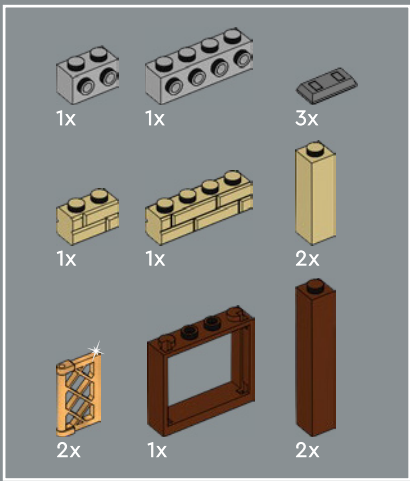

19

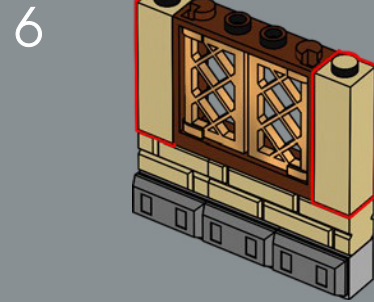
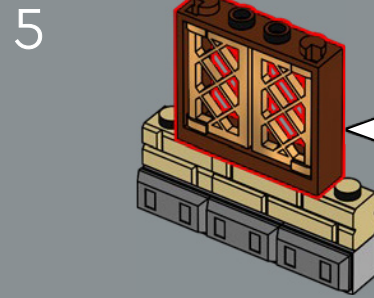
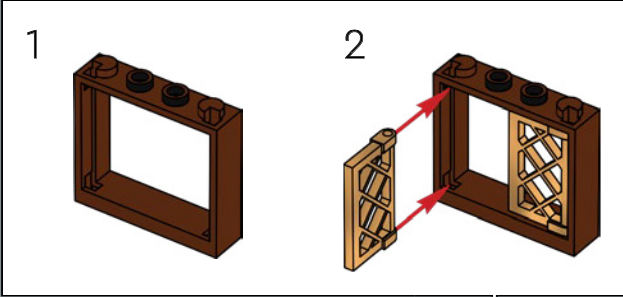
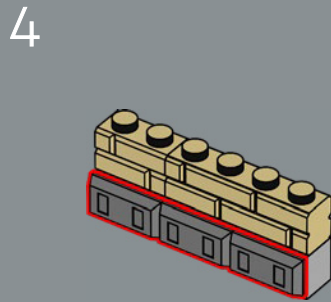
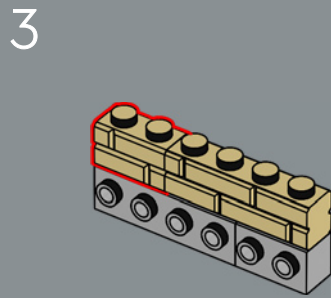
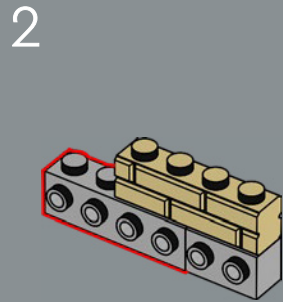
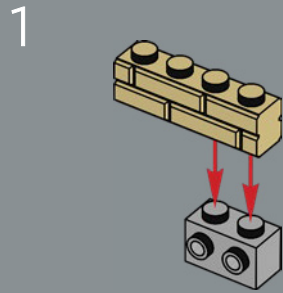

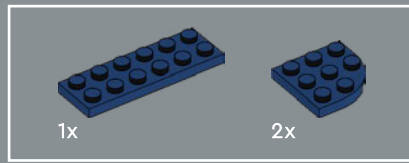
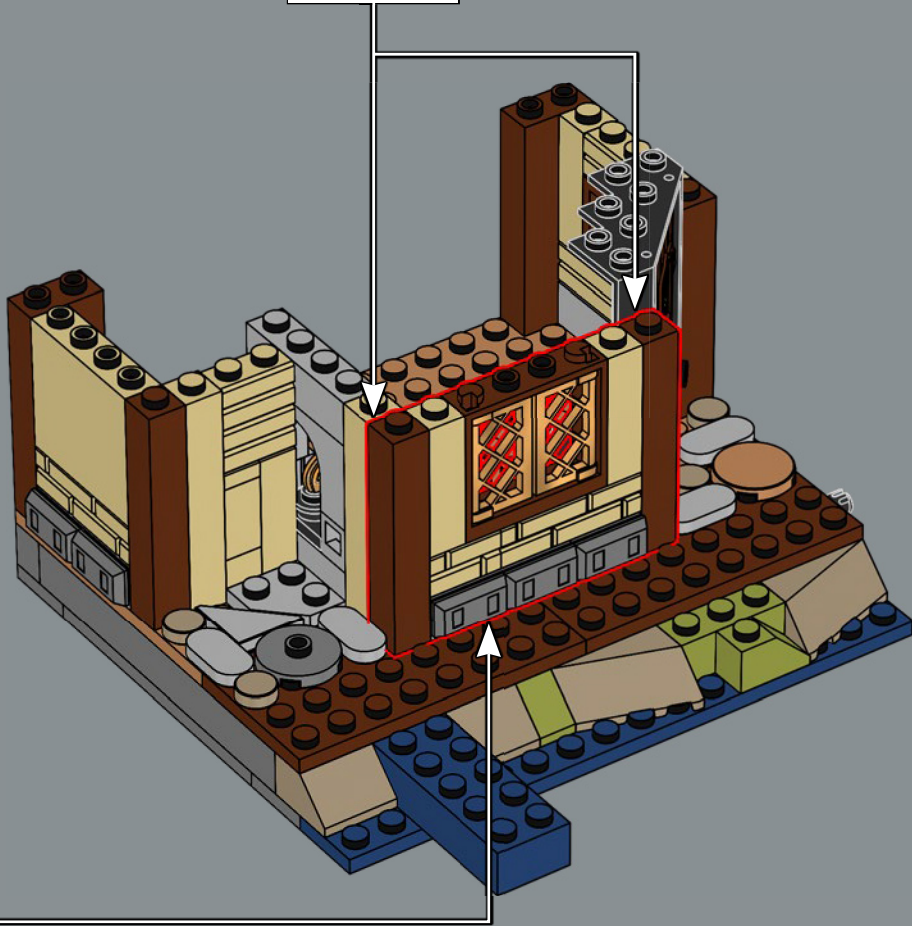
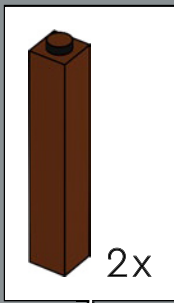

20

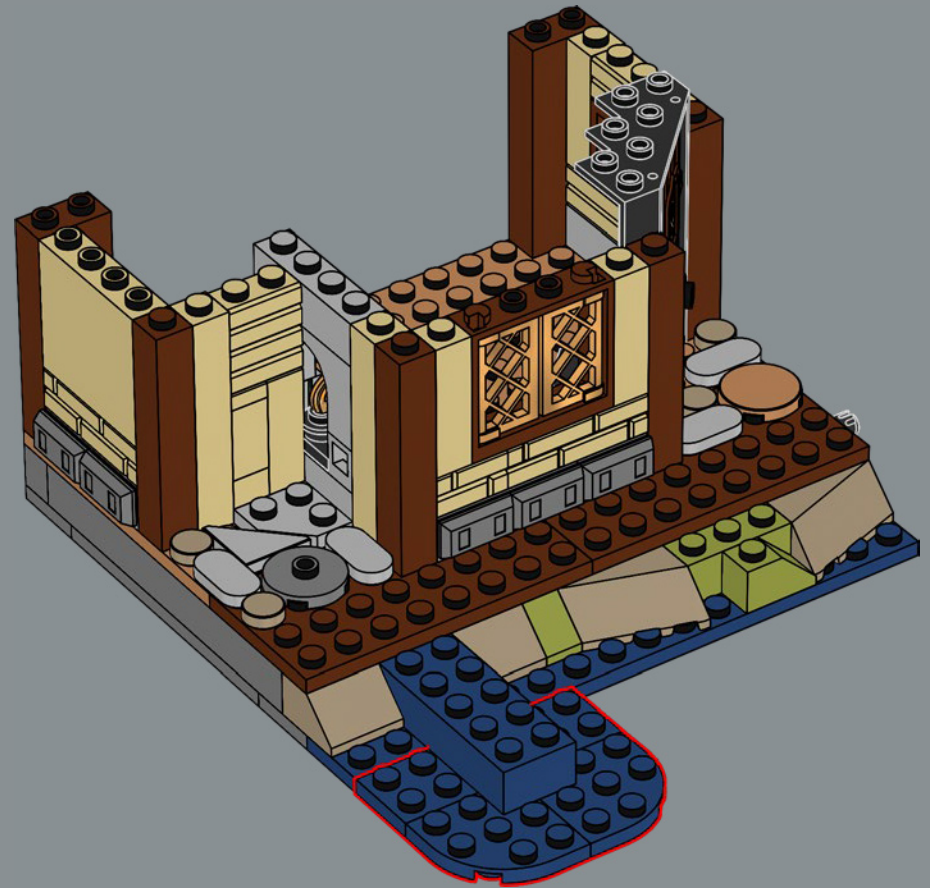



4x

21

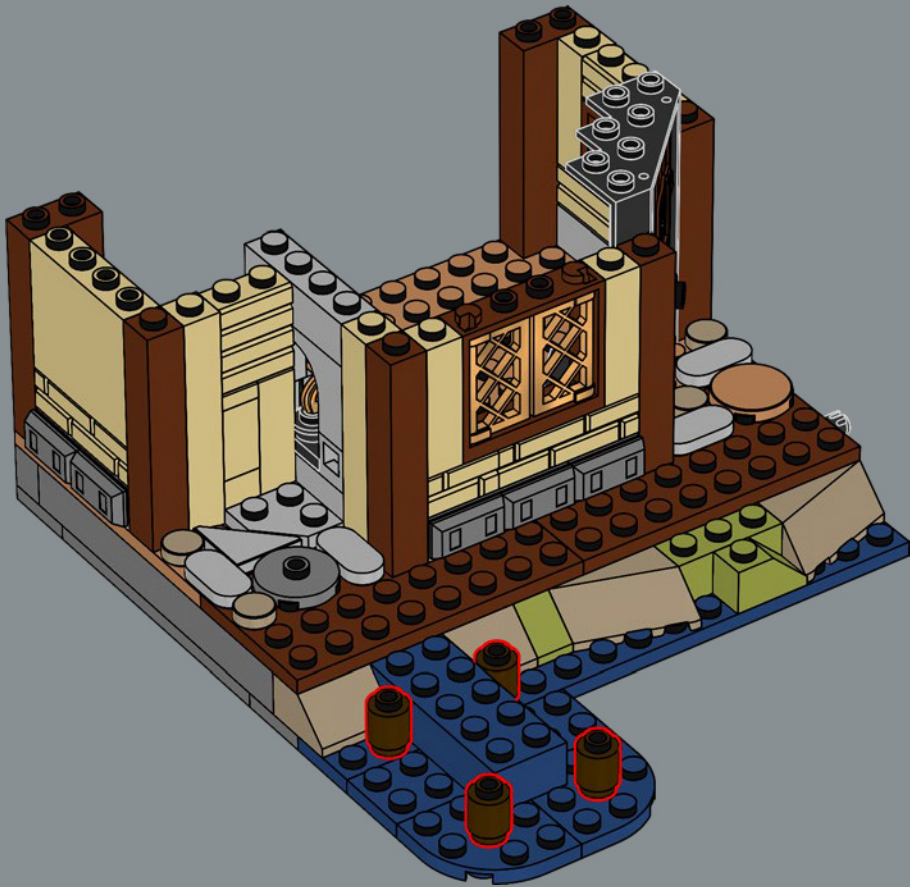

2x



1x

22

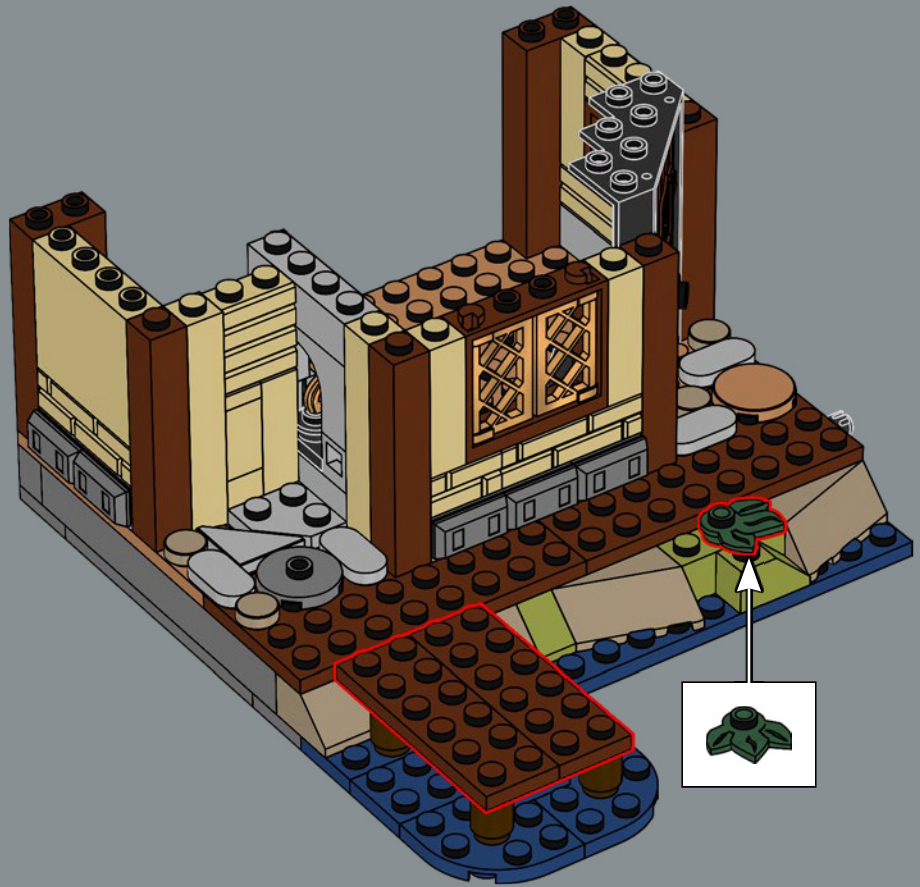

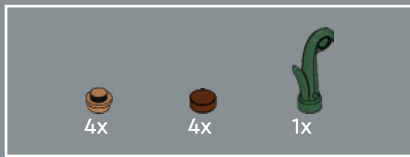

23

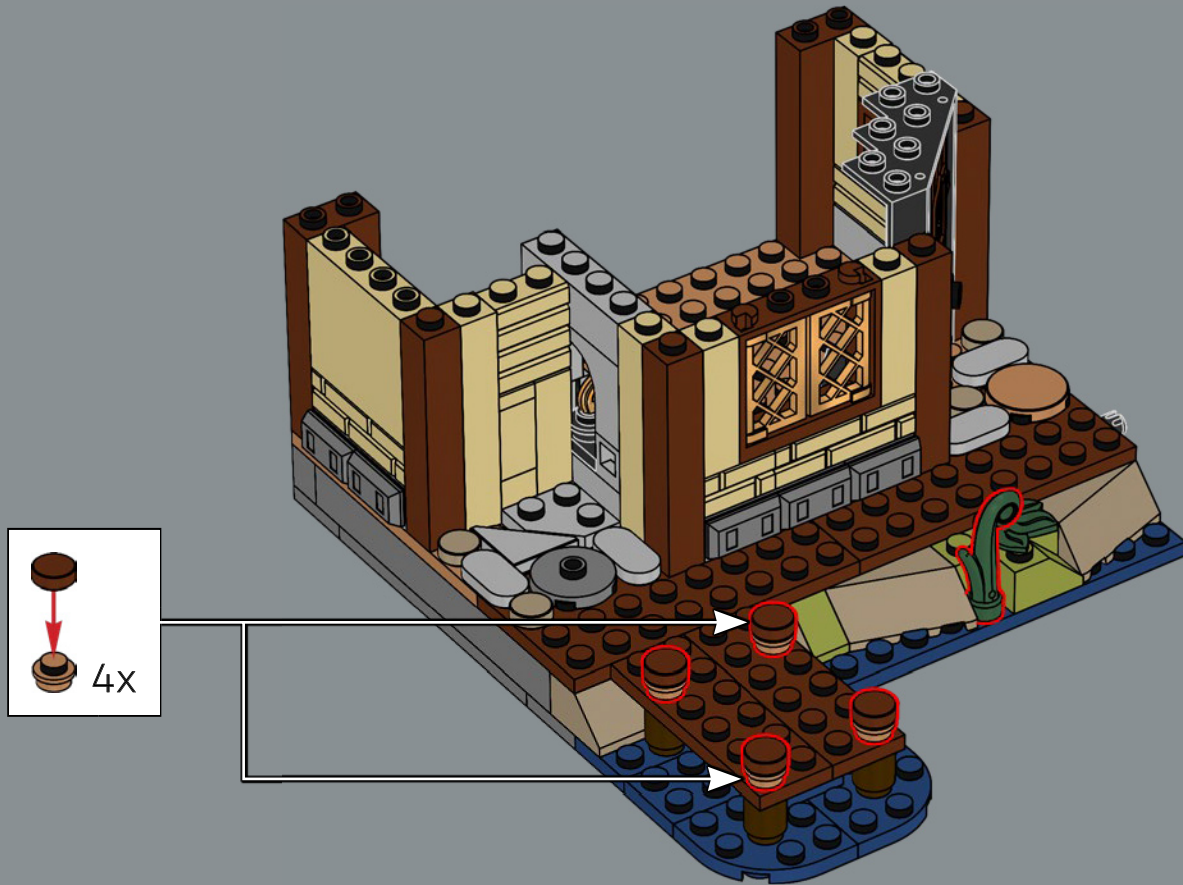

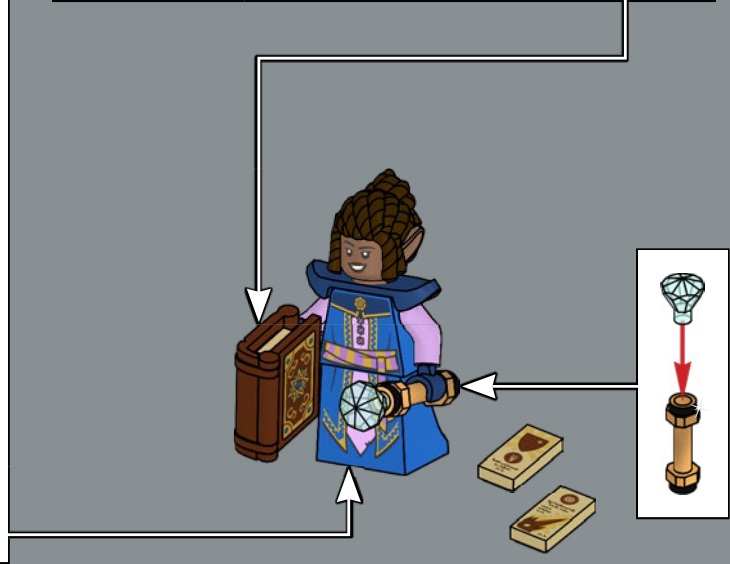
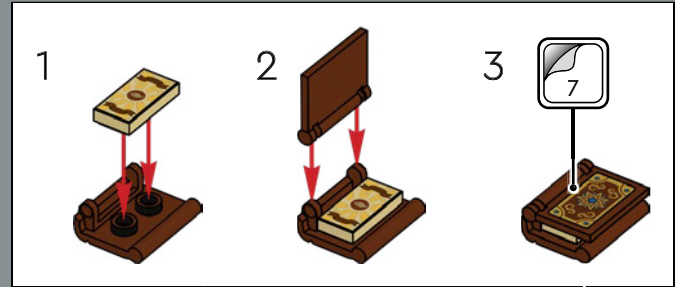
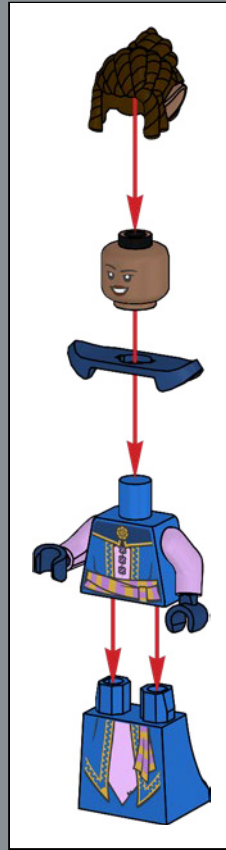

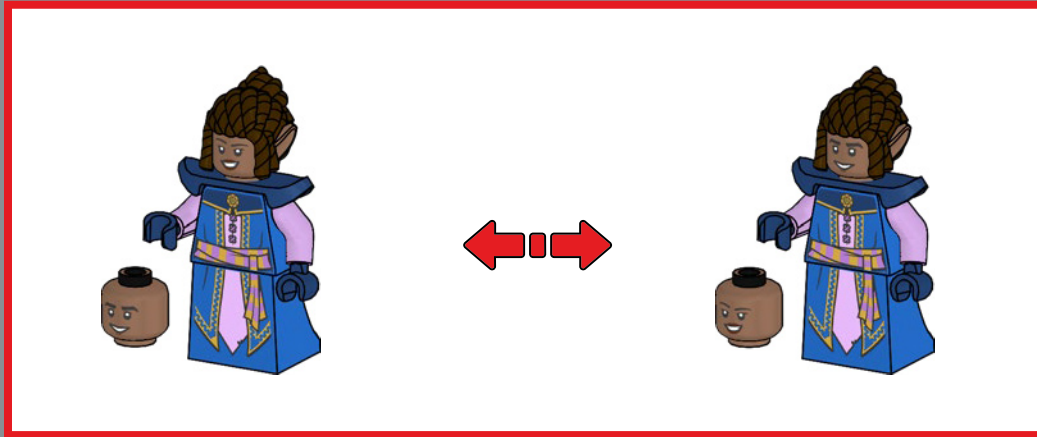



24

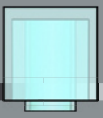
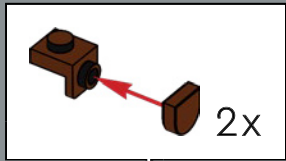

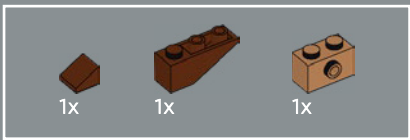

25

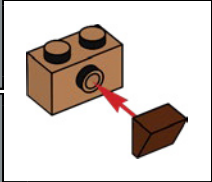
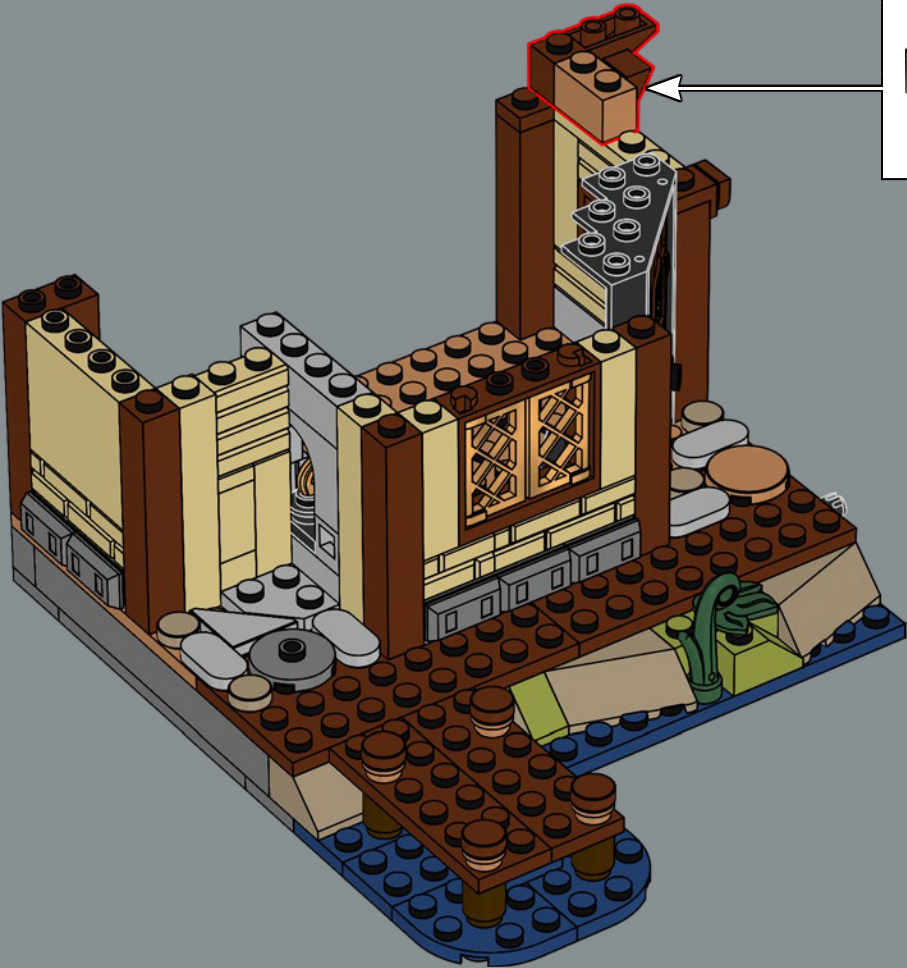

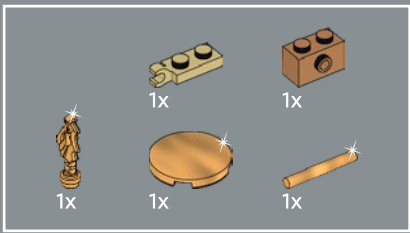

26

1

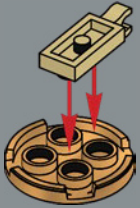

2



3

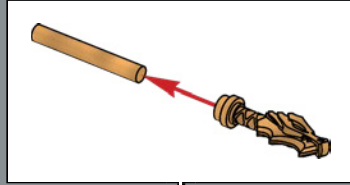

4

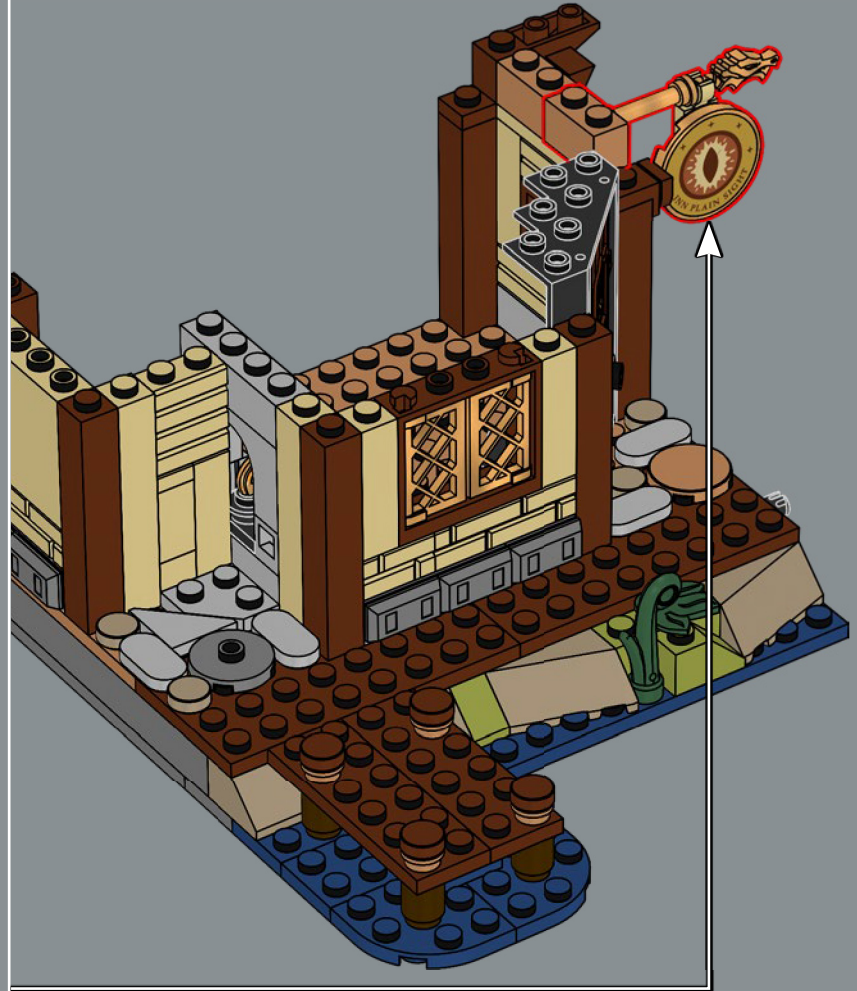
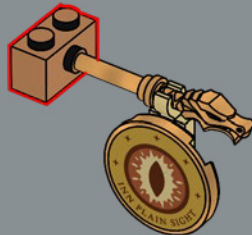

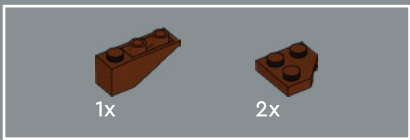

27



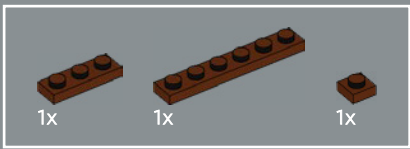

28

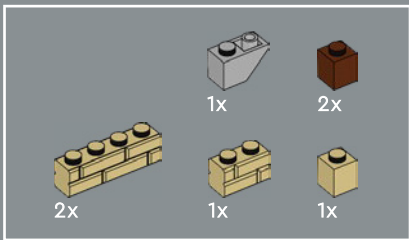

29



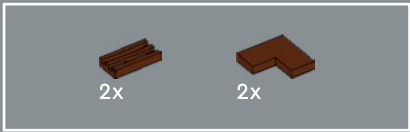

30



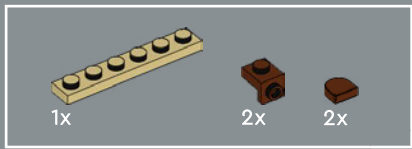

31

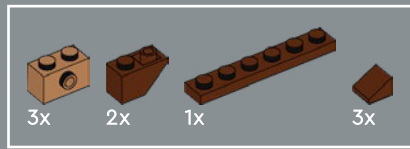
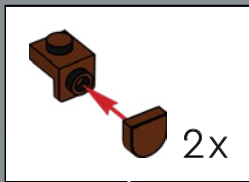

32

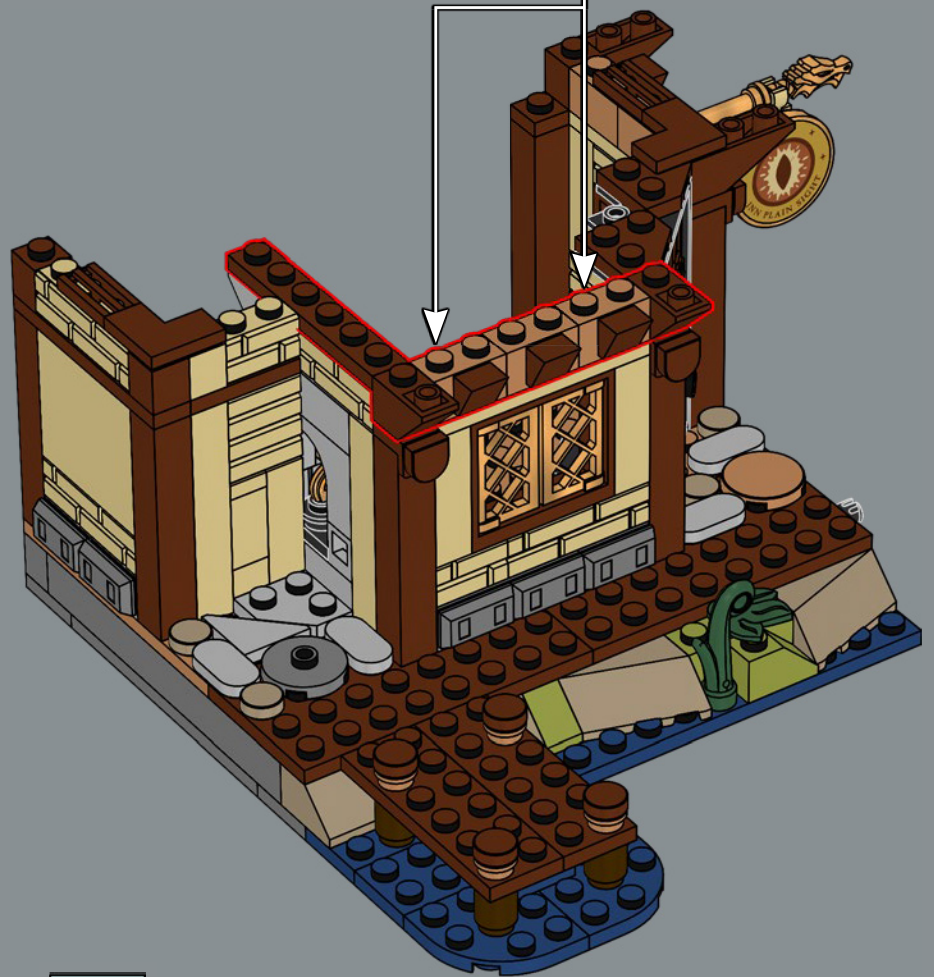
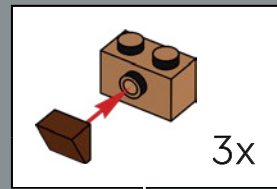

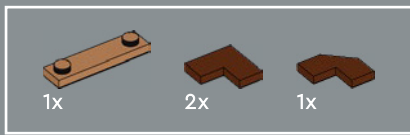

33



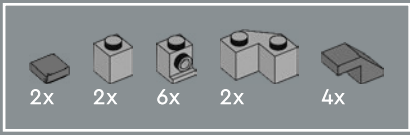

34

1

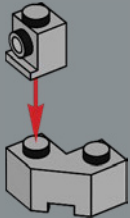

3

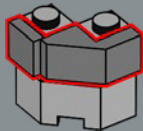

5

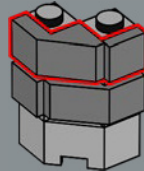

7

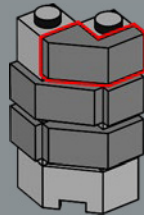

2

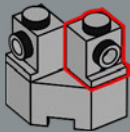

4

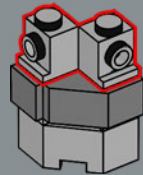

6

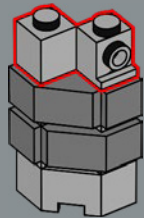

8

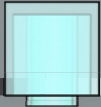
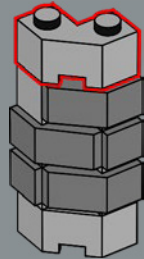

9

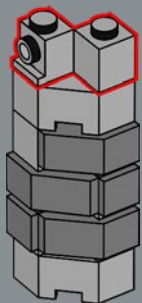

10

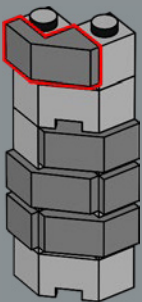

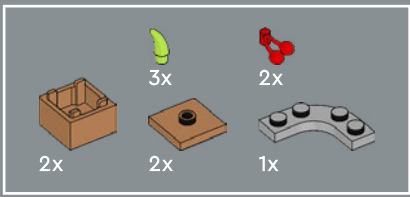

35

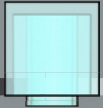
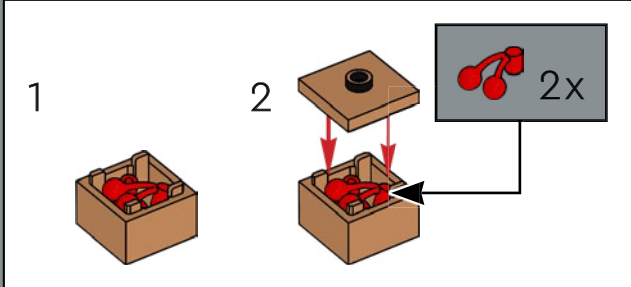
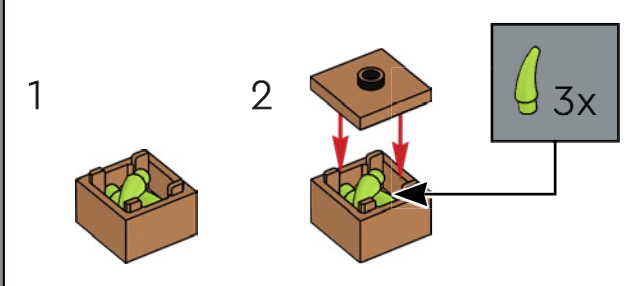

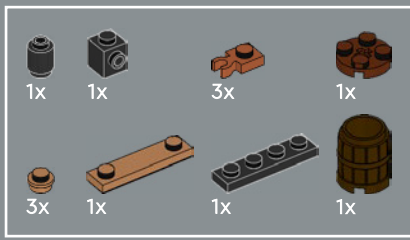

36

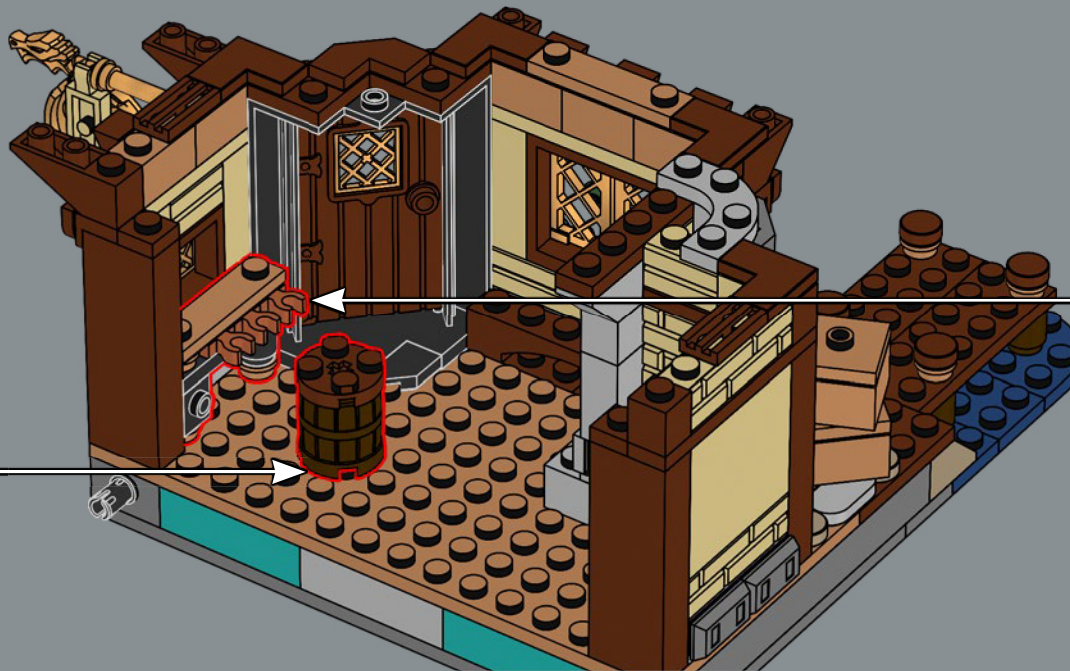
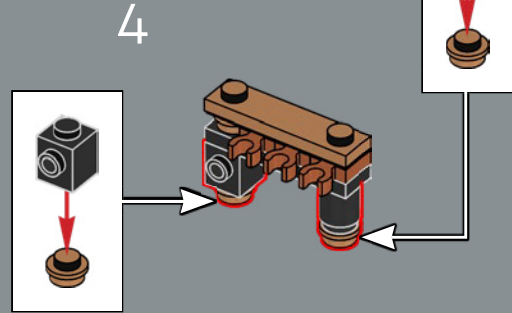
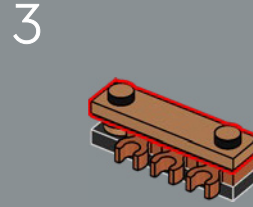
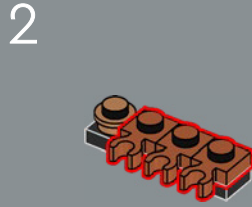
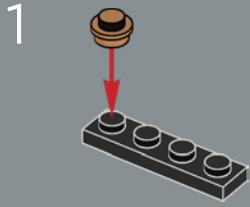

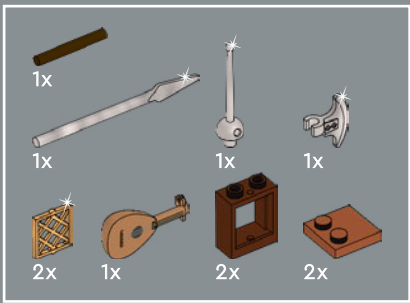

37

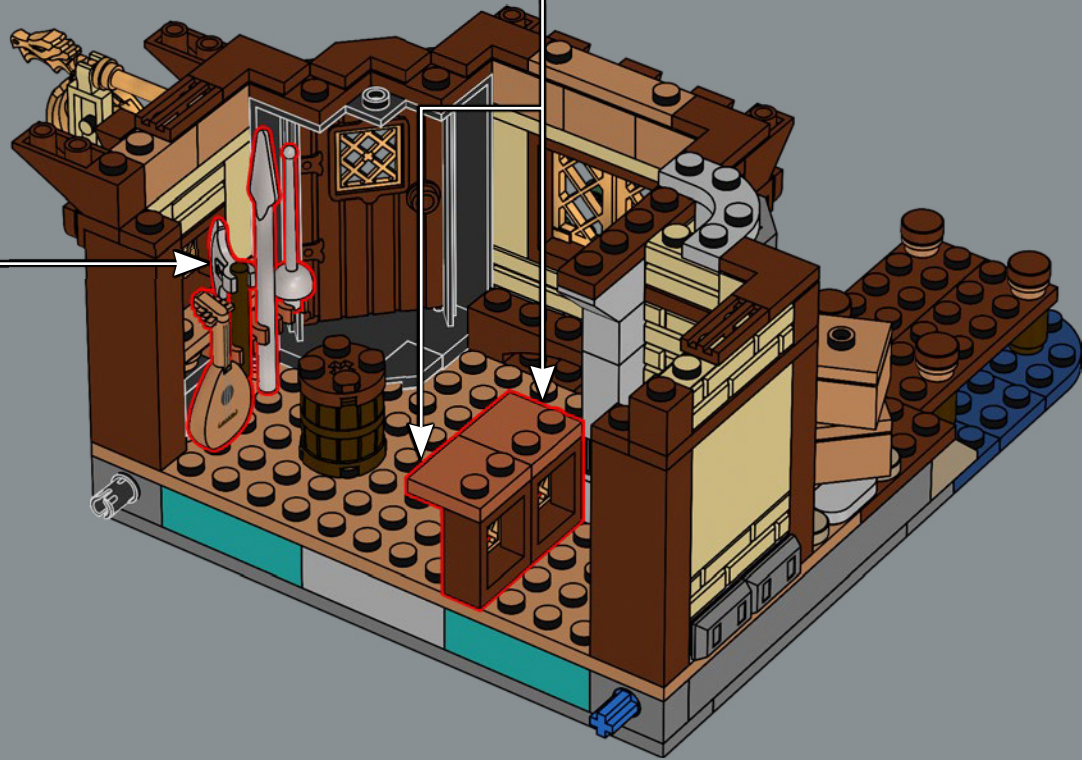
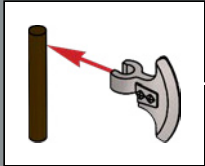
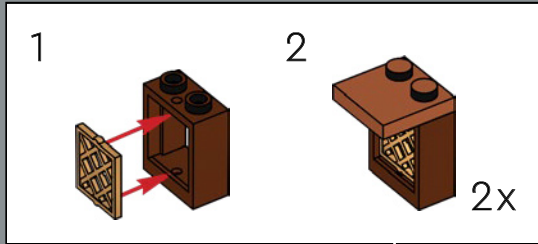

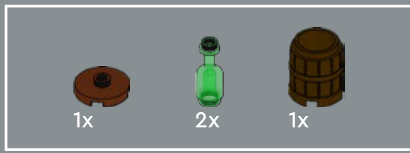

38

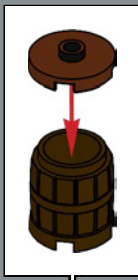

39

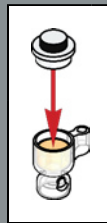
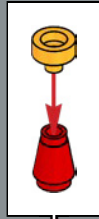
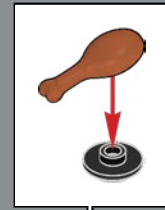

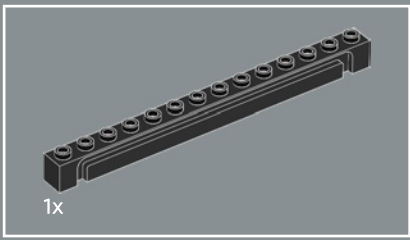

40

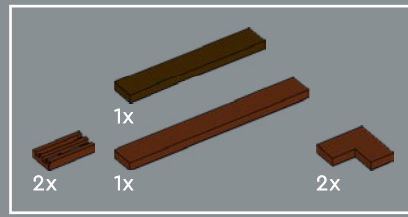
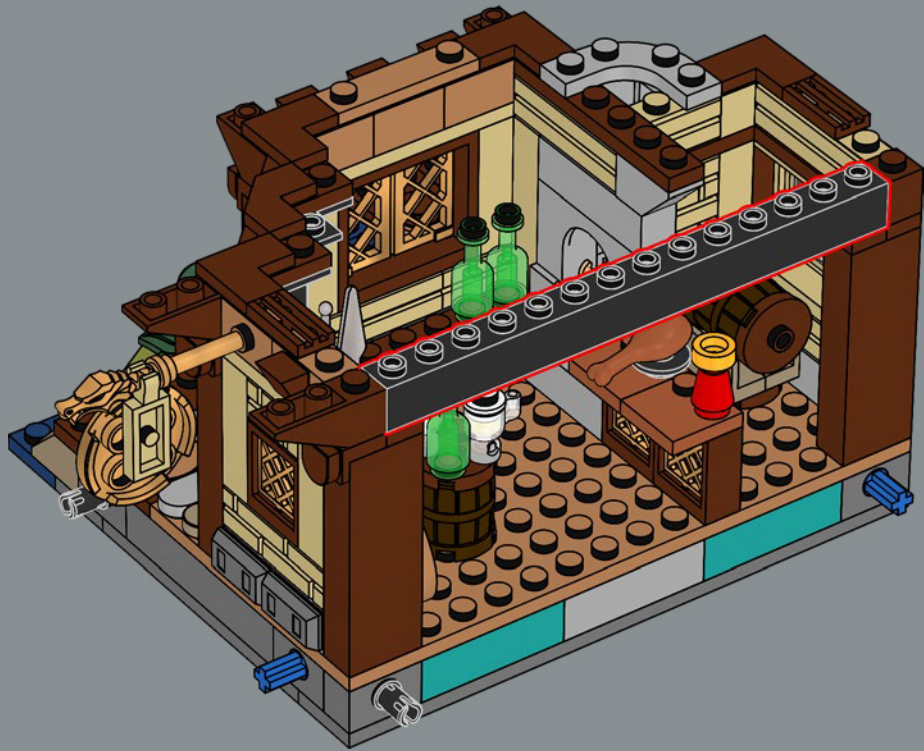

41

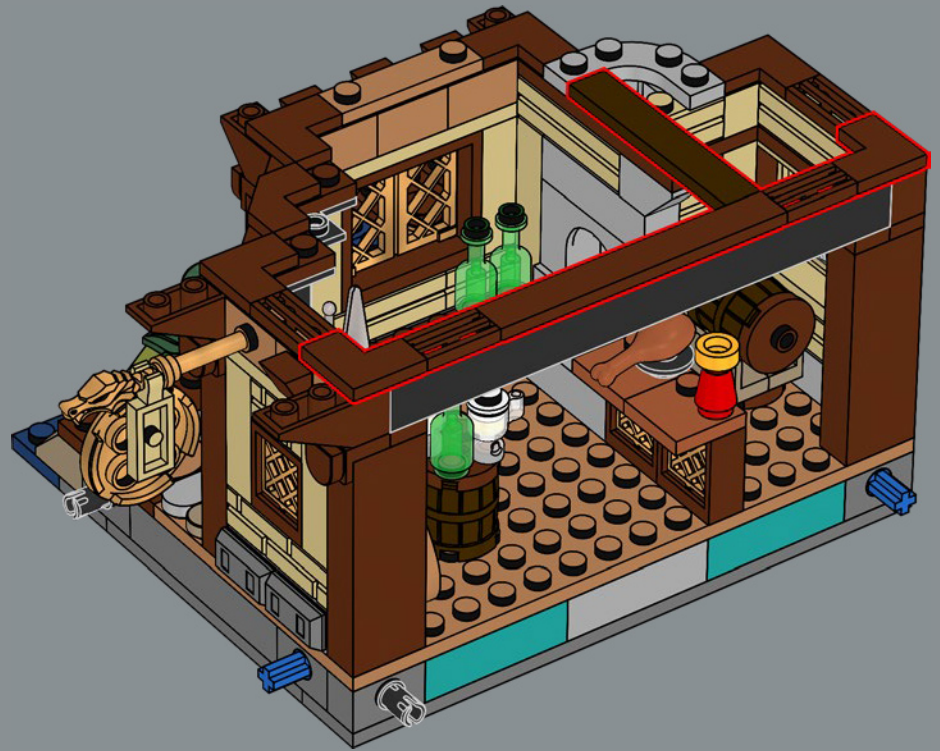

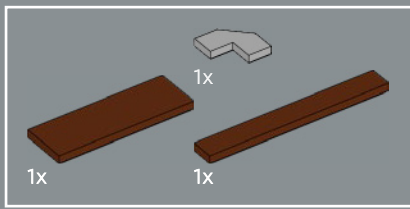

42

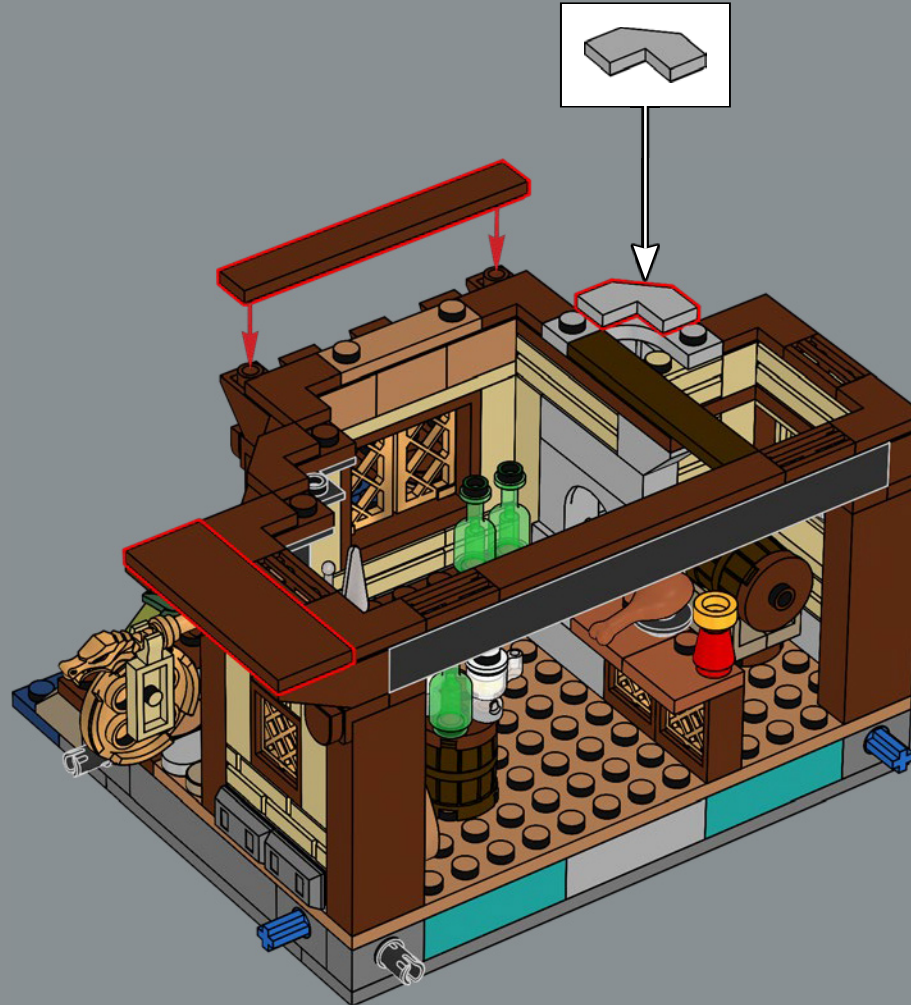

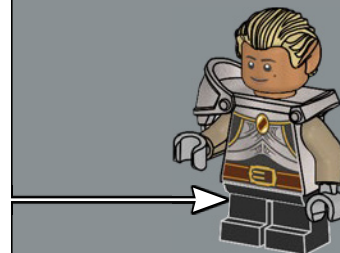
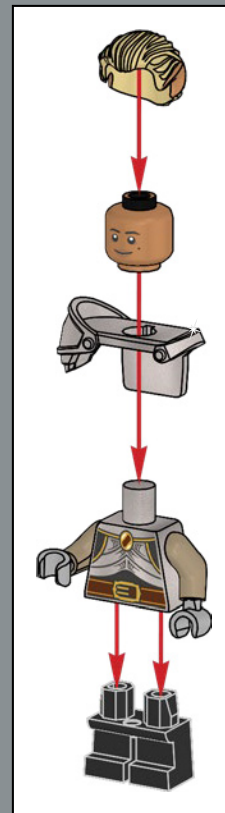

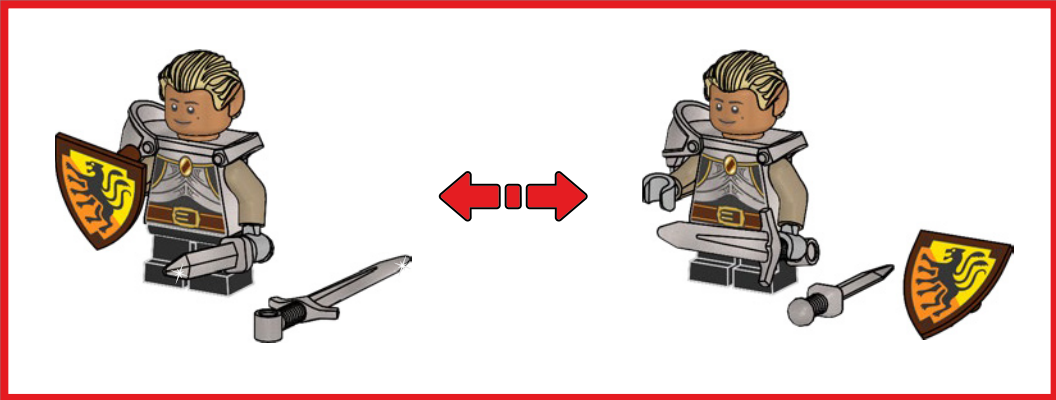
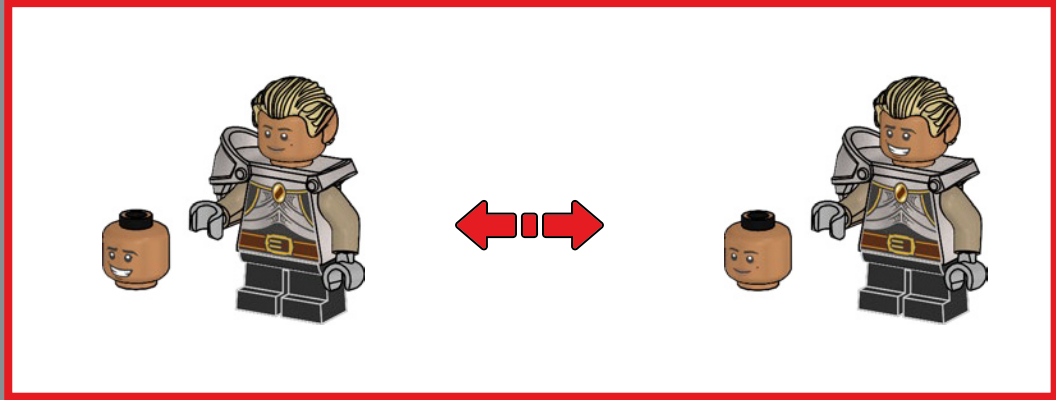

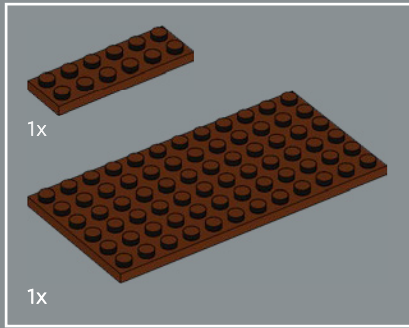
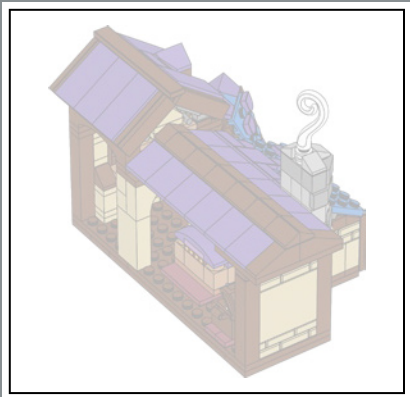

43

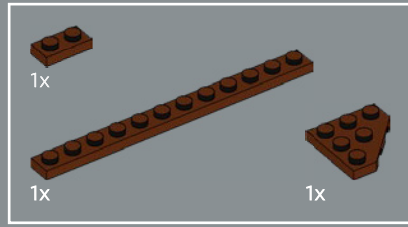
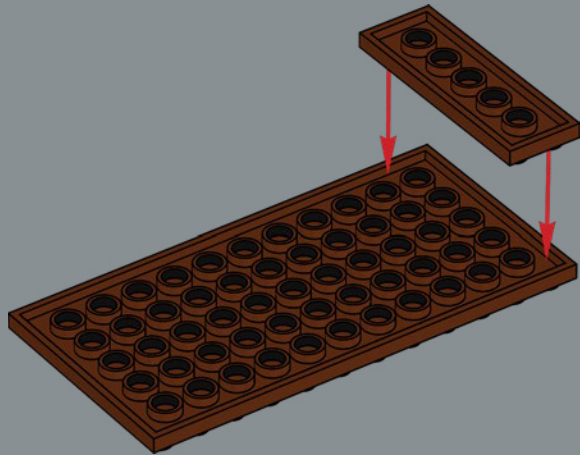

44

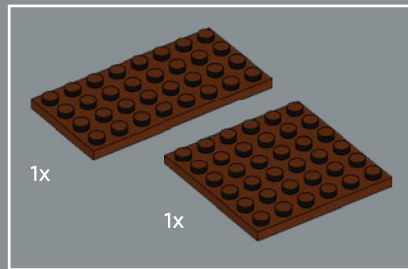
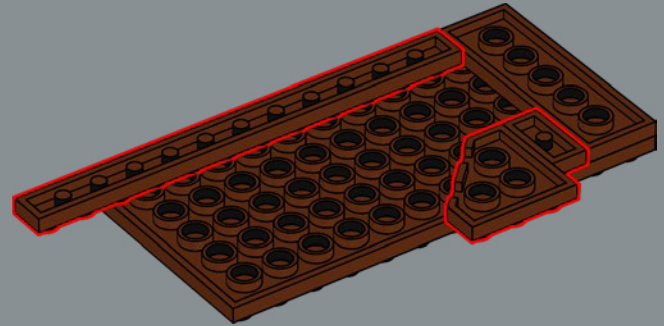

45

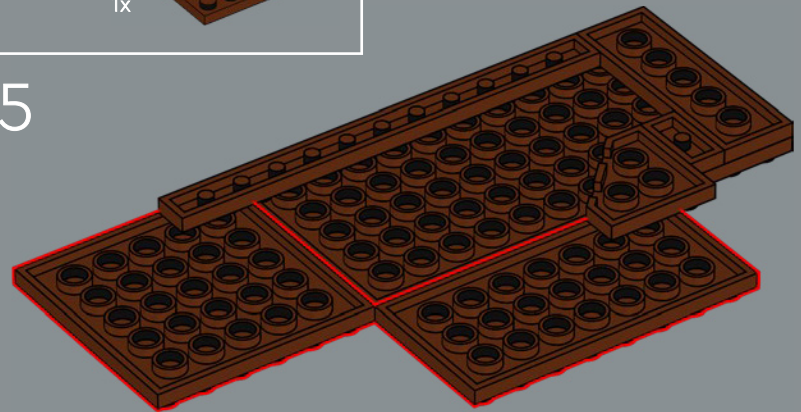

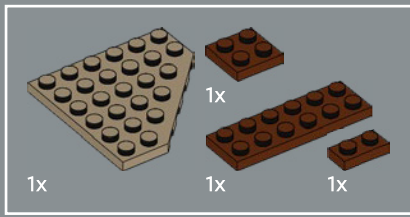

46

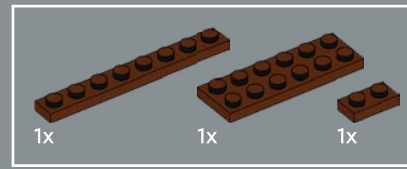
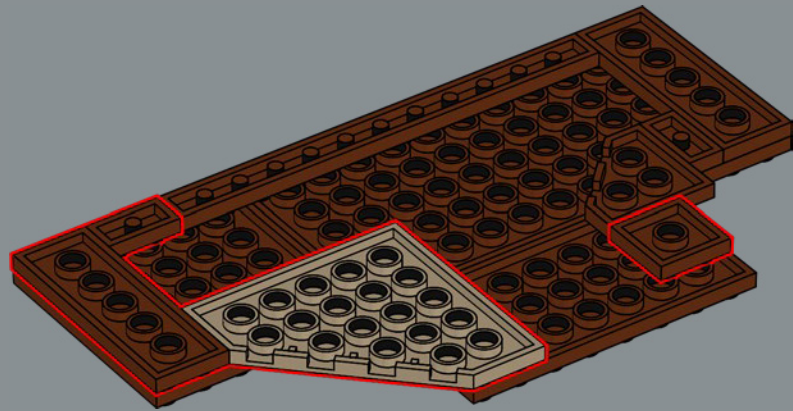

47

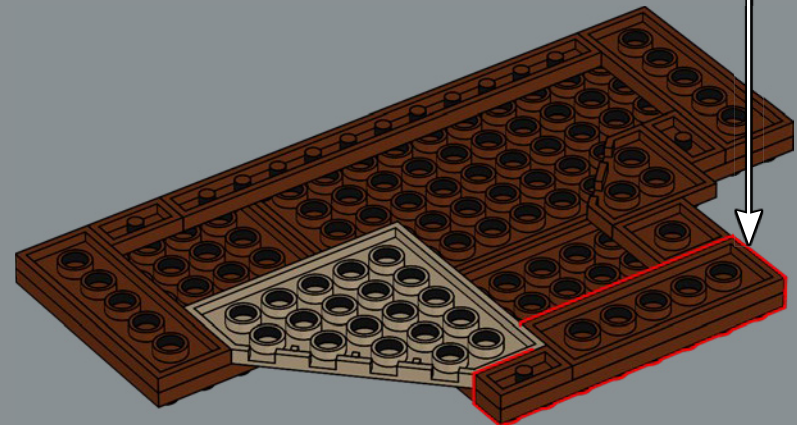
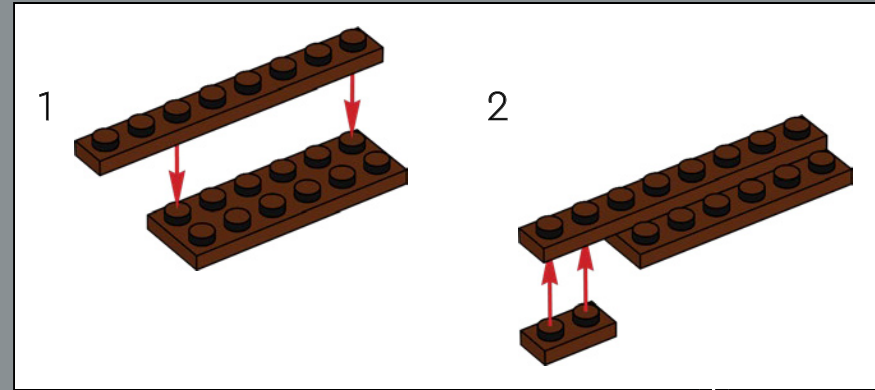

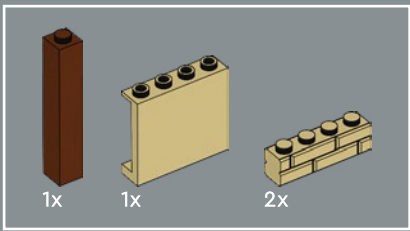

48

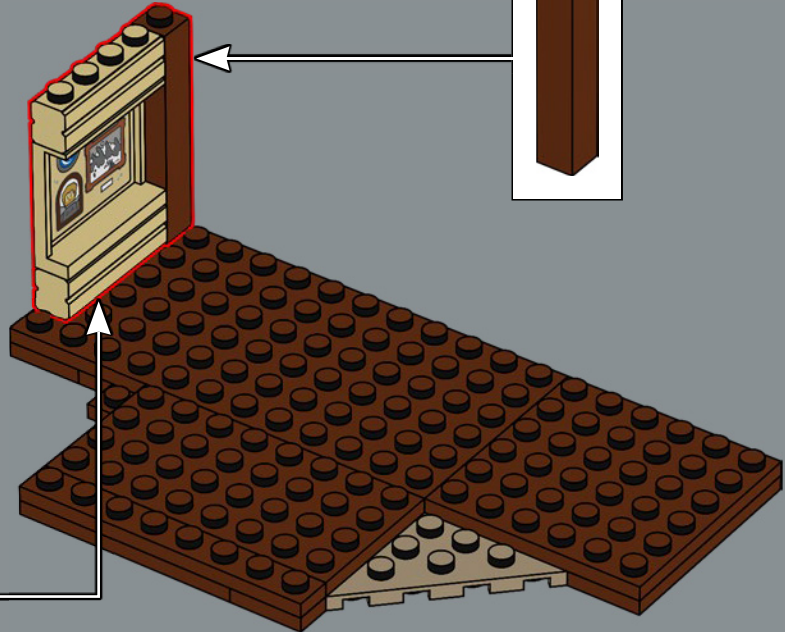
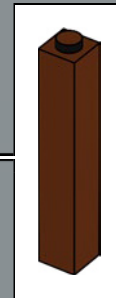
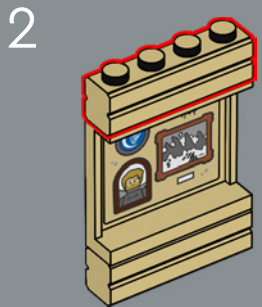
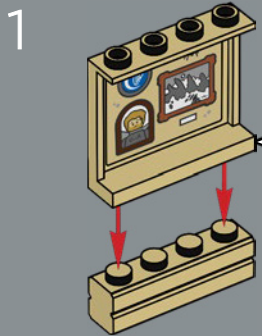
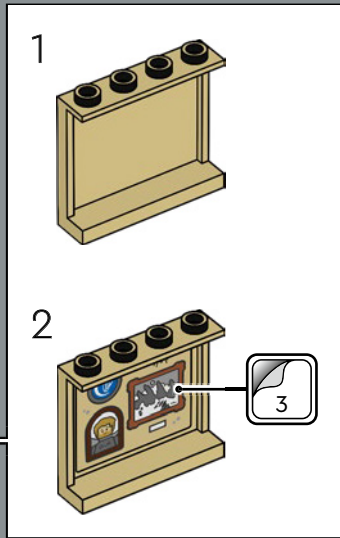

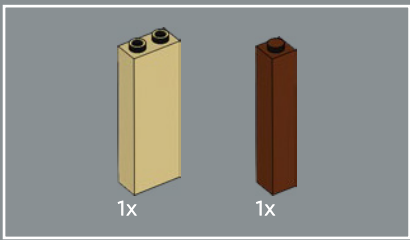

49

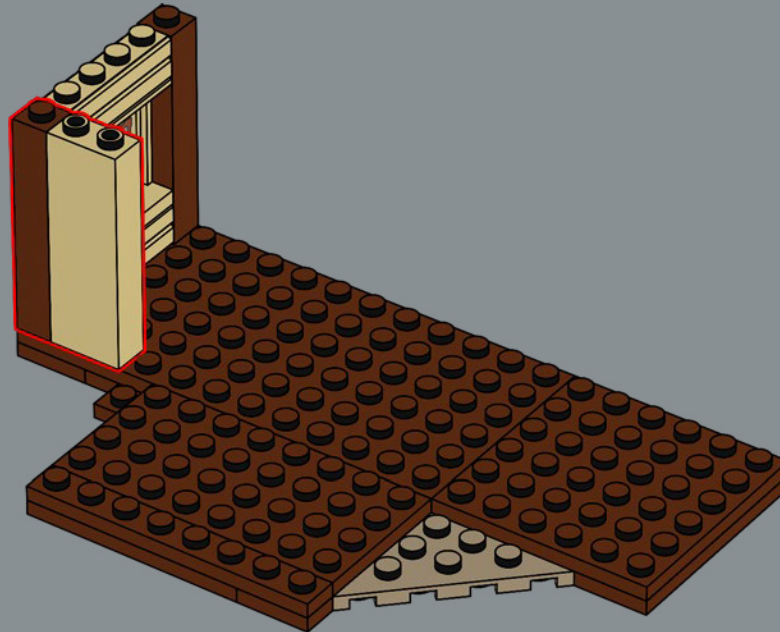

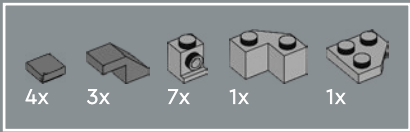

50

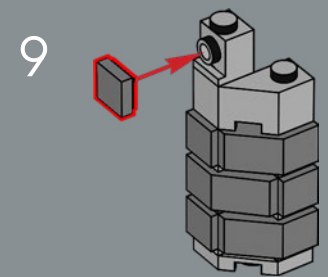
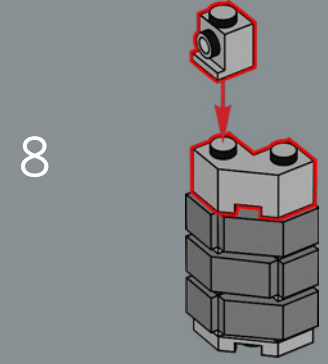
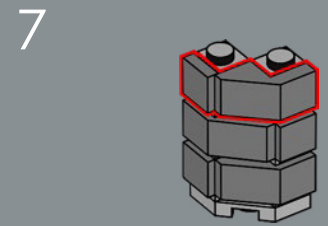
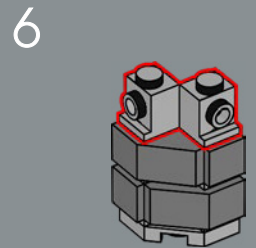
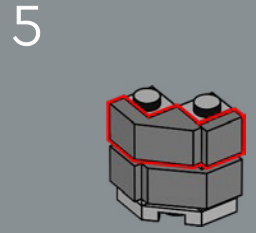
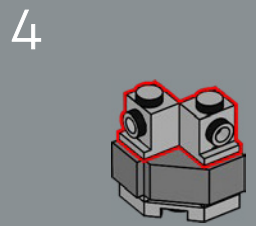
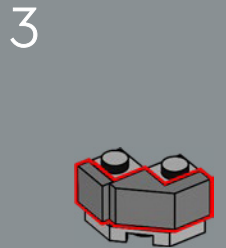
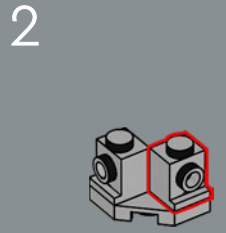
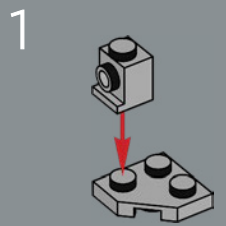

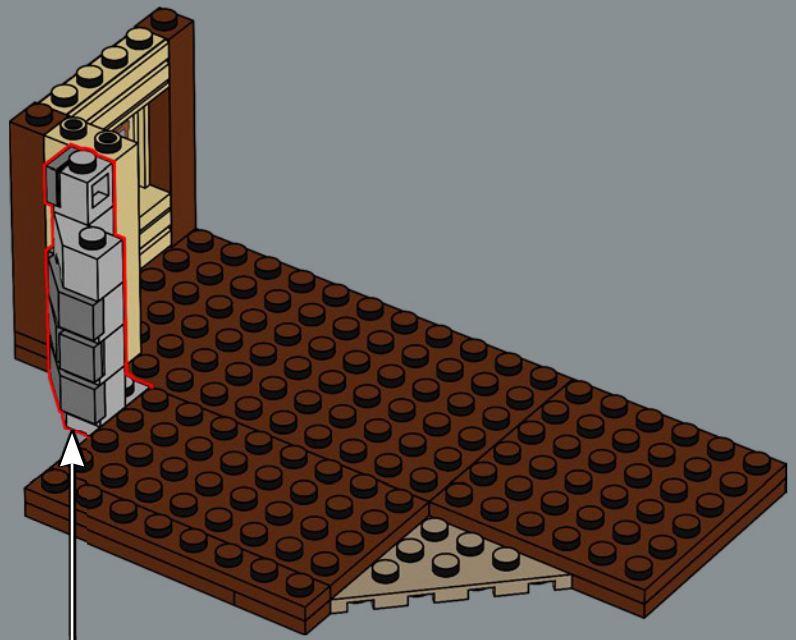

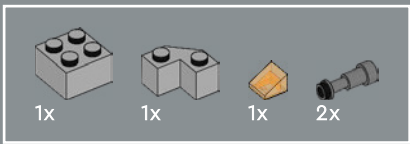

51

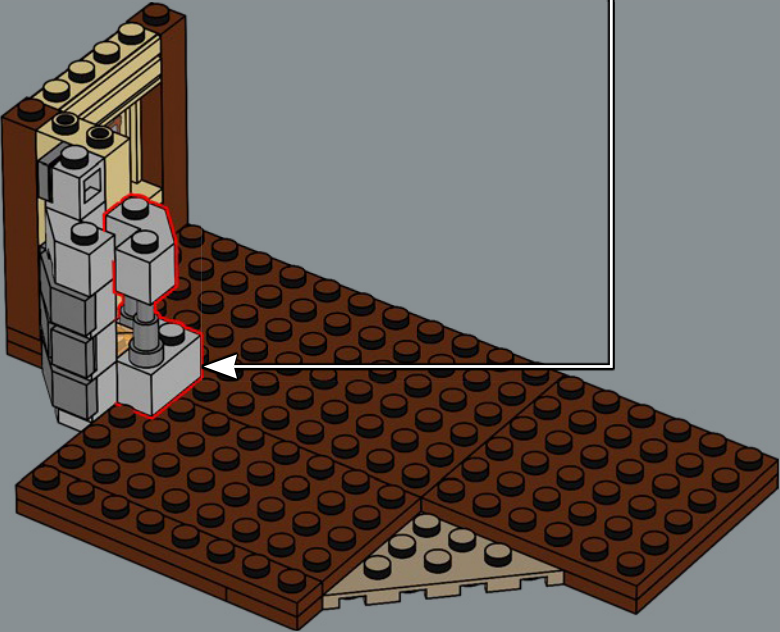
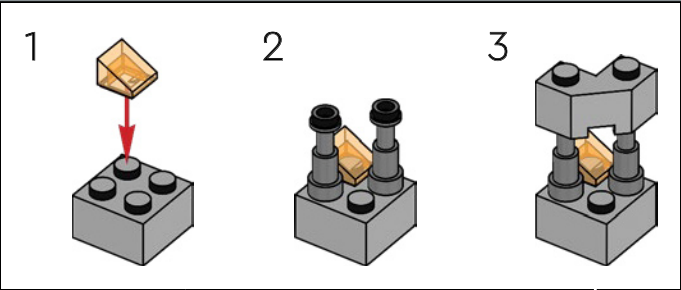

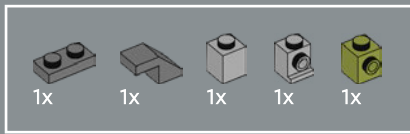

52

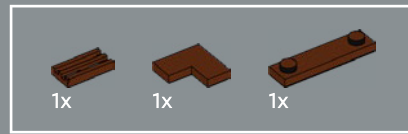
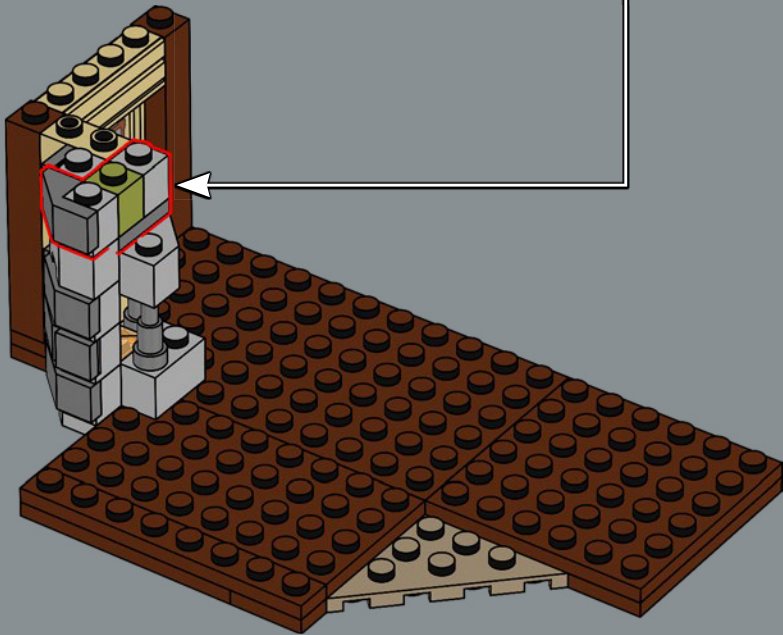
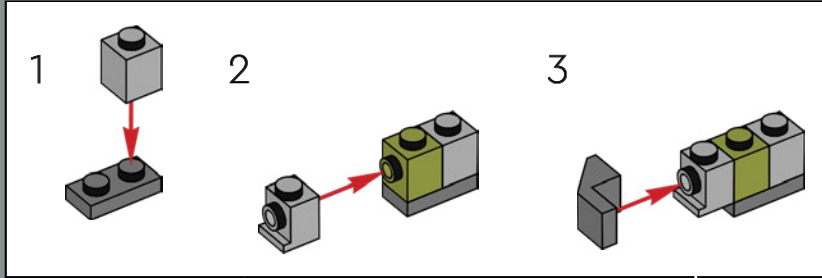

53

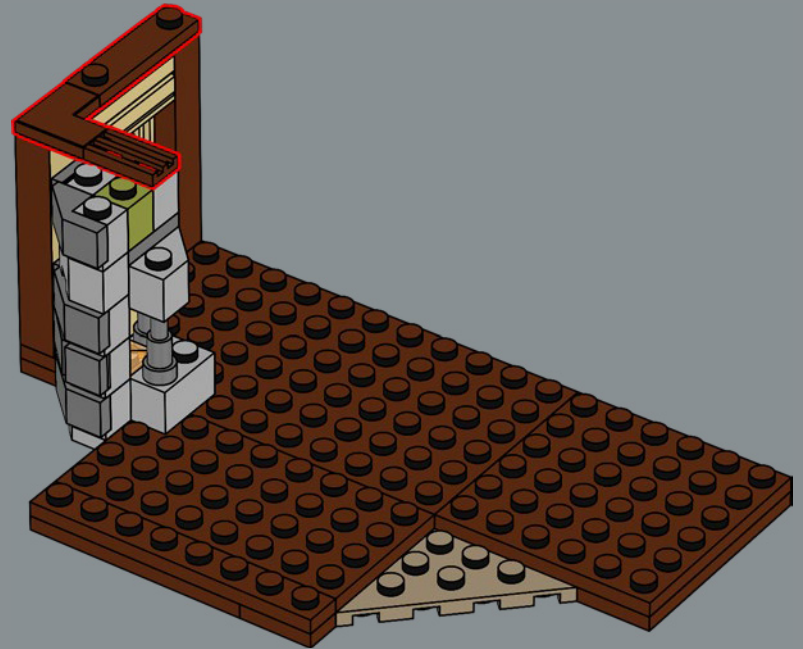

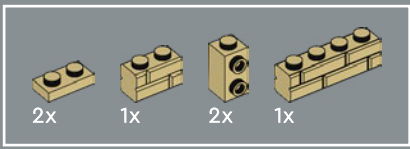

54

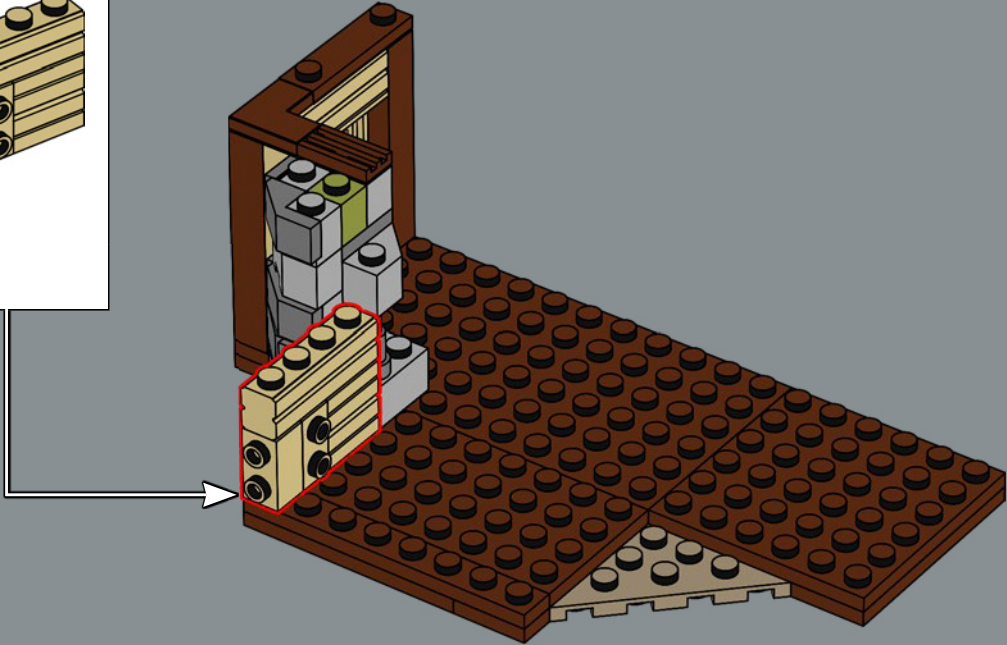
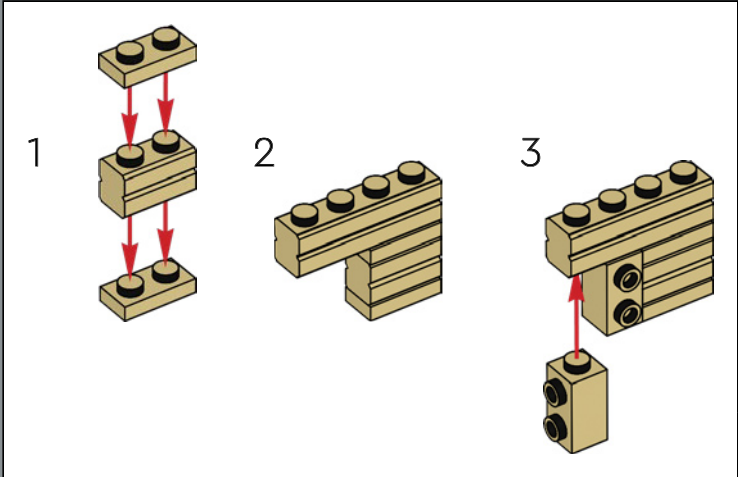

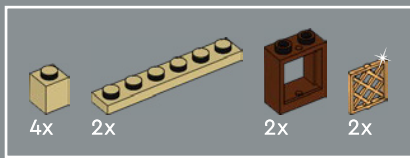

55

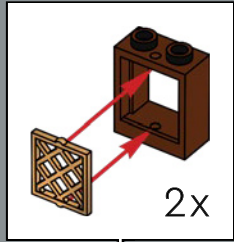

1

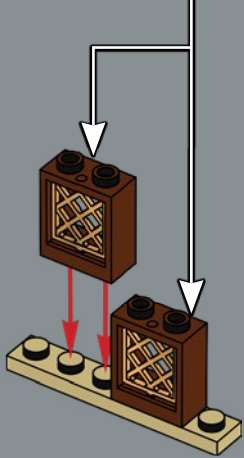

2

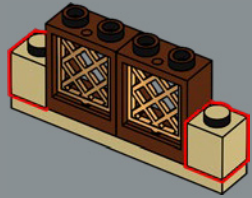

3

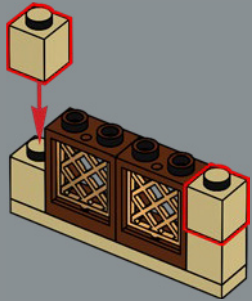

4

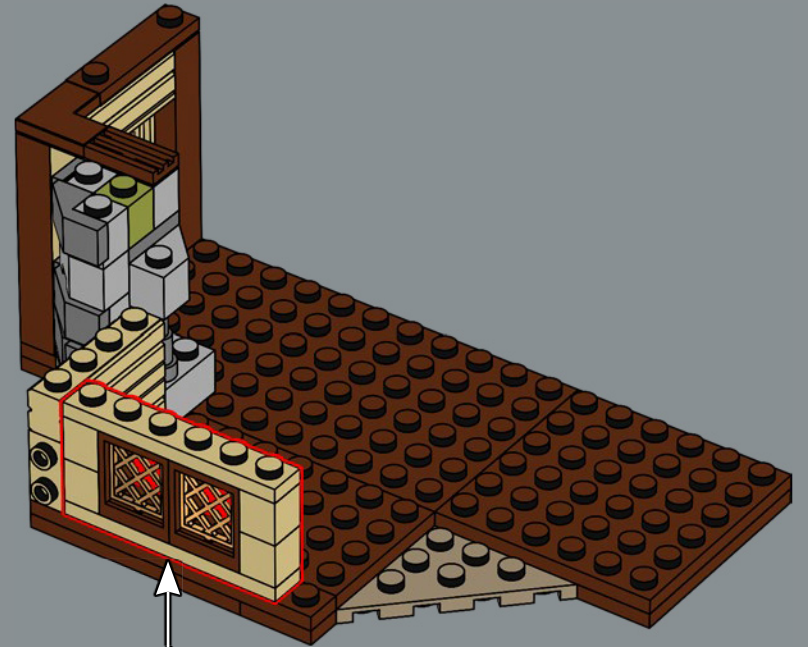
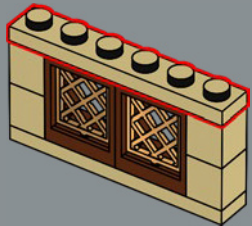



56

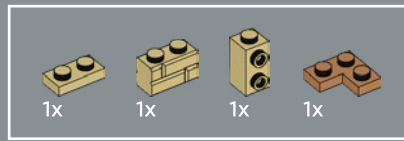
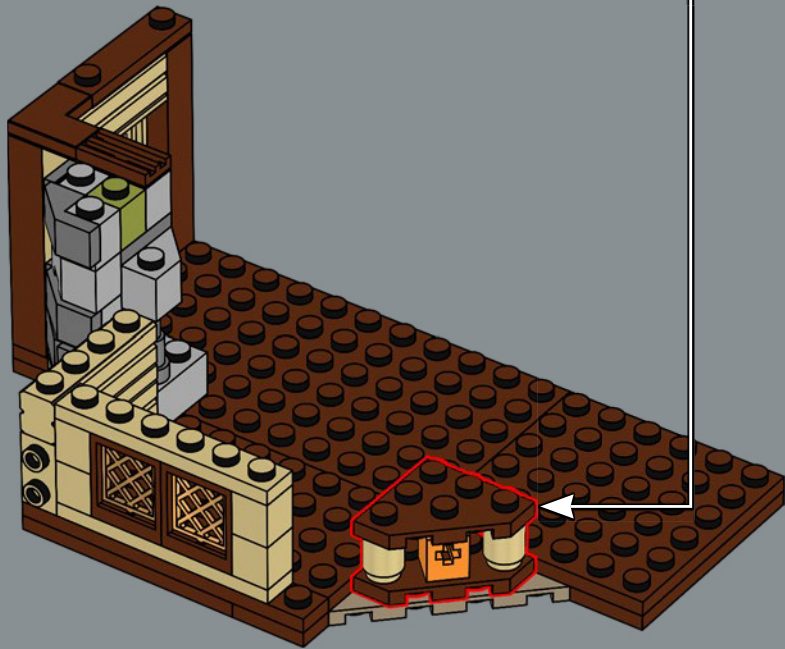
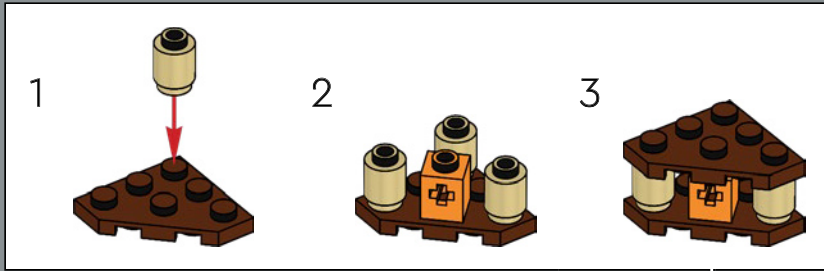

57

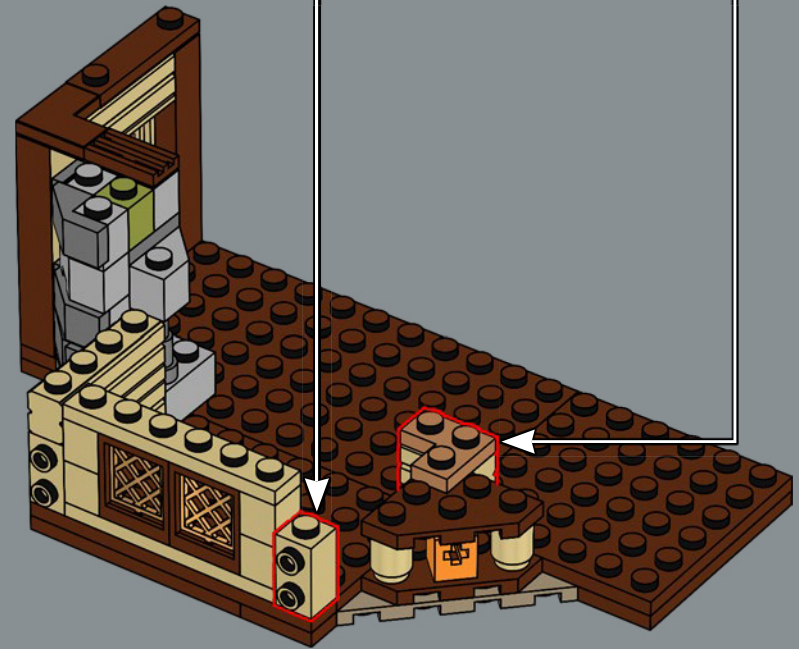
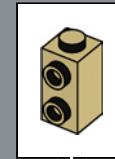
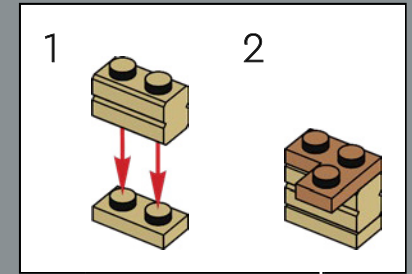

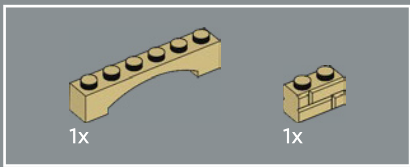

58

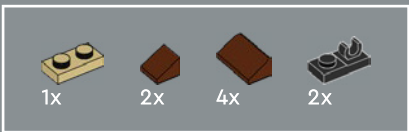
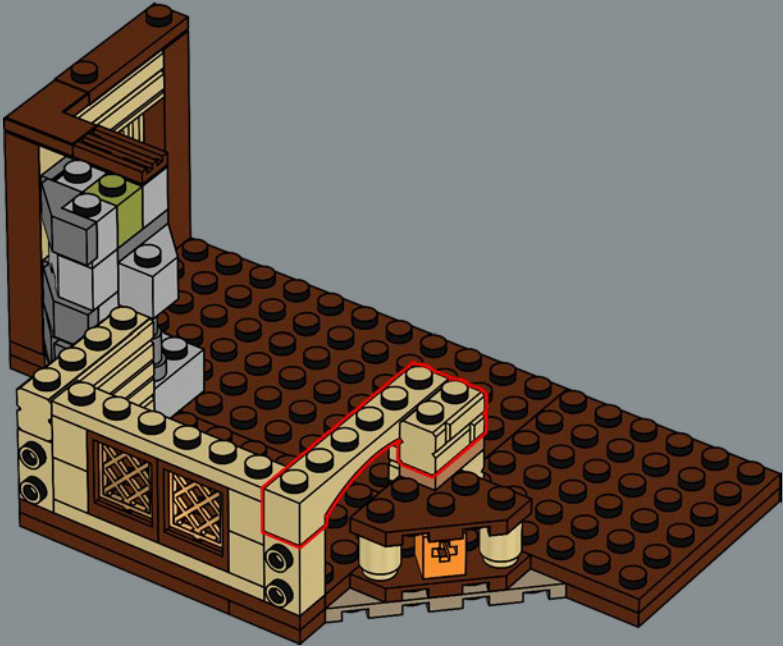

59

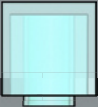
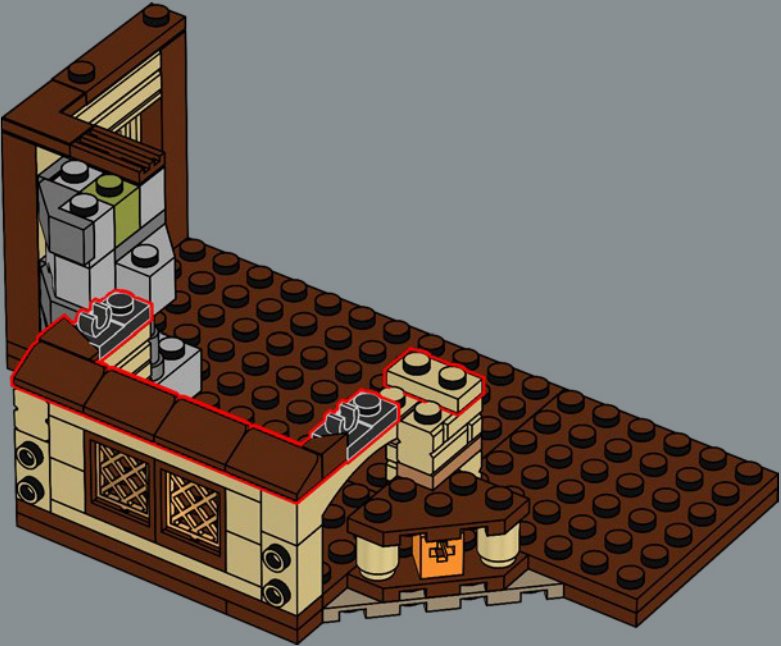

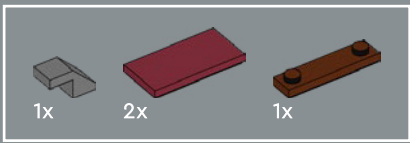

60

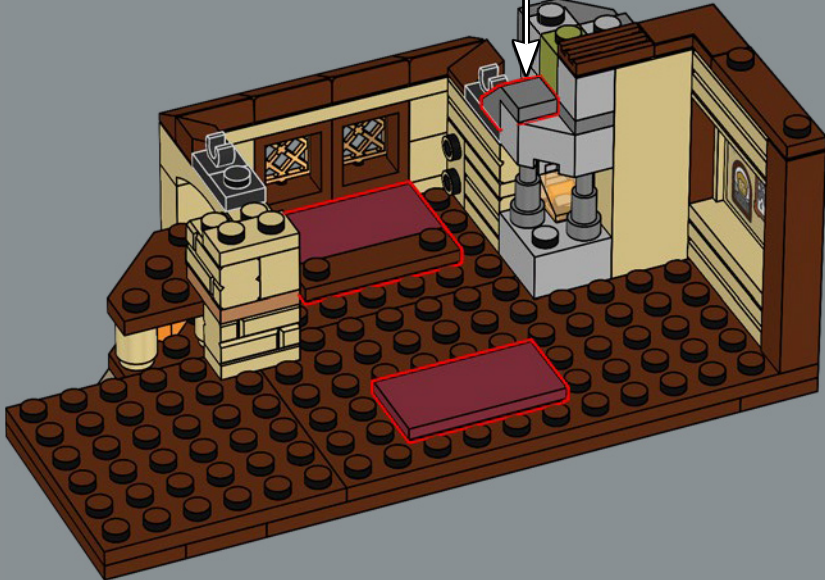
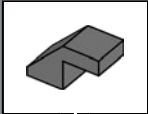

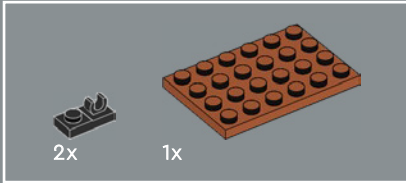
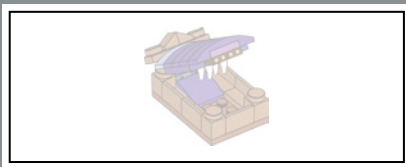

61

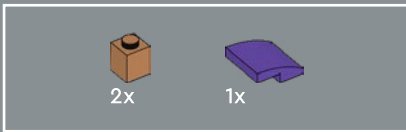
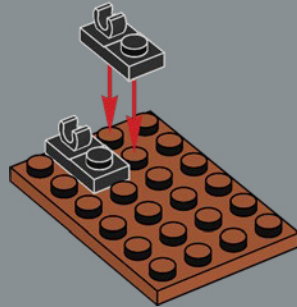

62

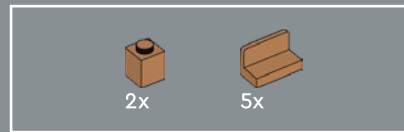
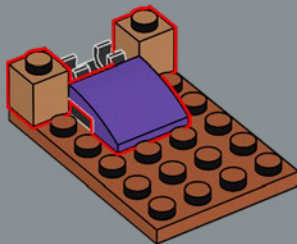

63

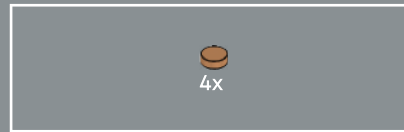
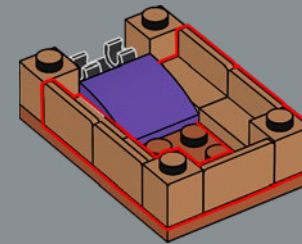

64

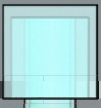
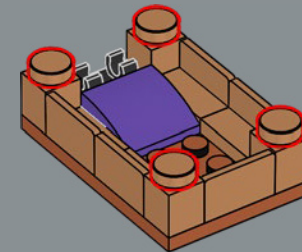

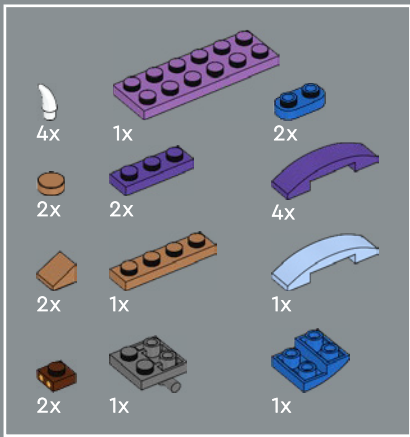
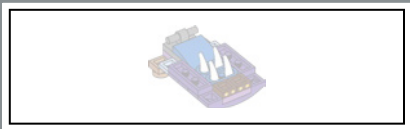

65

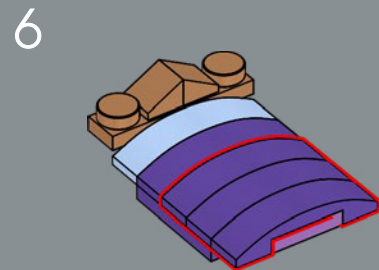
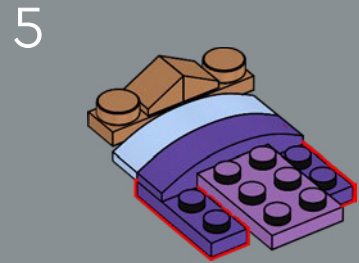
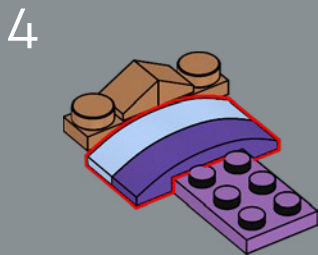
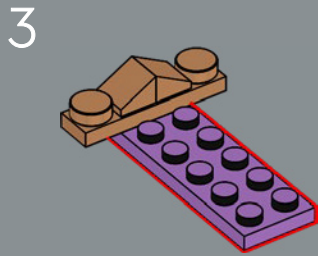
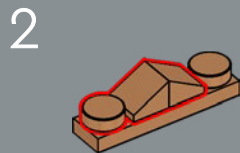
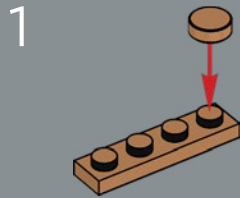

7

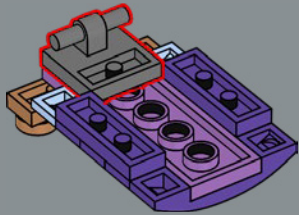

8

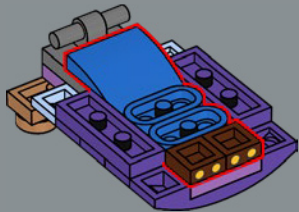

9

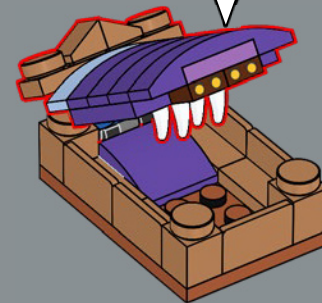
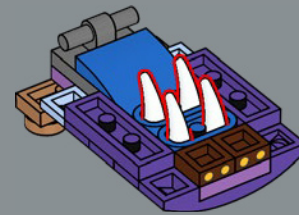

66





1

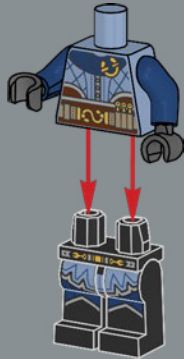

2

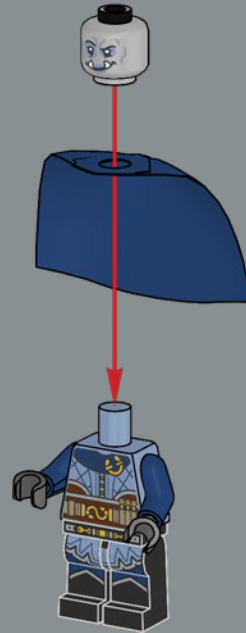

3



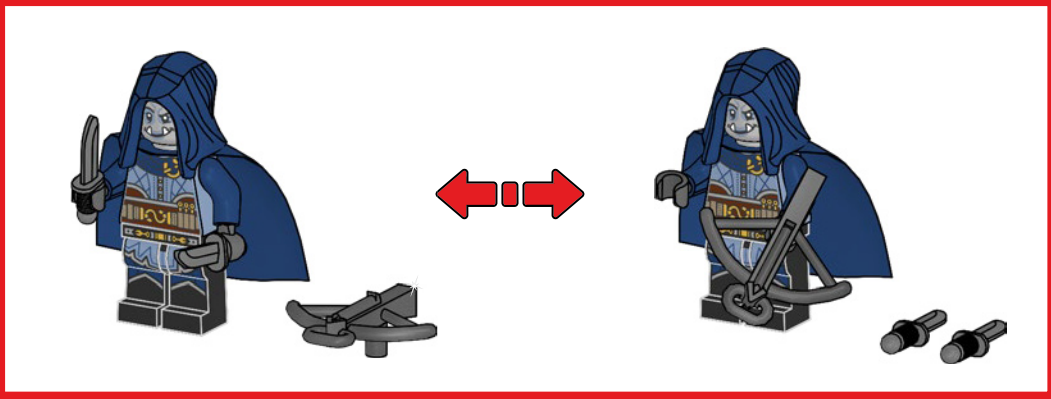
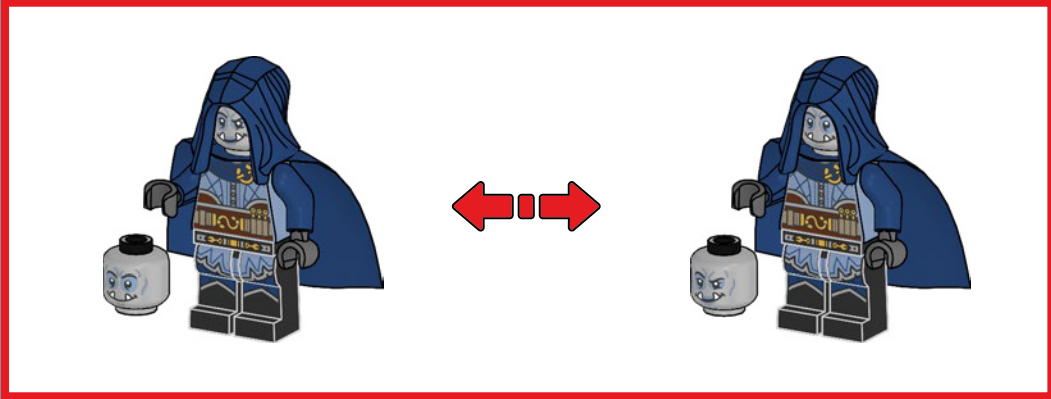

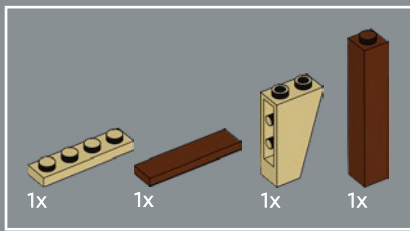

67



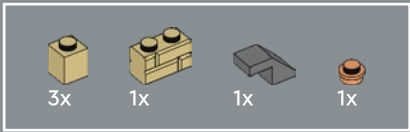

68

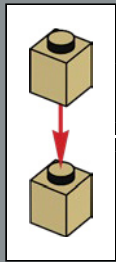
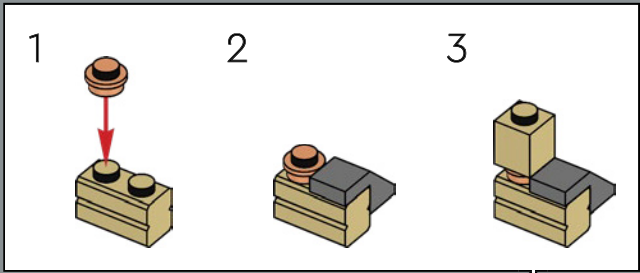

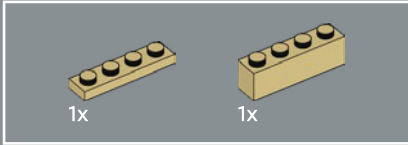

69

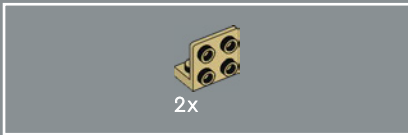
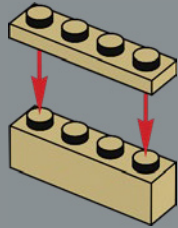

70

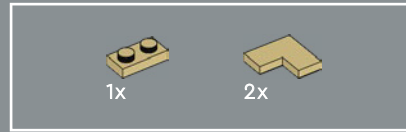
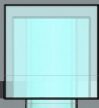
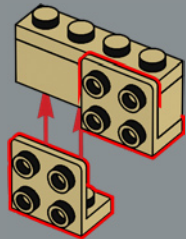

71

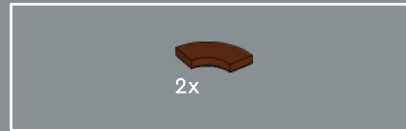
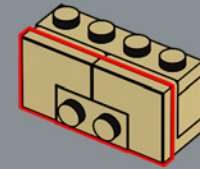

72

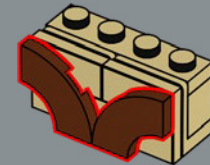



73

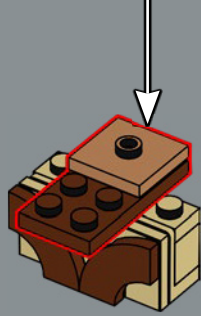
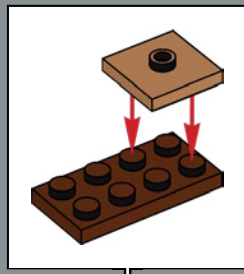

74

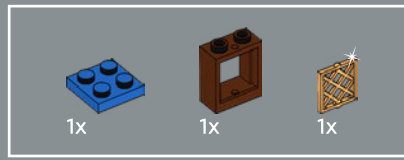
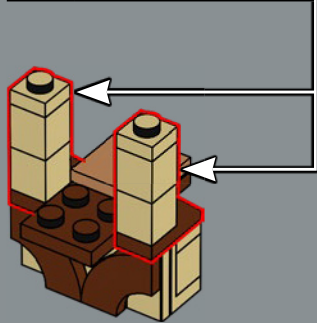
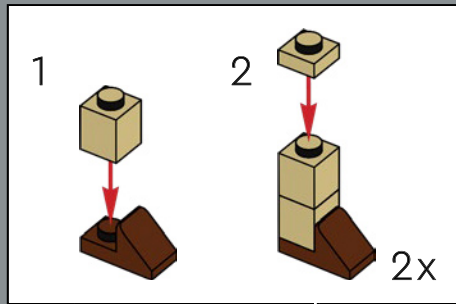

75

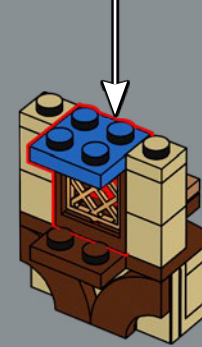
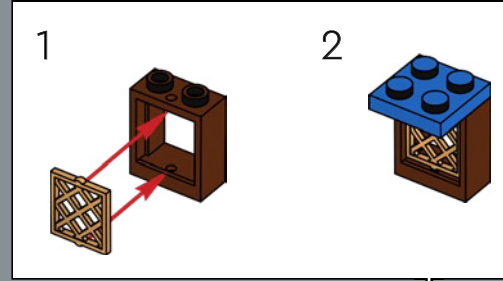



76

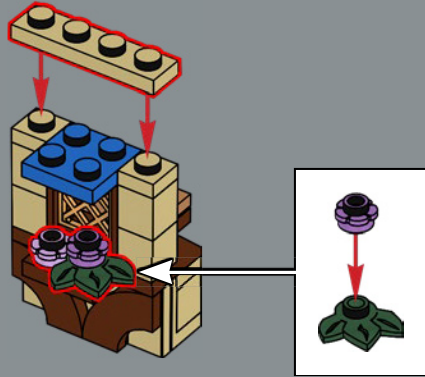

77



78

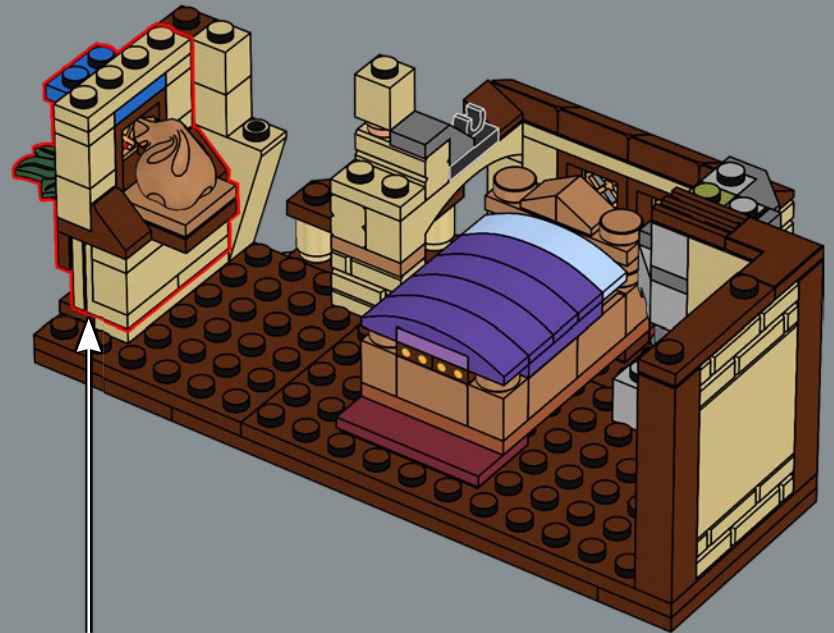

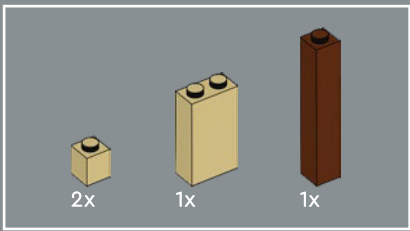

79

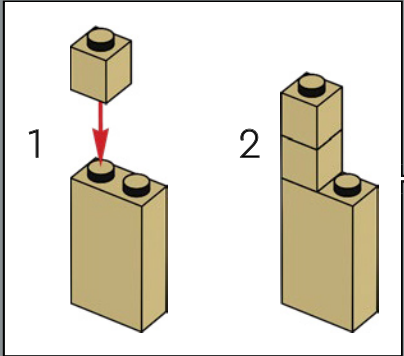
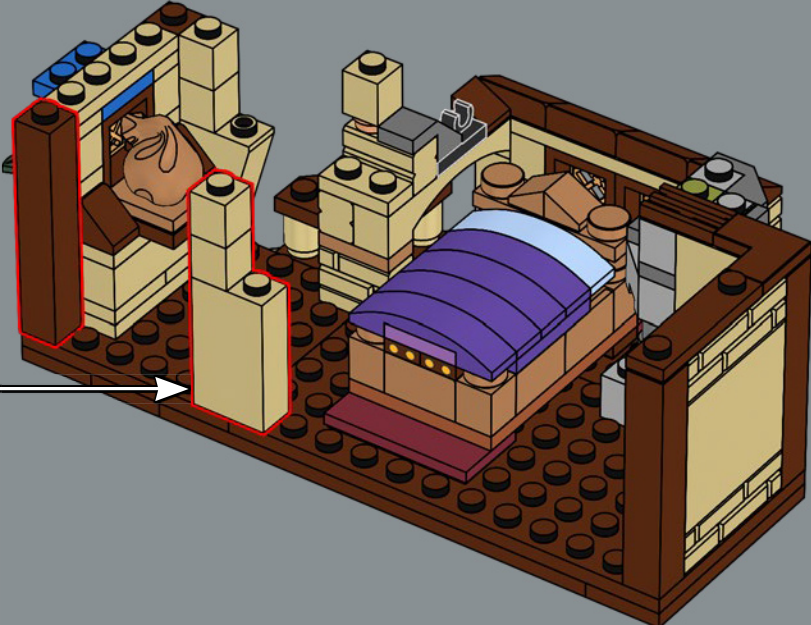

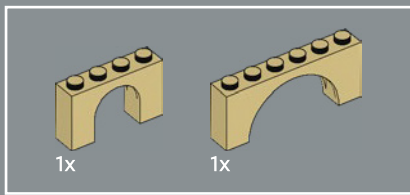

80

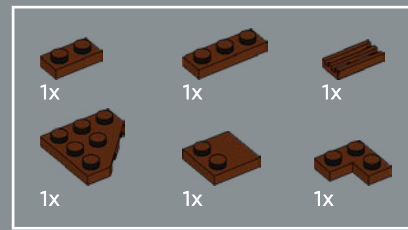
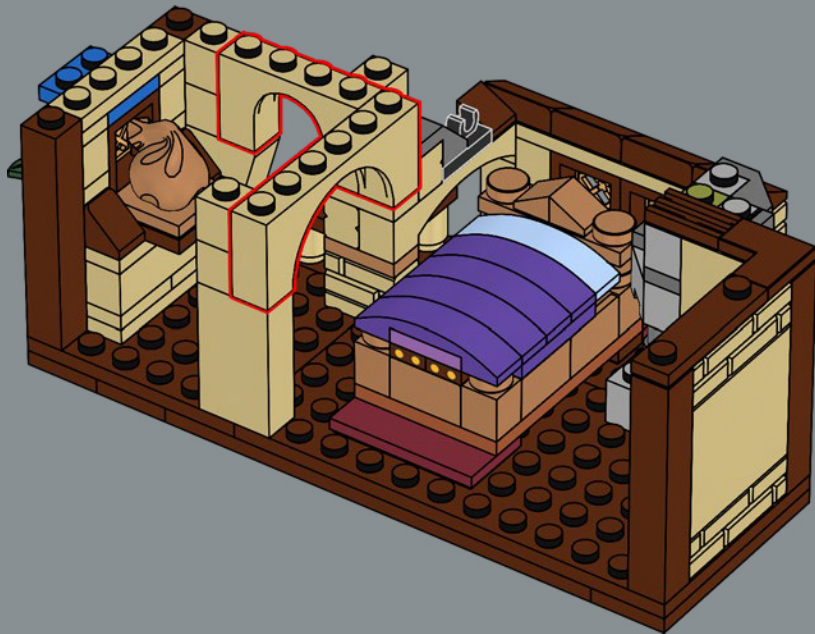

81



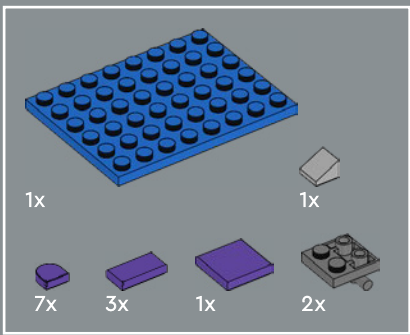

82

1

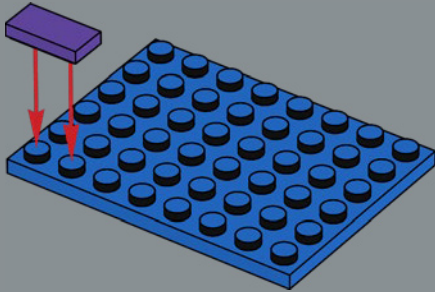

2

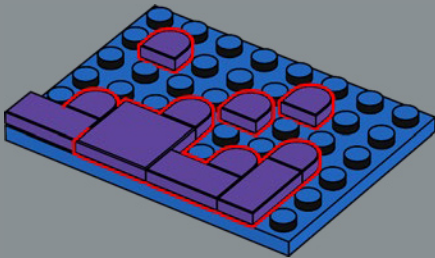

3

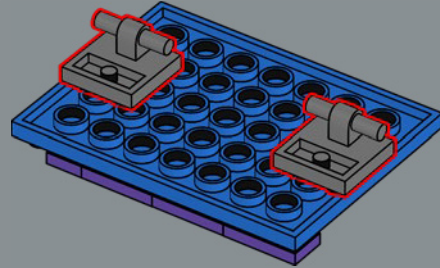

4

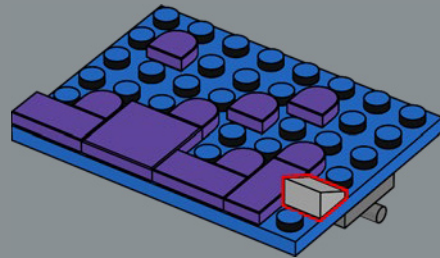

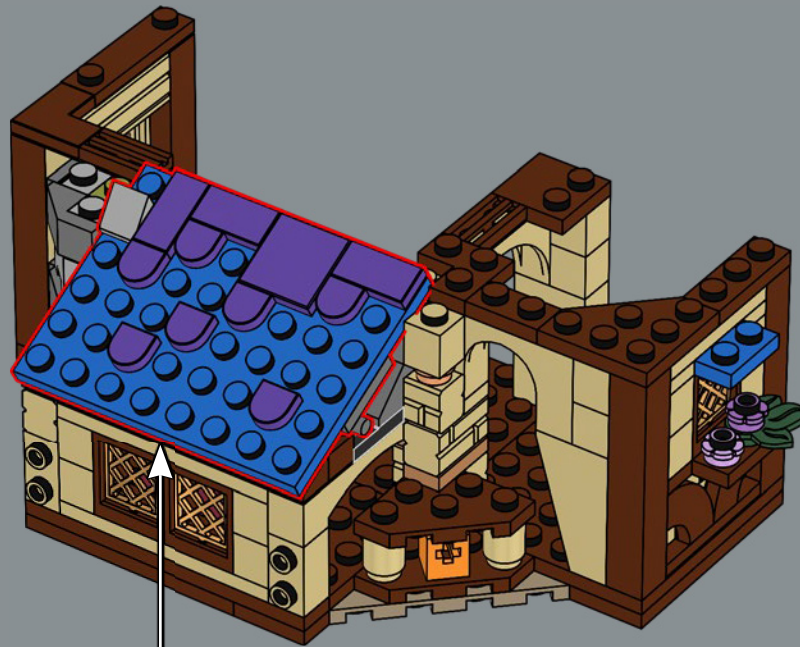

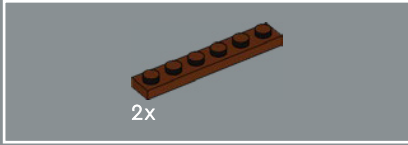
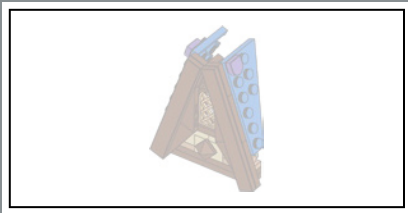

83

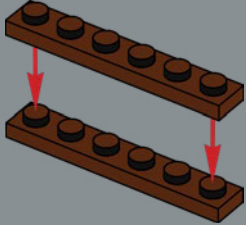

84

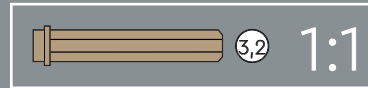
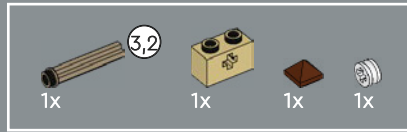
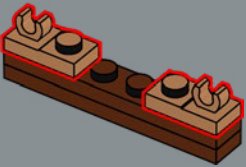

85

1

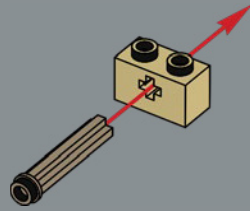

2

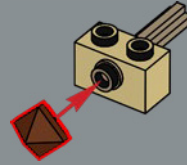

3

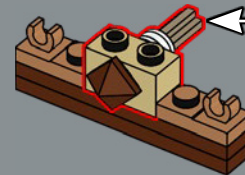
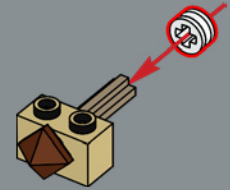



86

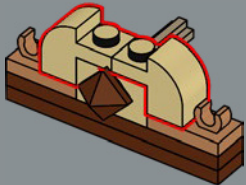

87

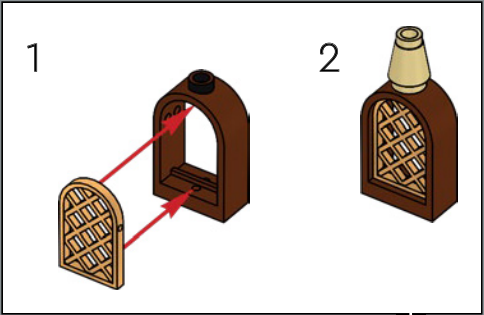

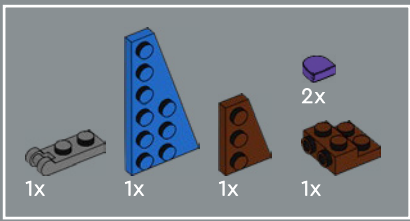

88

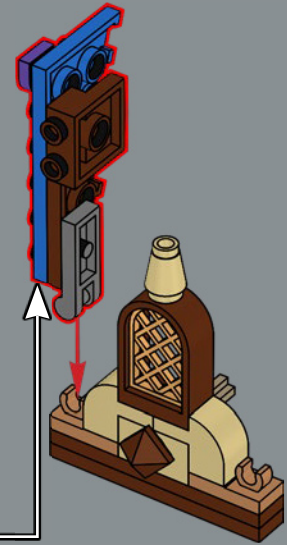
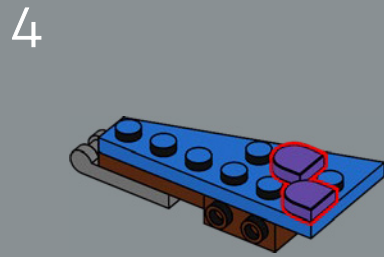
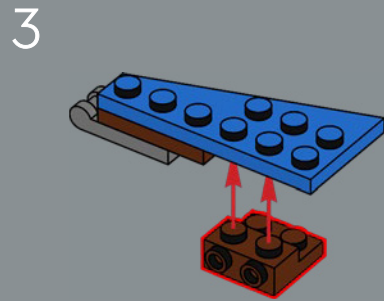
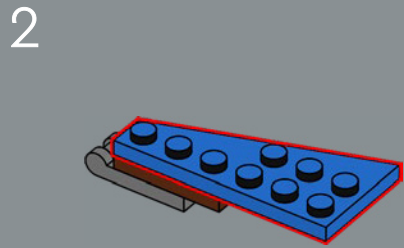
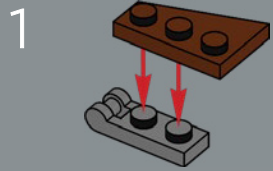

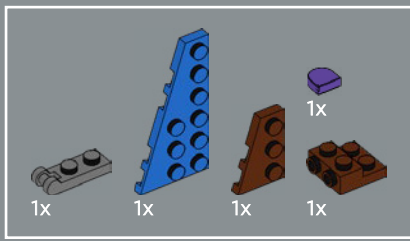

89

1

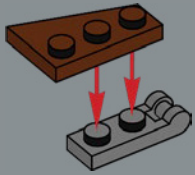

2

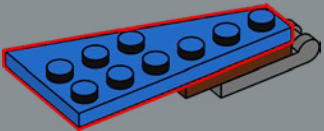

3

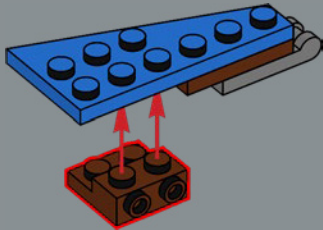

4

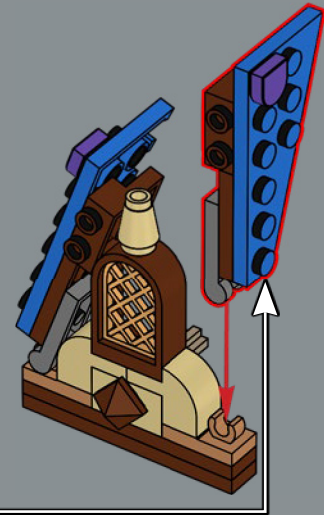
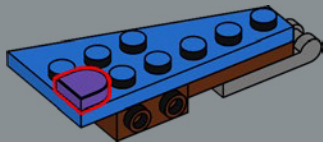

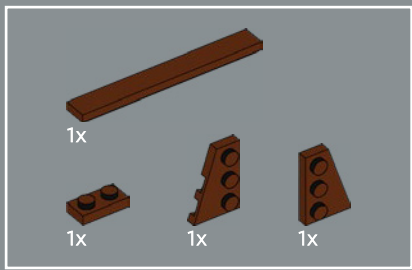

90

1

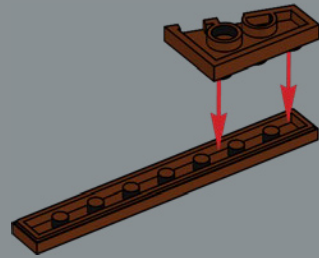

2

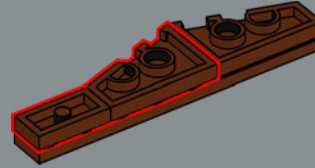

3

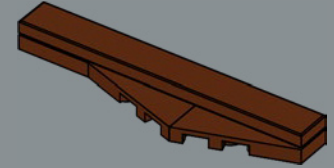

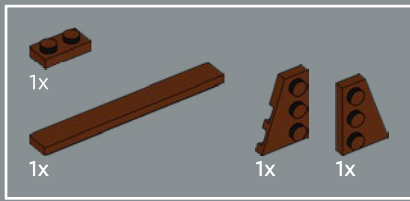

91

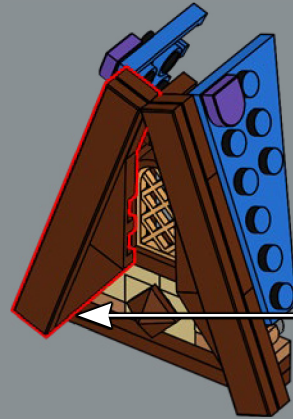
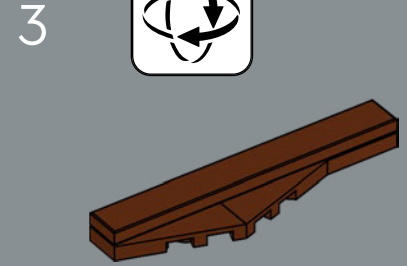
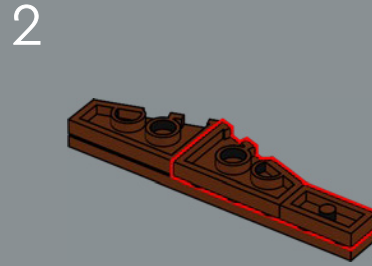
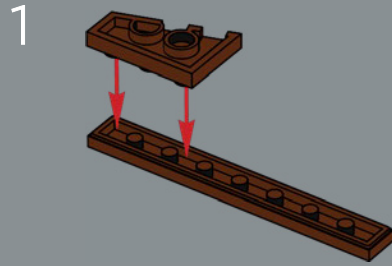

92

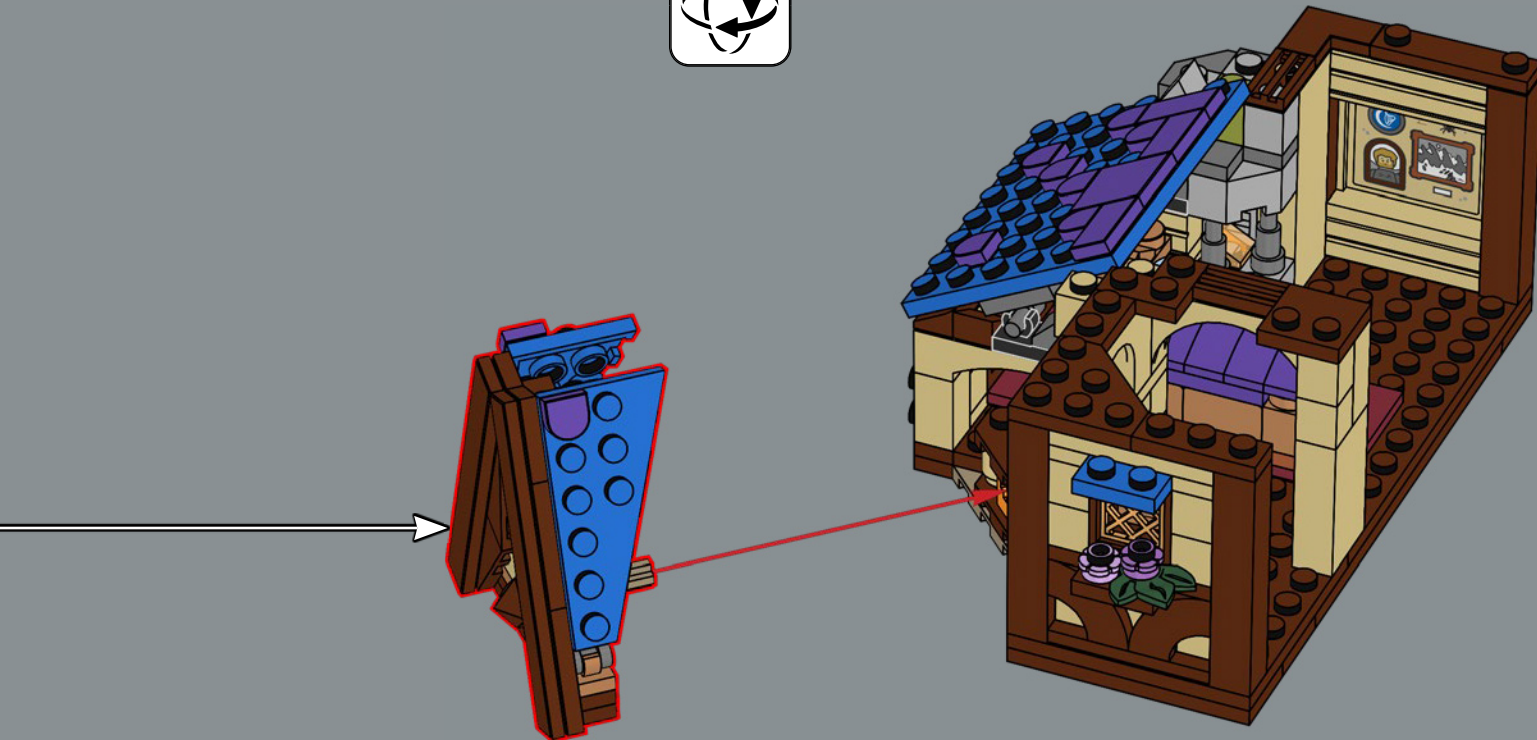



93

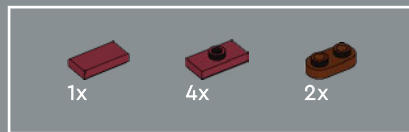
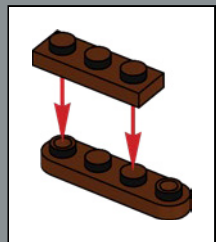

94



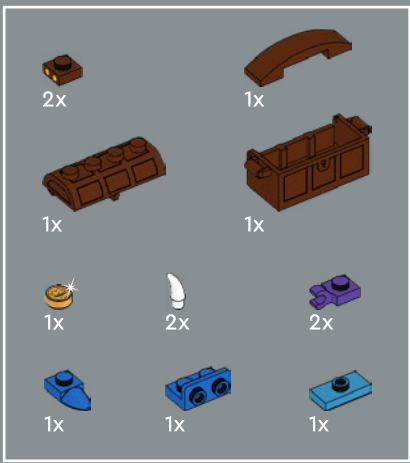

95

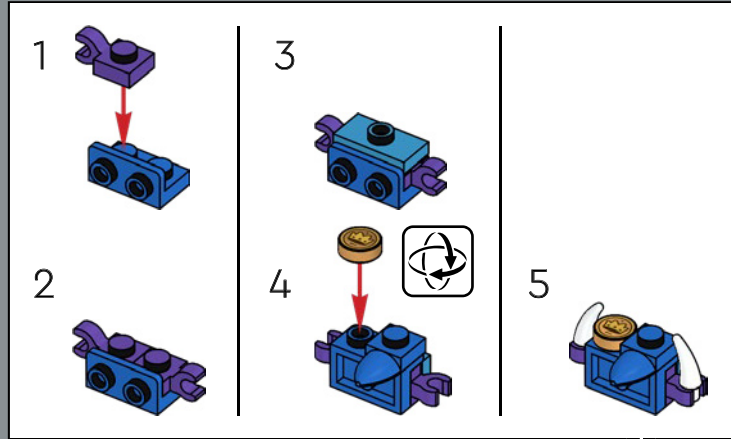
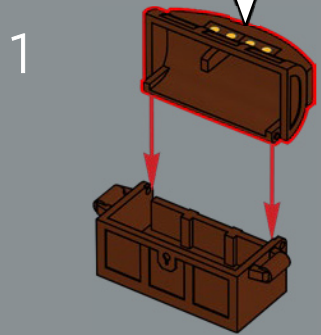
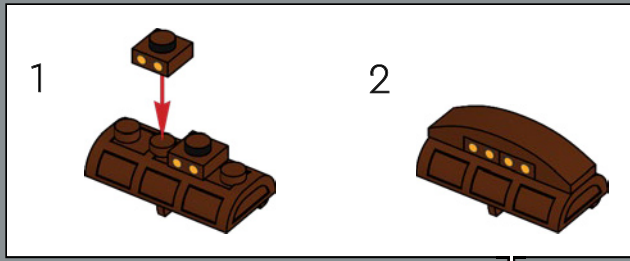

2



96





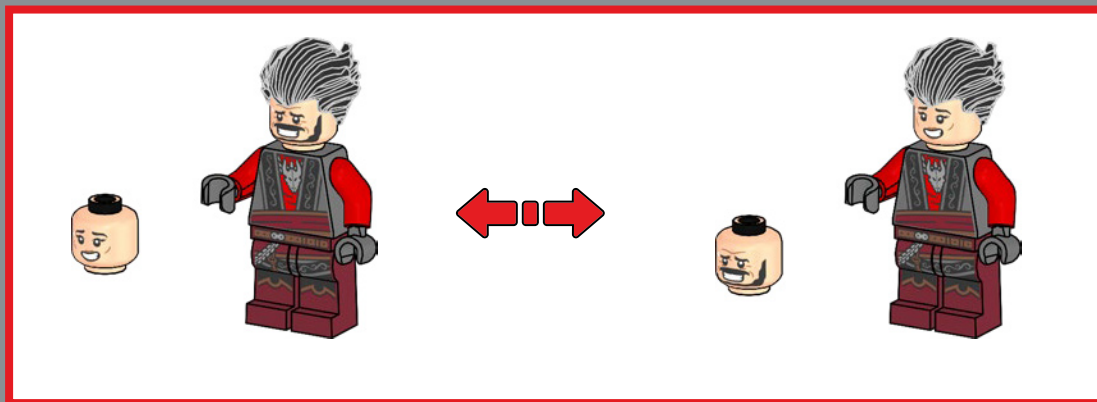
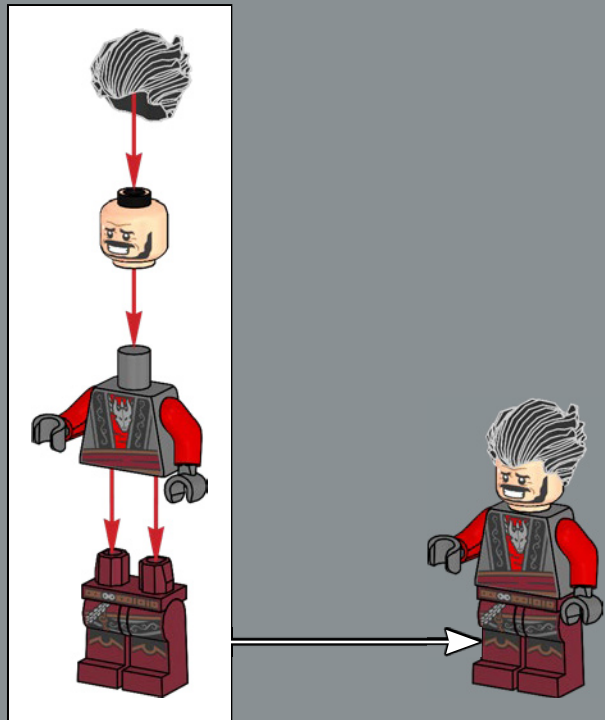

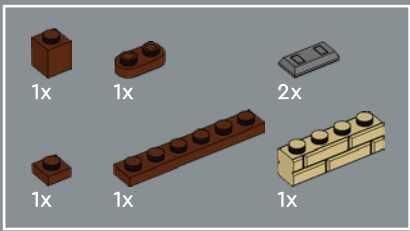

97

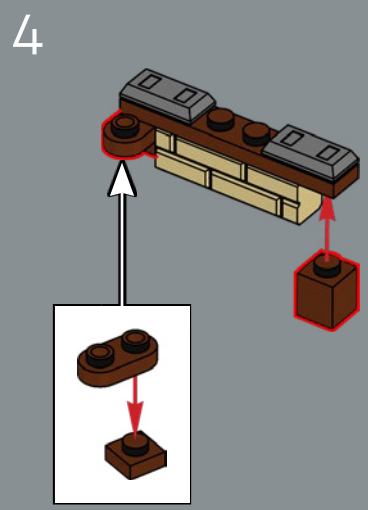
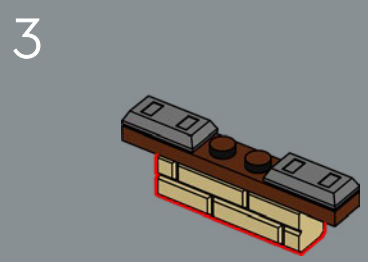
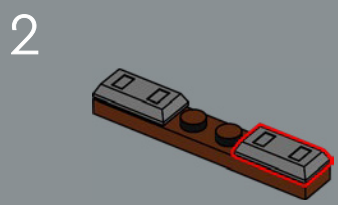
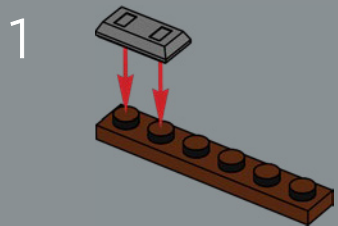

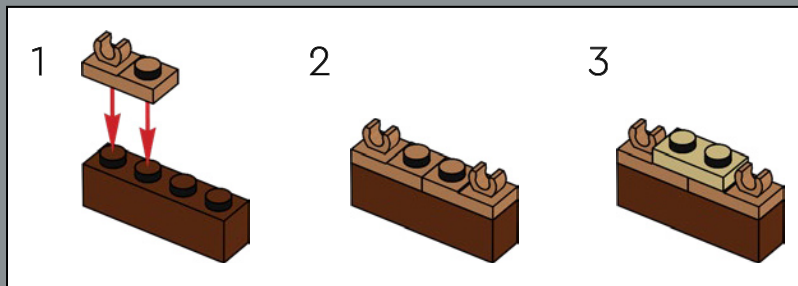
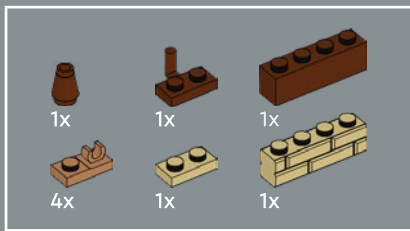

98

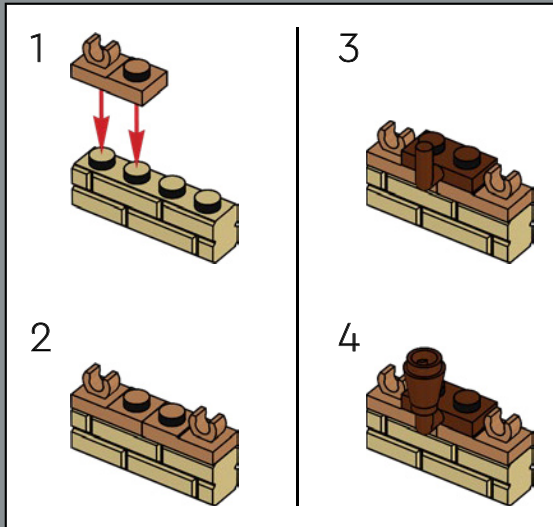

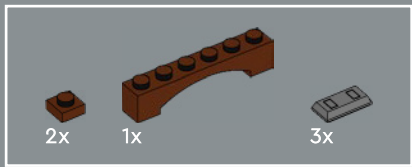

99

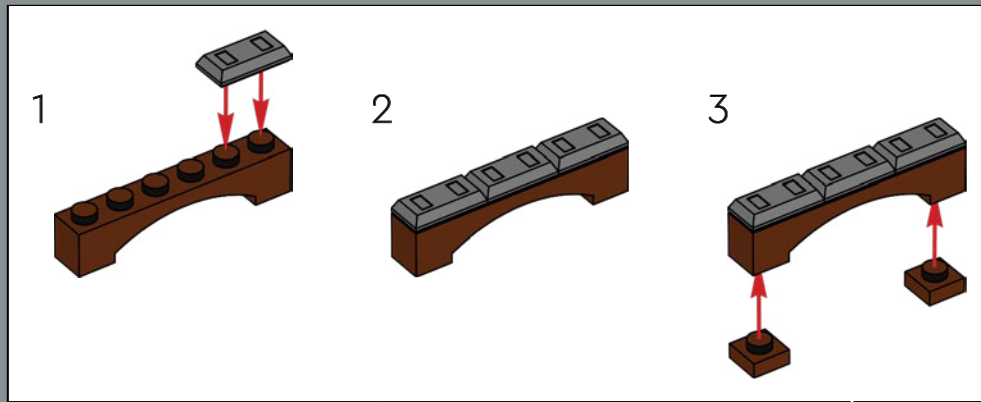

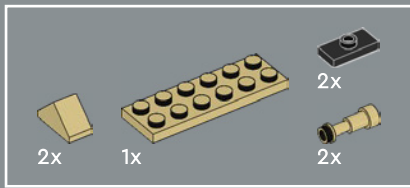

100

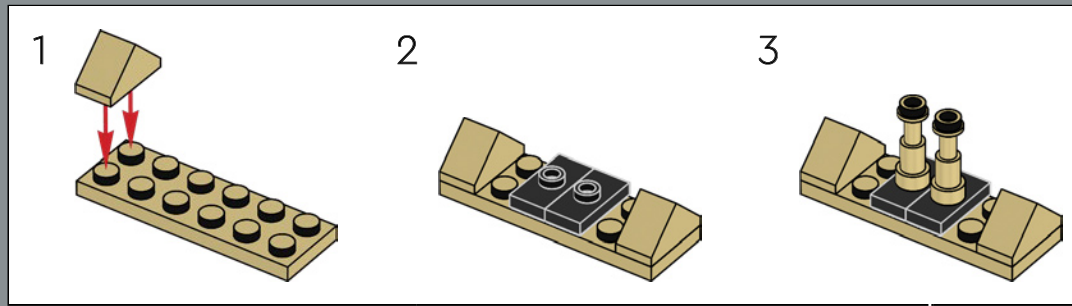

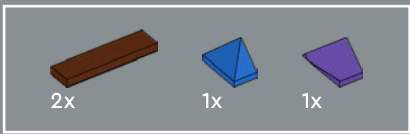

101

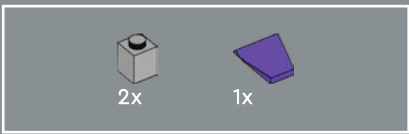
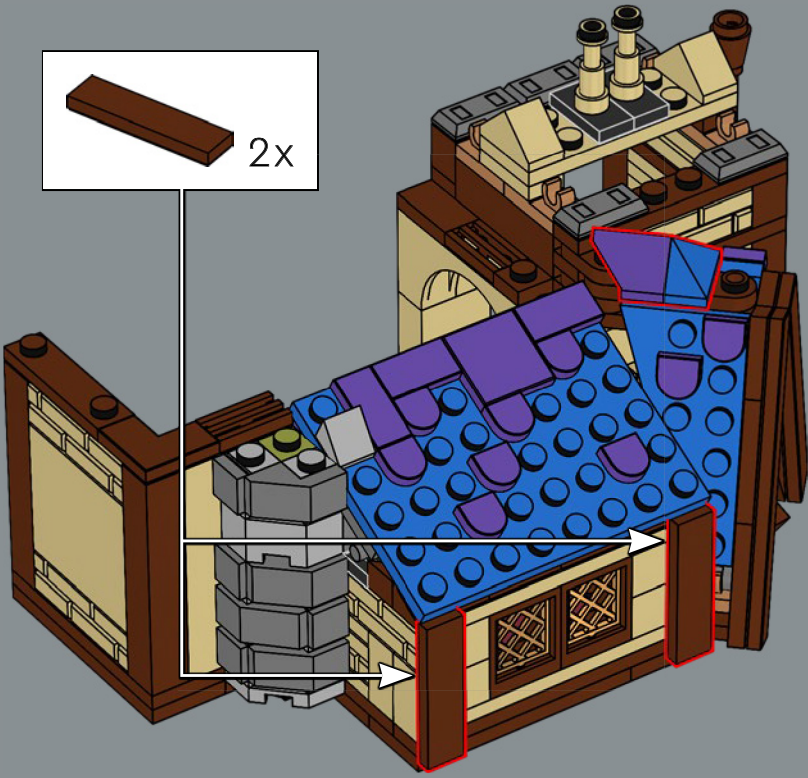
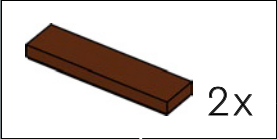

102

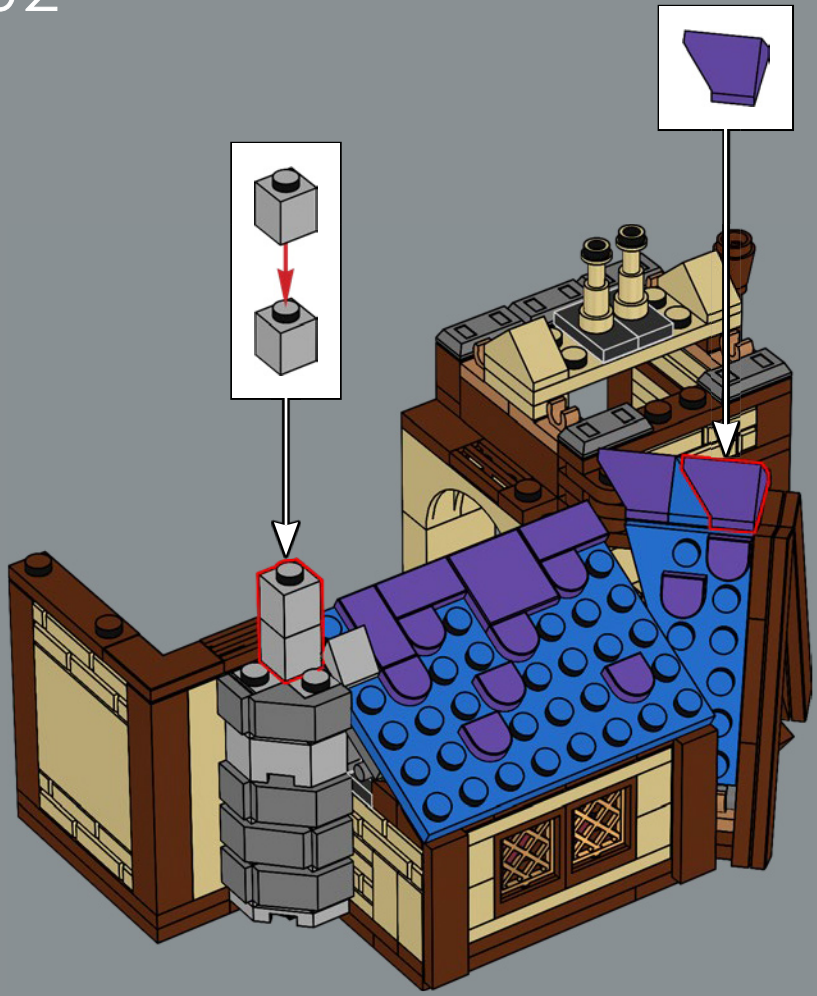
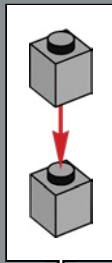

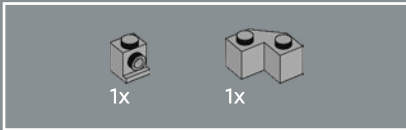

103

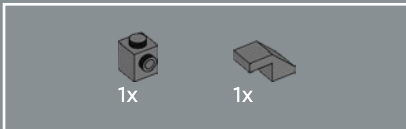
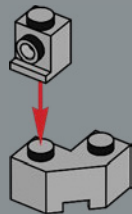

104

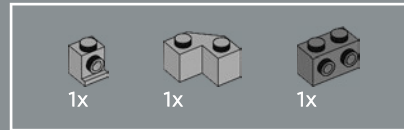
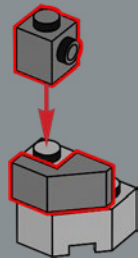

105

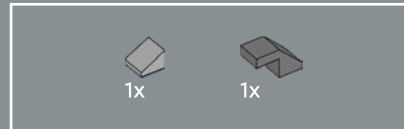
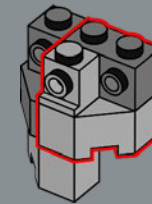
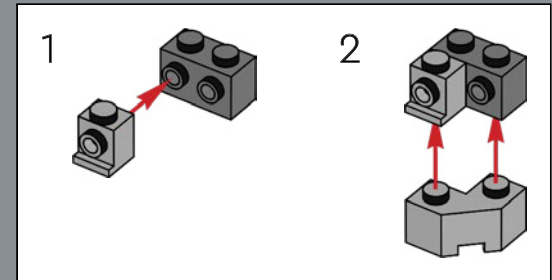

106

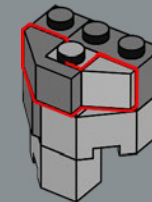



2x

107

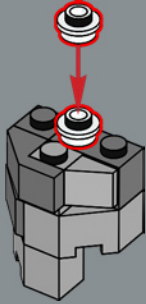

3x

108

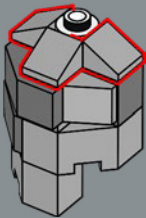

1x

109



1x

110

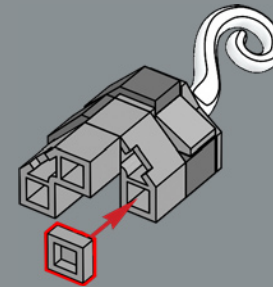

111

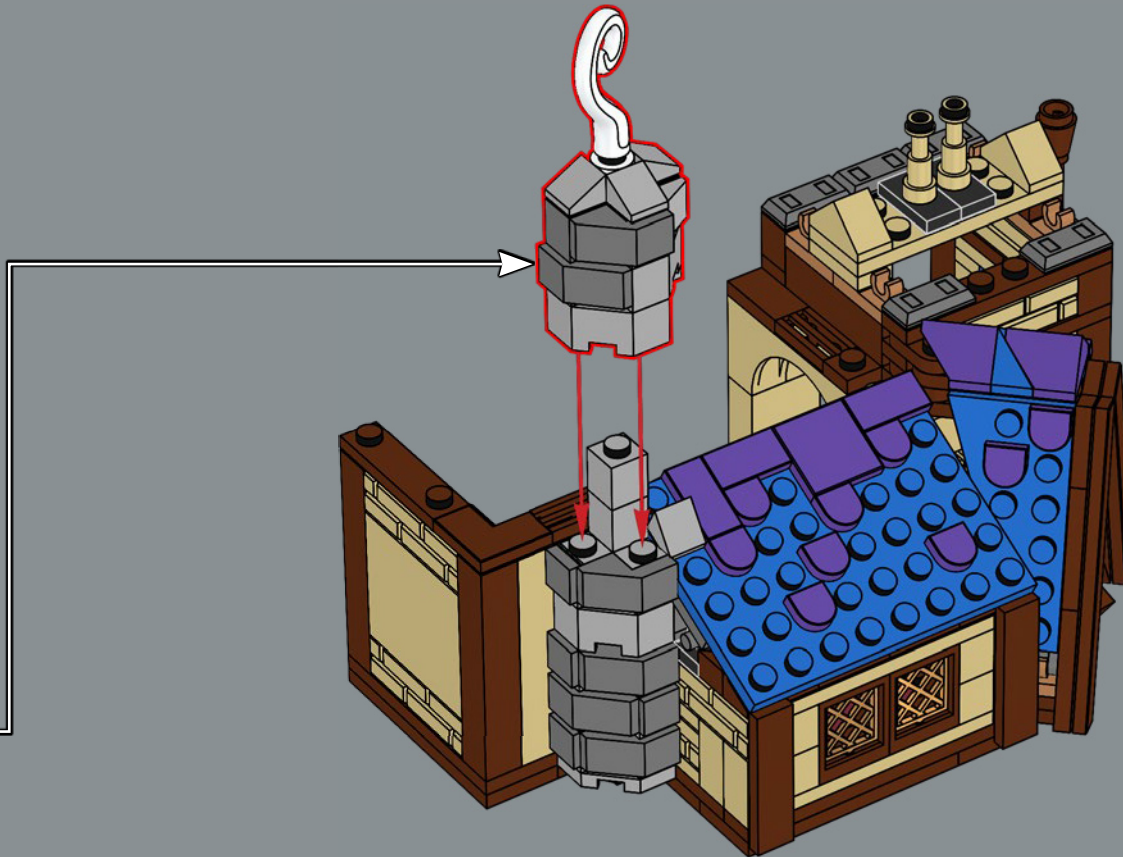

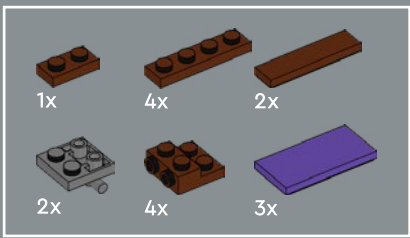

112

1

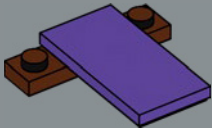

2

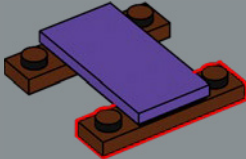

3

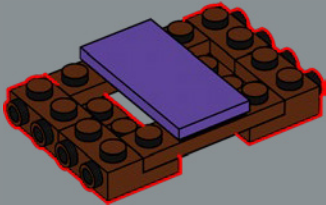

4

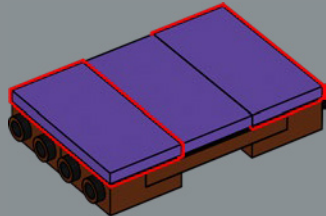

5

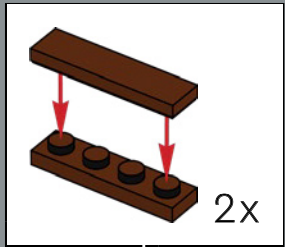
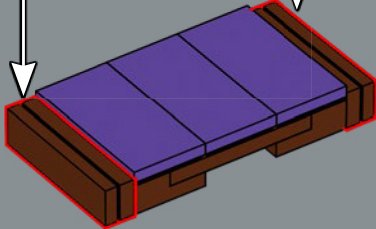

6

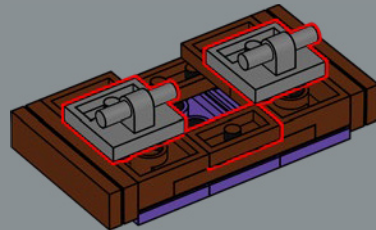

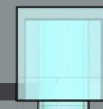

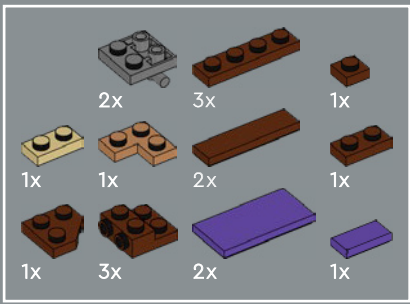

113

1

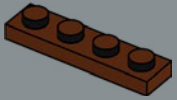

2

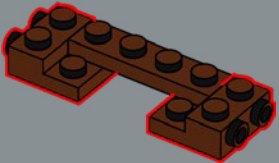

3

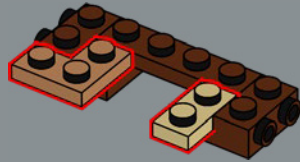

4

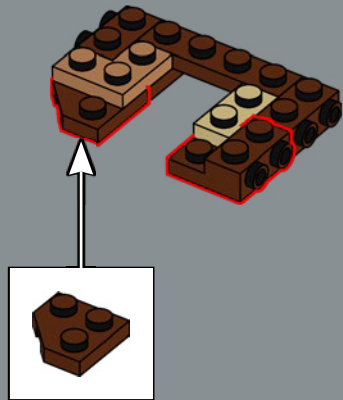

5

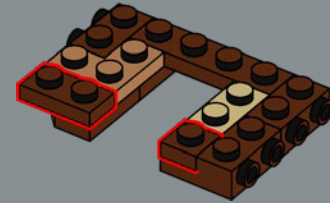

6

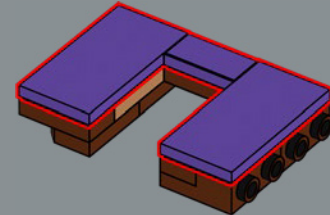

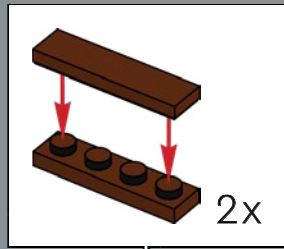

7

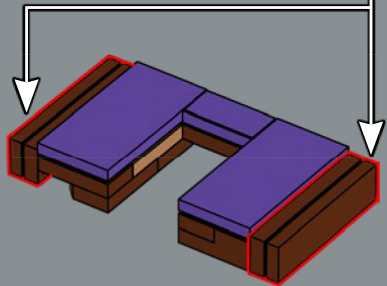

8

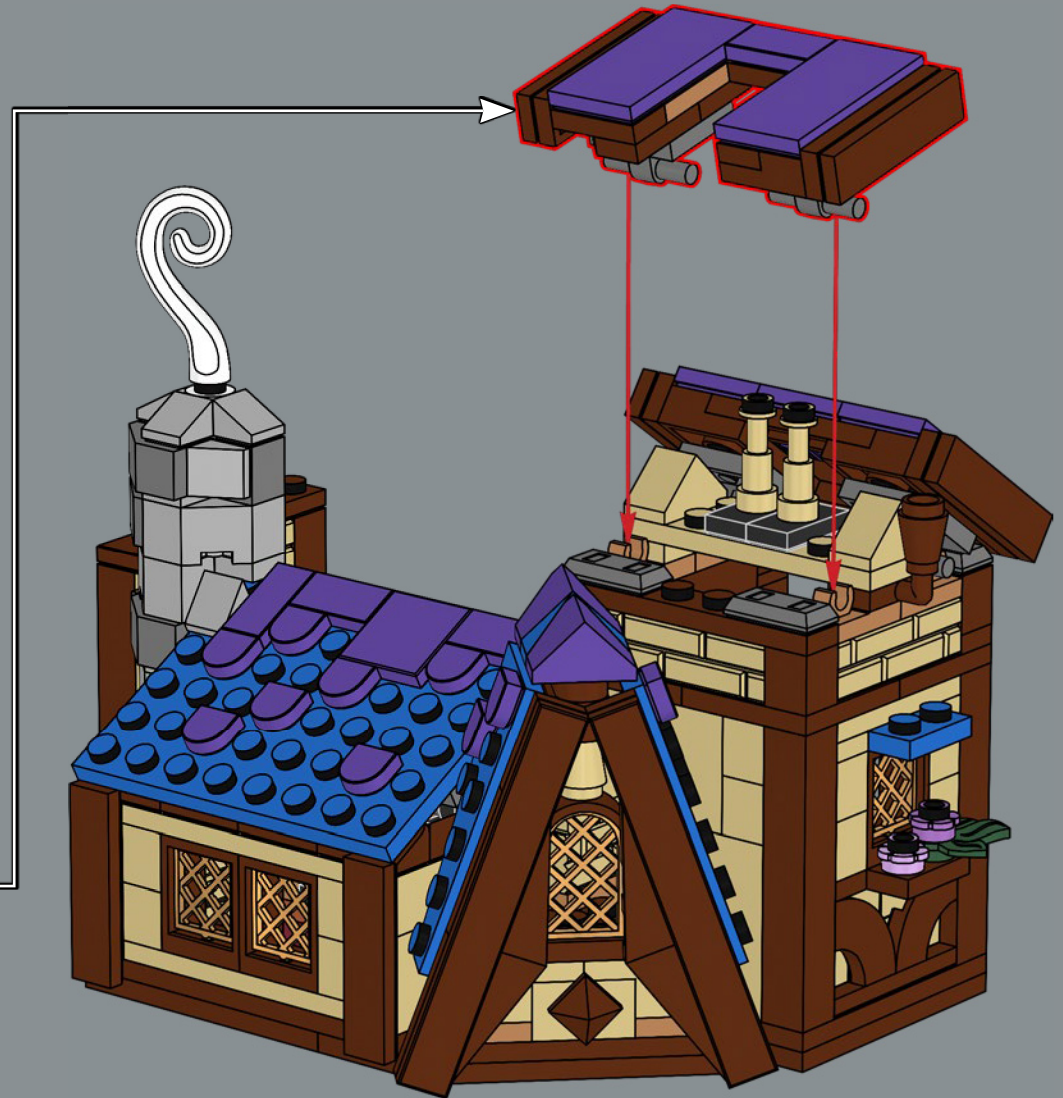
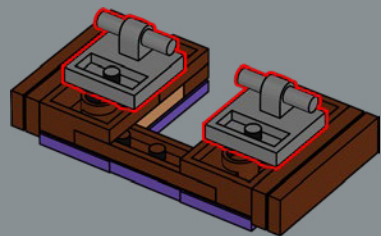

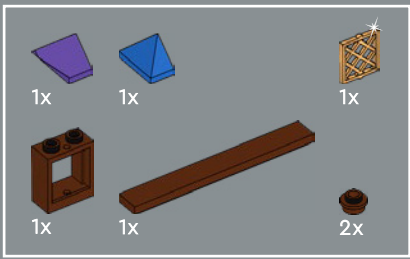

114

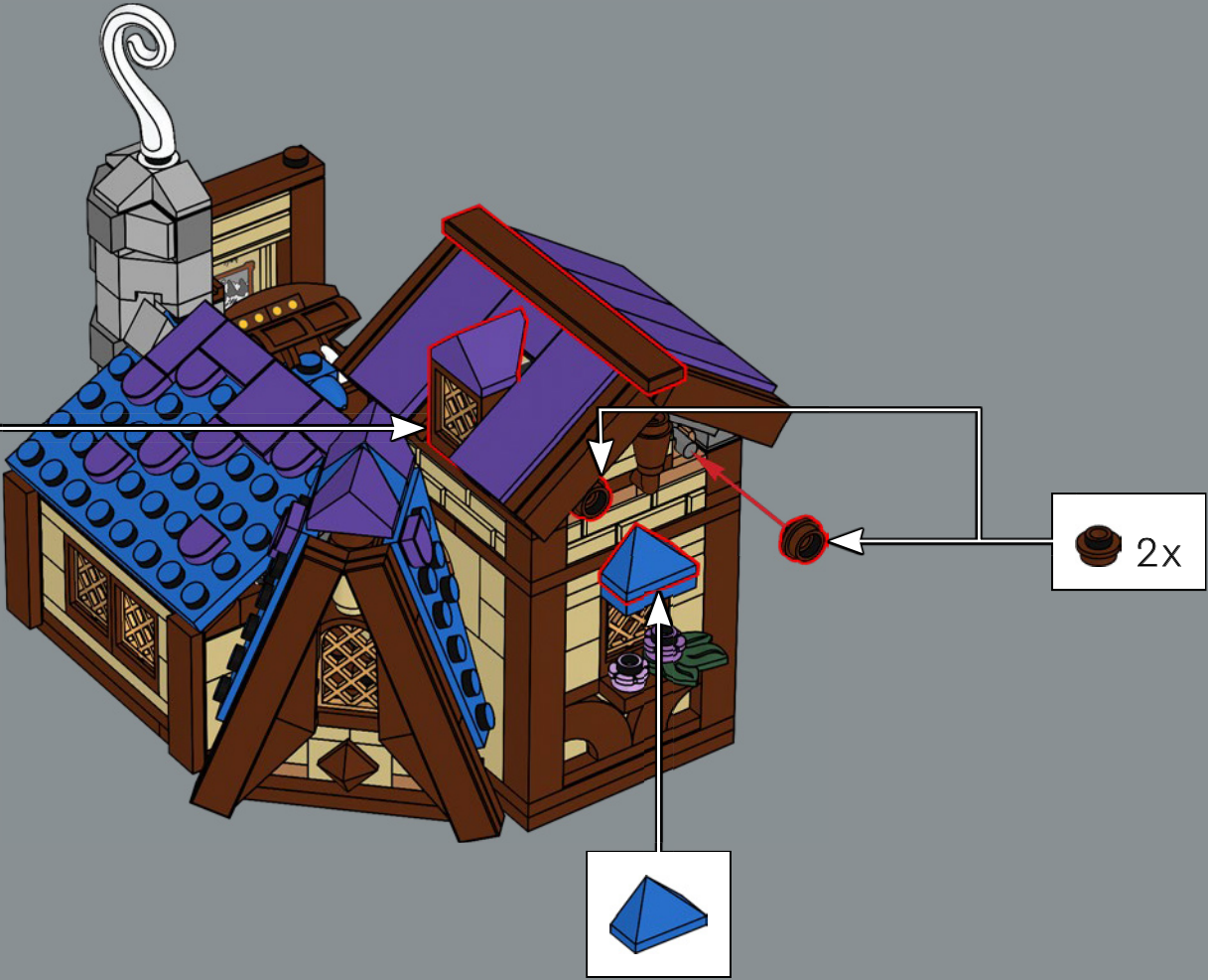
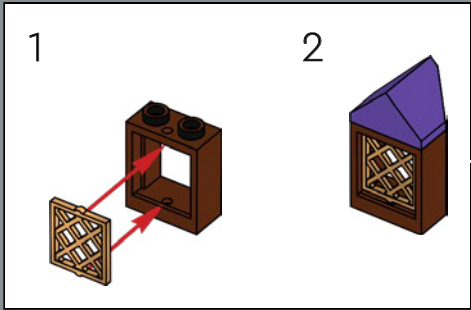

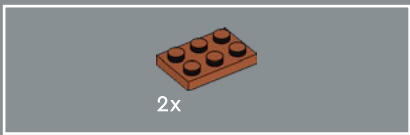

119

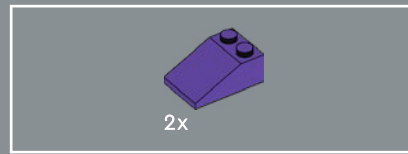
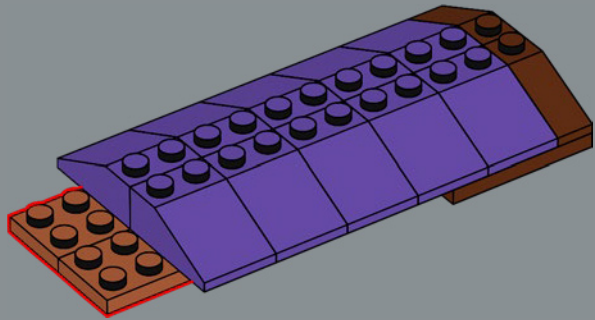

120

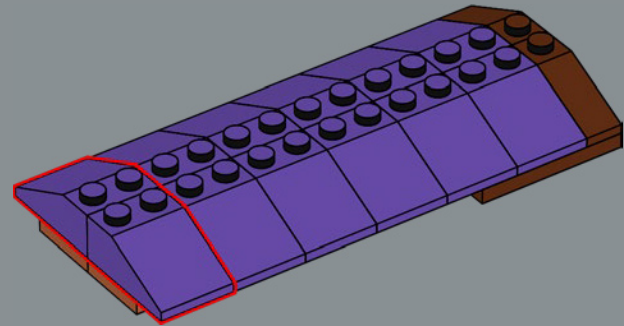

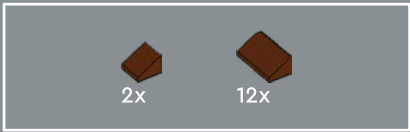

121

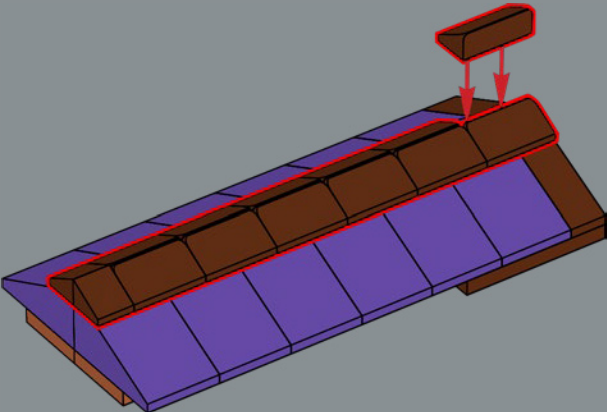

122

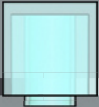
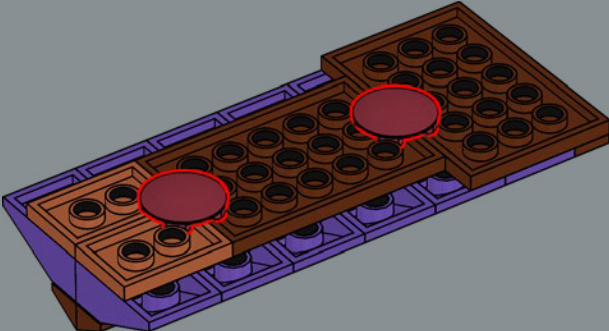

123

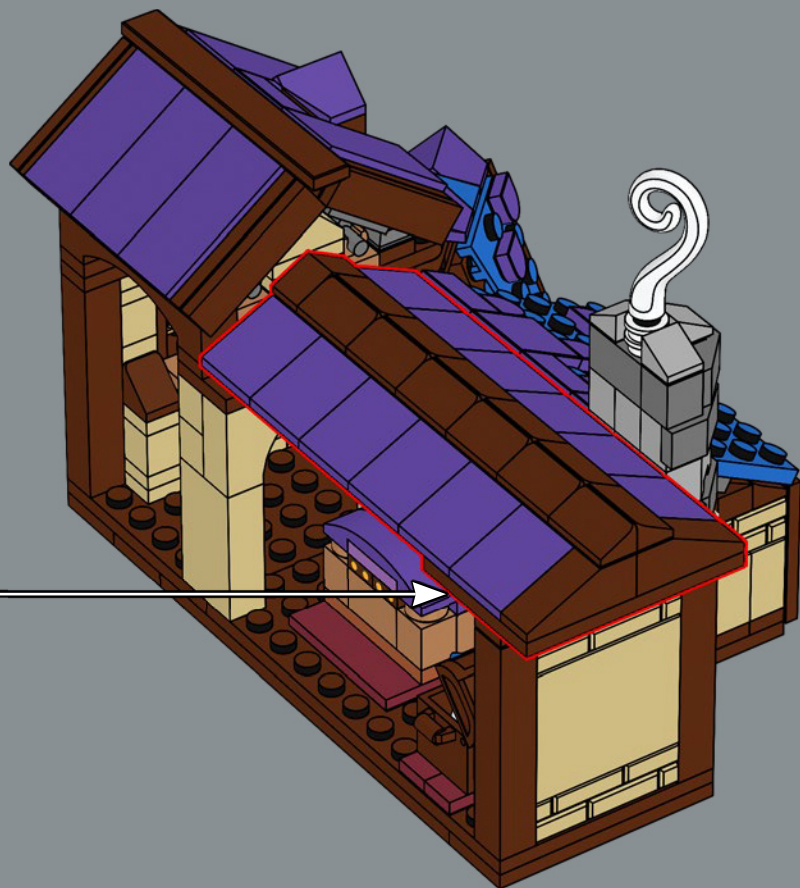

124

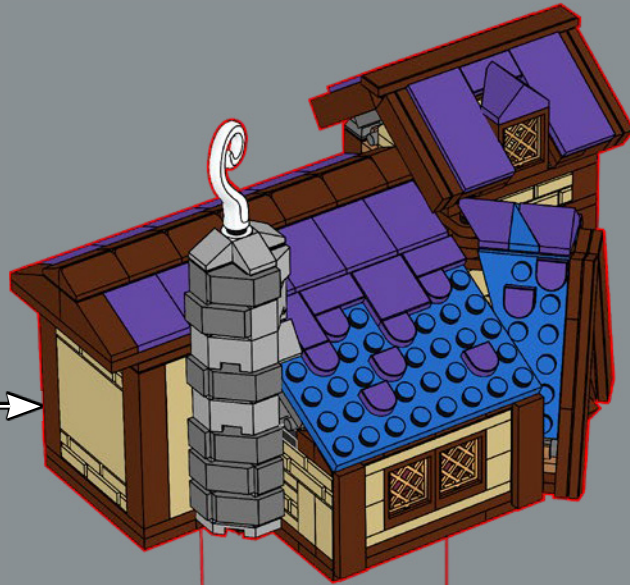



LEGO and the LEGO logo are trademarks of the/son des marques de commerce du/son marcas registradas de LEGO Group. ©2024 The LEGO Group. 6515794
DUNGEONS & DRAGONS is a trademark of Wizards of the Coast LLC and is used with permission. ©2024 Wizards of the Coast.