

LEGO

NINJAGO

Masters of Spinjitzu



2519



1

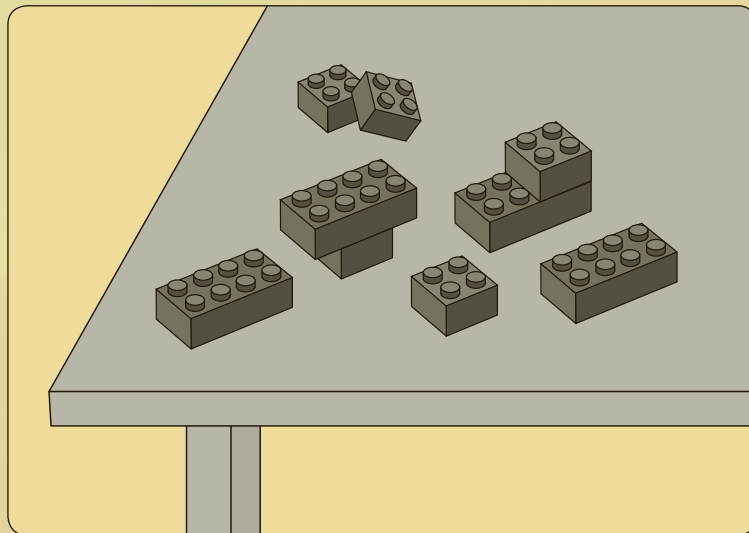
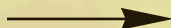
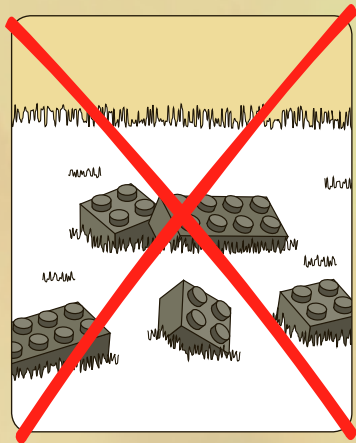

2



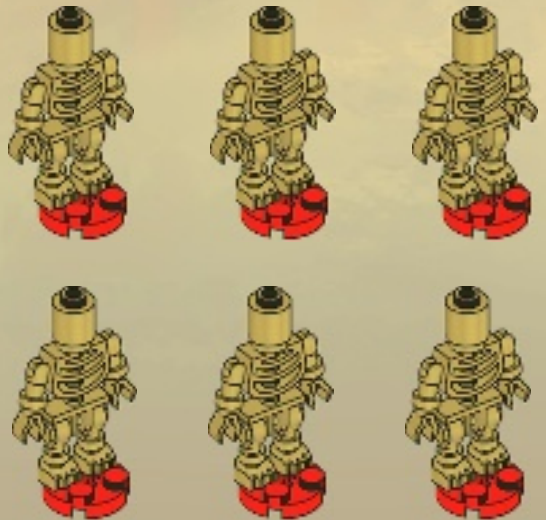
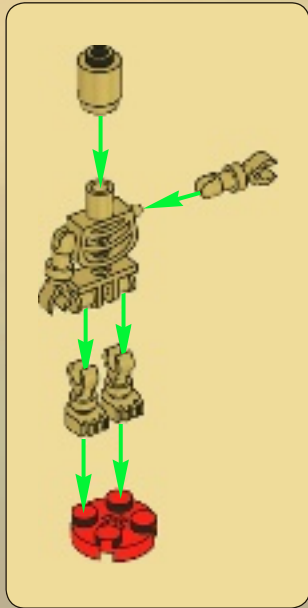
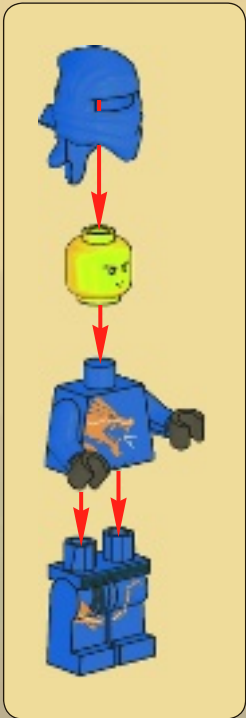
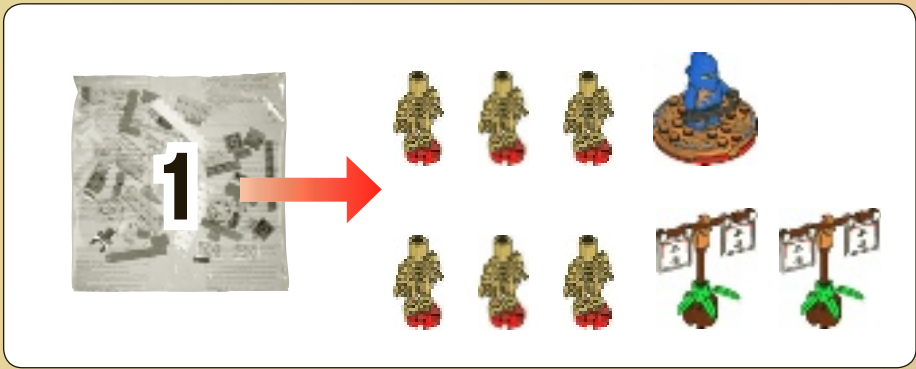

1



2



3

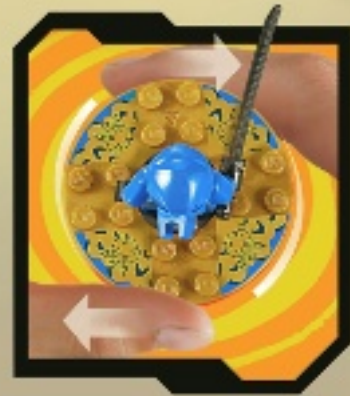



1



2



3

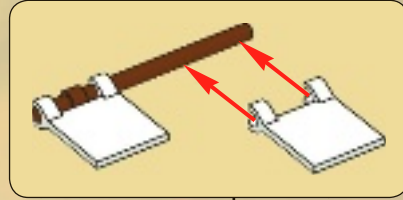

4

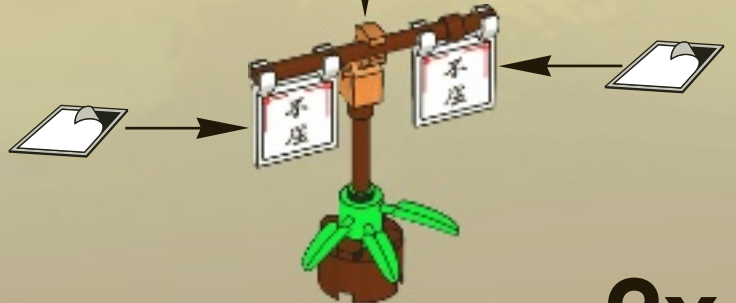

2x

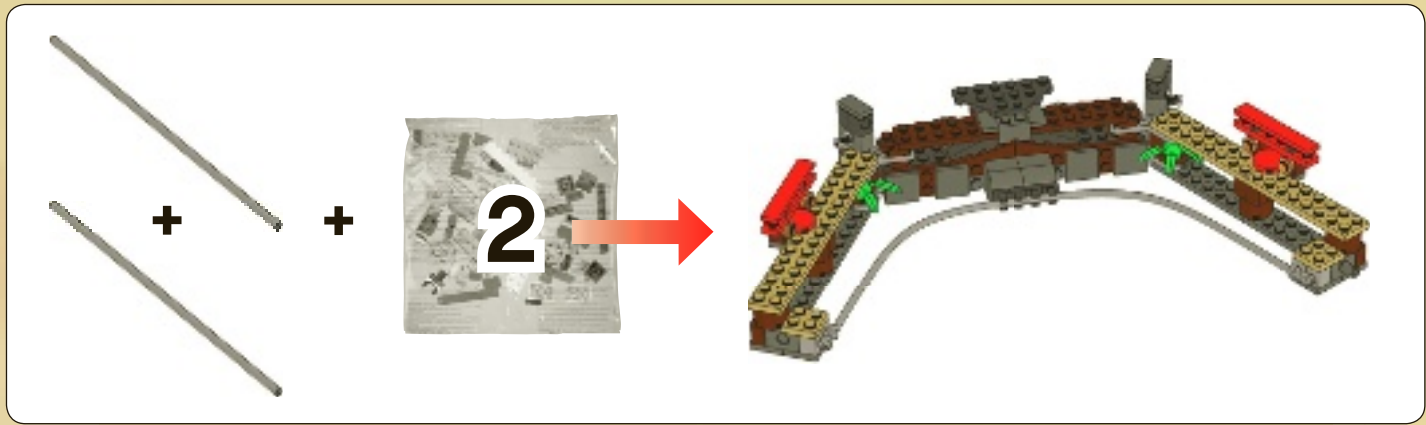

1



2





3

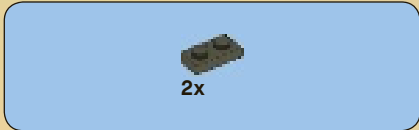

4





2x

5



1x



1x

6

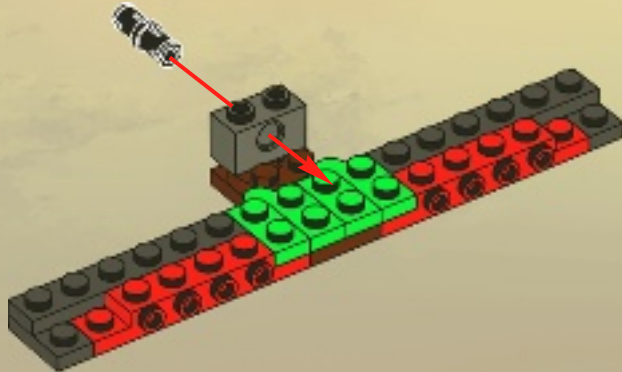



7

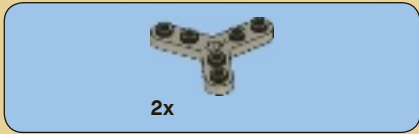
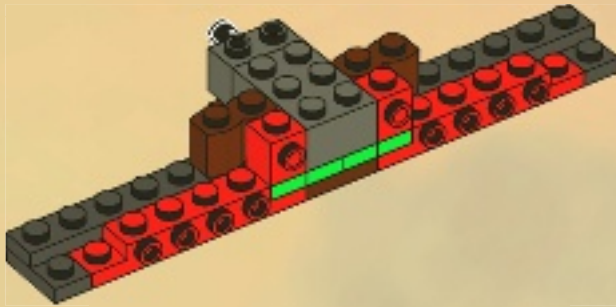

8

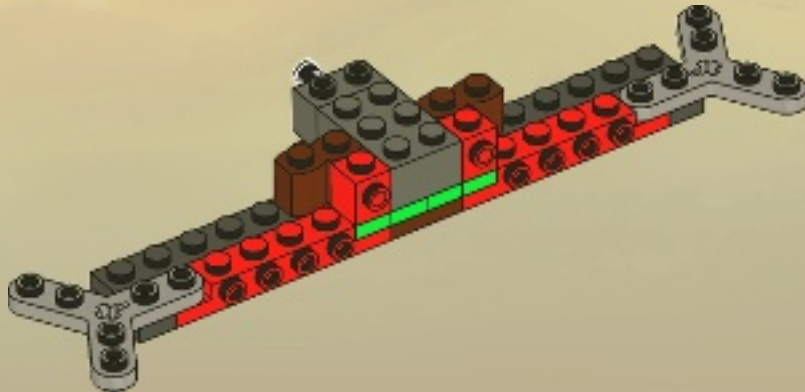



9

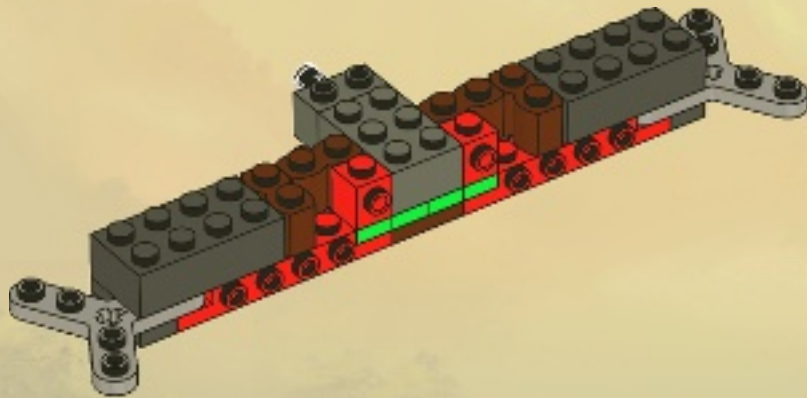

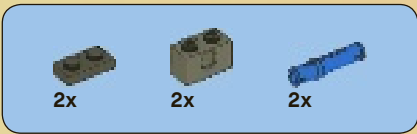

10

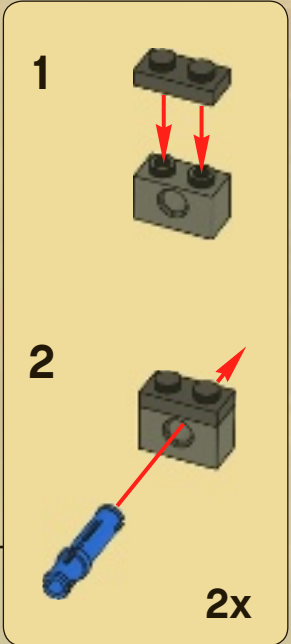
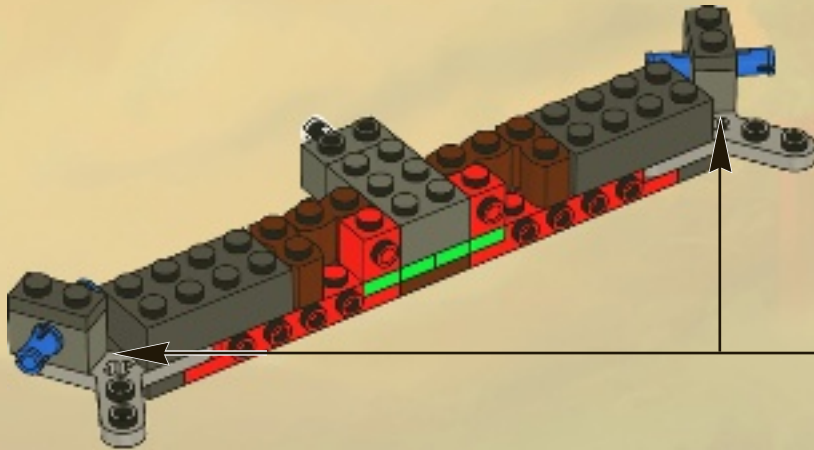



2x

11



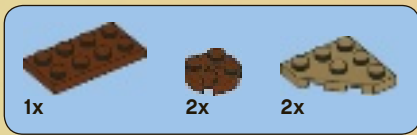

12

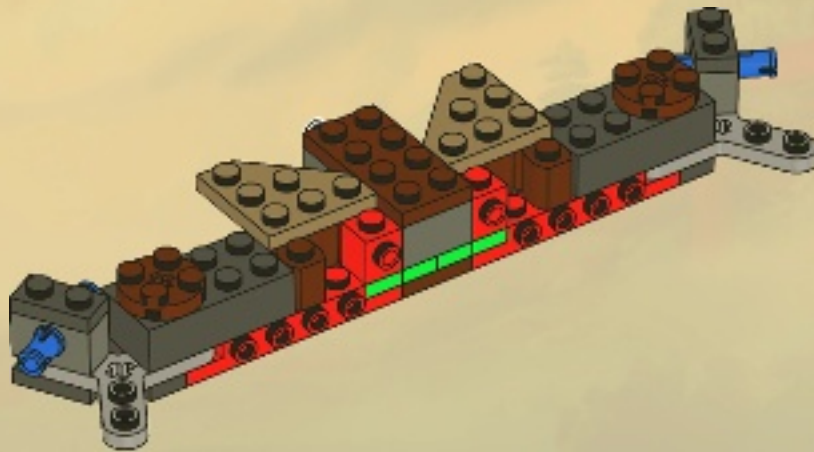
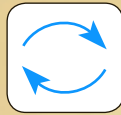

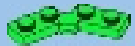

2x



1x

13

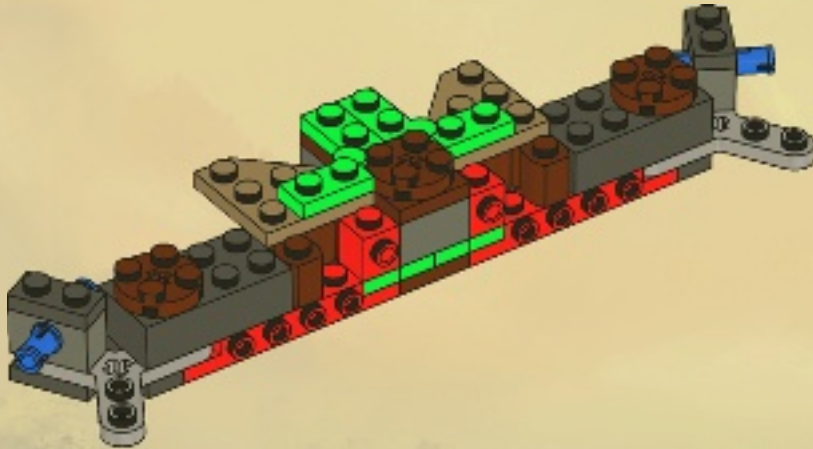



4x



2x

14

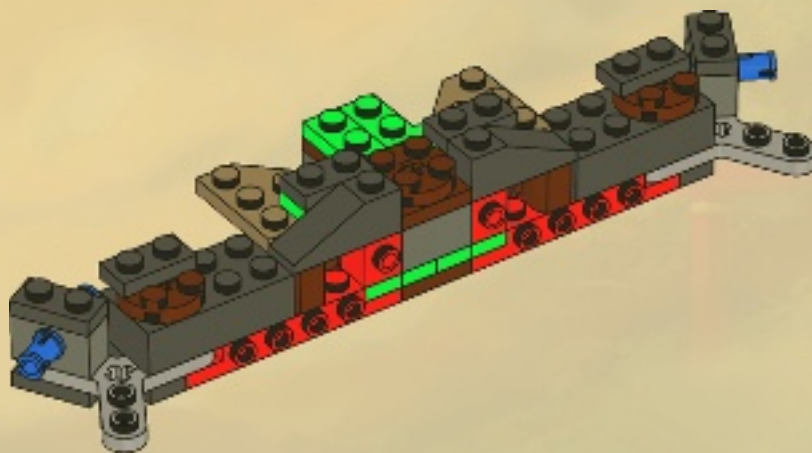

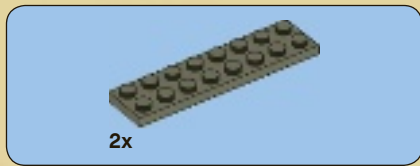

15





2x

16





2x

17





2x



2x

18



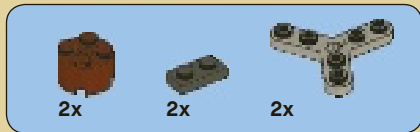

19



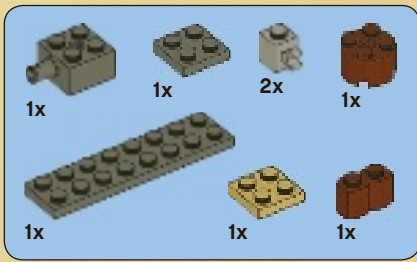

20

1

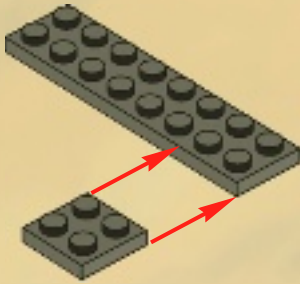

2

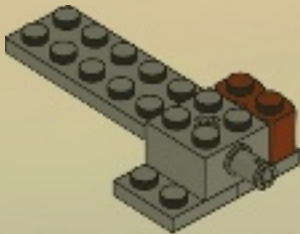

3

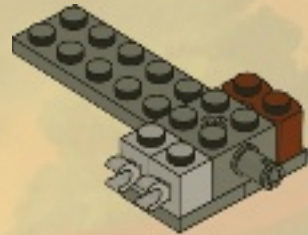

4

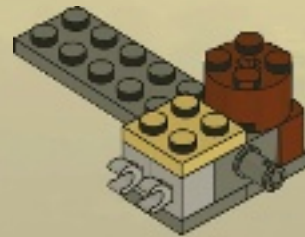

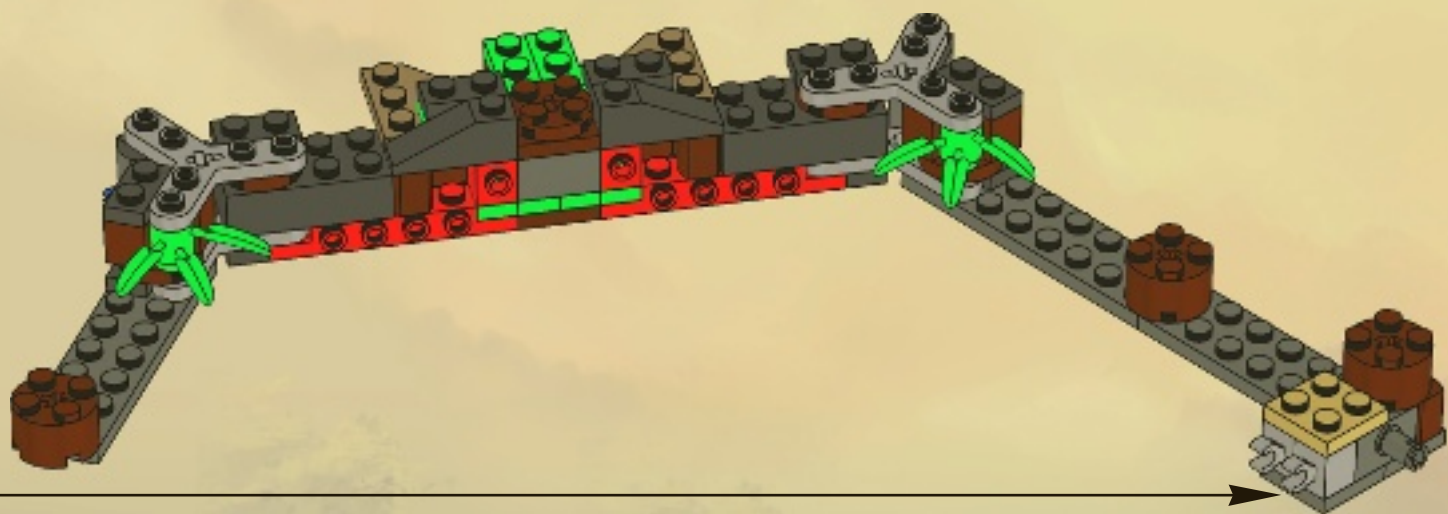

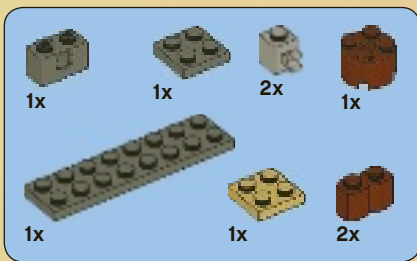

21

1

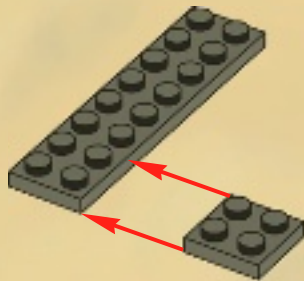

2

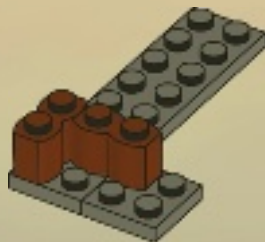

3

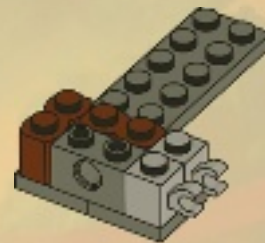

4

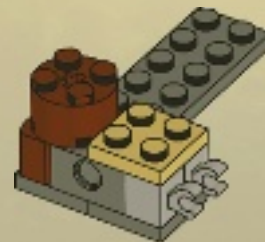





2x



2x

22

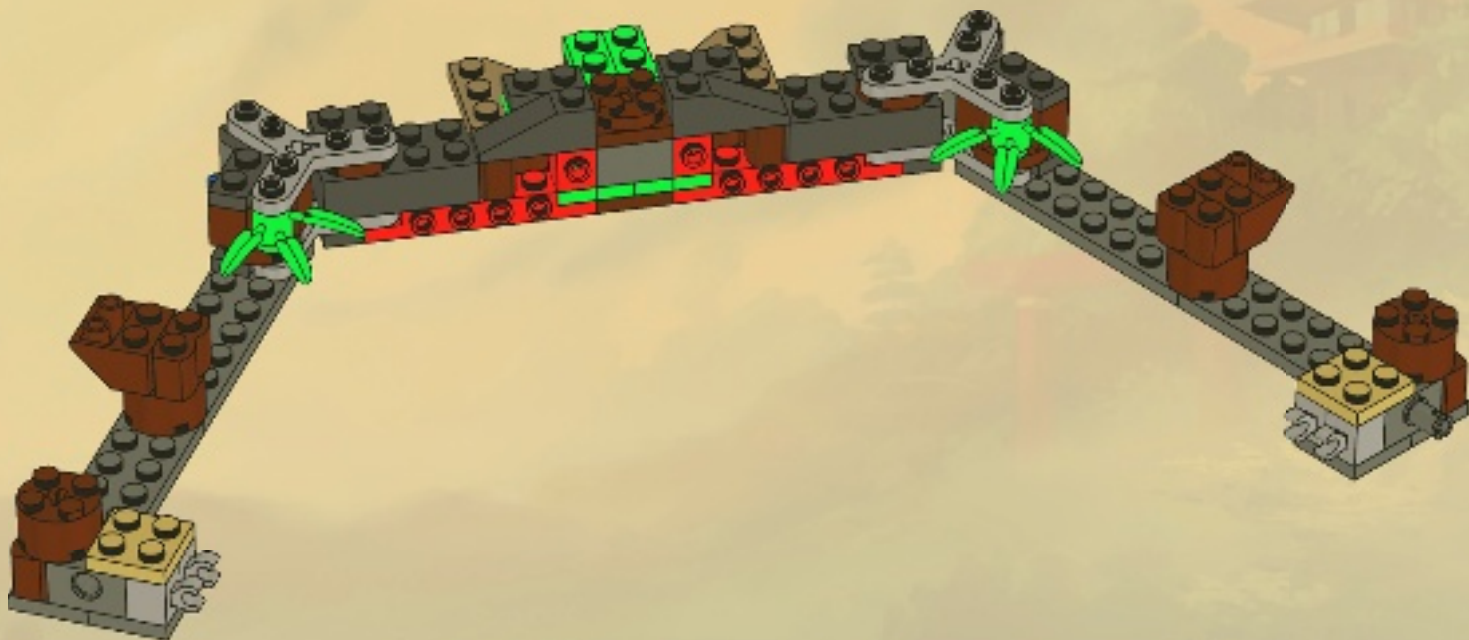

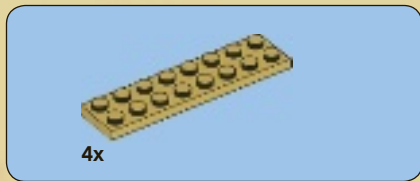

23





24





25





26

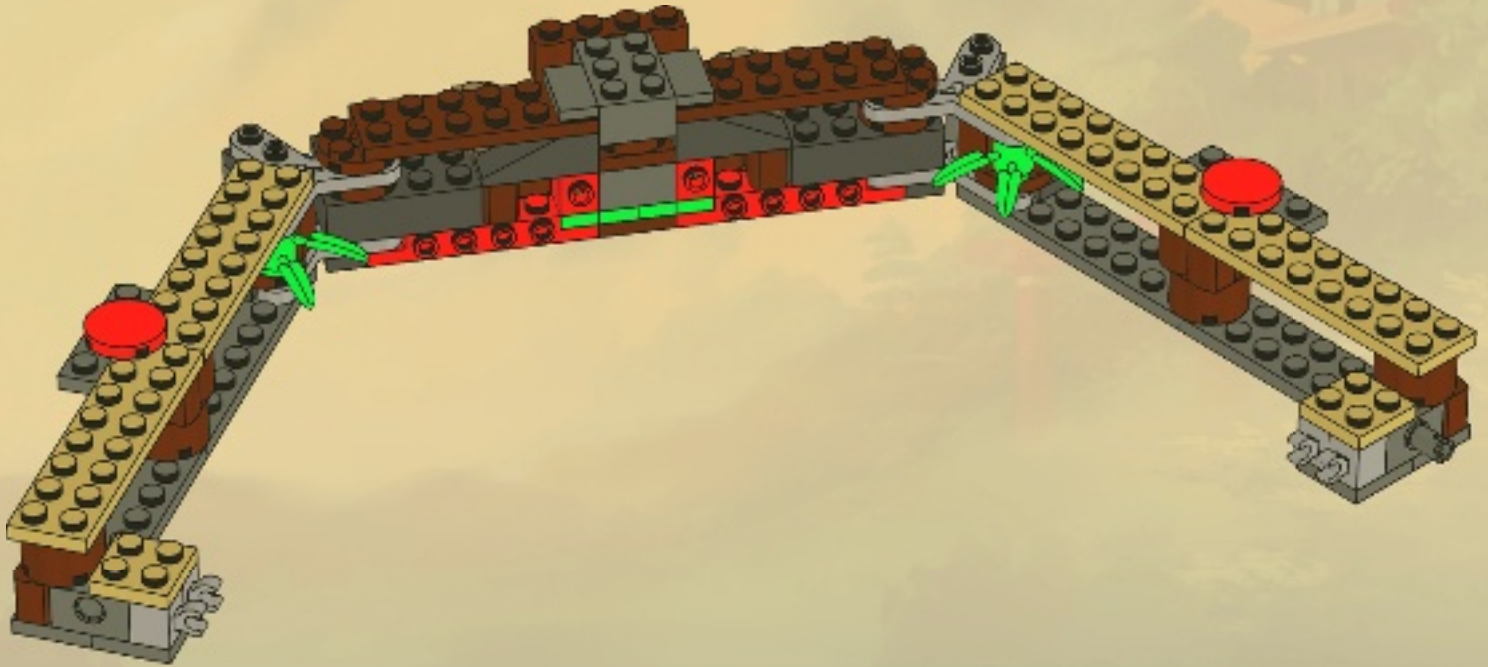

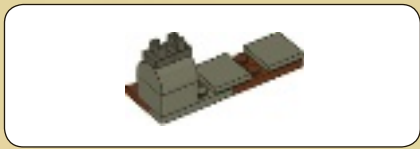

1



2

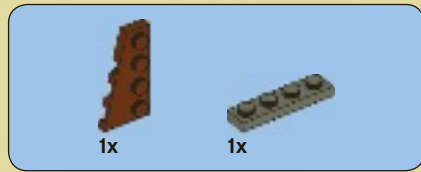
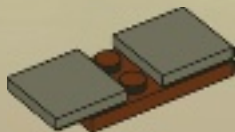

3

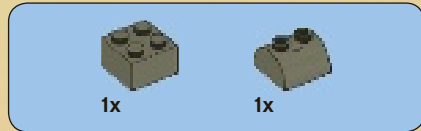
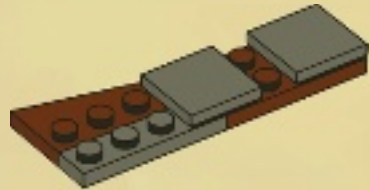

4

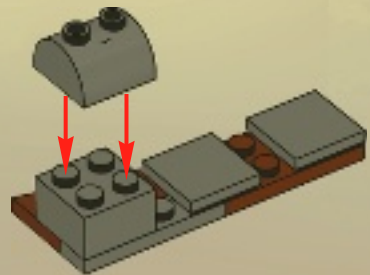

2x

5

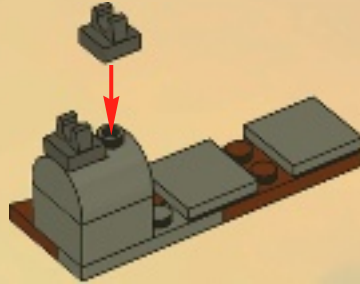

27



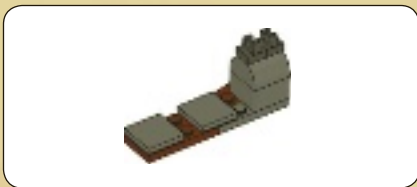

1



2

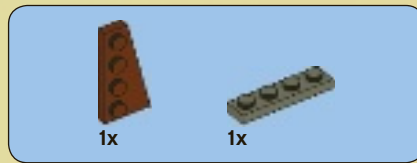
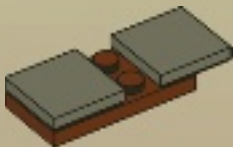

3

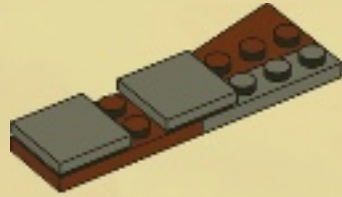

4

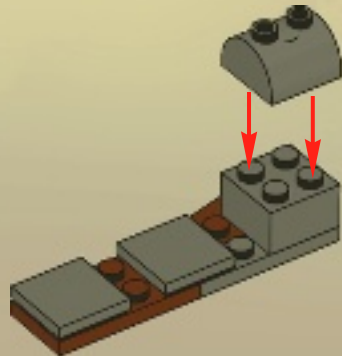

2x

5

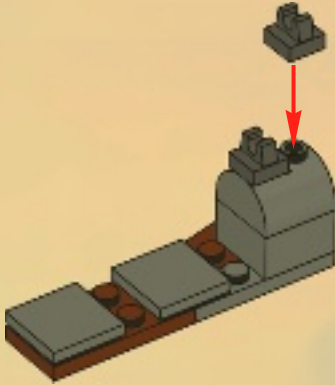

28

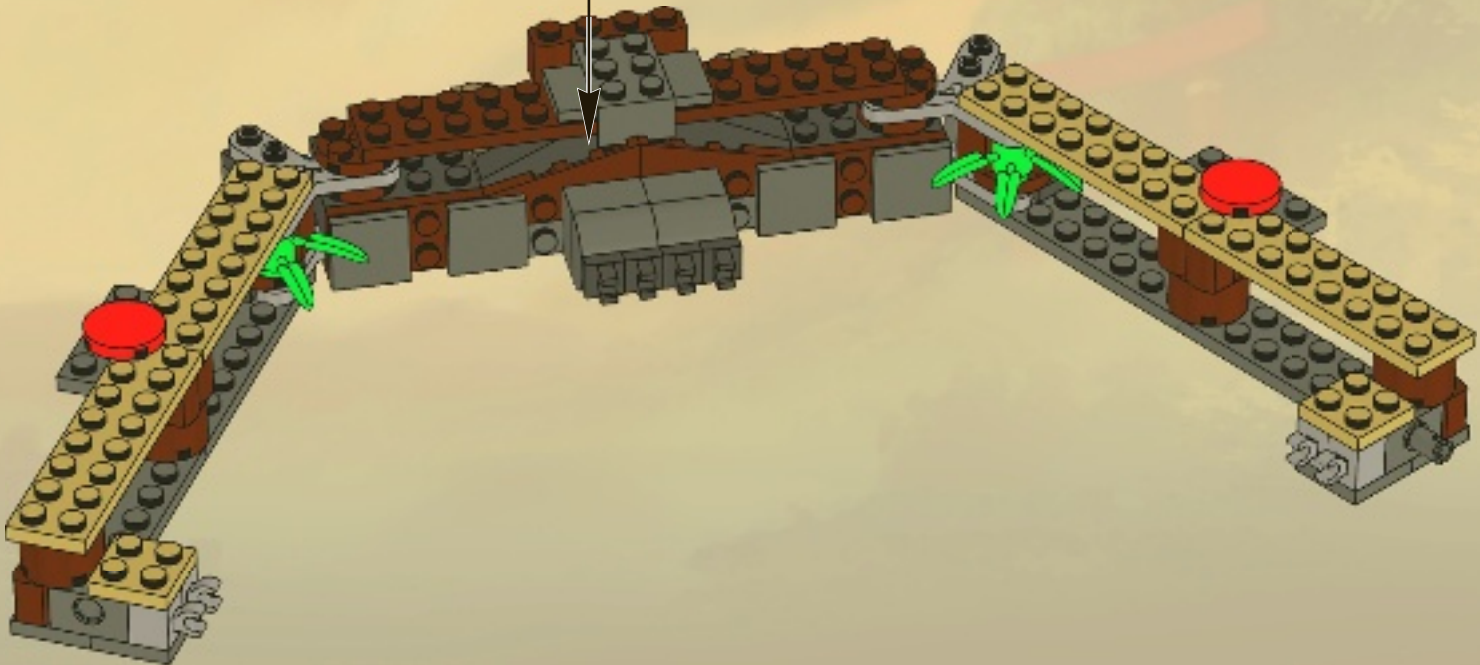

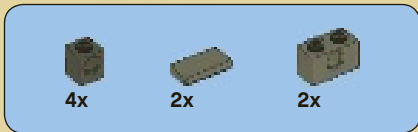

29

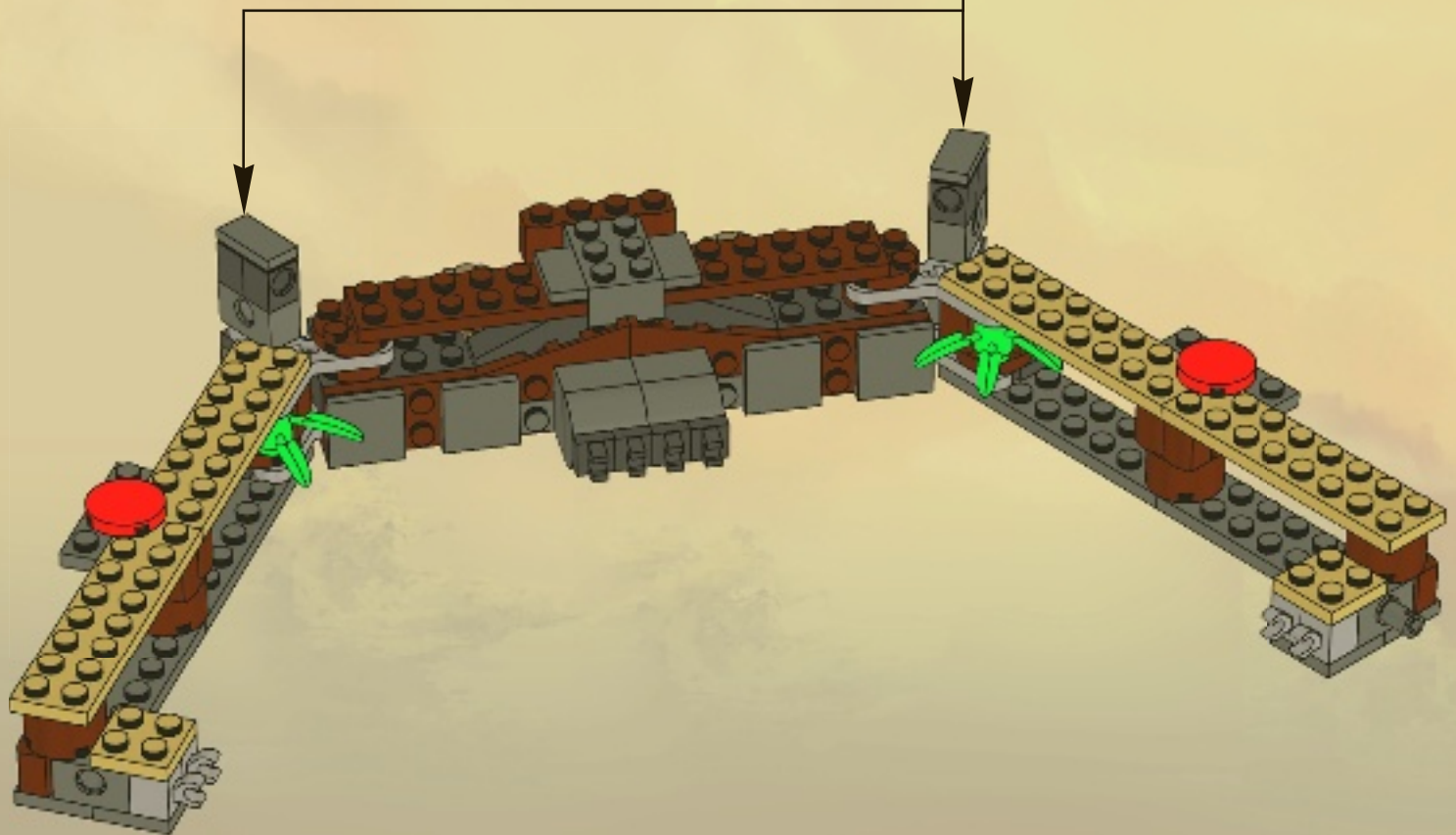
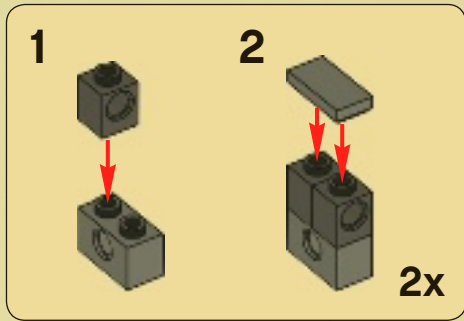



2x

30





4x



4x

31



4x

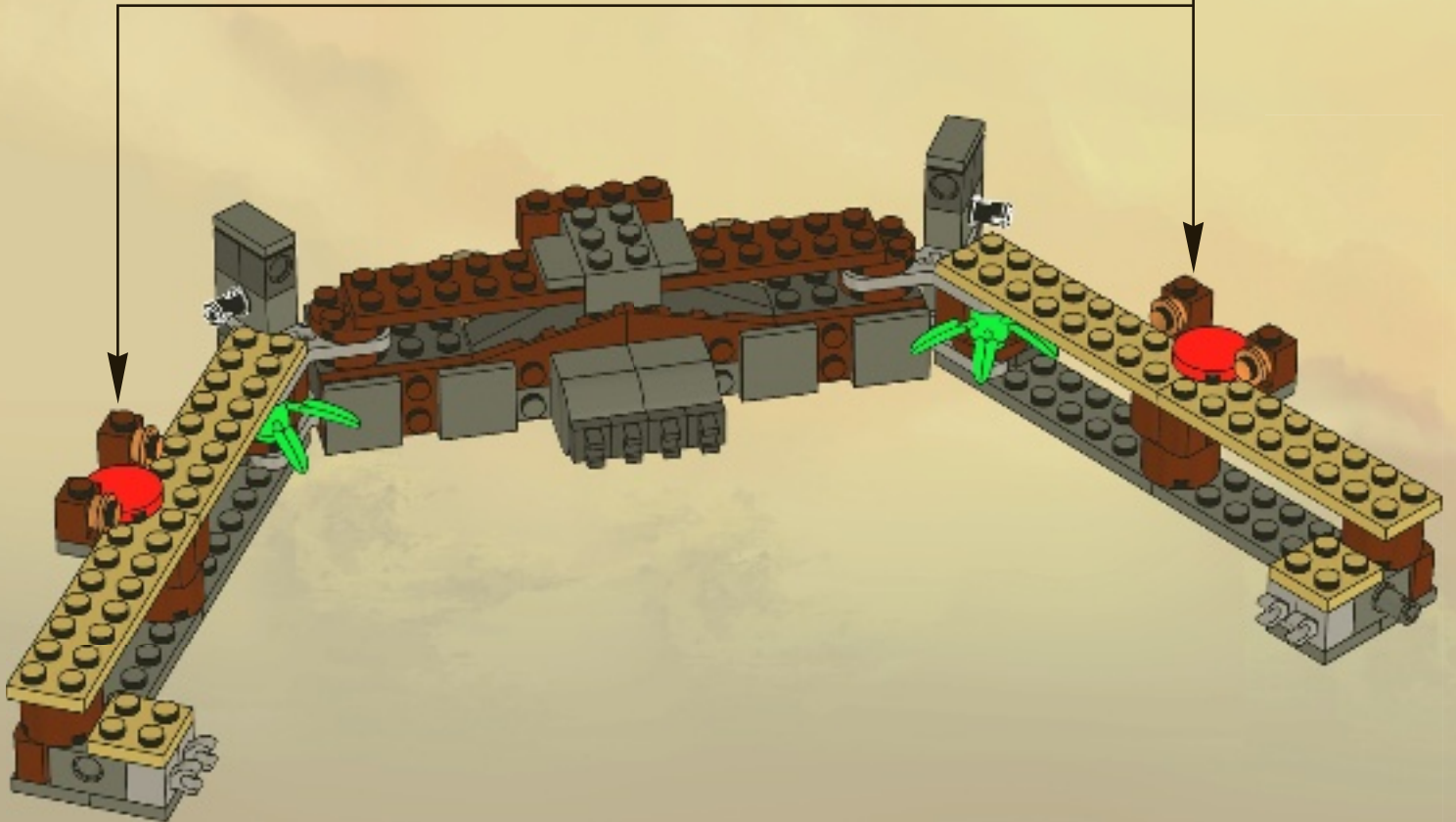



32

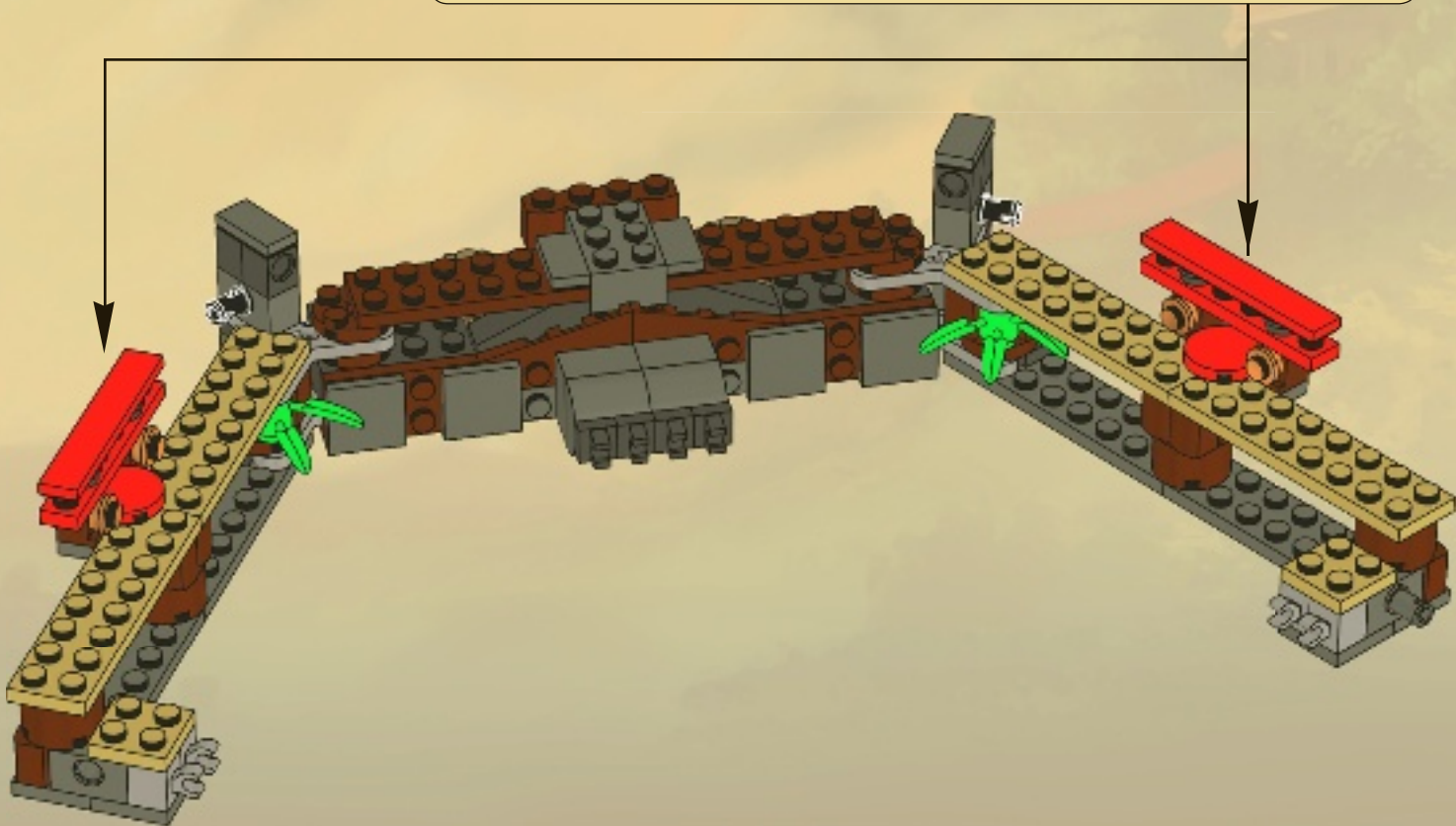
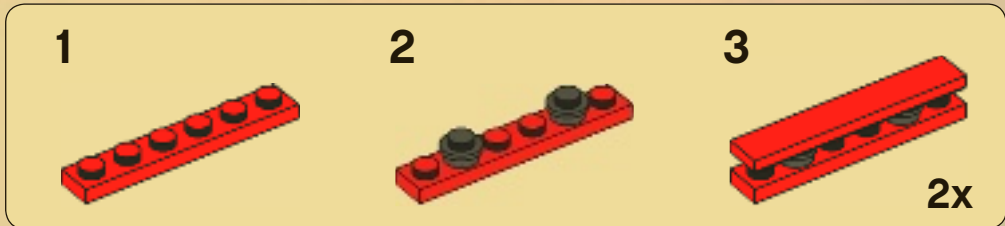

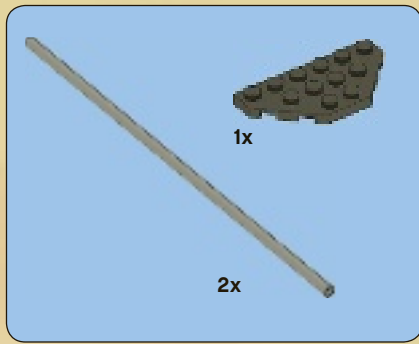

33

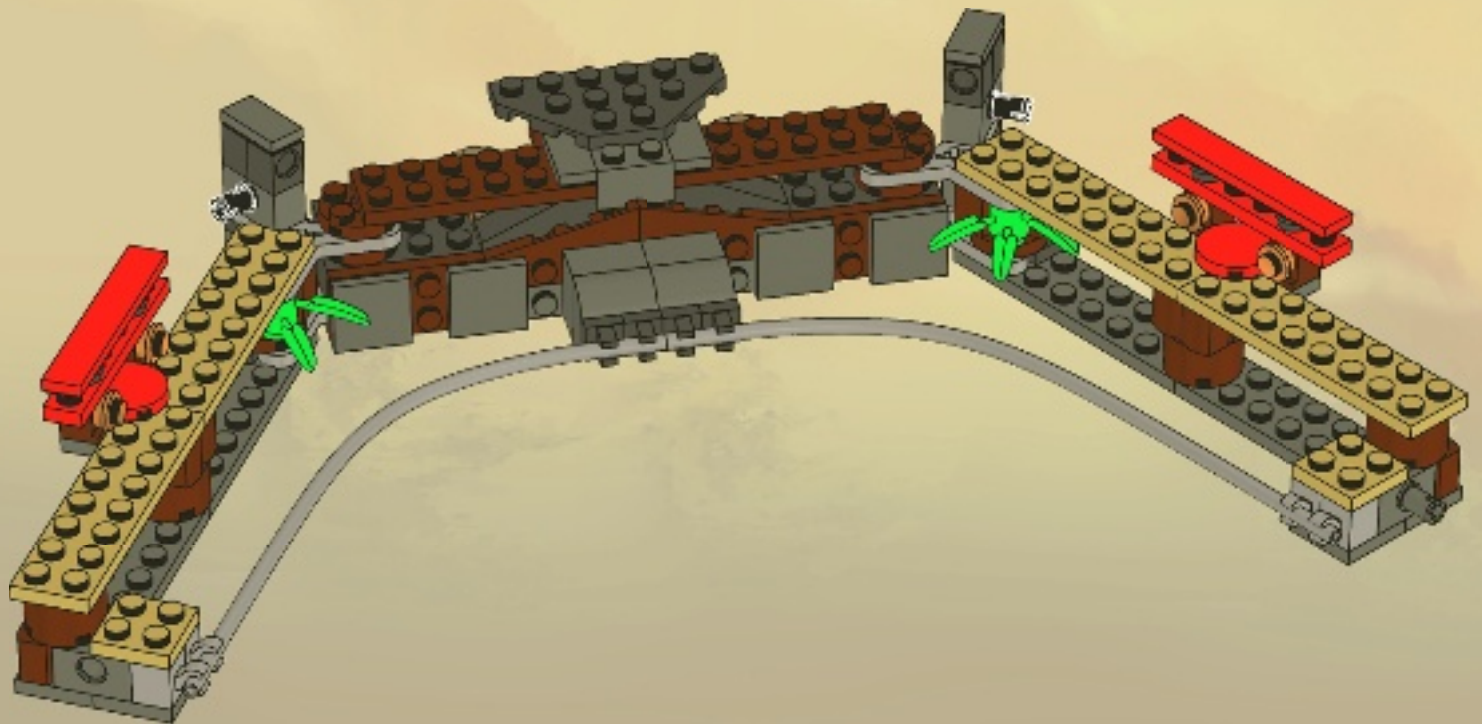

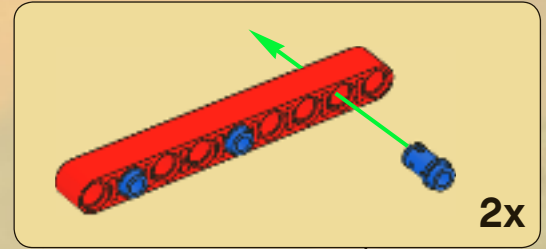
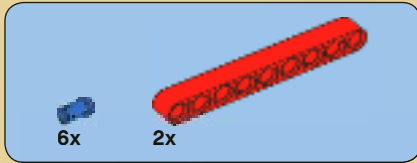
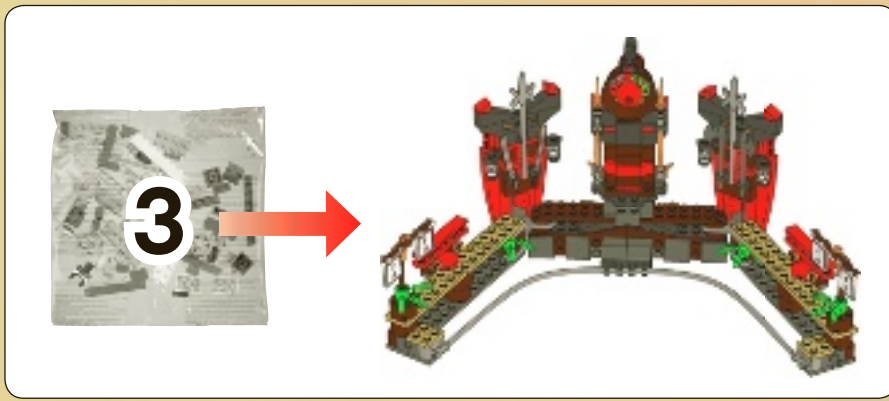

34

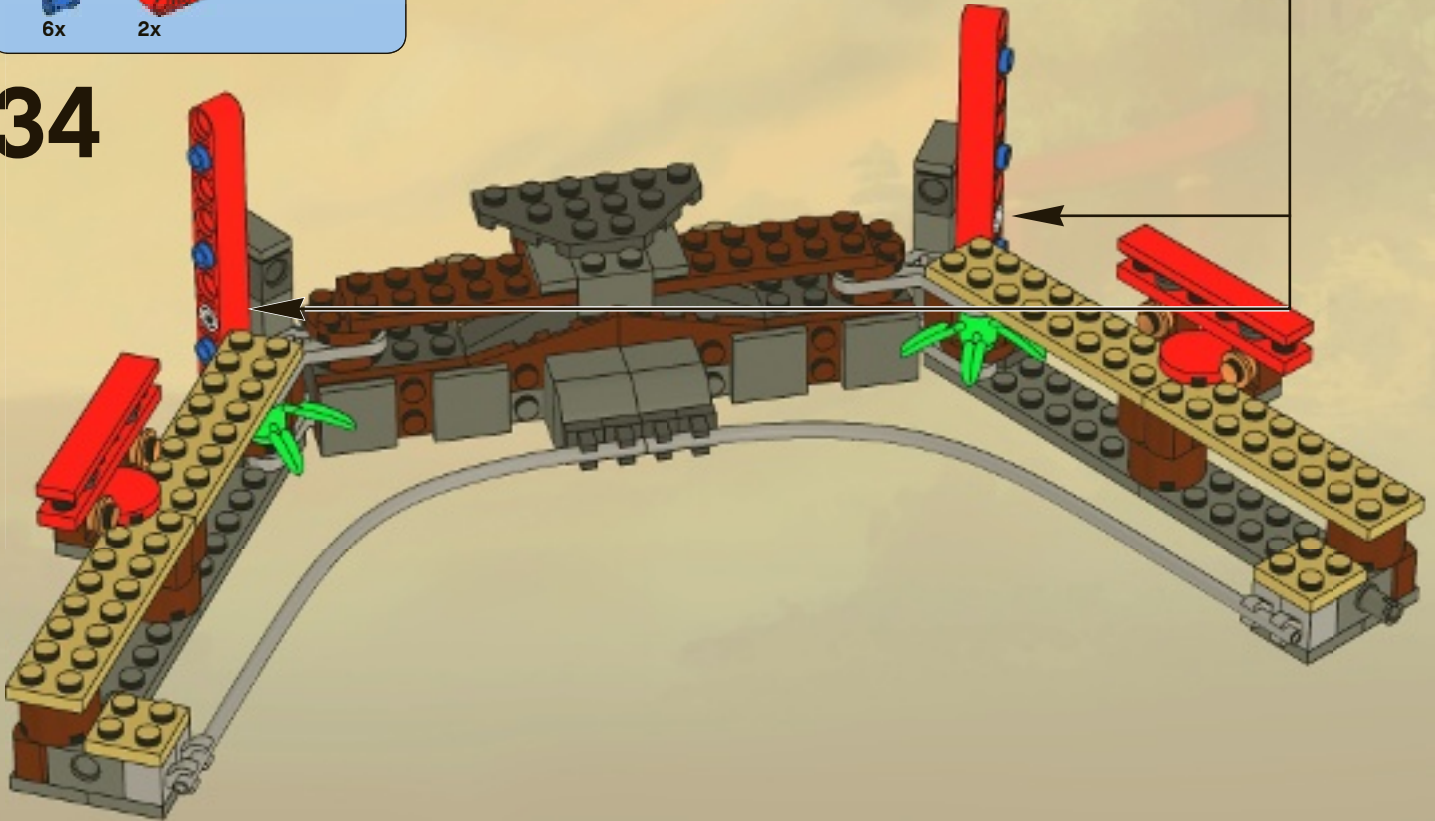



2x



1x

1



1x

2



2x

3



2x



2x

4

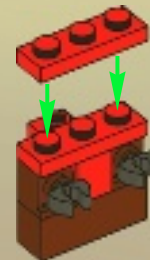



5

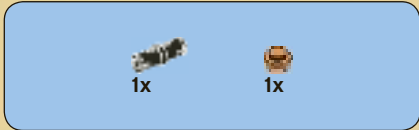

6

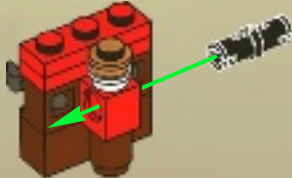

7



8

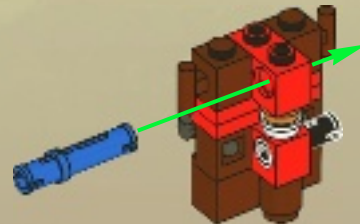

2x

35



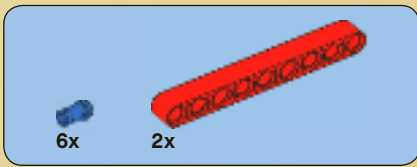

36

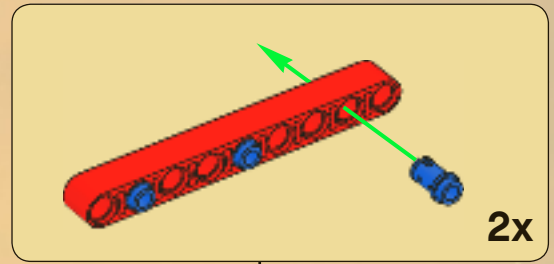

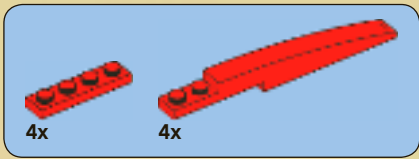

37

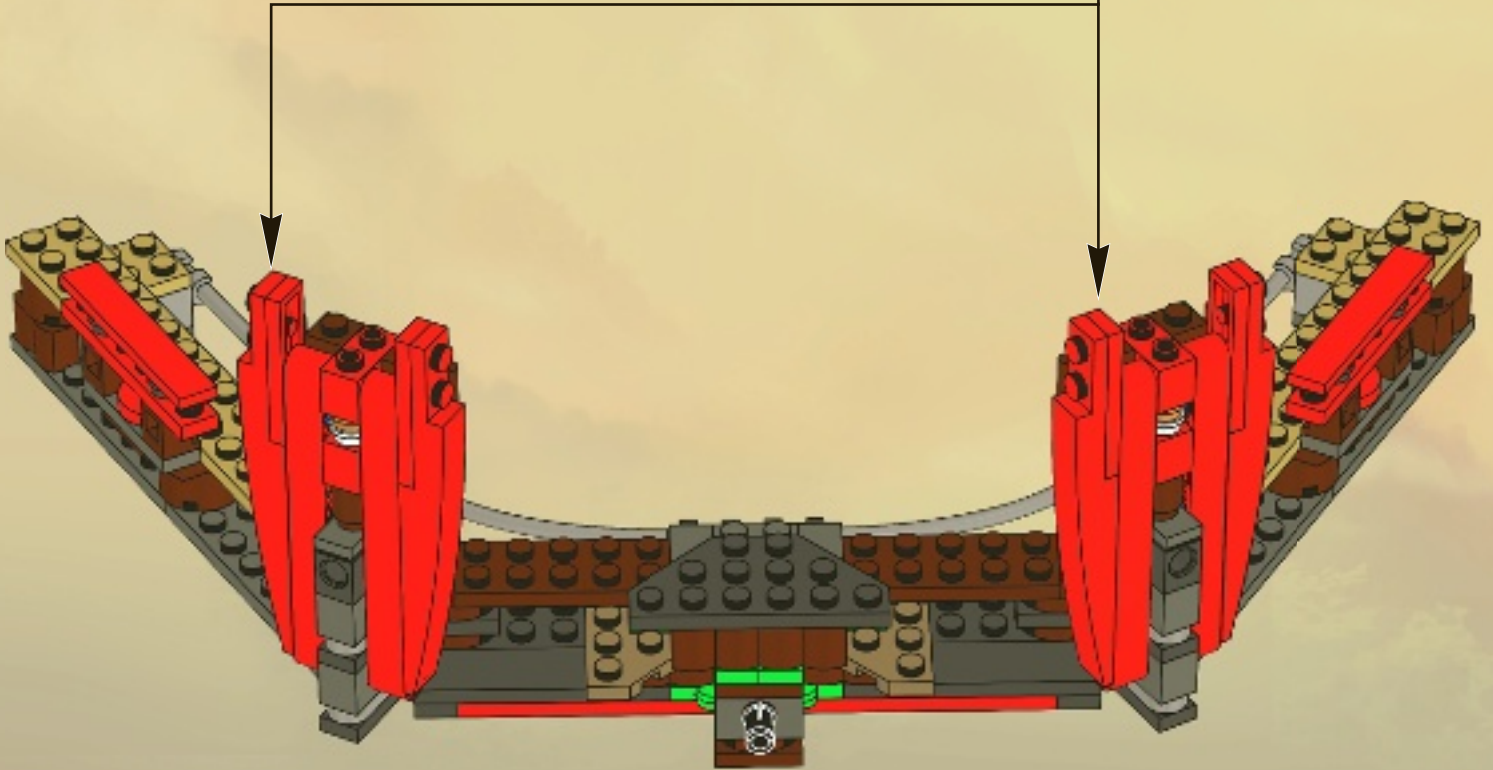
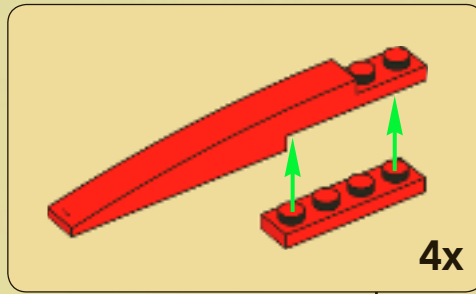



1

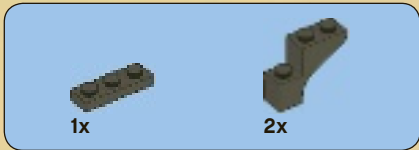

2

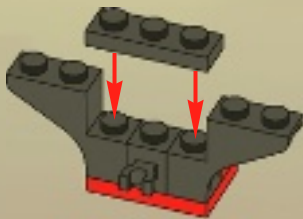

3

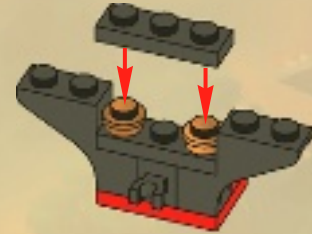

4

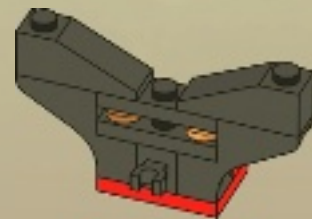

2x



5

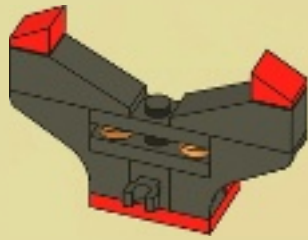

2x

38

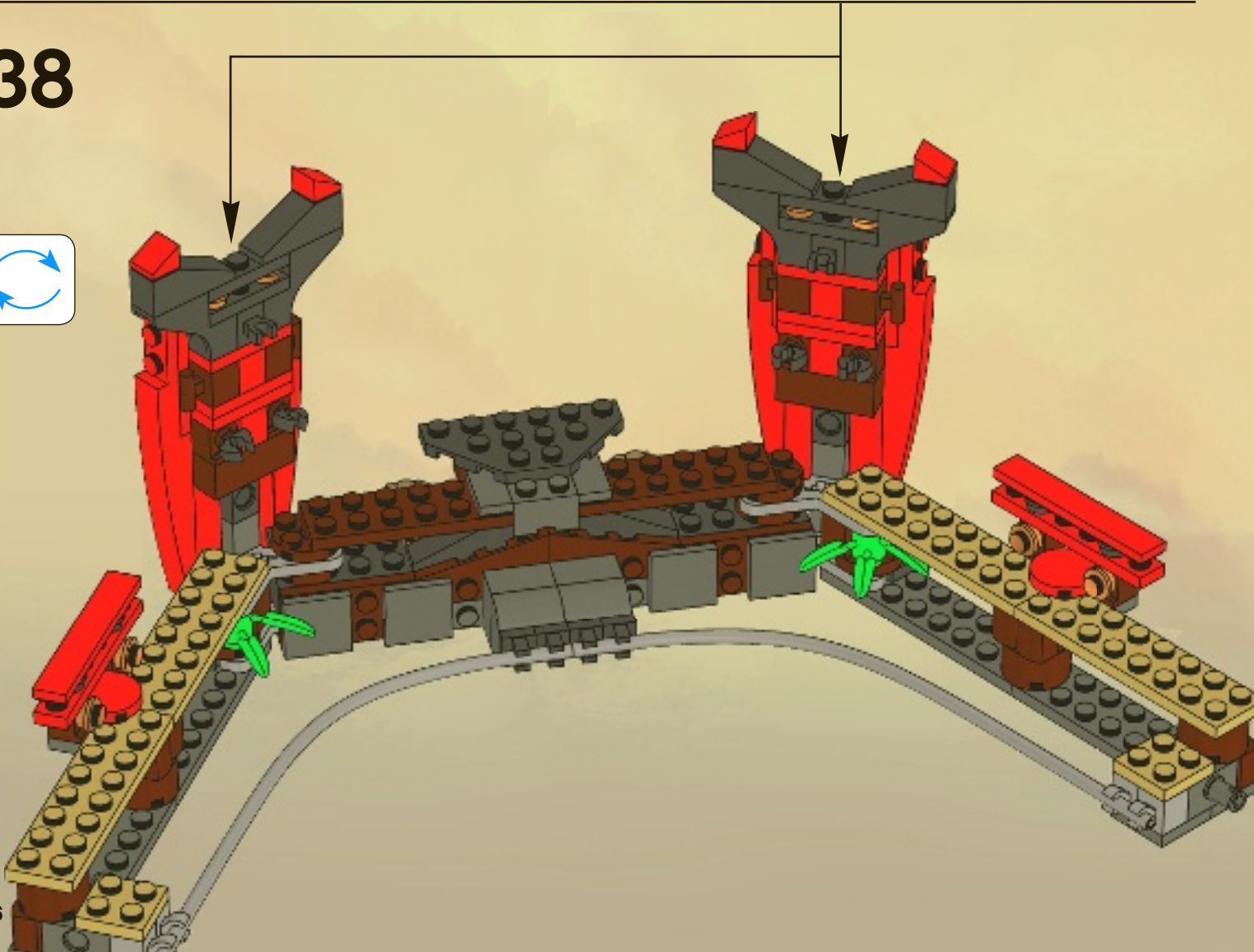



1



2



3



4

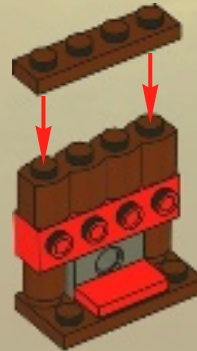



2x

5



2x



1x

6

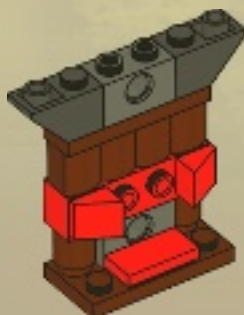

1x



2x

7



1x

8





9



10

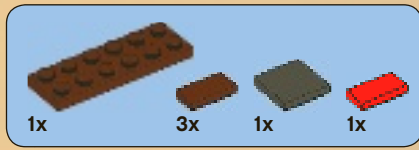
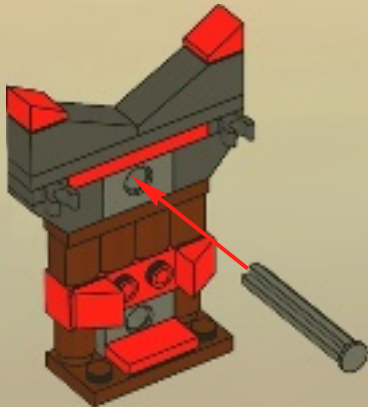

11

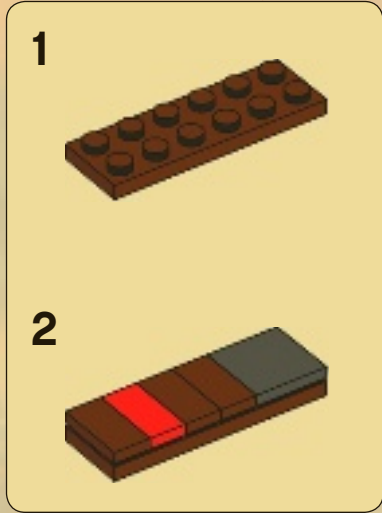

39

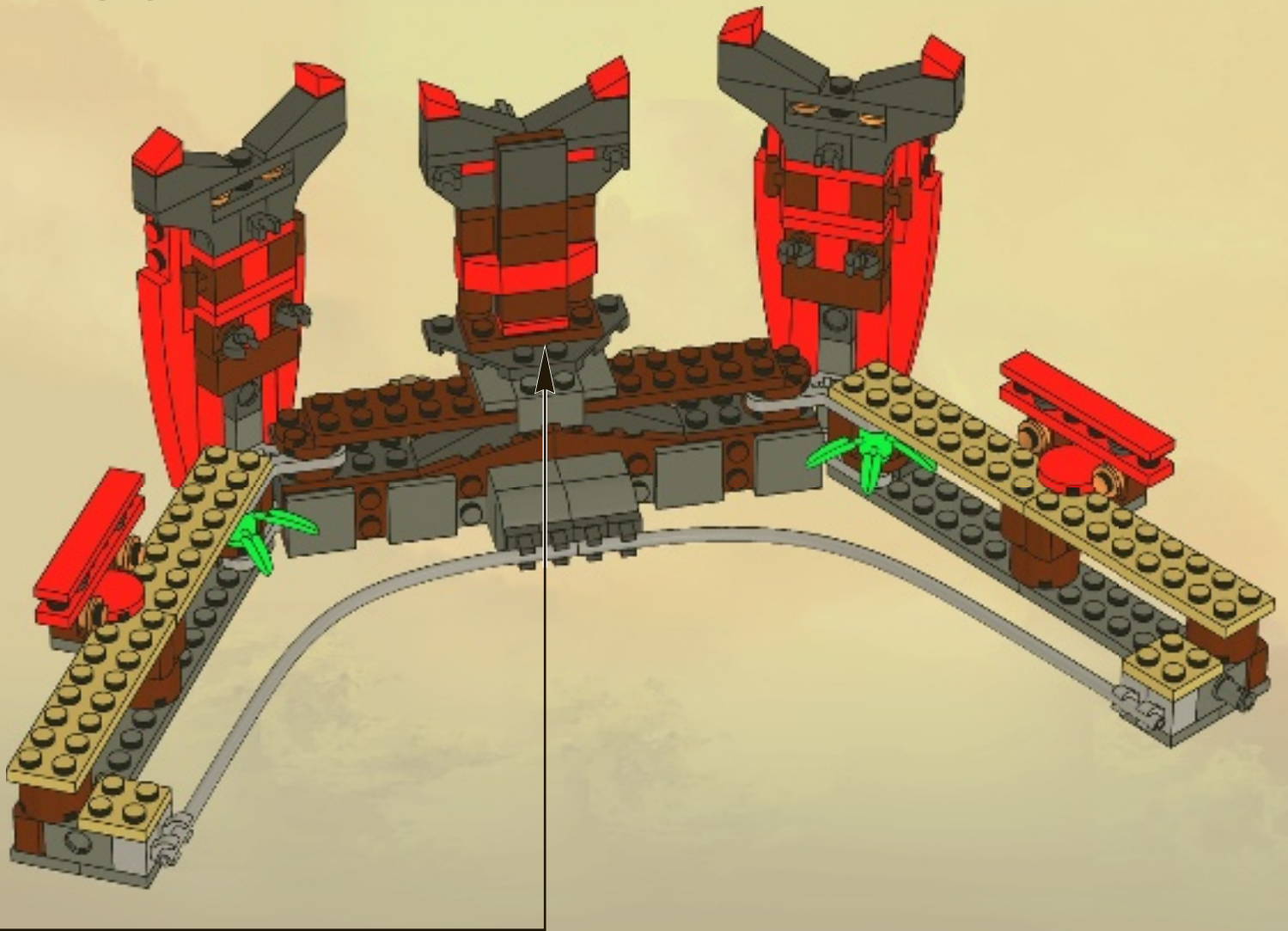

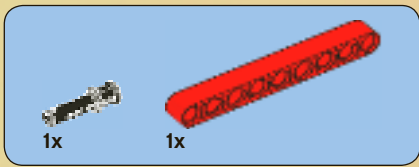

40



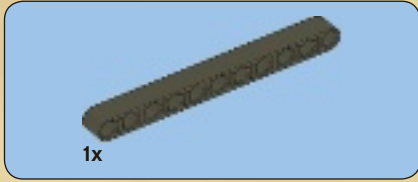

1



2

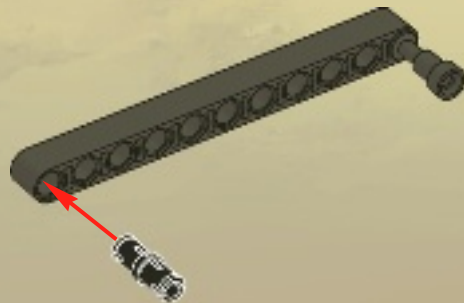

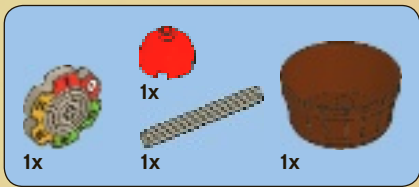

3

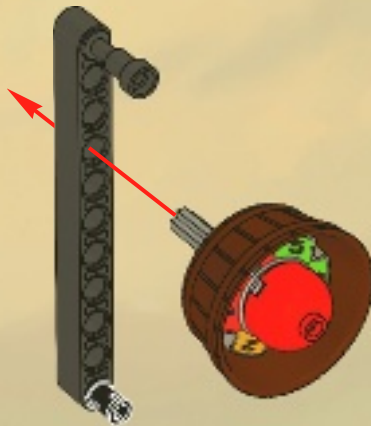



4

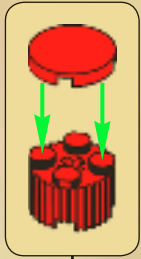

5



41





1x

42

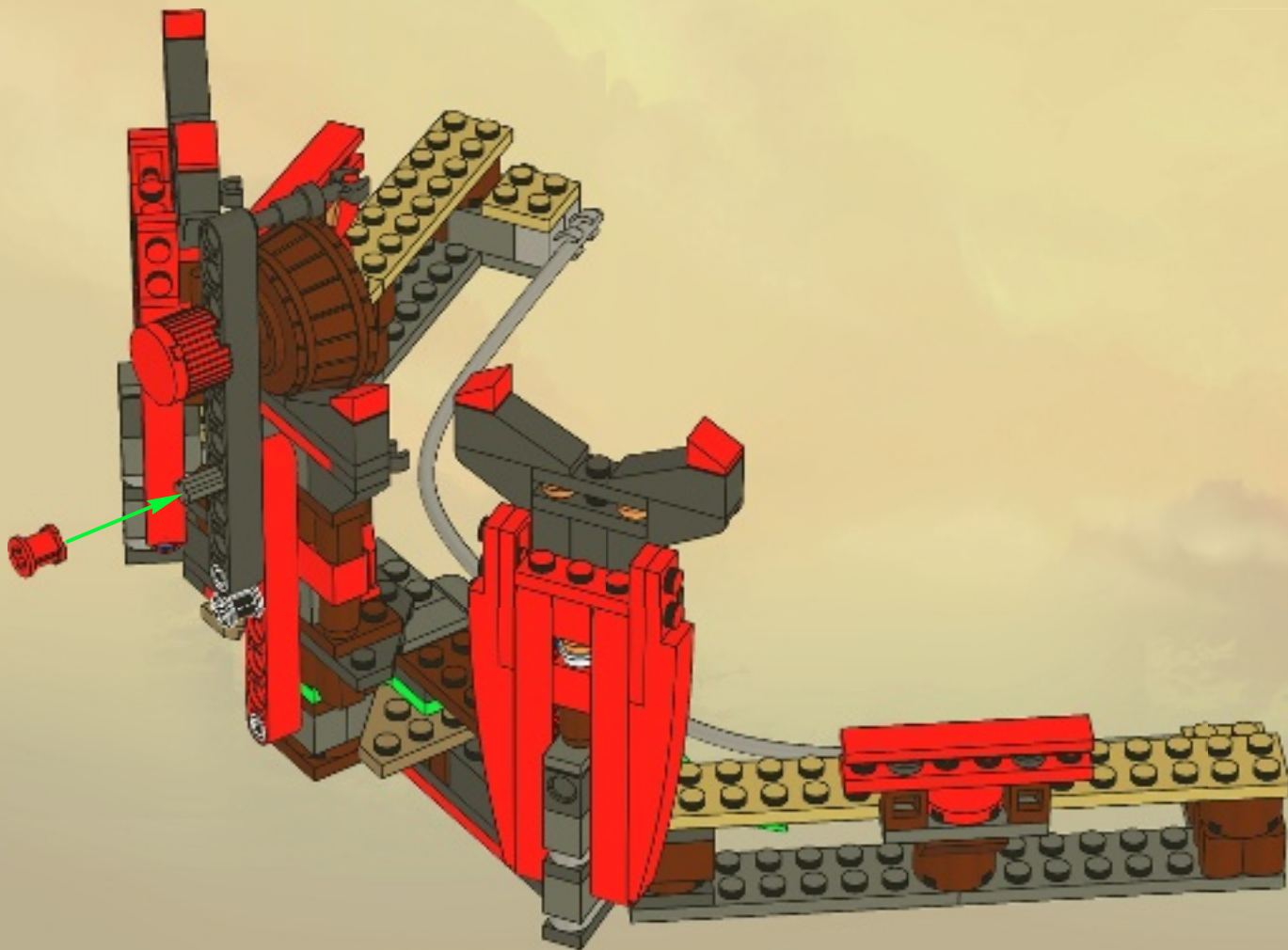

12x

4x

4x

43

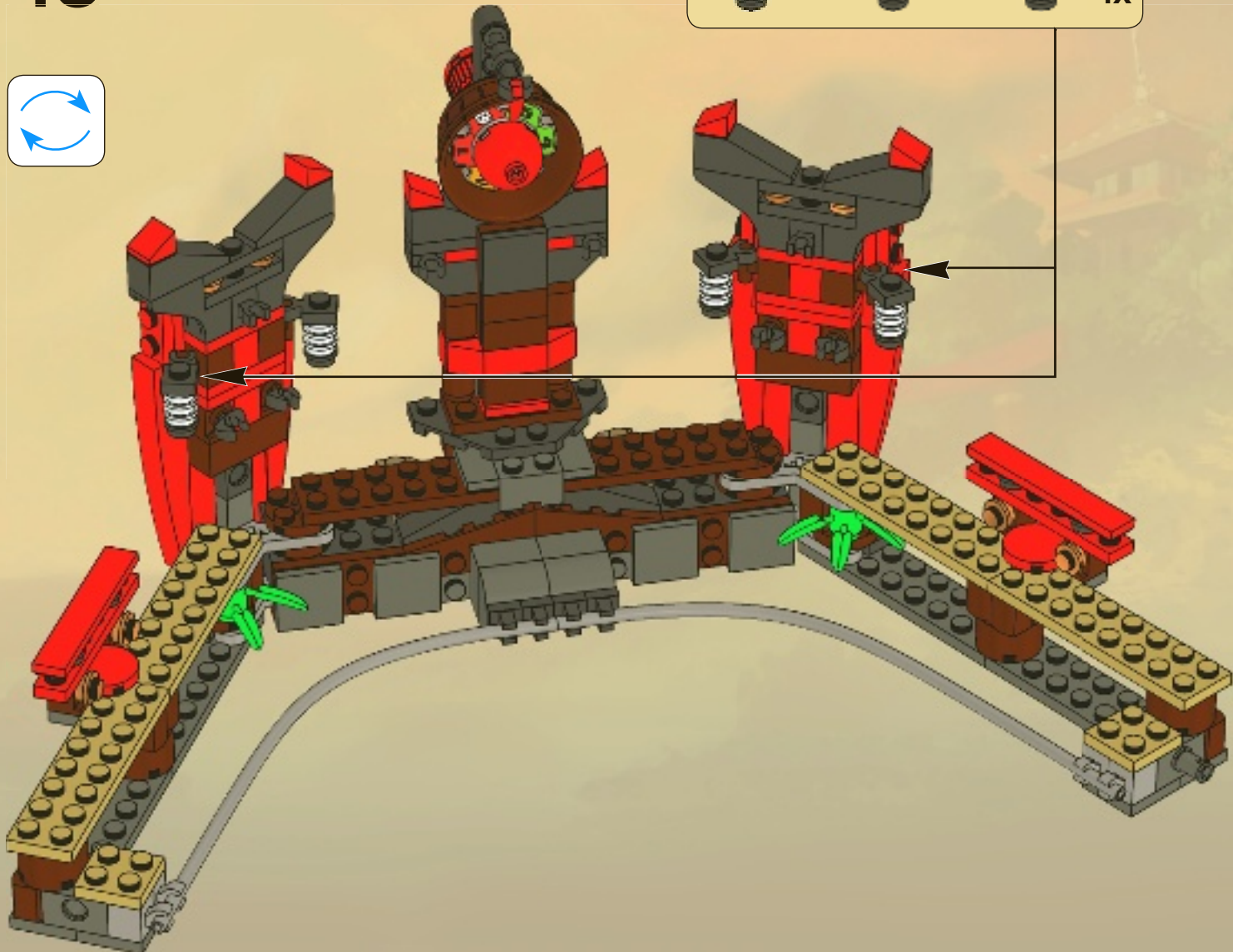

1 2 3

A parts list for step 43. It includes three numbered items: 1. A black Technic bush. 2. A grey Technic axle with a red arrow pointing to a hole. 3. A grey Technic axle with a spring and a cross-axle. The quantity '4x' is written to the right of item 3.

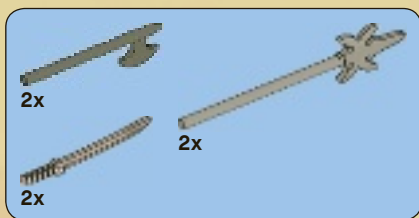

44





45

1



2



3



2x

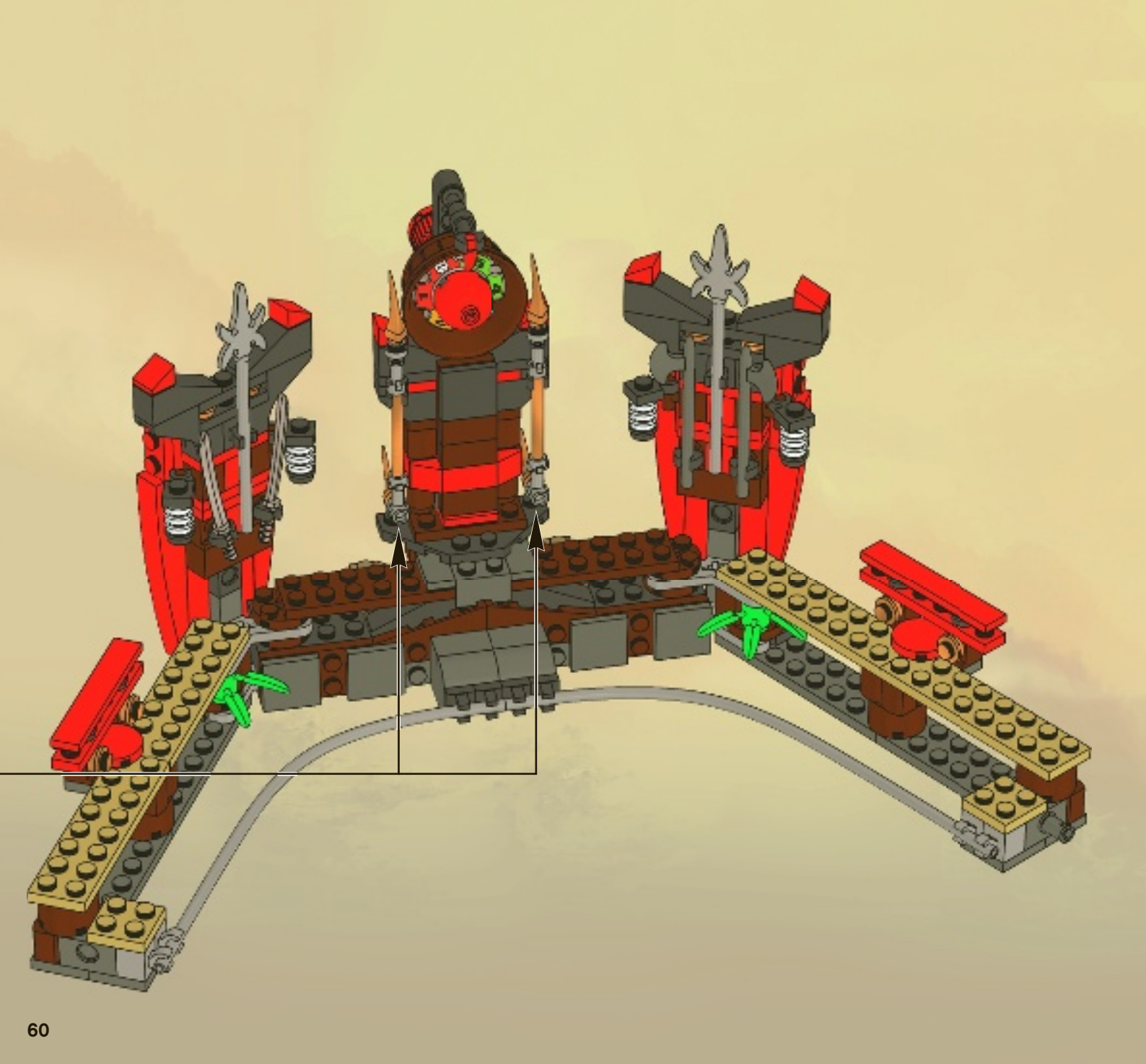

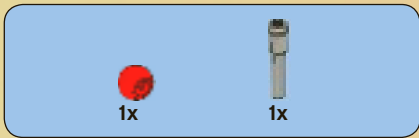

46

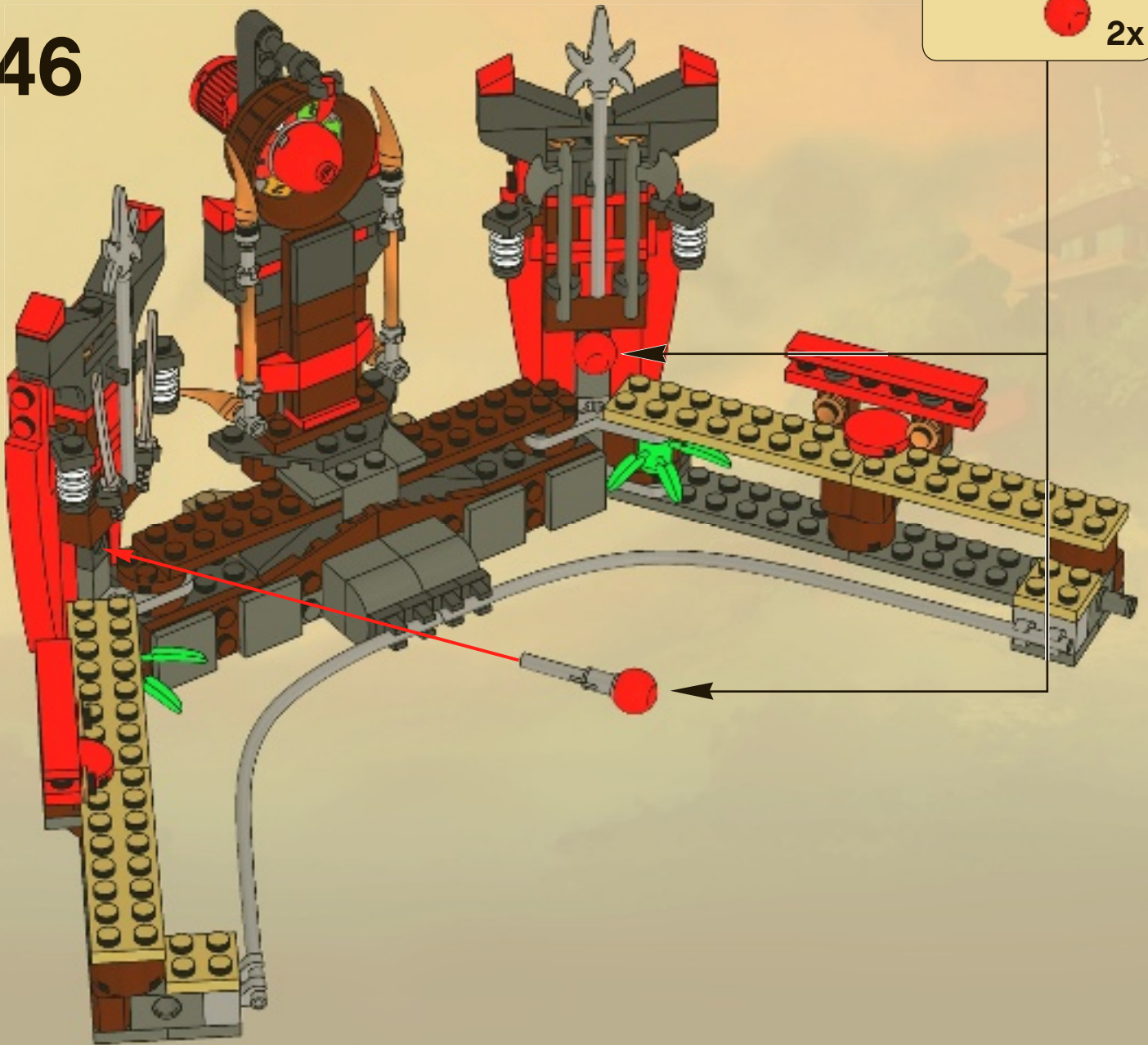
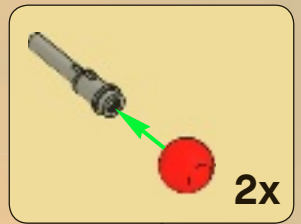

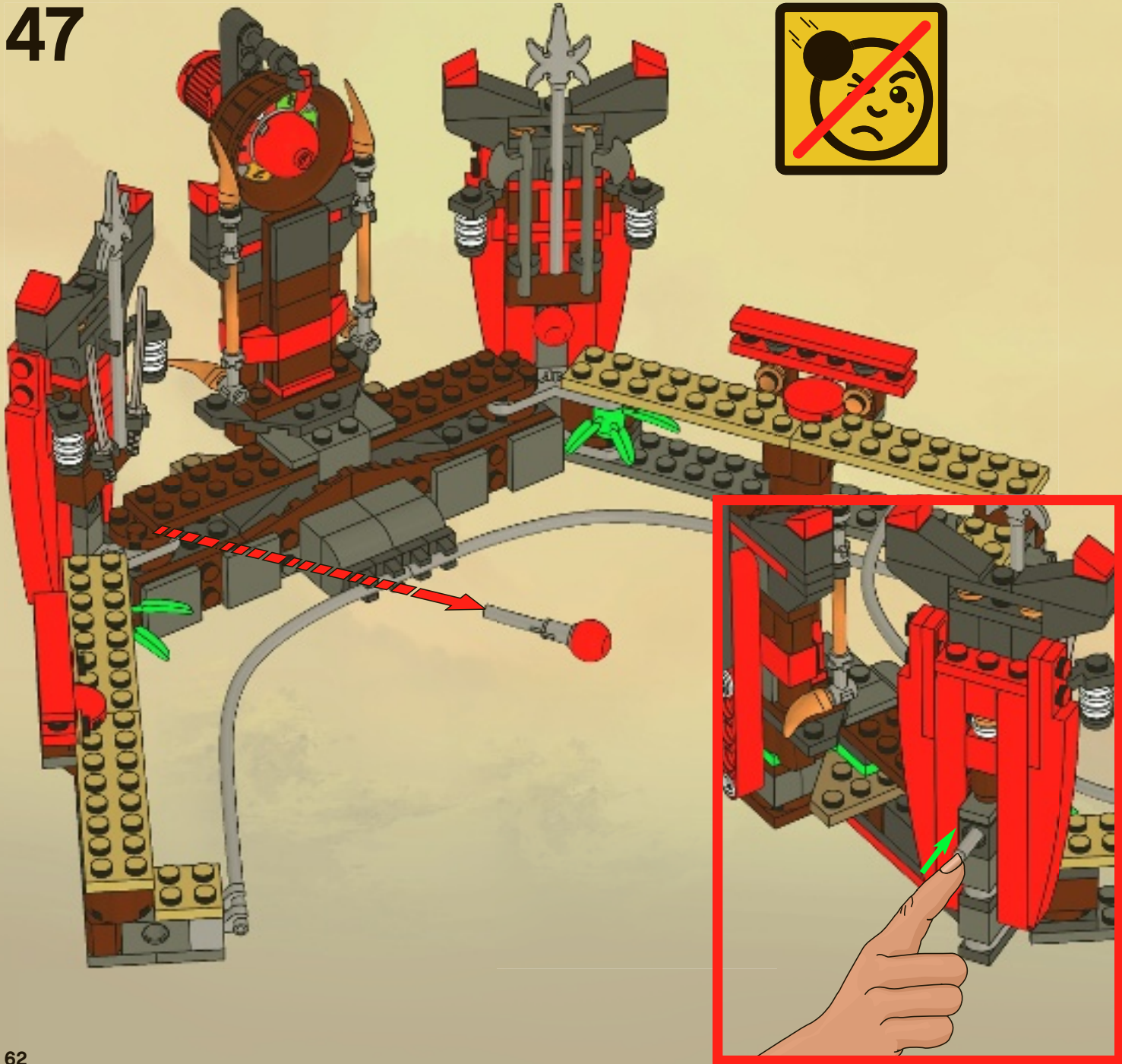

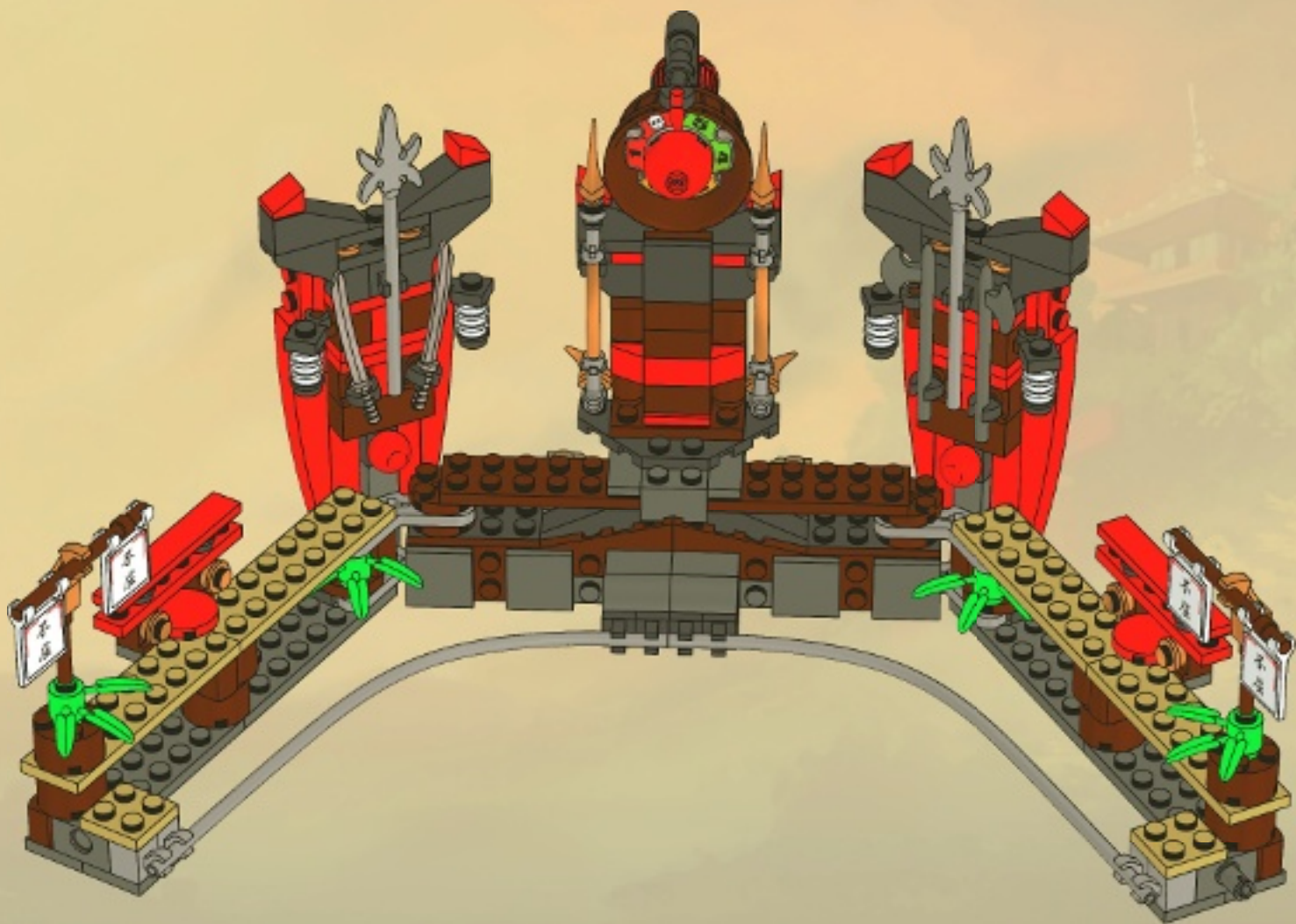



3x 366626
 4x 255526
 6x 4550017
 8x 614126
 1x 241926
 1x 4538456
 1x 4114206
 5x 4289538
 1x 4156150
 6x 4121715
 1x 4140801
 4x 4187931
 4x 4114348
 1x 4619747

2x 4211200
 2x 4211220
 8x 4225469
 4x 4225823
 9x 4211180
 2x 4211181
 4x 4211183
 6x 4211166
 2x 4211221
 1x 4211190
 5x 4211186
 3x 4211247
 1x 4205469
 1x 4205470

3x 4211151
 8x 4211159
 1x 4541875
 4x 4538724
 4x 4535764
 4x 4262978
 2x 4539481
 2x 4600518
 2x 4520991
 2x 4520320
 1x 4211639
 14x 614101
 4x 4523403
 2x 4616561

2x 4514198
 2x 4211060
 2x 4211105
 1x 4211046
 8x 4211111
 2x 4211093
 4x 4211052
 4x 4211055
 2x 4211094
 4x 4211001
 4x 4210997
 1x 4278274

2x 4506846
 1x 4560177
 10x 4523159
 2x 4600267
 4x 4611904
 2x 4612900
 1x 4544529
 2x 4505141
 6x 4117070
 2x 4114084
 4x 4113988
 12x 4619814
 6x 4619707
 12x 4619711

1x 4620536
 1x 4621280
 1x 4610824
 2x 300126
 2x 4533771
 4x 654126
 2x 366526
 8x 428626
 4x 4581280
 14x 302326
 1x 503626
 4x 362326

2x 4558886
 6x 403221
 3x 415021
 1x 4612108
 1x 4216657
 4x 4179355
 2x 4290714
 1x 4227155
 8x 4504379
 2x 306921
 4x 362321
 1x 4568388

2x 302121
 5x 371021
 2x 4113858
 2x 366621
 2x 4565431
 1x 4157223
 5x 4192225
 4x 4571075
 1x 4611427
 12x 4143005
 4x 4514553

Customer Service
Kundenservice
Service Consommateurs
Servicio Al Consumidor
www.lego.com/service or dial
 : 00800 5346 5555
 : 1-800-422-5346





NINJAGO

Masters of Spinjitzu



2505



2504



2263



2260





NINJAGO

Masters of Spinjitzu

NINJAGO.COM



JAY

KAI

ZANE

COLE

NYA

SENSEI WU

ZANE DX

FRAKJAW

KRAZI

CHOPOV

GARMADON

BONEZAI

NUCKAL

SAMUKAI





NINJAGO

Masters of Spinjitzu



2111
2518
2520



2111
2113



2111



2112



2112
2259
2504
2505
2516
2520



2112



2113
2504
2505
2260



2113
2219
2257
2258
2263
2504
2505
2520



2114
2520



2114
2257
2504



2114
2257



2115



2115



2115
2505
2258



2116



2116



2116



2257



2257



2504
2257



2505
2263
2258



2505
2259
2520



2505



2504
2519



2516



2516



2259



2518



2519



2519



2520



2520



2504
2520



2520



NINJAGO

Masters of Spinjitzu



2111



2257



2112



2113



2114



2115



2116



NINJAGO
Masters of Spinjitzu



LEGO

NINJAGO
Masters of Spinjitzu



NINJAGO.COM

NINJAGO

THE BOARD GAME

3856



2-4



8+



15 - 25



www.LEGO.com/LEGOGames



UNIVERSE

www.LEGOuniverse.com



www.pegi.info

**MASSIVELY MULTIPLAYER ONLINE GAME
VIDEOJUEGO MULTIJUGADOR MASIVO EN LÍNEA
JEU EN LIGNE MASSIVEMENT MULTIJOUEUR
MEHRSPIELER ONLINE SPIEL
JOGO MULTIJOGADOR ONLINE EM MASSA
NAGYON SOK SZEREPLŐS ONLINE JÁTÉK**

Einstufung
ausstehend

USK

Rating pending



NINJAGO

Masters of Spinjitzu





www.LEGOclub.com



LEGO® Club Email

LEGO club™

FREE! GRATIS! GRATUIT!



LEGO® Club Magazine

SIGN UP ONLINE!

www.LEGOclub.com



00800 5346 5555*



1-866-534-6258 • 1-877-518-5346

US & Canada only

Canada seulement

* Freephone. Mobile charges may apply.
* Numéro sans frais. Des frais peuvent s'appliquer avec les téléphones cellulaires.
* Gebührenfrei, Kosten für Anrufe aus Mobilfunknetzen können abweichen.
* Gratis telefonnummer vanaf vaste lijn.
* Det er et gratis nummer, når du ringer fra fasttelefon.
* Det är gratis, när du ringer från en fast telefon.
* Numéro sans frais. Des frais peuvent s'appliquer avec les téléphones portables.



WIN!

Go to www.LEGOsurvey.com/product to fill out a survey for a chance to win a cool LEGO® Product. No purchase necessary. Open to all residents where not prohibited.

 www.LEGO.com



www.LEGOsurvey.com/product

GEWINNE! WIN!

Nimm an der Umfrage auf www.LEGOsurvey.com/product teil und hab die Chance ein cooles LEGO® Produkt zu gewinnen!
Die Teilnahme am Gewinnspiel führt zu keinerlei Kaufverpflichtungen. Teilnahme in allen nicht ausgeschlossenen Ländern möglich.

Ga naar www.LEGOsurvey.com/product, vul een enquêteformulier in en maak kans op een cool LEGO® product.
Geen aankoopverplichting. Iedereen mag deelnemen, uitgezonderd ingezetenden van landen waar een enquêteverbod geldt.

GAGNE! 当てよう!

Visite www.LEGOsurvey.com/product pour répondre à un questionnaire et avoir une chance de gagner un produit LEGO® très cool!
Aucune obligation d'achat. Ouvert à tous les résidents des pays autorisés.

www.LEGOsurvey.com/product にアクセスして、アンケートにご記入ください。当選者にはレゴ®製品を差し上げます。
お買い上げの必要はありません。
禁止されていない限り、すべての皆様にご利用いただけます。