



THE LEGO MOVIE

30528



6268293



THE LEGO MOVIE

LEGO.com/movie2

LEGO.com/service

THE LEGO® MOVIE 2™ © & ™ Warner Bros. Entertainment Inc. & The LEGO Group. LEGO, the LEGO logo, DUPLO, the Minifigure and the Brick and Knob configurations are trademarks and/or copyrights of the LEGO Group.

©2019 The LEGO Group. All rights reserved. WB SHIELD: TM & © WBEI. (s19) 6268293

1

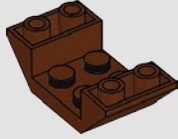

2

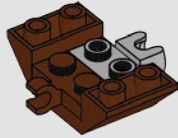

3

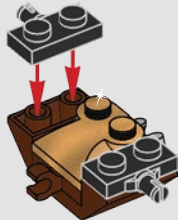

4

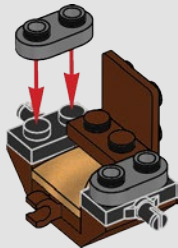

5

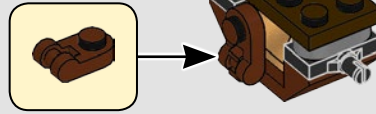

6

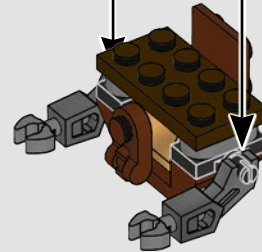

7

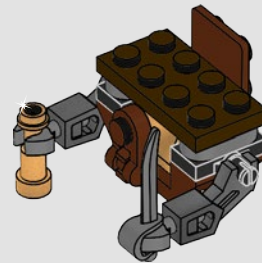

8

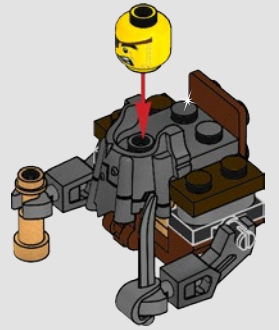

9

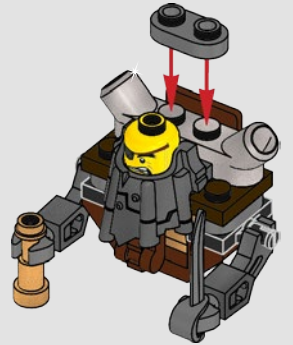

10

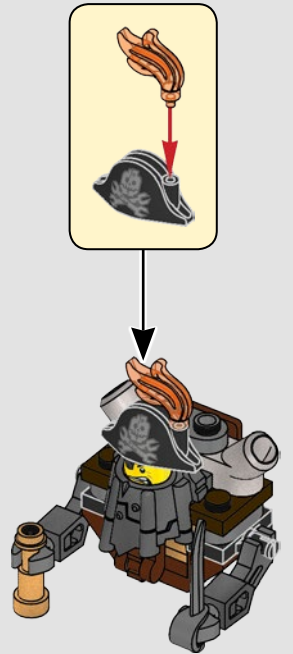

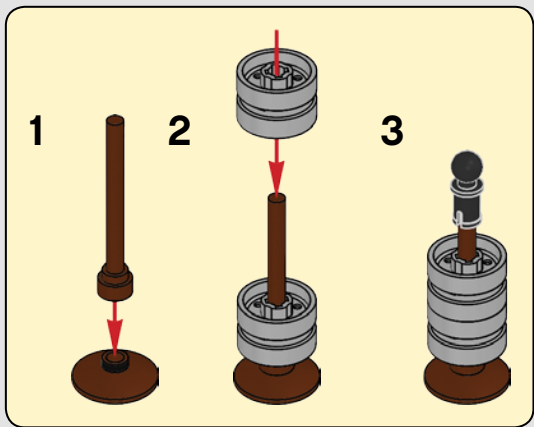

11

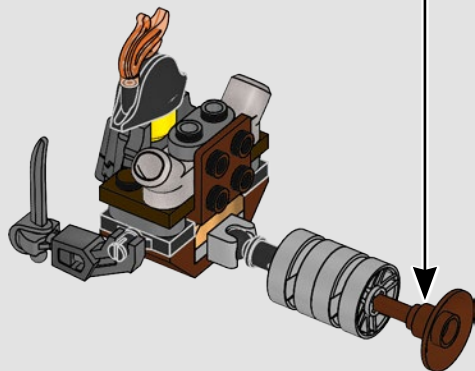

12

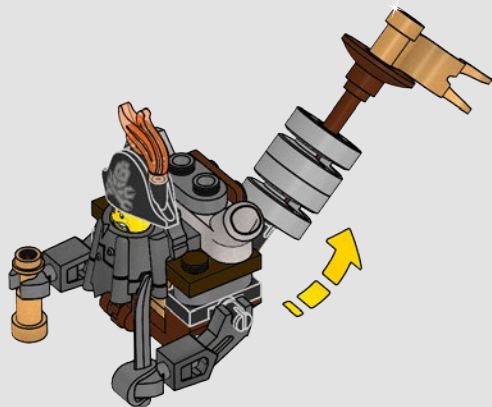

13

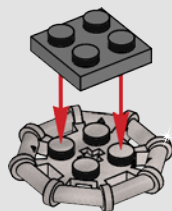

14

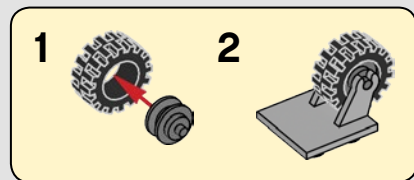
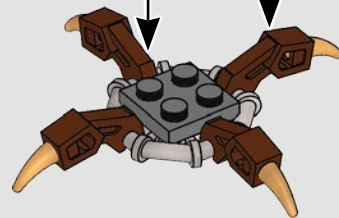

15

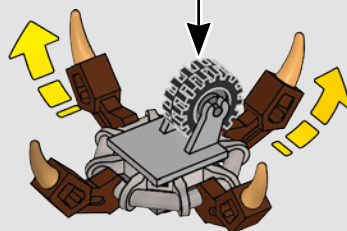

16

