

3  
IN  
1

# CREATOR



31065



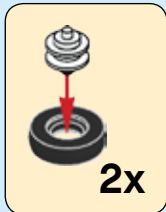
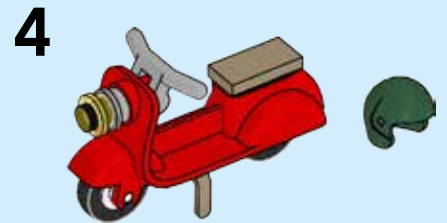
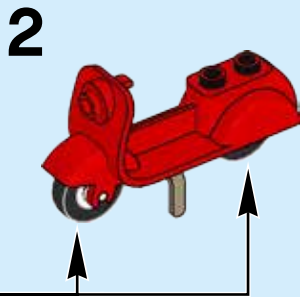
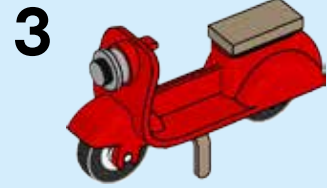
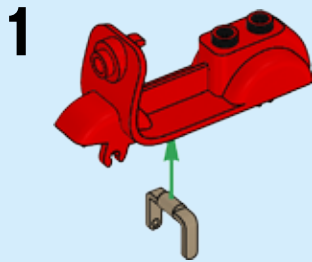
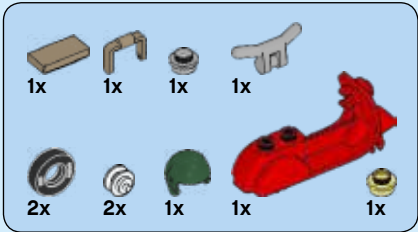
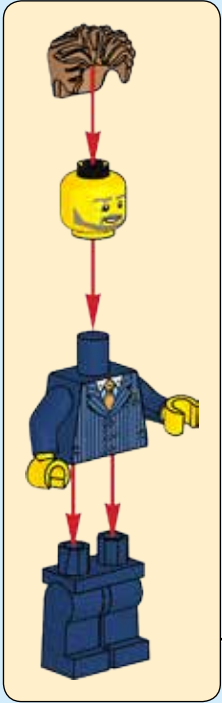

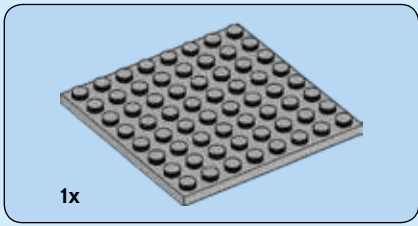

1

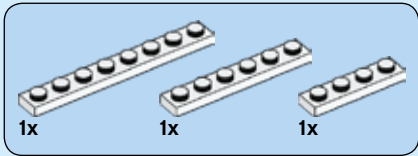
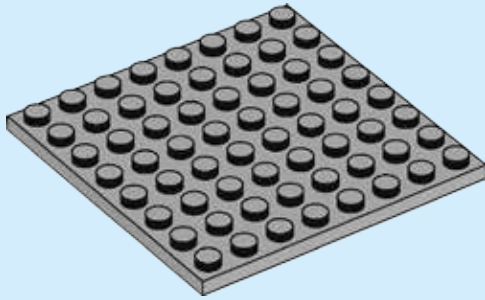

2

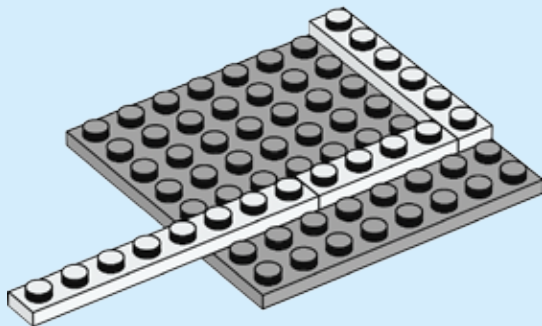

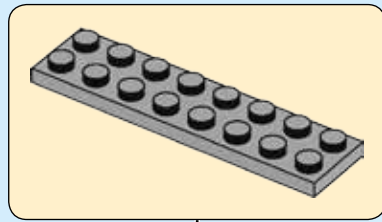
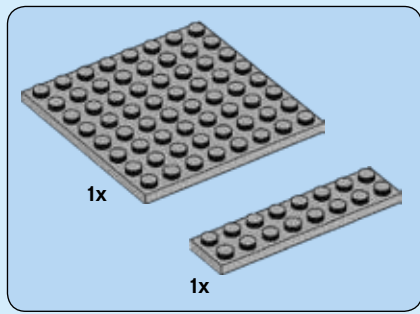

3

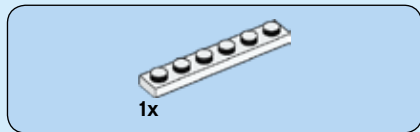
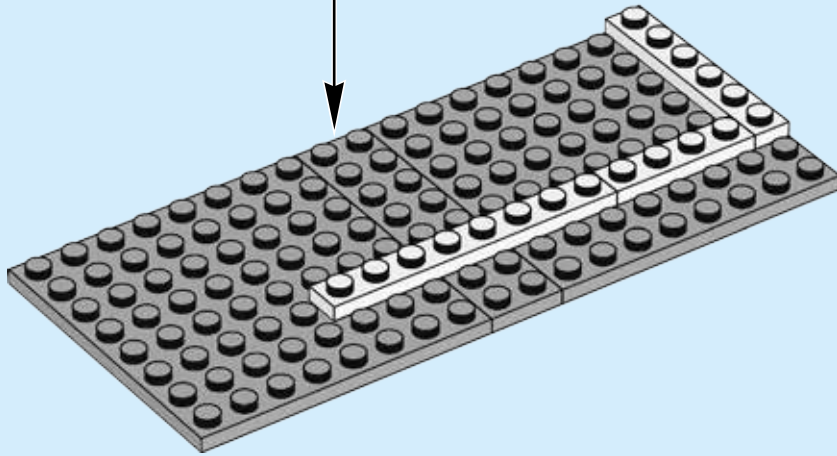

4

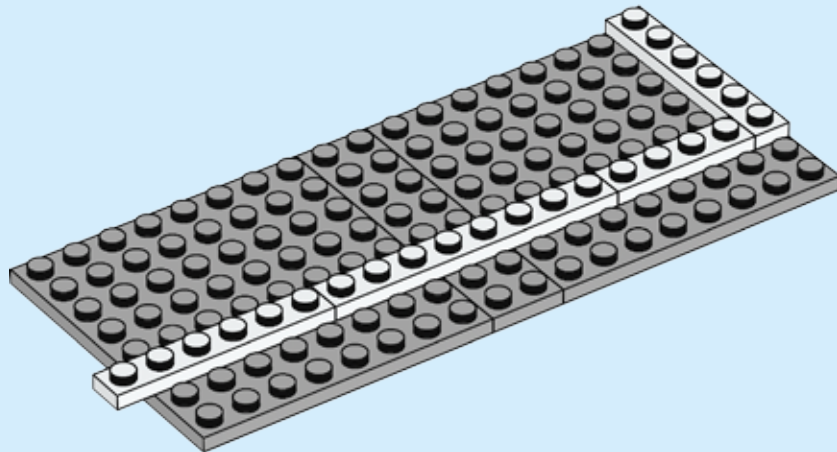

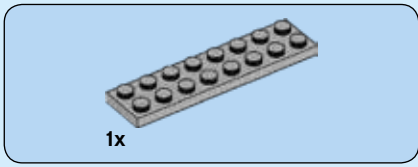

5

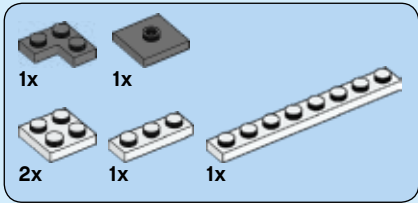
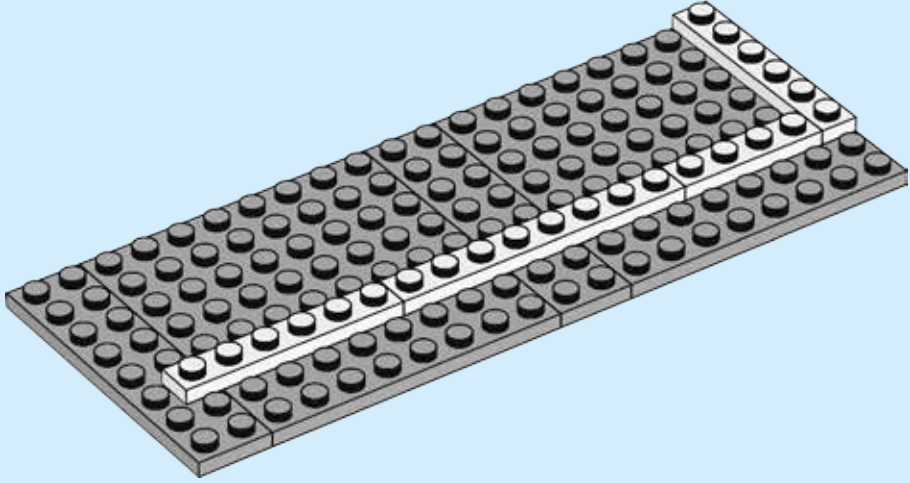

6

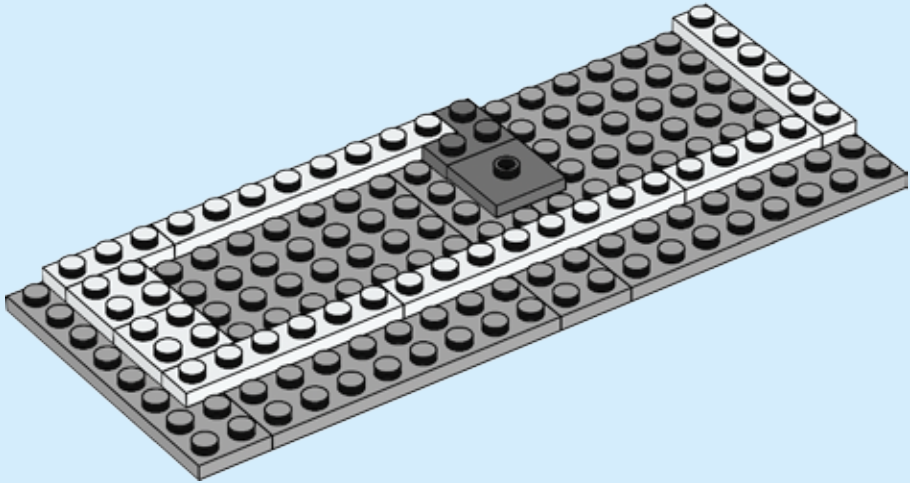

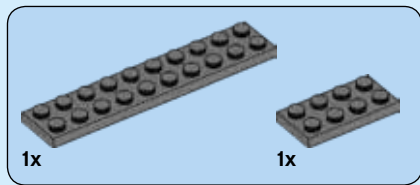

7

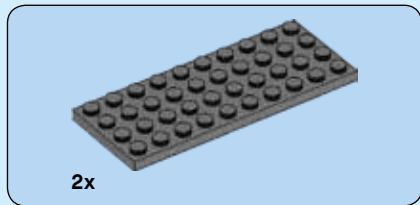
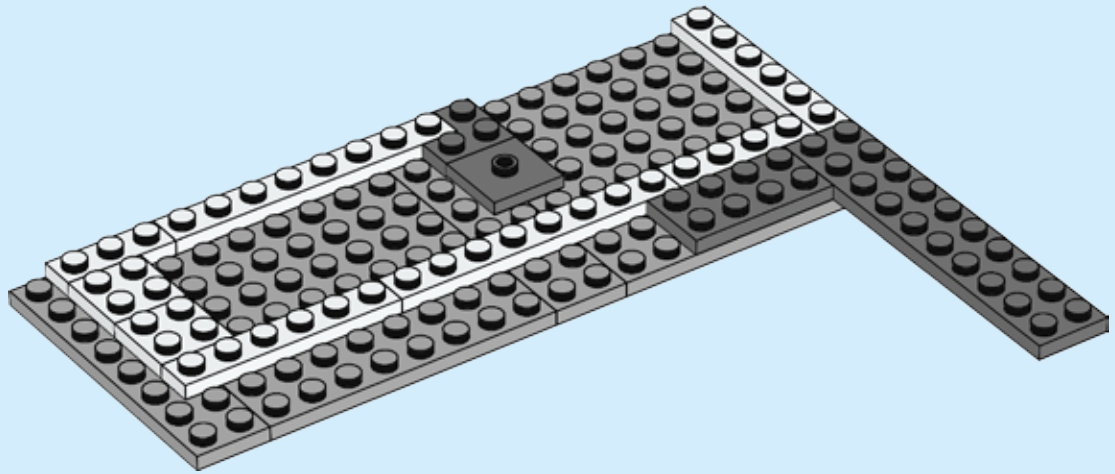

8

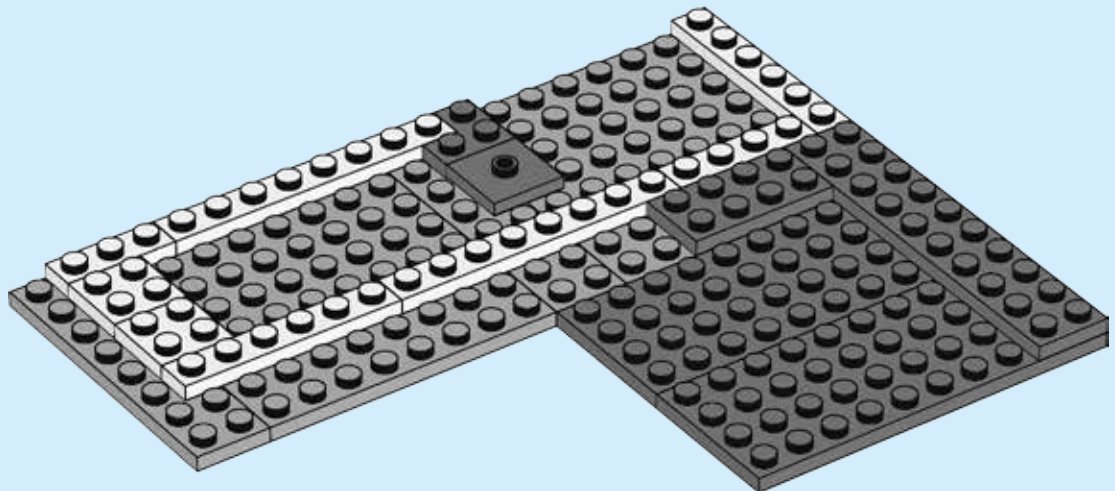

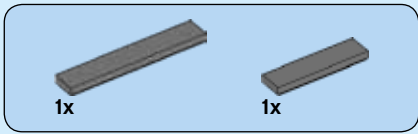

9

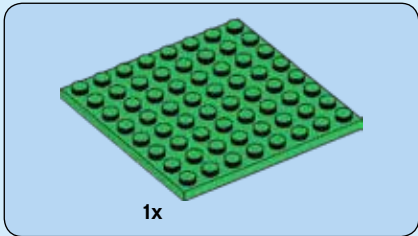
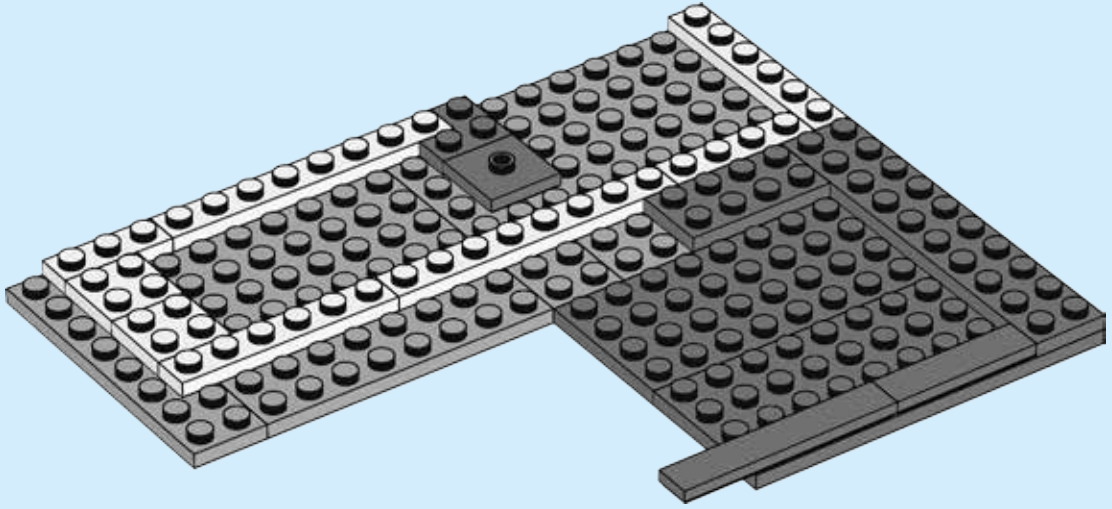

10

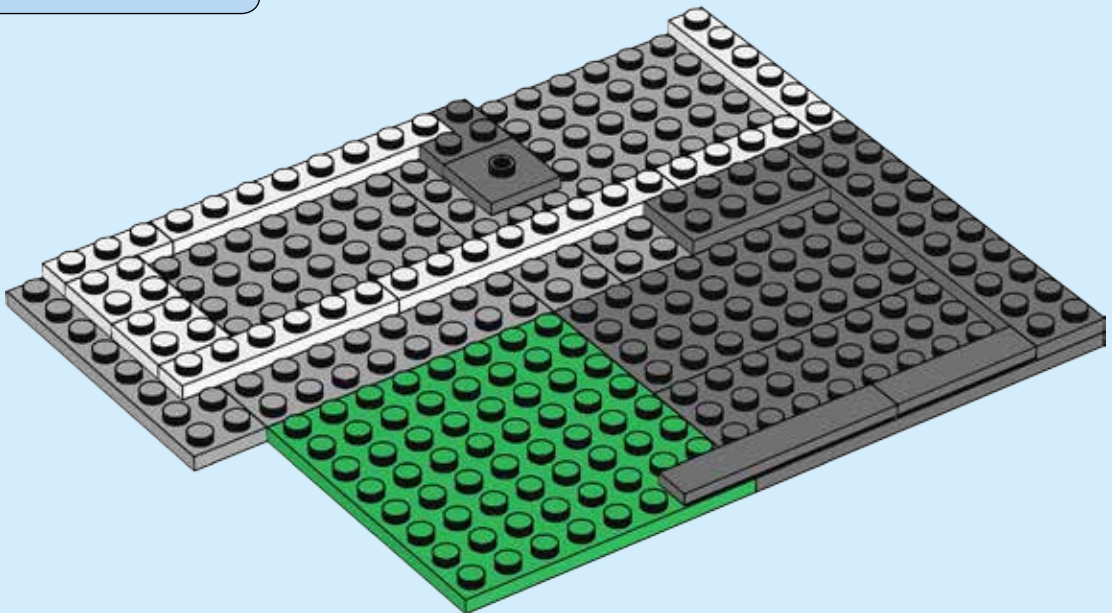



11

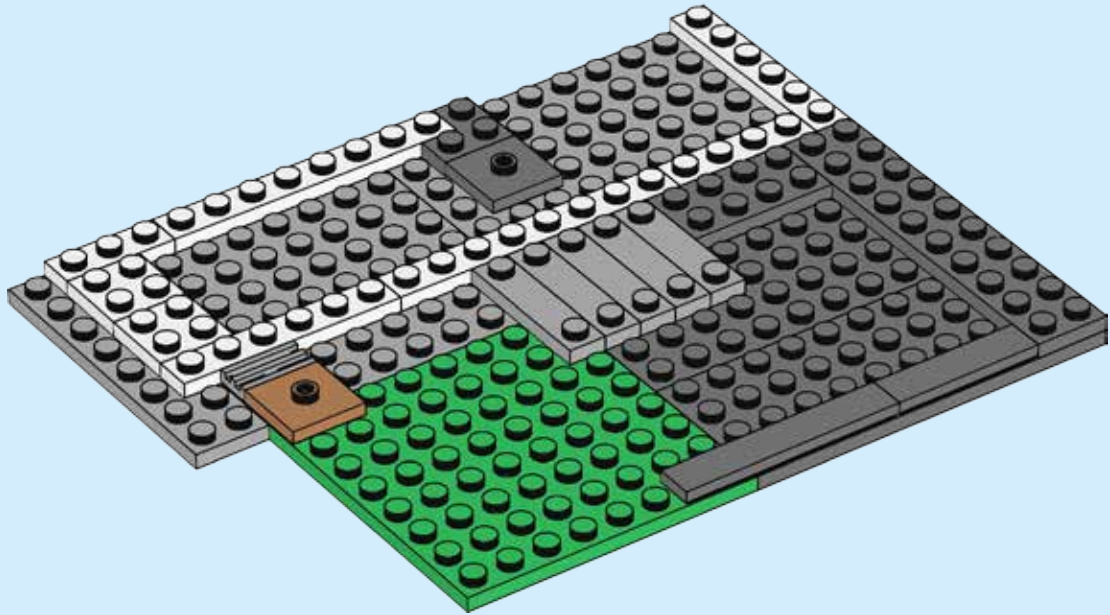



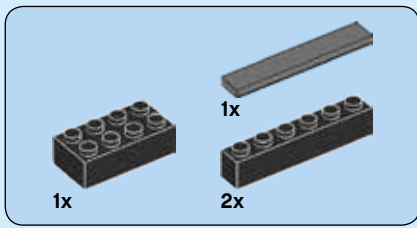

12

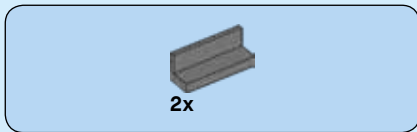
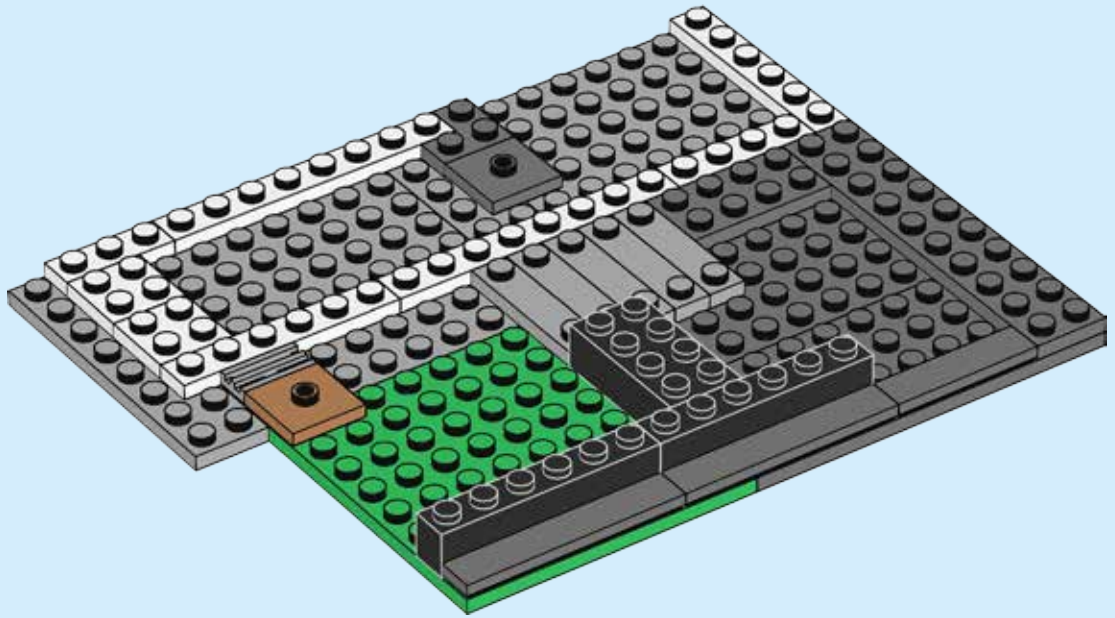

13

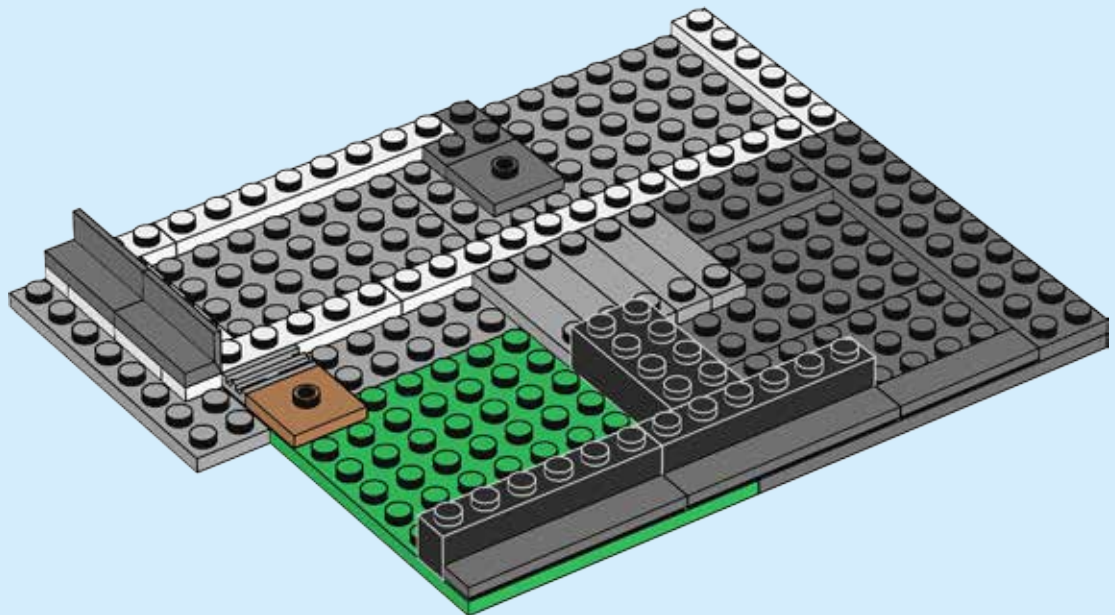

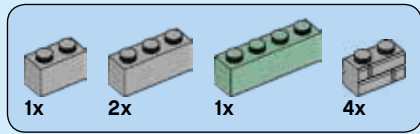

14

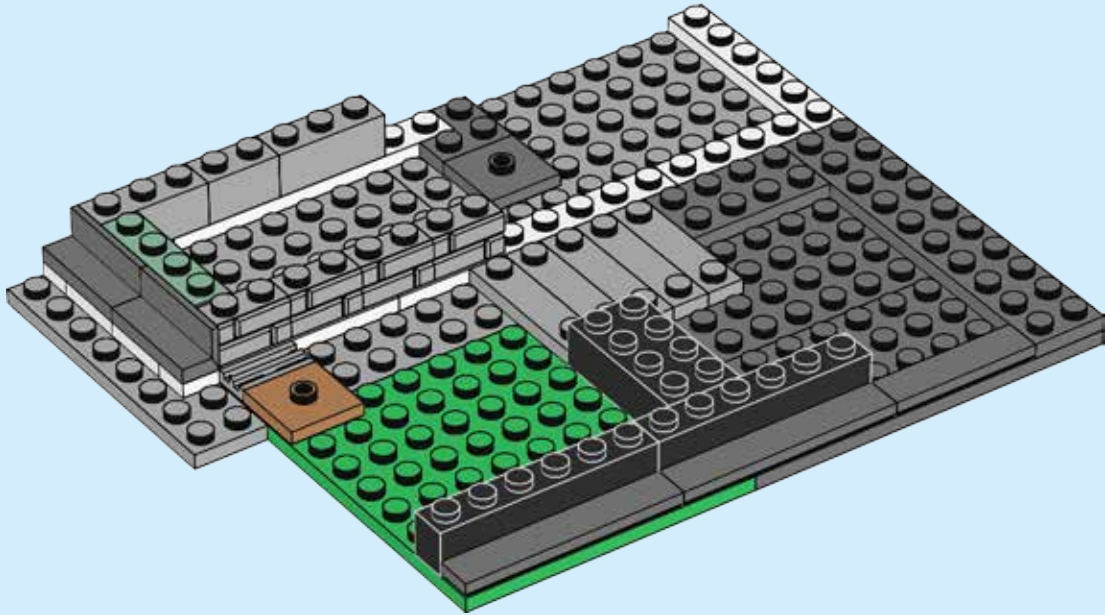

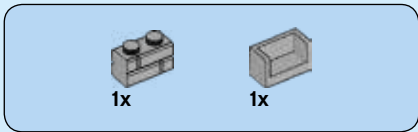

15

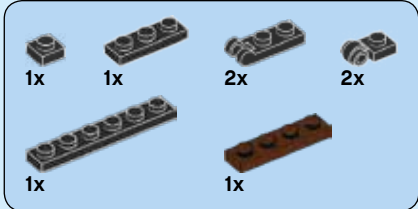
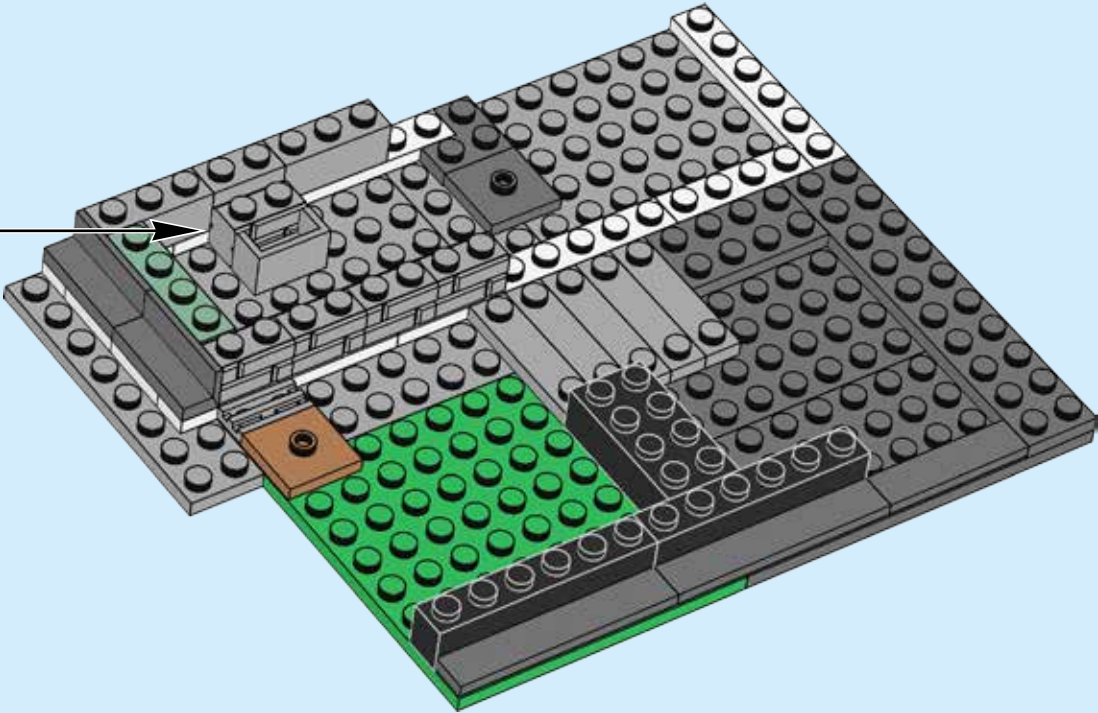
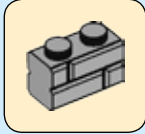

16

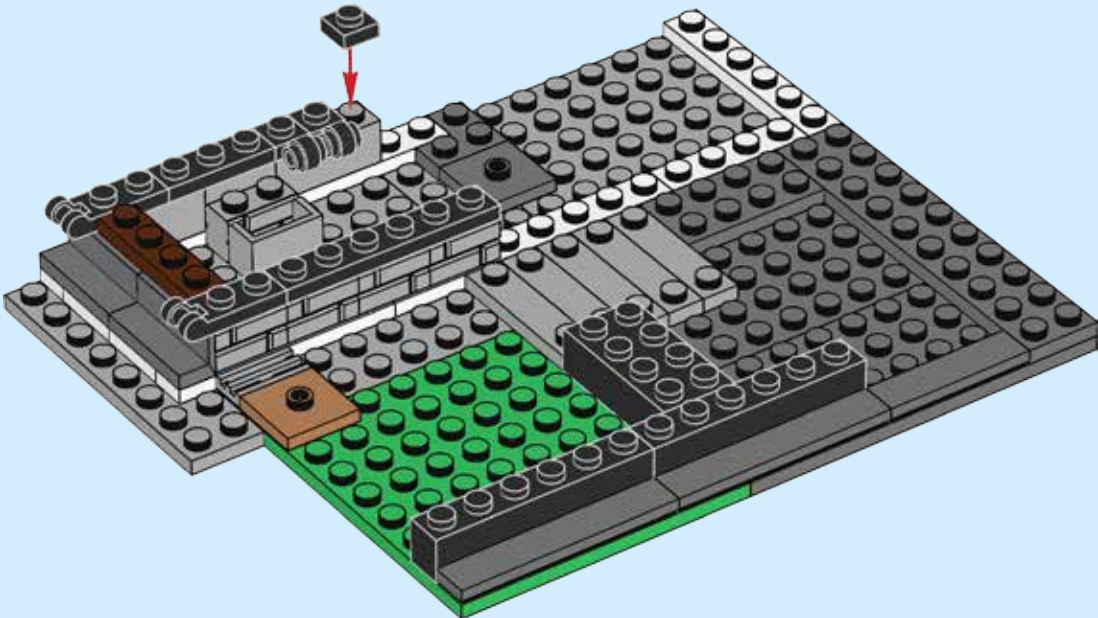



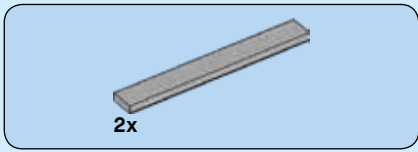

18

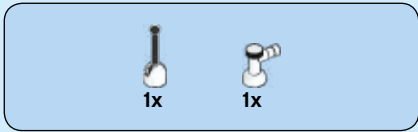
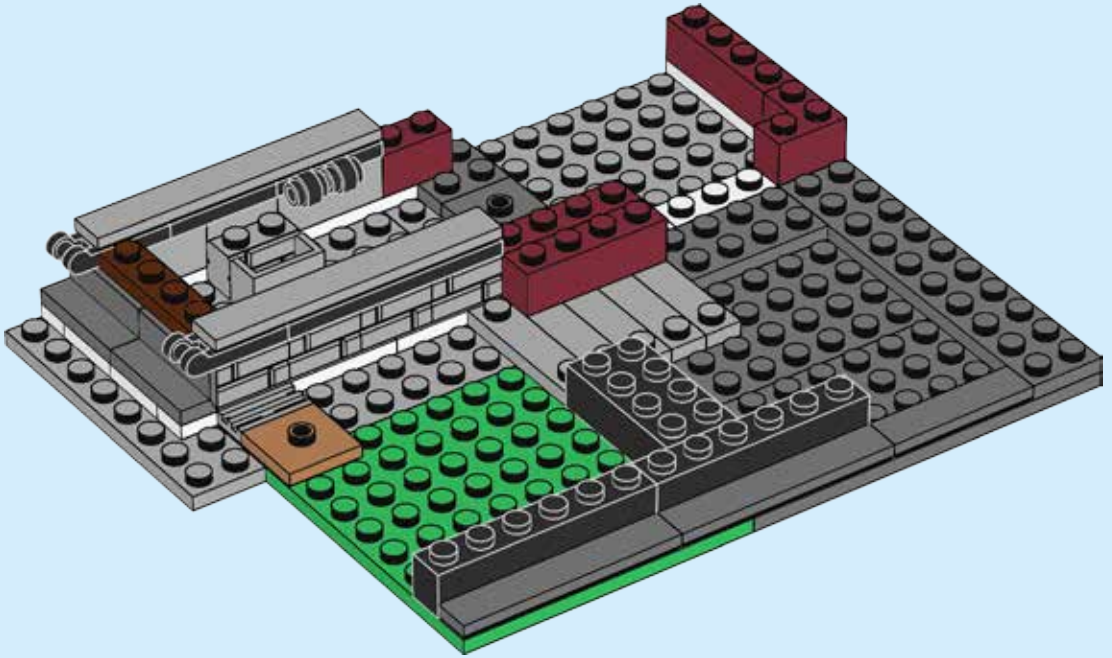

19

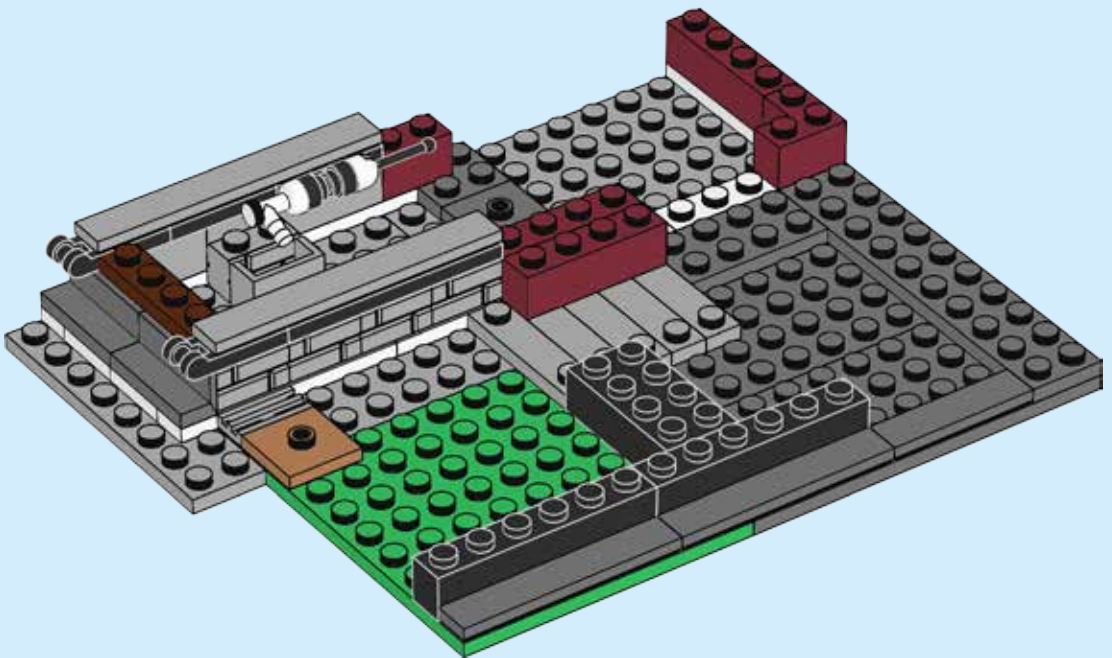

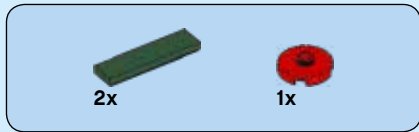

20

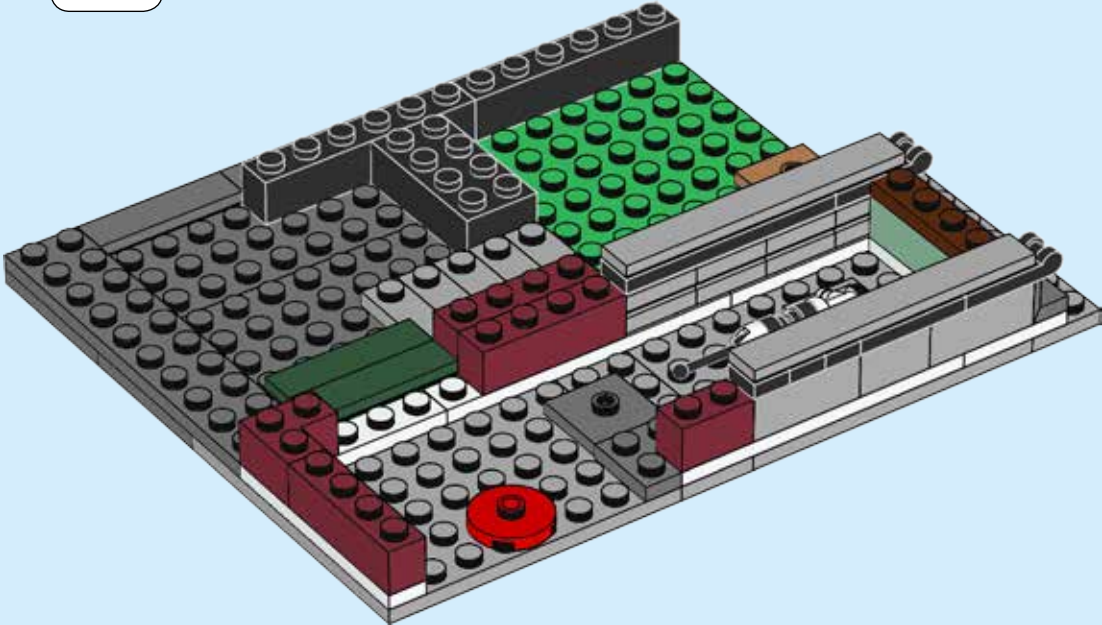
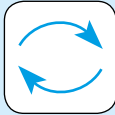

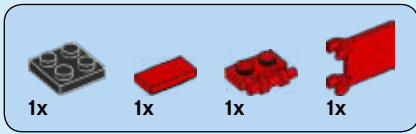

# 21

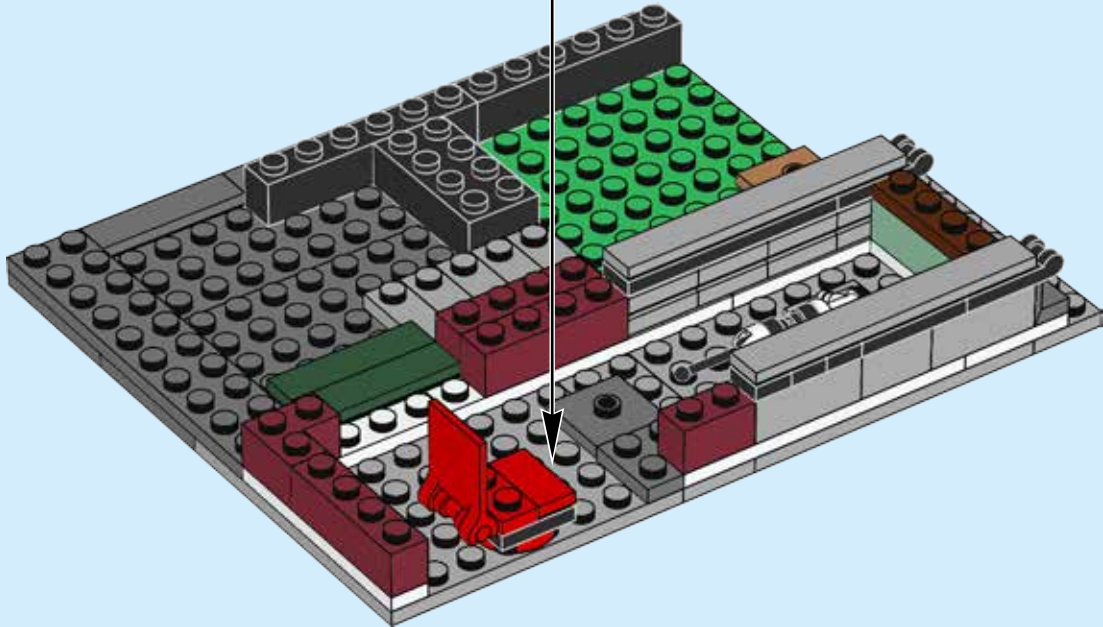





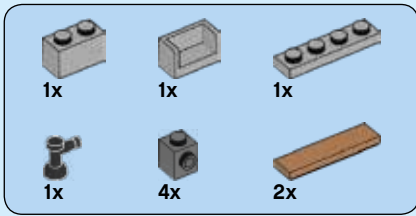

# 23

1

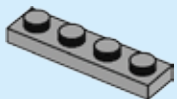

2

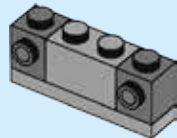

3

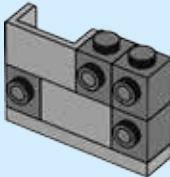

4

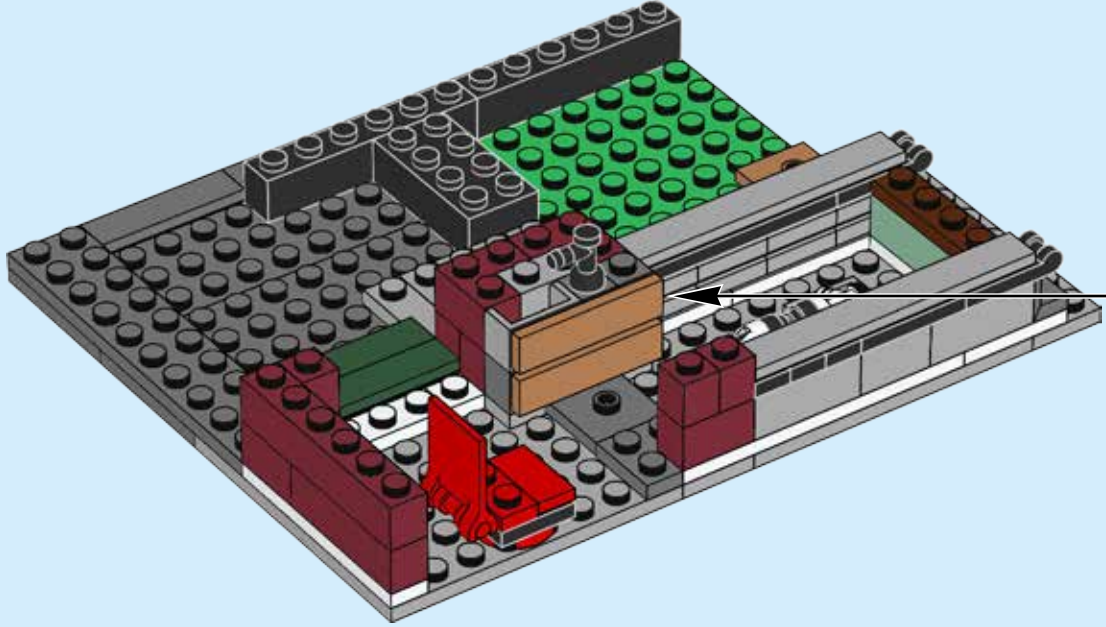
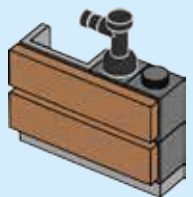

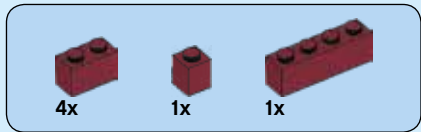

# 24

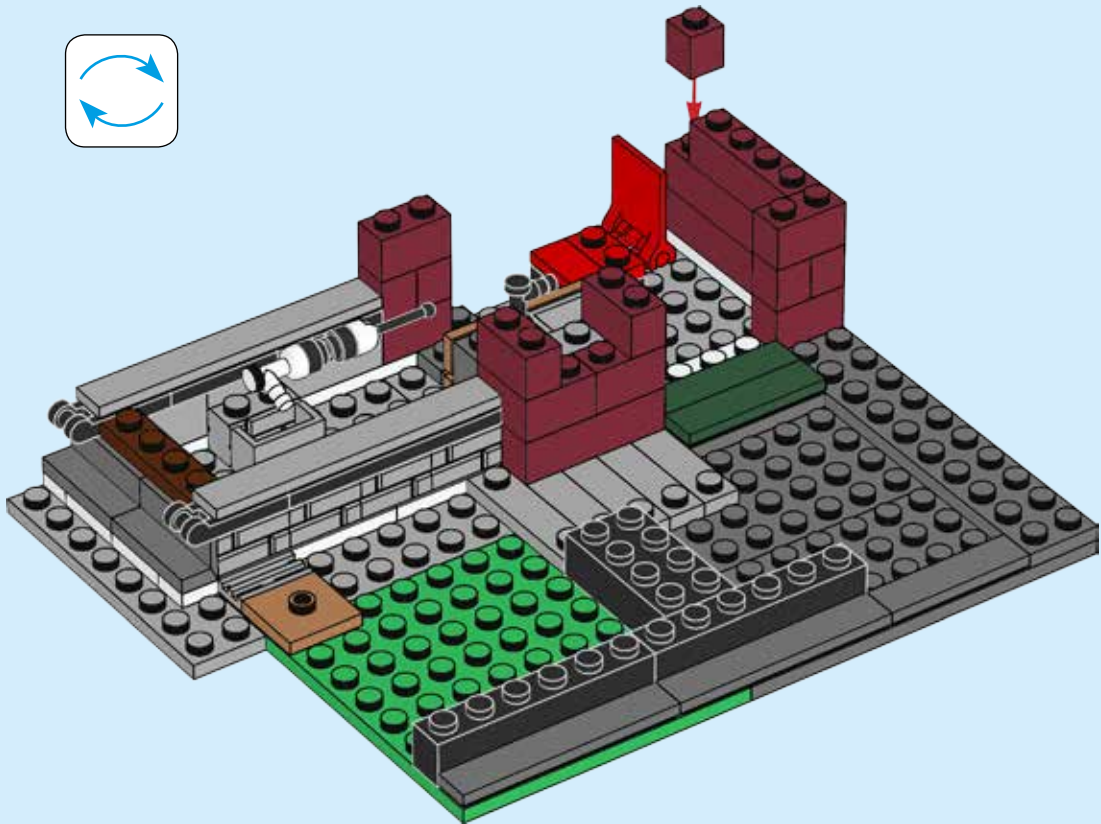
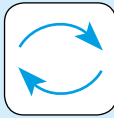

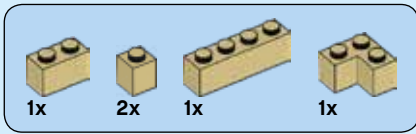

25

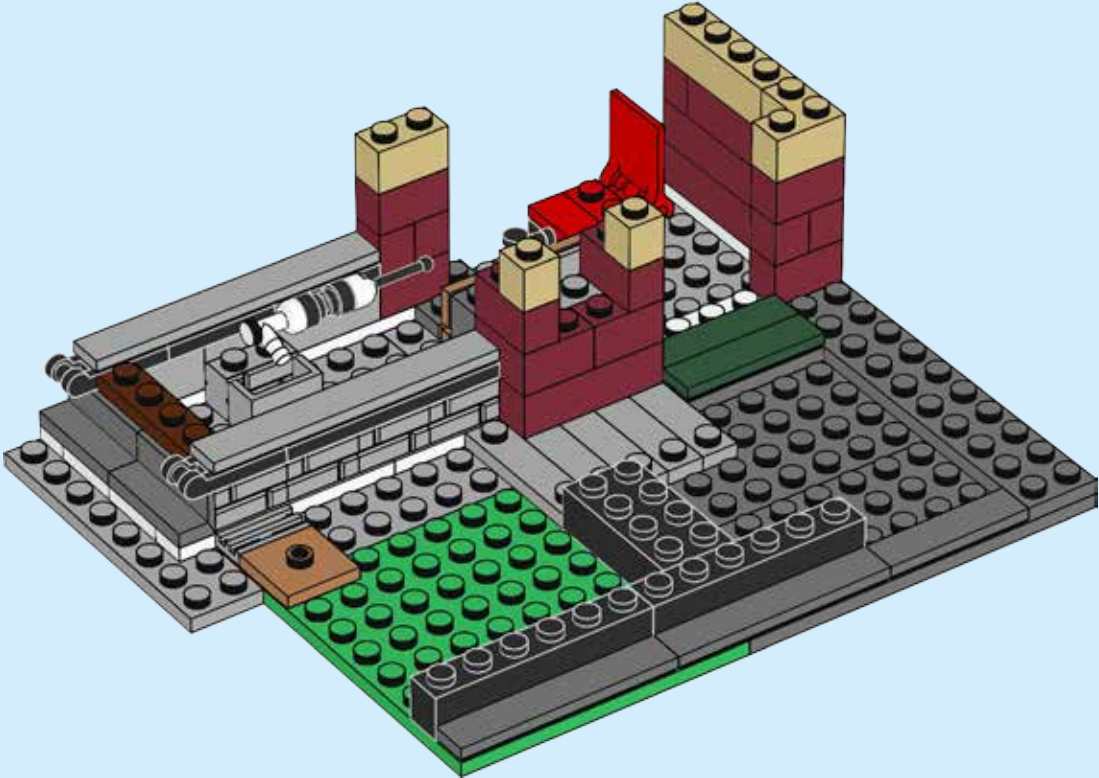

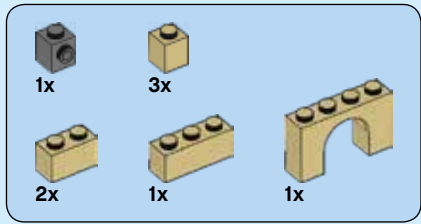

26

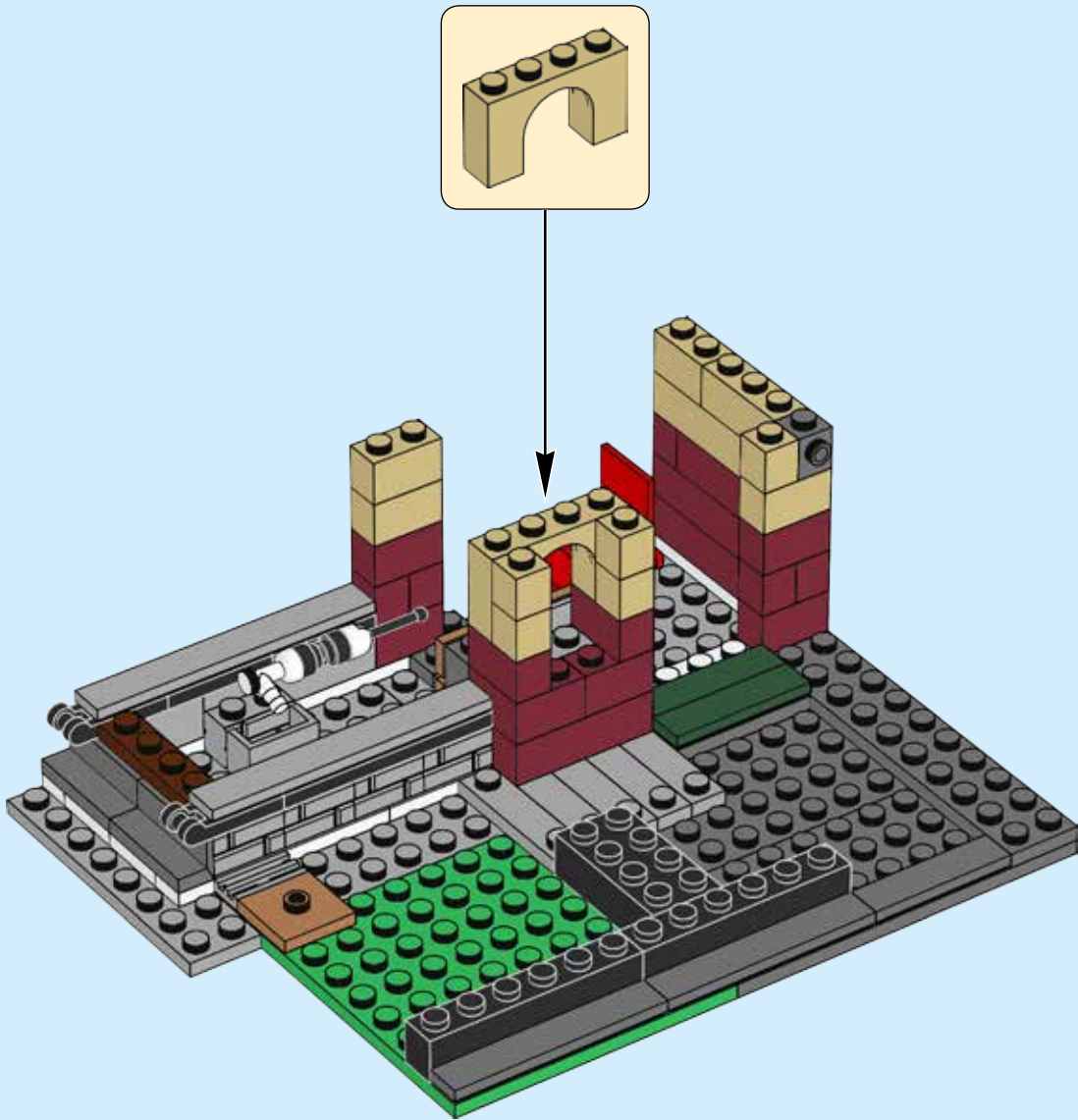

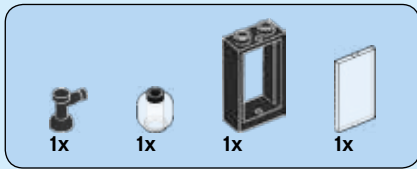

27

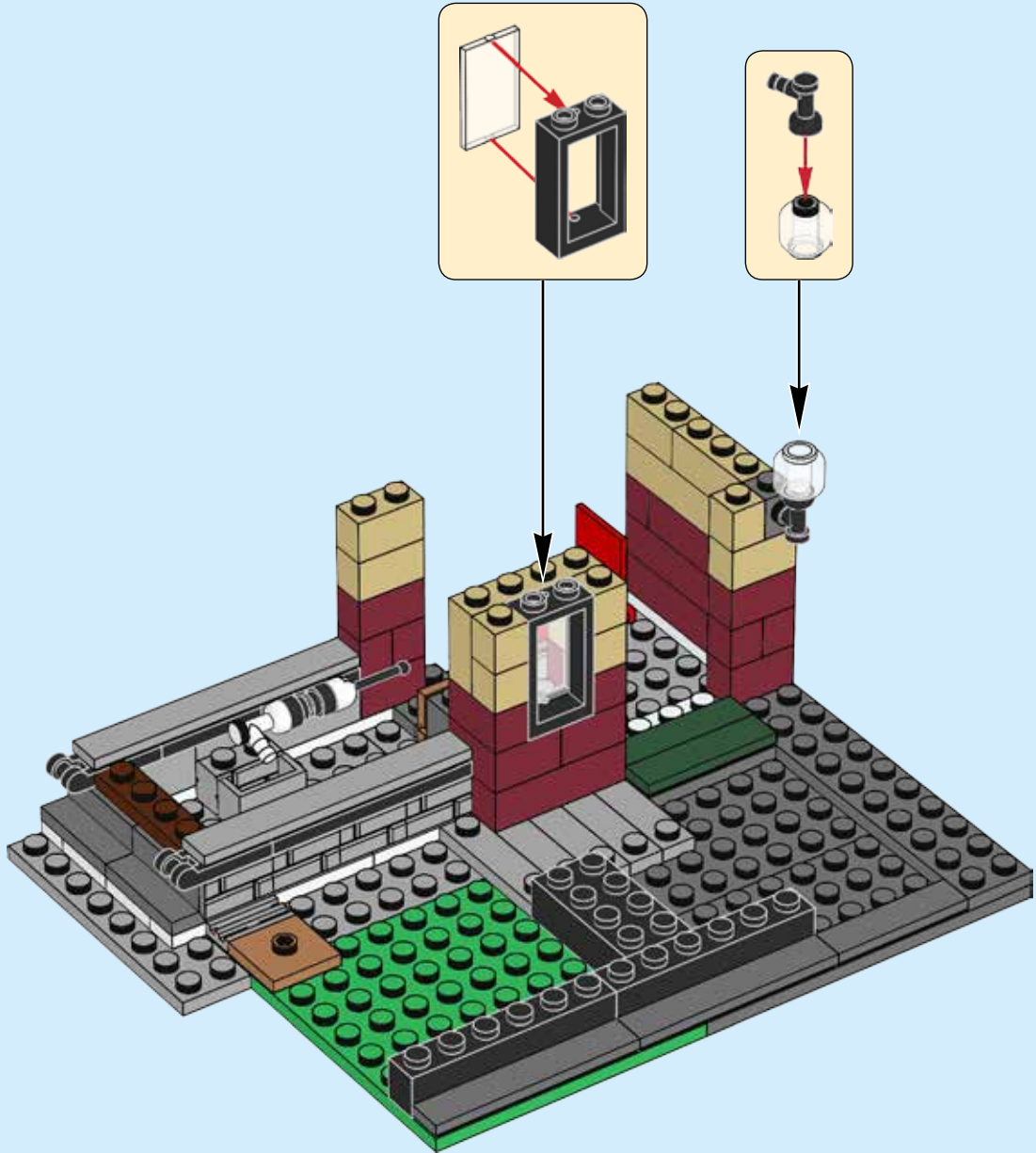

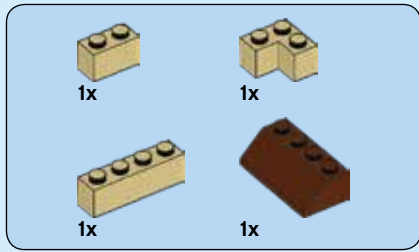

28

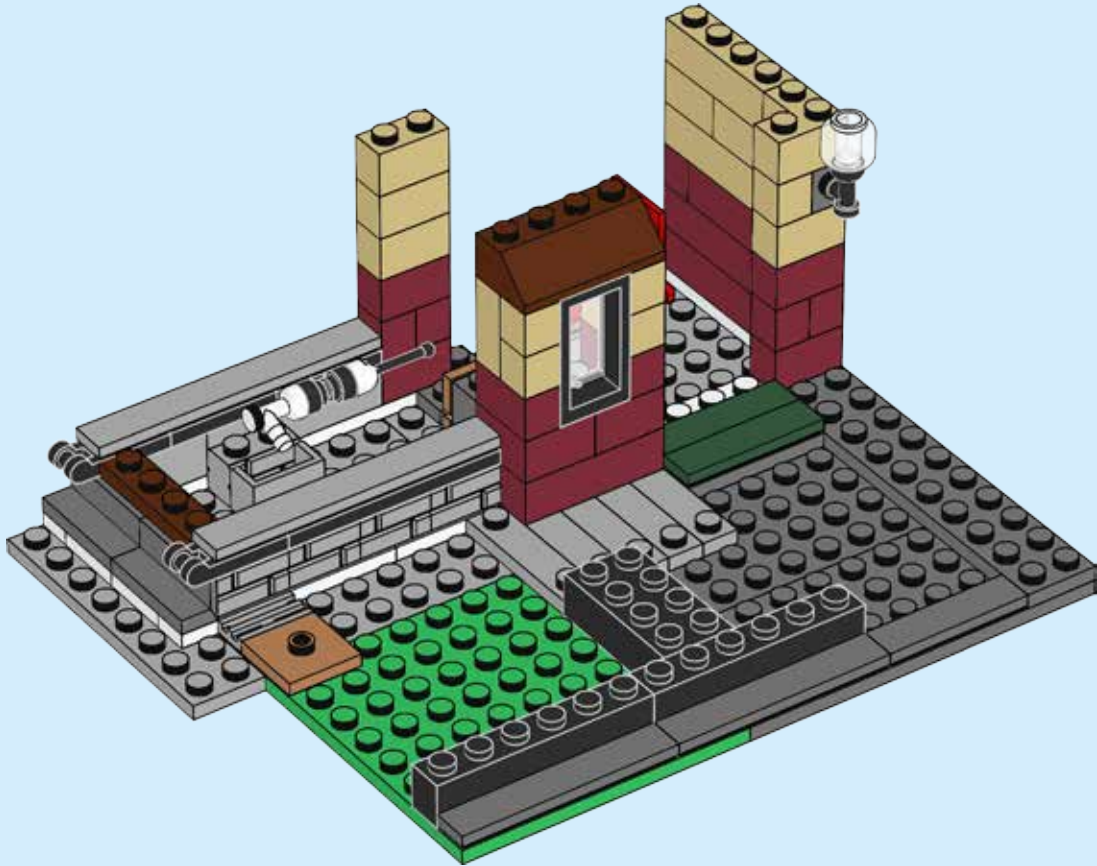

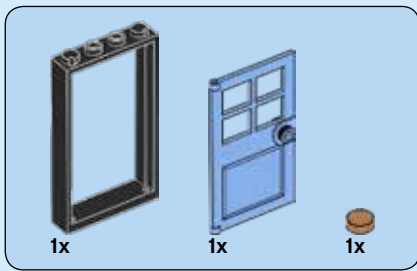

29

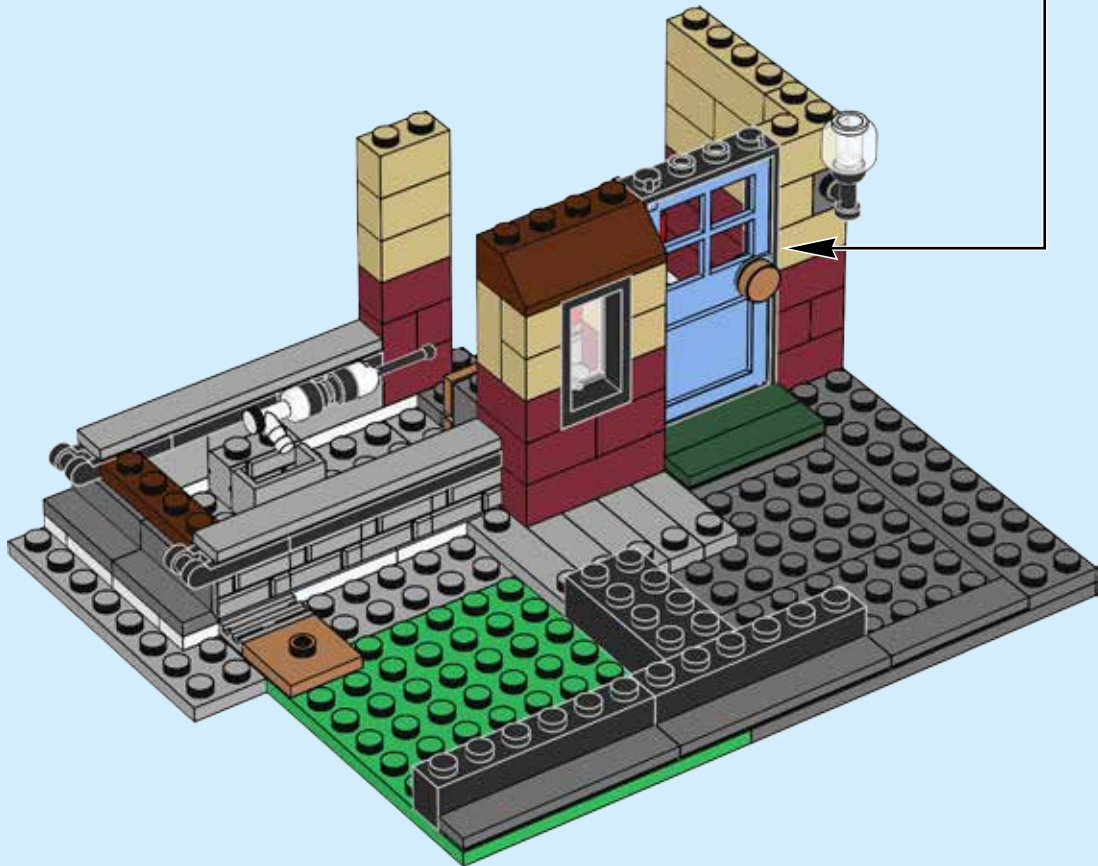
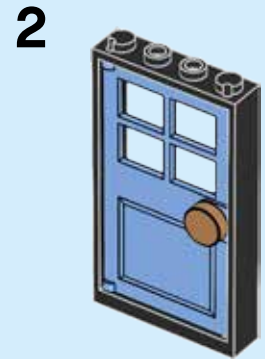
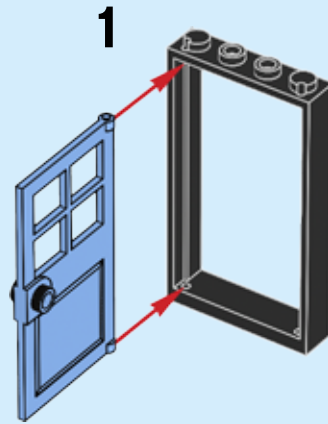







3x



1x

31

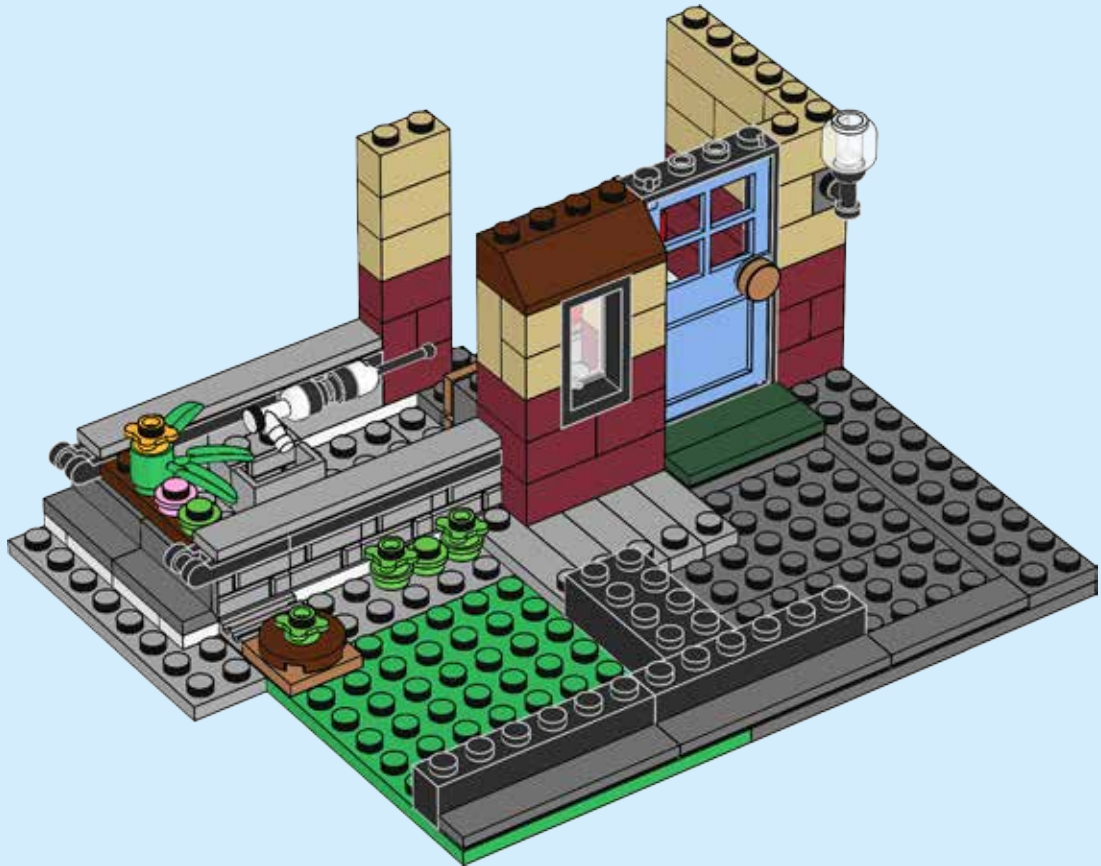

2x

2x

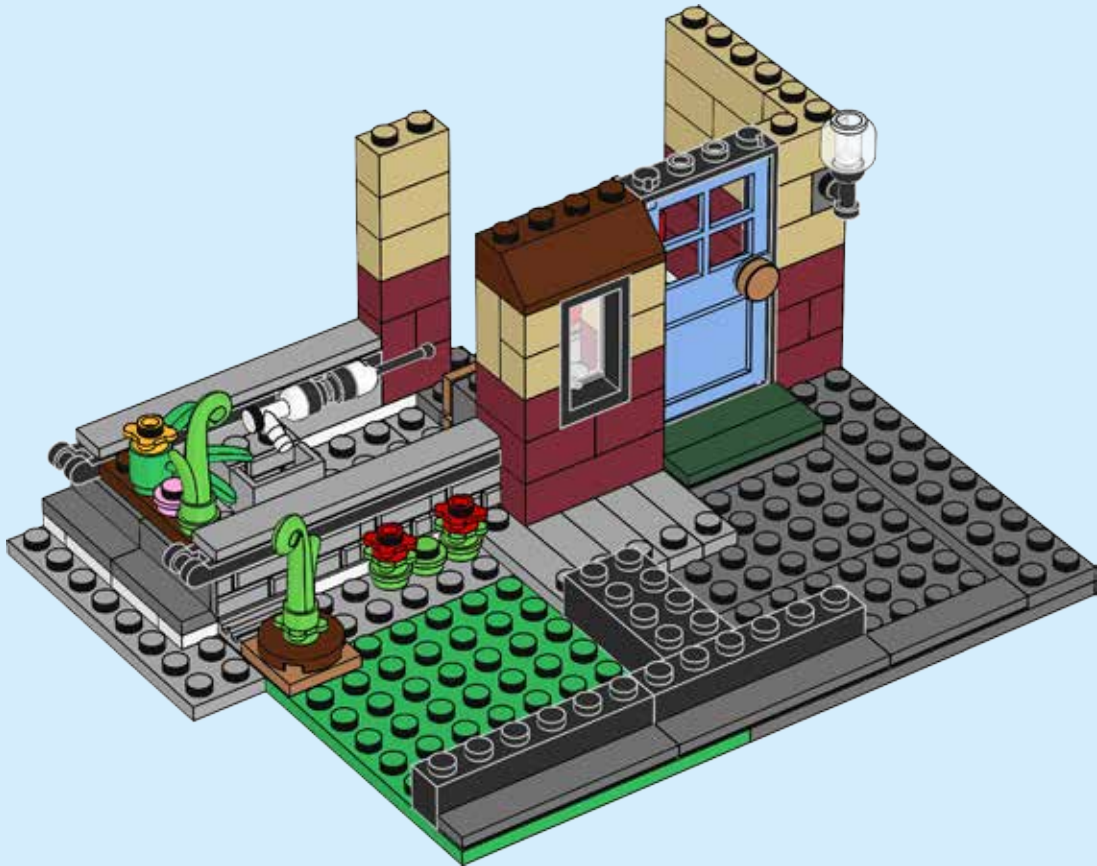

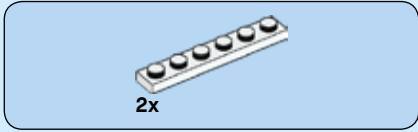
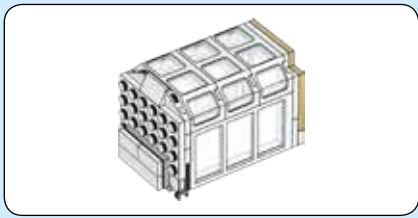

**33**

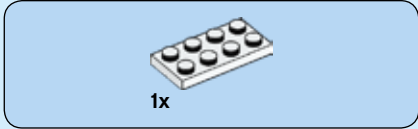
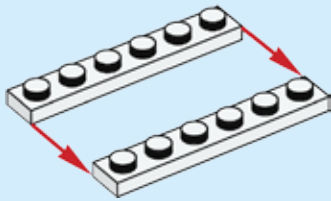

**34**

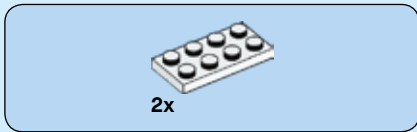
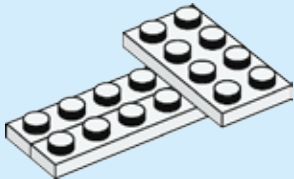

**35**

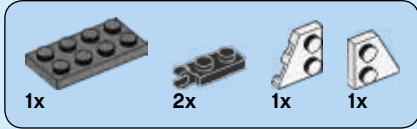
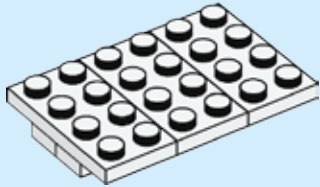

**36**

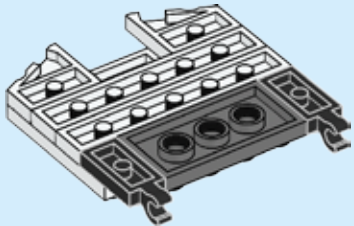
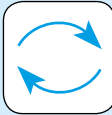

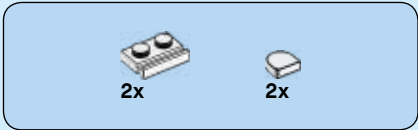

37

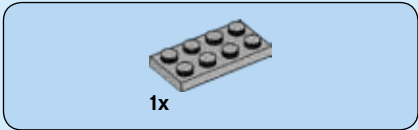
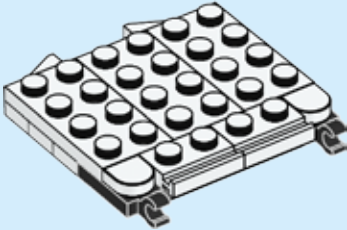
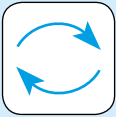

38

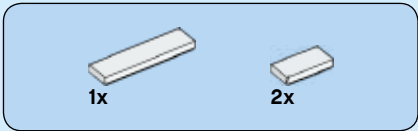
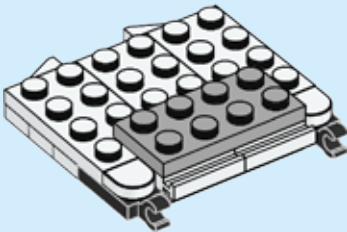

39

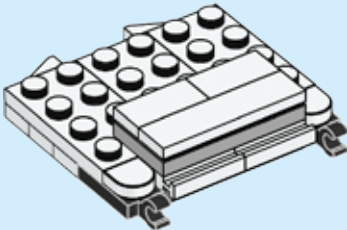

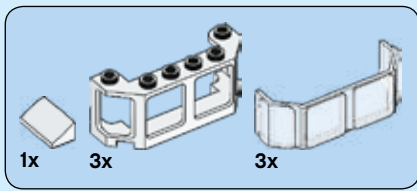

40

1

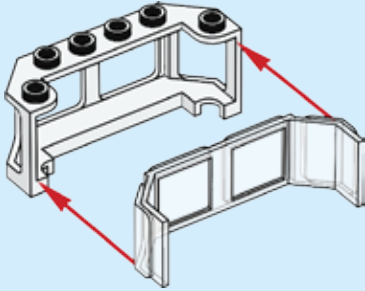

2

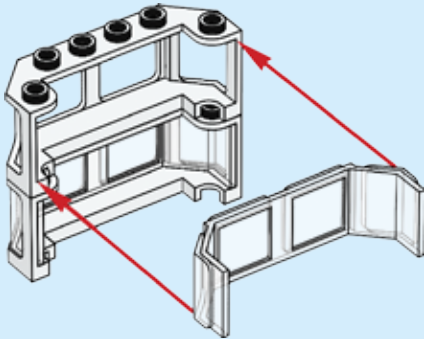

3

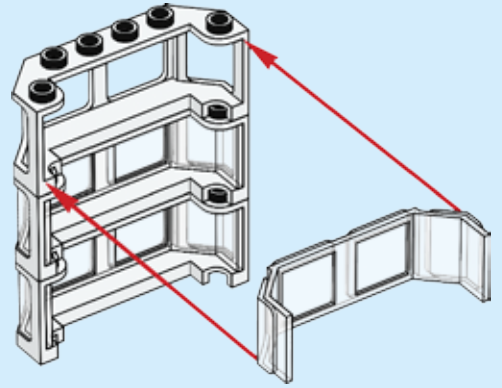

4

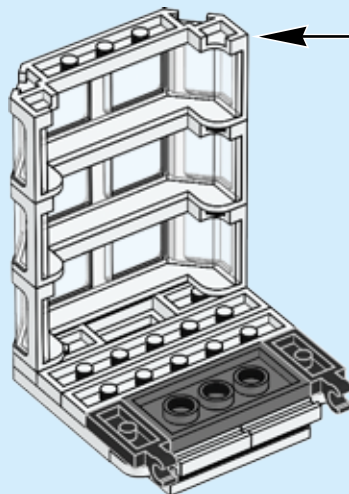
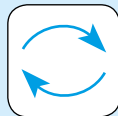
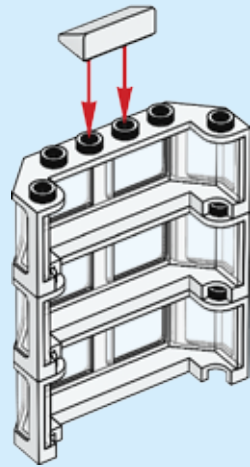

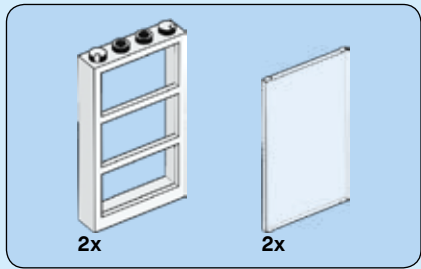

41

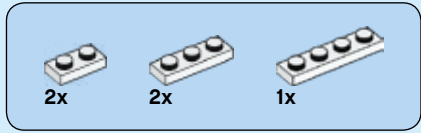
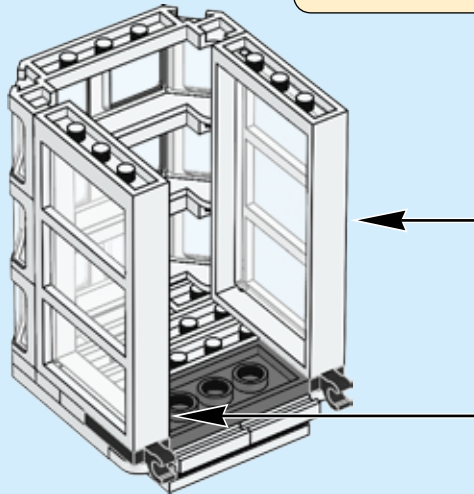
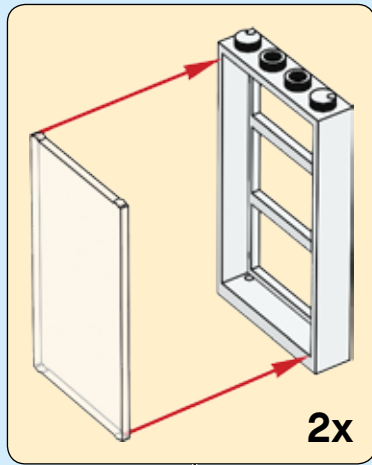

42

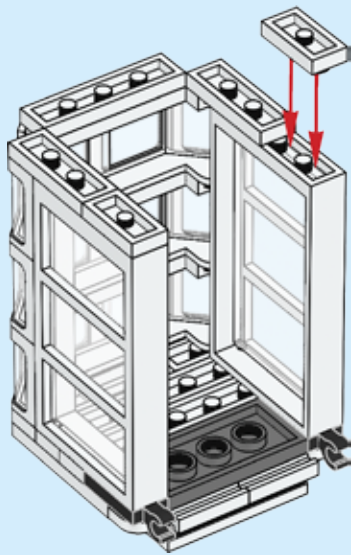

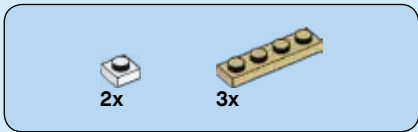

43

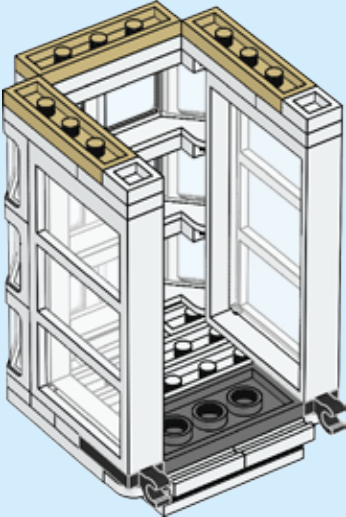

44

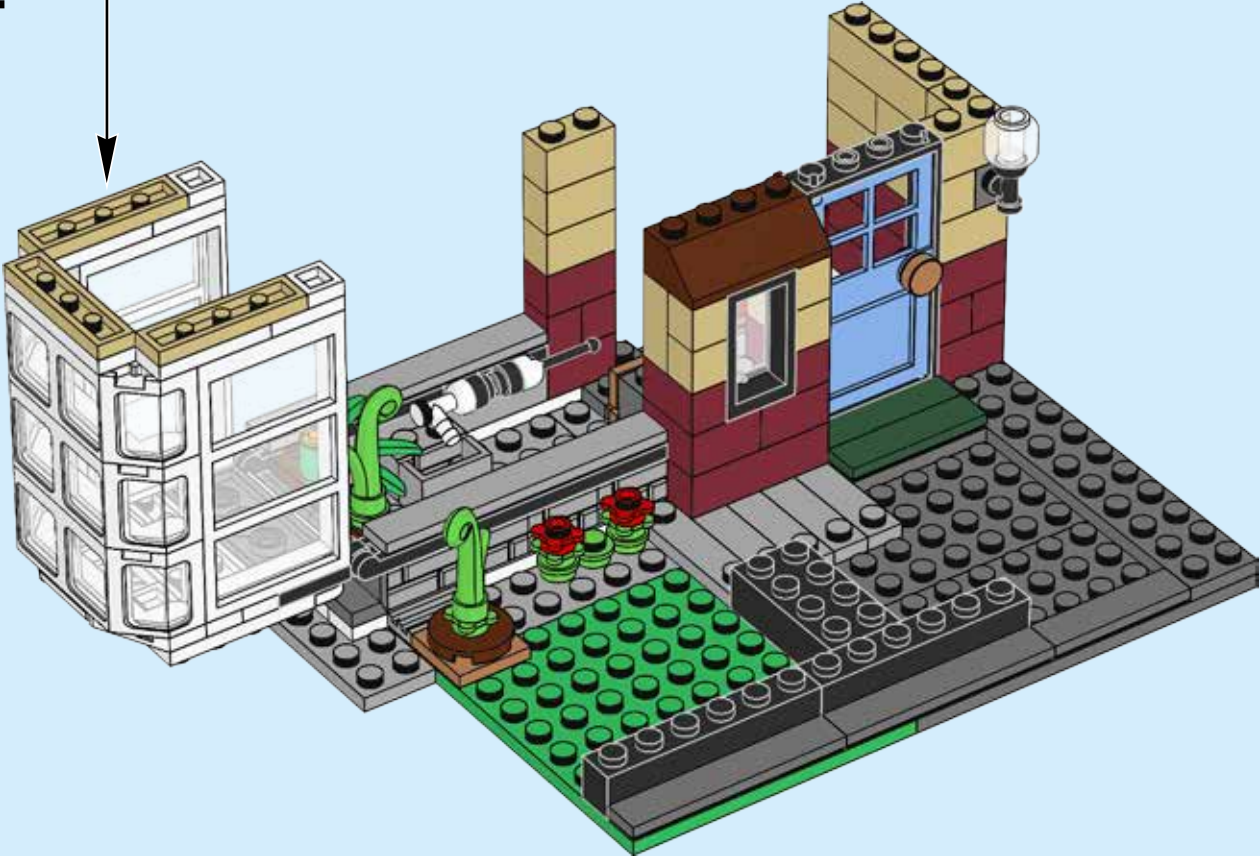

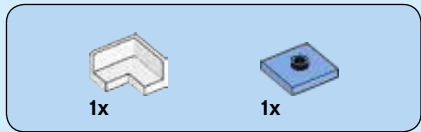

45

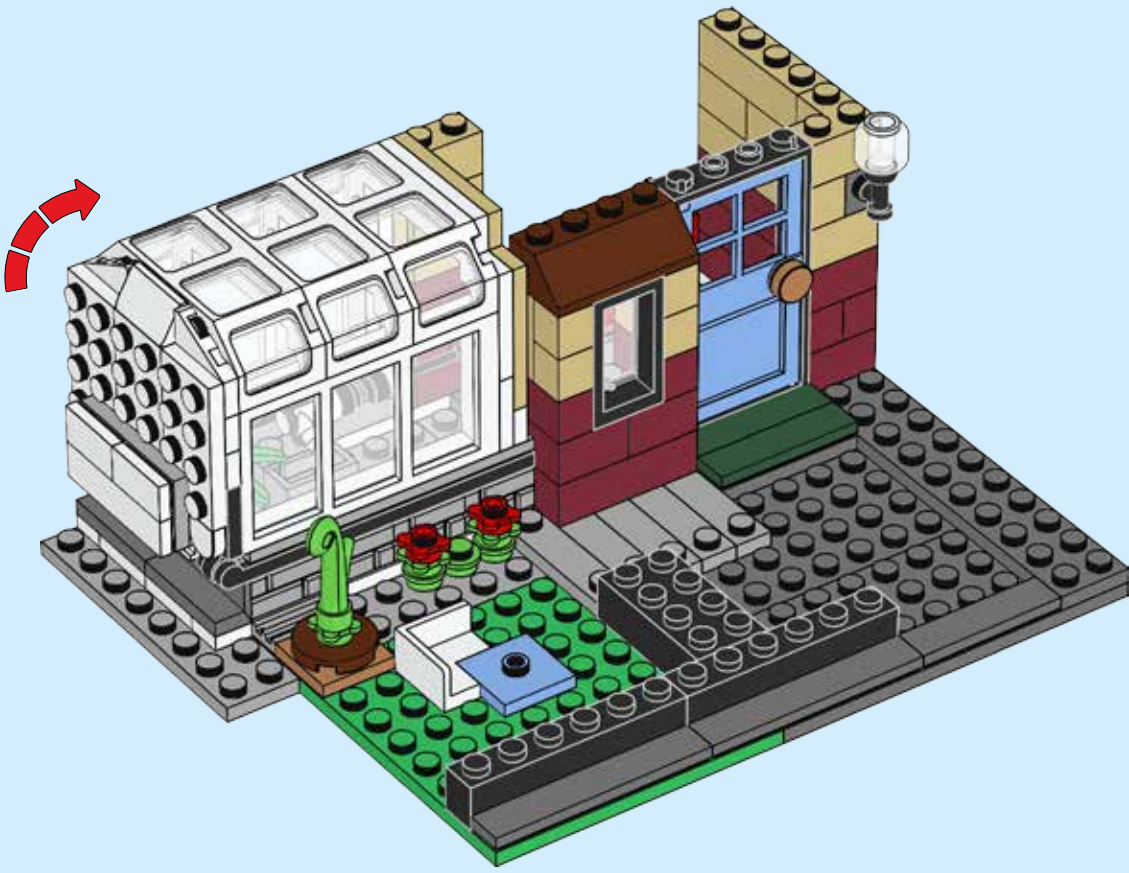





1x



2x

# 46

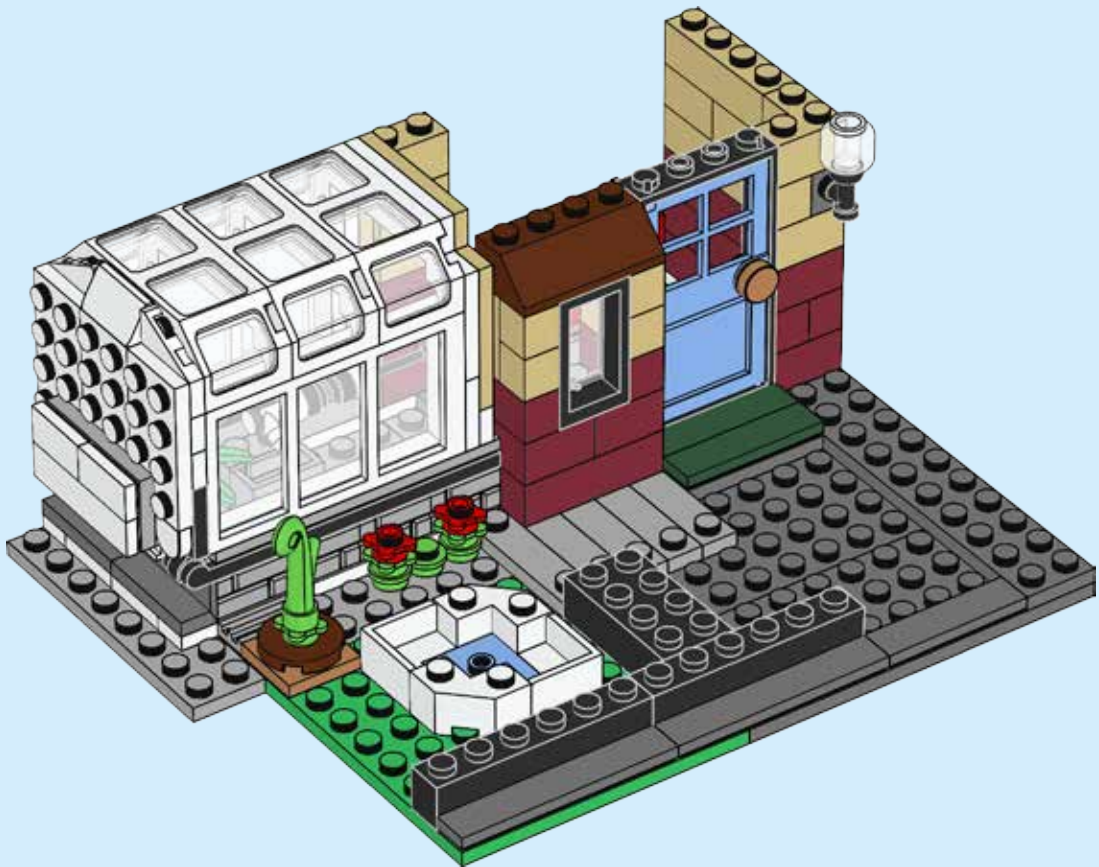

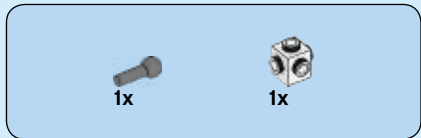

47

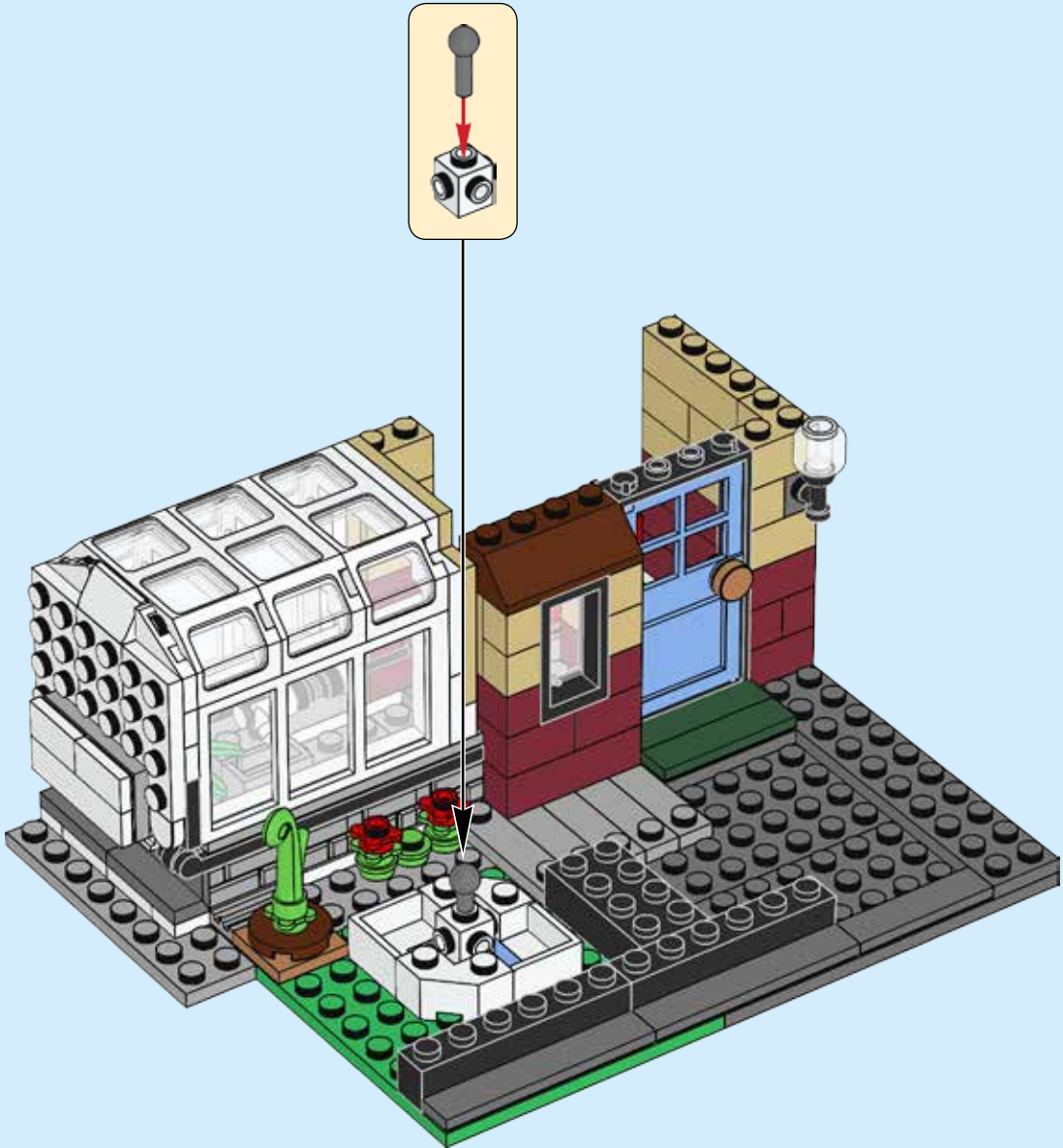

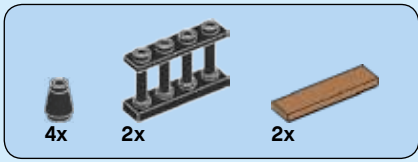

48

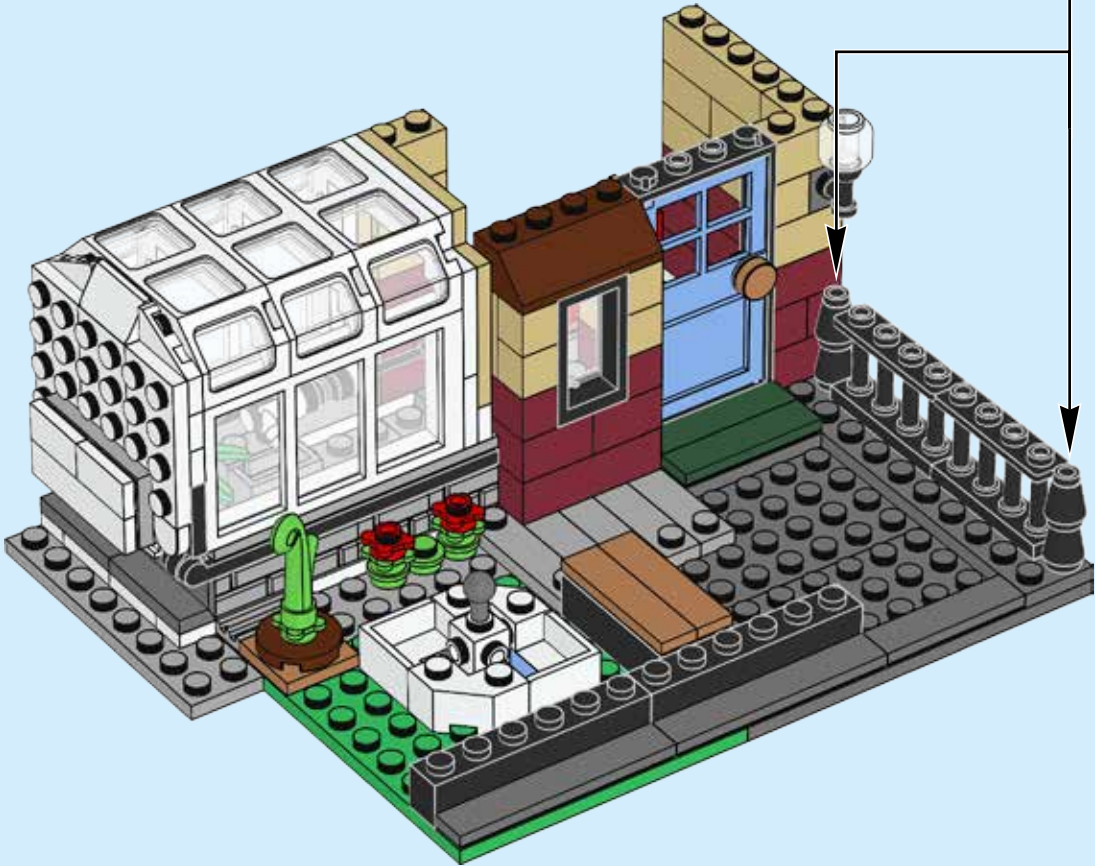
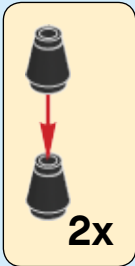

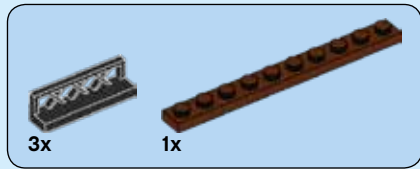

49

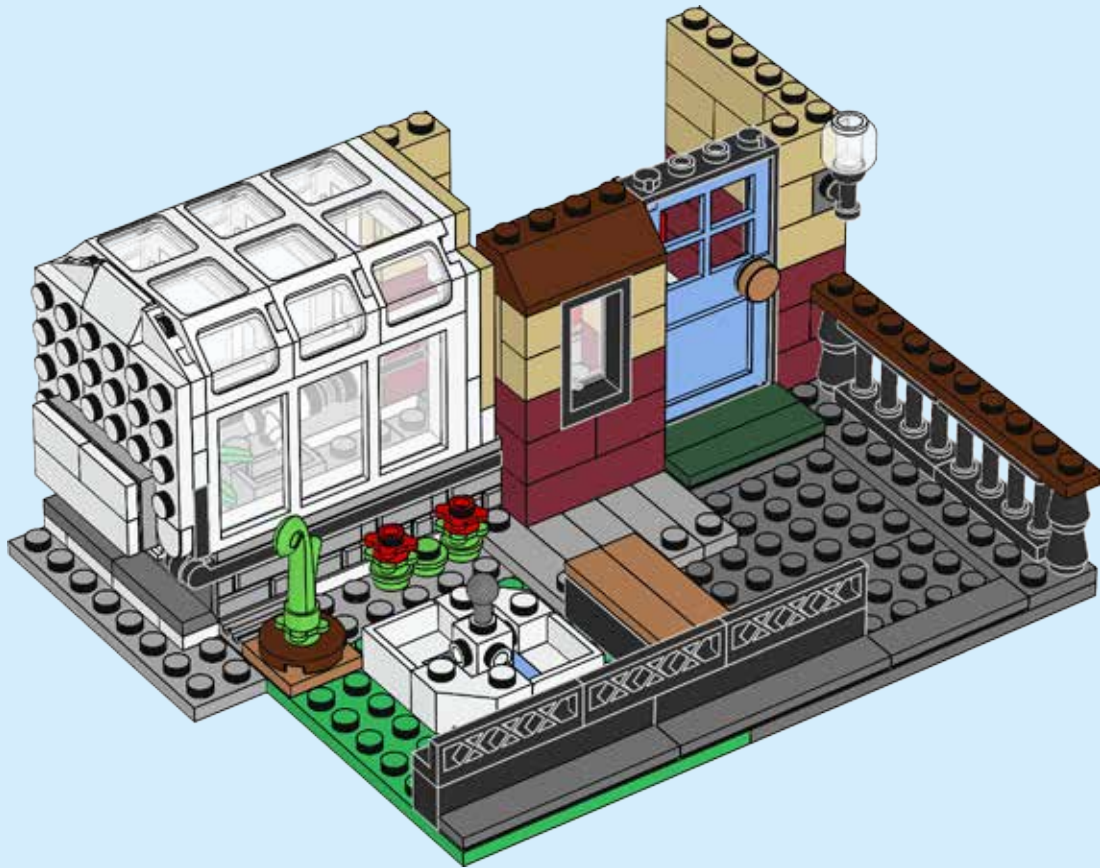

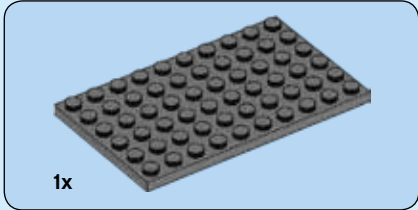

50

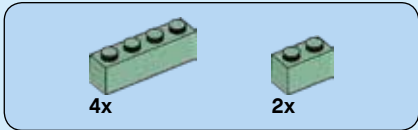
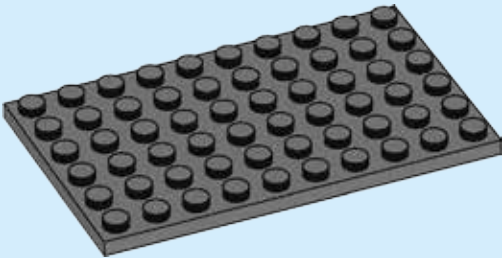

51

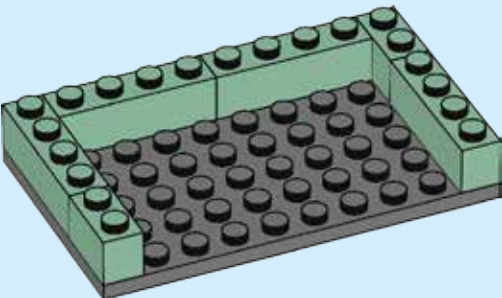

52

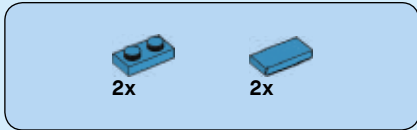
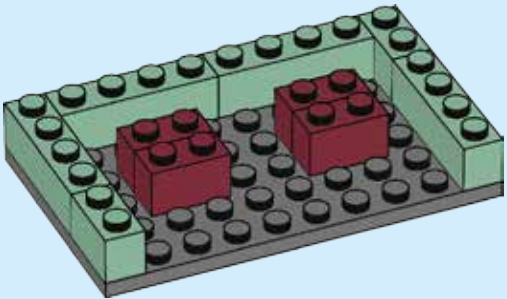

53

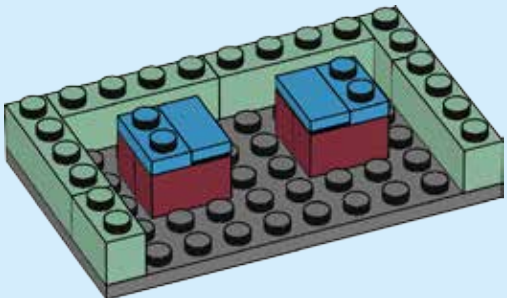

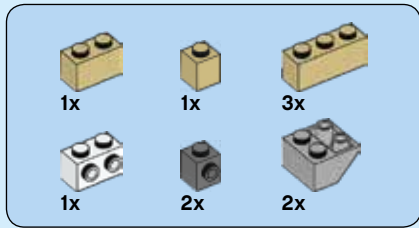

54

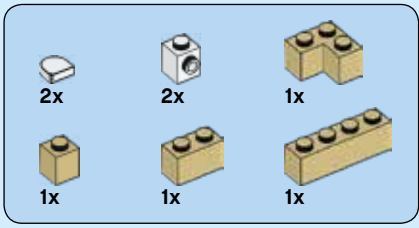
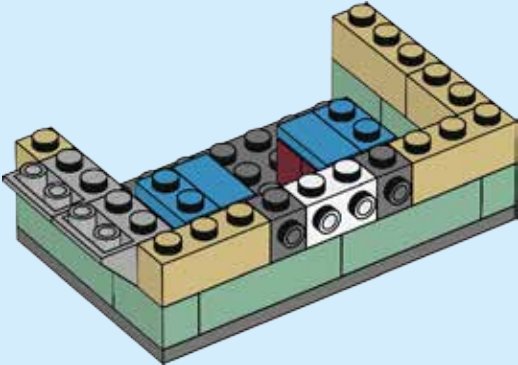
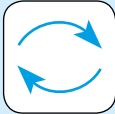

55

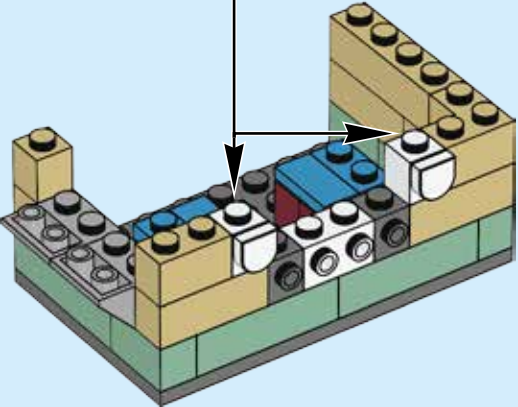
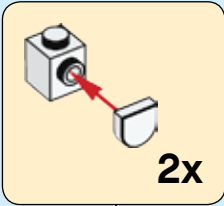

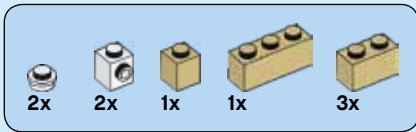

56

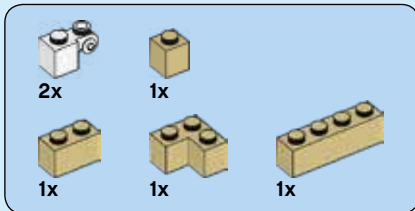
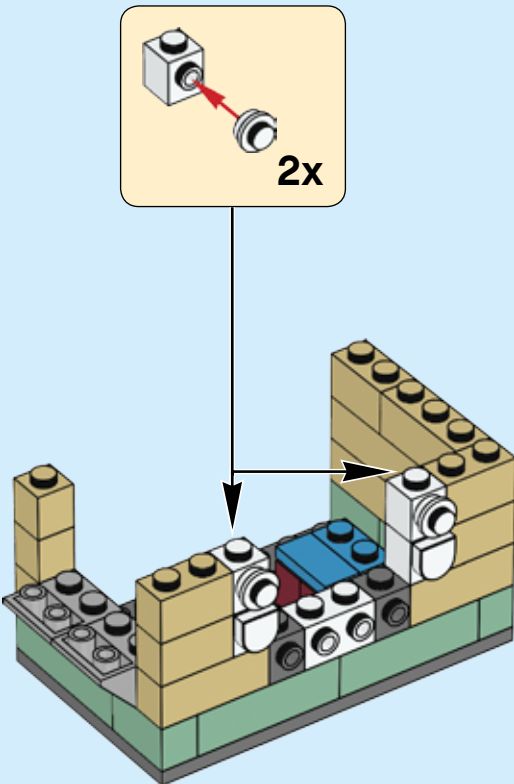

57

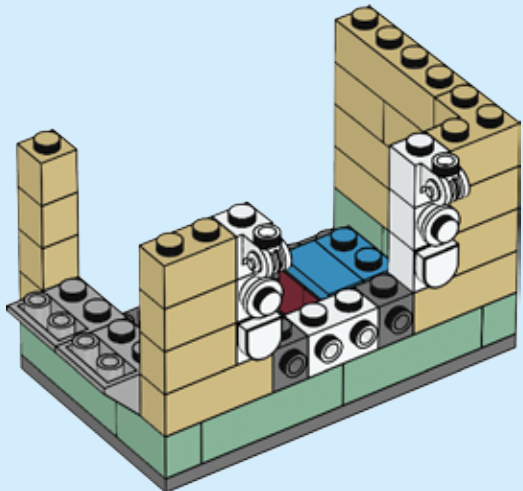

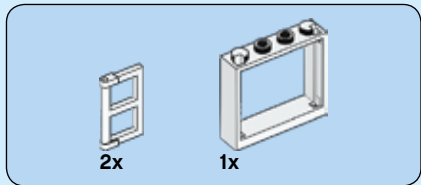

58

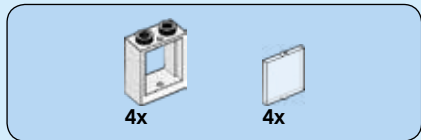
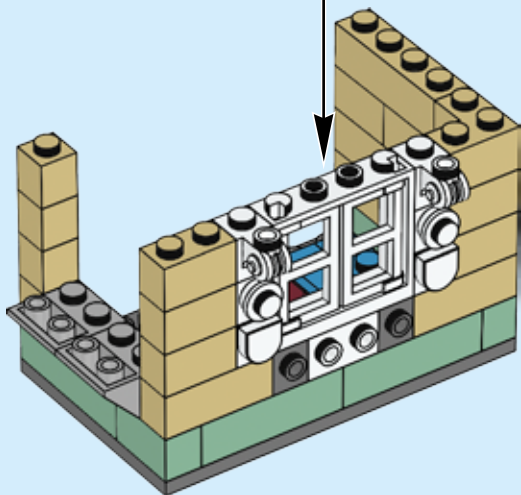
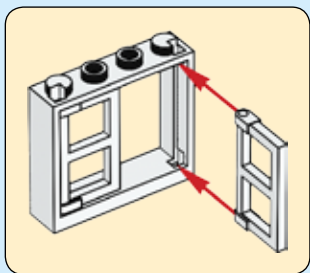

59

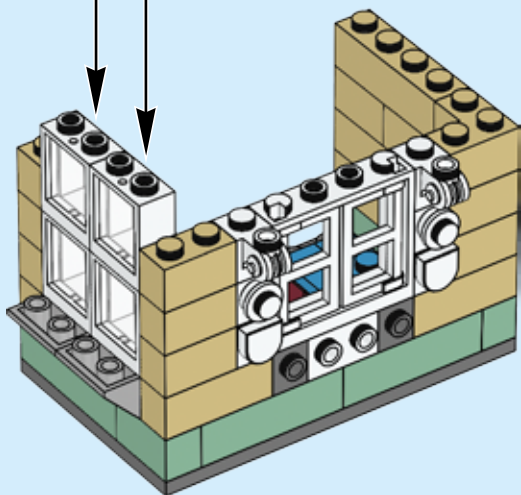
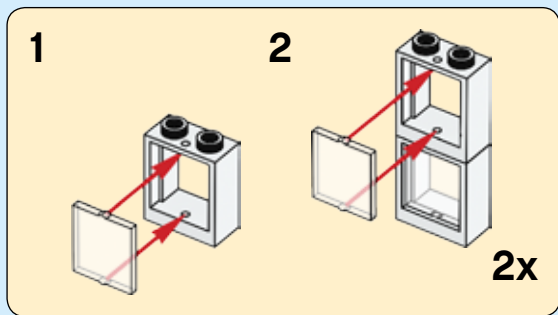



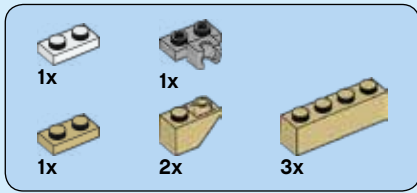

60

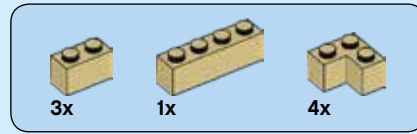
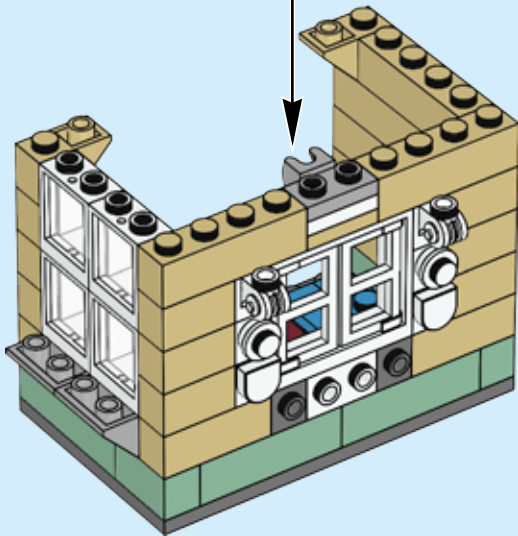
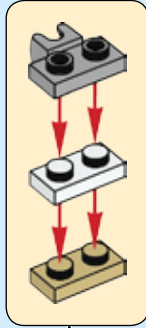

61

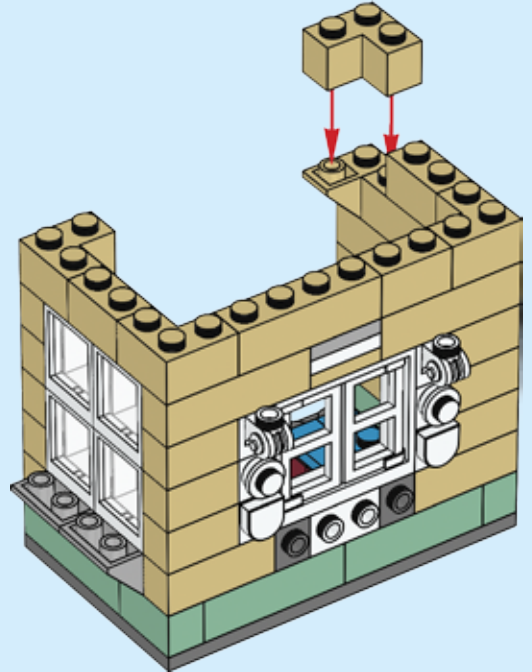



# 62

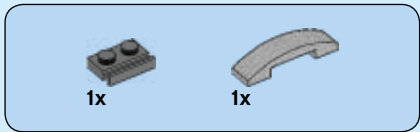
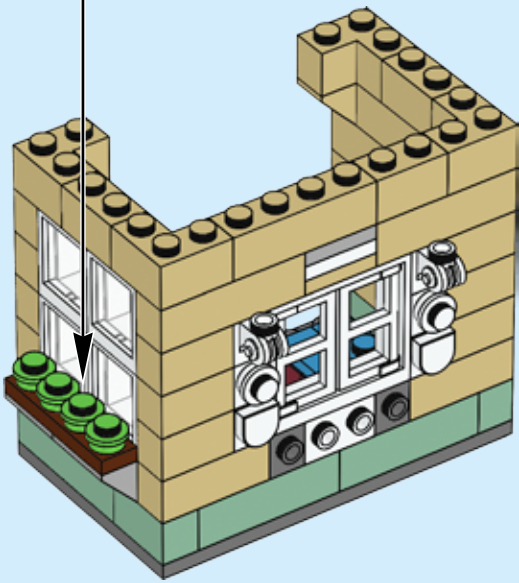

# 63

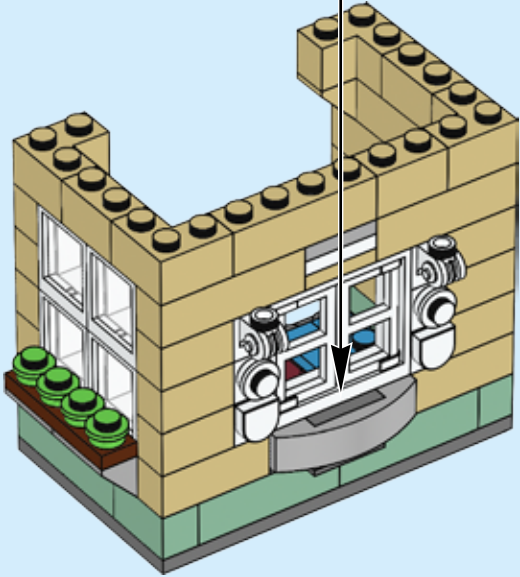
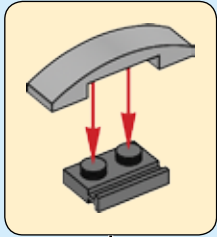

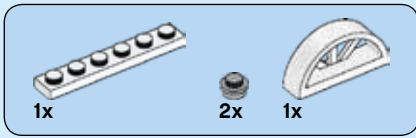

# 64

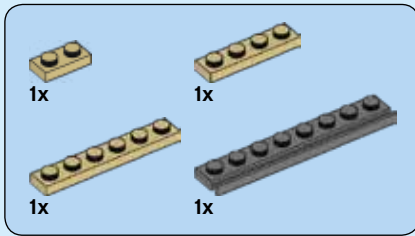
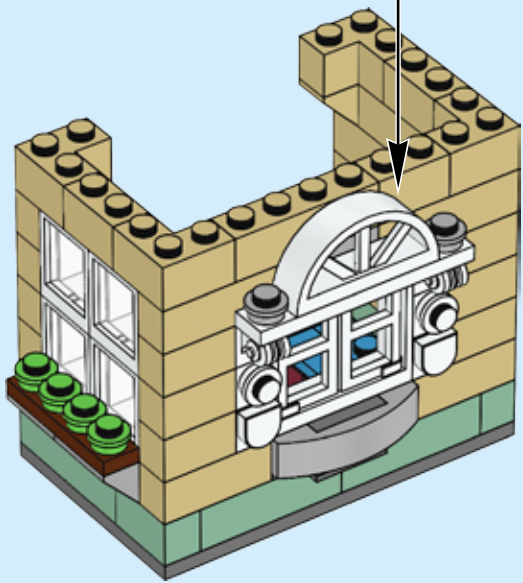
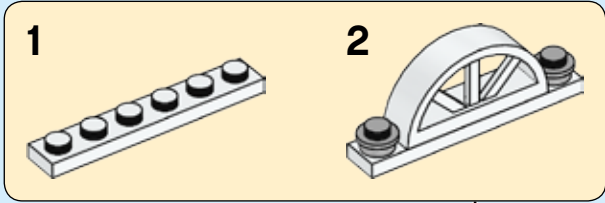

# 65

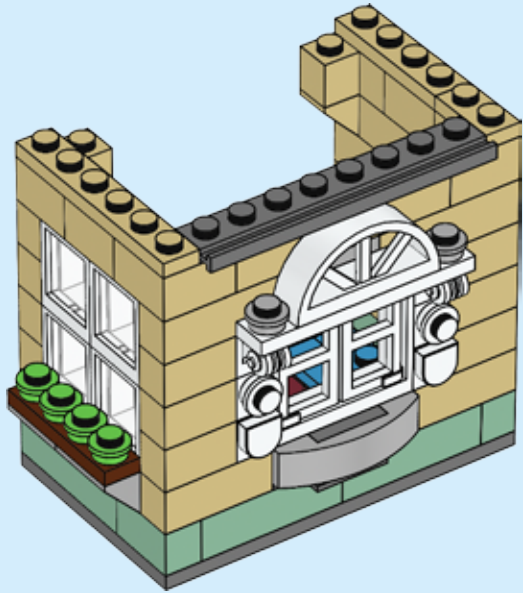

2x

2x

# 66

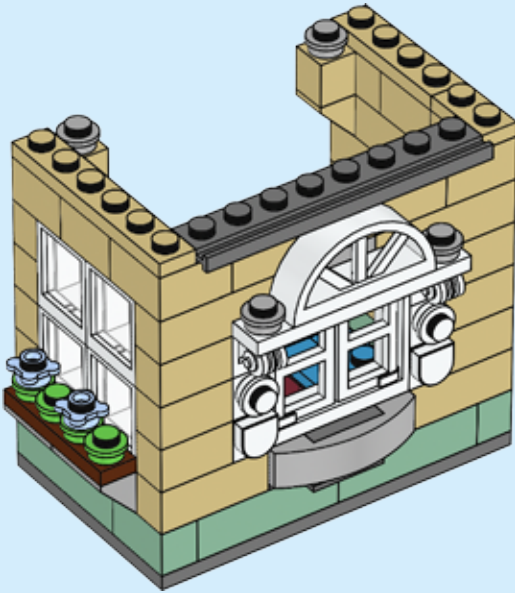

2x

2x

1x

1x

# 67

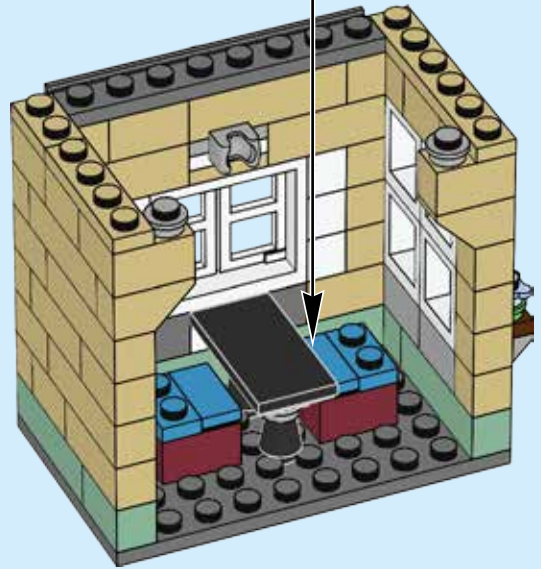
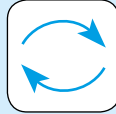
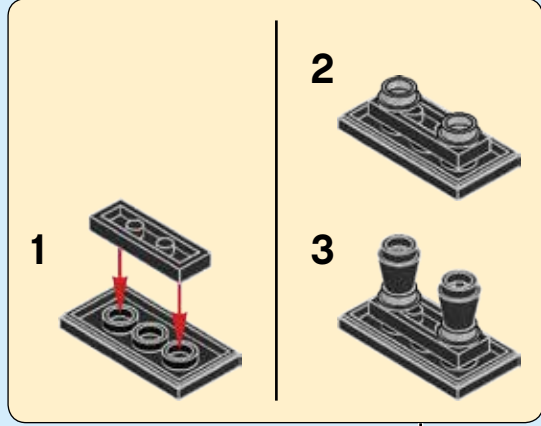



68

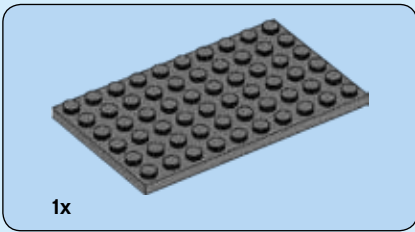
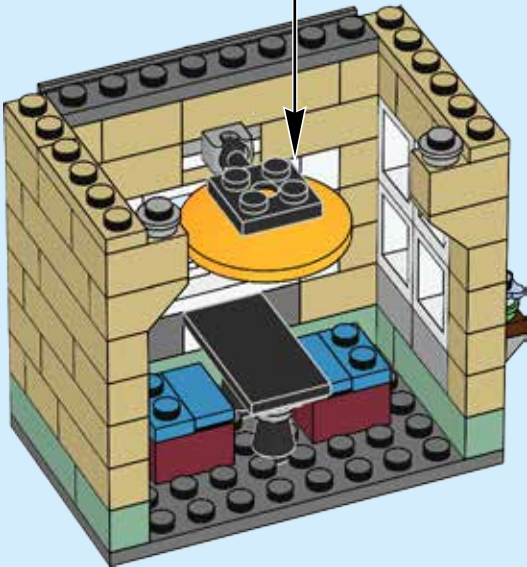
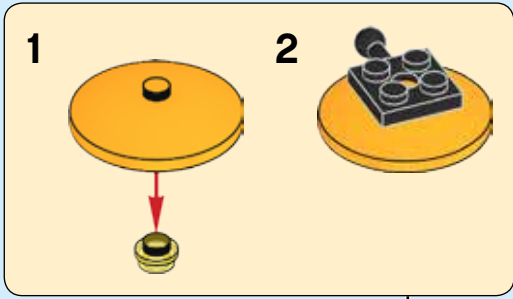

69

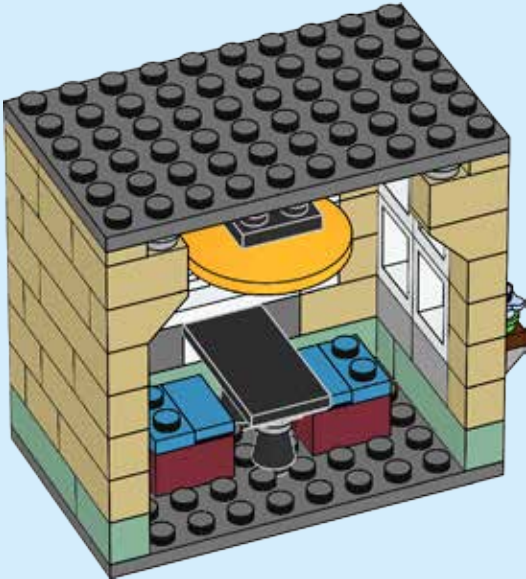

70

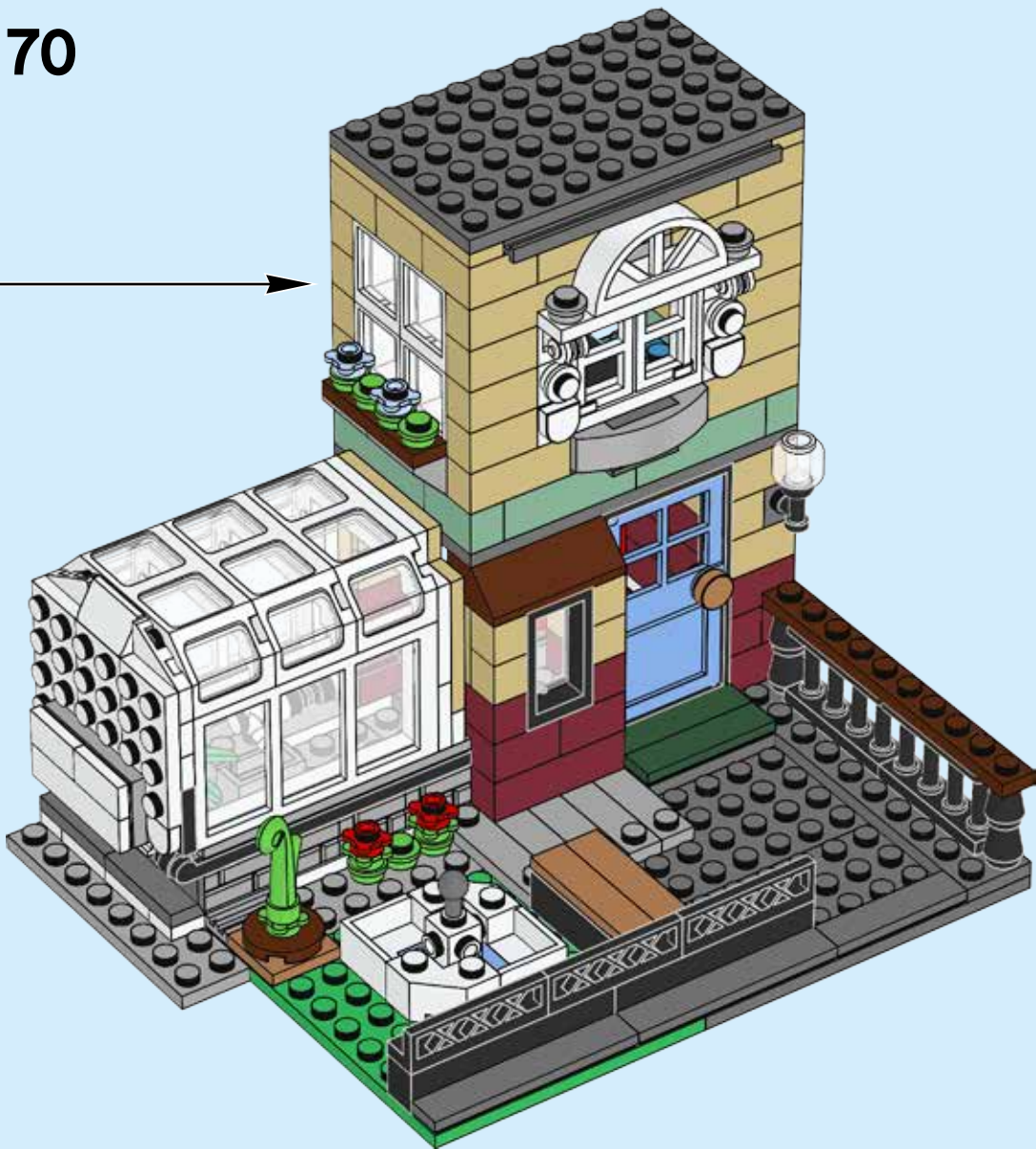

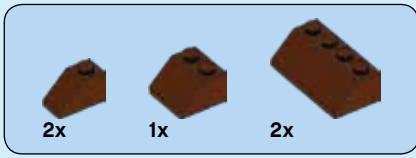

71

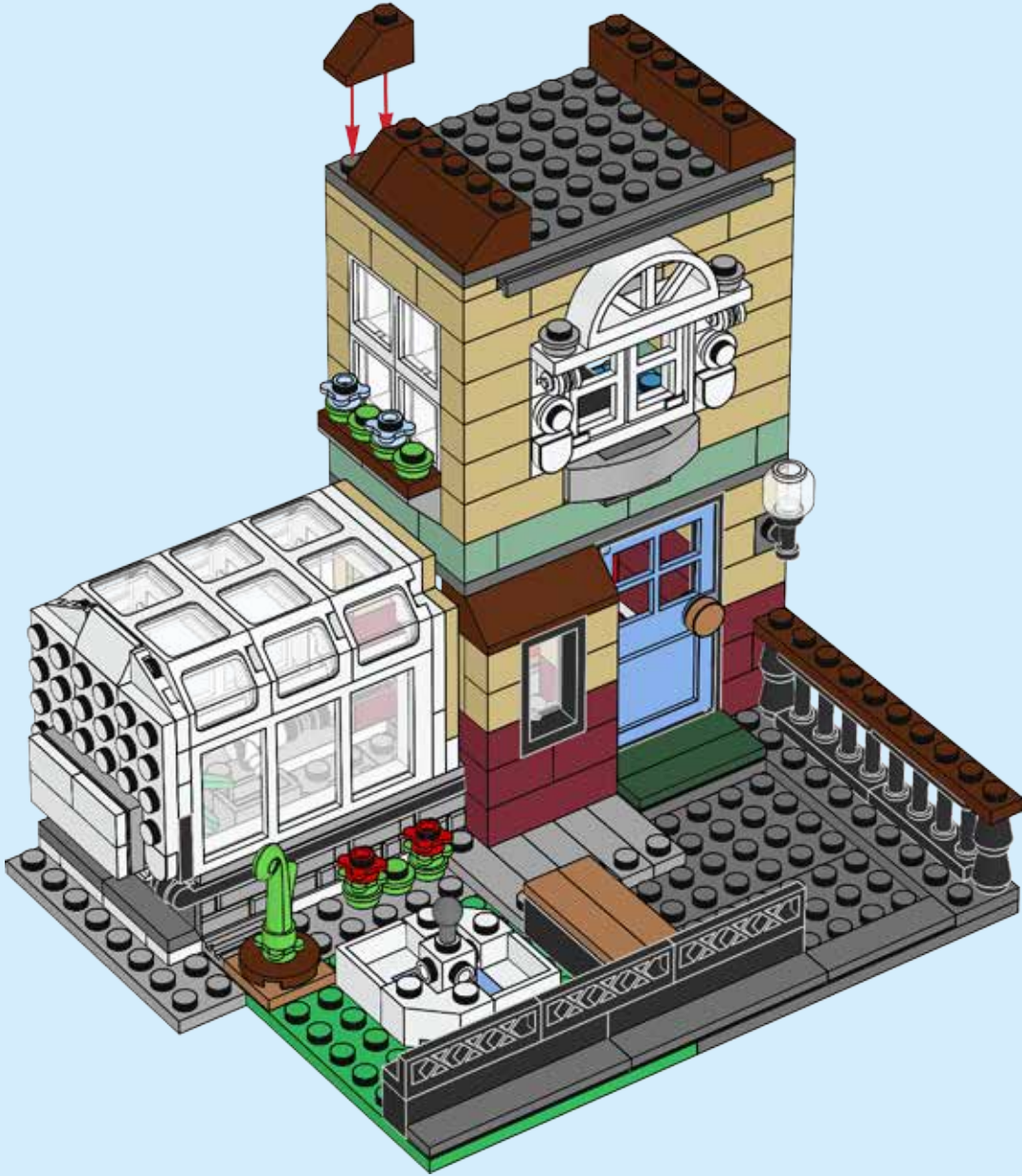

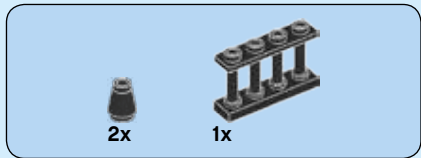

72









74





JANUARY 2017 / JANVIER 2017 / ENERO 2017



XBOX ONE



PS4

LEGO.com/worlds



LEGO WORLDS software © 2017 TT Games Ltd. Produced by TT Games under license from the LEGO Group. LEGO, the LEGO logo, the Brick and the Knob configurations and the Minifigure are trademarks of the LEGO Group. © 2017 The LEGO group. All other trademarks and copyrights are the property of their respective owners. All rights reserved. WB GAMES LOGO, WB SHIELD: ™ & © Warner Bros. Entertainment Inc. (s17)

Logiciel LEGO WORLDS © 2017 TT Games Ltd. Produit par TT Games avec l'autorisation du Groupe LEGO. LEGO, le logo LEGO, les configurations de briques et tenons et la minifigurine sont des marques de commerce du Groupe LEGO. © 2017 Le Groupe LEGO. Tous les autres droits d'auteur et marques de commerce sont la propriété de leurs propriétaires respectifs. Tous droits réservés. LOGO WB GAMES, LOGO WBIE, BOUCLEUR WB : ™ et © Warner Bros. Entertainment Inc. (s17)

LEGO WORLDS software © 2017 TT Games Ltd. Producido por TT Games bajo licencia de LEGO Group. LEGO, el logotipo de LEGO, la configuración del Ladrillo y de la Perilla, y la Minifigura son marcas comerciales de LEGO Group. © 2017 The LEGO Group. Todas las demás marcas comerciales y derechos de autor son propiedad de sus respectivos propietarios. Todos los derechos reservados. LOGOTIPO DE WB GAMES, LOGOTIPO DE WBIE, ESCUDO DE WB: ™ y © Warner Bros. Entertainment Inc. (s17)

31059

3  
IN  
1



LEGO and the LEGO logo are trademarks of  
the/ont des marques de commerce du/son  
marcas registradas de LEGO Group. ©2017  
The LEGO Group.

6188633