

The LEGO logo is displayed in its characteristic white, bold, sans-serif font with a black outline, set against a solid red square background.The word "SPORTS" is written in a large, stylized, red font with a black outline, positioned horizontally across the top center of the image.The number "3427" is printed in a large, white, sans-serif font in the top right corner of the image.A white rectangular warning box with a black border contains the text: "⚠️ **WARNING: CHOKING HAZARD.** Toy contains small parts and a small ball. Not for children under 3 years." The warning icon is a triangle with an exclamation mark.The part number "4195739" is printed in a small, white, sans-serif font in the bottom left corner of the image.The NBA logo, featuring a white silhouette of a basketball player on a red and blue background, is positioned to the left of the word "NBA" in a large, bold, red font with a white outline.





**⚠ AVERTISSEMENT : RISQUE D'ÉTOUFFEMENT.**  
Le jouet contient des petites pièces ainsi qu'une petite boule.  
Il ne convient pas aux enfants de moins de 3 ans.

**⚠ ADVERTENCIA: PELIGRO DE ASFIXIA.**  
Juguete que contiene partes pequeñas y una pelota pequeña.  
No recomendado para niños menores de 3 años.

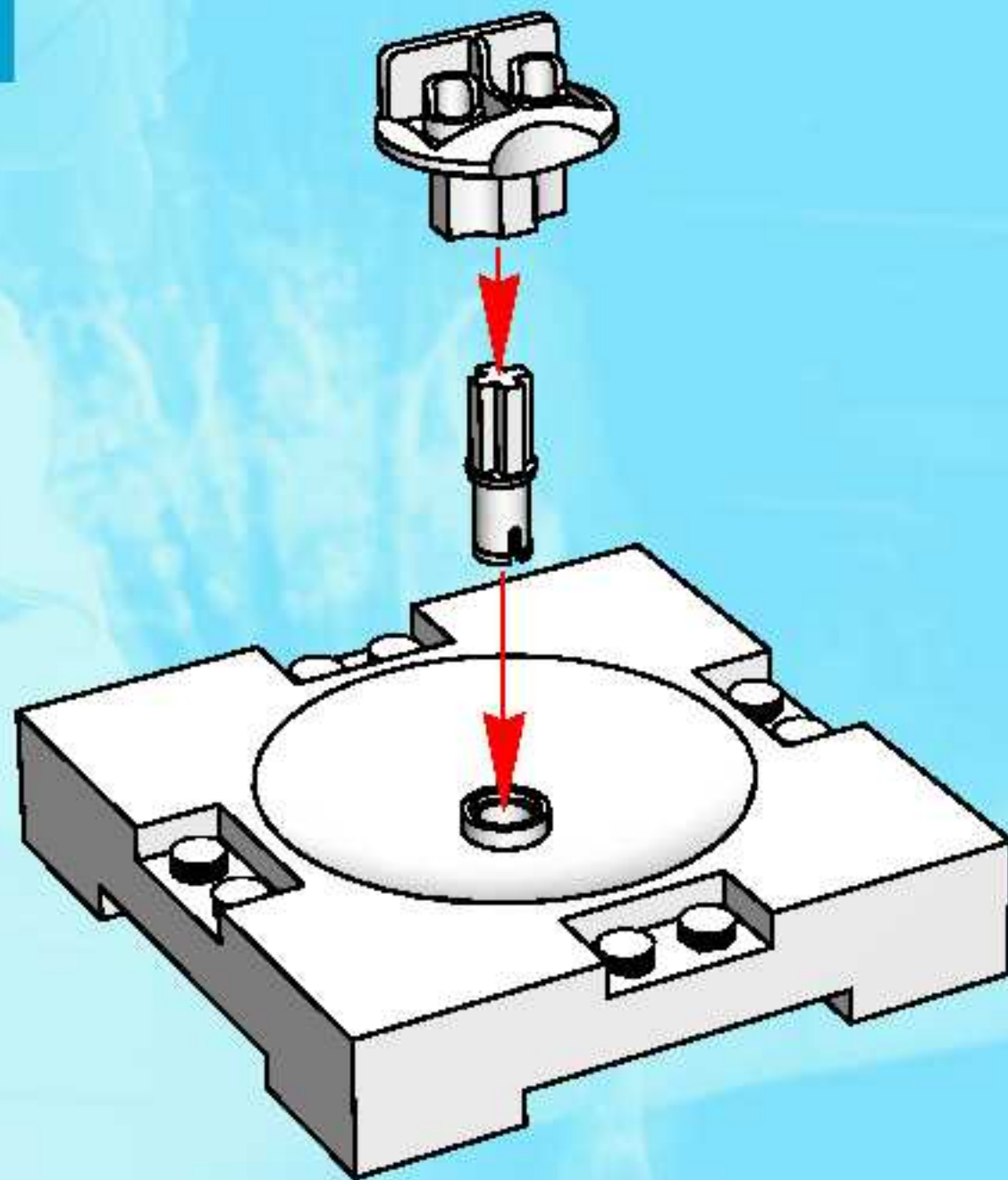
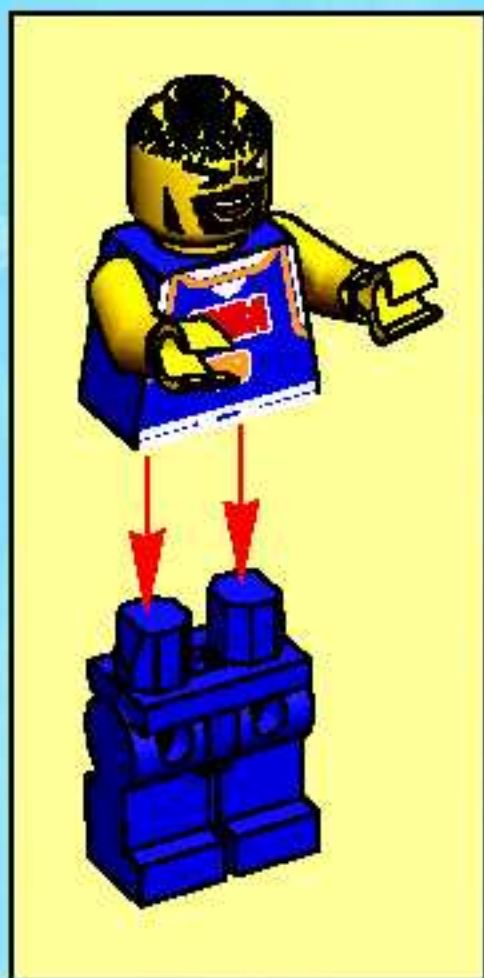

1

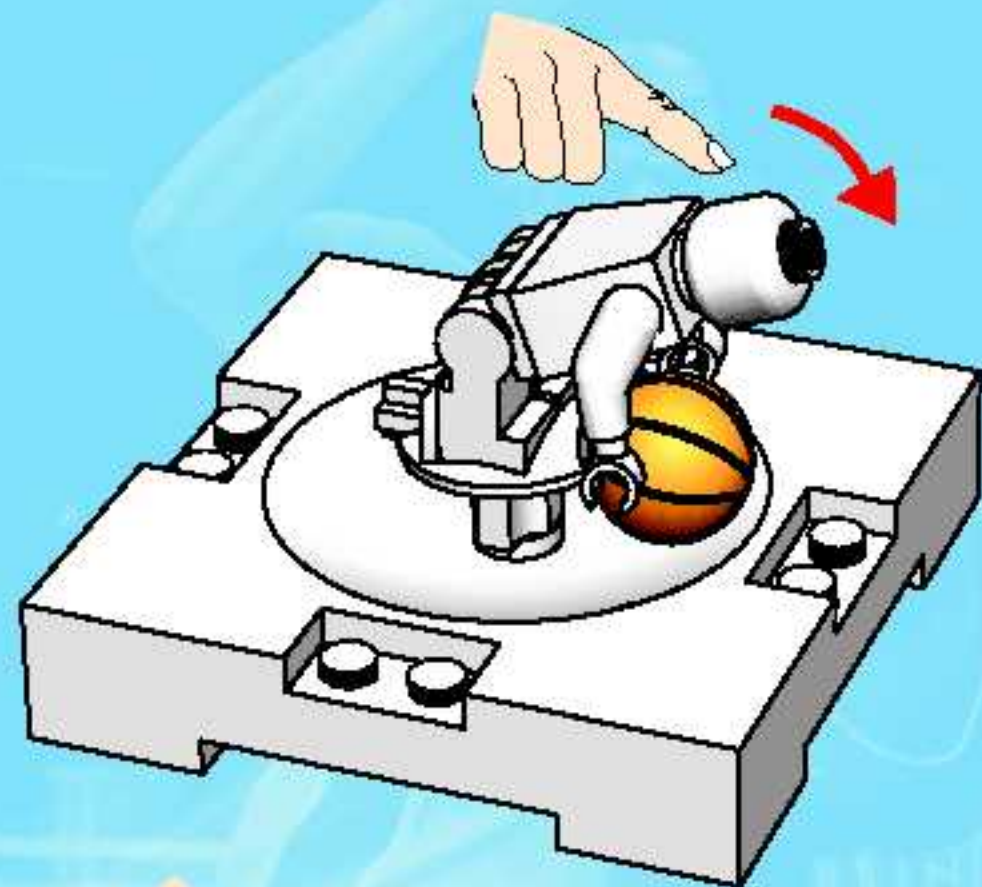

2

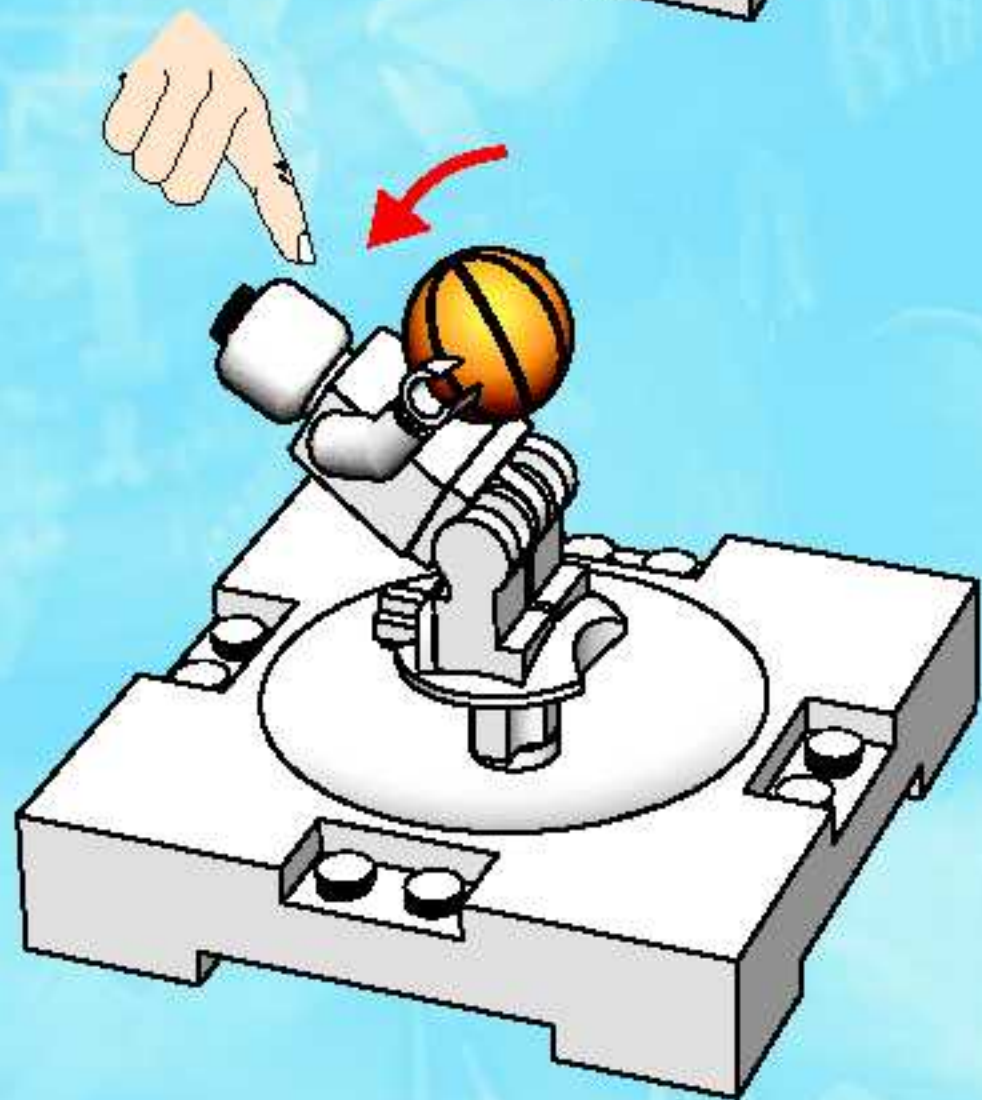

3

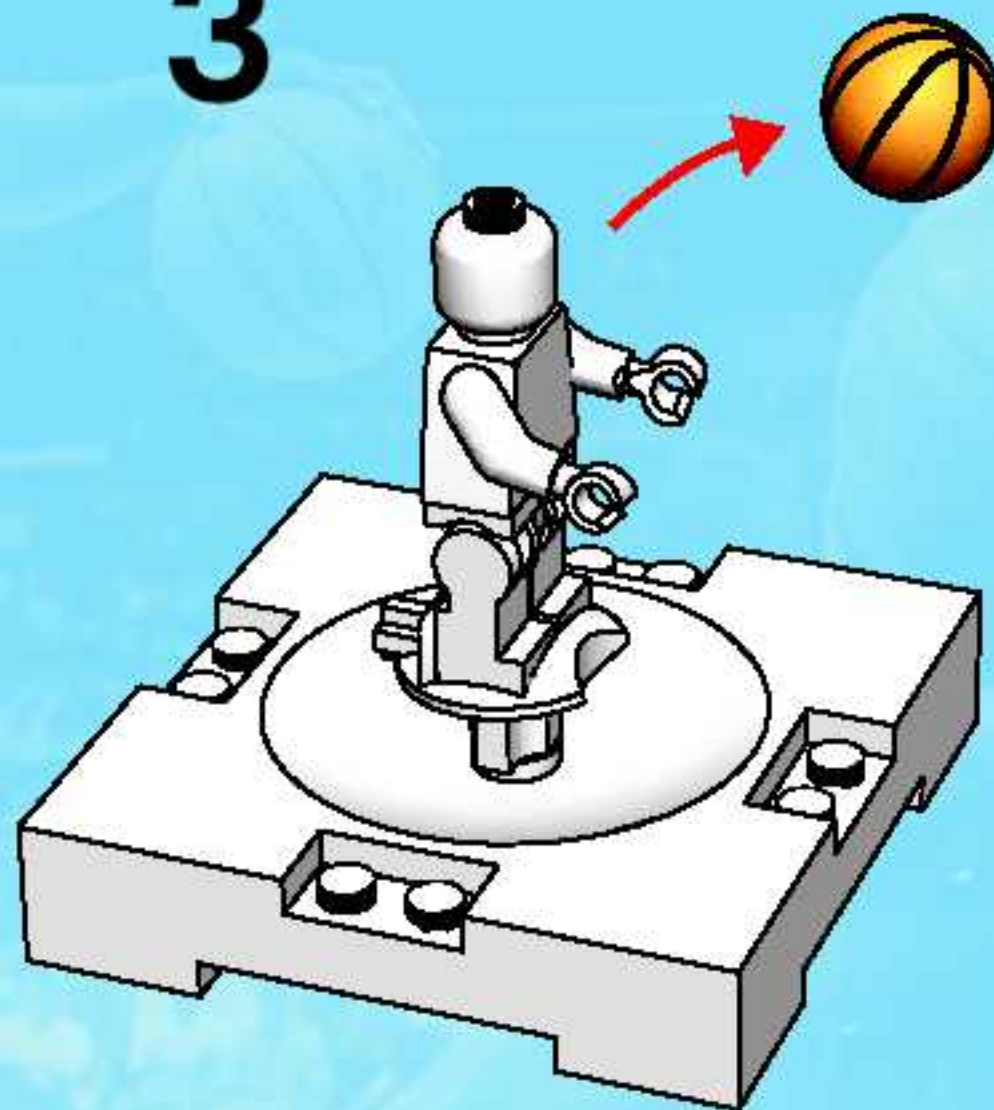

1



2

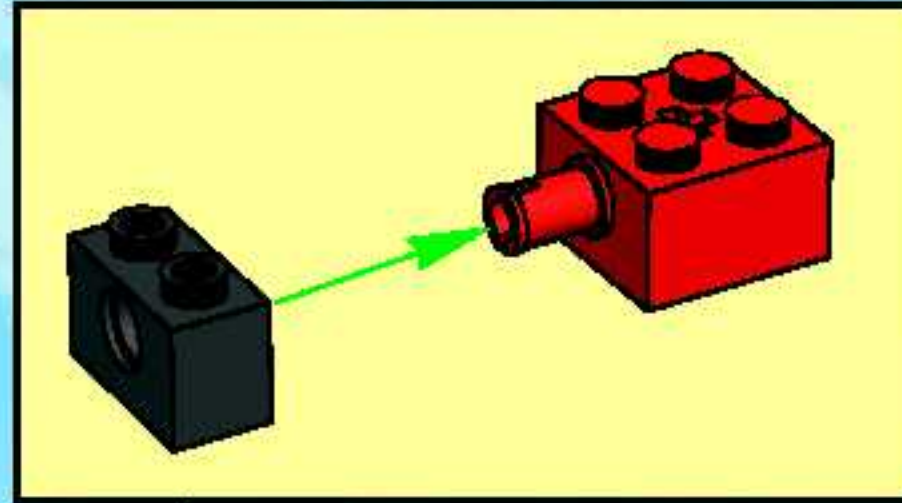

3

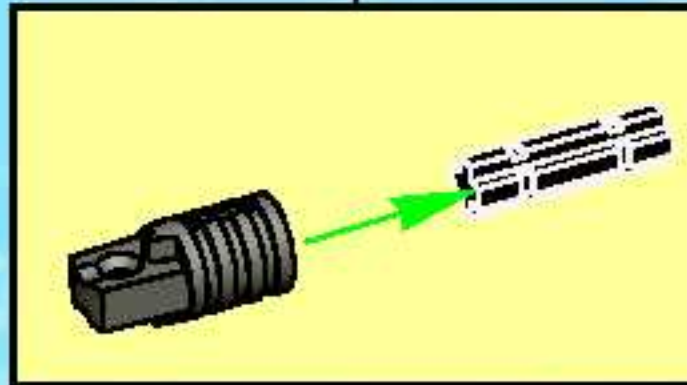
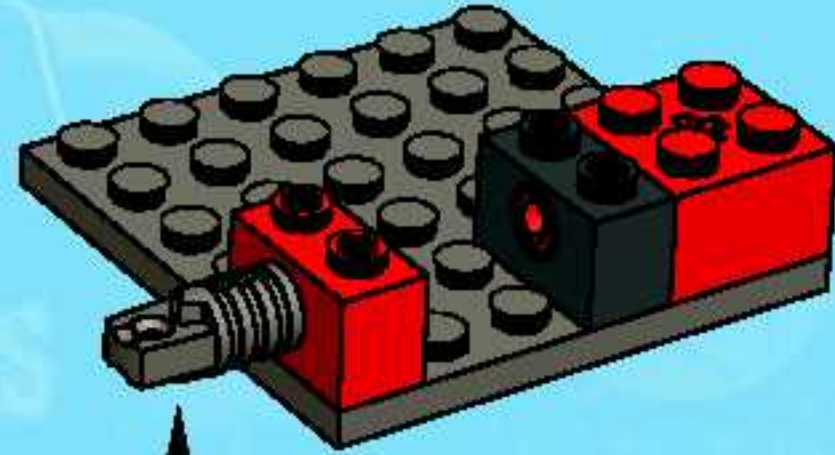

4

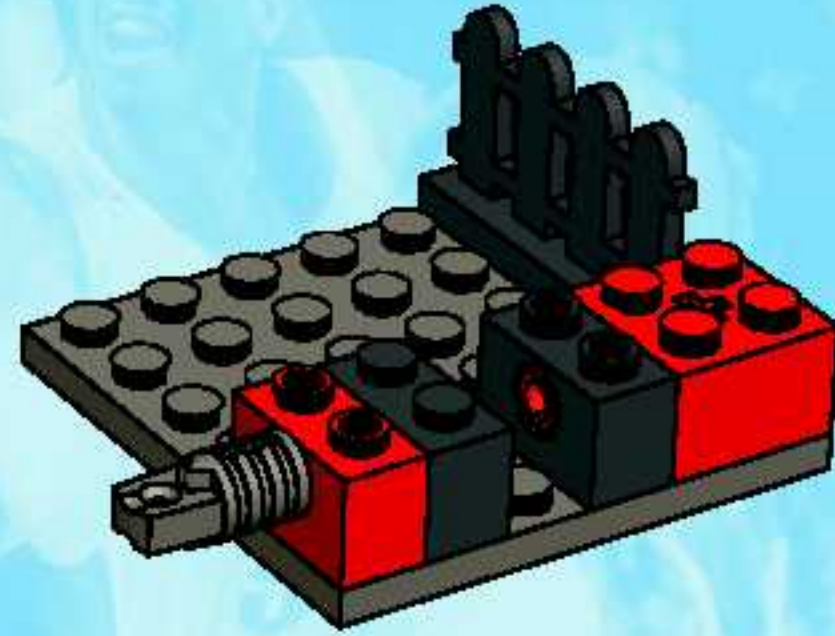

5

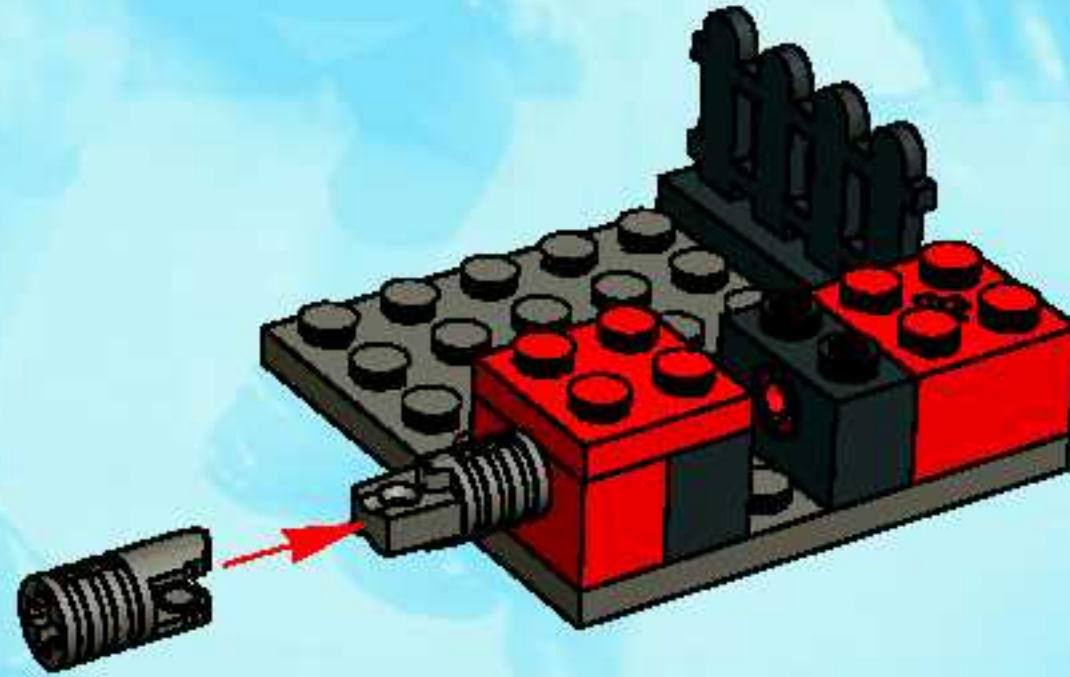



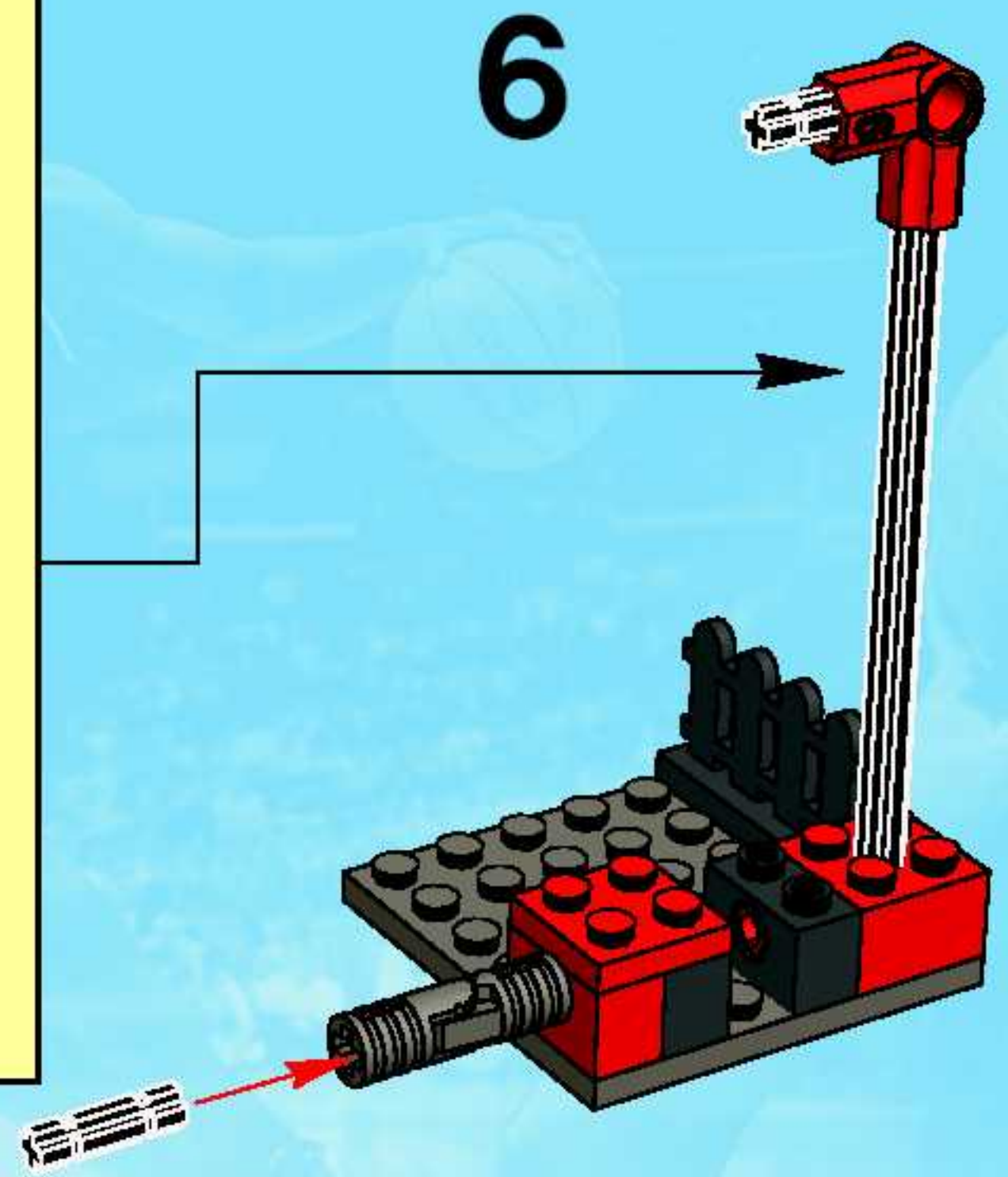
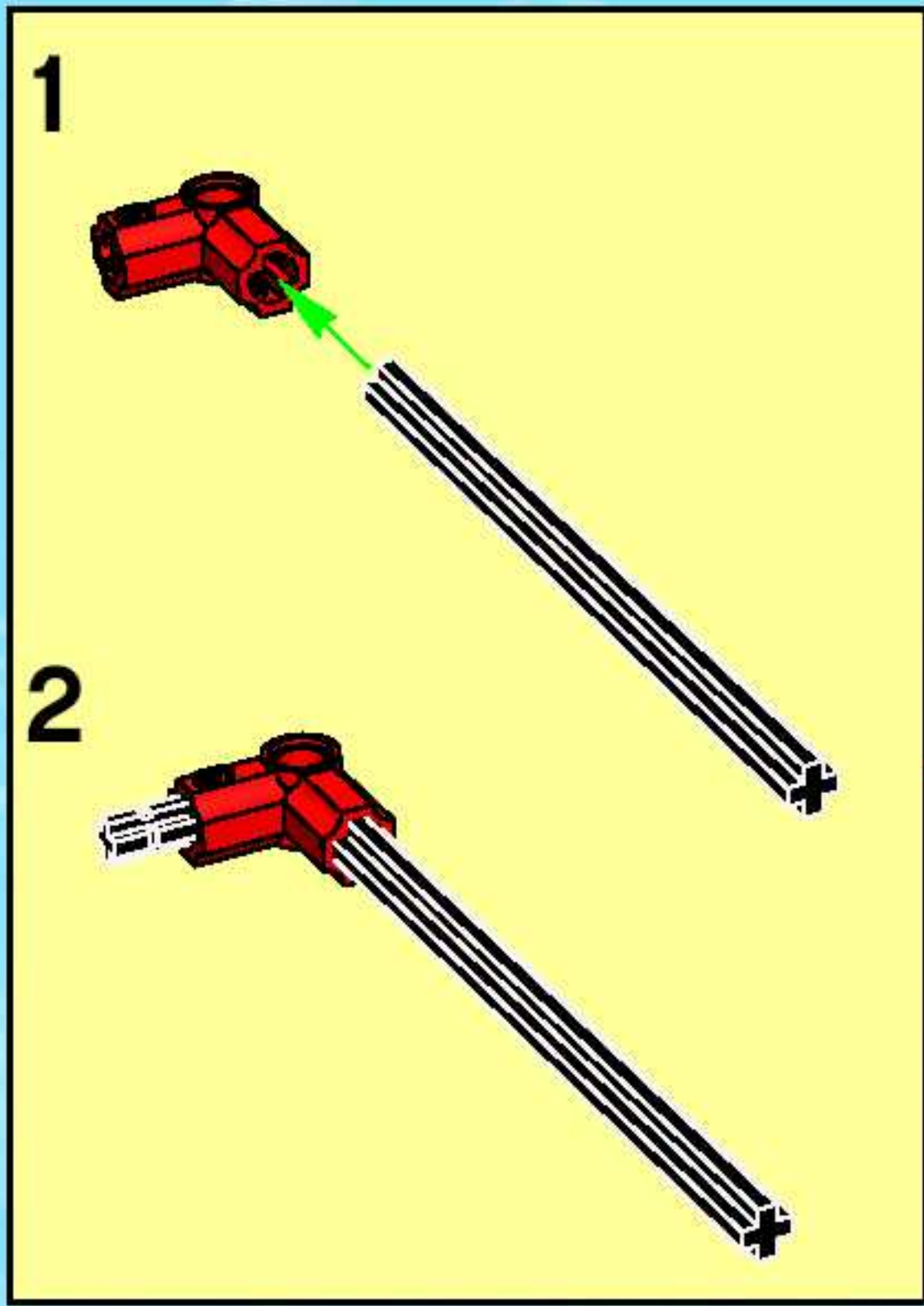

1



2

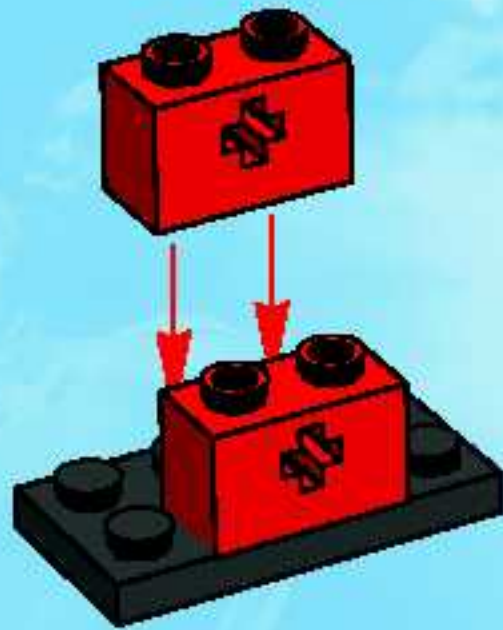

3



4

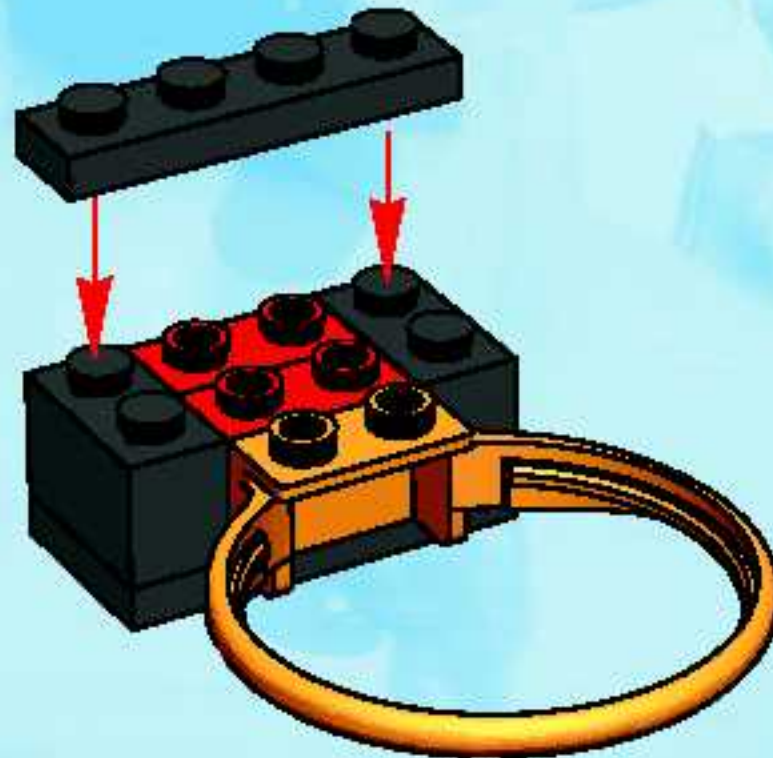

5

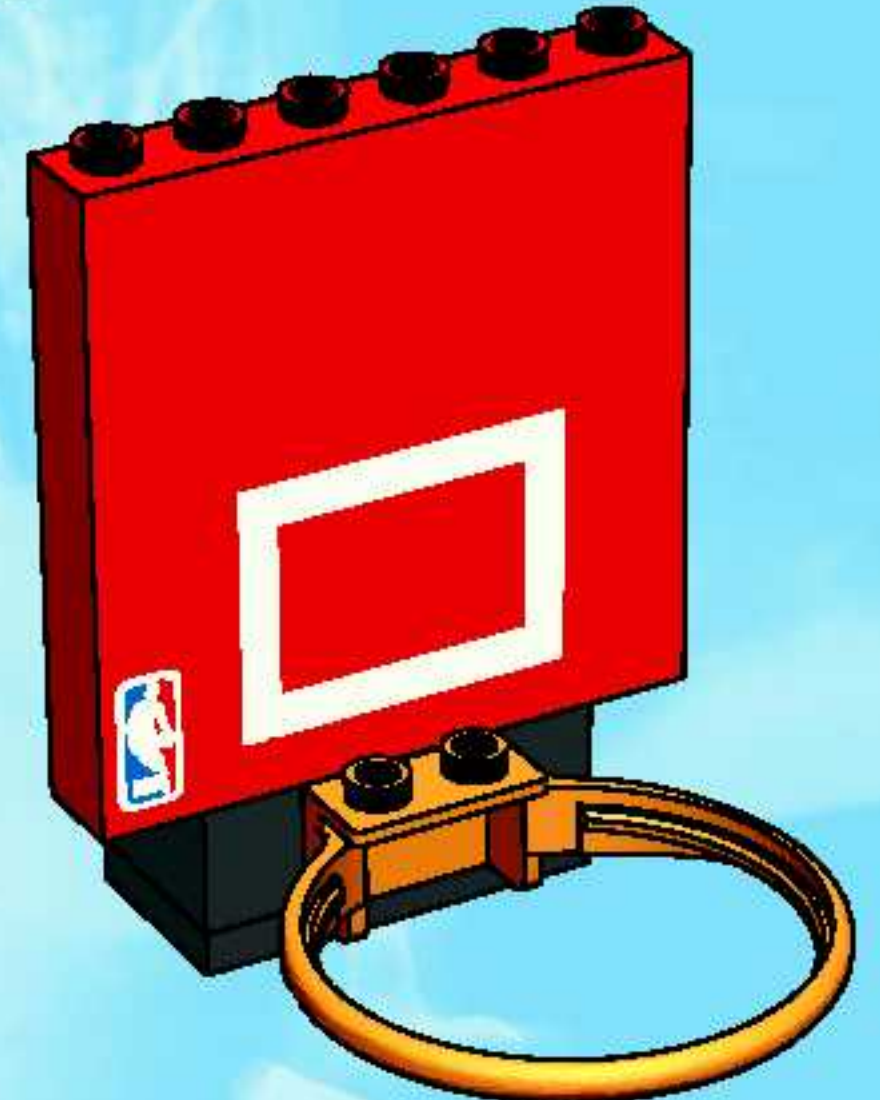

6



7



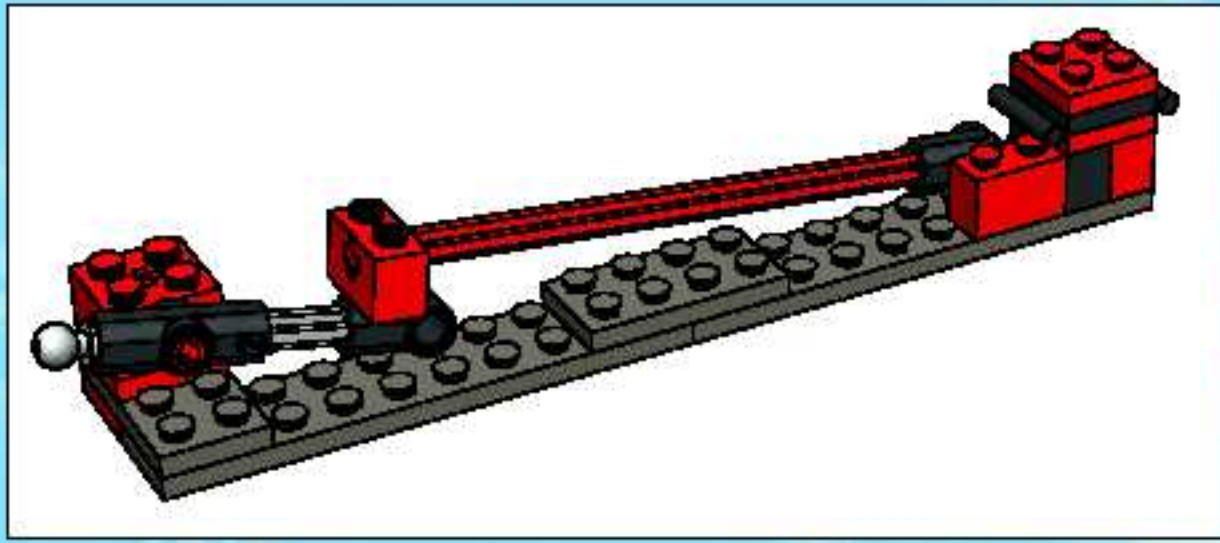

1

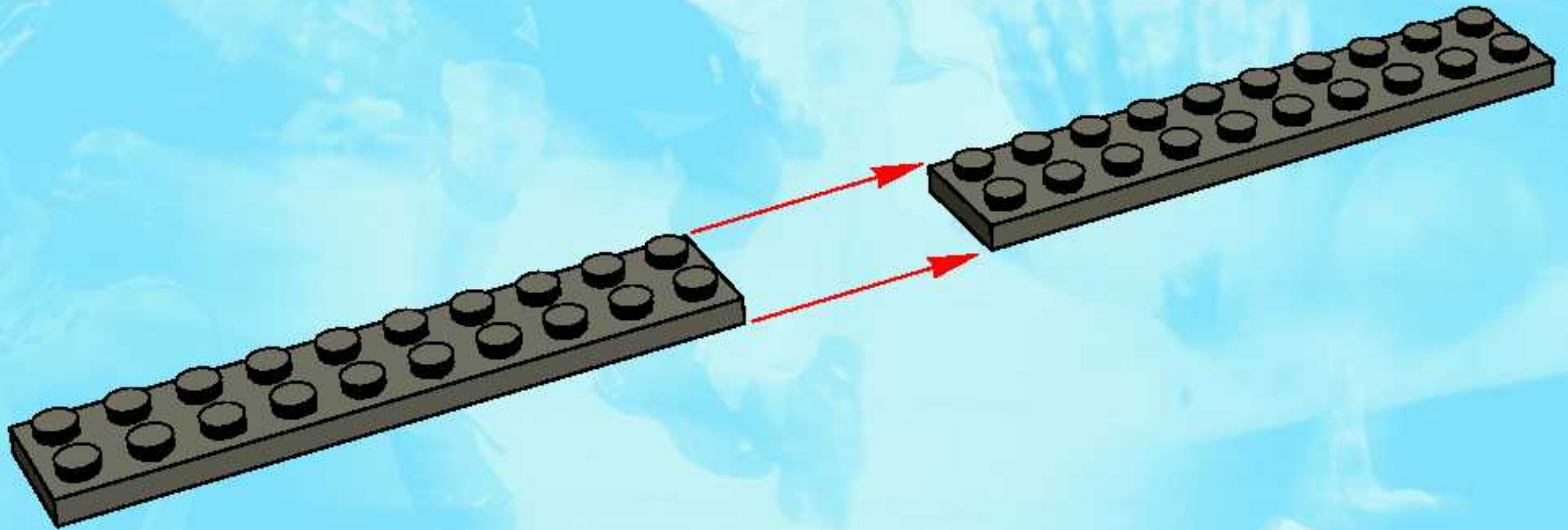

2

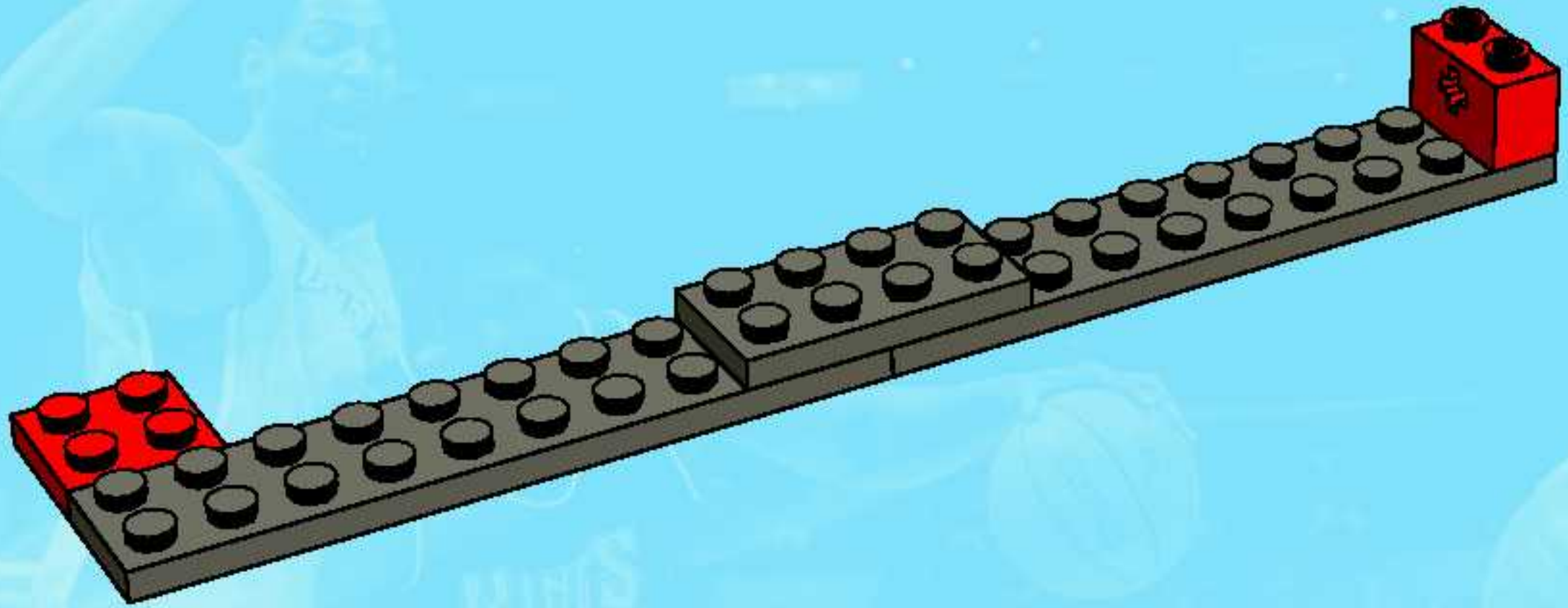

3

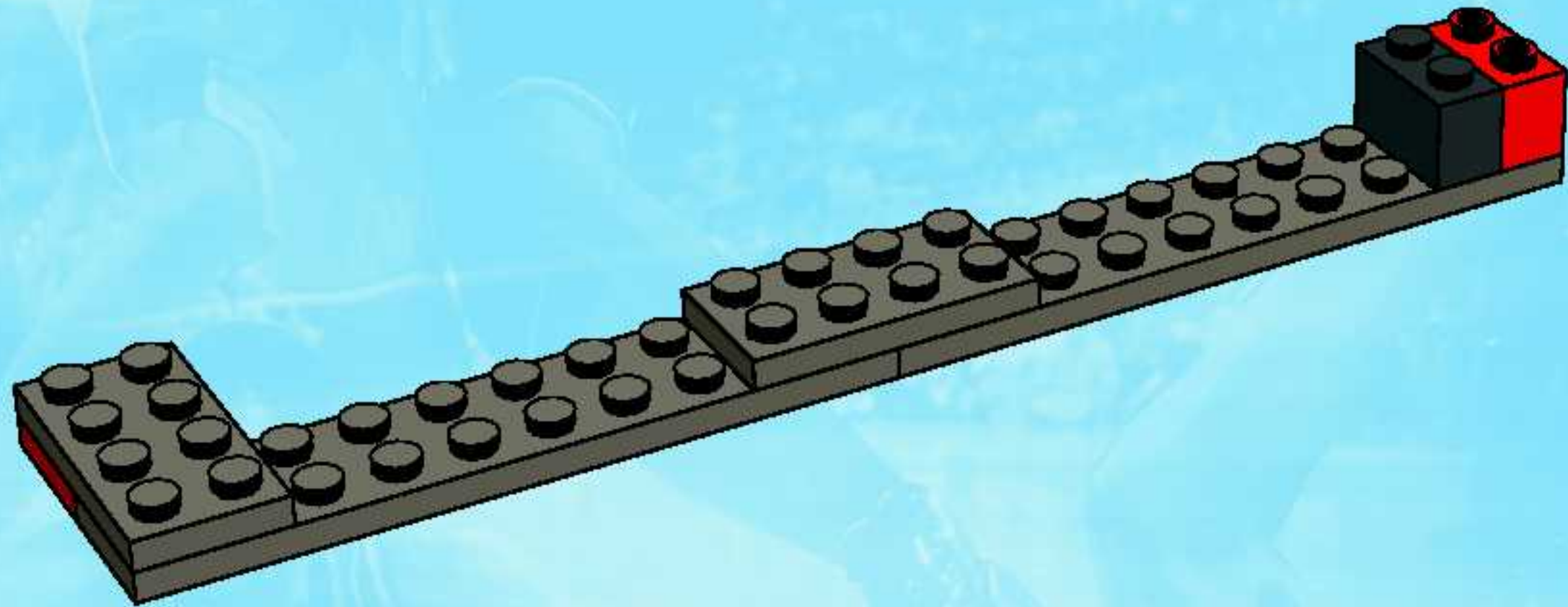

4

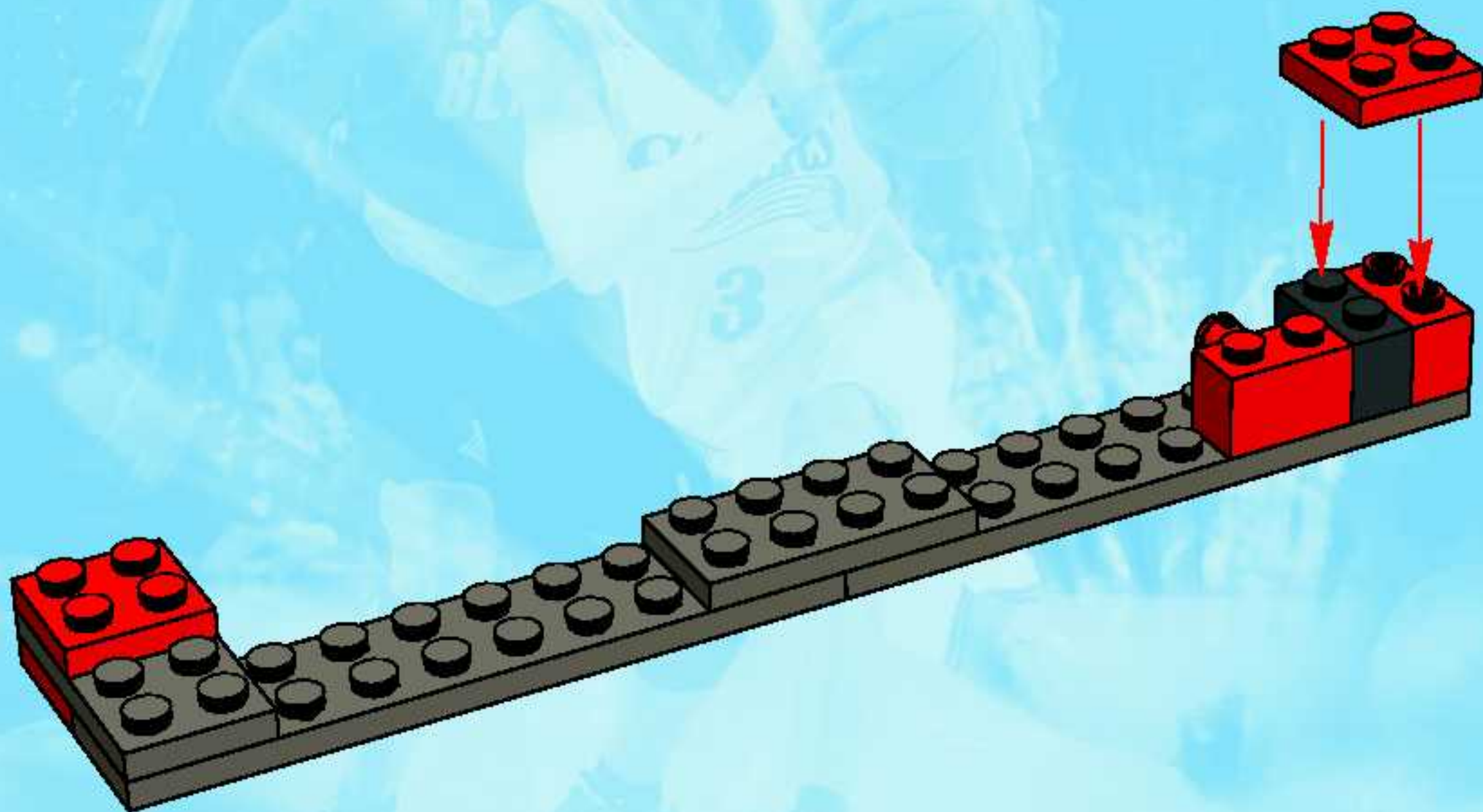

5

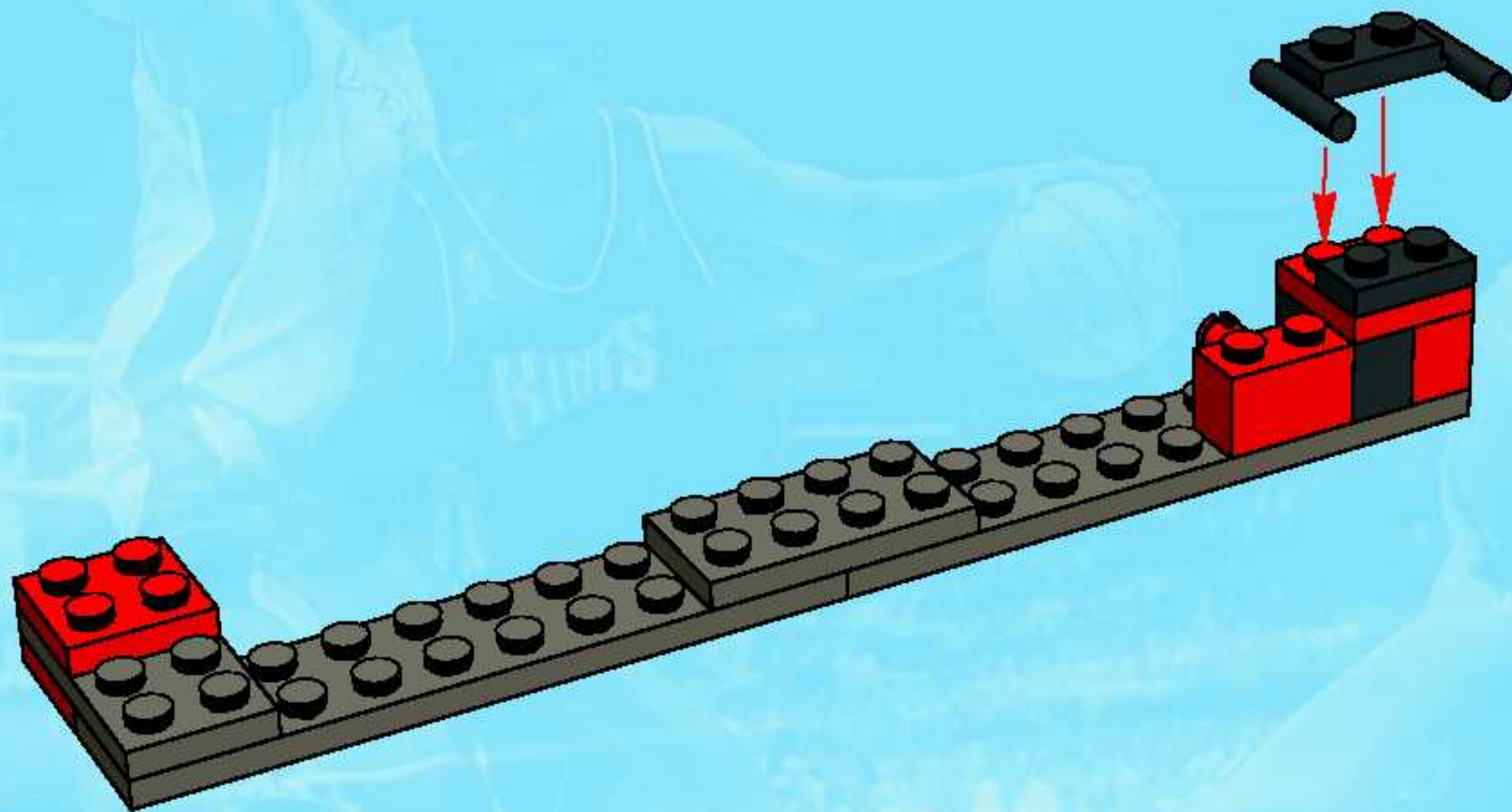

6

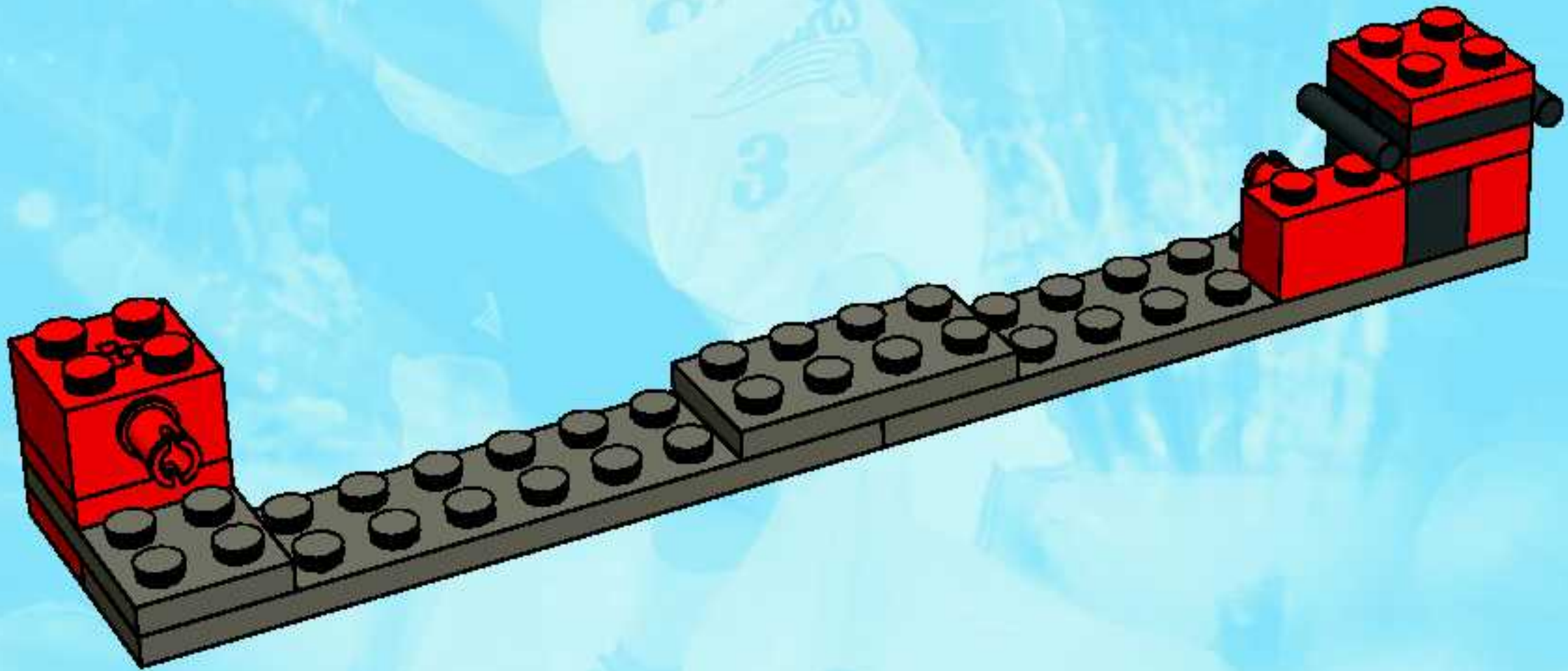



7

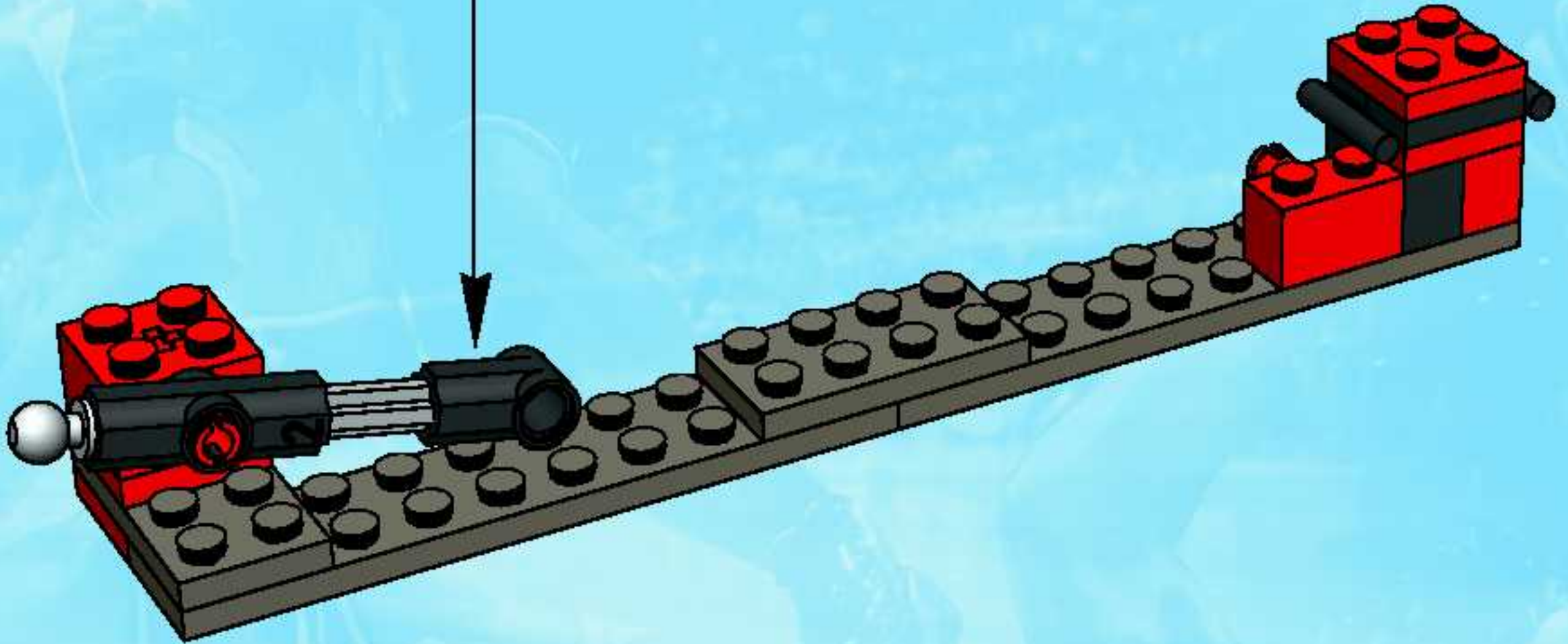
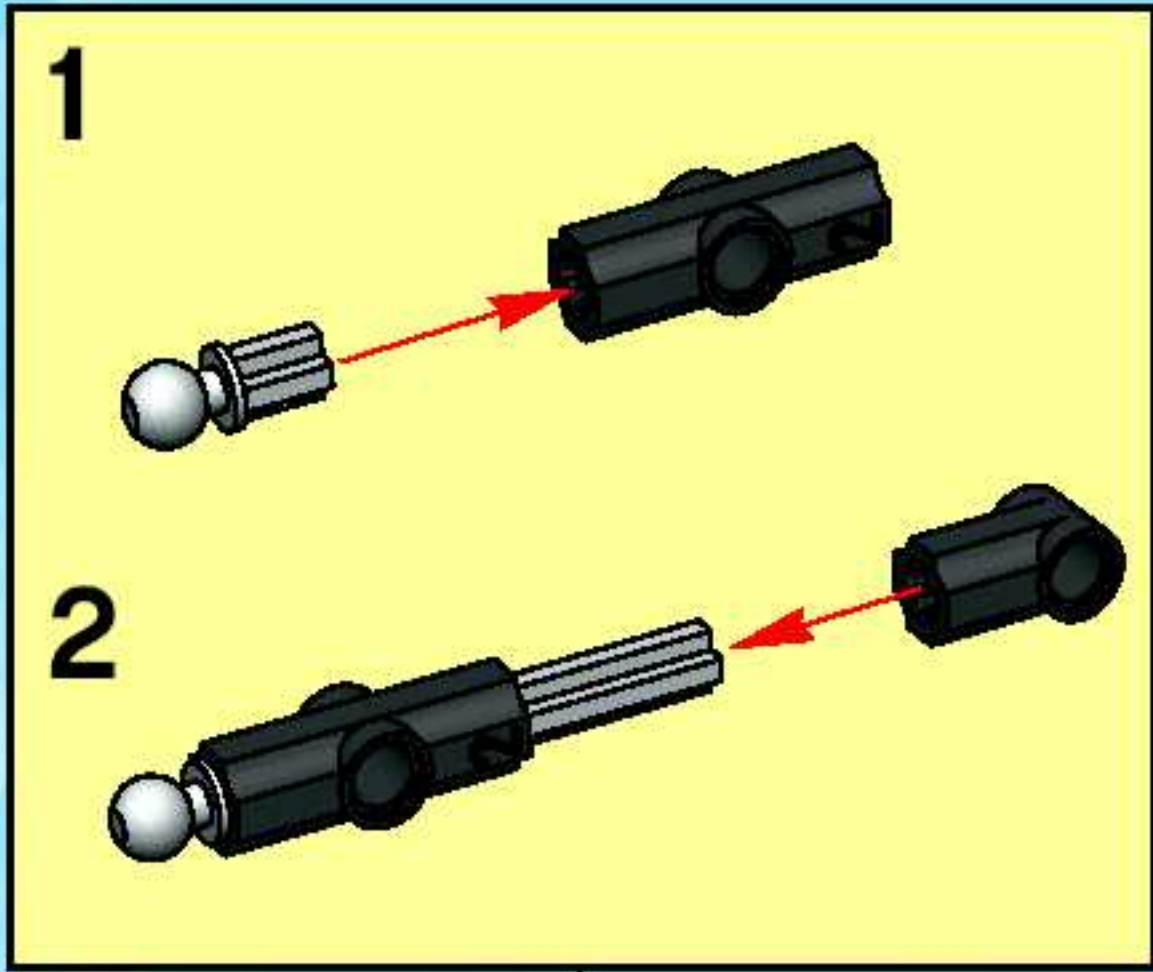

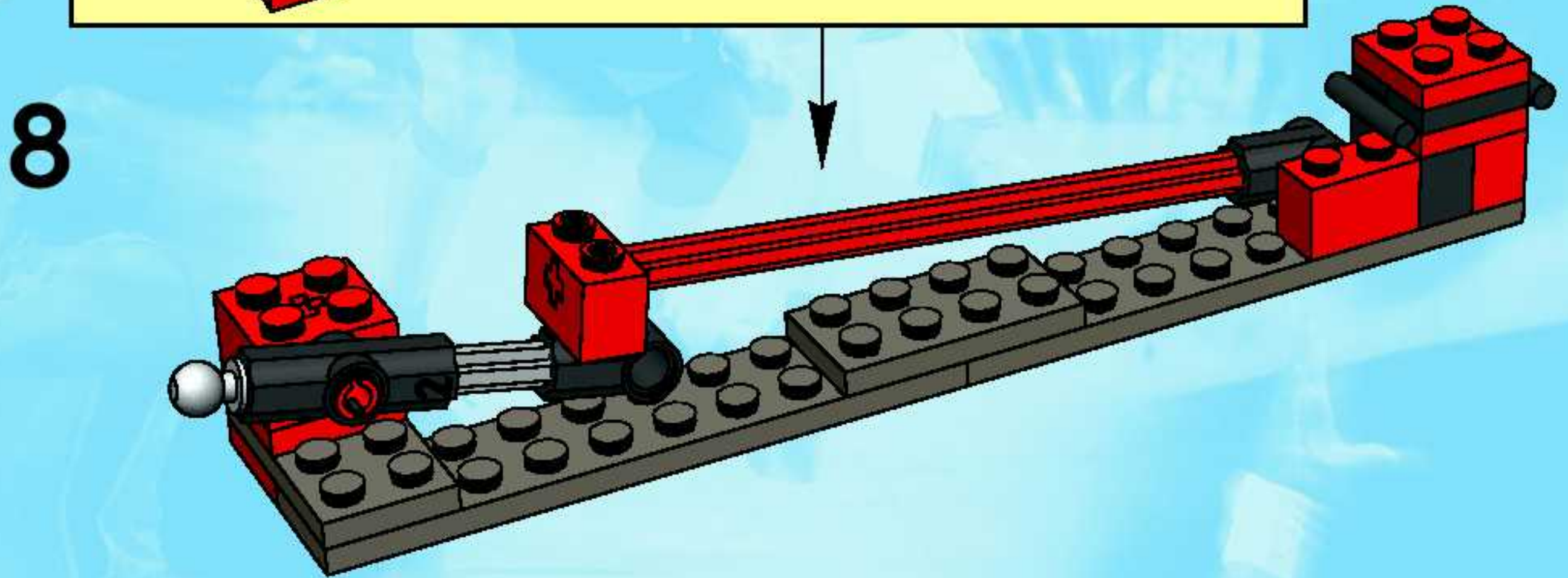
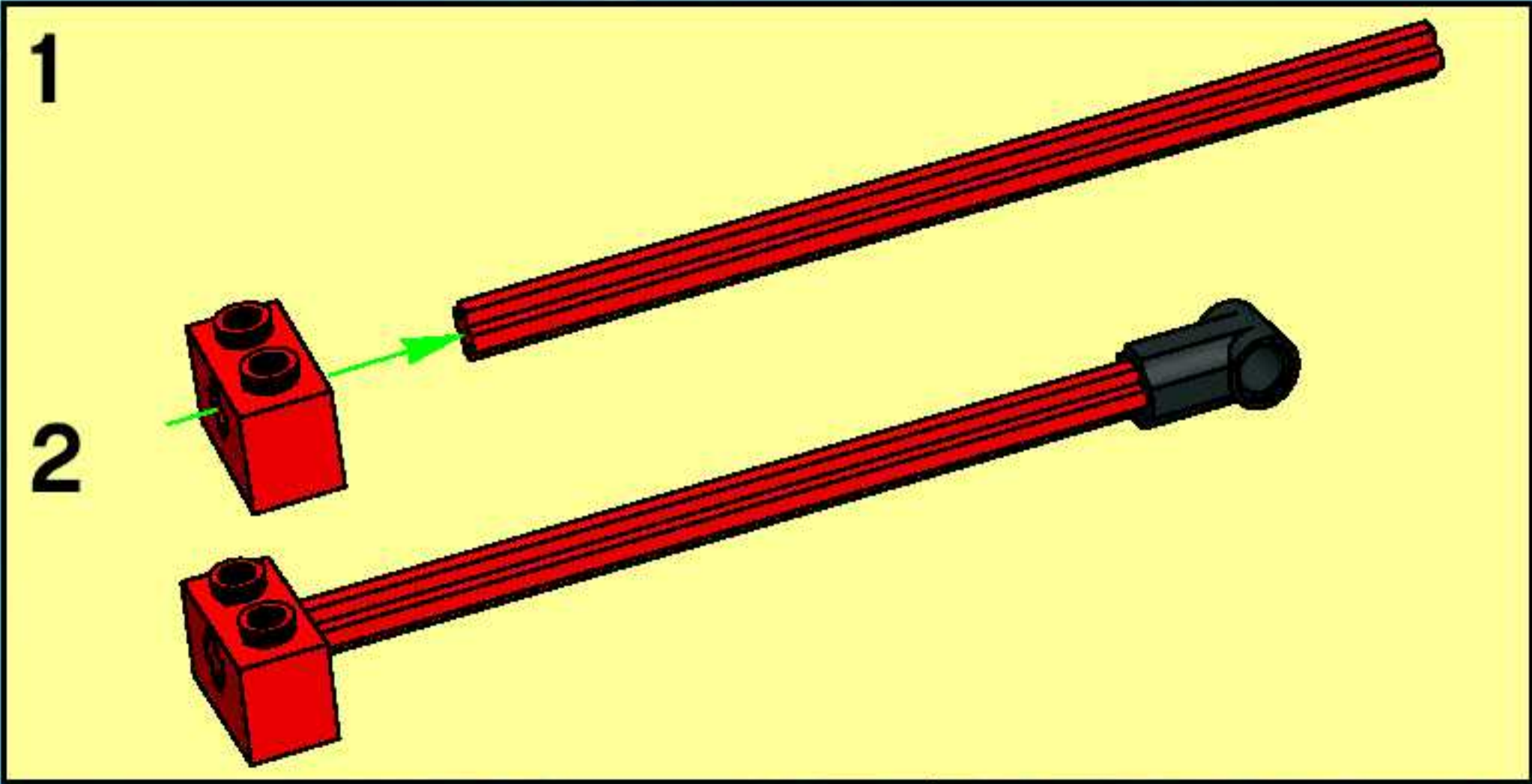

8

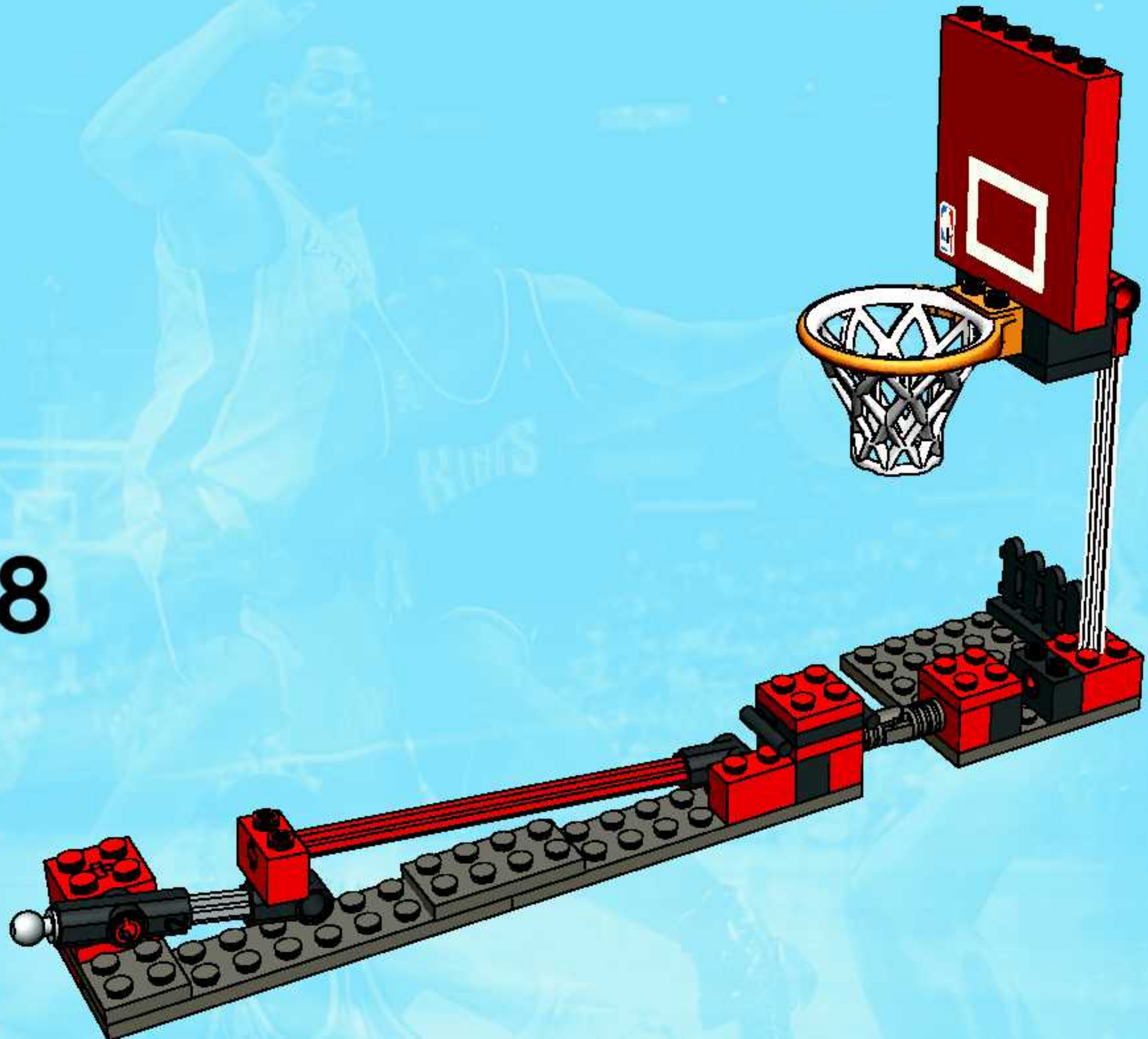

9

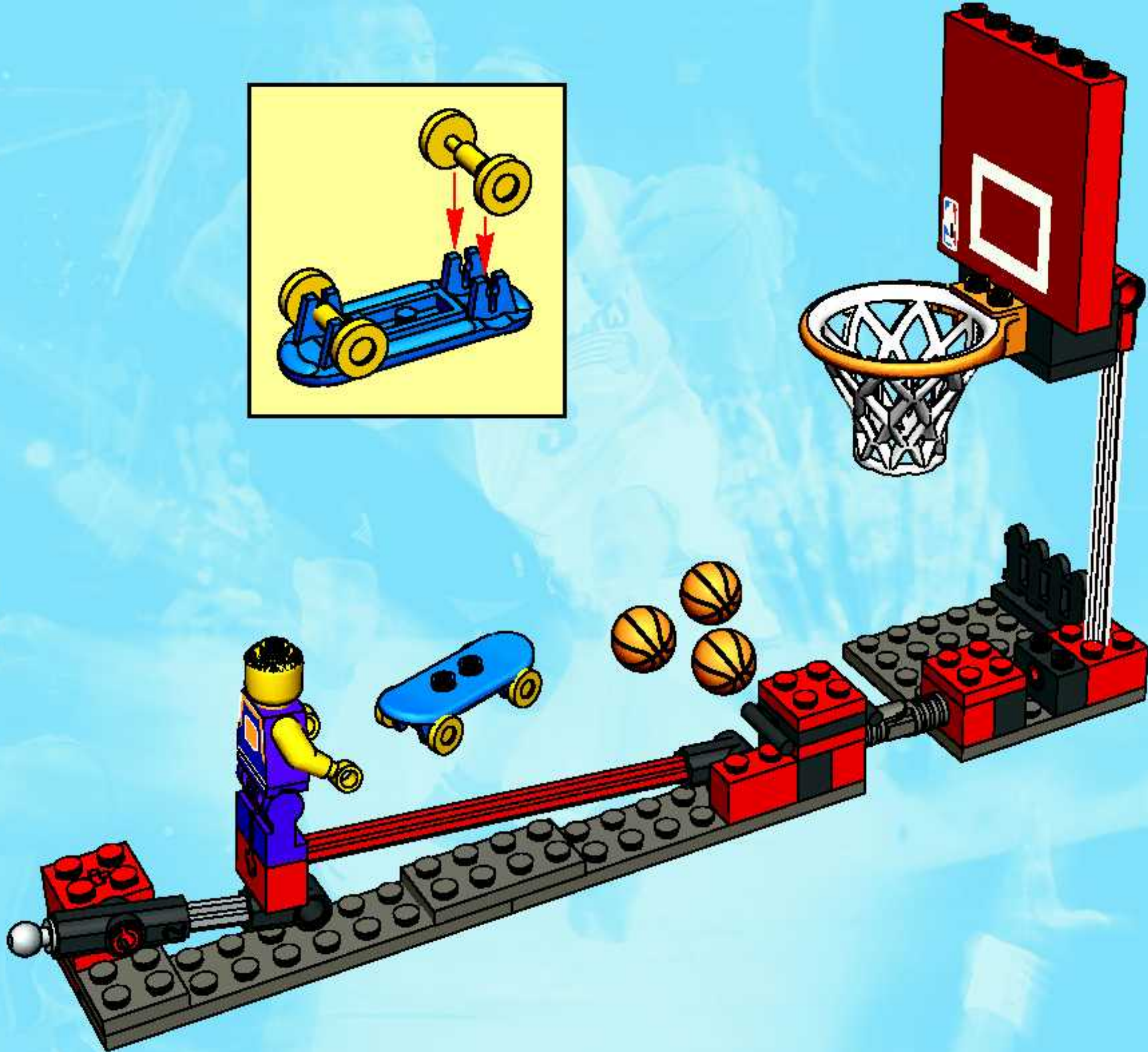
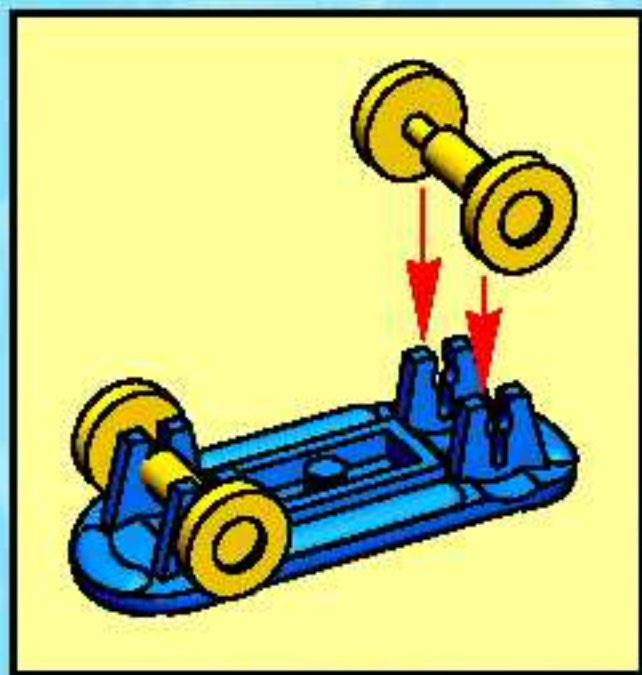



[www.LEGO.com](http://www.LEGO.com)

**NBA.COM**







#3427 + #3428







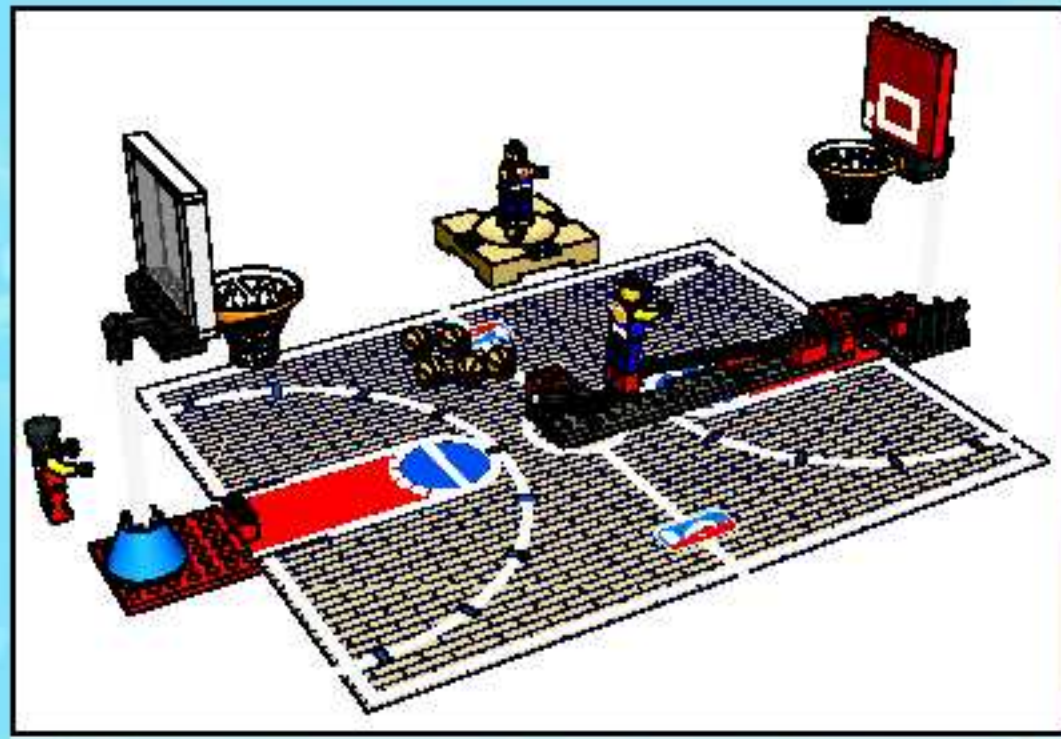

1

3428+3427

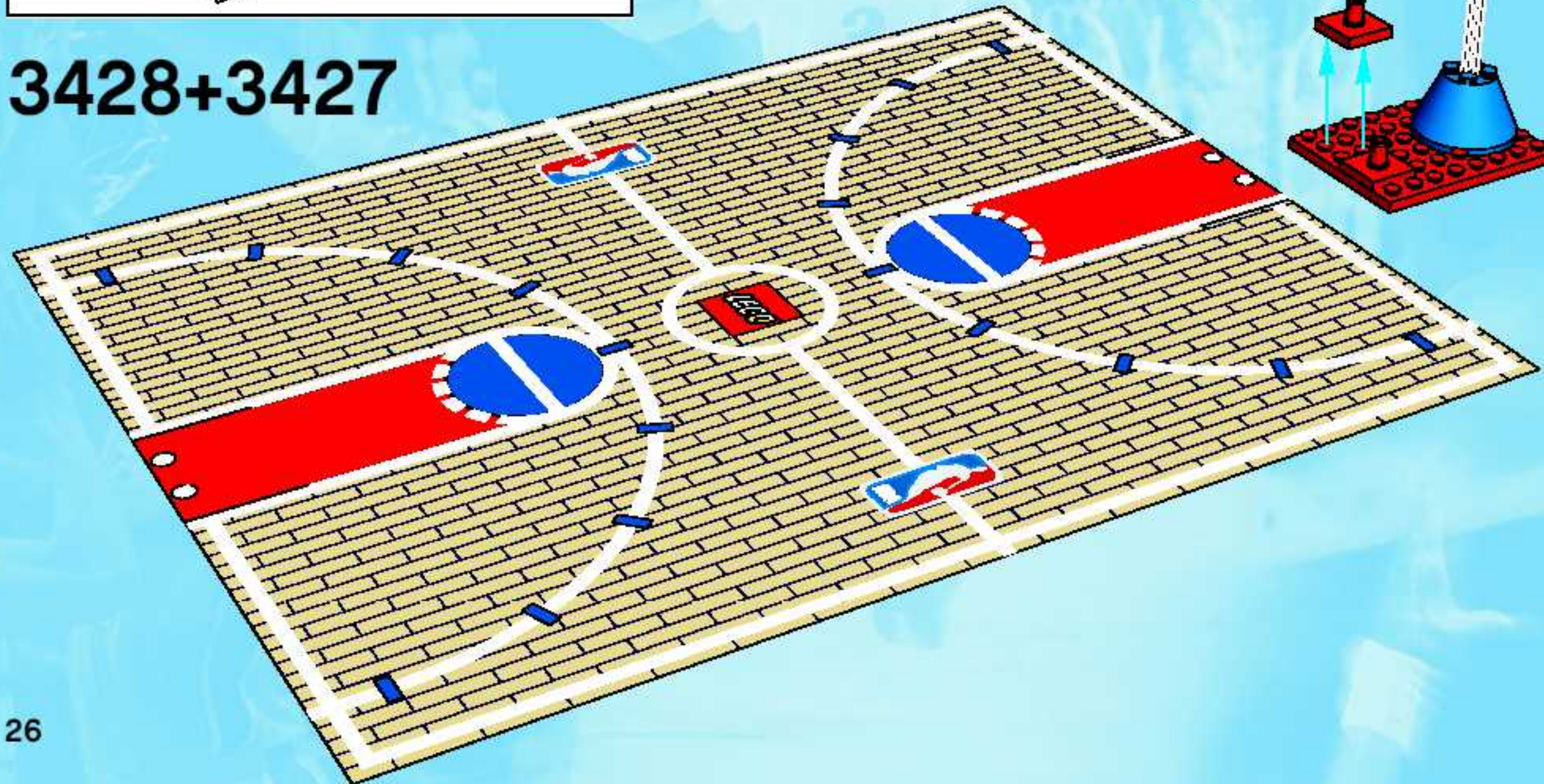

2

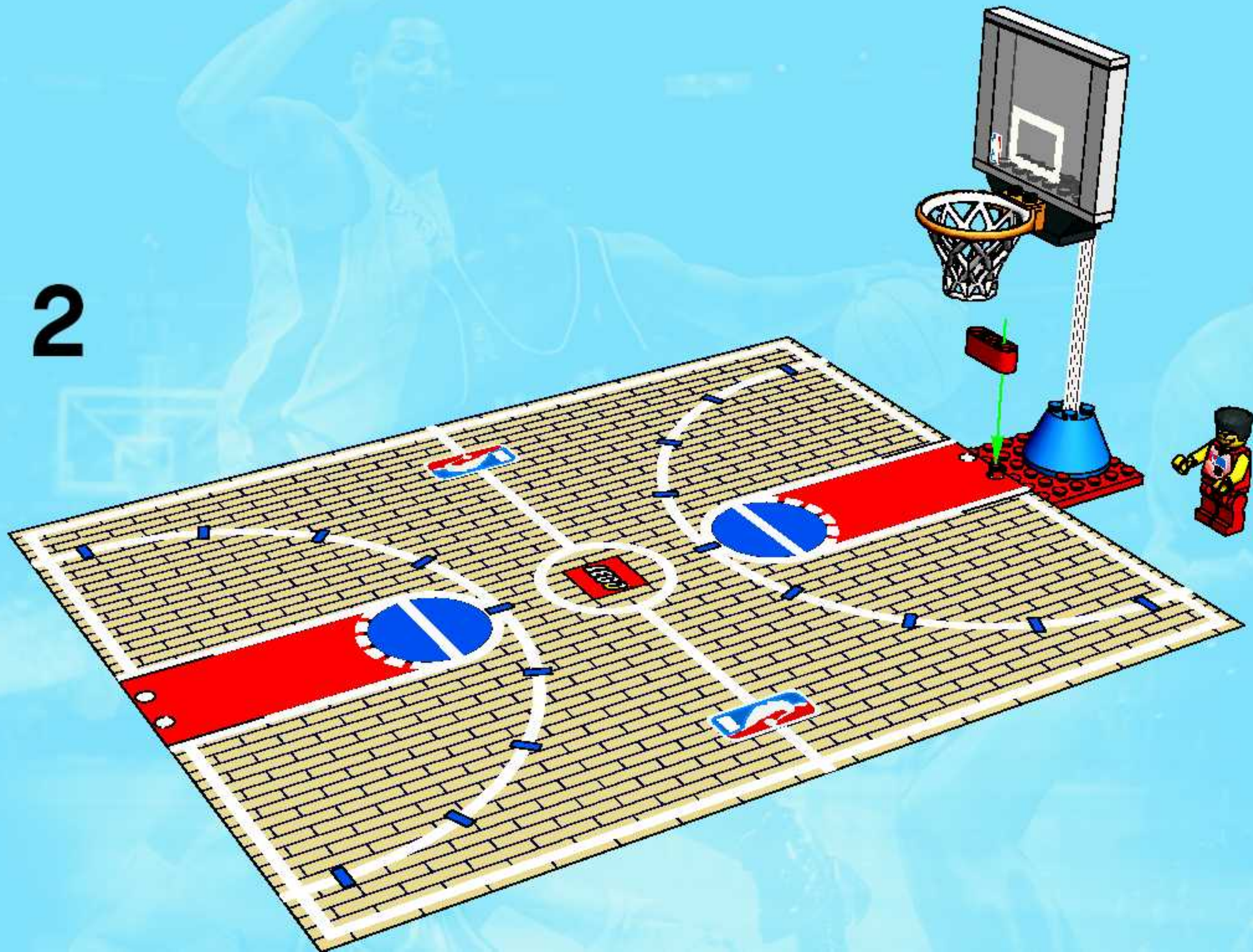

3



4



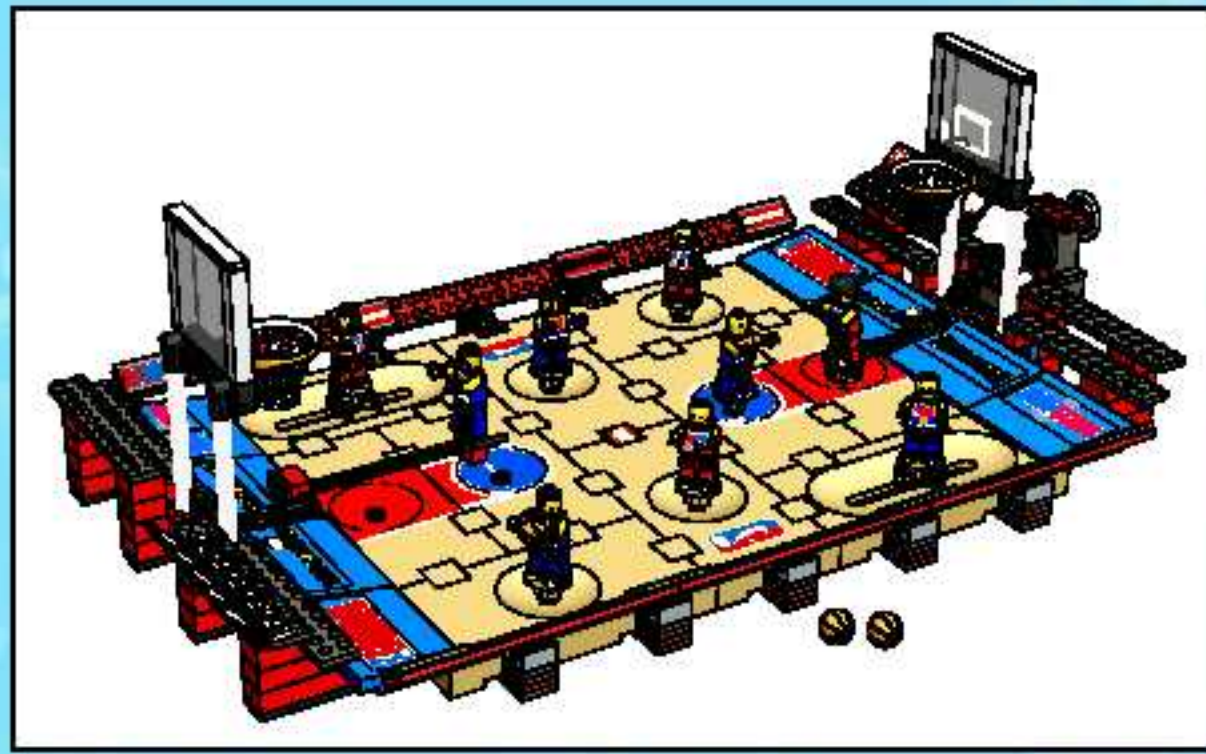

3427 + 3432

1

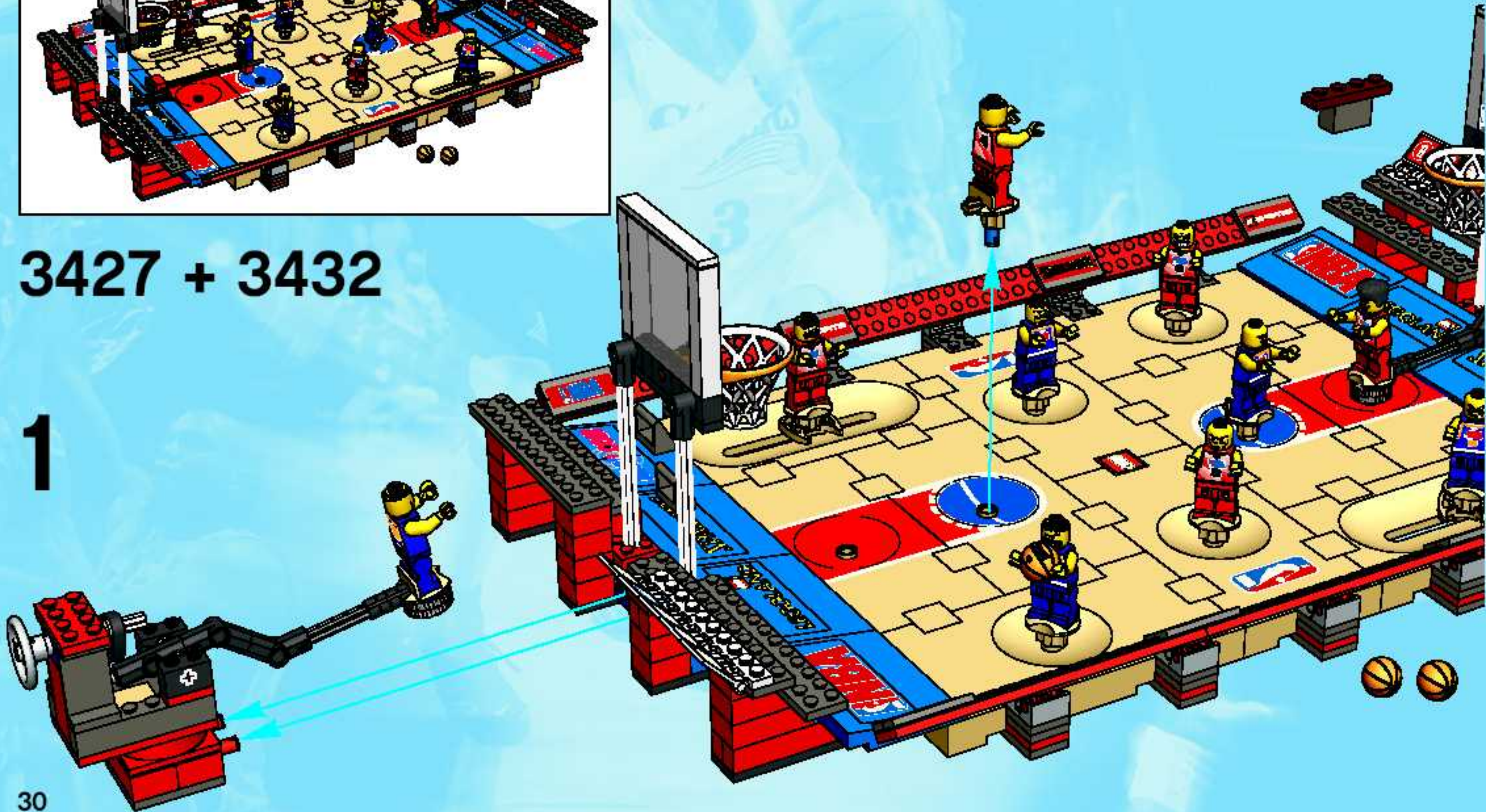

2

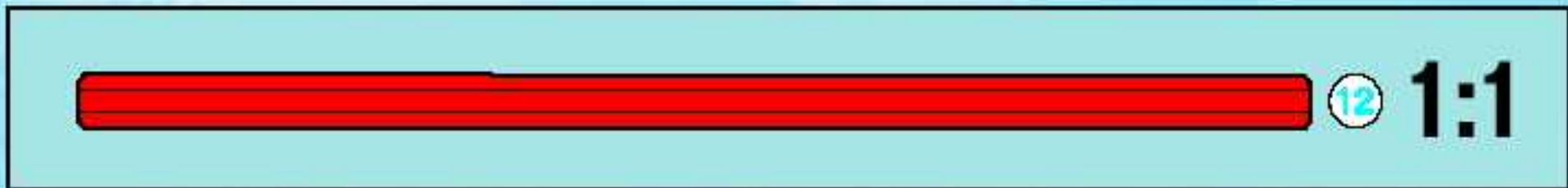
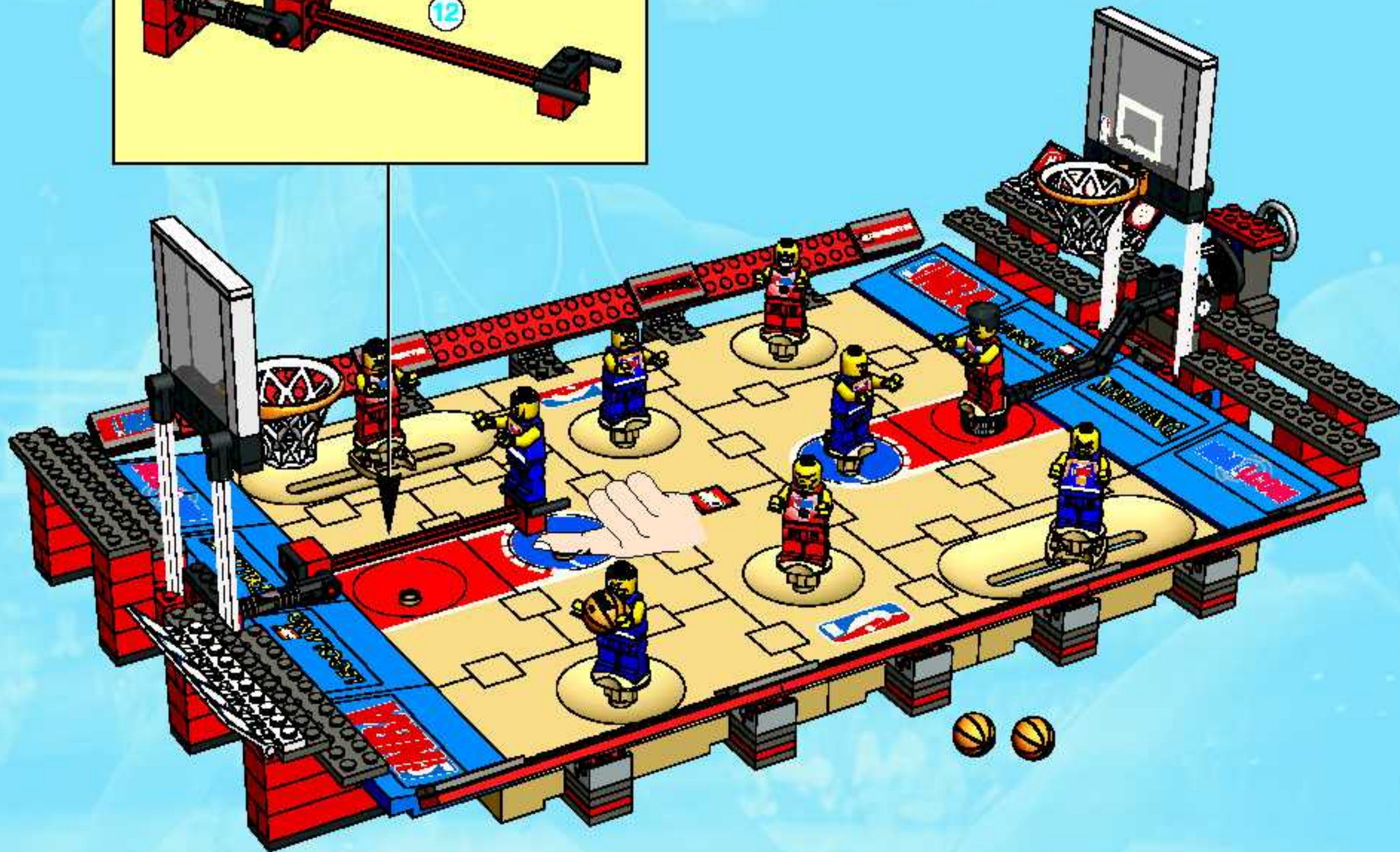
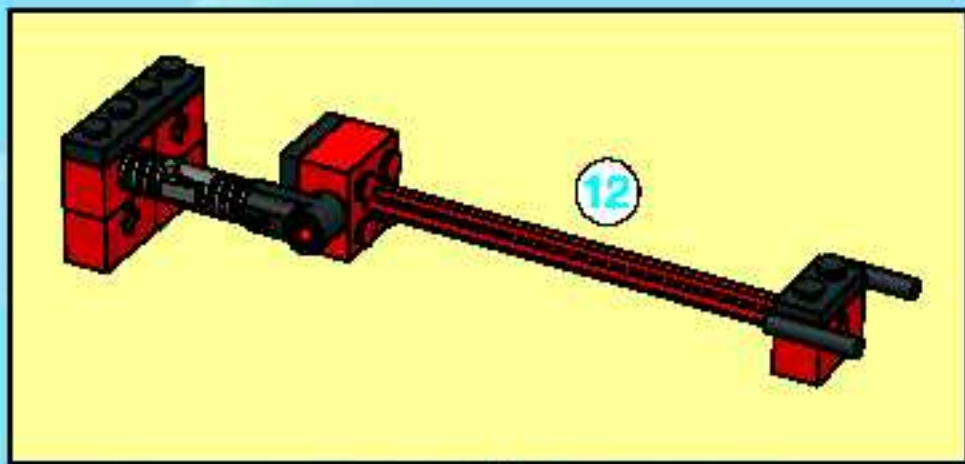



# SPORTS

adidas, the adidas logo and the three stripe trademark are registered trademarks of the adidas-Salomon group, used with permission. Fevemova and the Trigon logo are trademarks of the adidas-Salomon group, used with permission.

adidas, le logo adidas et la marque aux trois bandes sont des marques déposées du groupe adidas-Salomon, utilisées avec sa permission. Fevemova et le logo Trigon sont des marques déposées du groupe adidas-Salomon, utilisées avec sa permission.

adidas, el logotipo adidas y el símbolo de tres bandas son marcas registradas del grupo adidas-Salomon y se utilizan con autorización. Fevemova y el logotipo Trigon son marcas registradas del grupo adidas-Salomon y se utilizan con autorización.



NBA identifications depicted are the exclusive property of NBA Properties, Inc. and/or the NBA Member Teams, and are used with permission.

Les identifications NBA reproduites sont la propriété exclusive de NBA Properties, Inc. et/ou des équipes membres de la NBA et sont reproduites sous autorisation.

Las identificaciones retratadas de la NBA son propiedad exclusiva de NBA Properties, Inc. y/o de los miembros de los equipos de la NBA, y son usados bajo permiso.



LEGO and the LEGO logo are trademarks of/son des marques de commerce de/son marcas registradas de LEGO Group.  
©2003 The LEGO Group.



[www.LEGO.com](http://www.LEGO.com)

SPALDING is a trademark of/est une marque de commerce de/ es una marca registrada de Spalding Sports Worldwide, Inc. or/ou/ Lisco Sports, Inc., a Spalding affiliate/une filiale de Spalding/un afiliado de Spalding. ©Spalding Sports Worldwide, Inc. 2003.

