



Disney

40521





LE MANOIR HANTÉ DU PARC DISNEYLAND®

Construit en 1963 et ouvert aux visiteurs téméraires en 1969, le manoir hanté du parc Disneyland® se dresse majestueusement au cœur de New Orleans Square. Les résidents spectraux veillent à ce que l'extérieur soit d'un blanc fantomatique impeccable, avec d'élégantes rampes en fer forgé en guise de décoration. La girouette sur le toit est un magnifique voilier.

Conçu à l'origine comme une maison hantée au bout de Main Street, U.S.A., le manoir est devenu une maison de retraite pour fantômes qui garantit « des portes et des planchers qui grincent » à tous les occupants potentiels. Des esprits surexcités se sont déplacés des maisons hantées du monde entier pour y passer leur dernier repos, et 999 joyeux fantômes y résident actuellement (mais il reste toujours de la place pour un millier !).

MANSIÓN EMBRUJADA DE DISNEYLAND® PARK

Construida en 1963 e inaugurada para sus osados huéspedes en 1969, la Mansión Embrujada de Disneyland® Park se erige majestuosa en New Orleans Square. Los espectros que la habitan se toman mortalmente en serio el mantenimiento del exterior en un impecable blanco fantasmal con elegantes barandales de hierro forjado como decoración. La veleta del tejado es un señorial barco de vela.

Originalmente concebida como una casa embrujada ubicada al final de Main Street (EE. UU.), la mansión se transformó en una residencia para fantasmas que prometía "puertas rechinantes y suelos chirriantes" a todos sus posibles inquilinos. Numerosos espíritus se mudaron aquí con entusiasmo desde casas embrujadas de todo el mundo en busca de su descanso final, con 999 felices fantasmas actualmente alojados (¡aunque siempre hay espacio para mill!).

DISNEYLAND® PARK HAUNTED MANSION

Constructed in 1963 and opened to daring guests in 1969, the Disneyland® Park Haunted Mansion stands as a majestic manor in New Orleans Square. The spectral residents are dead serious about keeping its exterior a spotless ghostly white, with elegant wrought-iron railings serving as an accent piece. The weathervane on the roof is a stately sailing vessel.

Envisioned initially as a haunted house at the end of Main Street, USA, the Mansion eventually transformed into a retirement home for ghosts which promised 'creaking doors and creaking floors' to all prospective tenants. Excited spirits relocated from haunted houses all over the world to make their final rest, with 999 happy haunts currently in residence (but there's always room for a thousand!).



The brave souls who make their way past the foyer will find a place filled with wall-to-wall creeps, endless hallways, stretching rooms and many other ghoulish delights. A mysterious Ghost Host offers up a spirited tour to guests as they explore, transporting them in a "Doom Buggy" through the mansion and into the gloomy graveyard beyond. Just beware of hitchhiking ghosts you find along the way, or one of them may follow you home!

Les âmes courageuses qui franchiront le seuil découvriront un endroit rempli de monstres, de couloirs sans fin, de pièces biscornues et de bien d'autres curiosités macabres. Un mystérieux hôte fantôme offre une visite guidée animée aux invités, les transportant à bord d'un buggy à travers le manoir jusqu'au lugubre cimetière. Méfiez-vous des fantômes que vous rencontrez en chemin, ou l'un d'eux pourrait bien vous suivre chez vous !

Las valientes almas que se atreven a pasar del vestíbulo encuentran un terrorífico lugar de pared a pared, pasillos interminables, salas que crecen y otras muchas maravillas sobrenaturales. Un misterioso anfitrión fantasma ofrece un animado paseo a los visitantes para explorar la zona, transportándolos en un "buggy maldito" por la mansión y el tenebroso cementerio que hay afuera. Solo ten cuidado con los fantasmas que puedes encontrarte haciendo autostop por el camino. ¡Podría ser que alguno de ellos acabe siguiéndote de regreso a casa!





Get excited about our new packaging!

We're switching from plastic to paper-based packaging. That's why you might find a mix of paper and plastic in our boxes!

Nos nouveaux emballages vous emballeront !

Nous passons des emballages en plastique aux emballages à base de papier. C'est pourquoi vous pourriez trouver un mélange de papier et de plastique dans nos boîtes !

¡Te presentamos nuestros nuevos empaques!

Estamos sustituyendo las bolsas de plástico por bolsas con base de papel. ¡Por eso, puedes encontrar una mezcla de papel y de plástico en nuestras cajas!

LEGO.com/sustainable-packaging

1



2

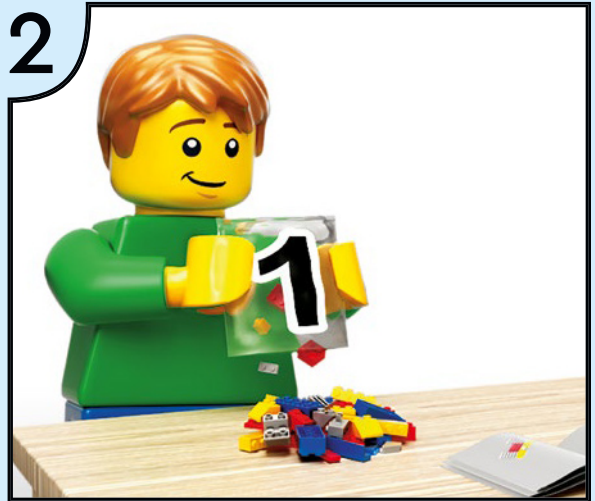

3



4



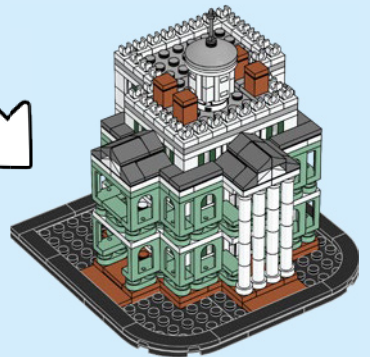
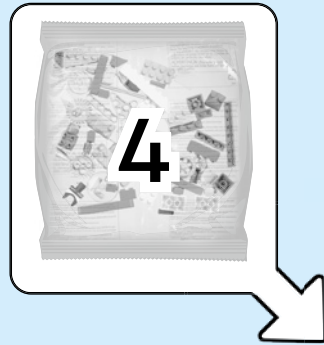
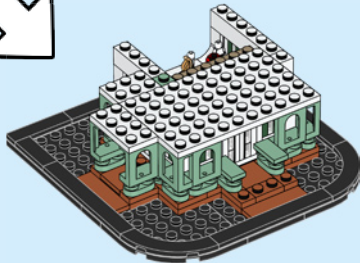
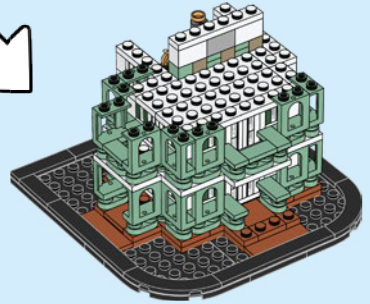
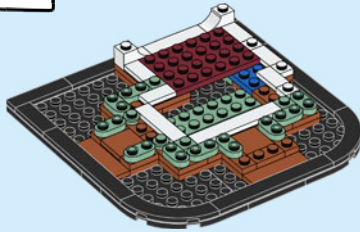



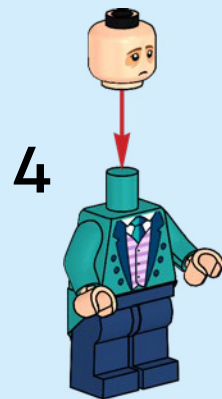
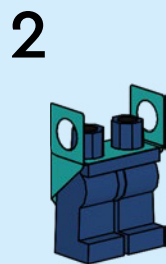
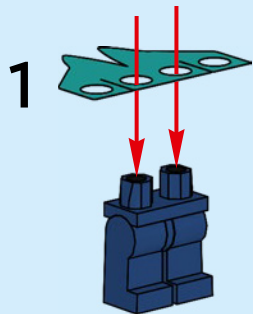

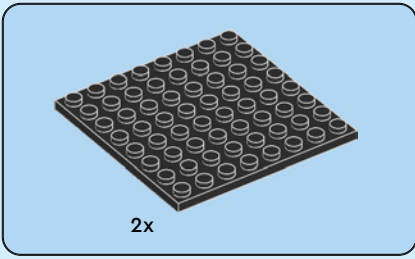

1

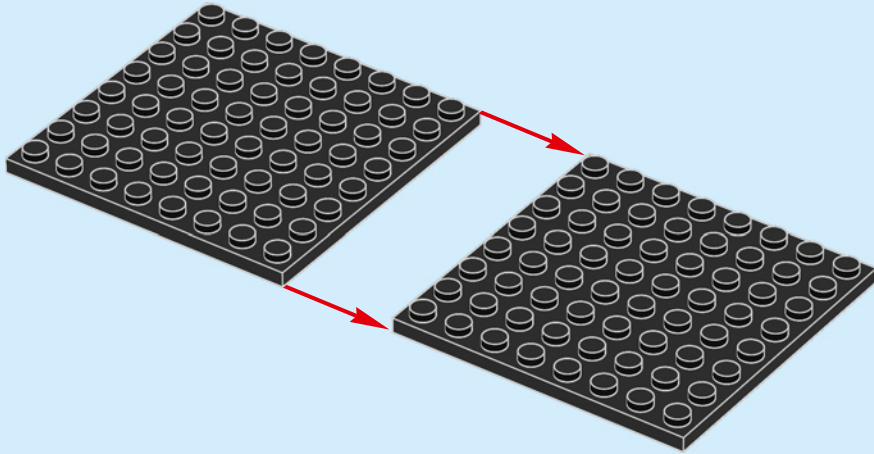

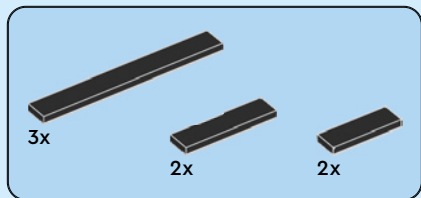

2

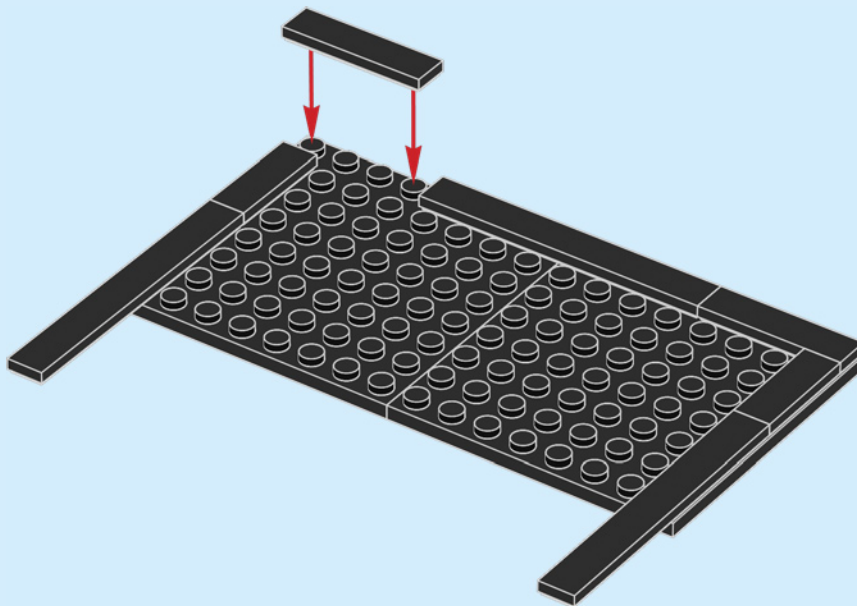

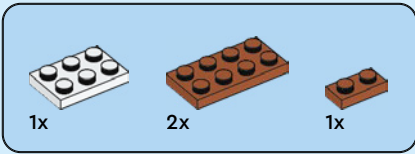

3

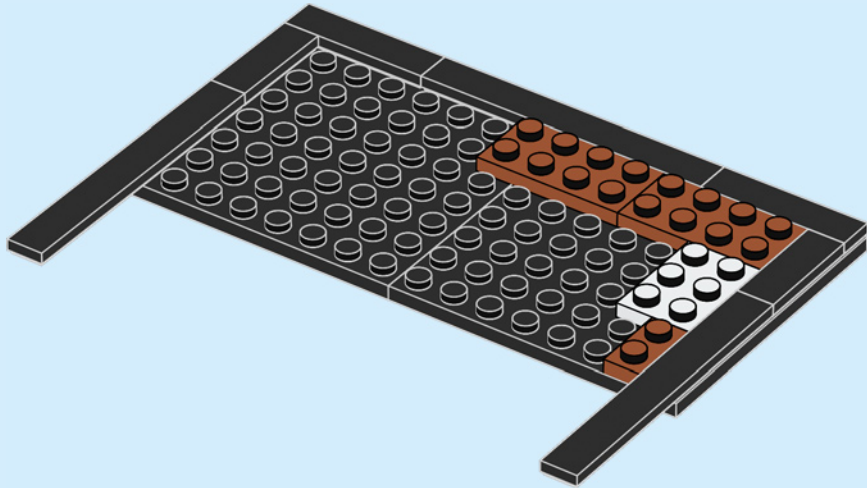

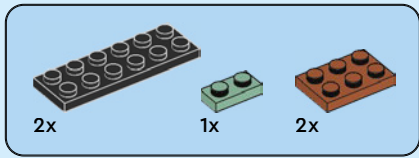

4

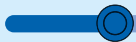
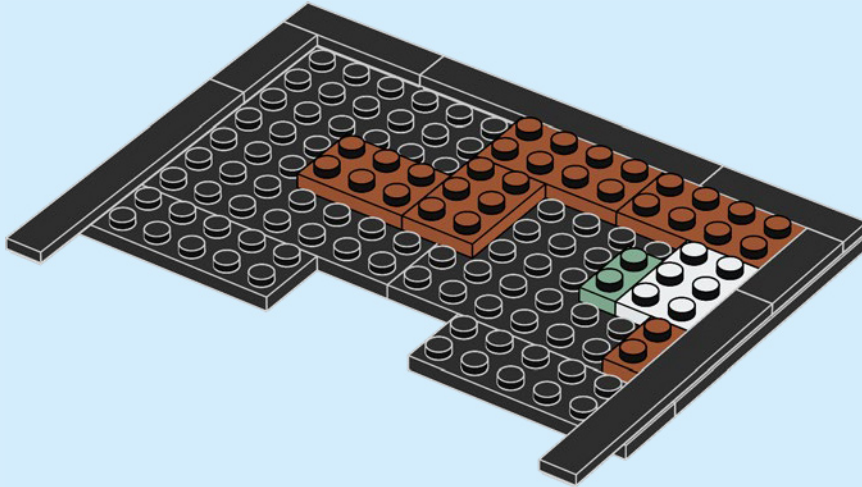

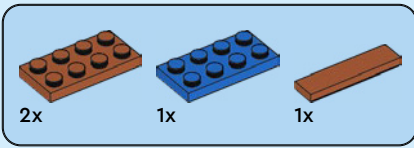

5

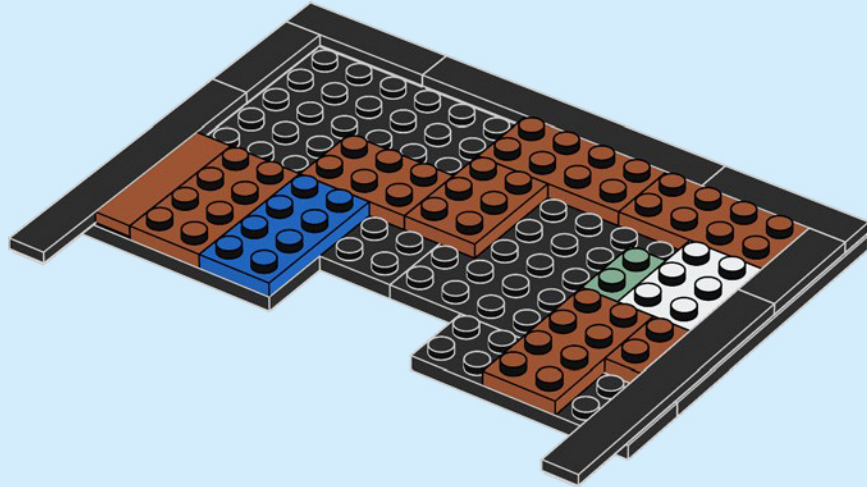

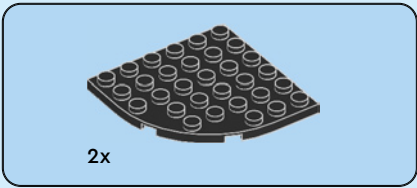

6

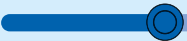
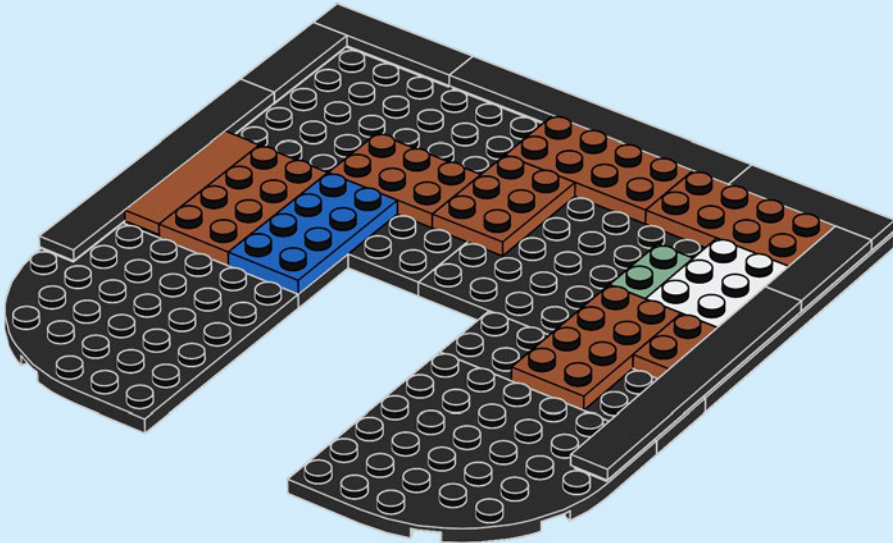

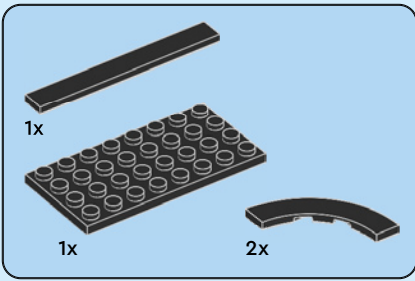

7

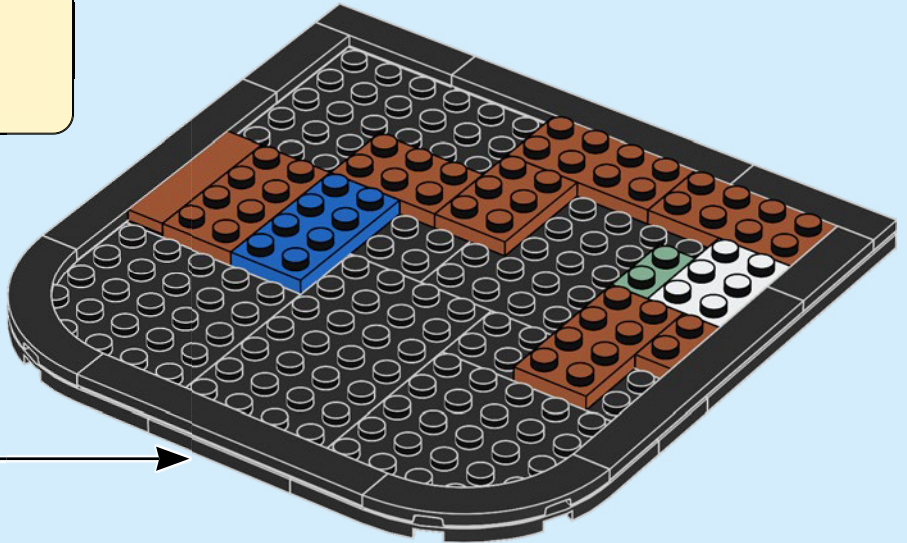
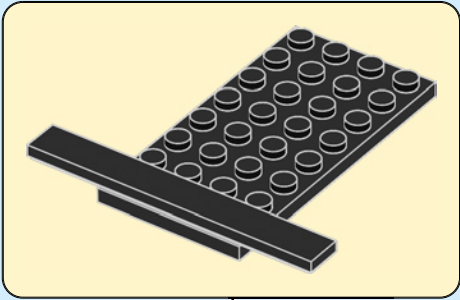

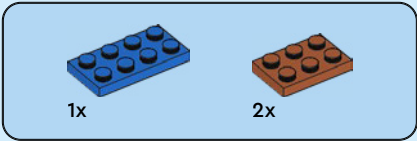

8

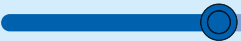
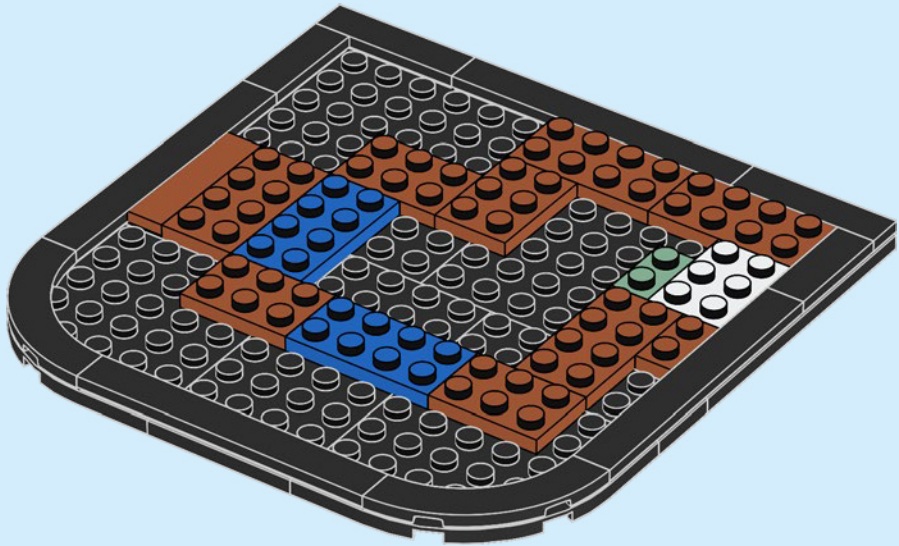

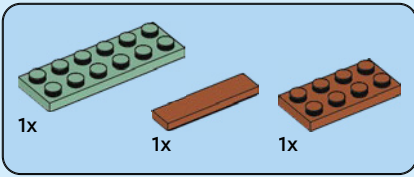

9

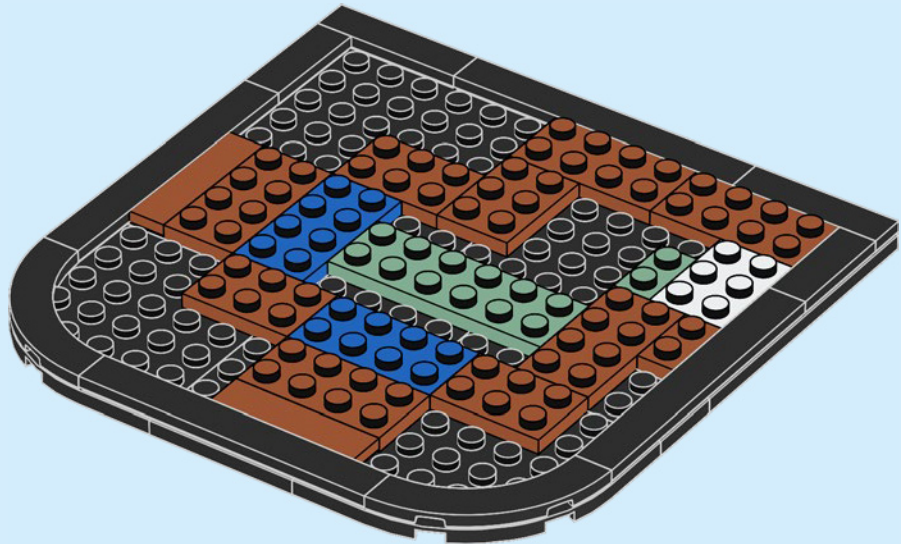

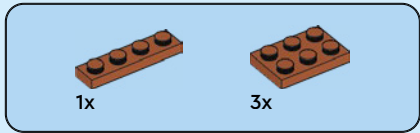

10

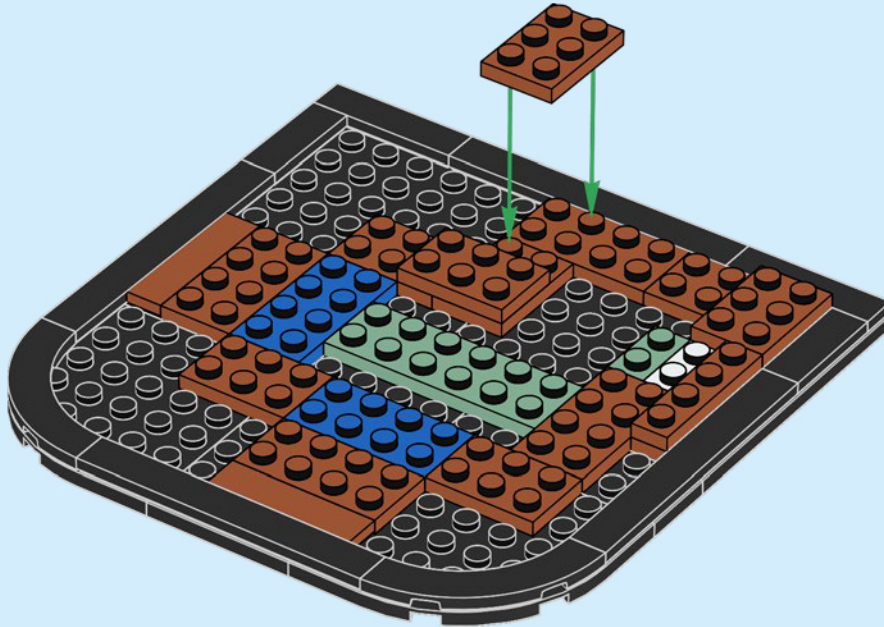

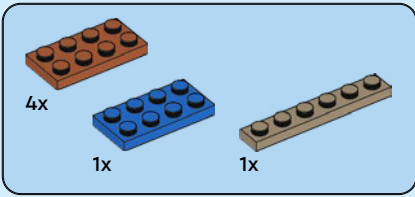

11

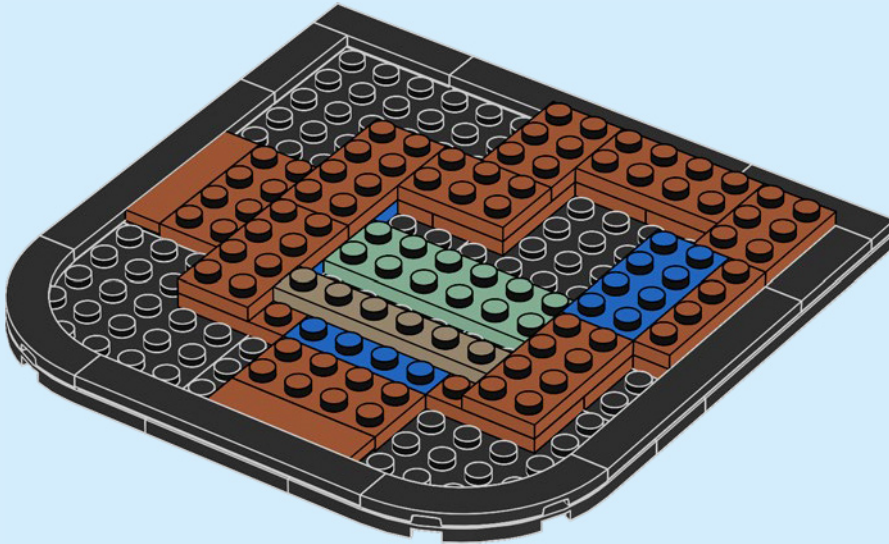

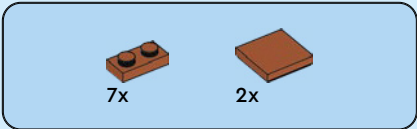

12

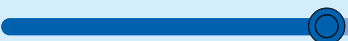
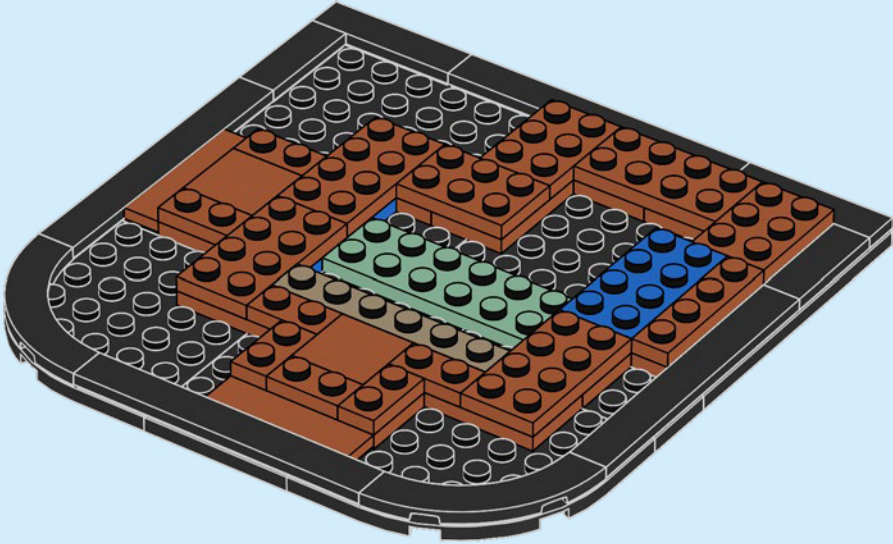

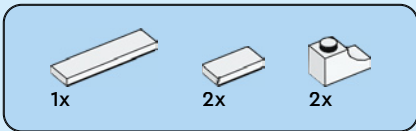

13

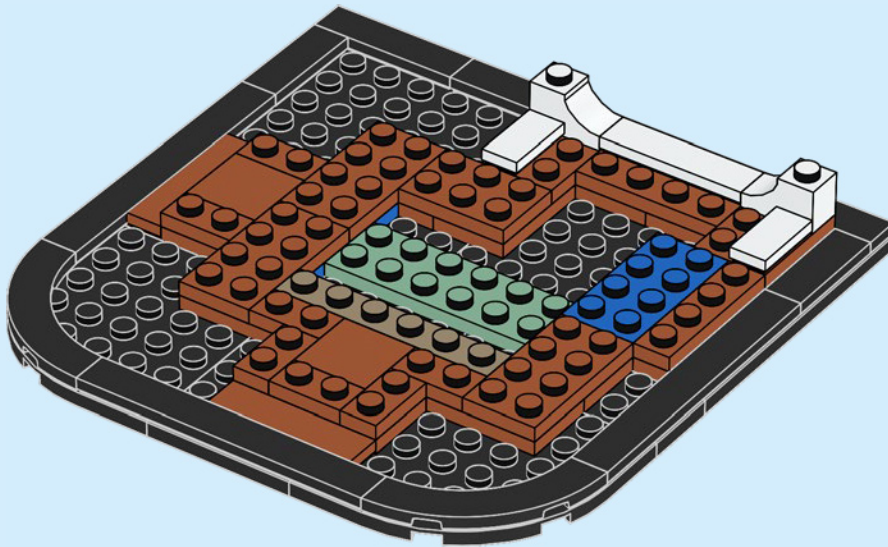



3x



2x

14

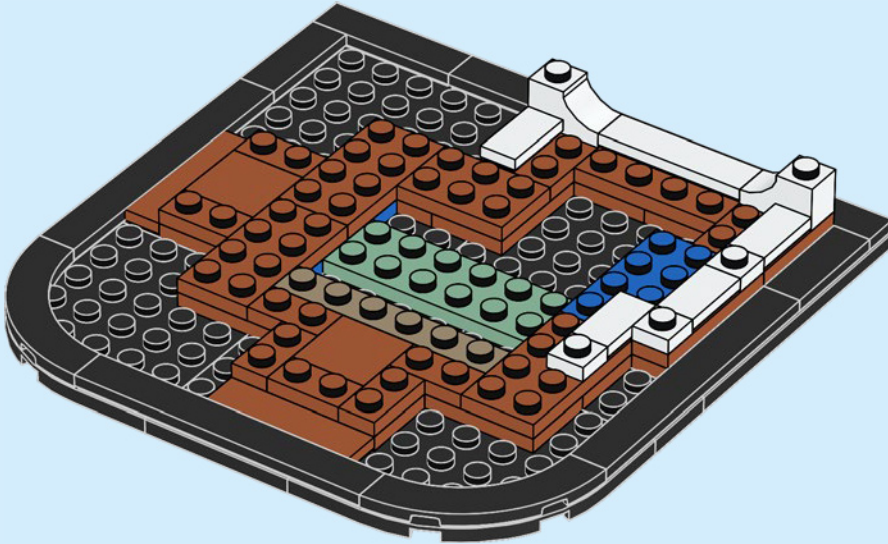

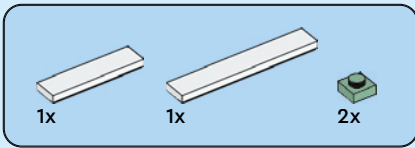

15

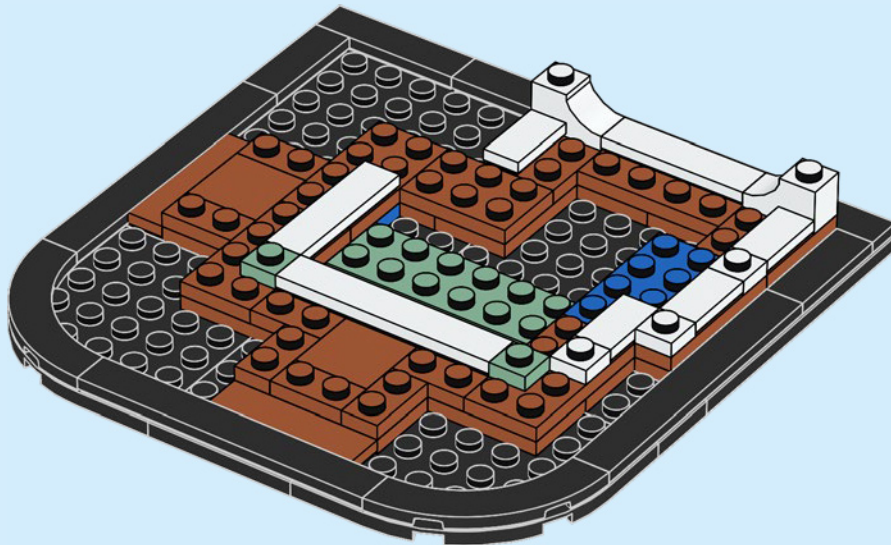

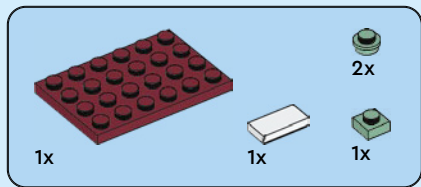

16

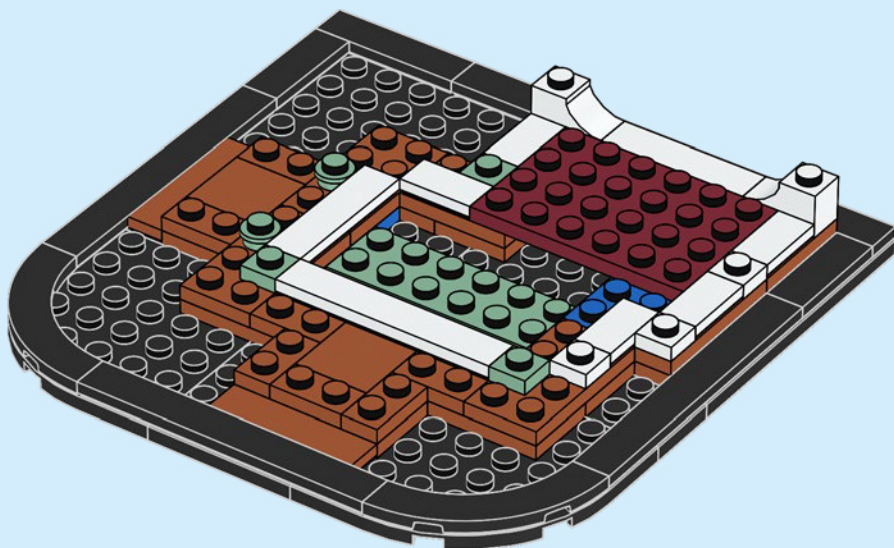



10x

17

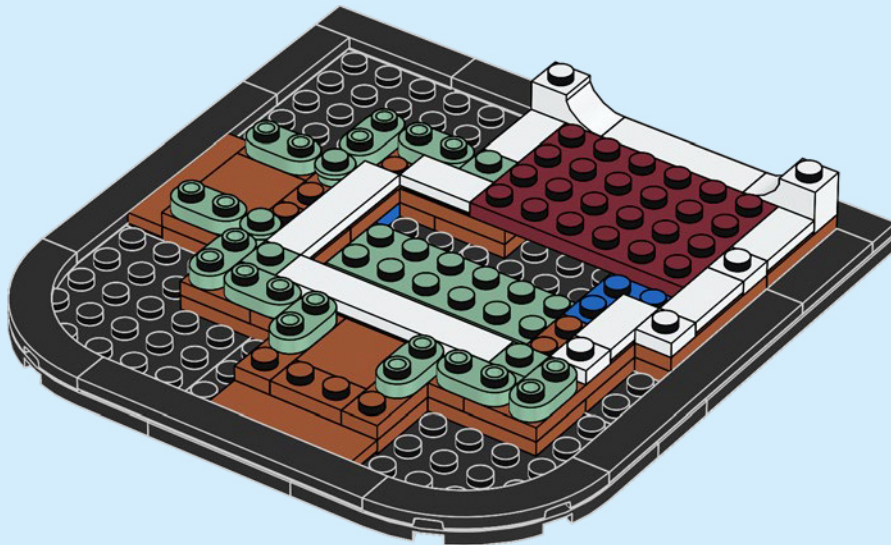





18

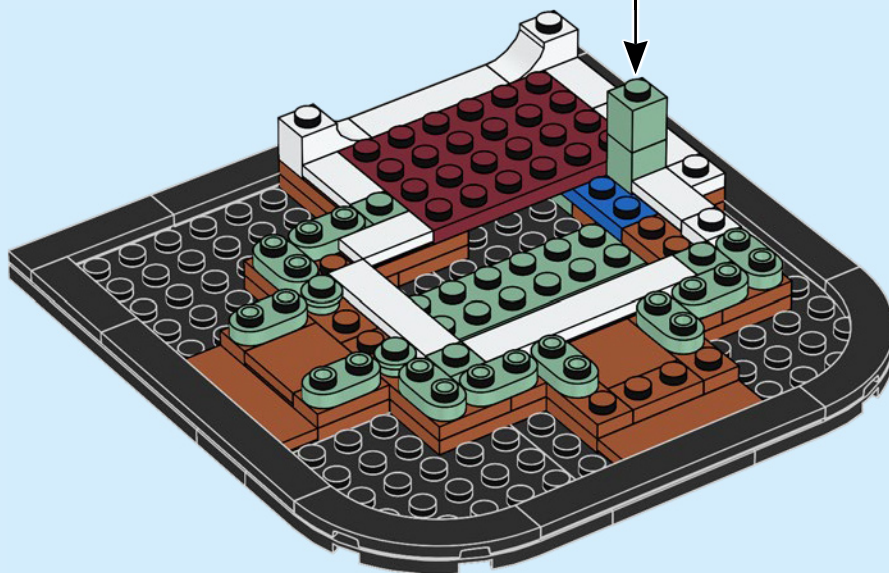
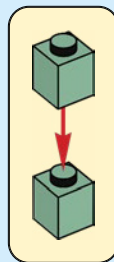

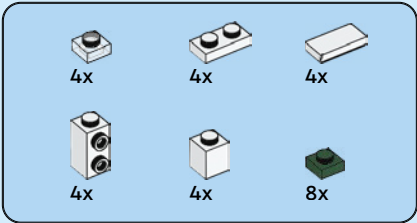

19

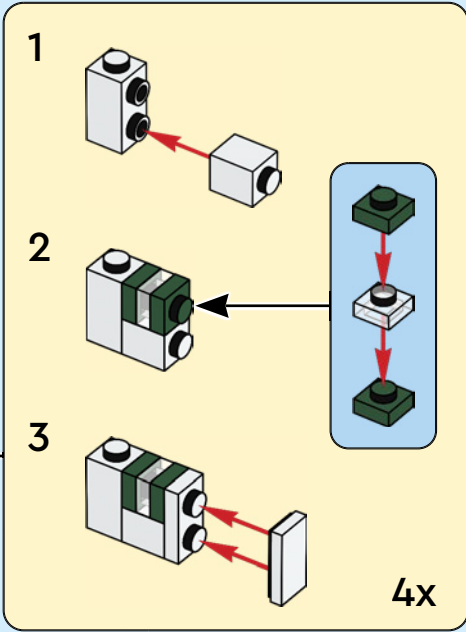
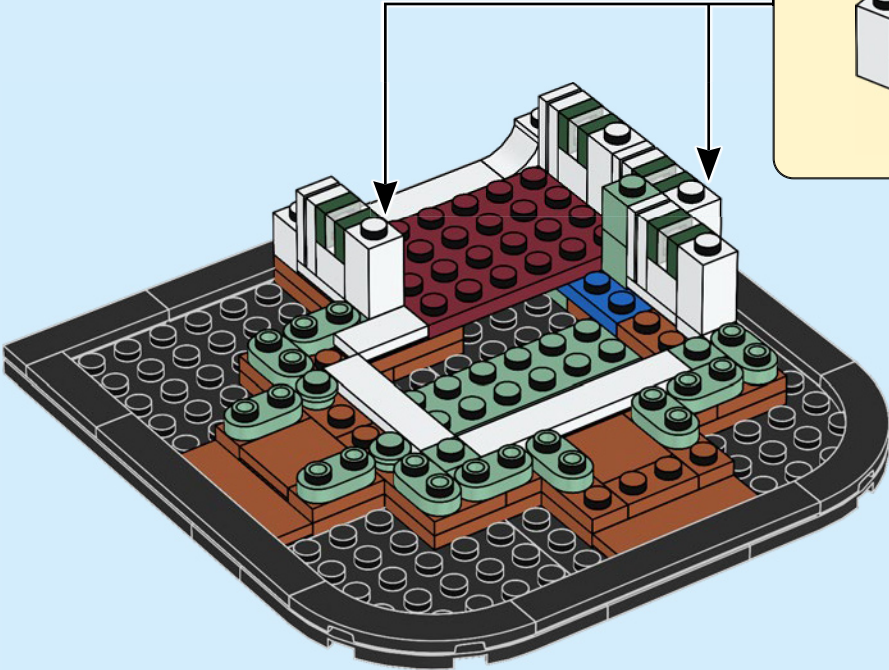



22x

20

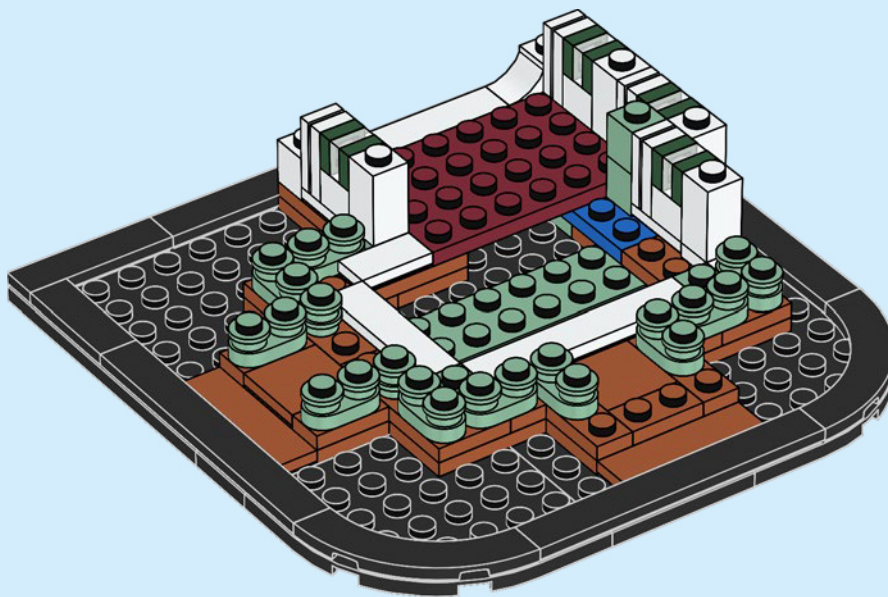



1x

1x

21



4x

2x

22

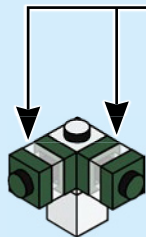

2x



1x



2x



1x

23

1

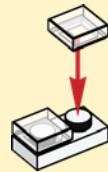

2

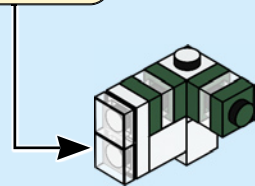
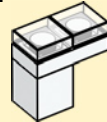

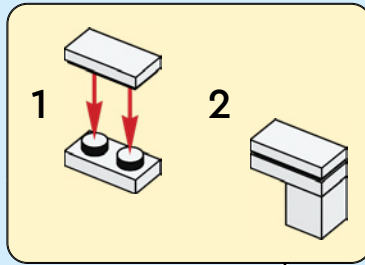
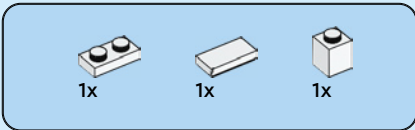

24

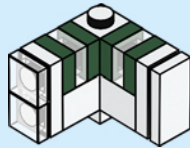

25

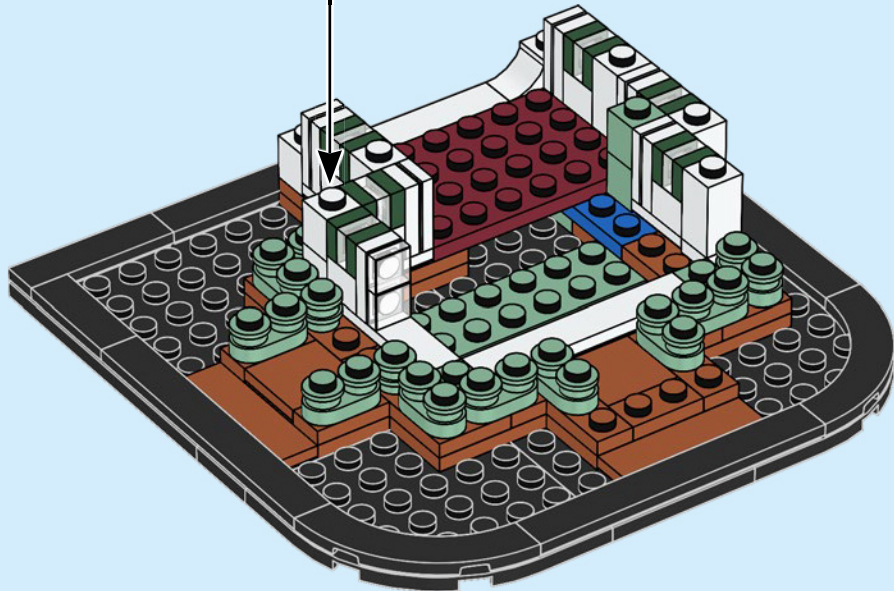

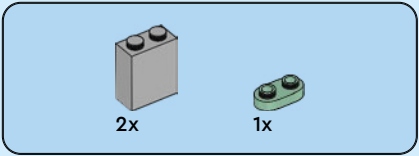

26

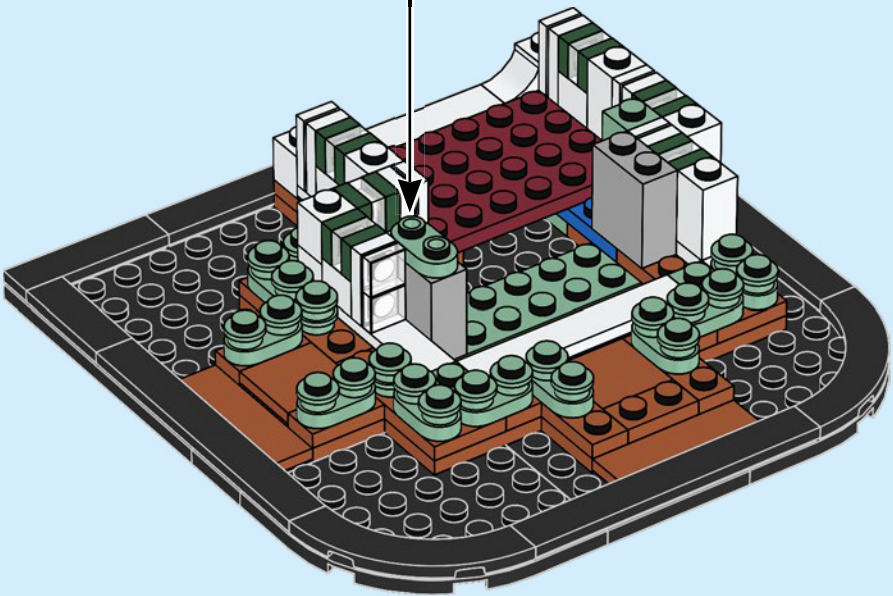
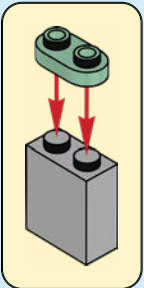



1x



1x

27



1x

28



1x

29

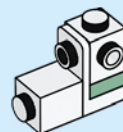

4x



2x

30

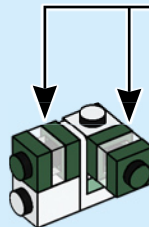

2x



2x



1x



2x

31

1

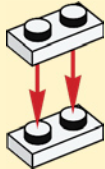

2

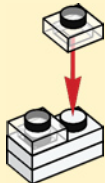

3

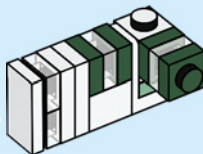

1x



1x



2x

32

1

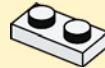

2

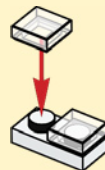

3

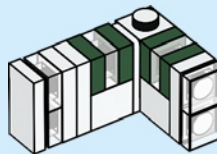

33

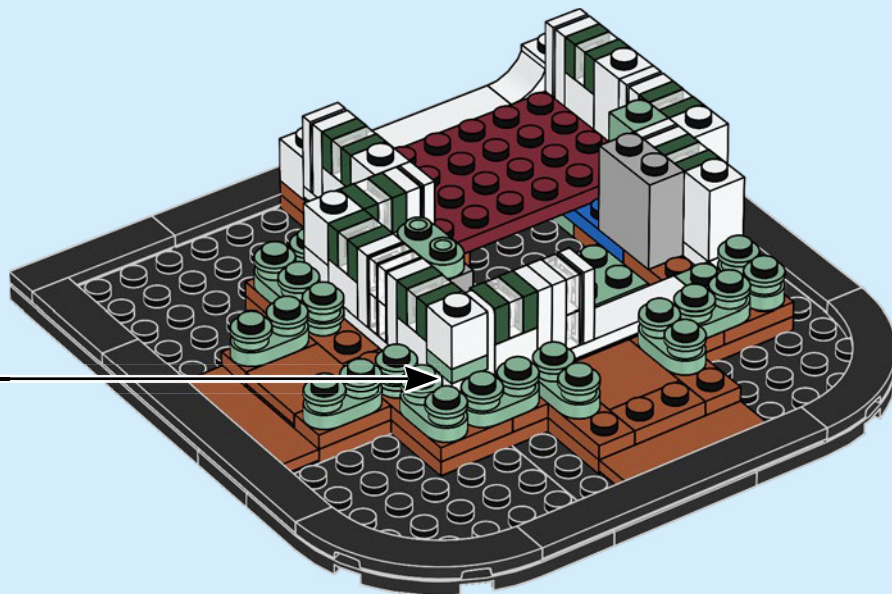



1x

1x

34



2x

35

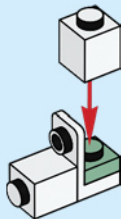

2x



1x

36

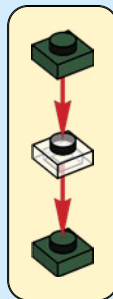

2x



1x



2x

37

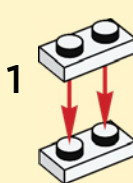

1

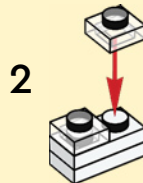

2

3

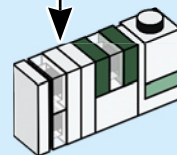

38

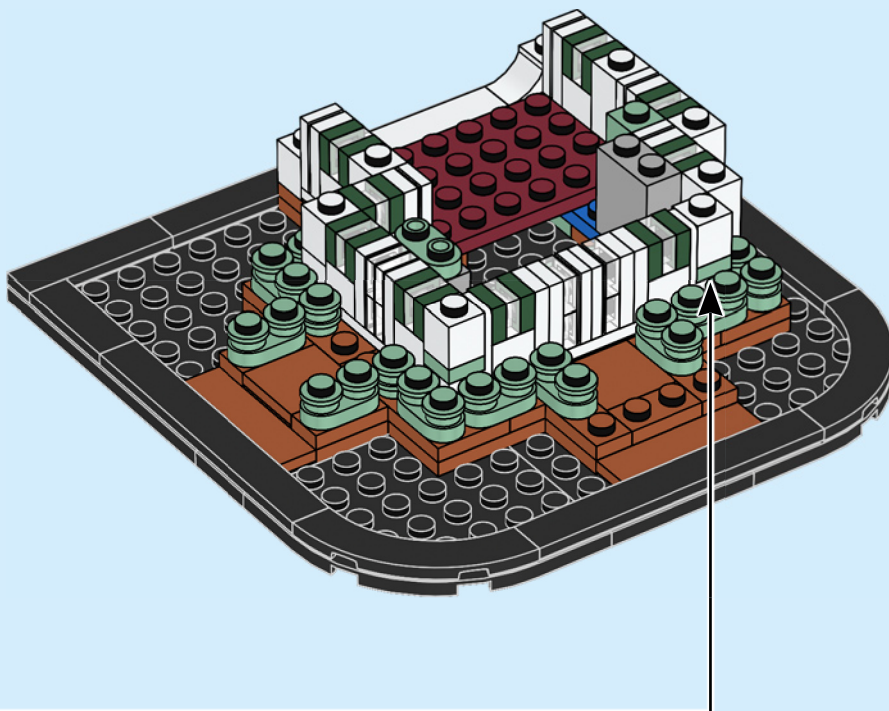

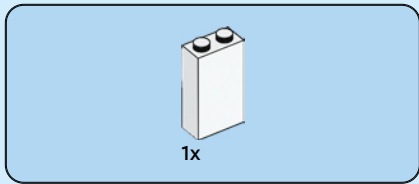

39

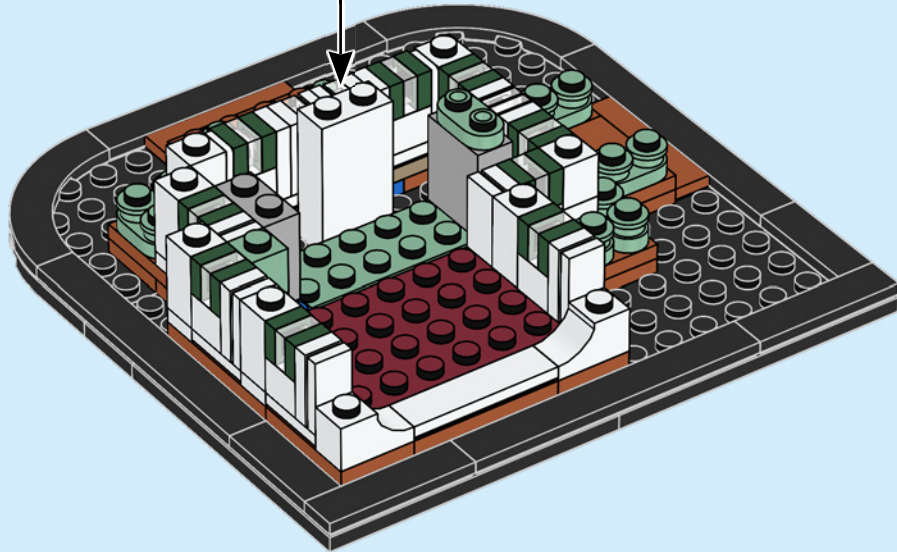
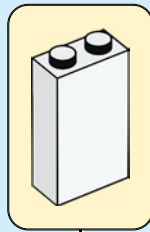

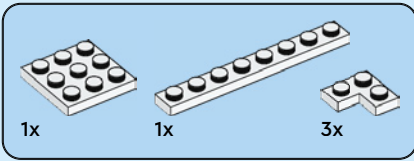

40

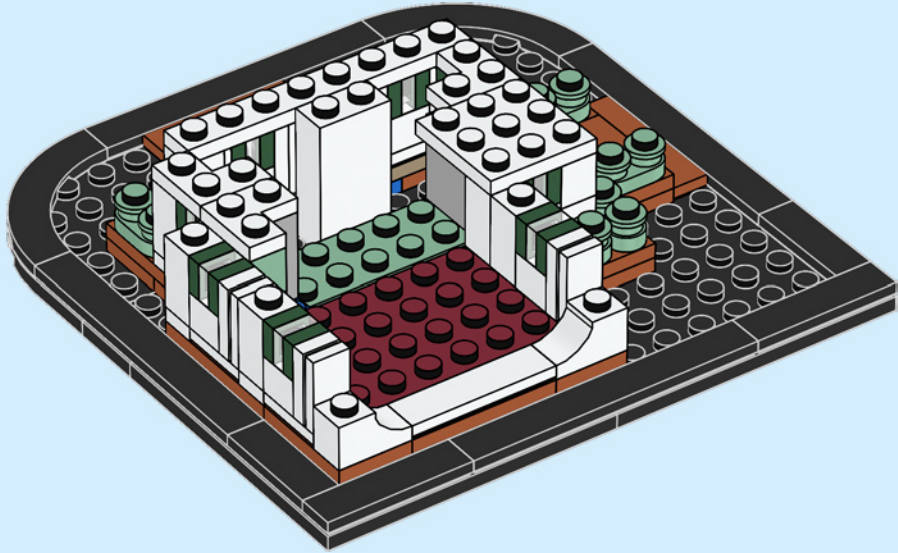

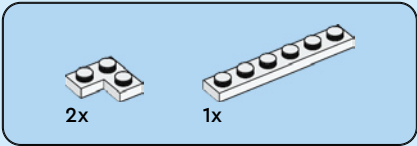

41

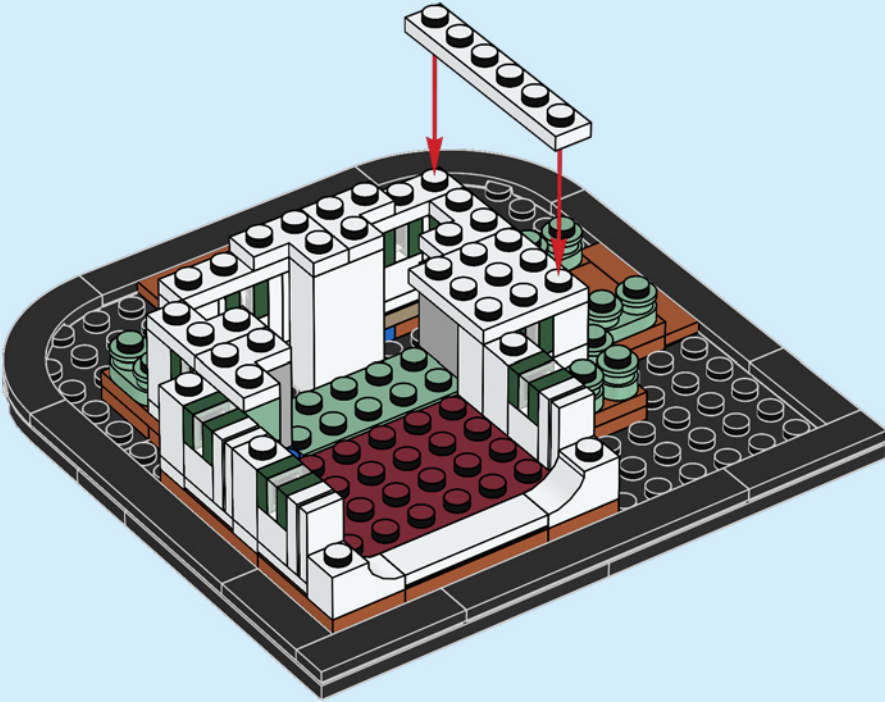



3x

42

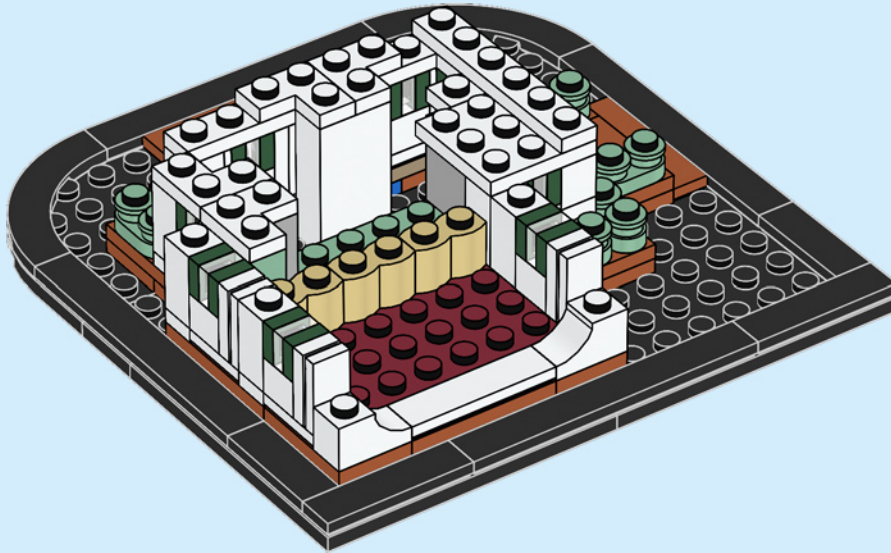



3x



3x

43

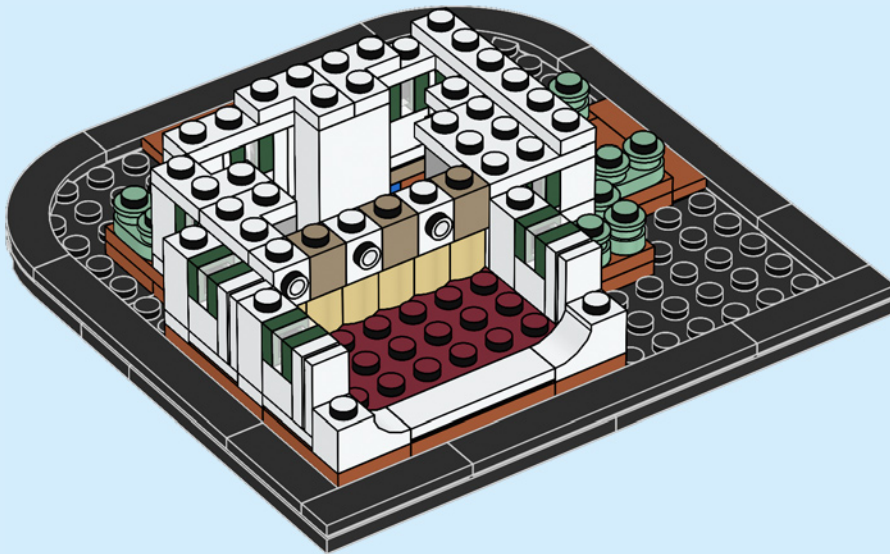

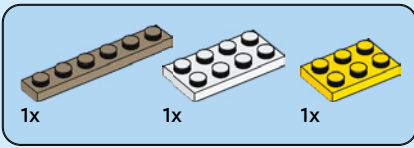

44

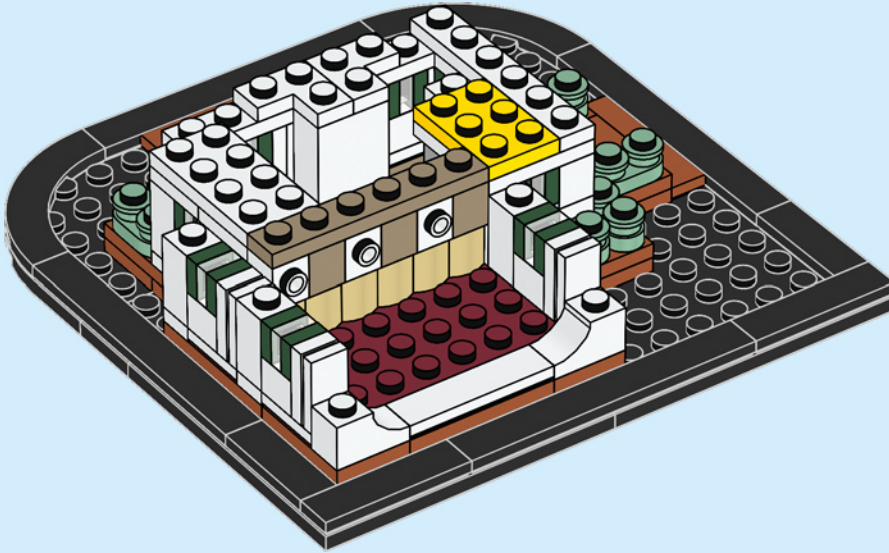

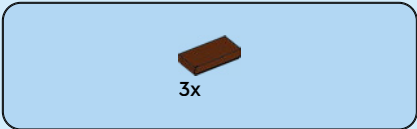

45

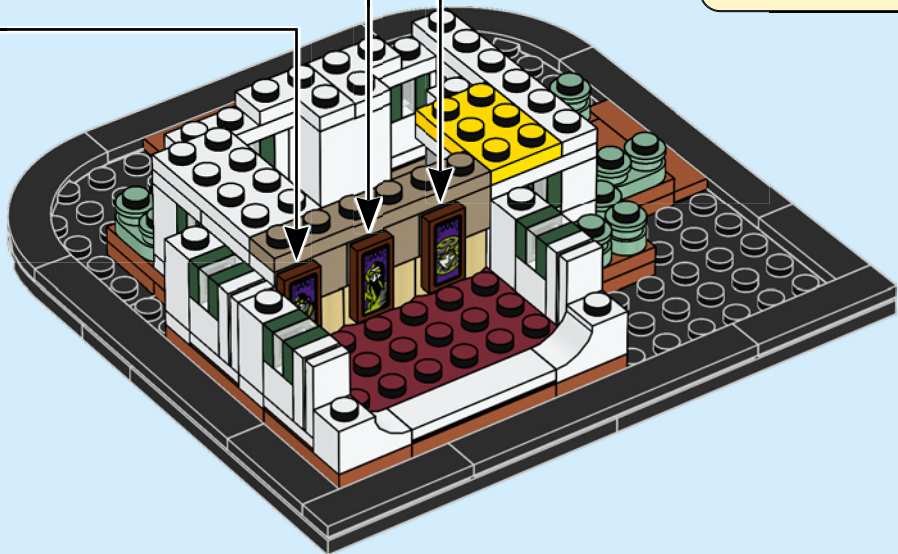
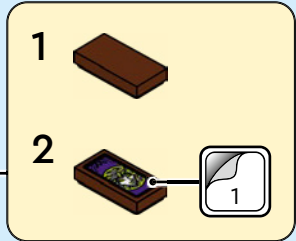
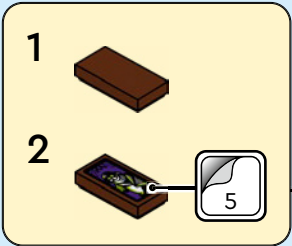
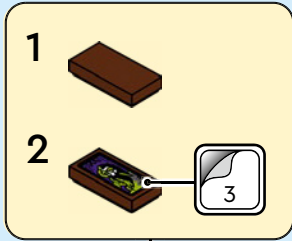

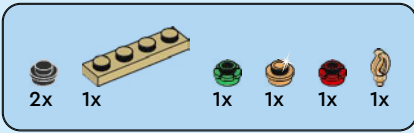

46

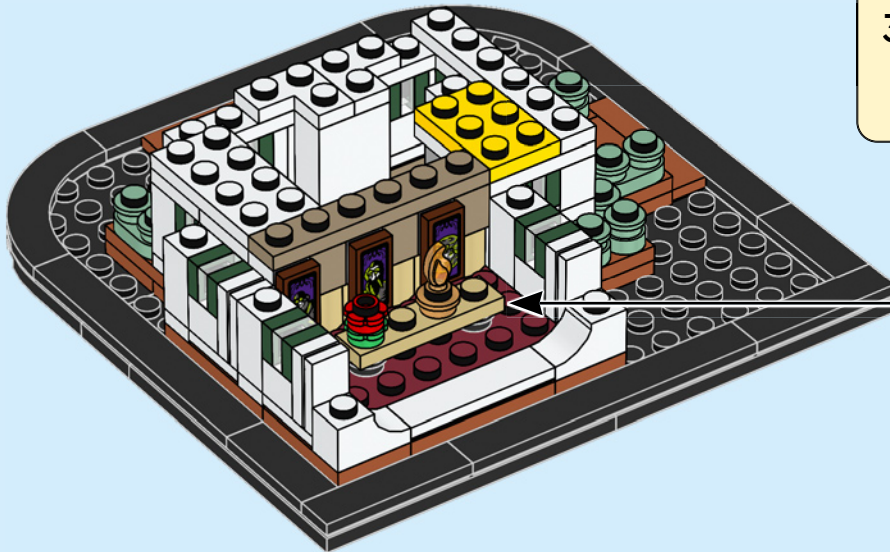



3x

47





2x

48



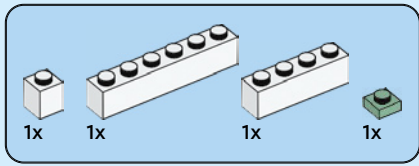

49



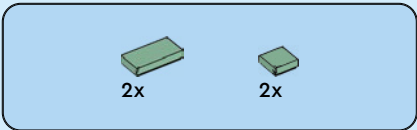

50

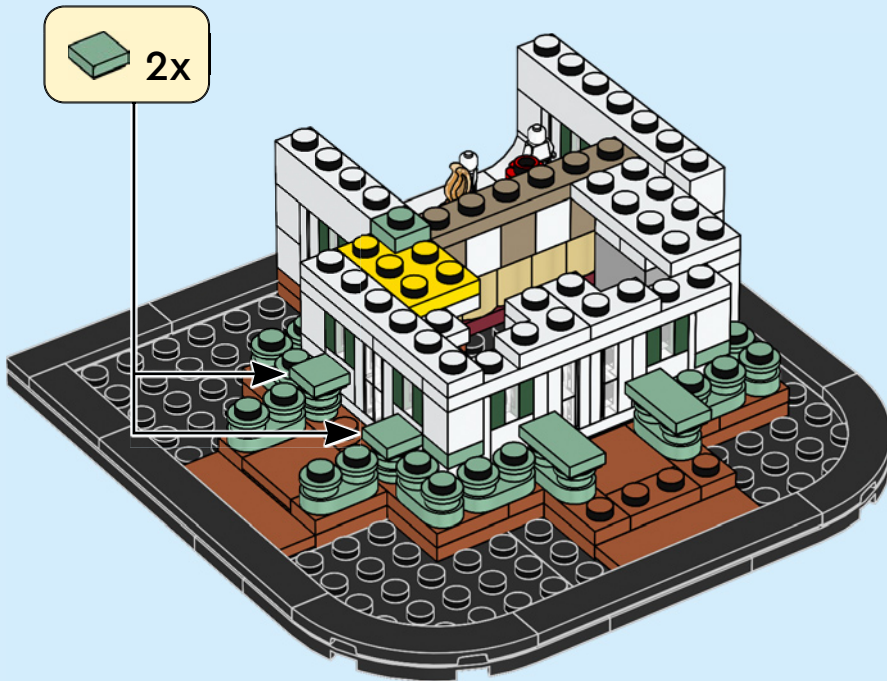
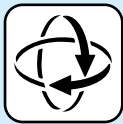



8x

51

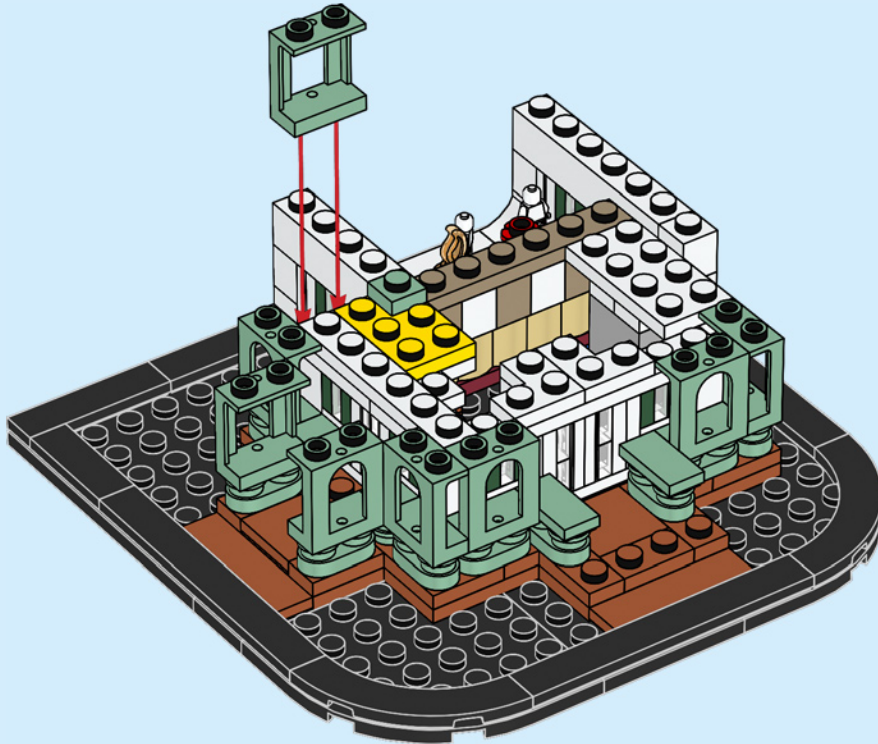

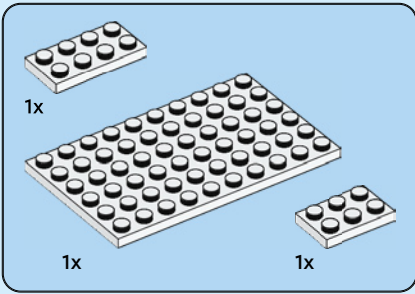

52

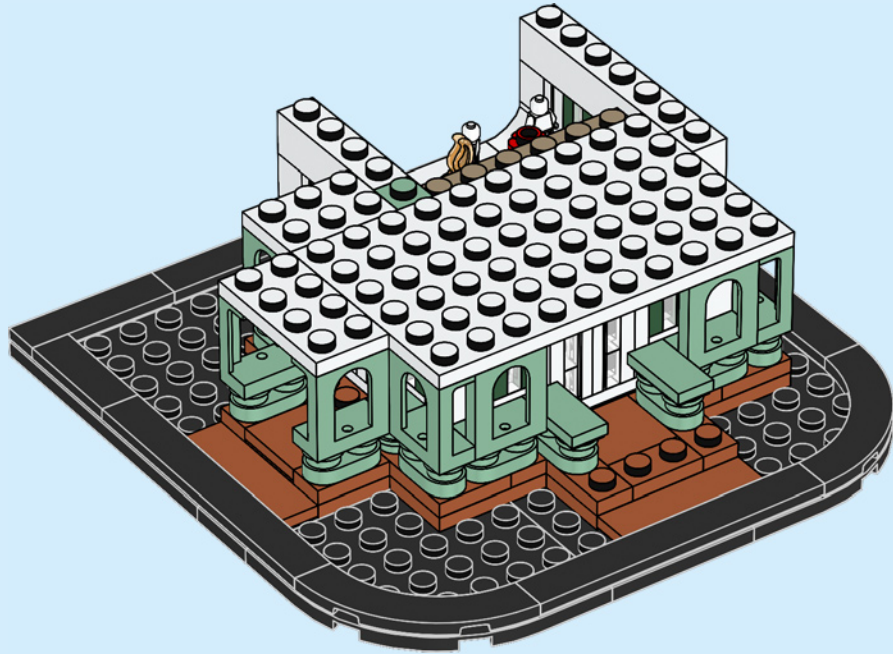



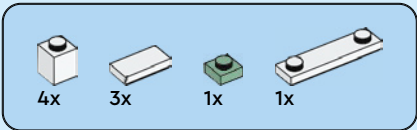

53

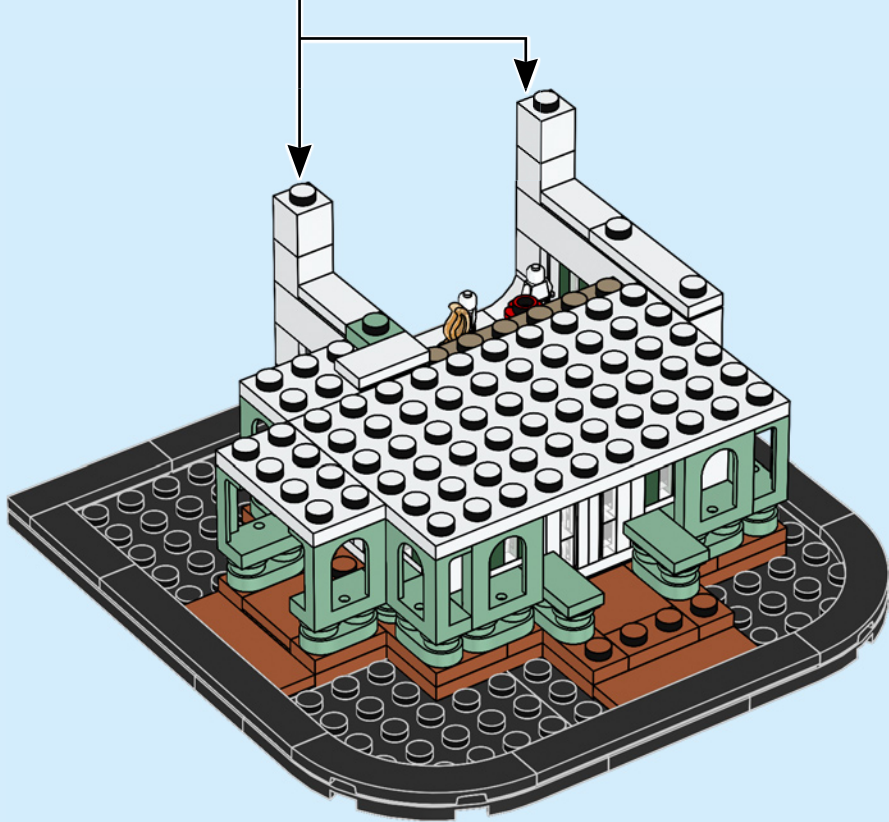
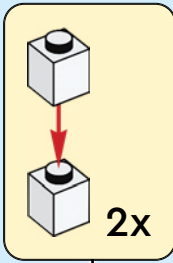

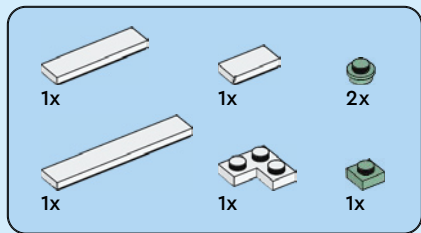

54

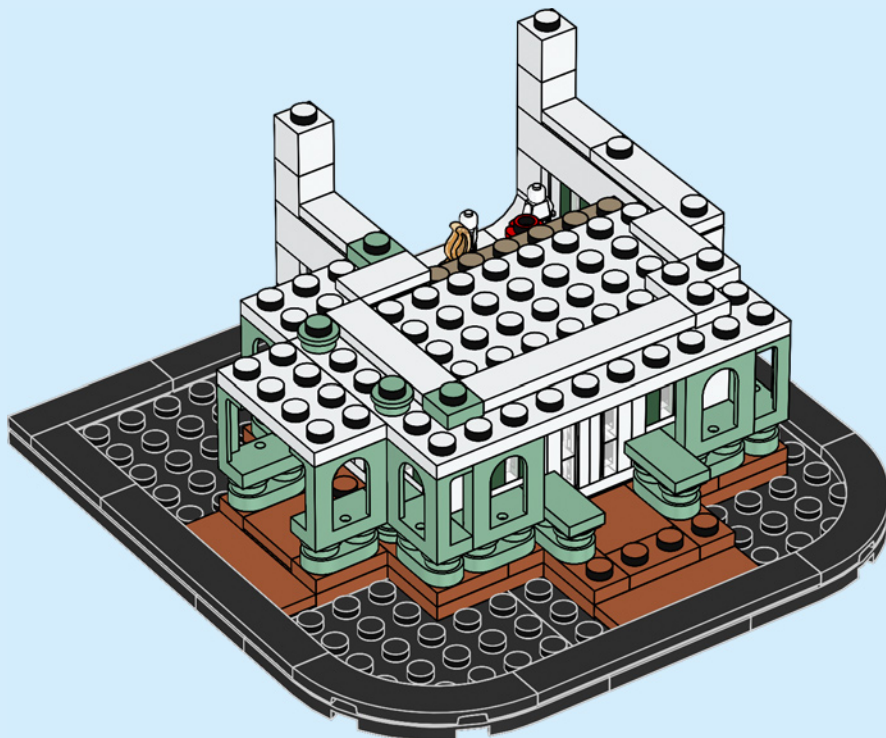



9x

55

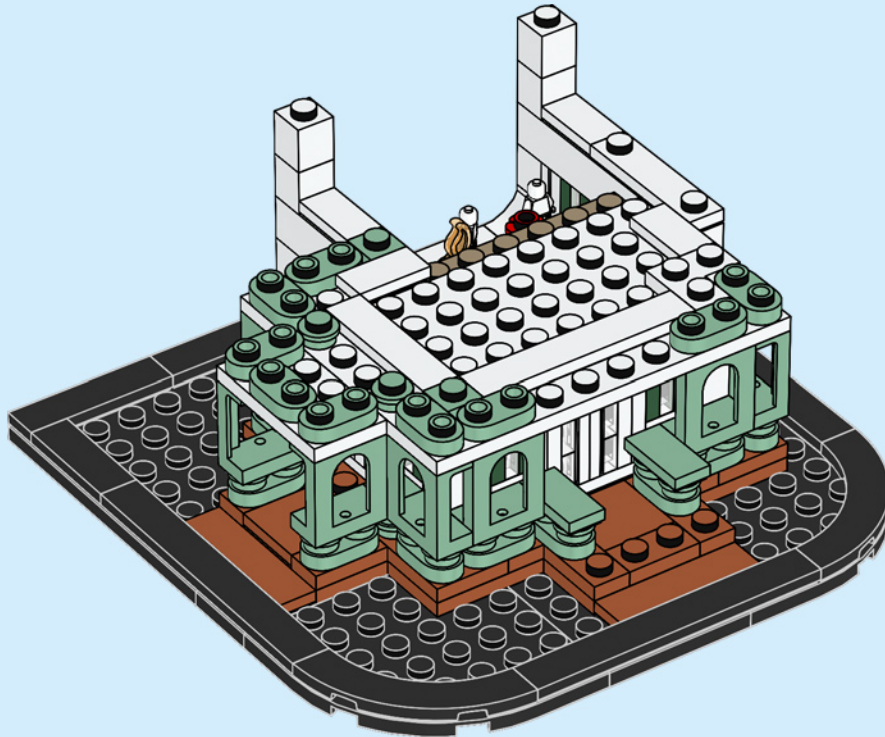

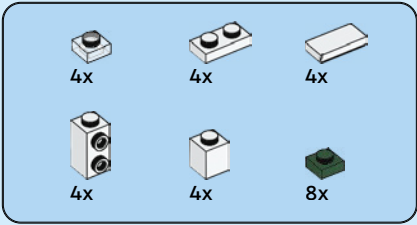

56

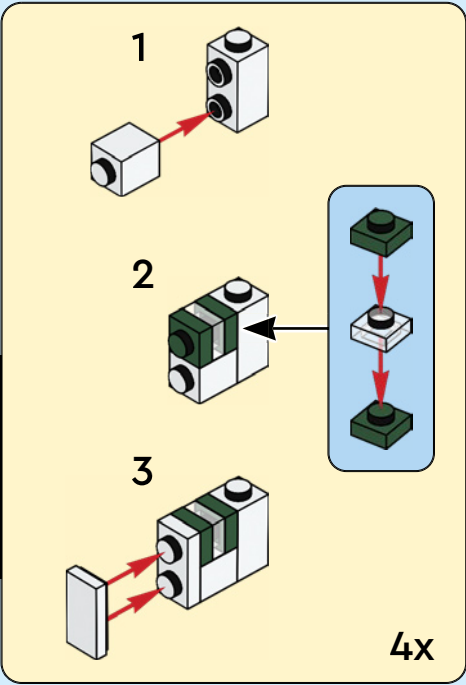
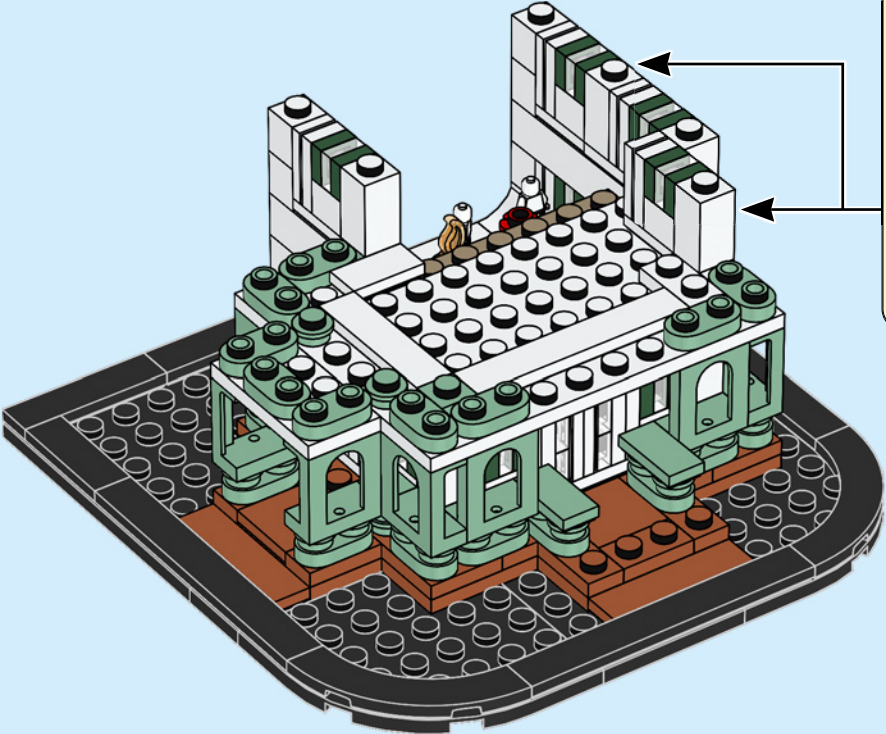

20x

57

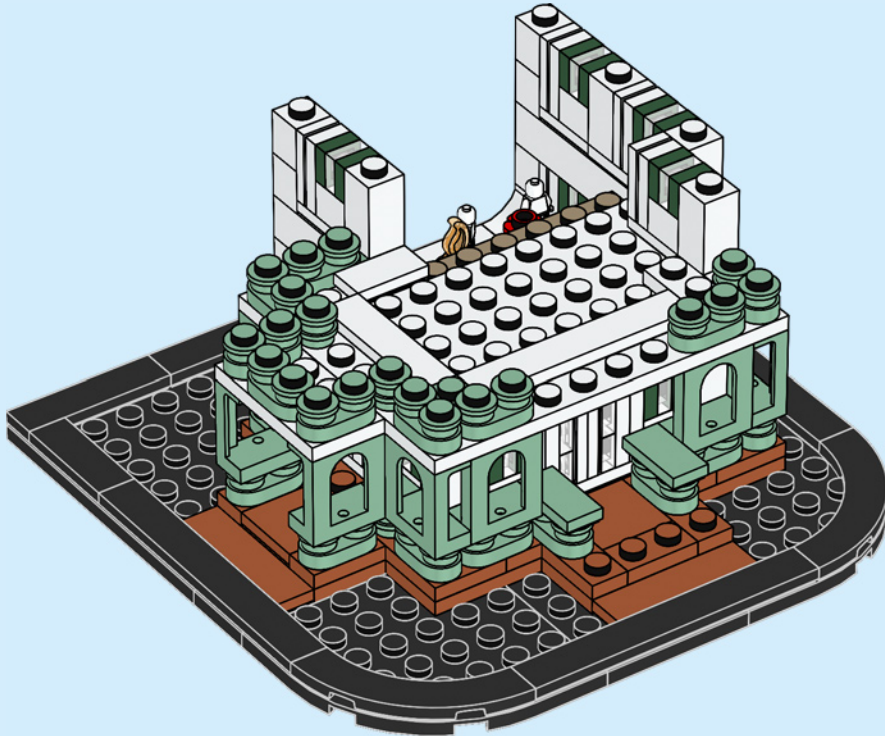



5x

58

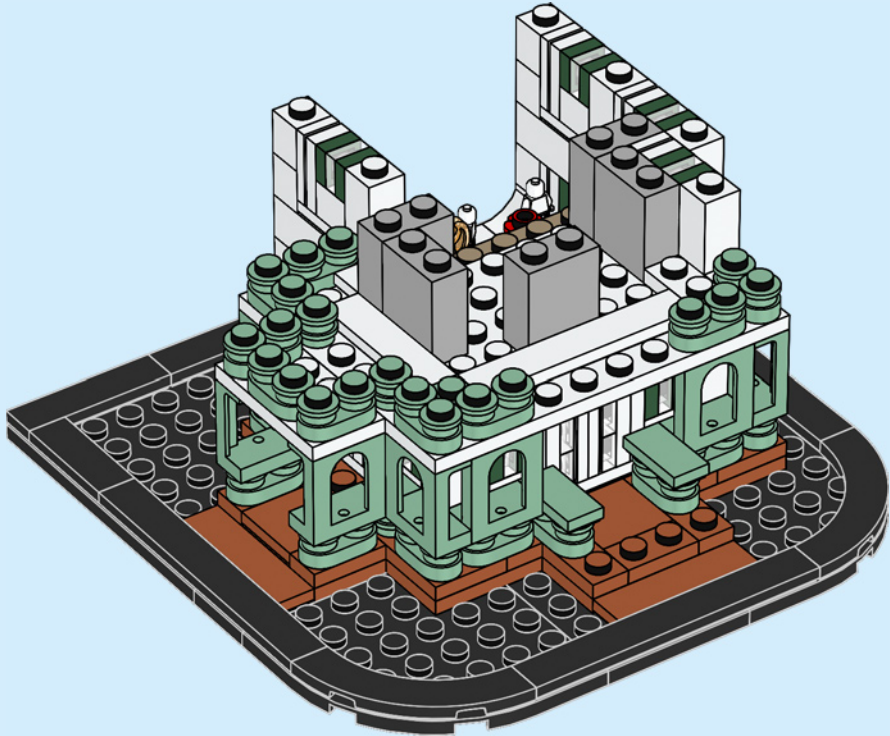



59



60

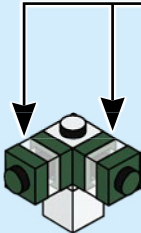

2x



61

1

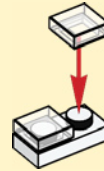

2

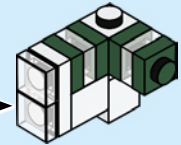

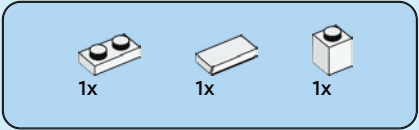

62

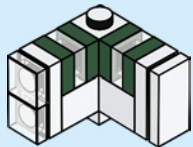
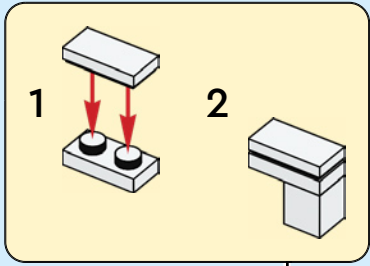

63

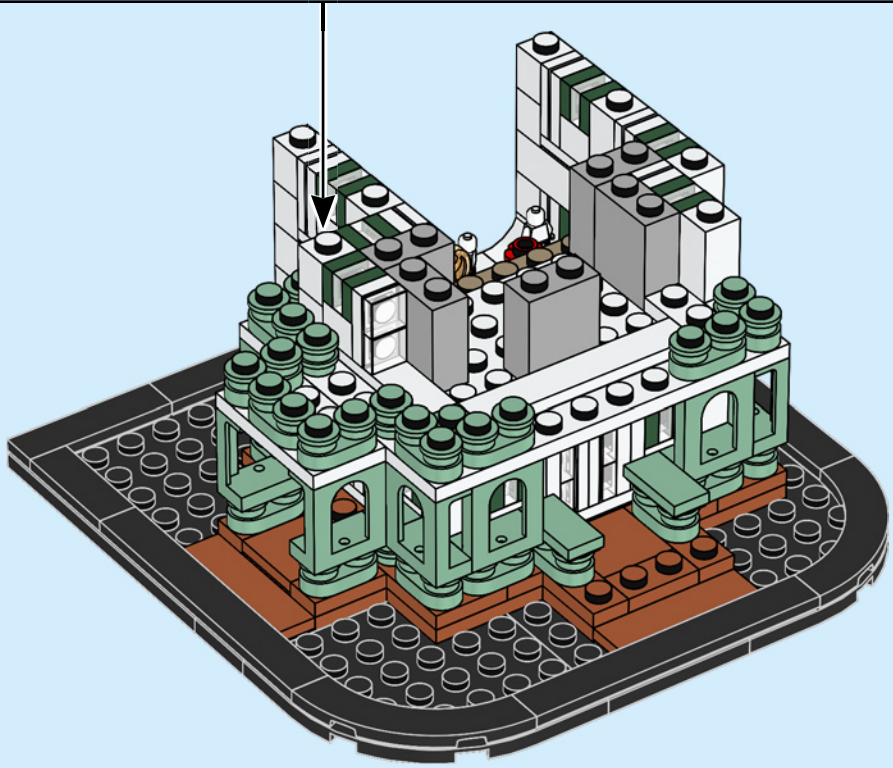



64

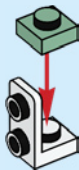

65



66

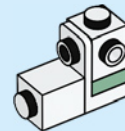

67

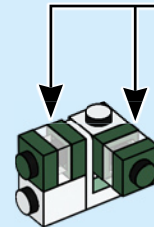

2x



68

1

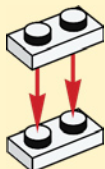

2

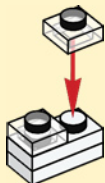

3

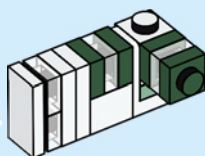

69

1

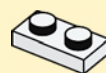

2

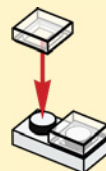

3

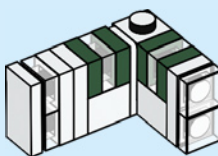

70

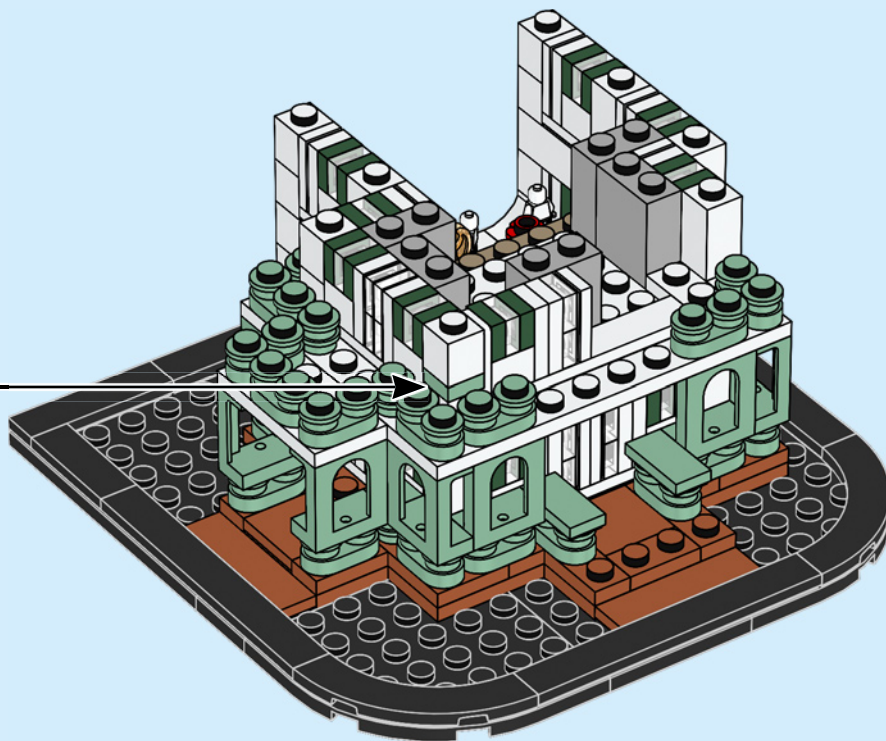



1x



1x

71



2x

72

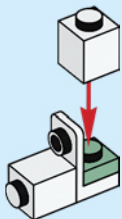

2x



1x

73

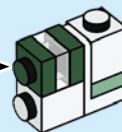
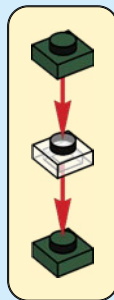

2x



1x



2x

74

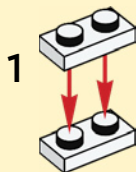

1

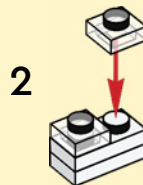

2

3

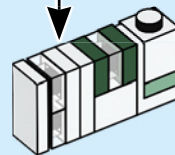

75

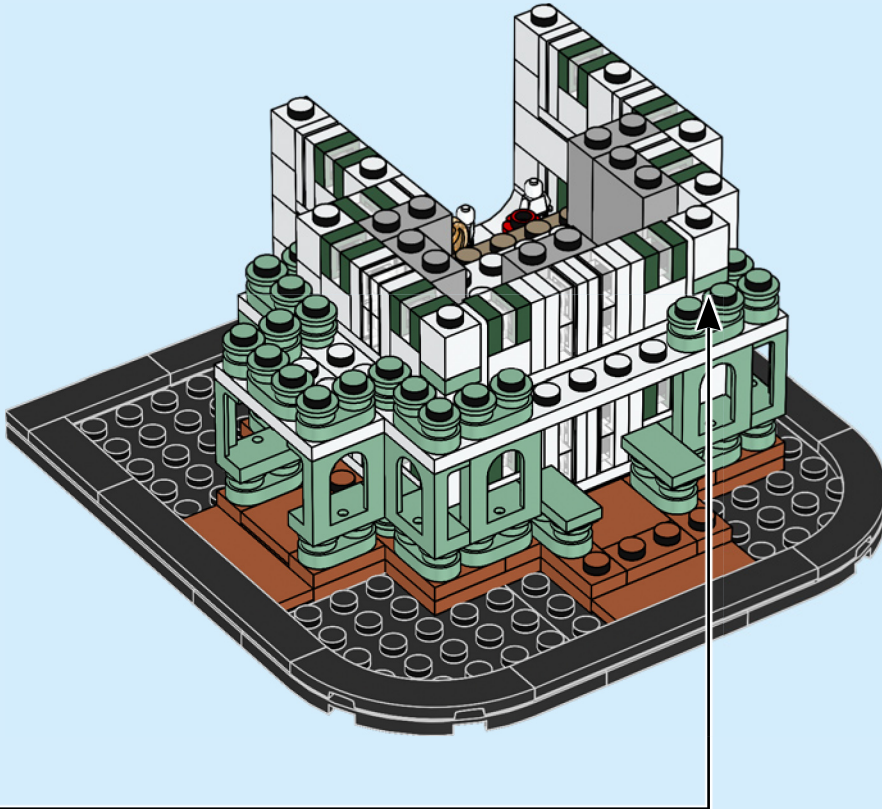

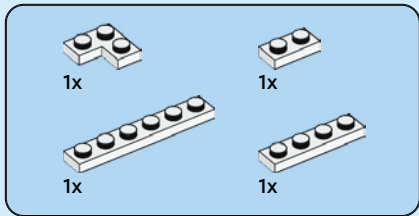

76

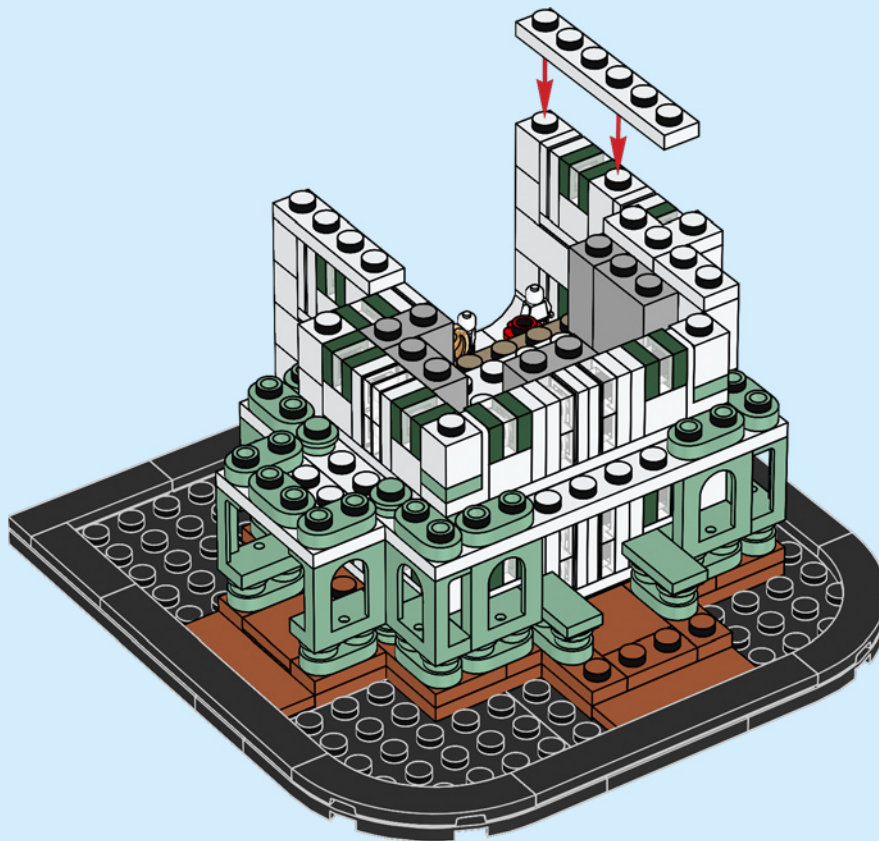

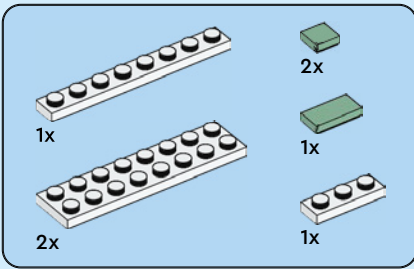

77

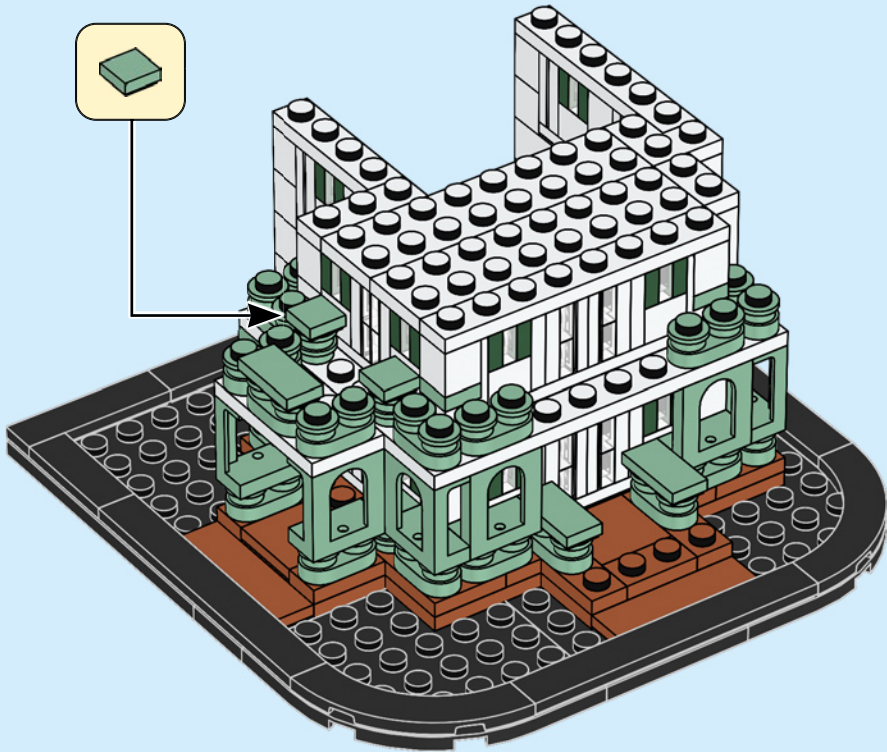

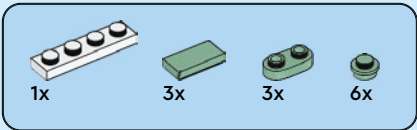

78

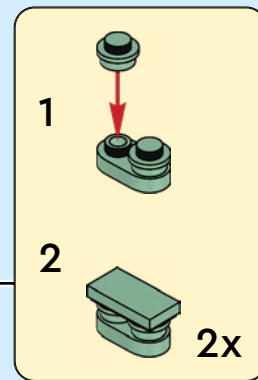
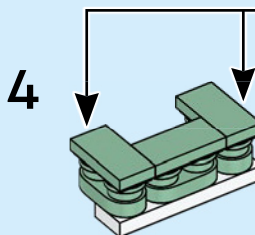
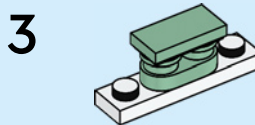
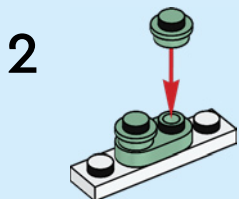
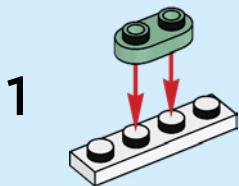

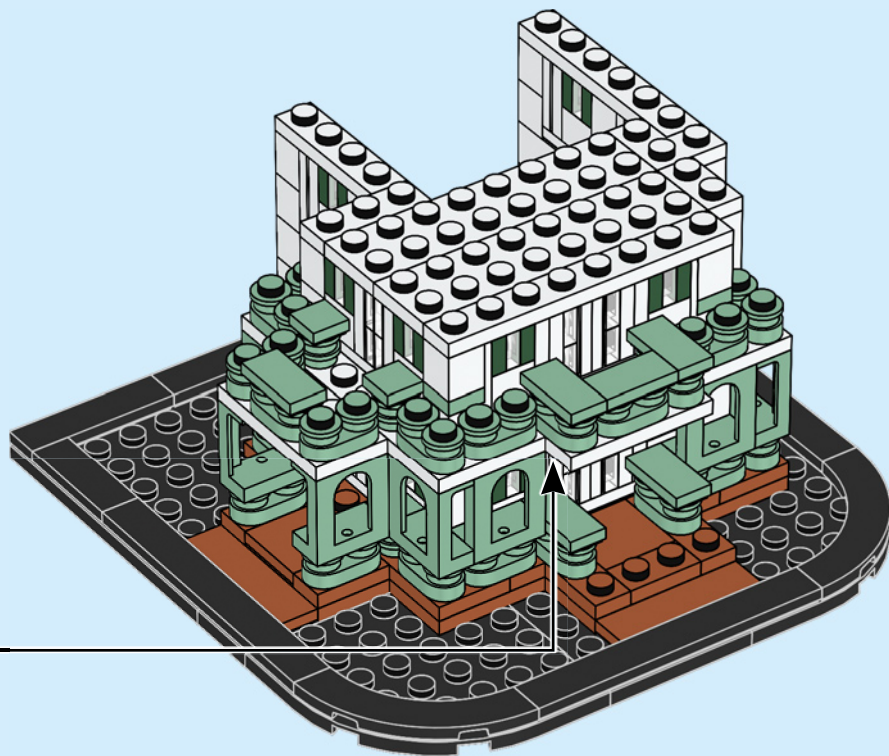



8x

79

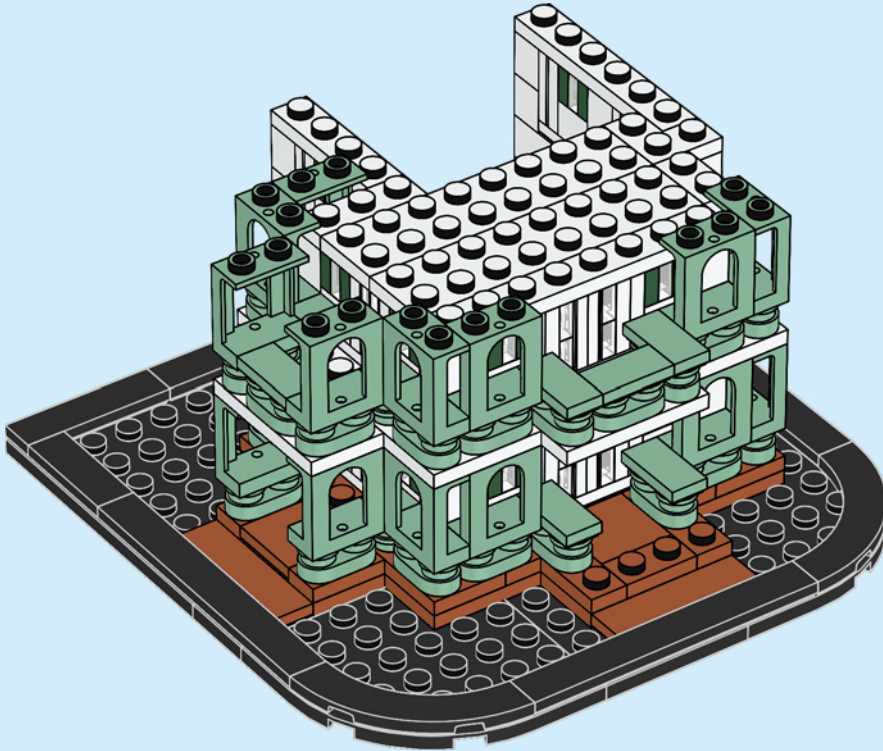

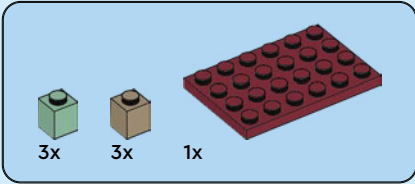

80

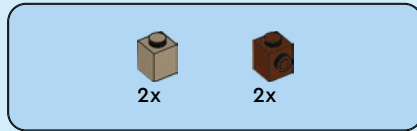
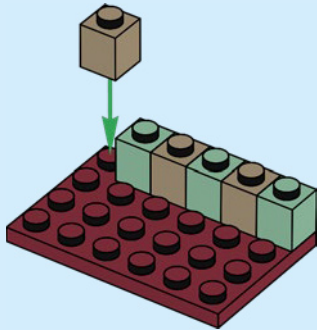

81

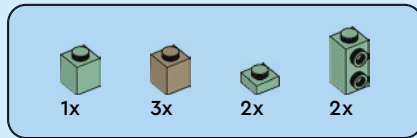
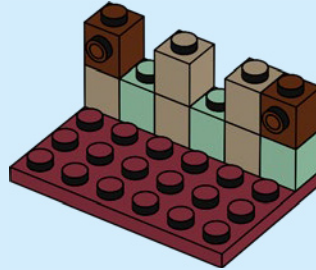

82

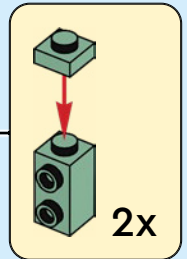
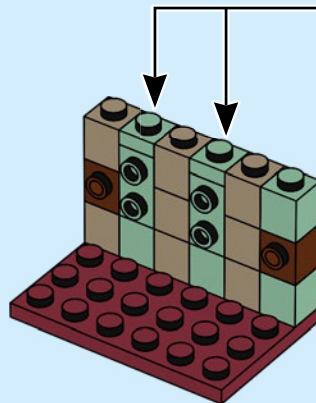

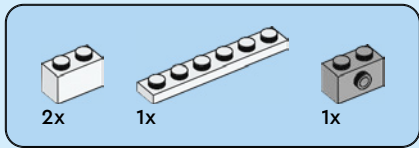

83

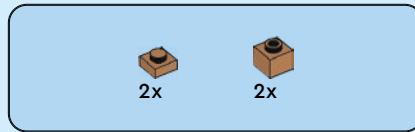
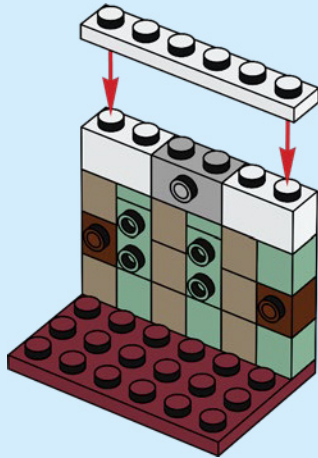

84

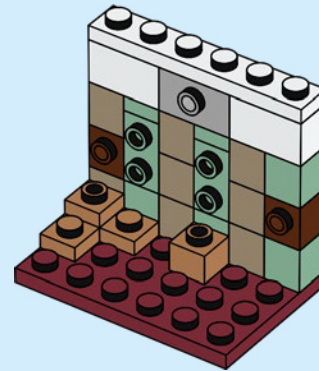



6x

85

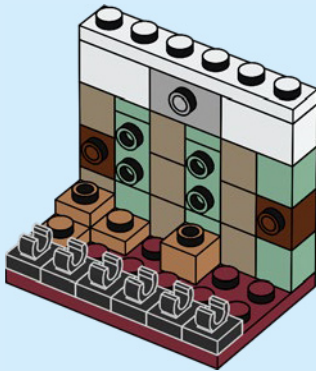

2x

86



2x

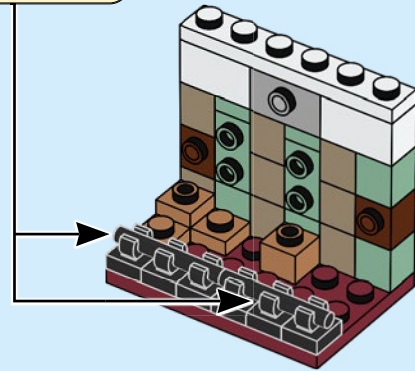



2x

87

1



2



1



2

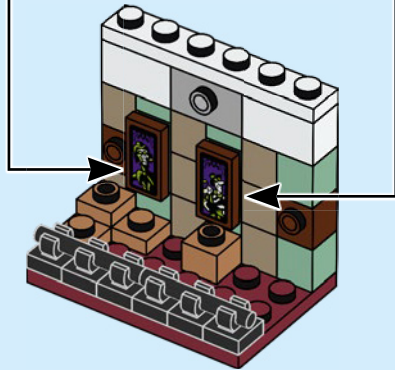

2x



2x



2x

88



1

2

3

4

2x

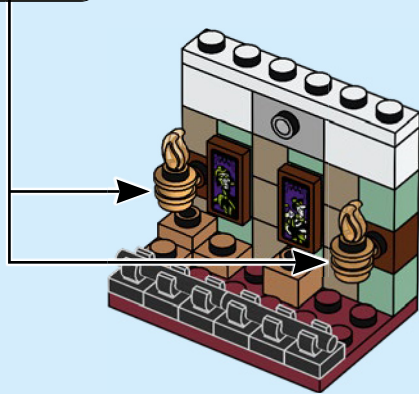

1x



1x

89

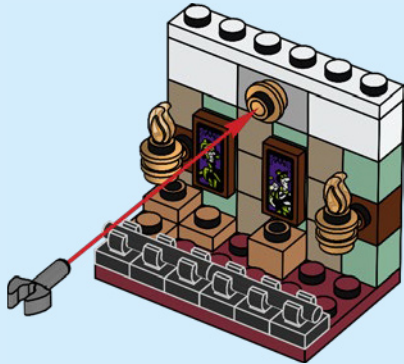

3x



1x

90

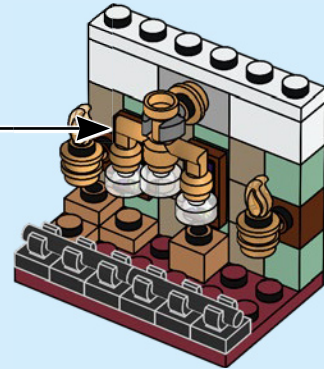
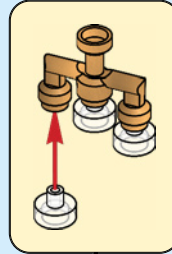

91

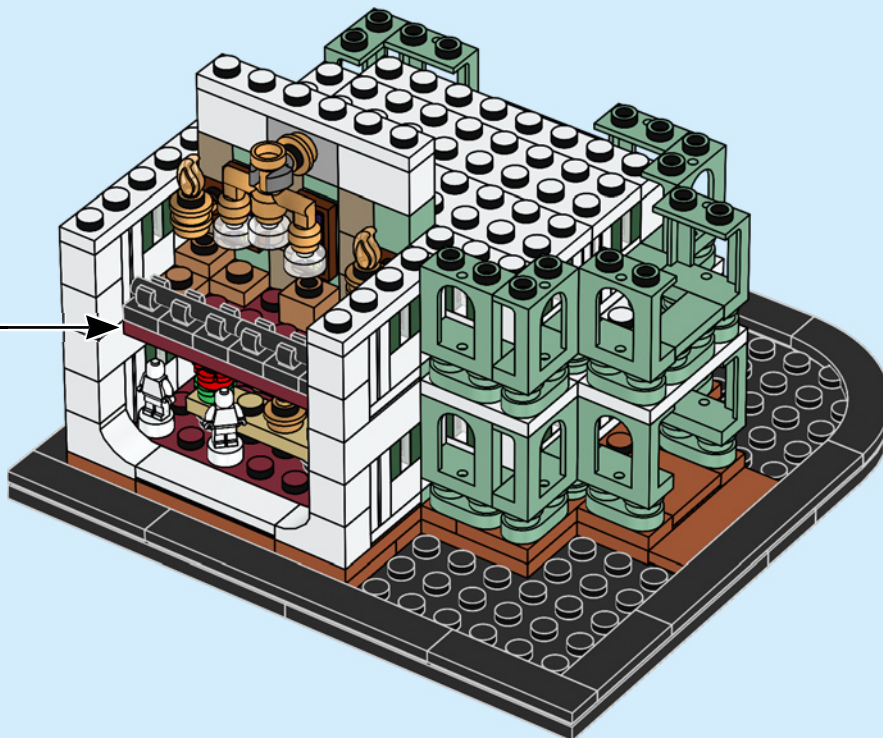



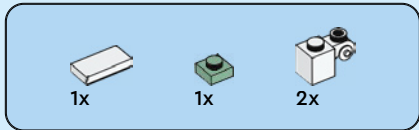

92

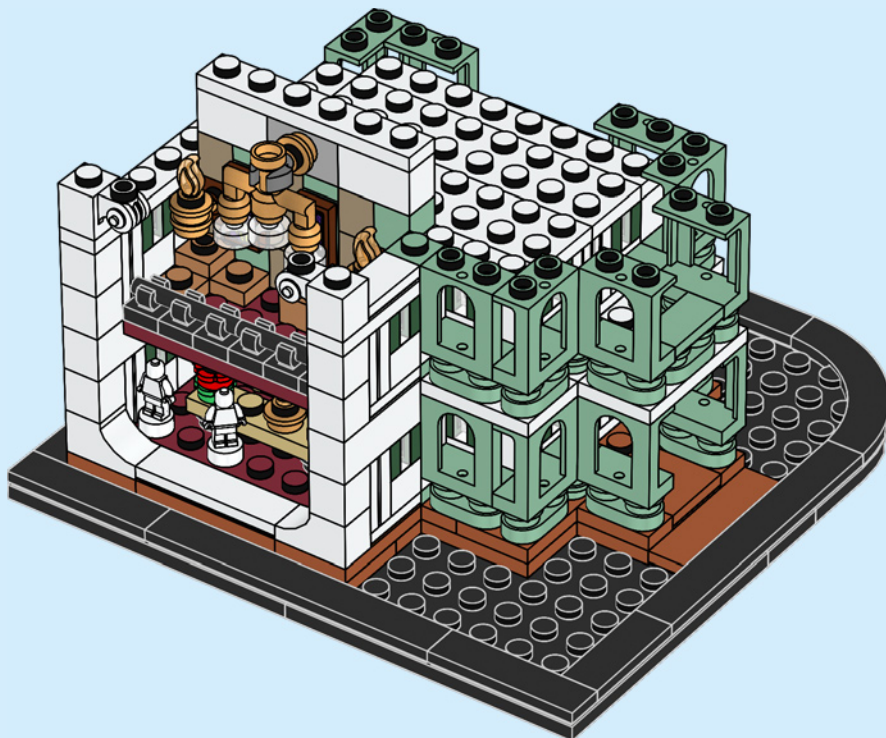

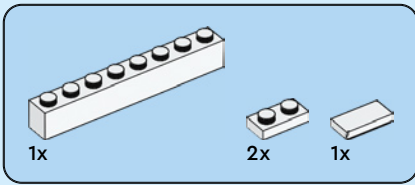

93

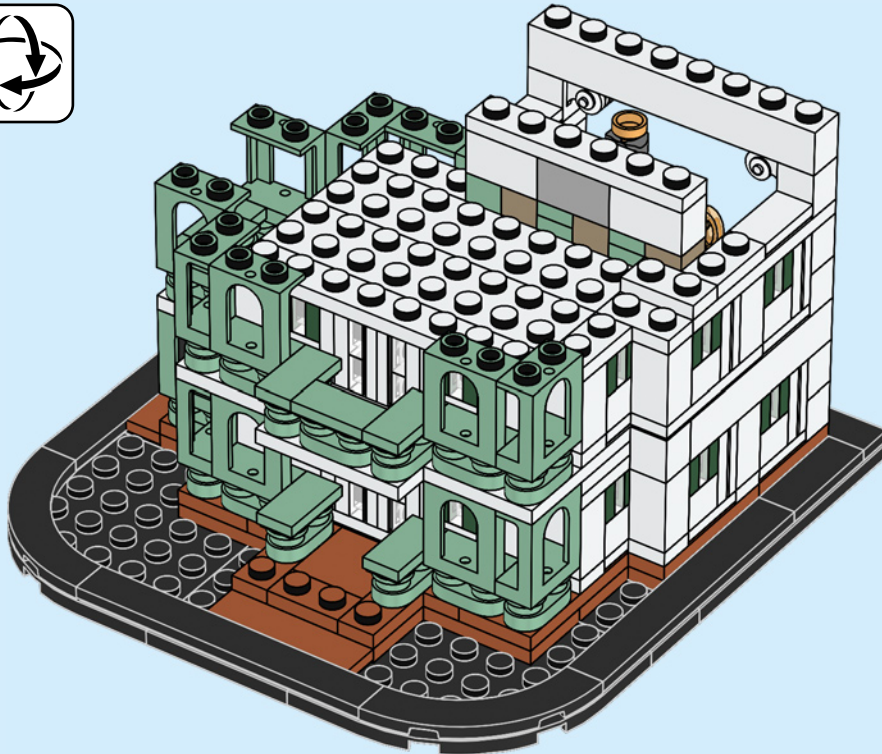

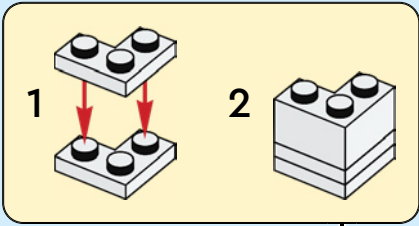
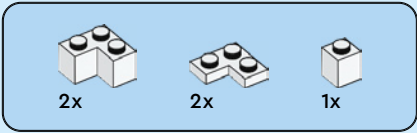

94

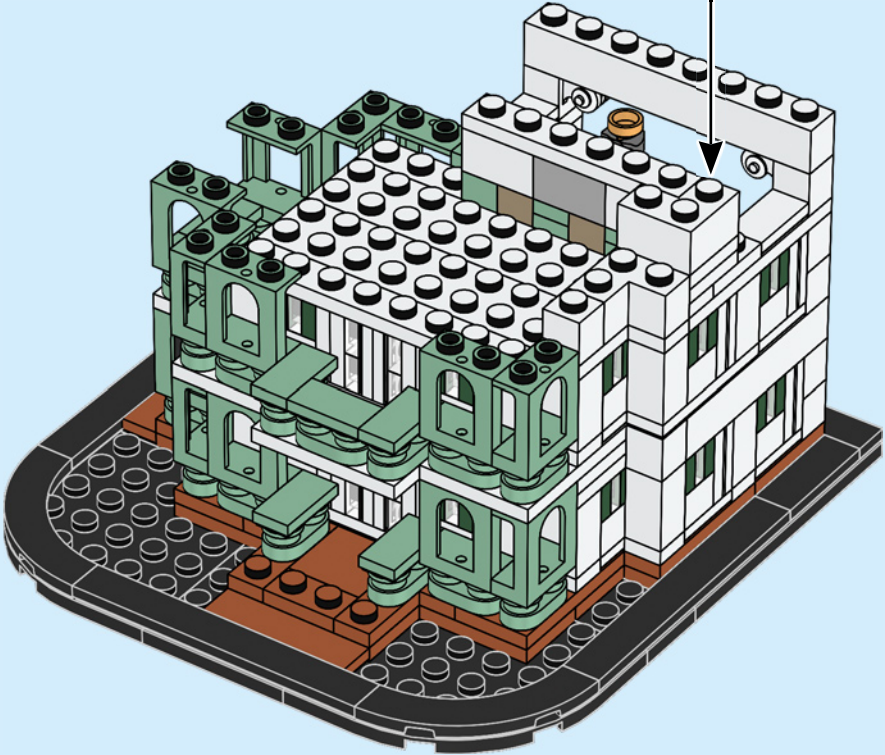

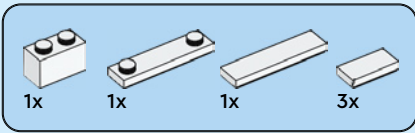

95

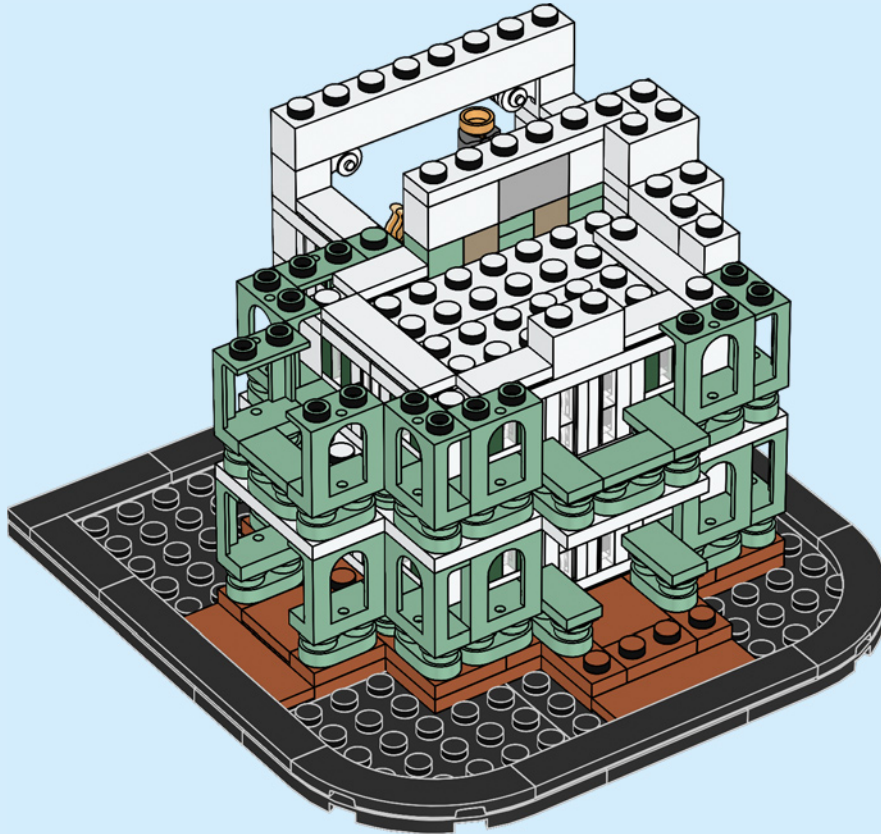

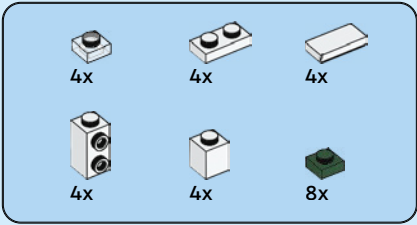

96

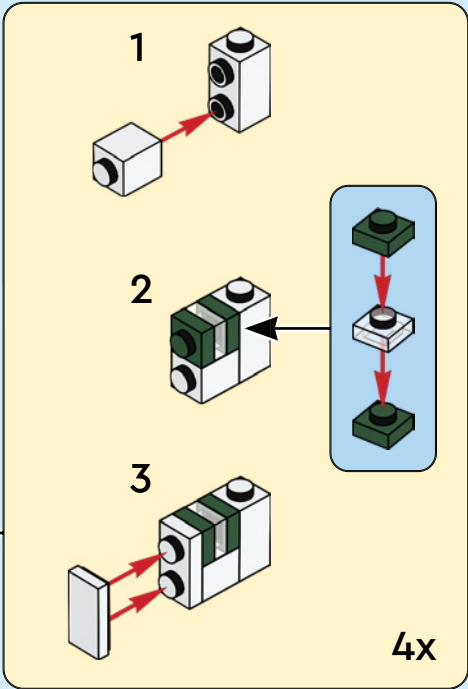
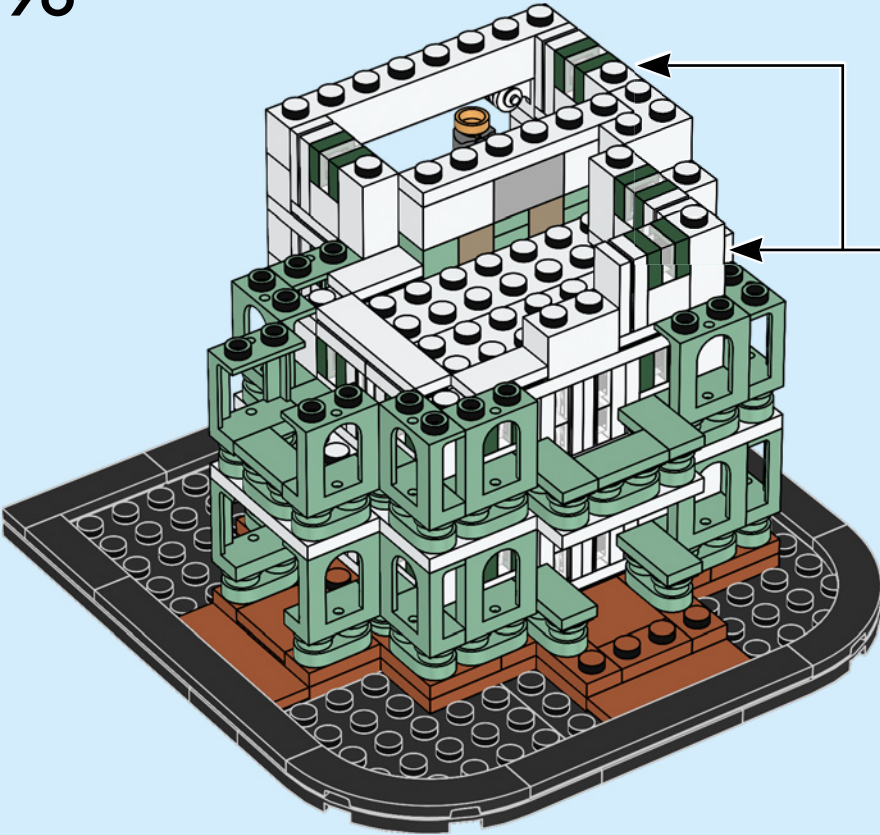

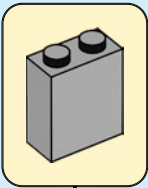
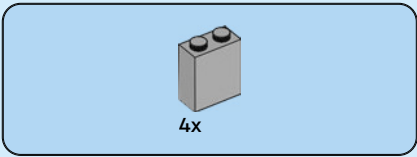

97

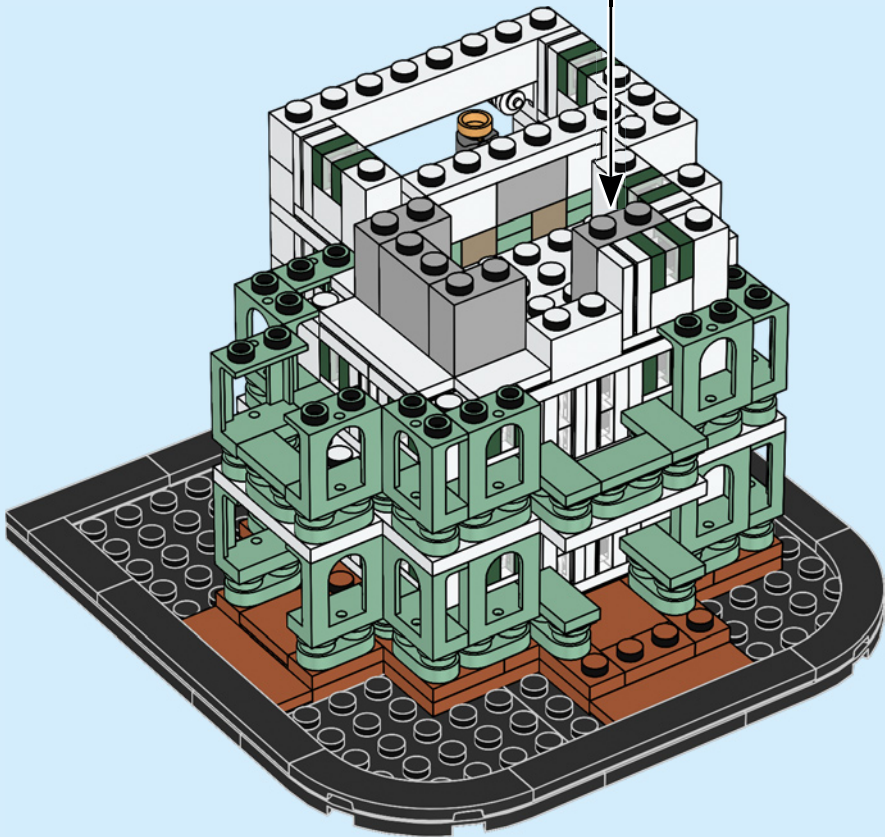

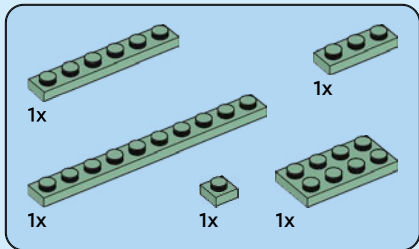

98

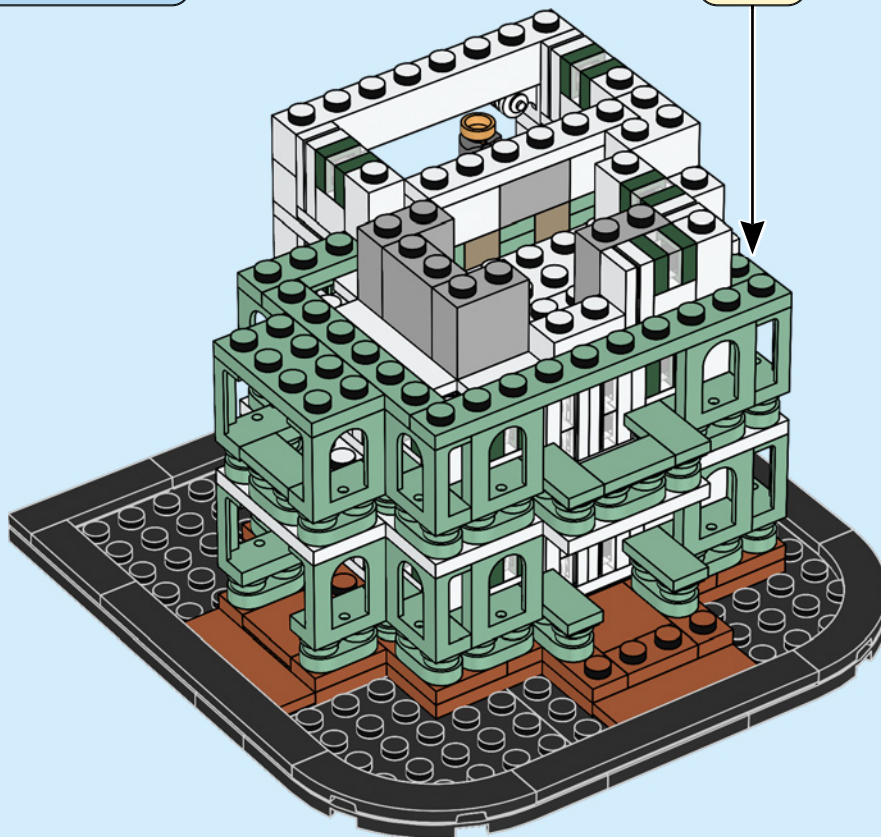

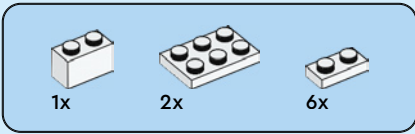

99

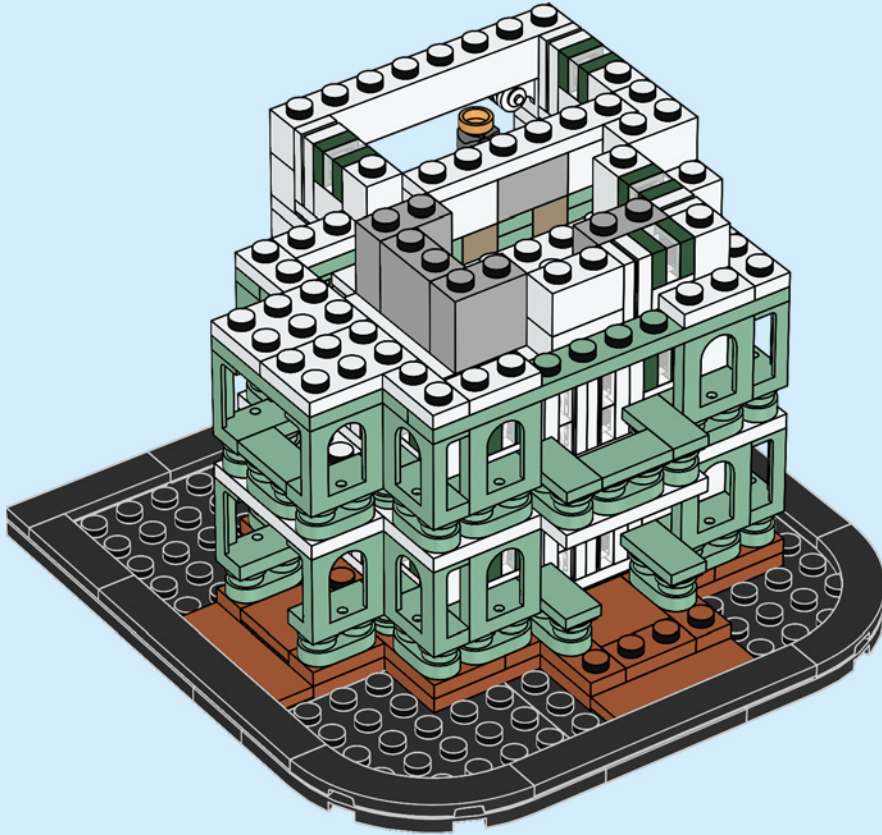

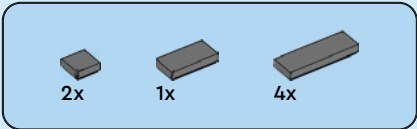

100

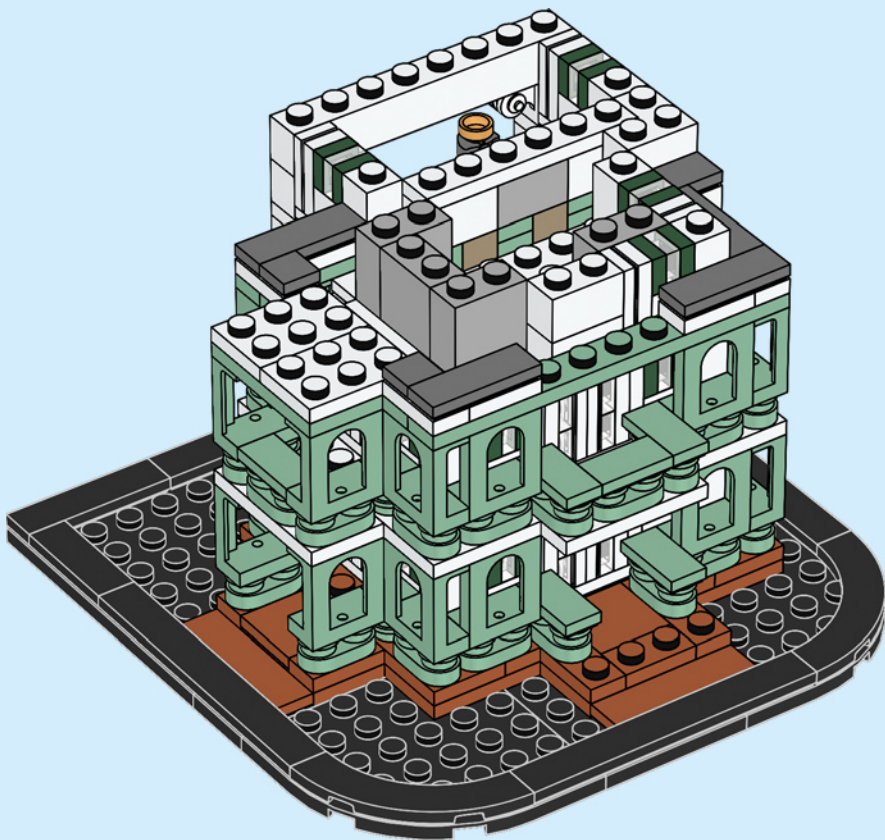



2x



8x



4x



4x



6x



2x



4x

101

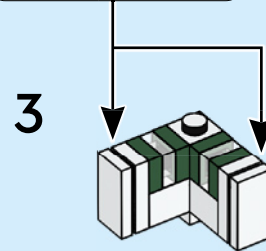
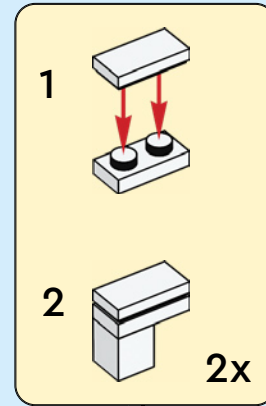
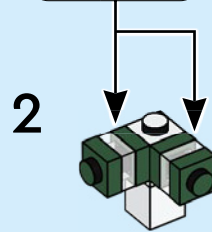
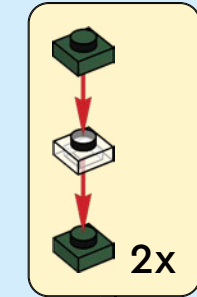
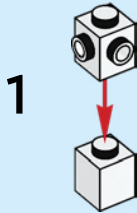

2x



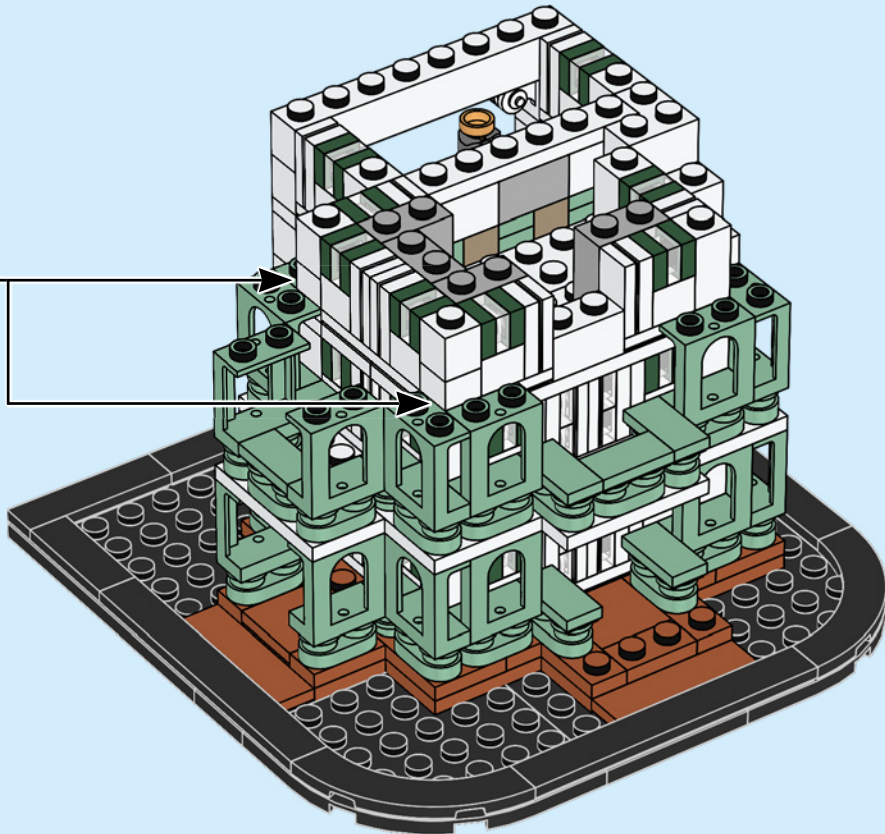

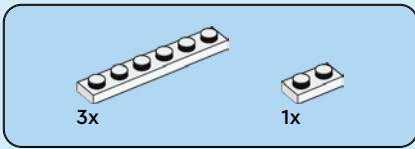

102

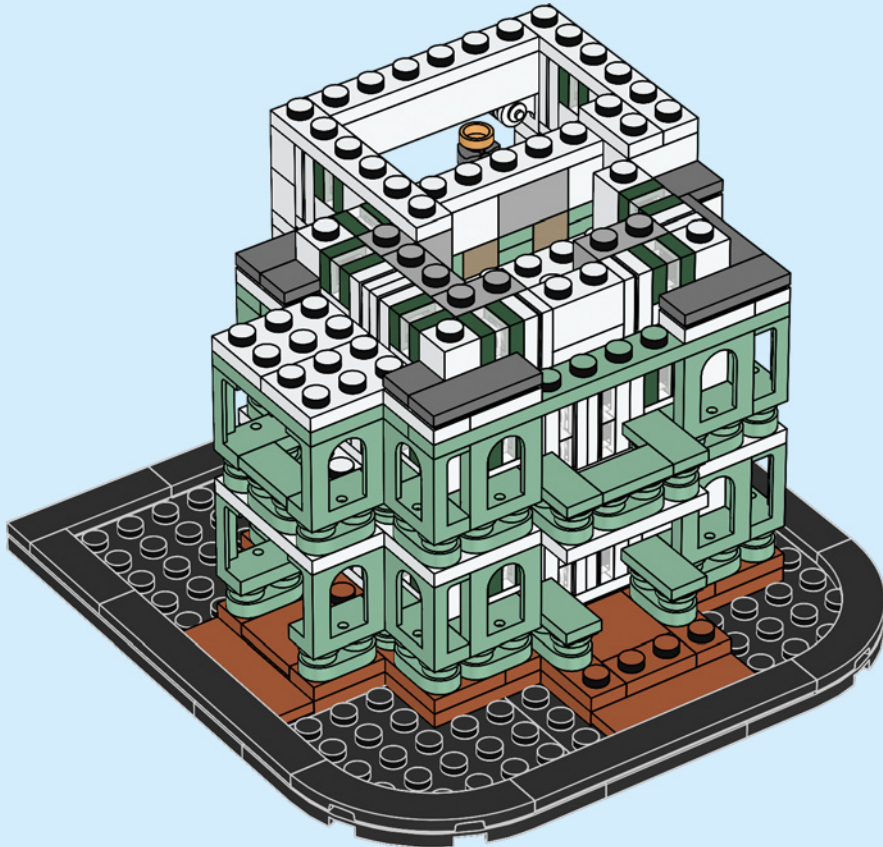

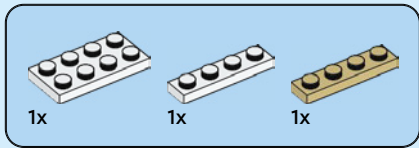

103

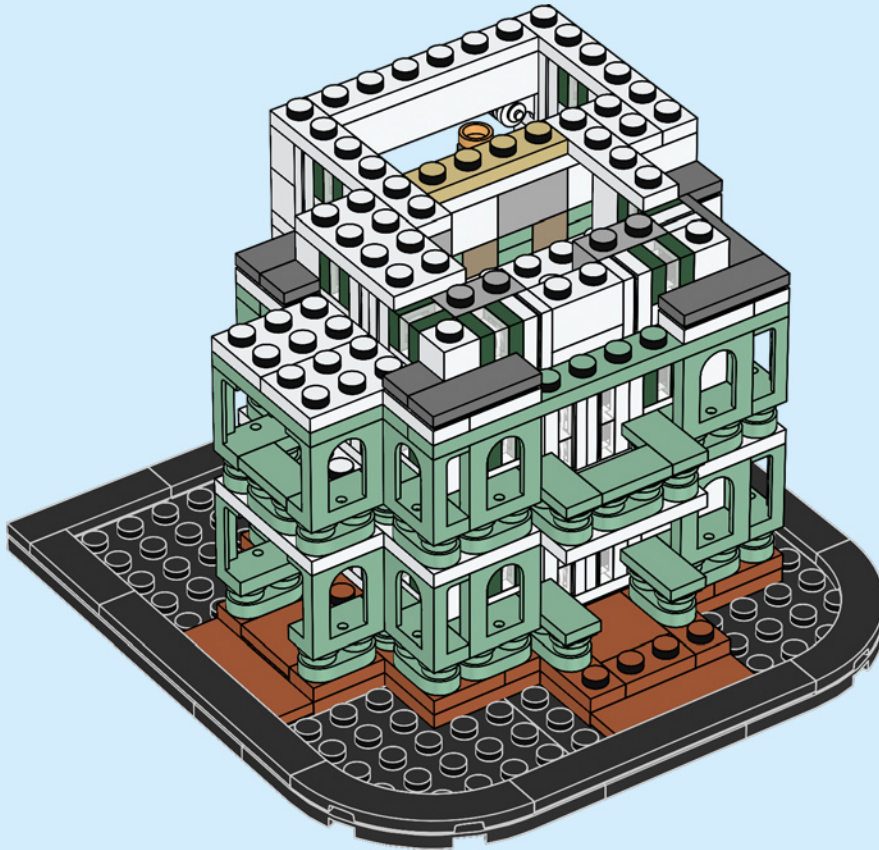

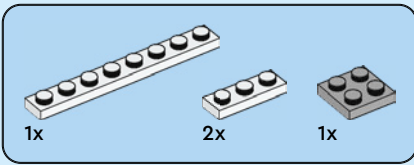

104

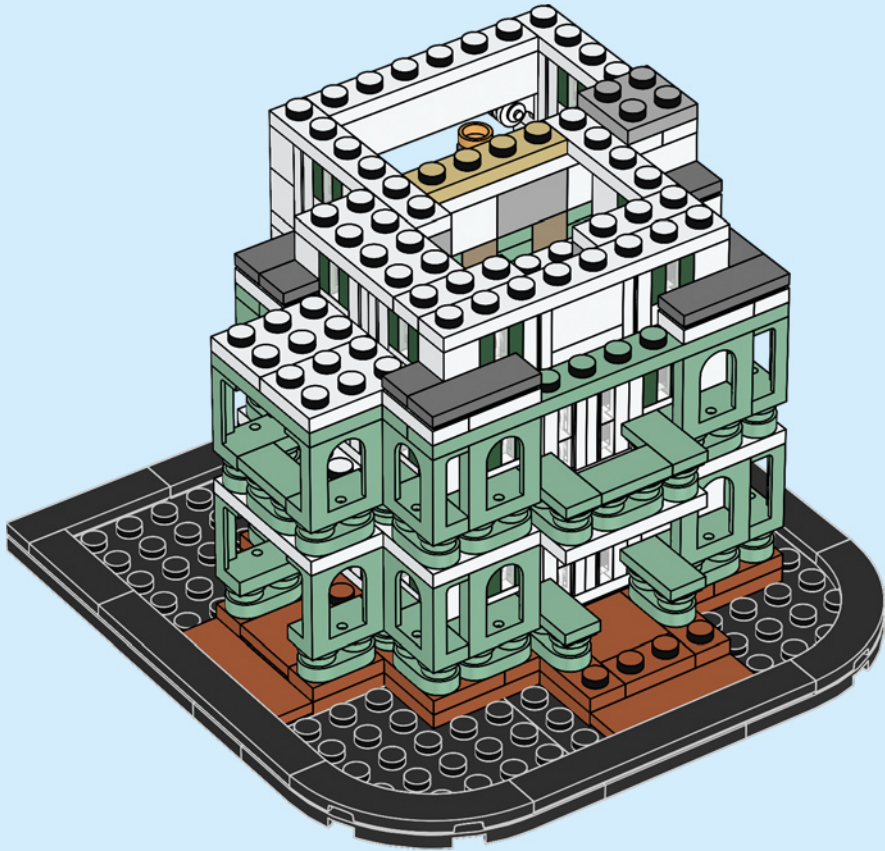

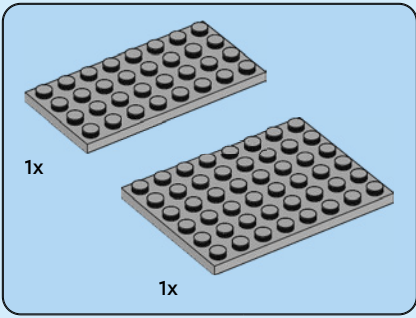

105





4x



16x

106

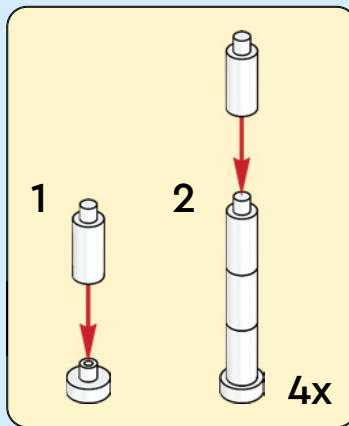
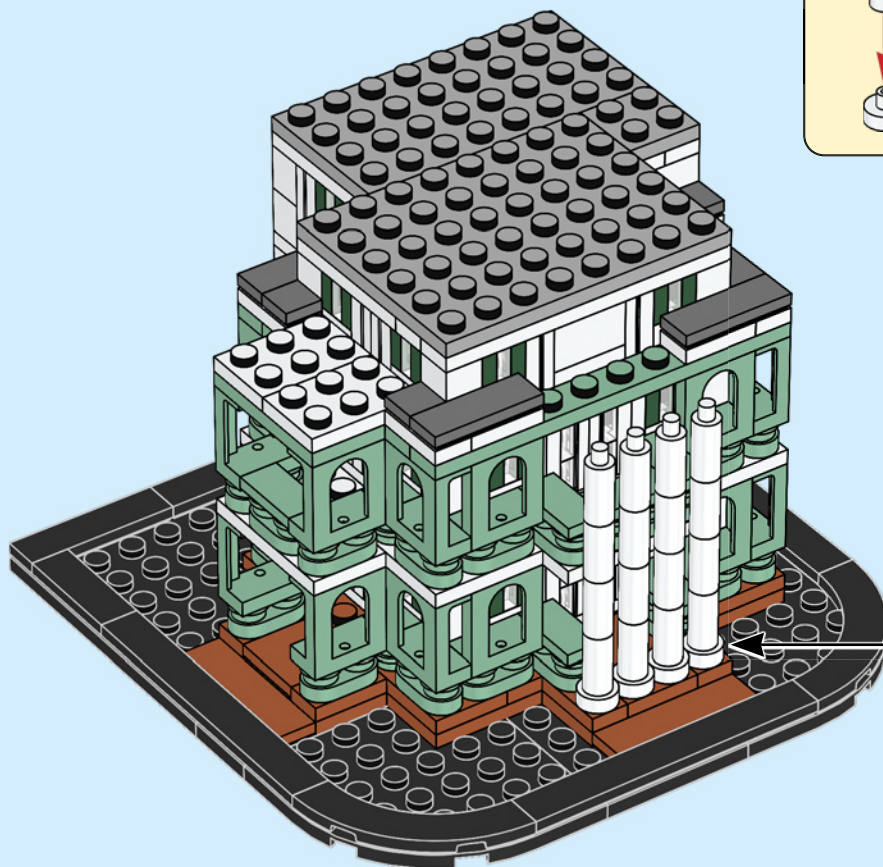

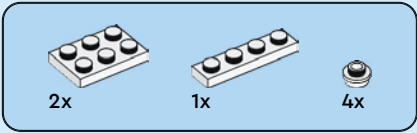

107

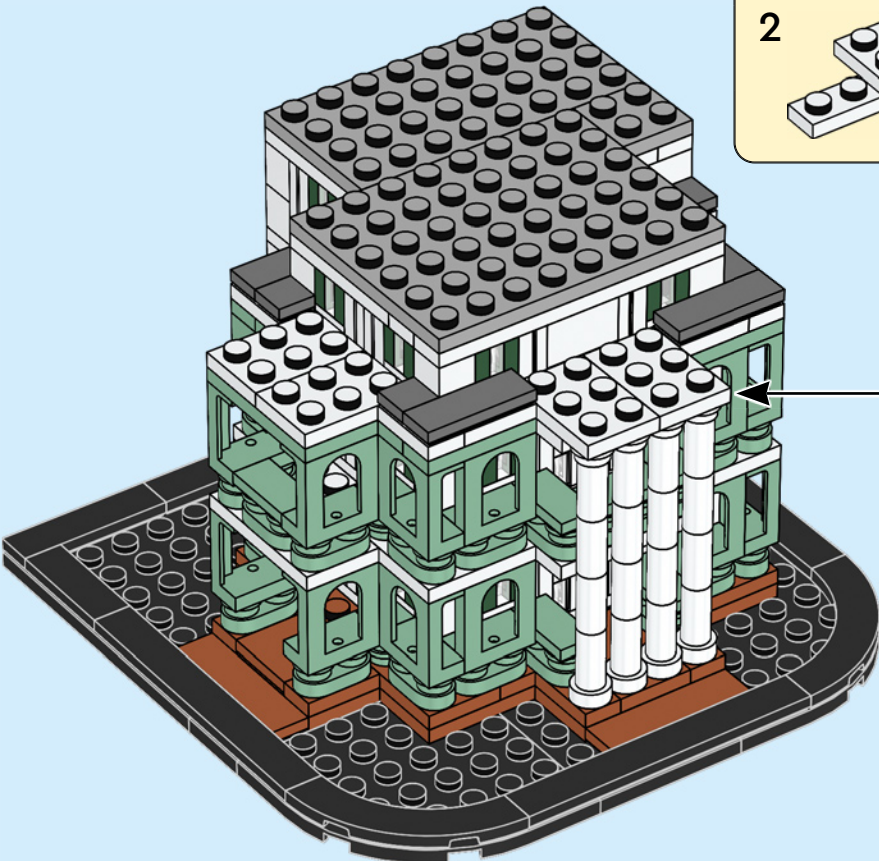

1. Insert a 1x4 grey Technic plate with 4 holes into the top edge of the structure.

2. Insert another 1x4 grey Technic plate with 4 holes into the top edge of the structure, offset by one hole from the first plate.

3. Insert a 1x4 grey Technic plate with 4 holes into the top edge of the structure, offset by two holes from the first plate.

4. Insert a black Technic pin into the hole at the end of the second plate from the left.



4x



4x



4x

108

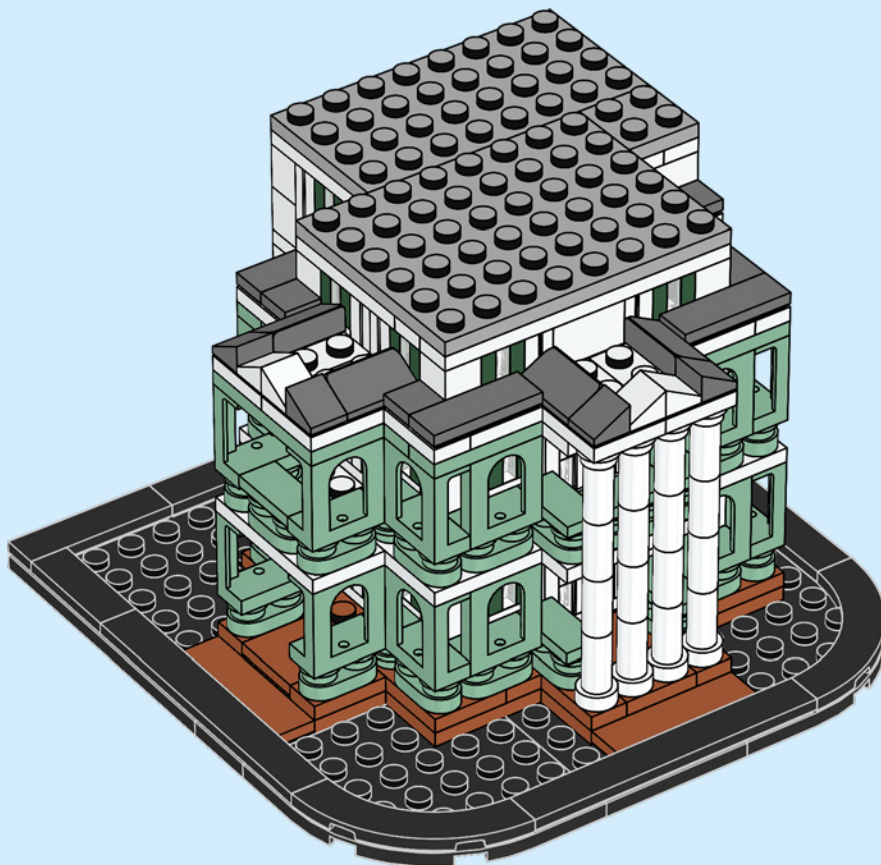

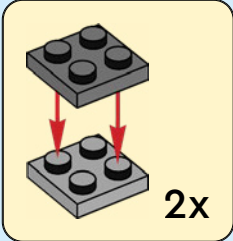
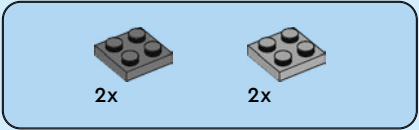

109

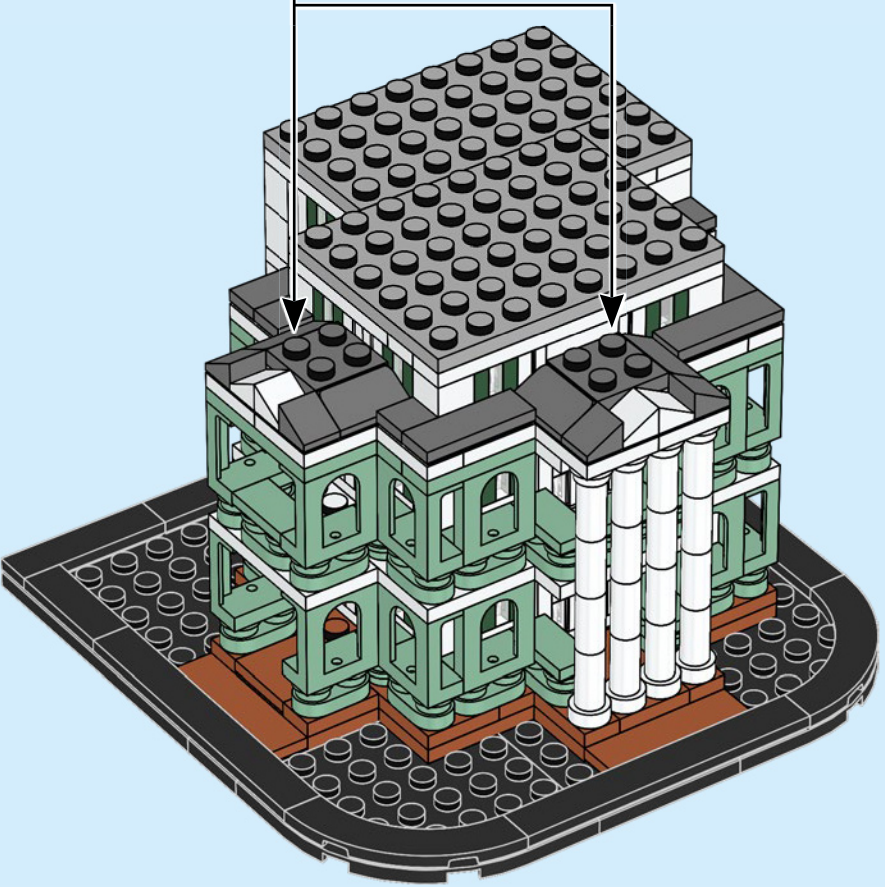



4x



4x

110

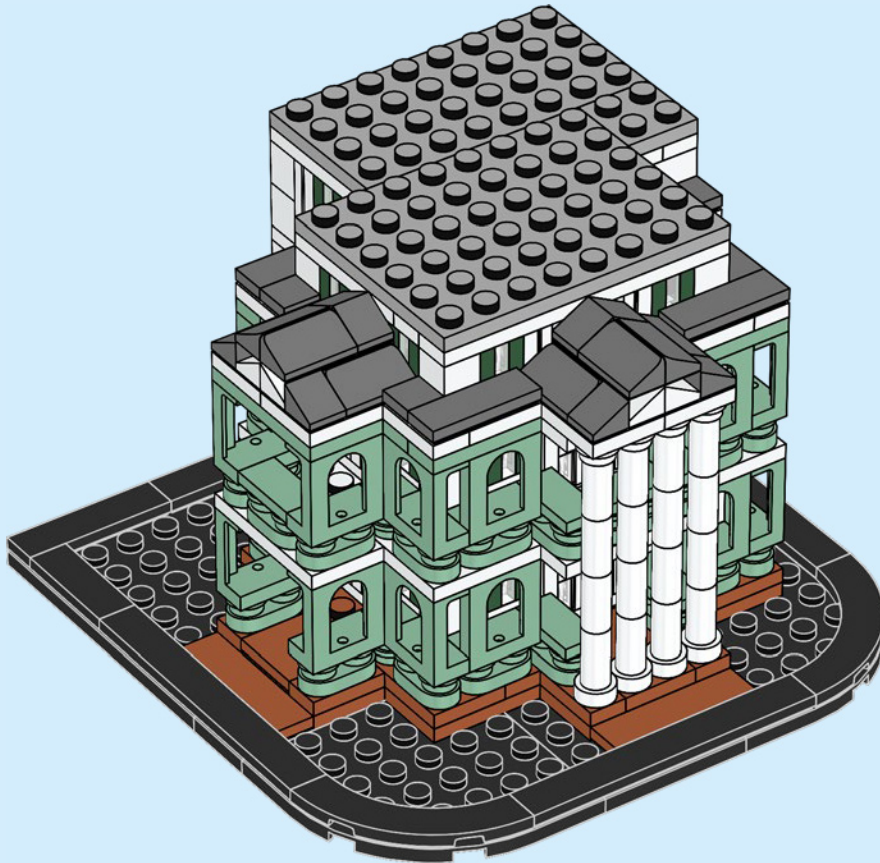



22x

111

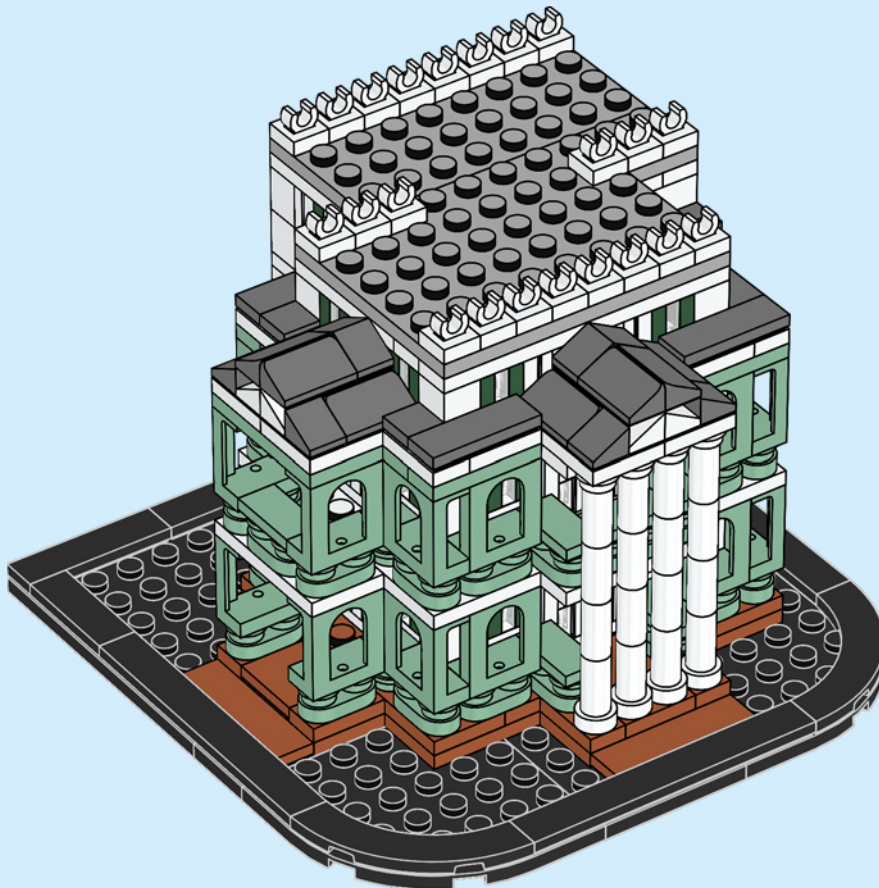



14x

112

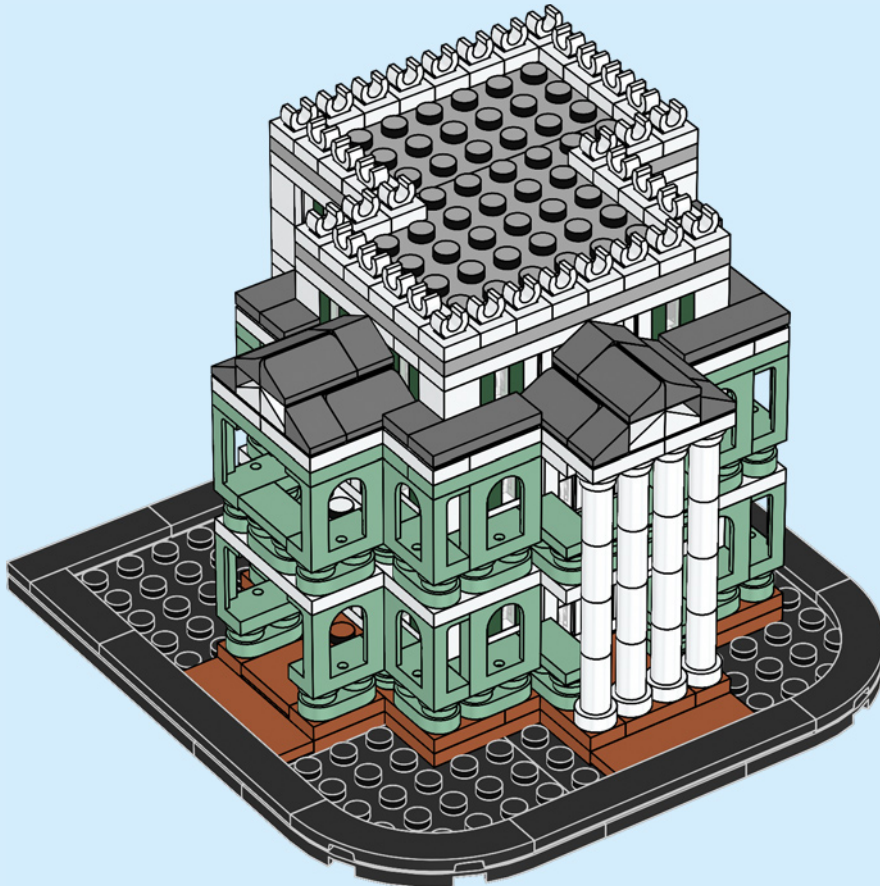



4x

113

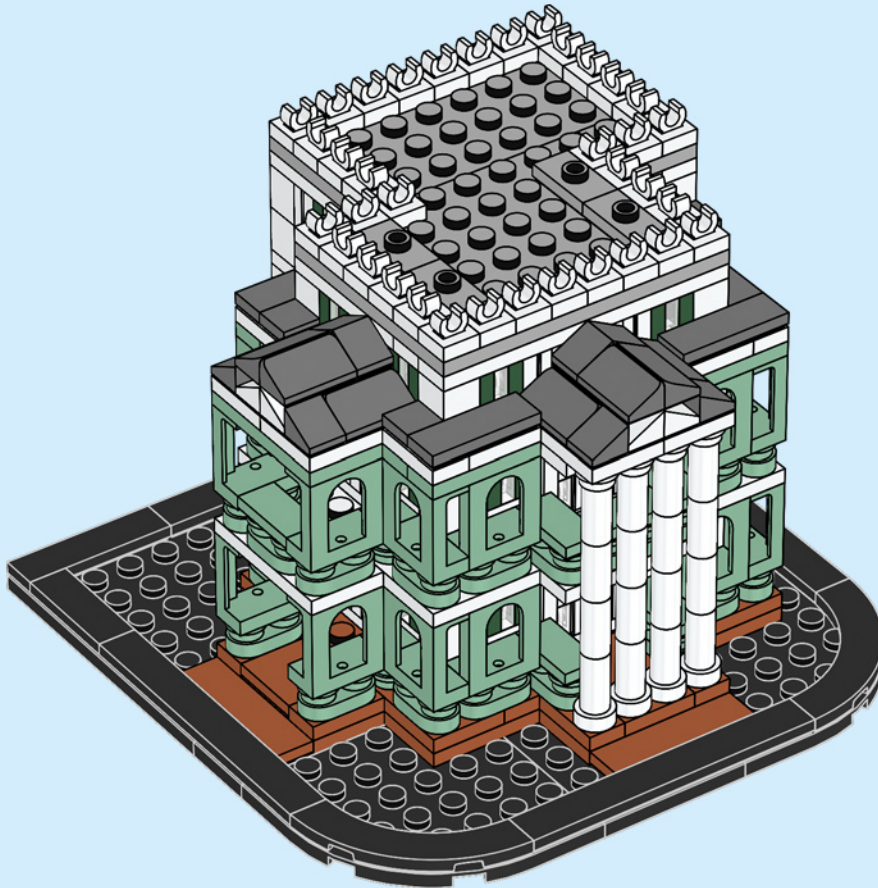

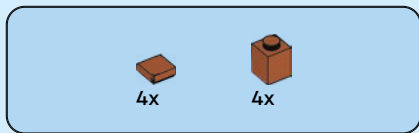

114

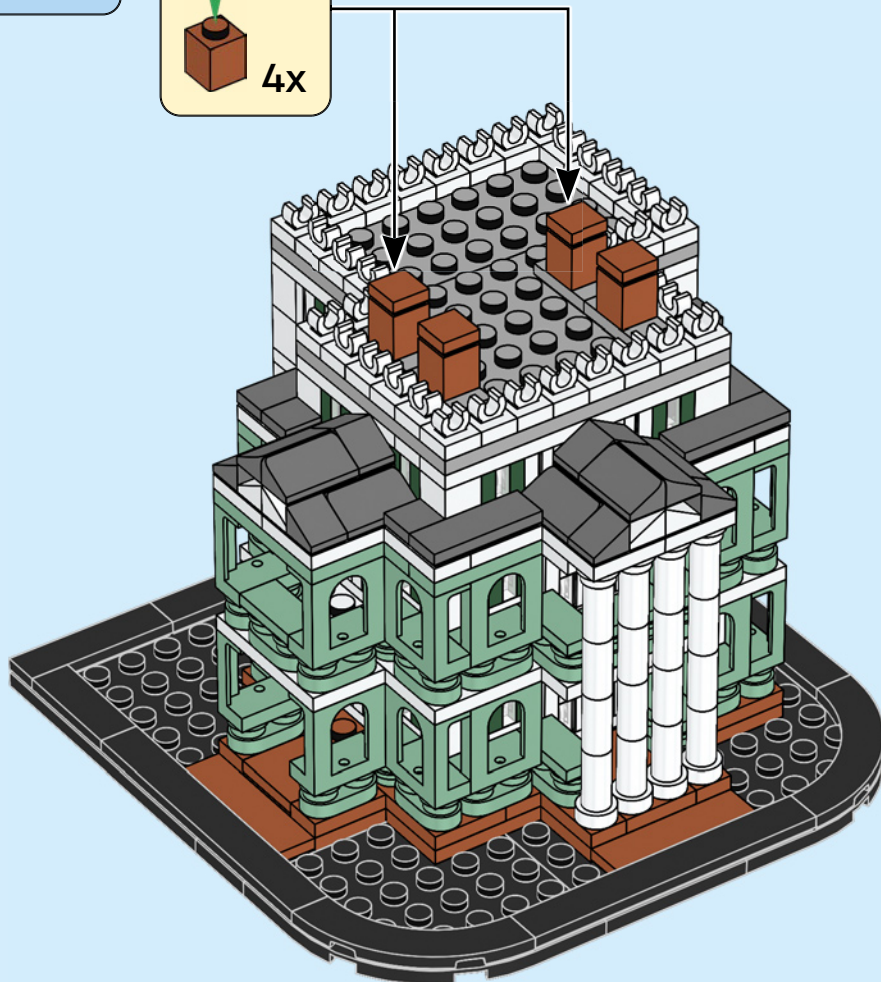
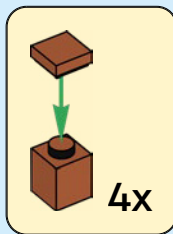

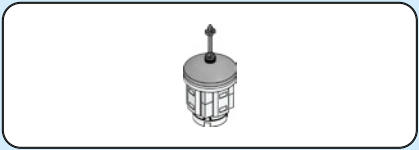

115



116

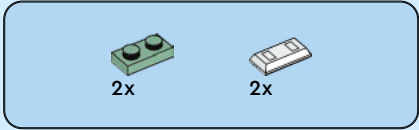
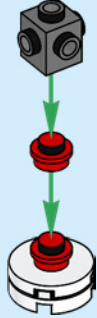

117

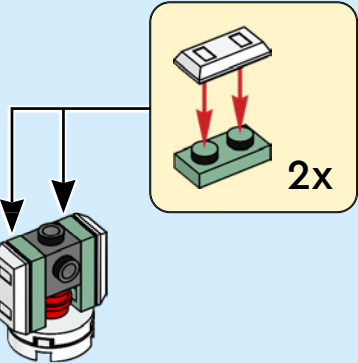

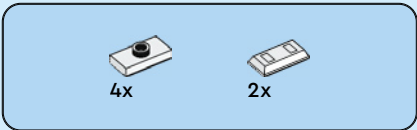

118

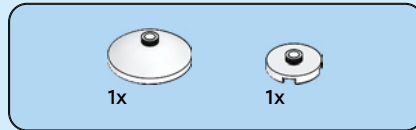
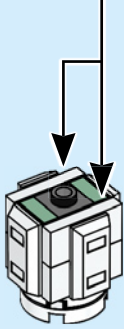
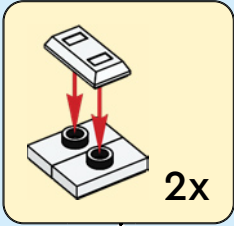

119

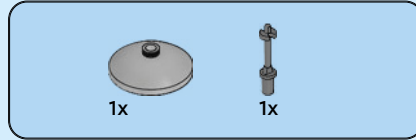
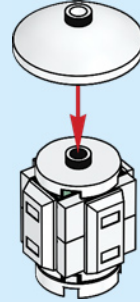

120

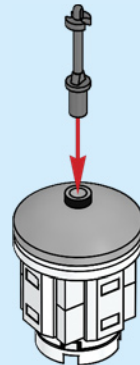

121

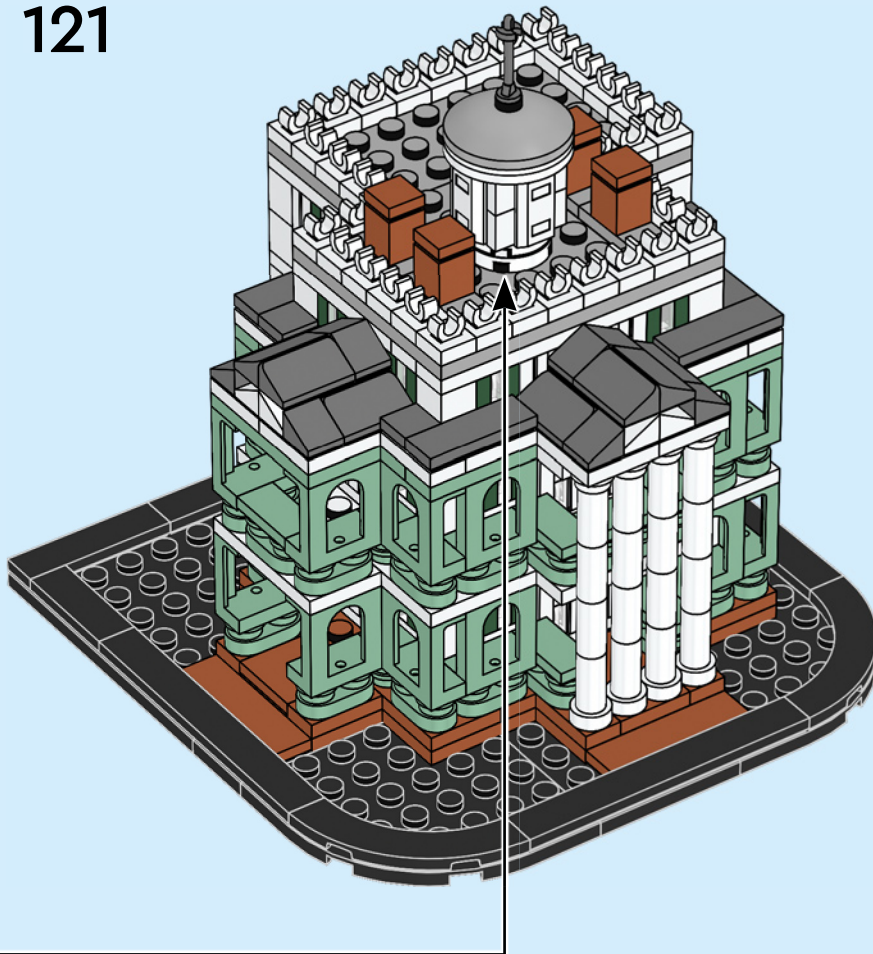

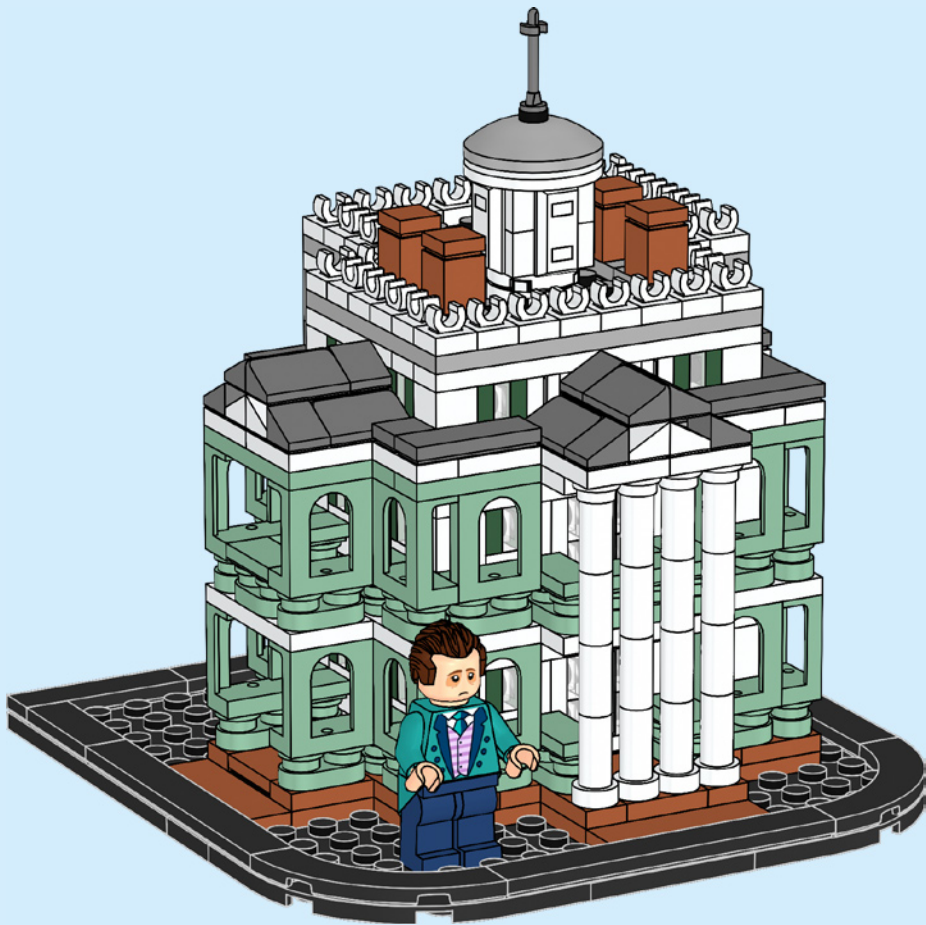



1x
302124



3x
6357747



16x
6234807



3x
6299492



4x
6168642



4x
6186681



3x
302401



40x
300501



5x
4558952



12x
6218841



4x
6224811



4x
6337079



4x
4504369



36x
6348055



36x
306901



4x
6210076



4x
6051511



4x
300401



2x
6346616



1x
6153776



9x
242001



2x
235701



3x
362301



6x
302101



40x
302301



1x
403201



1x
4179580



2x
6093053



2x
6133766



4x
243101



4x
371001



2x
6249091



1x
301001



3x
302001



1x
6104805



6x
366601



1x
300901



2x
663601



1x
300801



3x
346001



2x
303401



1x
4528341

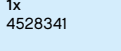

2x
6020122

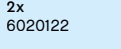

2x
4166619



2x
614126



6x
6335388



2x
6093525



2x
4558170



2x
243126



2x
6171264



4x
416226



2x
379526



2x
6137779



1x
303526

4x
6254484

4x
6143431

8x
4570877

2x
6186423



7x
6359717

1x
6074892

2x
6074893

9x
4535928

1x
6406947

1x
6406954

1x
6400087

6x
4521948

2x
6328131

23x
6303004



3x
4655080

16x
6013299



6x
4616578

1x
6069257

1x
6249817

1x
6099187

1x
6194726

1x
6328184

52x
6403175

14x
6099189

4x
6223913

2x
6062574

1x
6123038

5x
4211151

3x
6186867

34x
6252041

8x
6254254

1x
6206148

2x
614121

52x
6055169

1x
6135287

2x
6215606

2x
6383946

1x
4162916



11x
4211564



4x
6066097

1x
6383177

3x
4211397

1x
6070564

1x
4211407

1x
4211408

1x
6250678

1x
6278155

8x
4504378

2x
4210848

1x
4210700

8x
4567887

1x
4211052

2x
4211094

4x
4568734

11x
6001824

2x
6015424

3x
4218749

2x
4113233

3x
302023

4x
6190252

2x
6335111

1x
6326425

Customer Service
Kundenservice
Service Client
Assistenza clienti
Atención al cliente
Serviço de Apoio ao Consumidor
Ügyfélszolgálat
Klientu apkalpošanas dienests
Serviciul pentru clienț
客户服务
コンシューマーサービス
고객 서비스
LEGO.com/service

WIN

Terms & Conditions apply

Scan this QR code or go to **LEGO.COM/PRODUCTFEEDBACK** and give us your short feedback about this LEGO® set for a chance to win a cool LEGO prize.



GEWINNE

Scanne diesen QR-Code oder geh auf LEGO.COM/PRODUCTFEEDBACK

und gib uns dein kurzes Feedback zu diesem LEGO® Set. Dann hast du die Chance, einen coolen LEGO Preis zu gewinnen.

Es gelten die Teilnahmebedingungen

GAGNE

Scannez ce code QR ou rendez-vous sur LEGO.COM/PRODUCTFEEDBACK

pour donner votre avis sur ce produit LEGO® et avoir une chance de gagner un prix LEGO.

Voir Conditions Générales

GANAN

Escanea este código QR o visita LEGO.COM/PRODUCTFEEDBACK

y comparte con nosotros tu opinión sobre este set LEGO® para tener la oportunidad de ganar un fantástico premio LEGO.

Términos y Condiciones aplicables

获取奖品

只需扫描此二维码或访问 LEGO.COM/PRODUCTFEEDBACK,

就这款乐高®套装提供简短反馈, 就有机会赢得很酷的乐高奖品。

《条款及条件》适用