



40596





Get excited about our new packaging!

We're switching from plastic to paper-based packaging. That's why you might find a mix of paper and plastic in our boxes!

Nos nouveaux emballages vous emballeront !

Nous passons des emballages en plastique aux emballages à base de papier. C'est pourquoi vous pourriez trouver un mélange de papier et de plastique dans nos boîtes !

¡Te presentamos nuestros nuevos empaques!

Estamos sustituyendo las bolsas de plástico por bolsas con base de papel. ¡Por eso, puedes encontrar una mezcla de papel y de plástico en nuestras cajas!

[LEGO.com/sustainable-packaging](https://www.lego.com/sustainable-packaging)

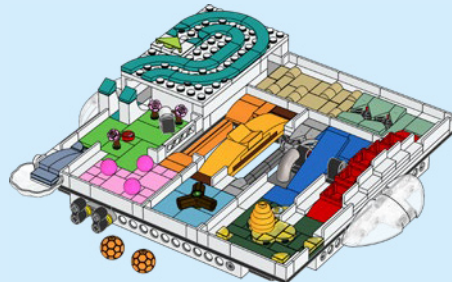
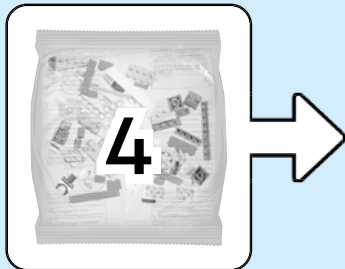
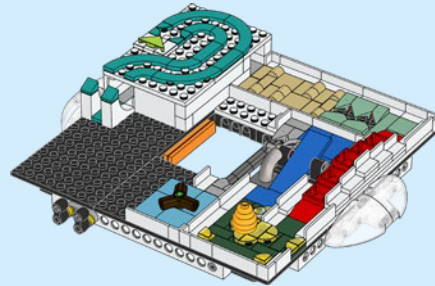
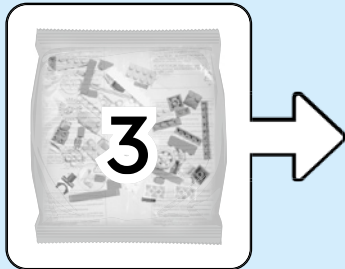
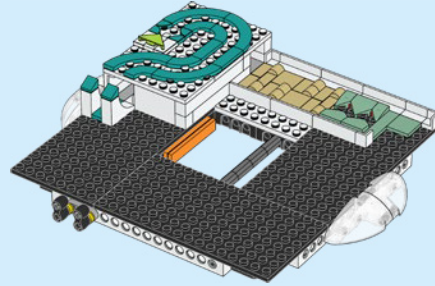
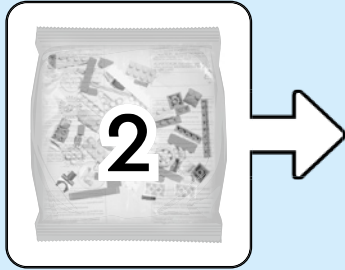
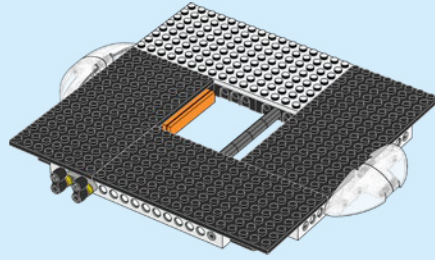
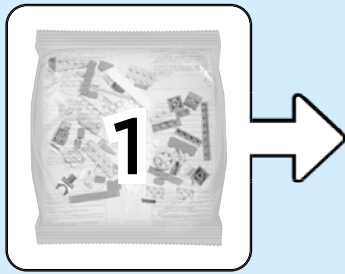

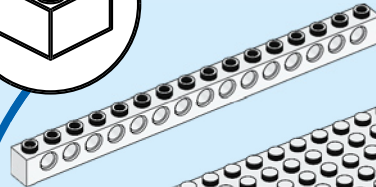
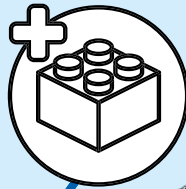
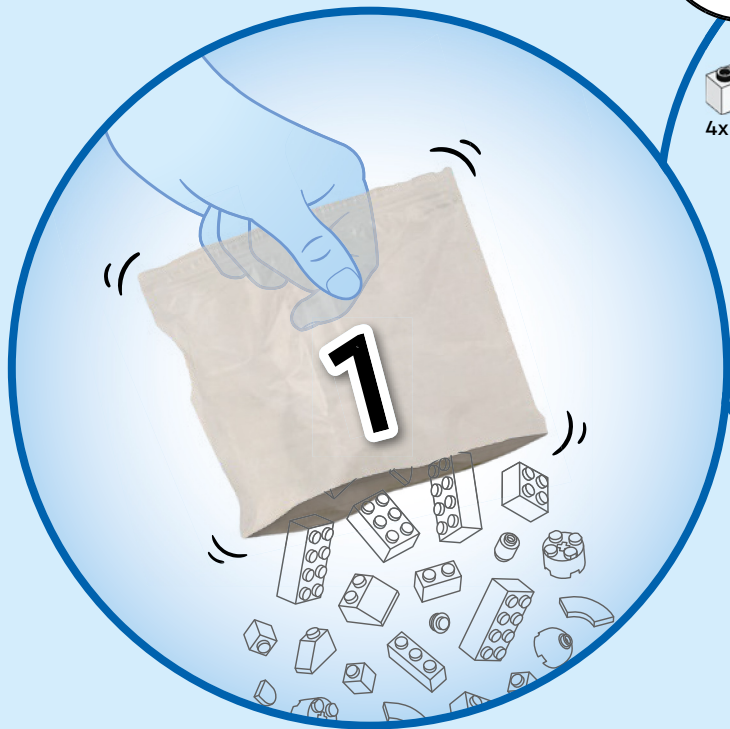

4x

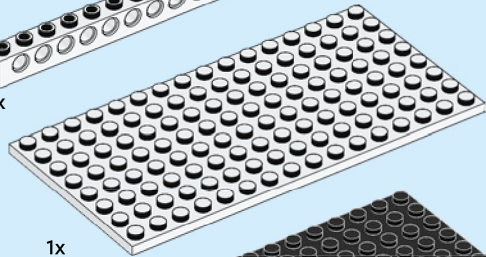

1x

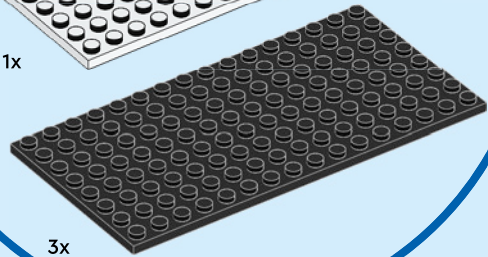

3x



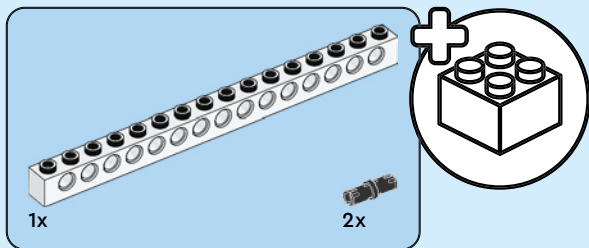

1

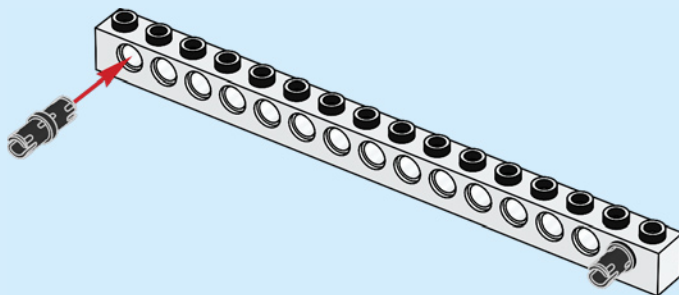

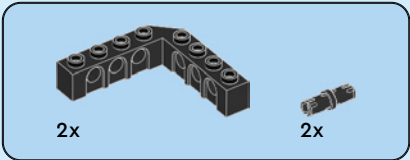

2

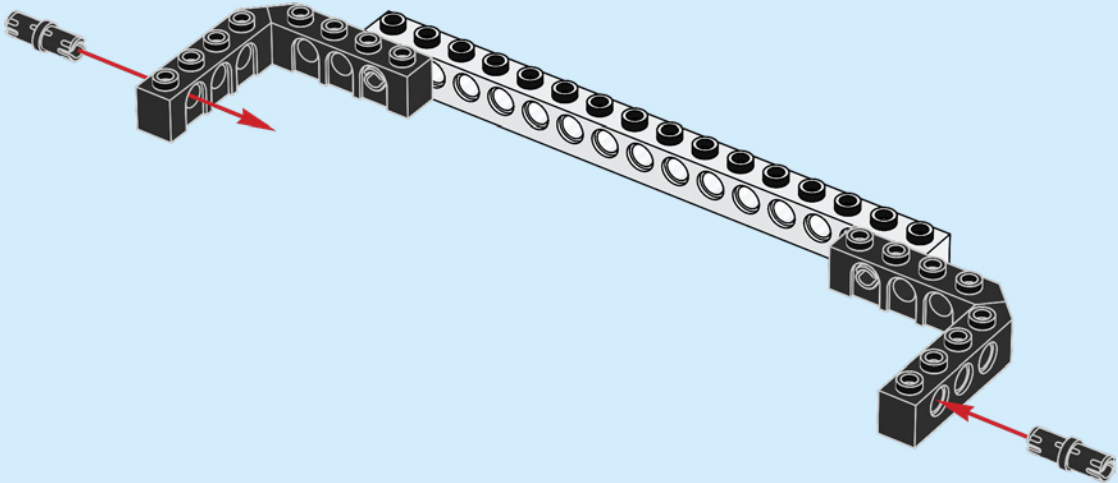

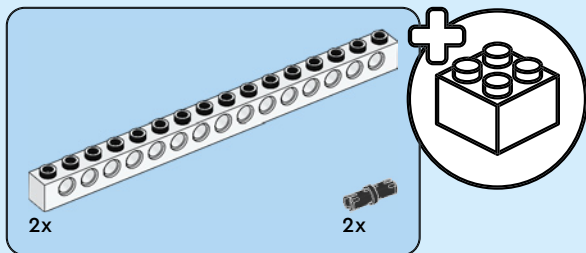

3

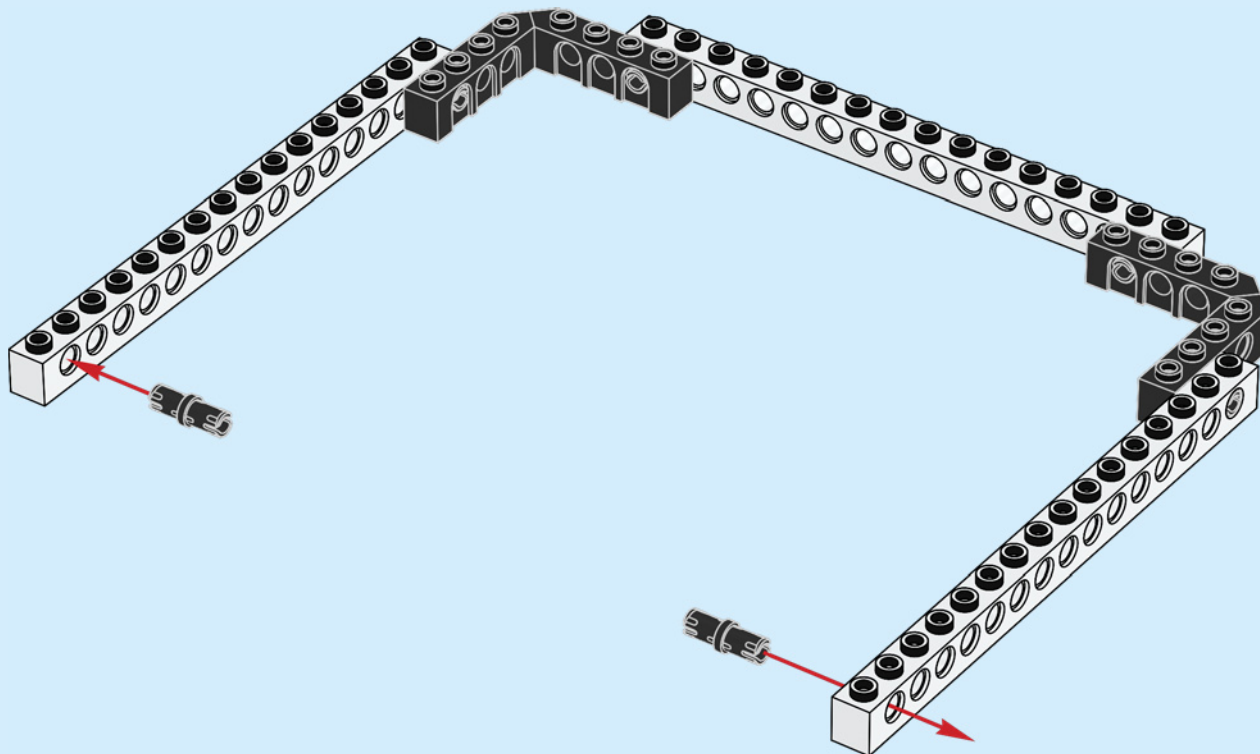

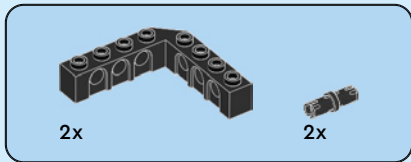

4

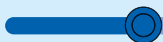
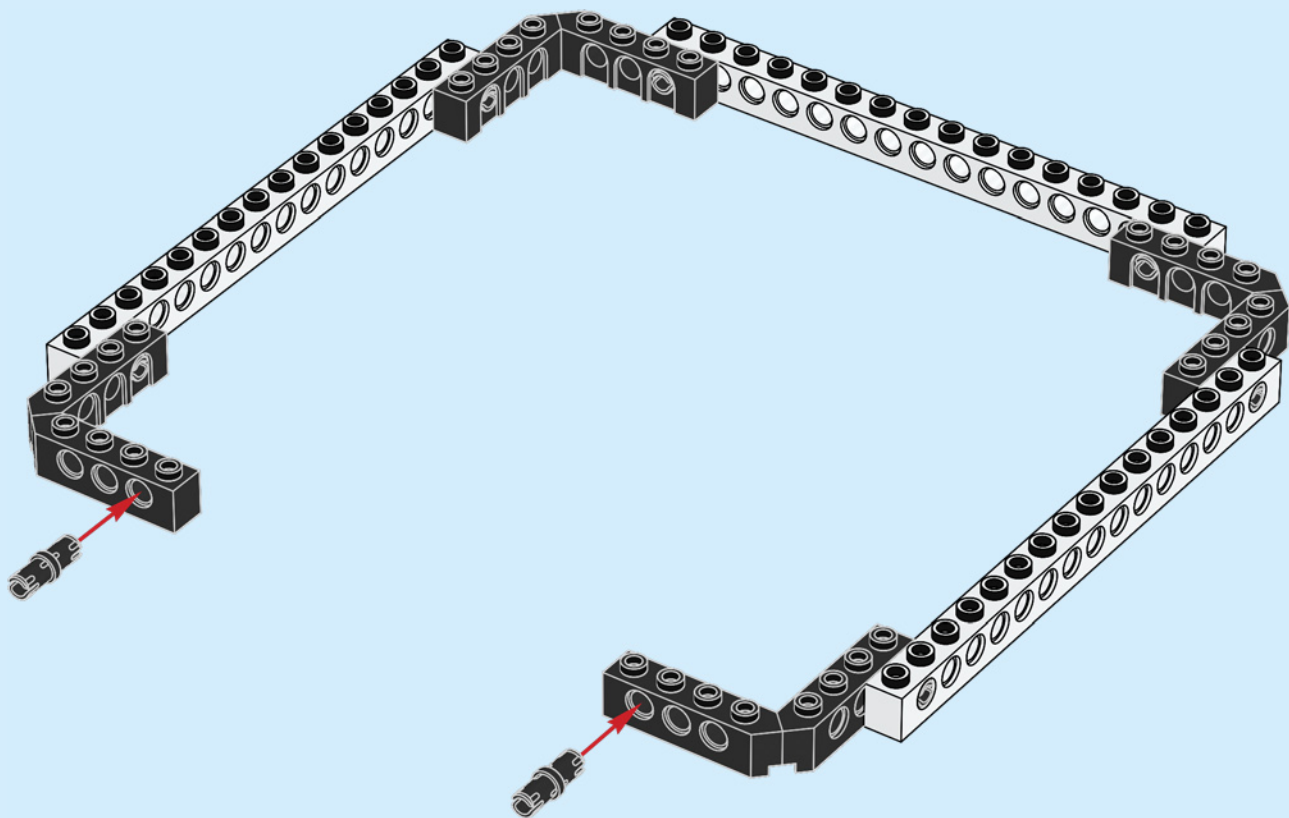

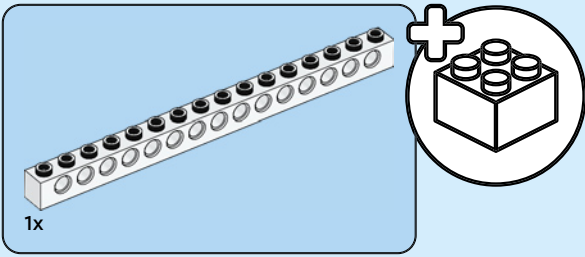

5

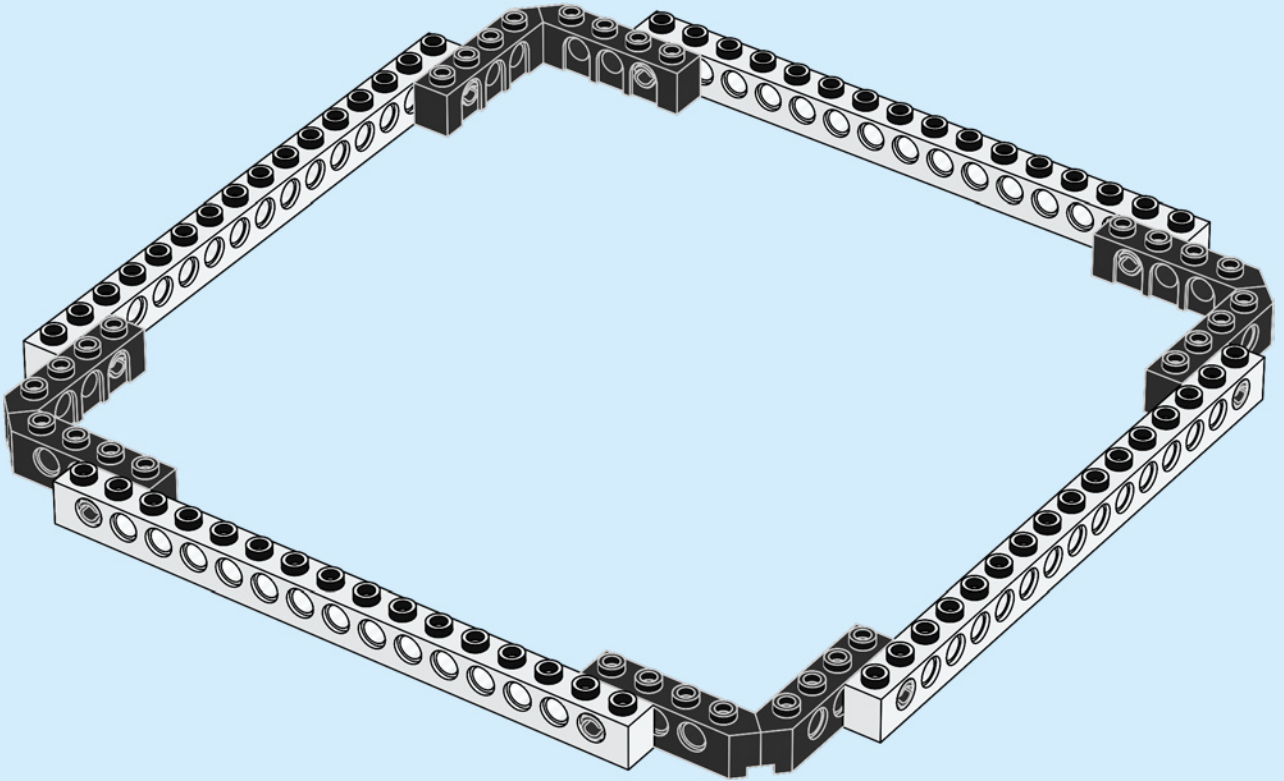

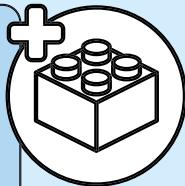
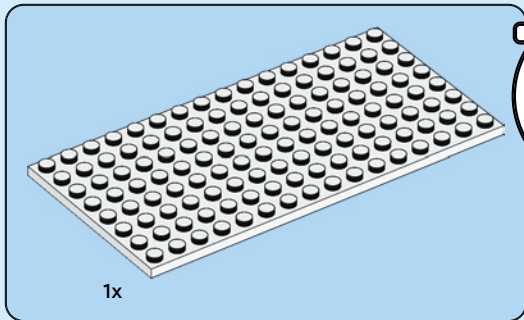

6

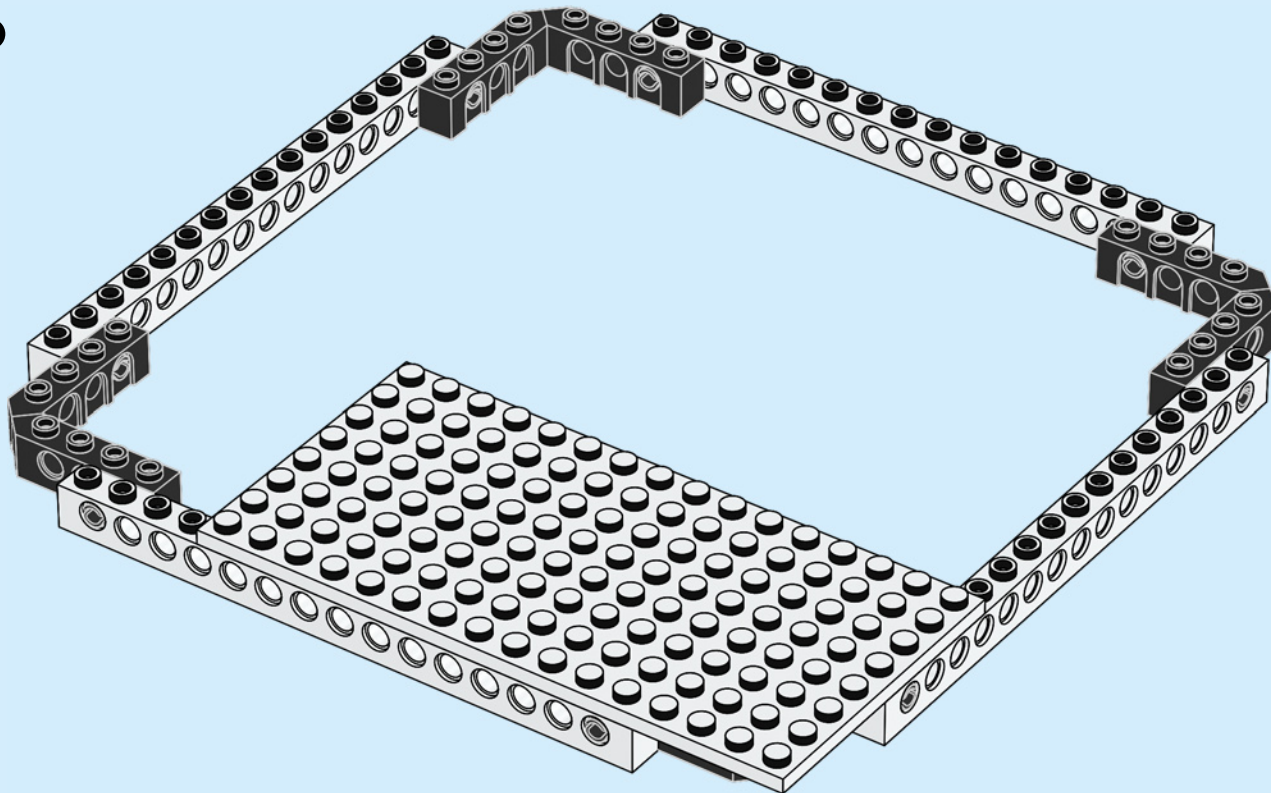

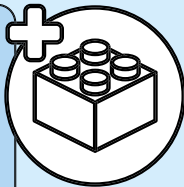
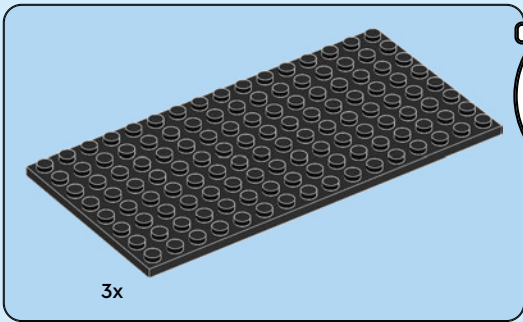

7

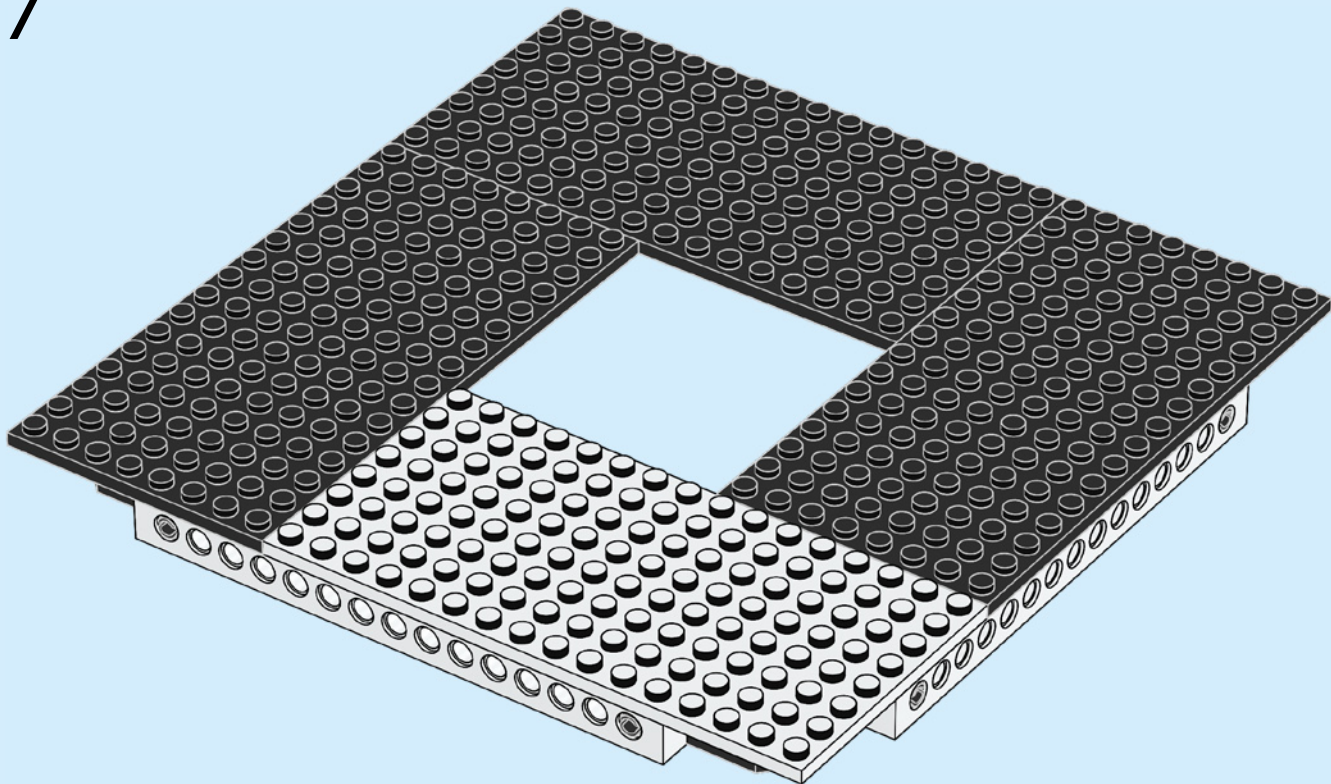

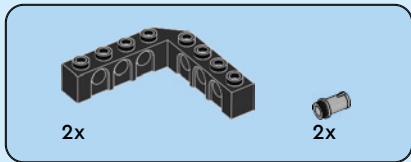

8

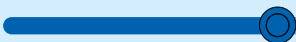
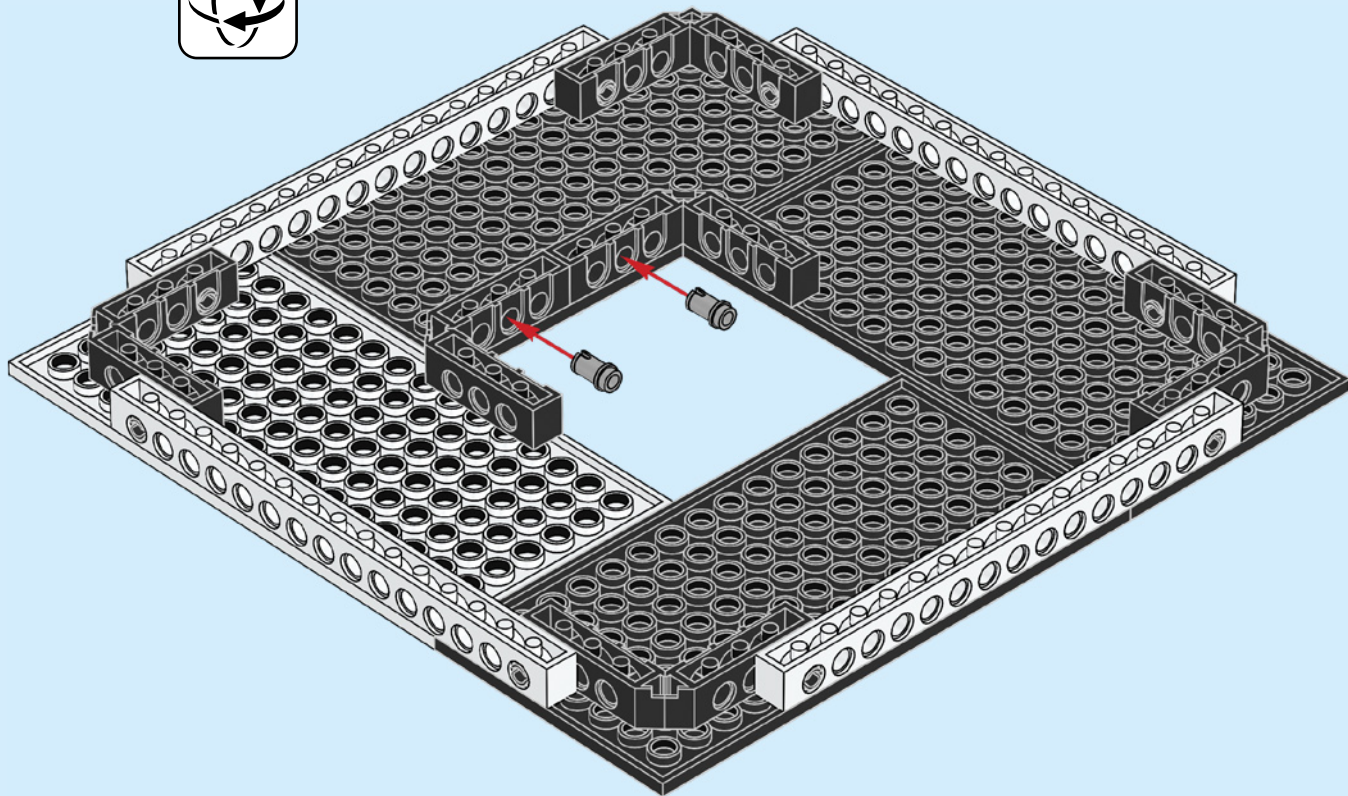

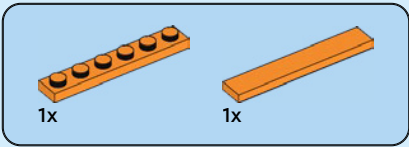

9

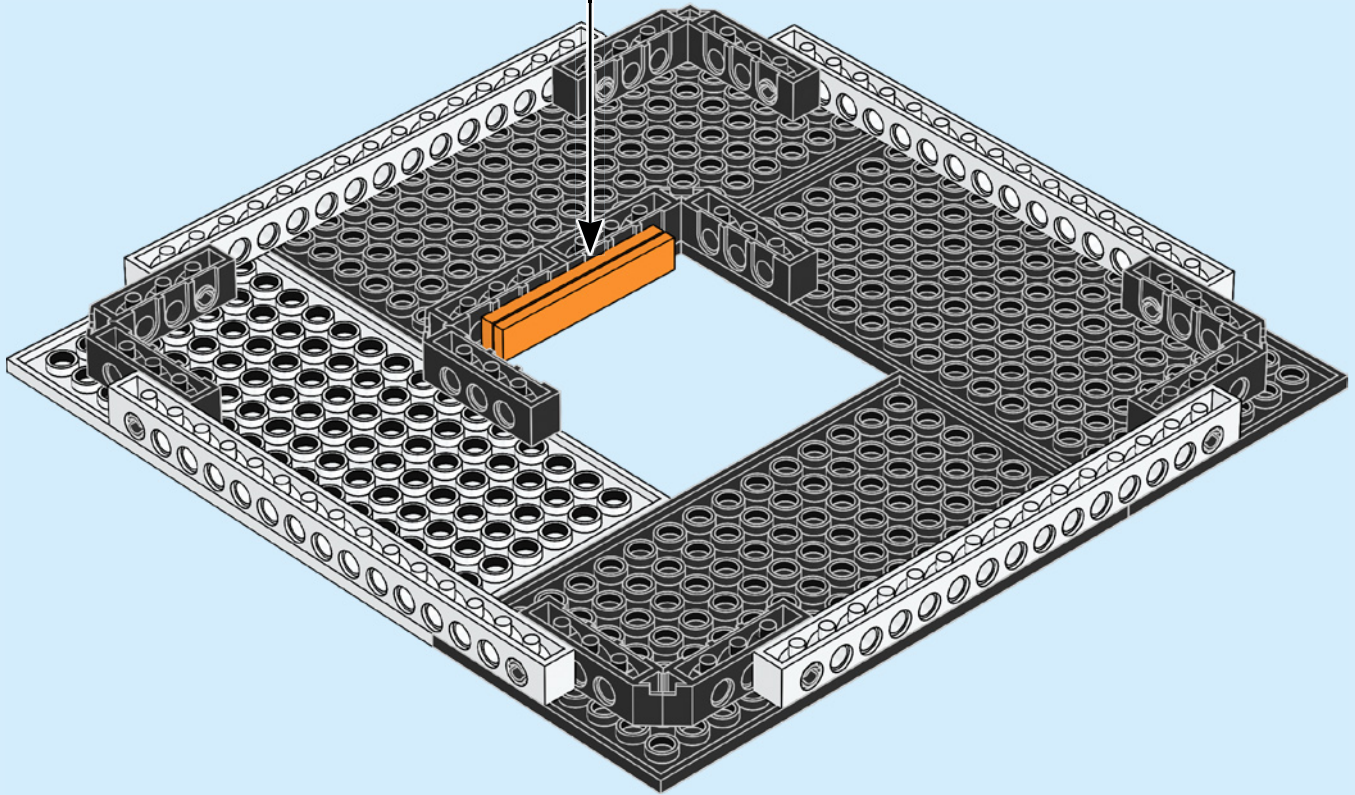
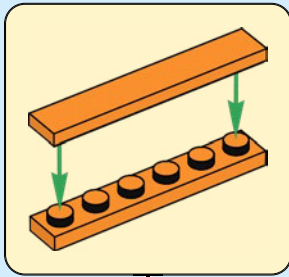

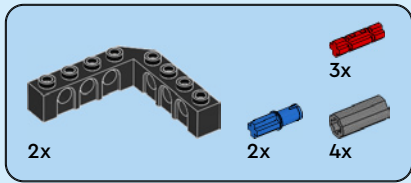

10

1

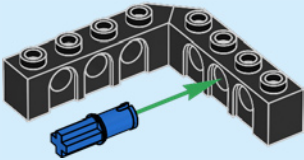

2

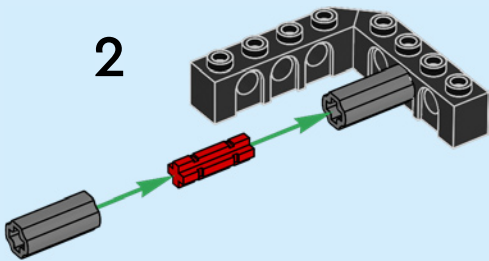

3

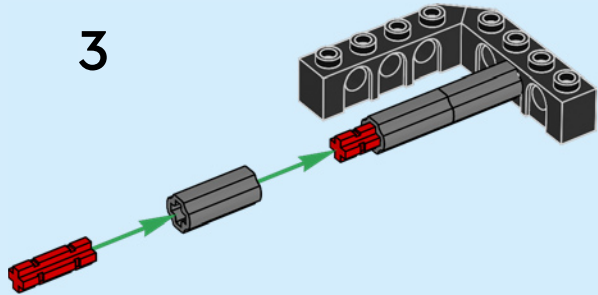

4

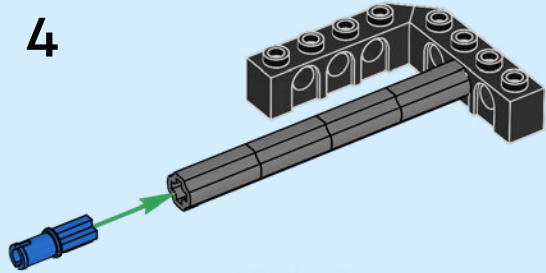

5

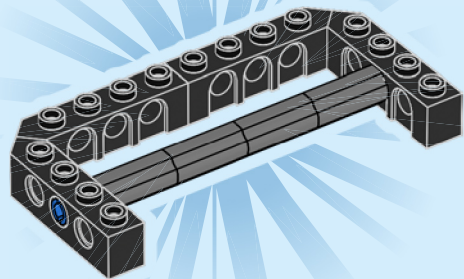

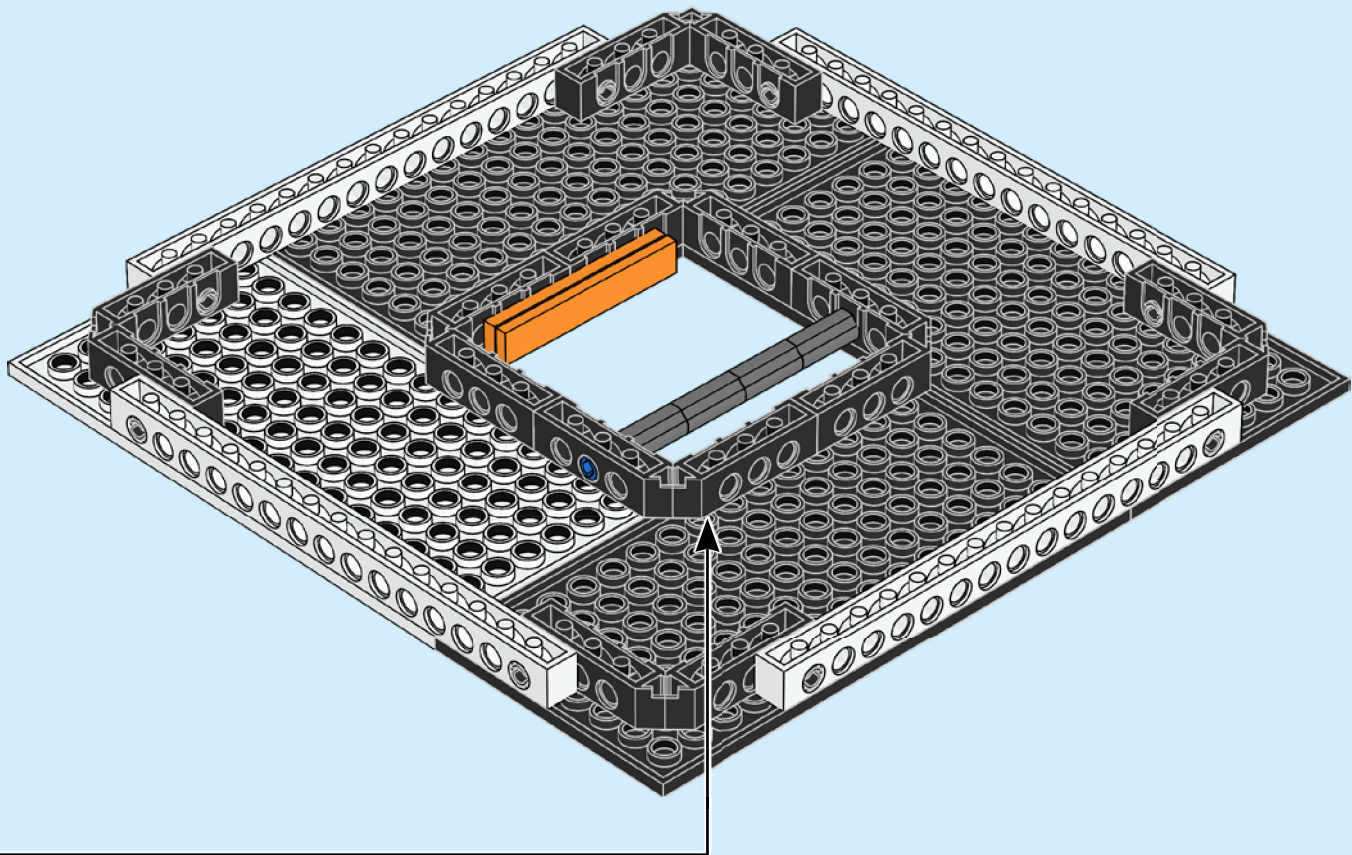

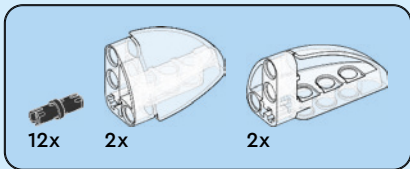
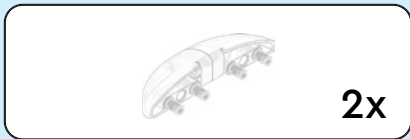

11

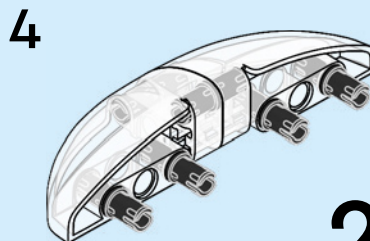
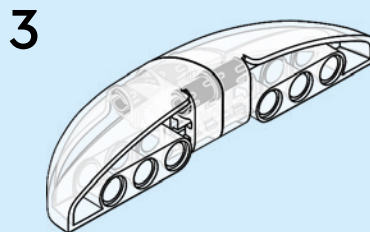
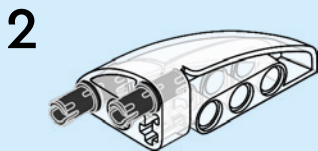
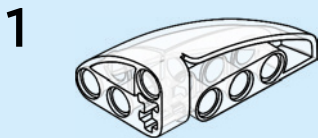

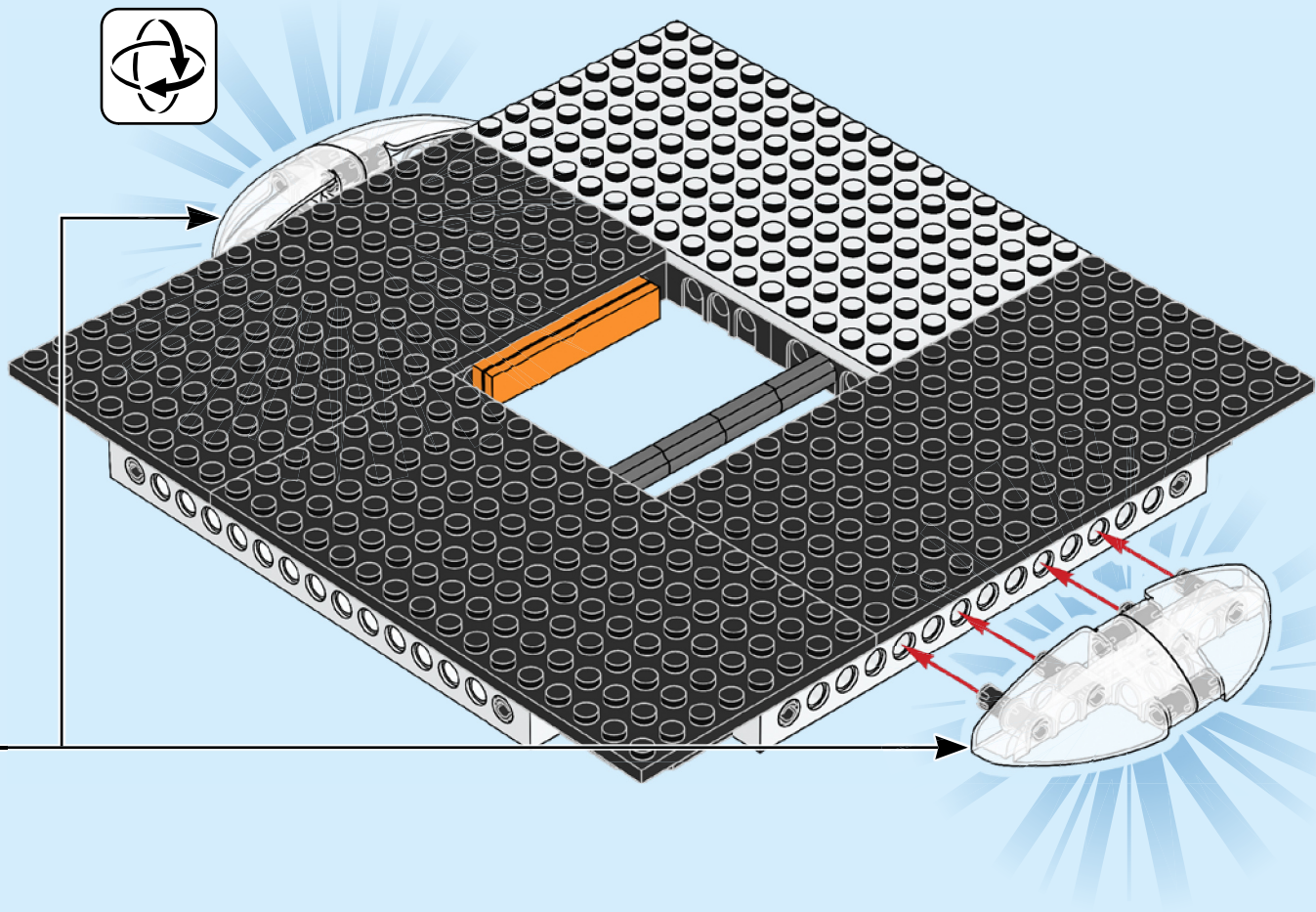

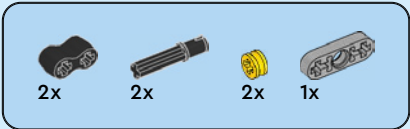

12

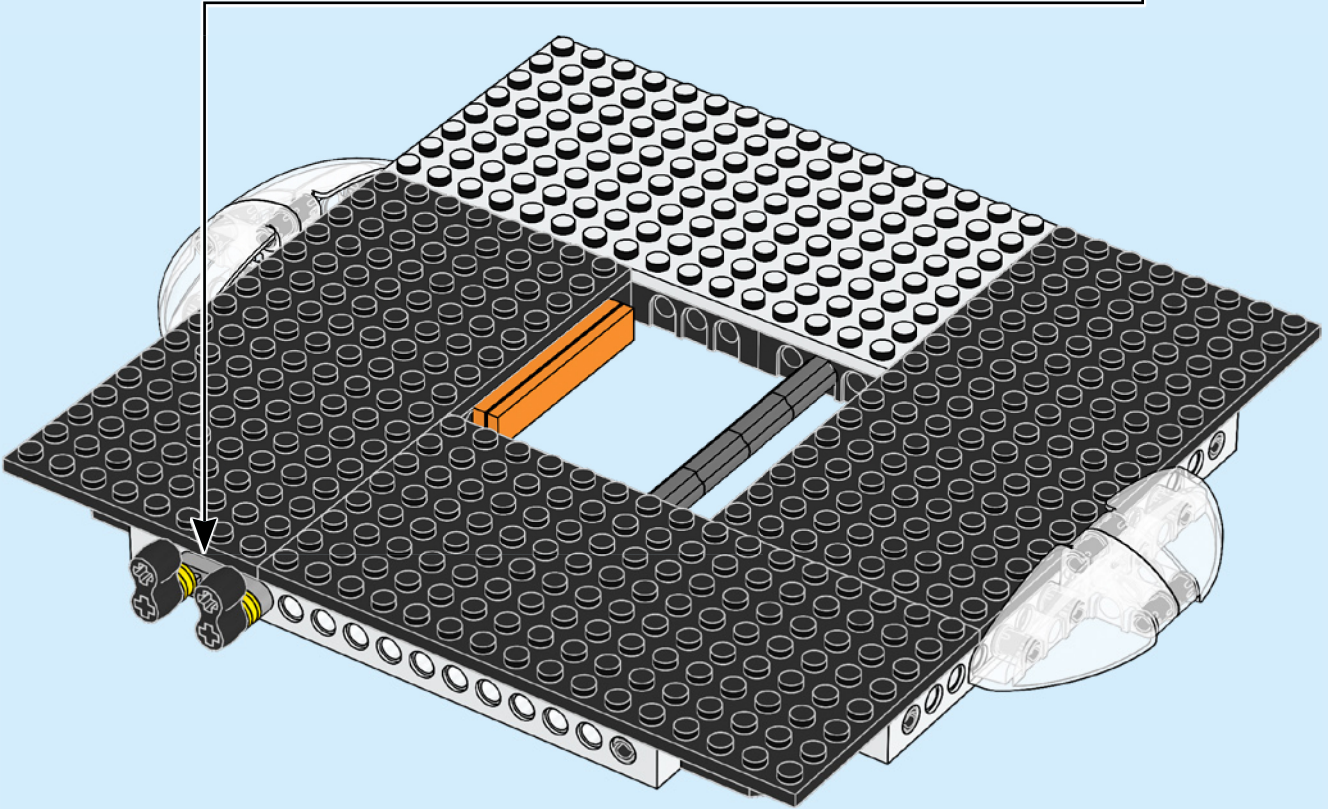
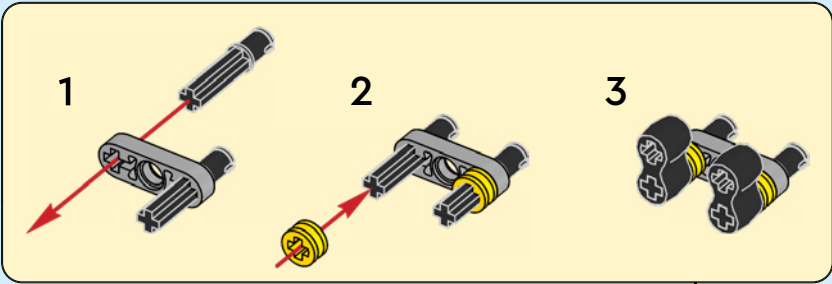

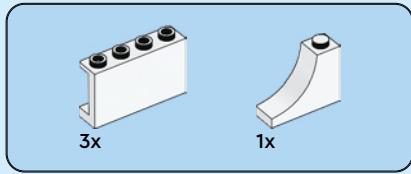

13

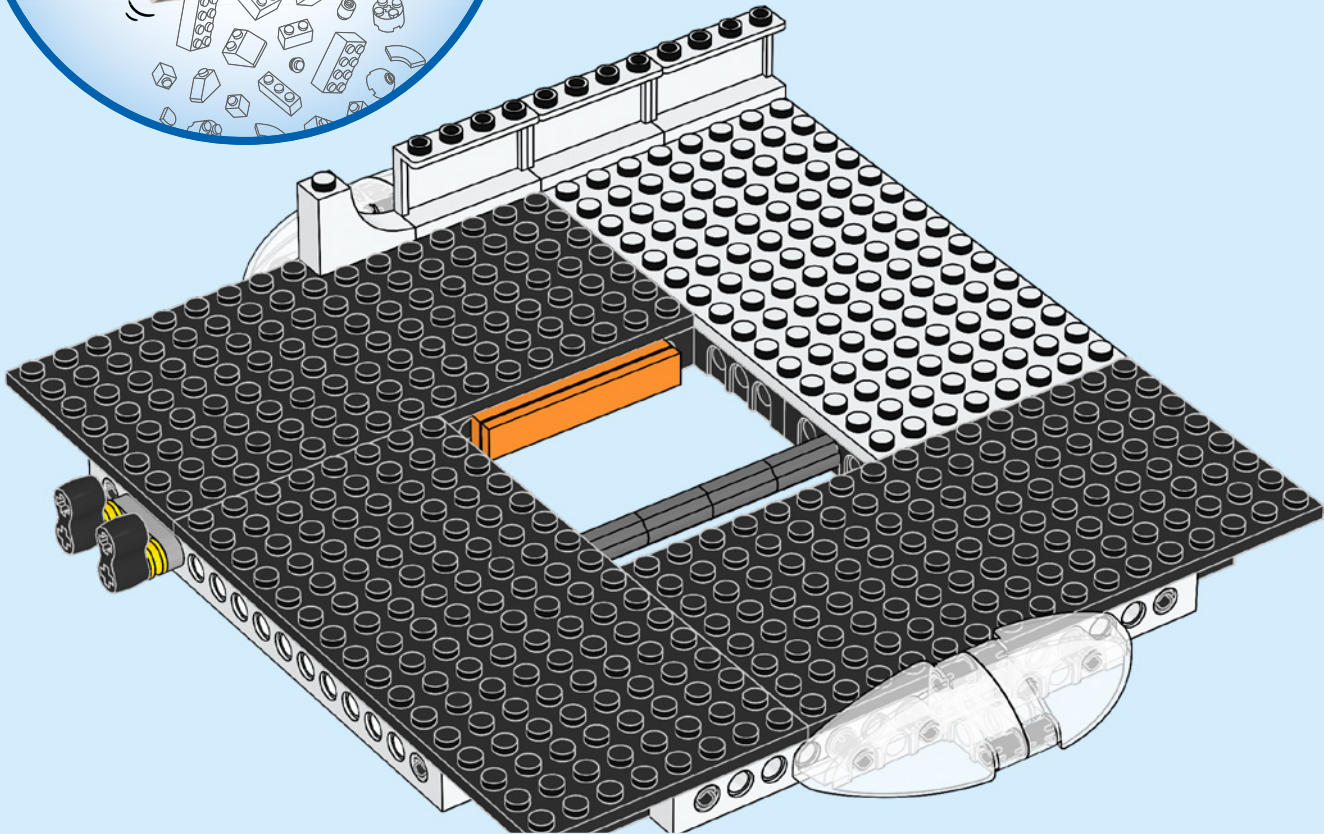

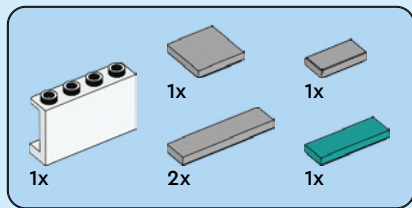

14

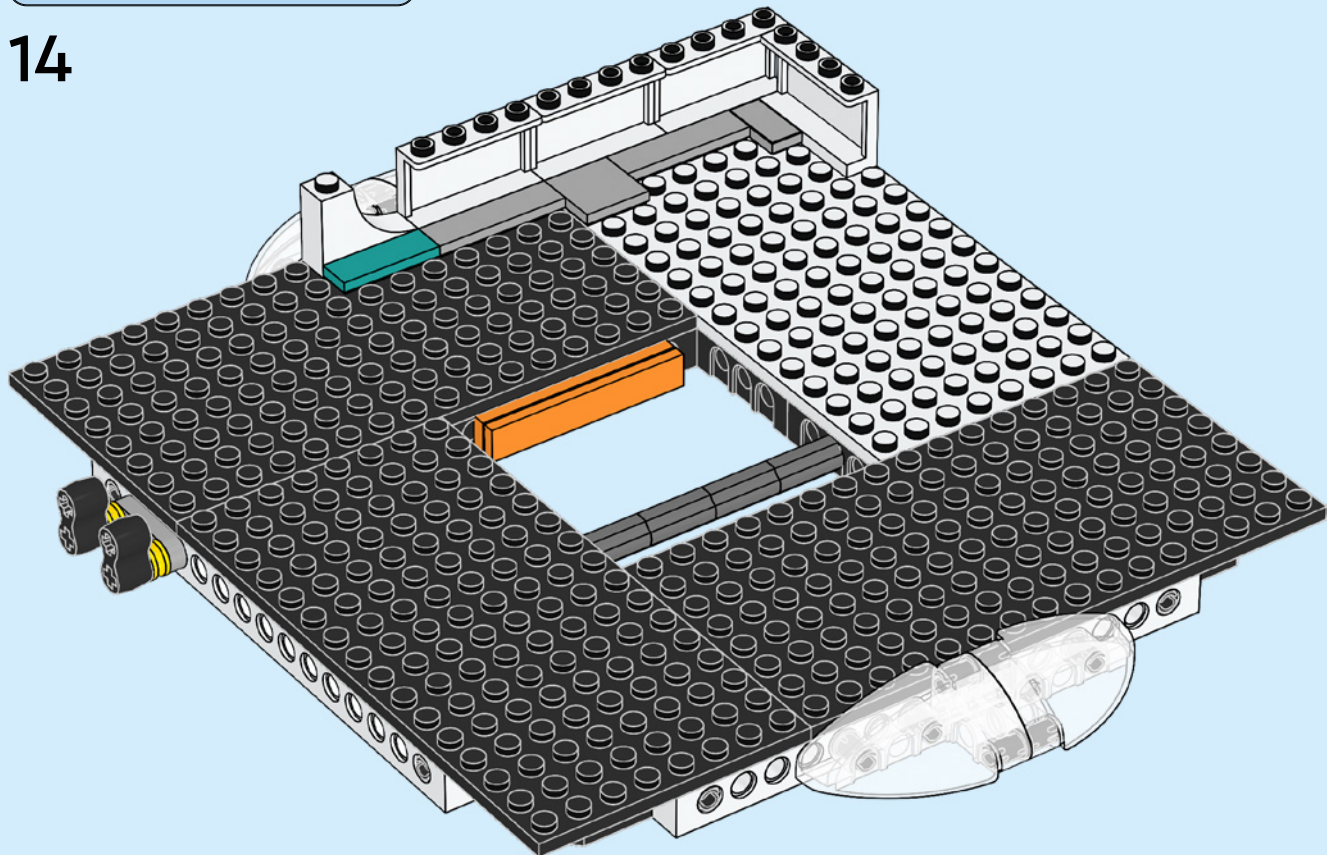

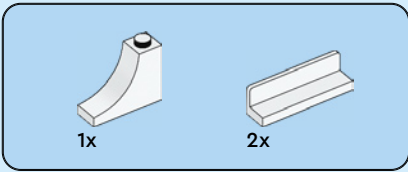

15

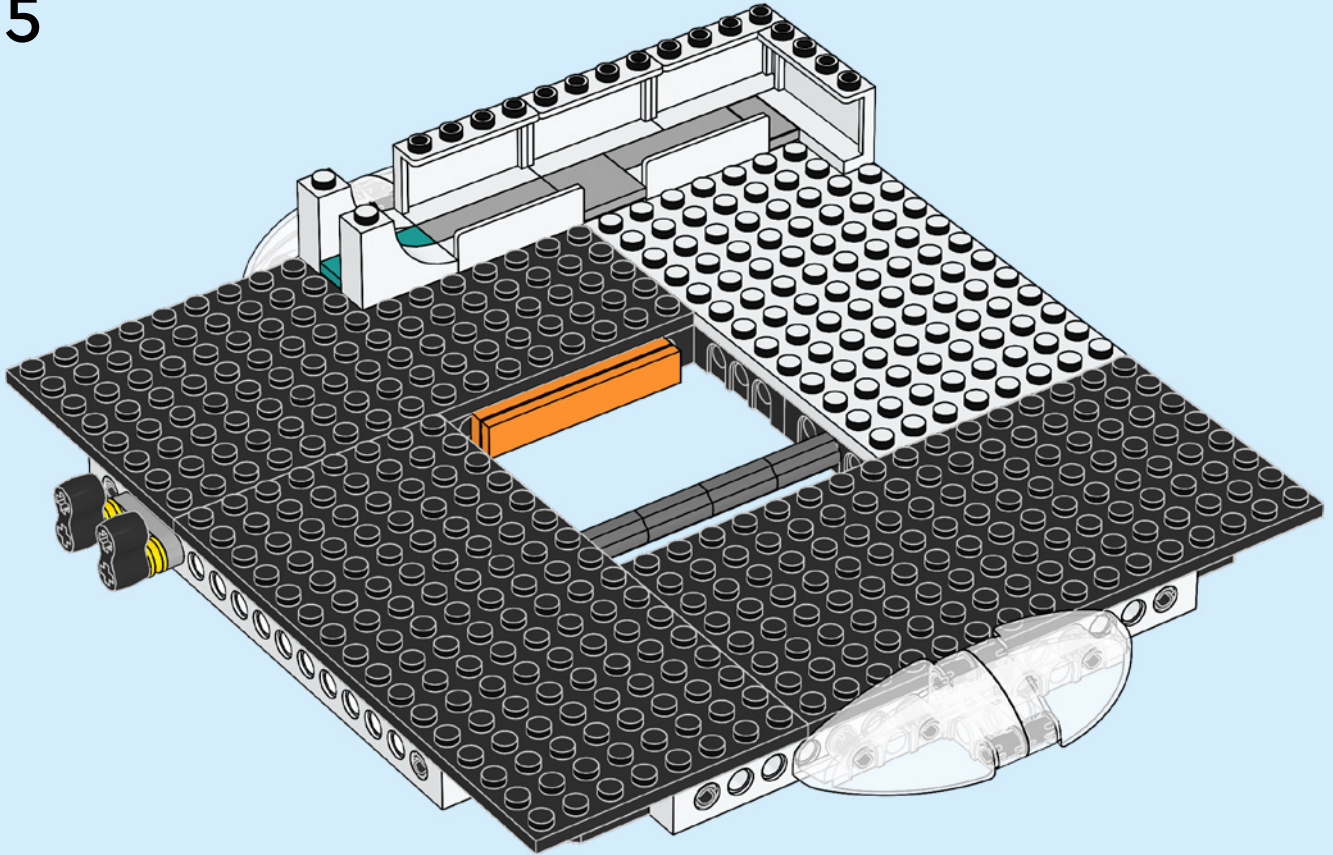

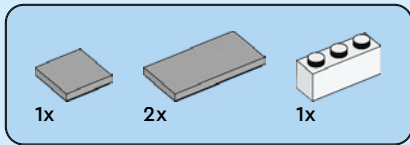

16

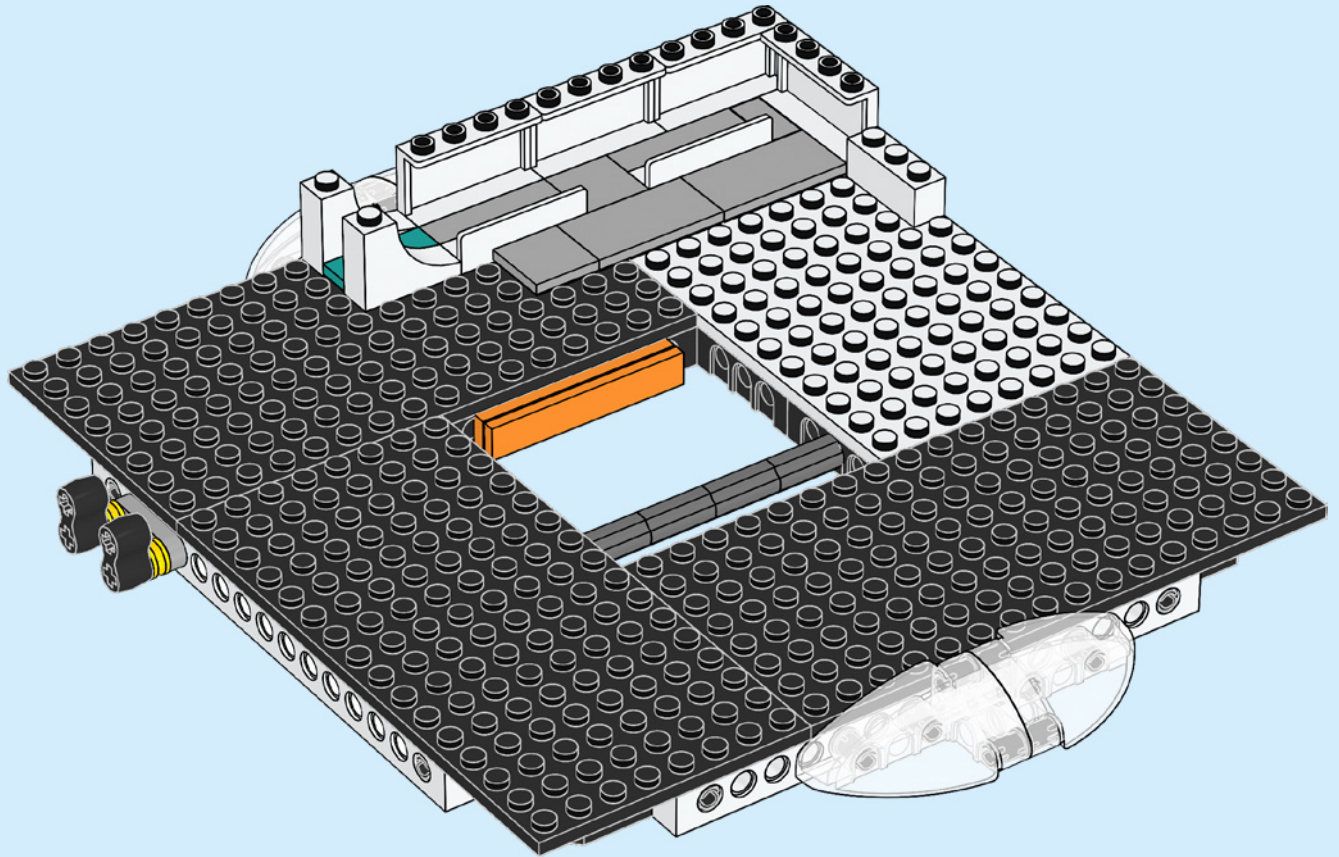

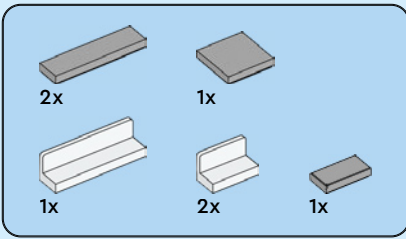

17

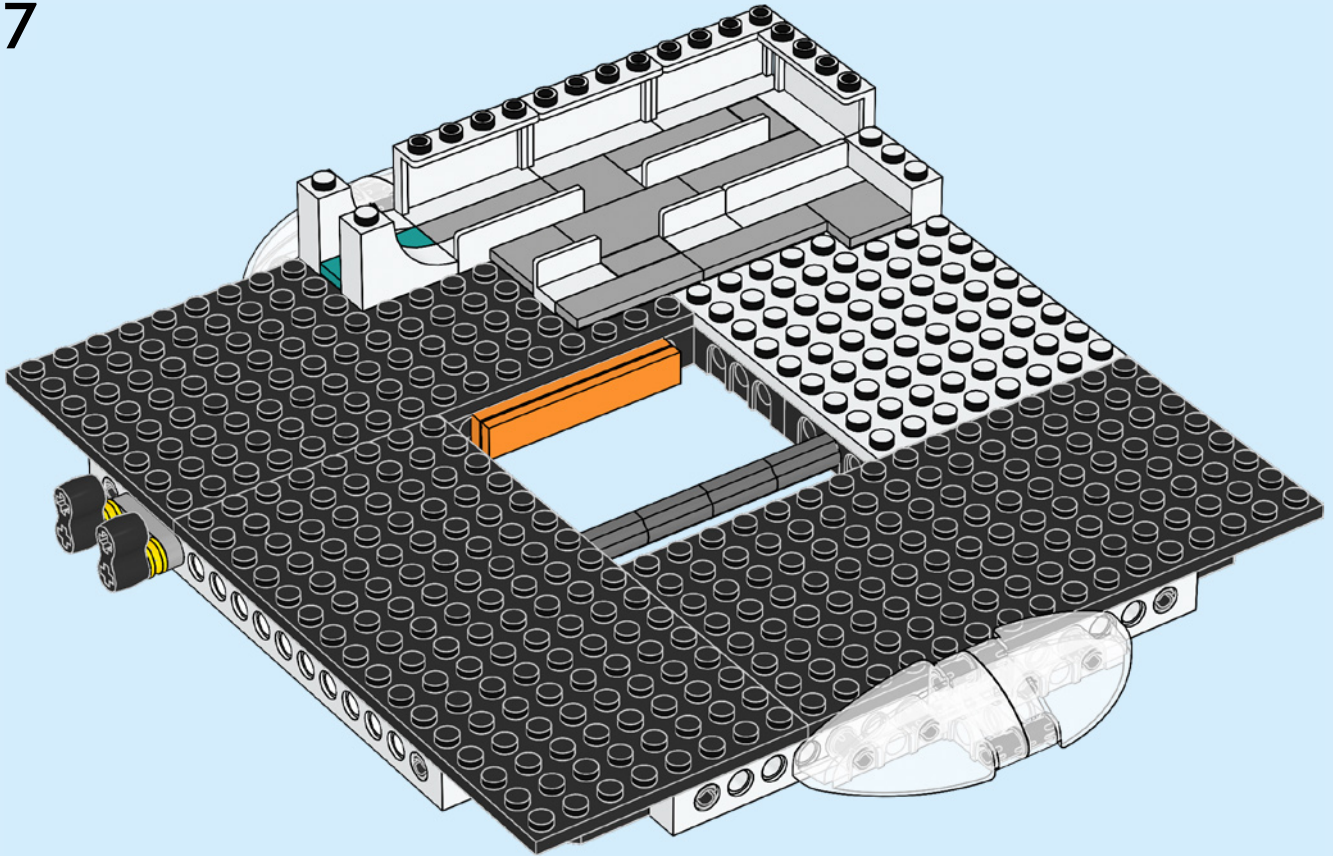

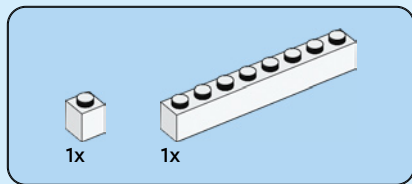

18

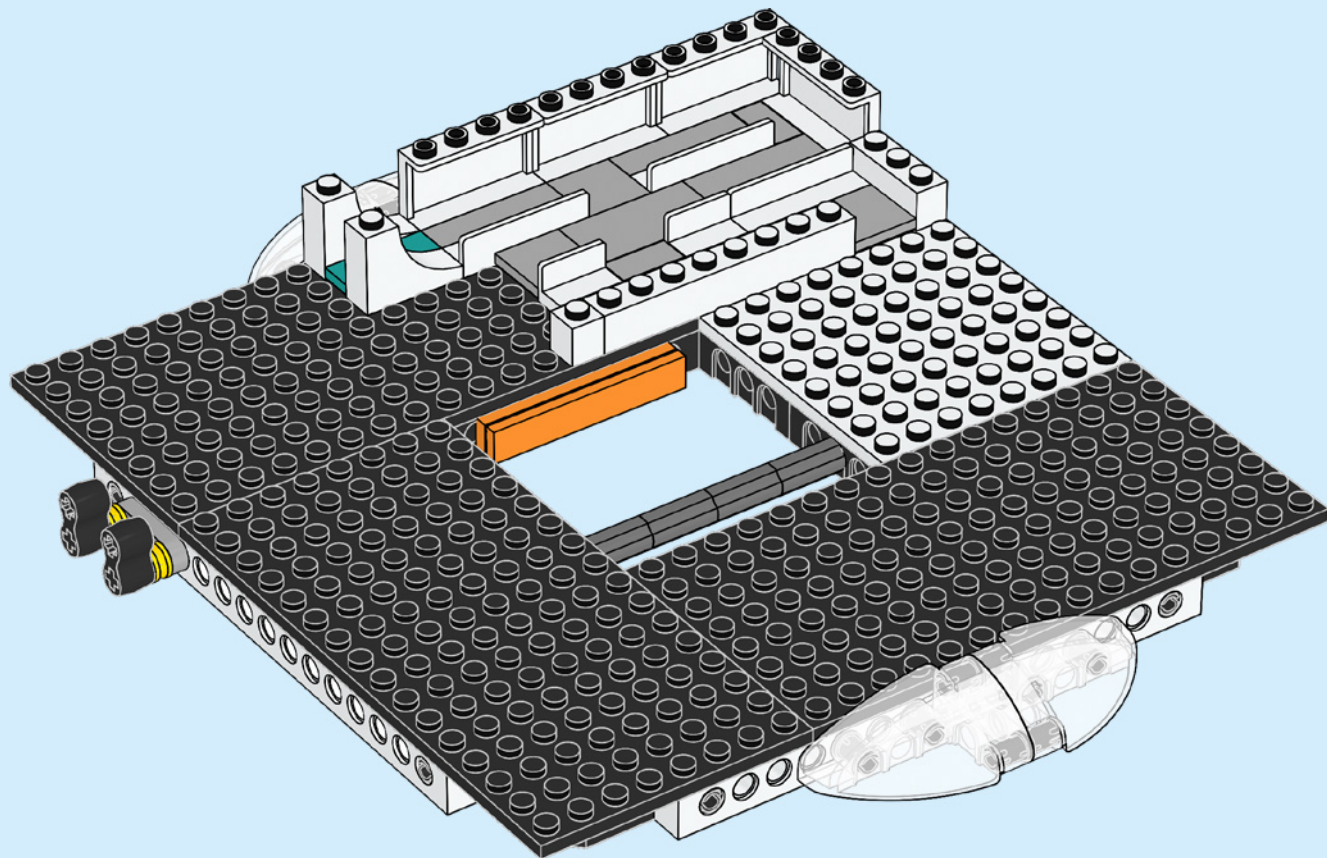

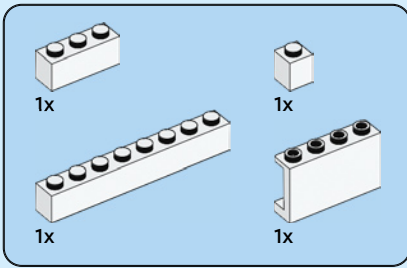

19

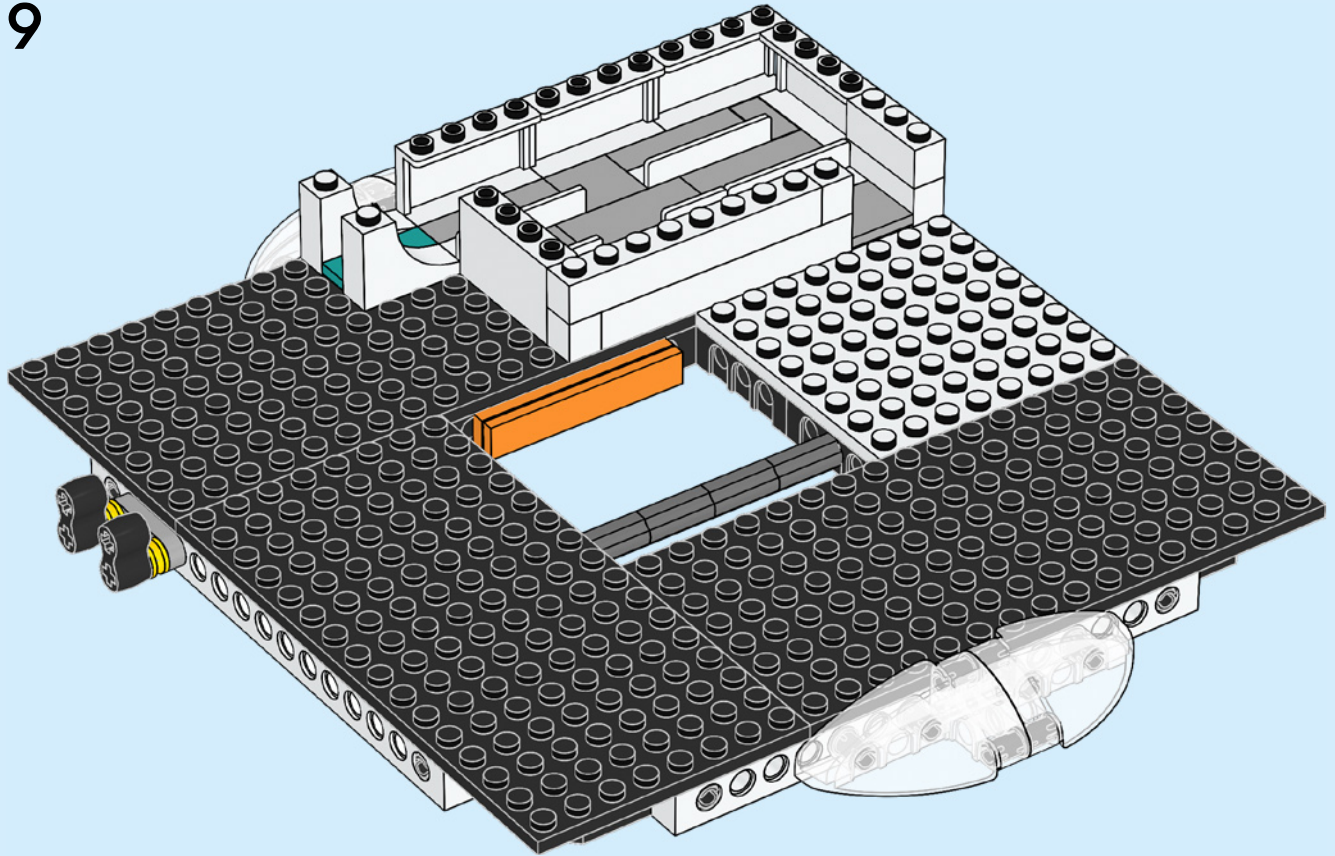

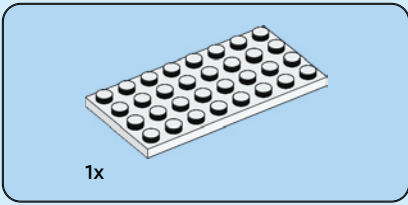

20

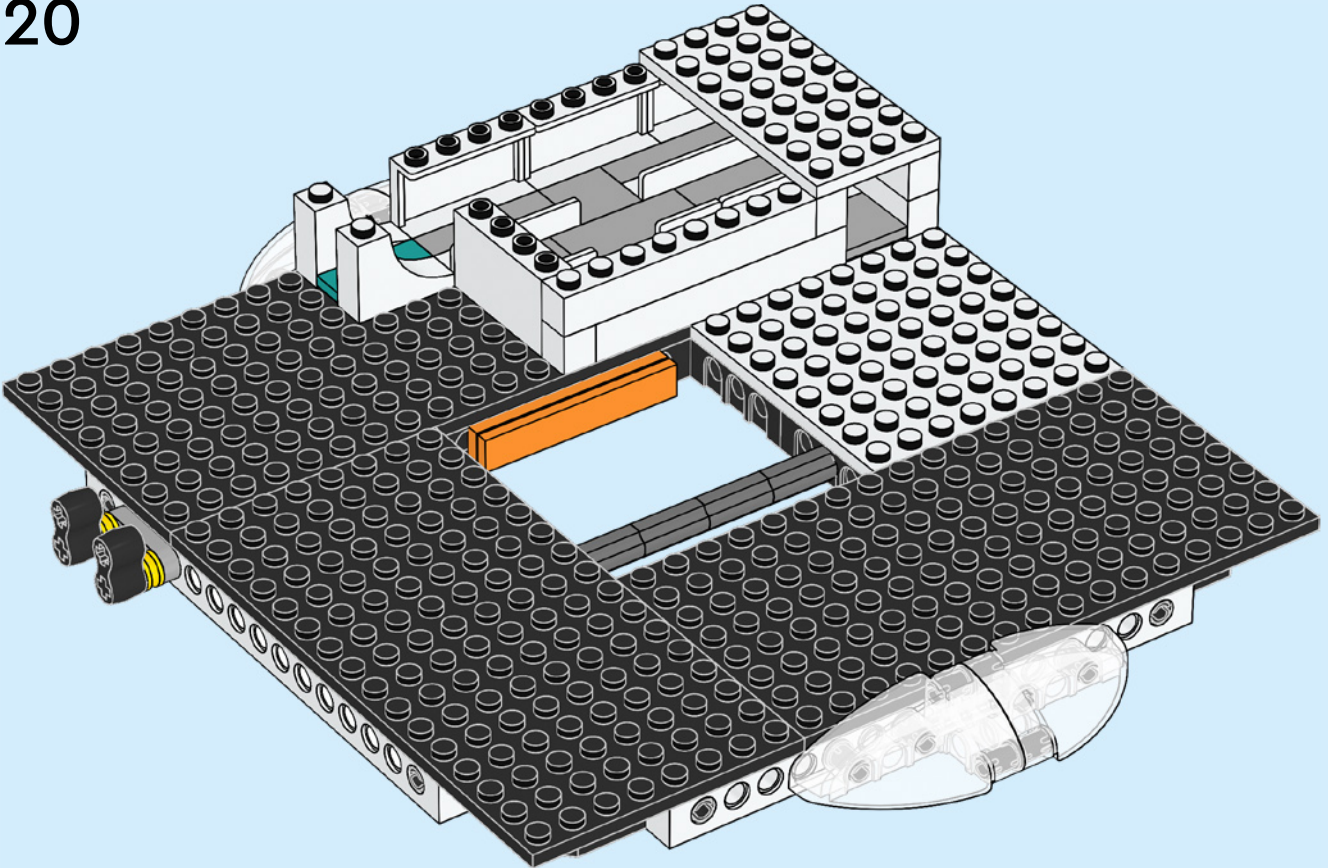

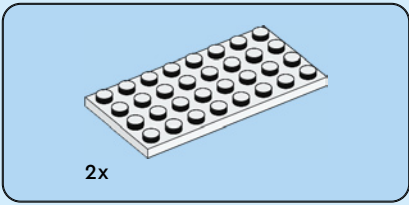

21

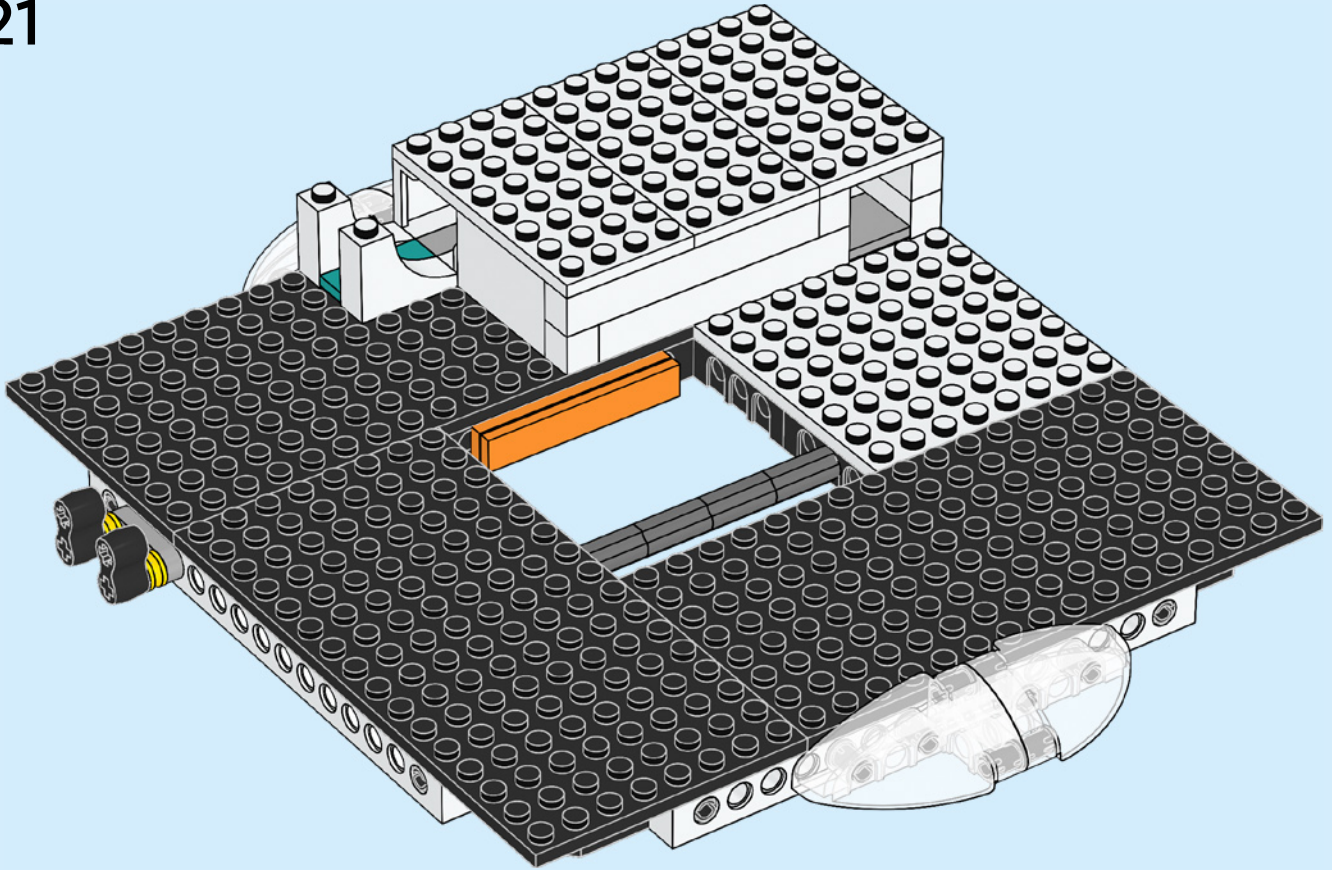

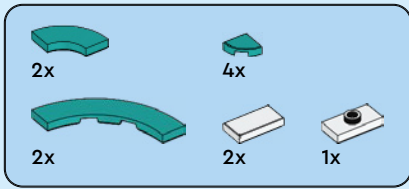

22

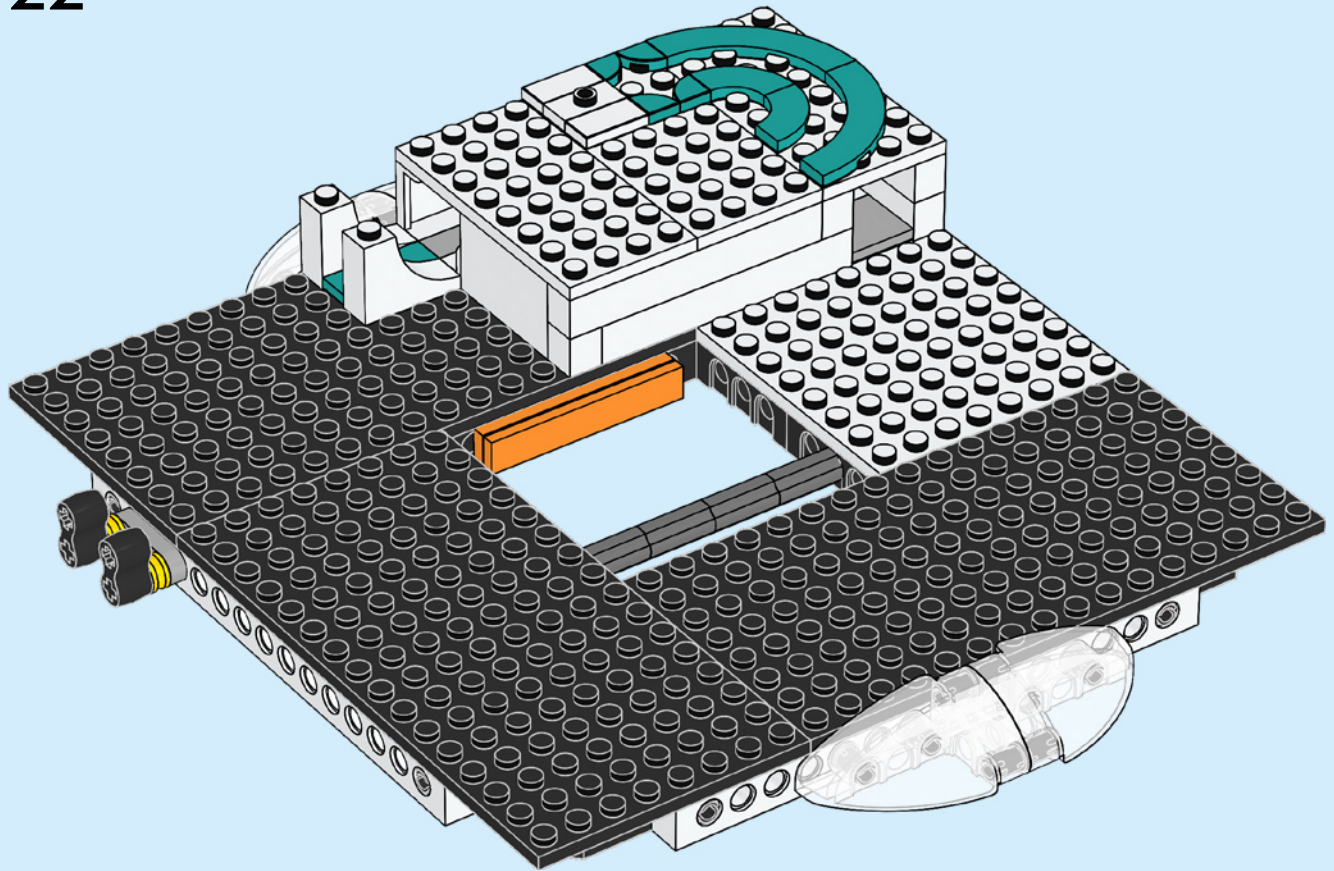

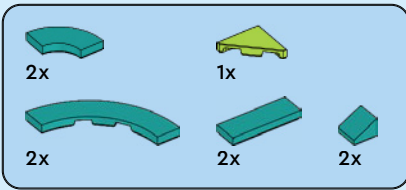

23

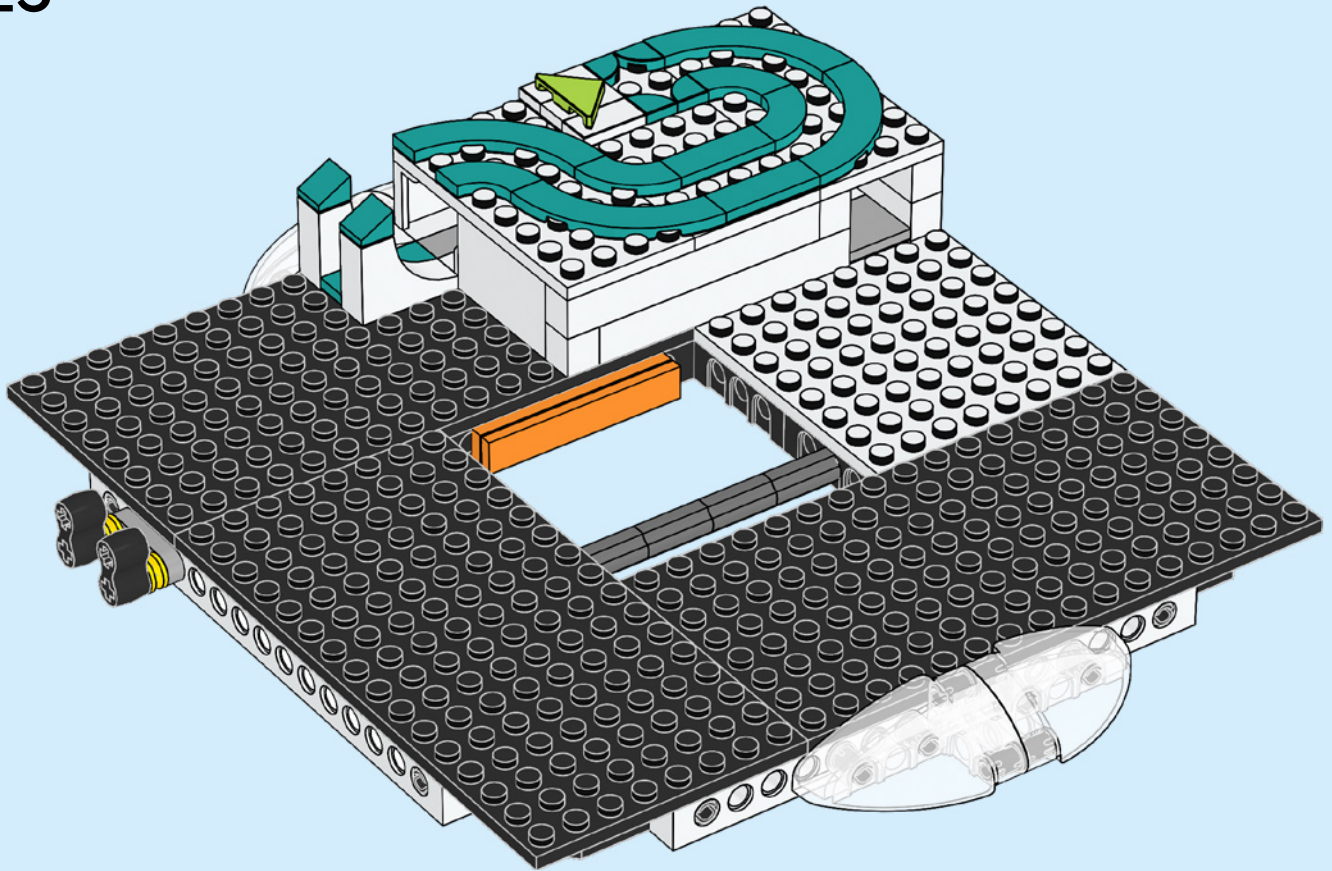

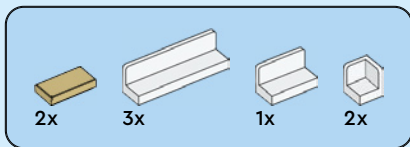

24

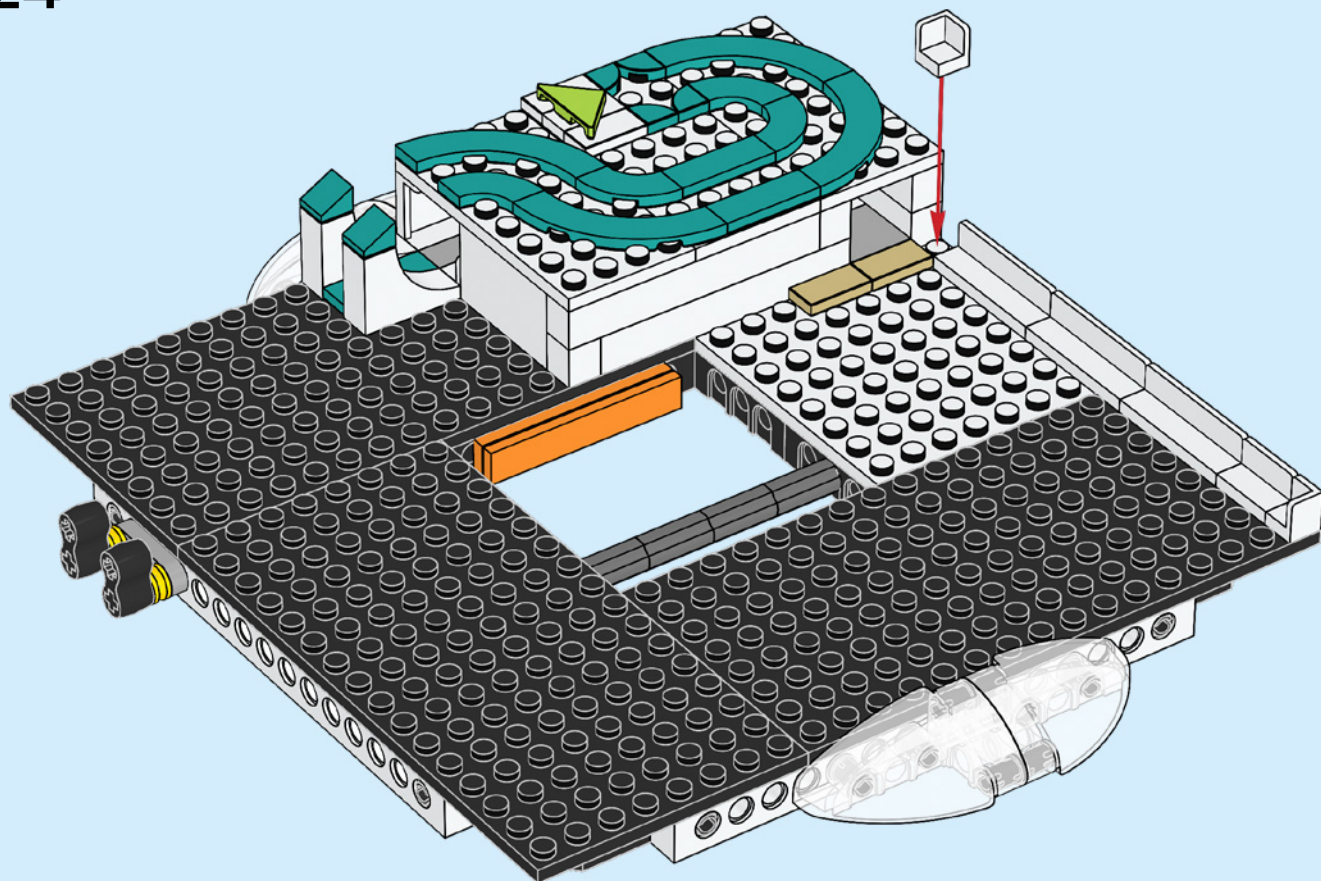

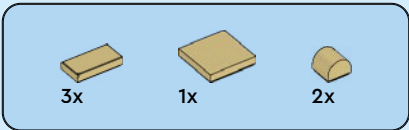

25

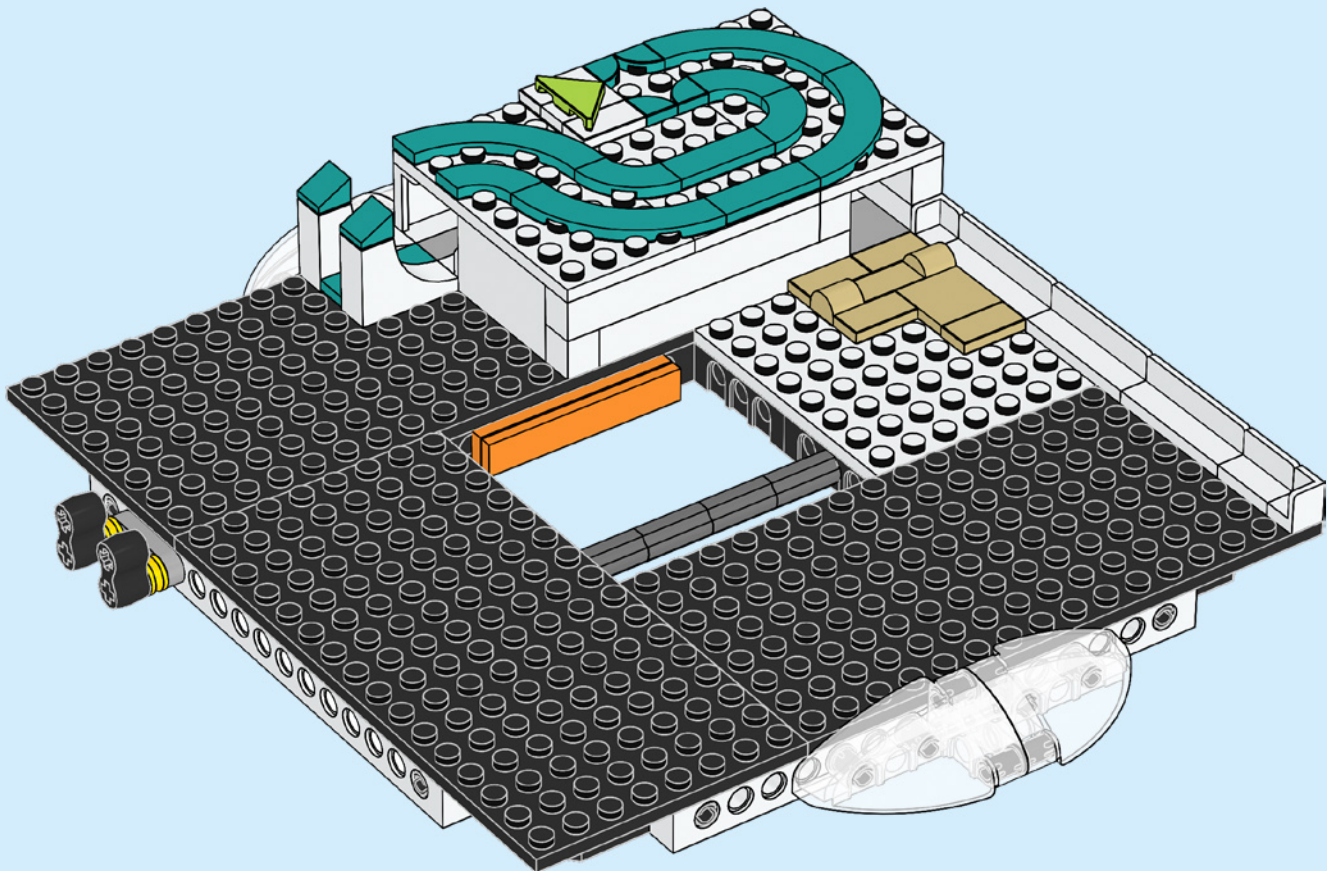

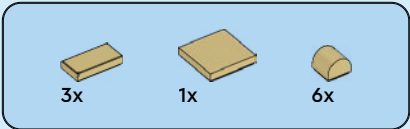

26

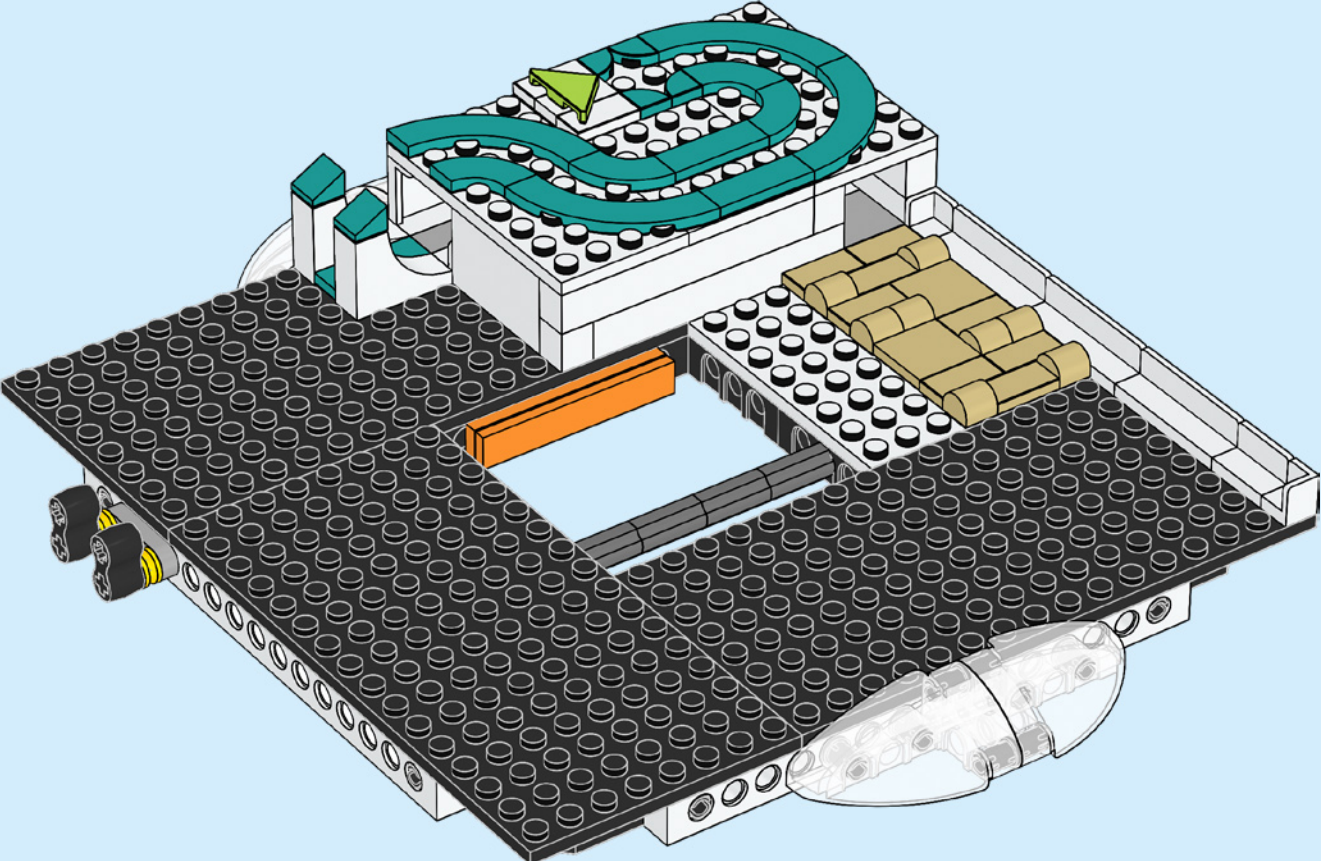

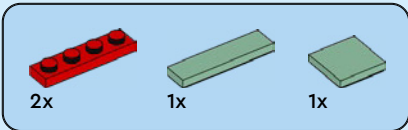

27

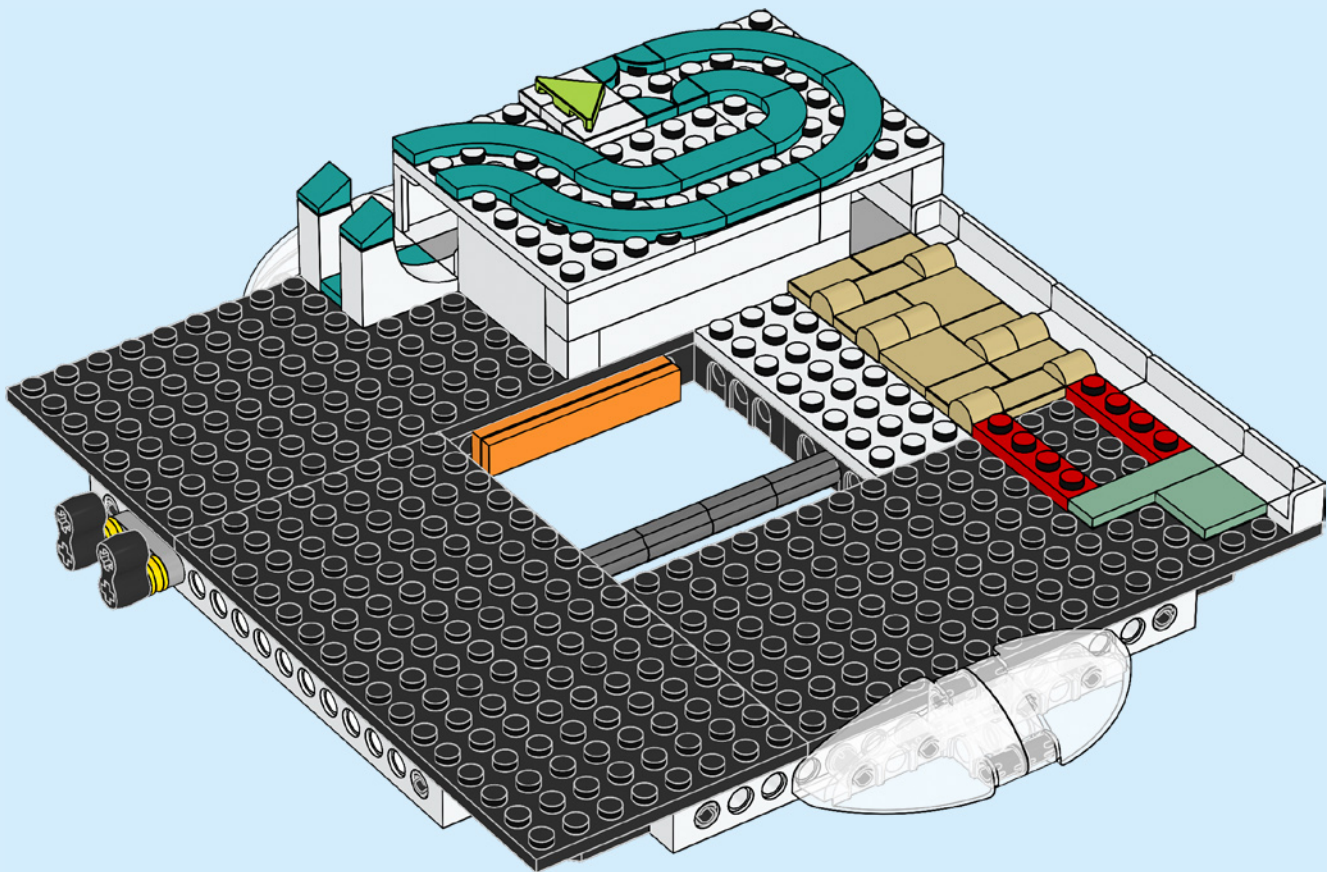

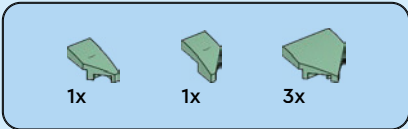

28

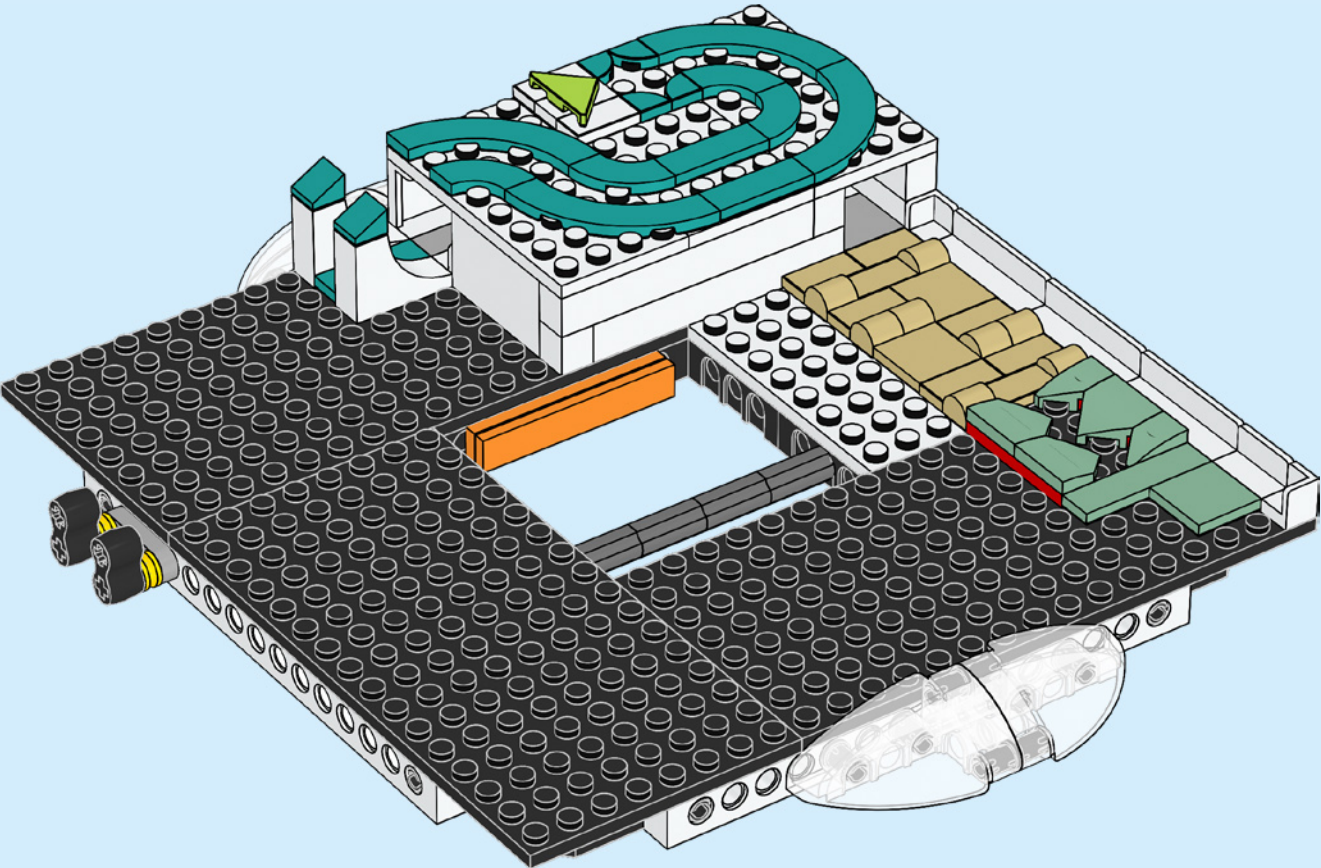

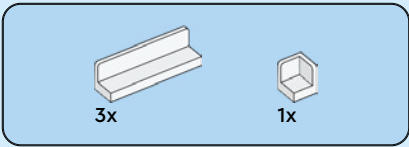

29

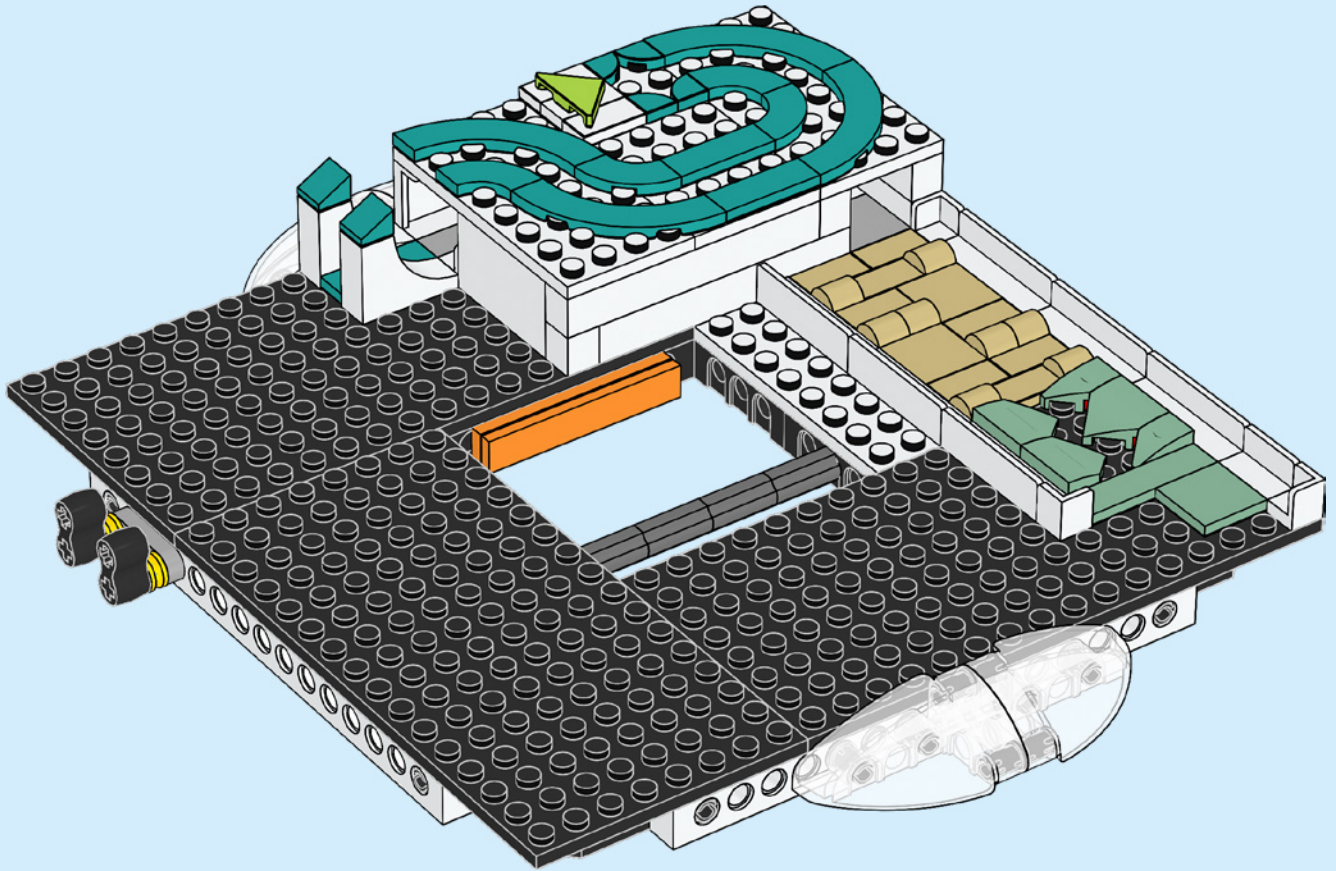

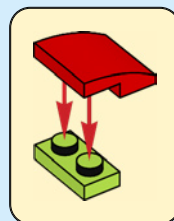
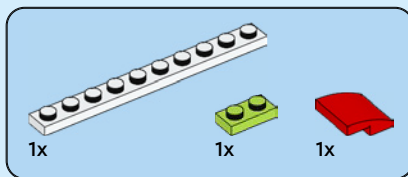

30

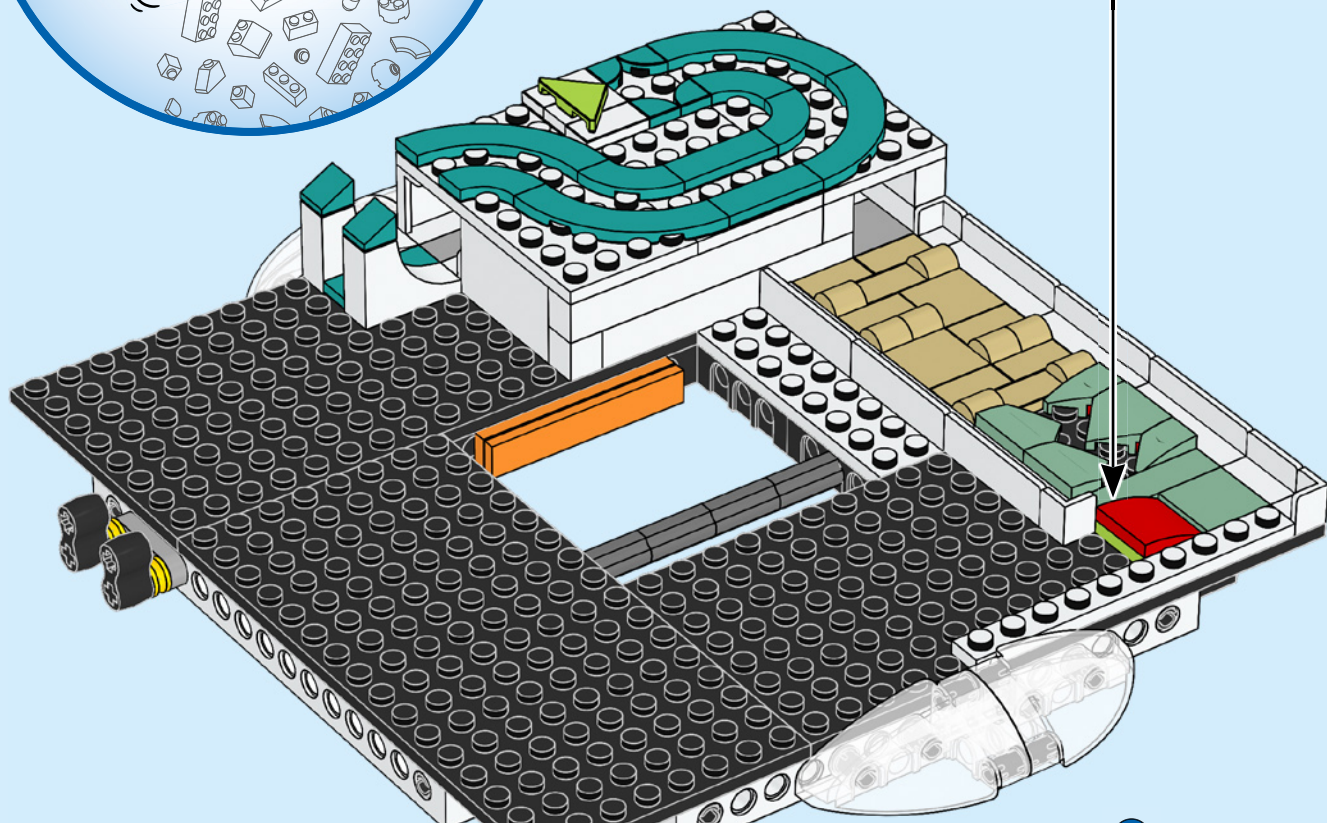

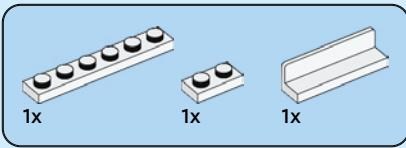

31

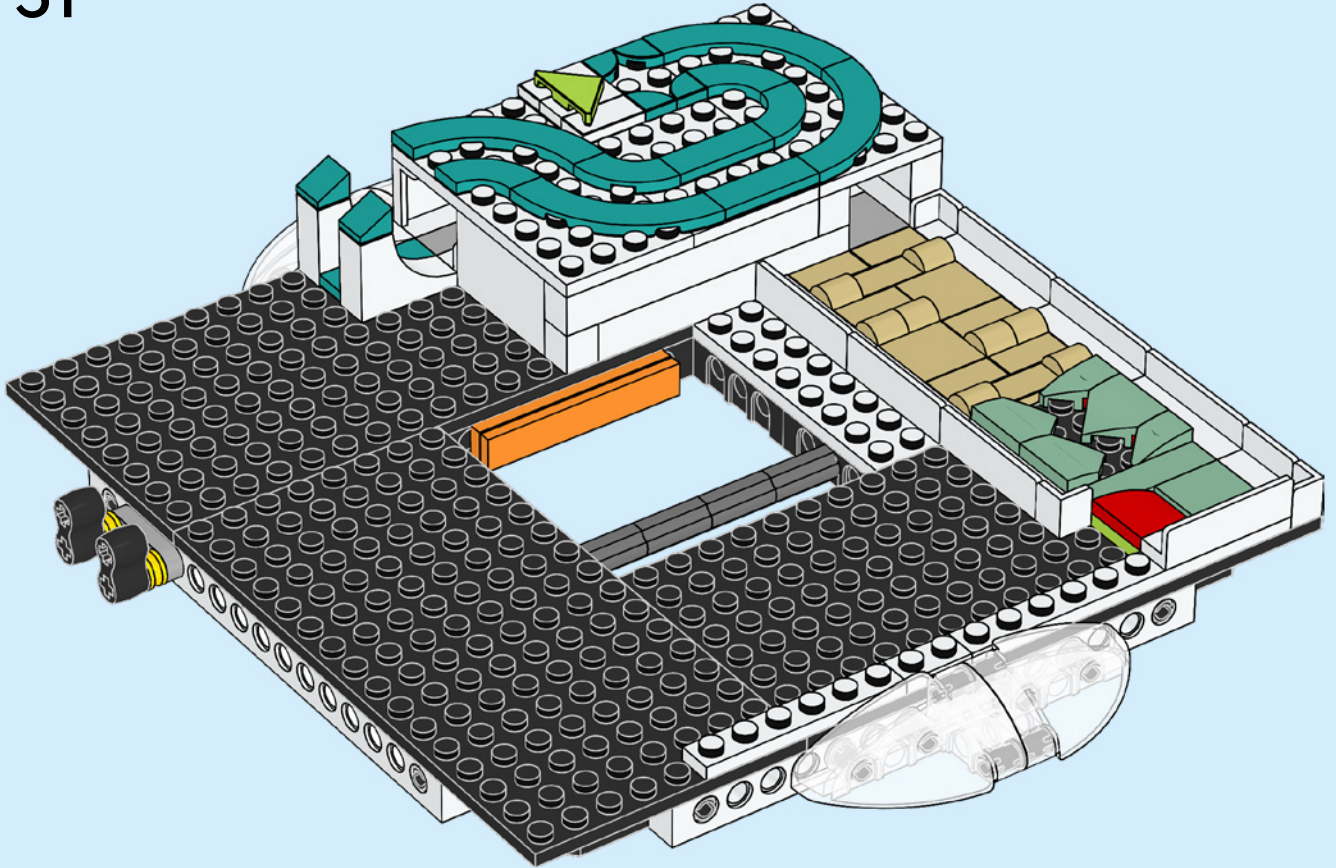

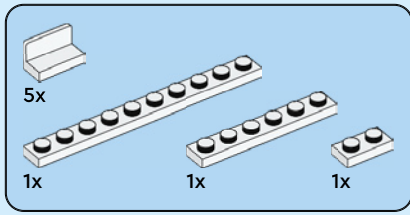

32

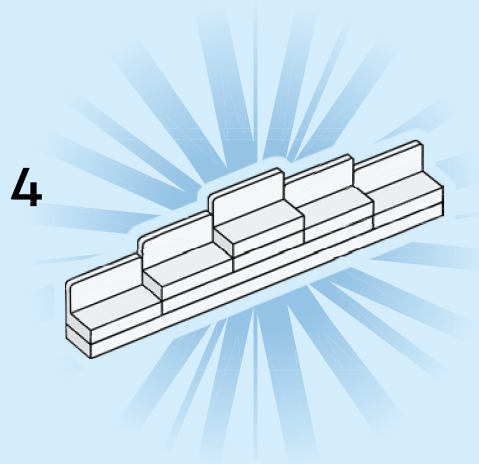
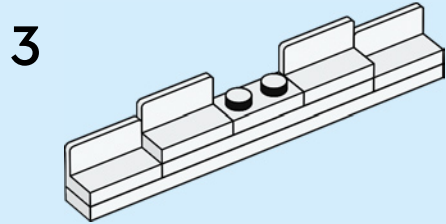
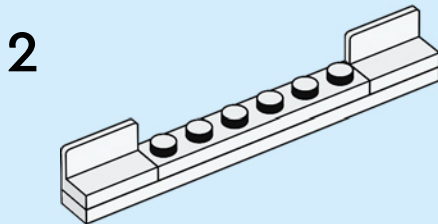
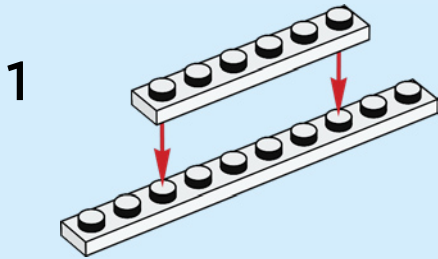

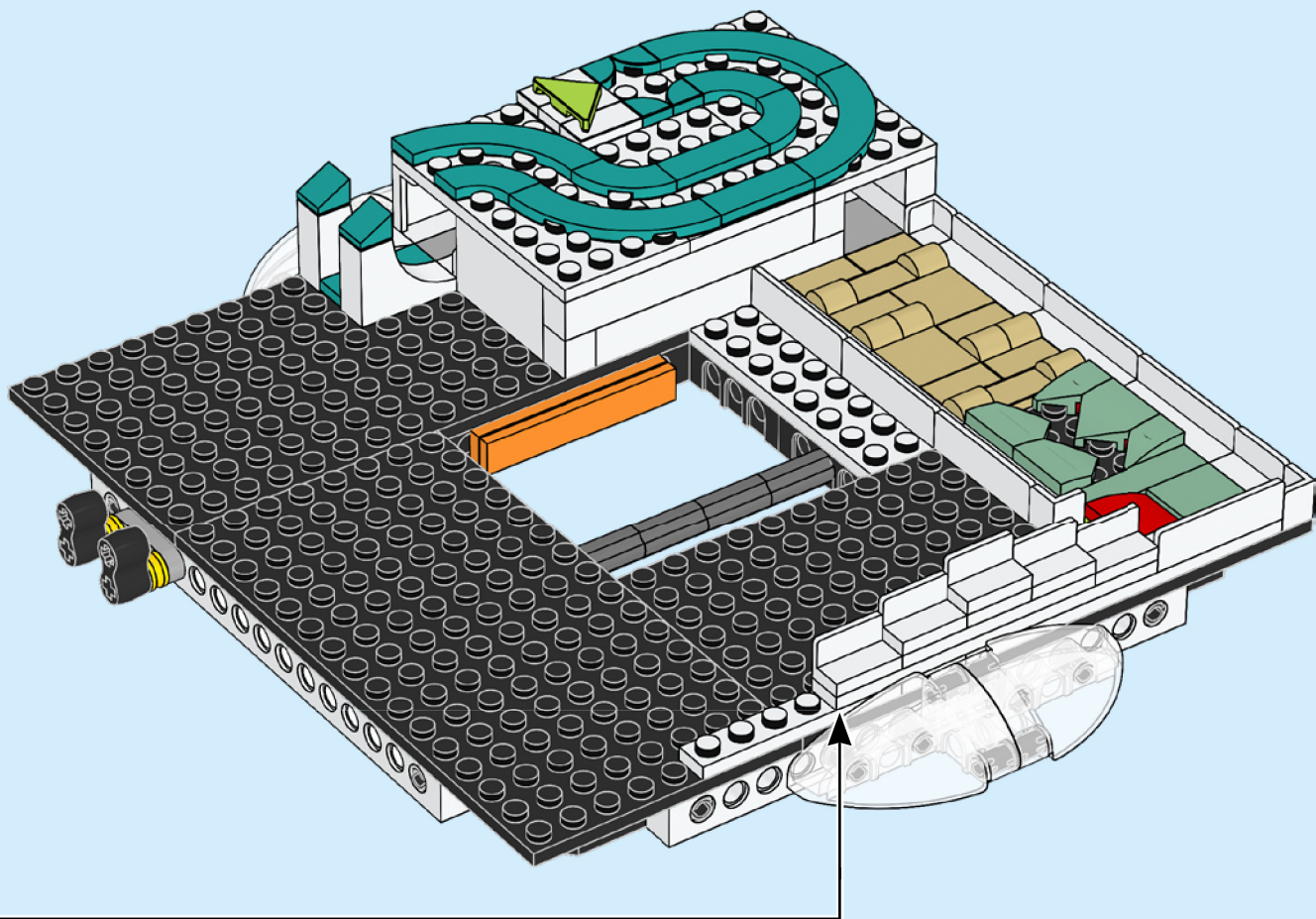

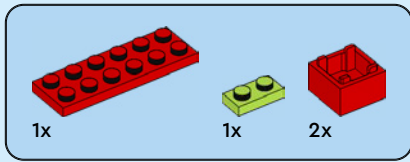

33

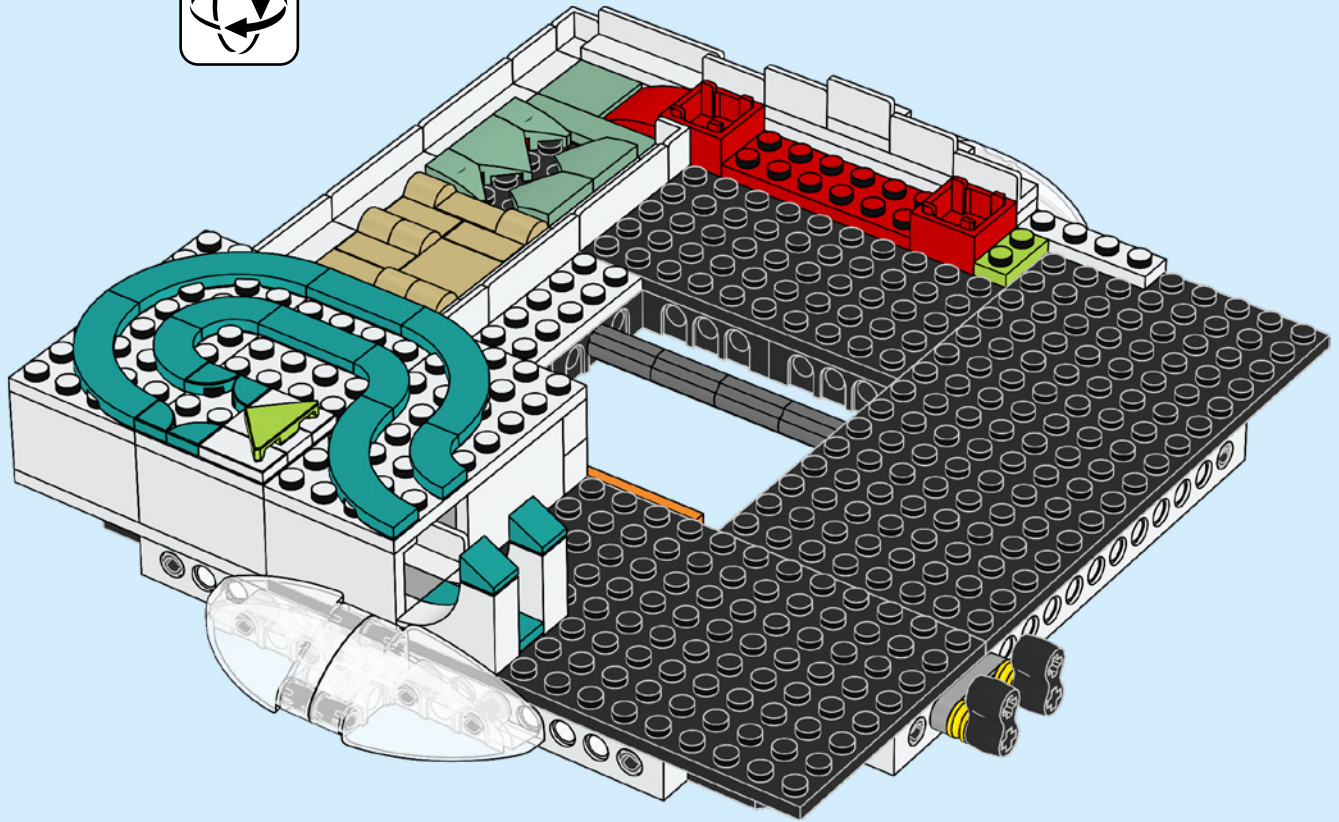

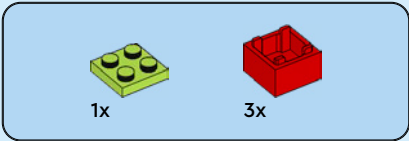

34

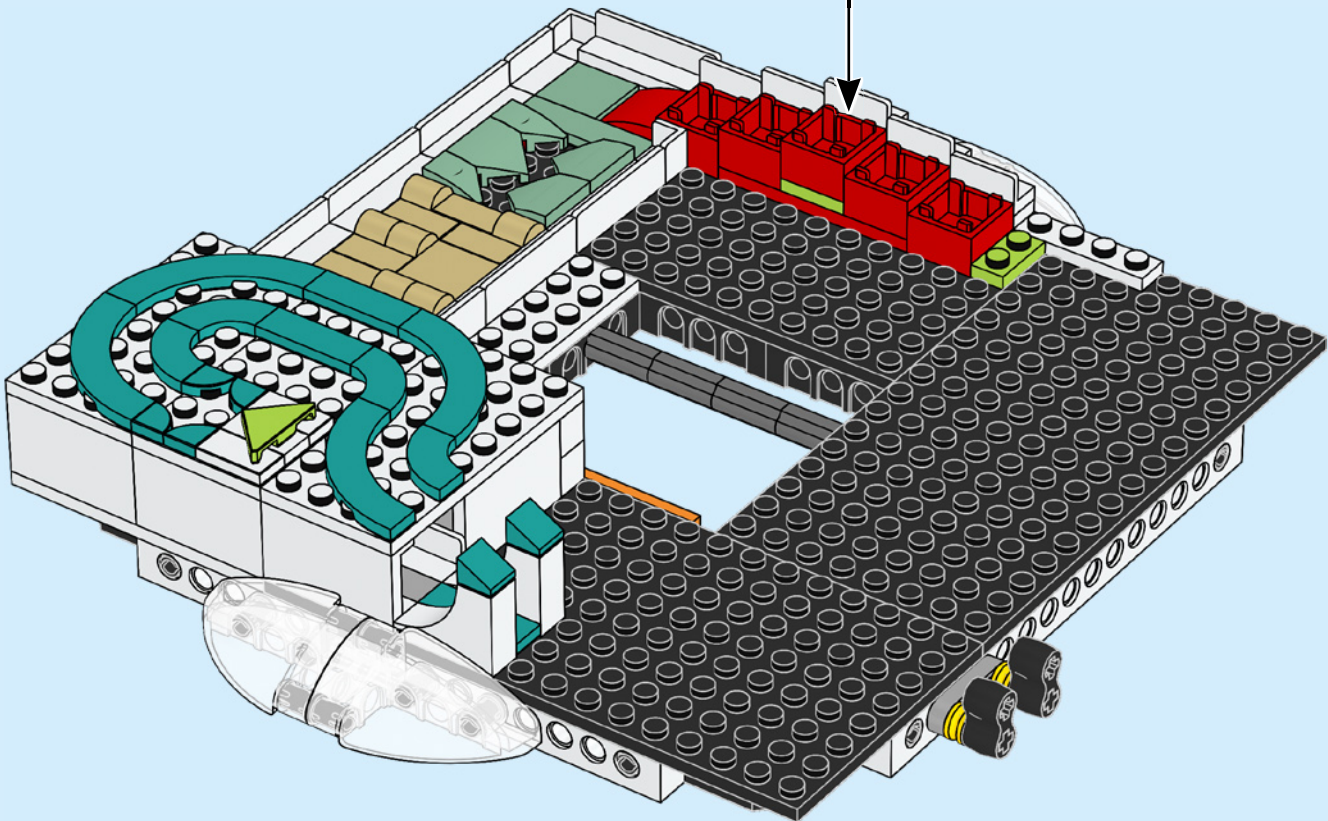
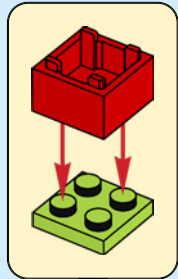

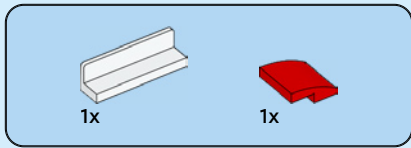

35

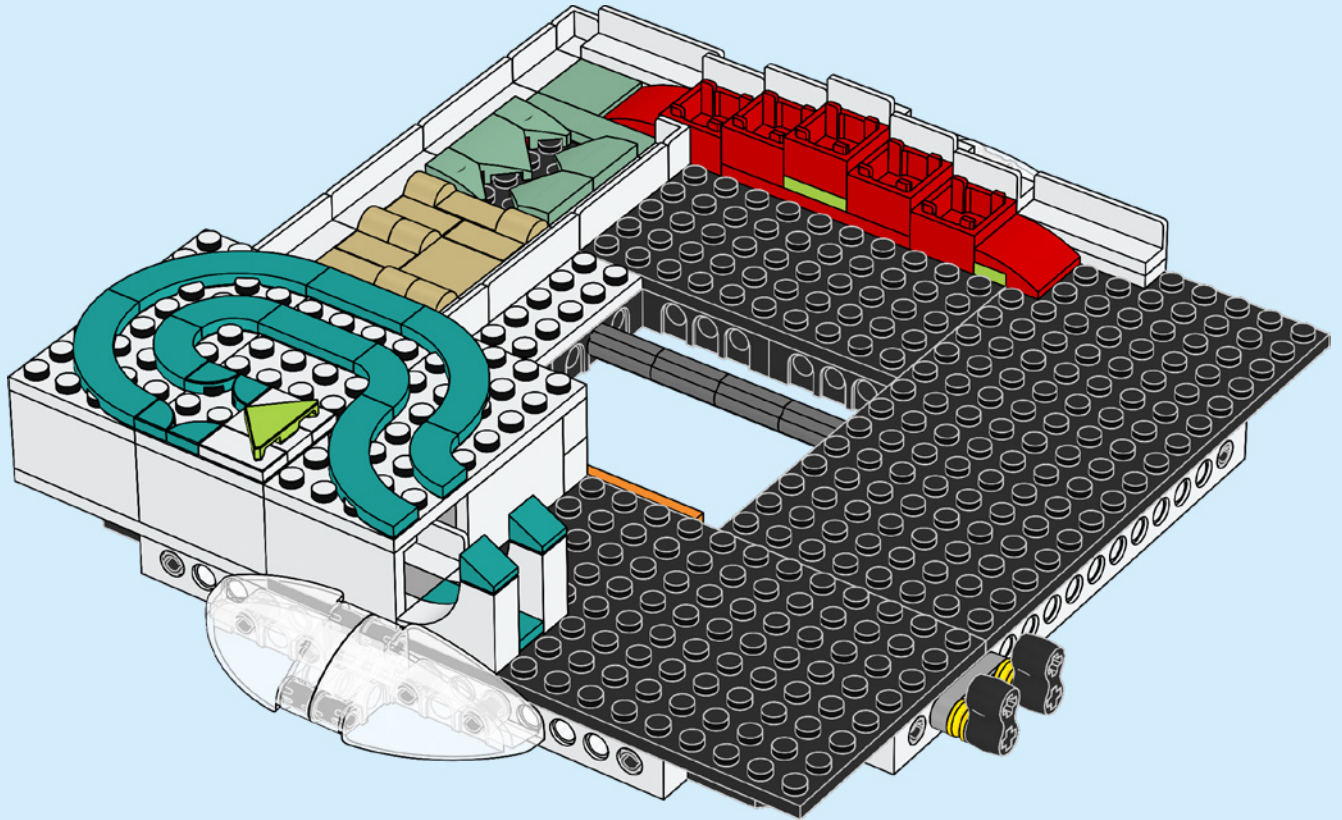

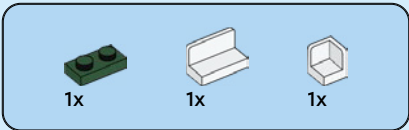

36

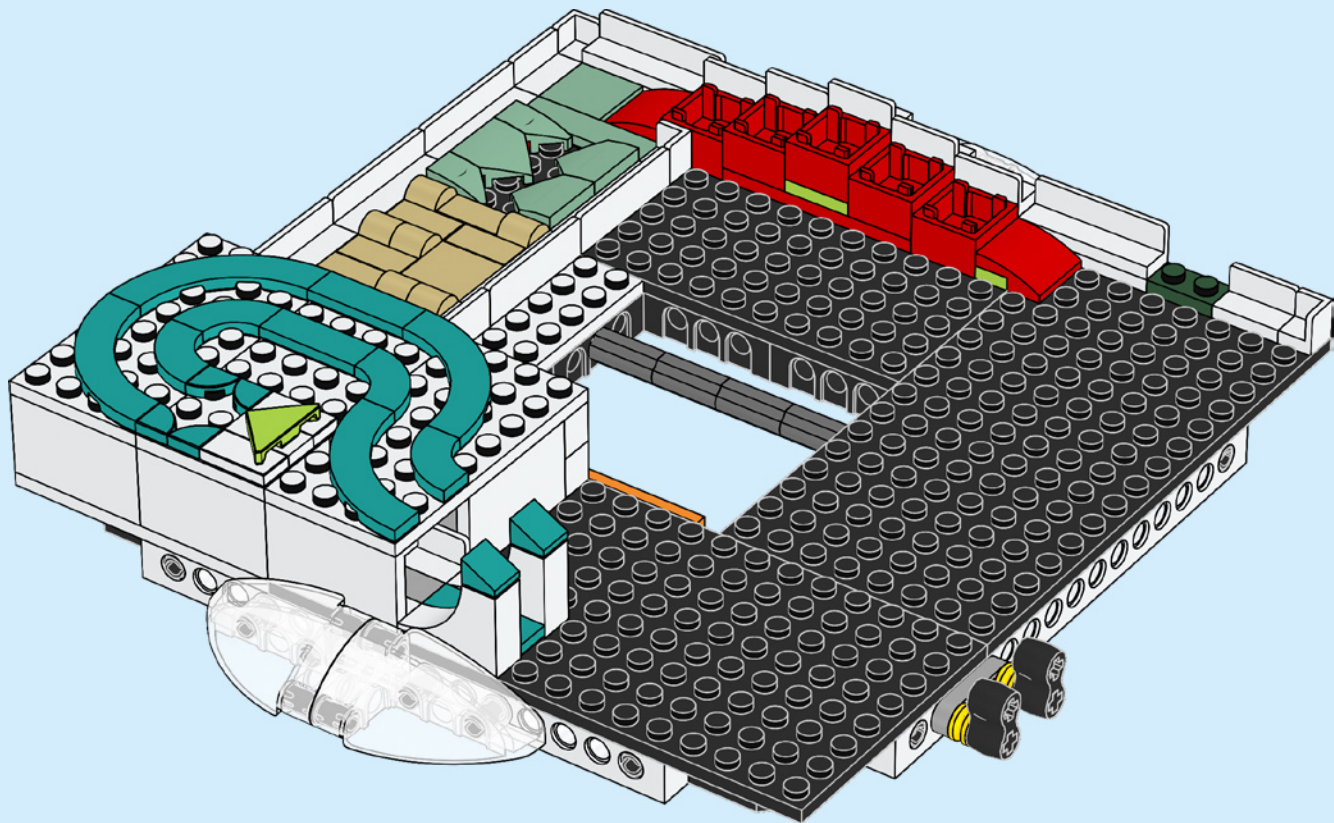

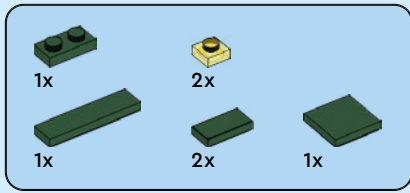

37

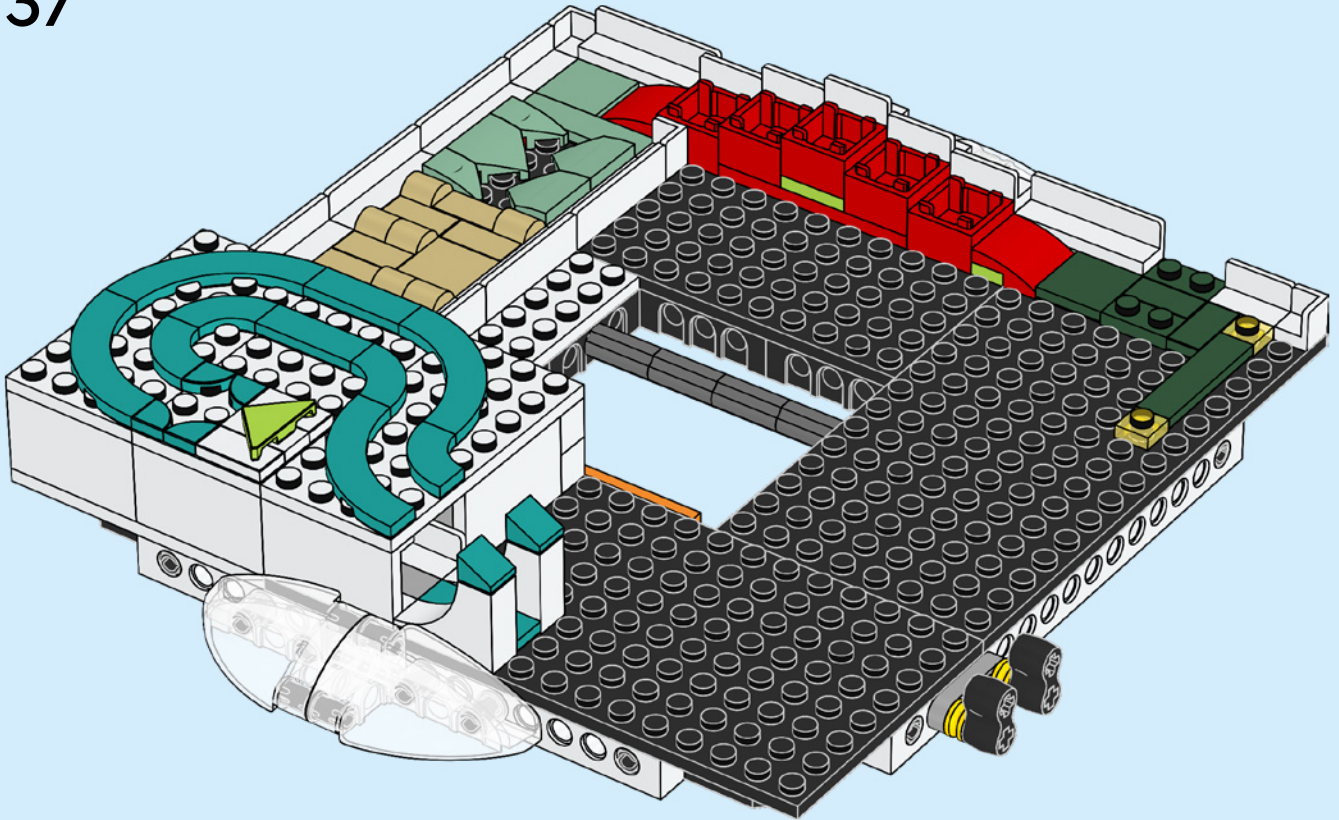

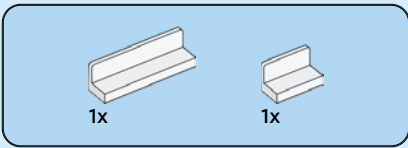

38

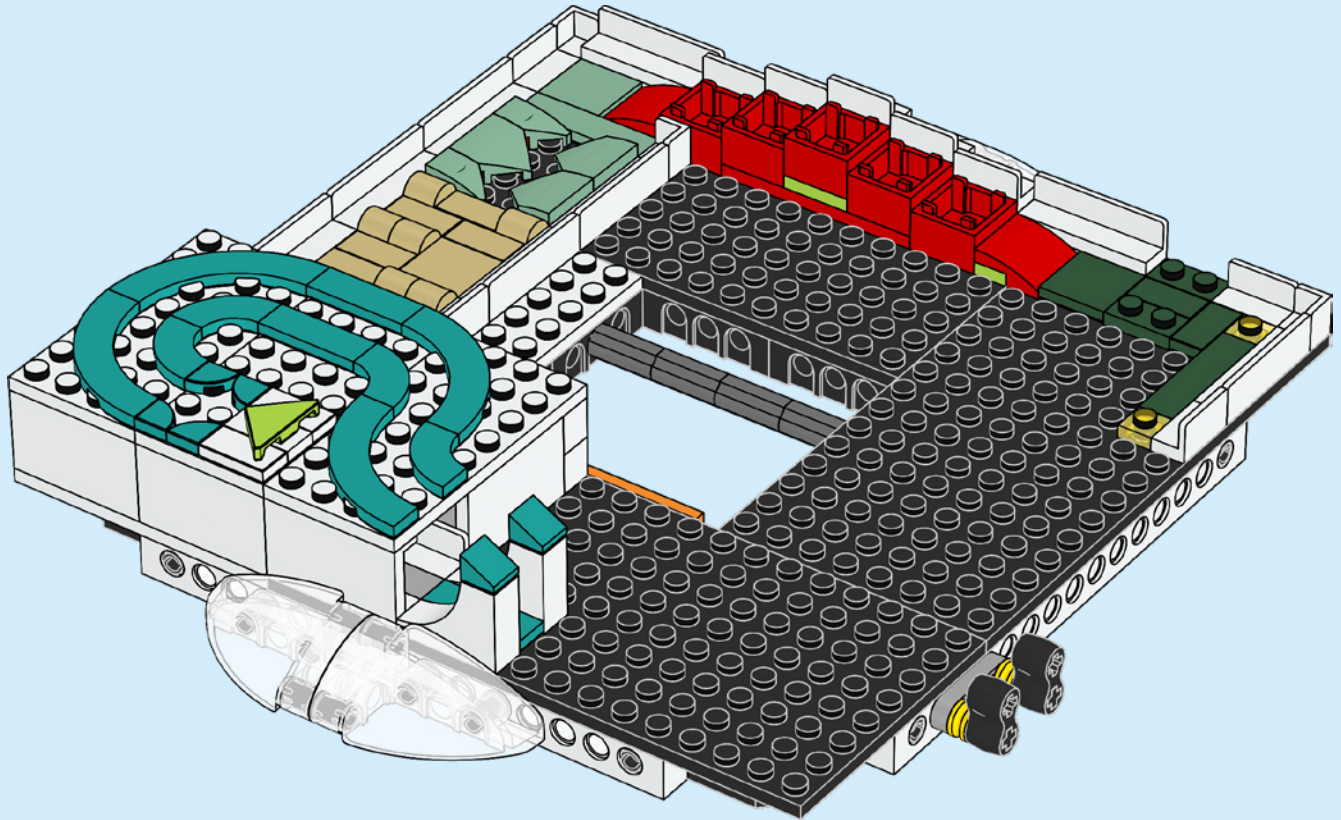

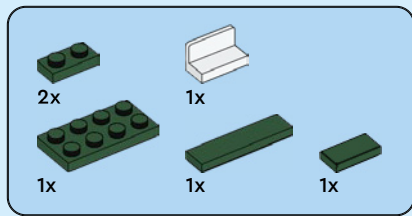

39

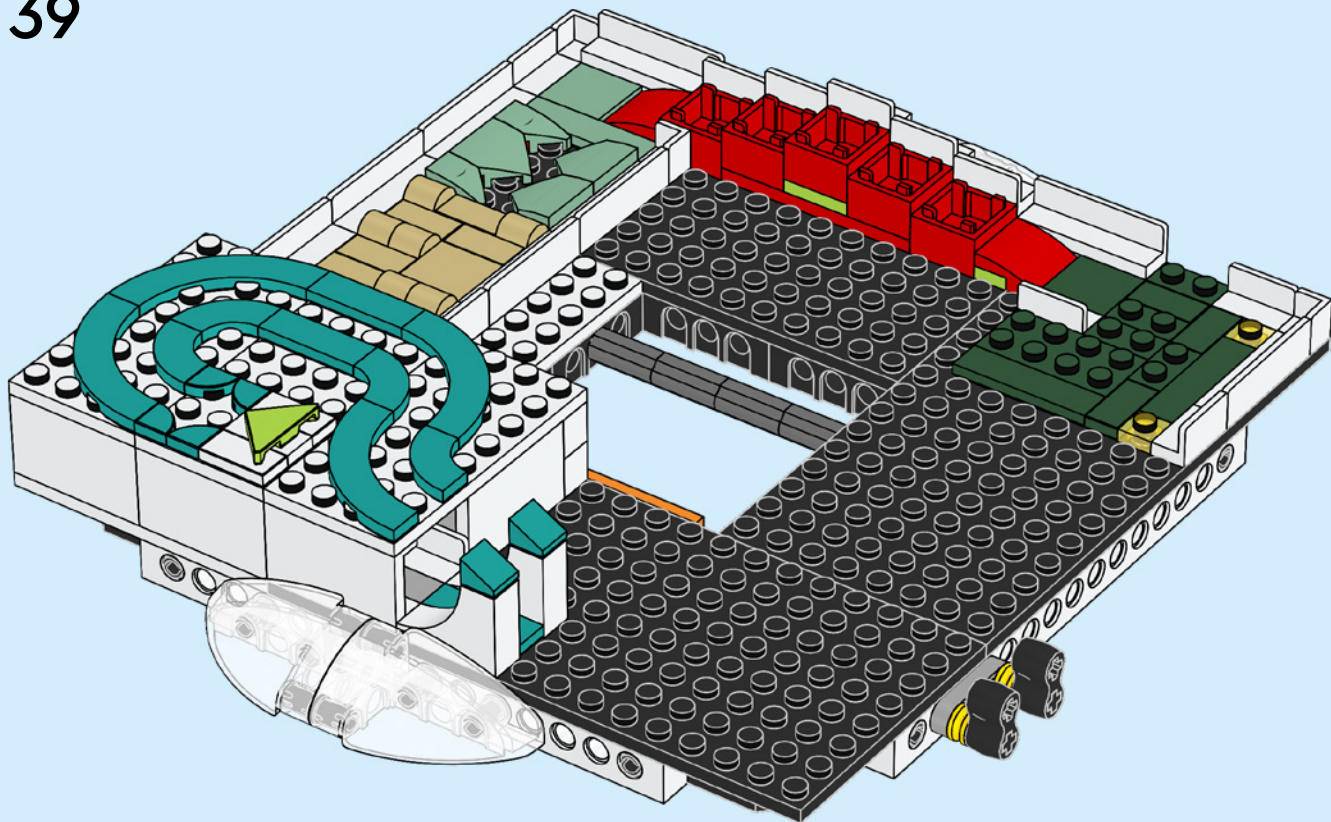



2x



6x

40

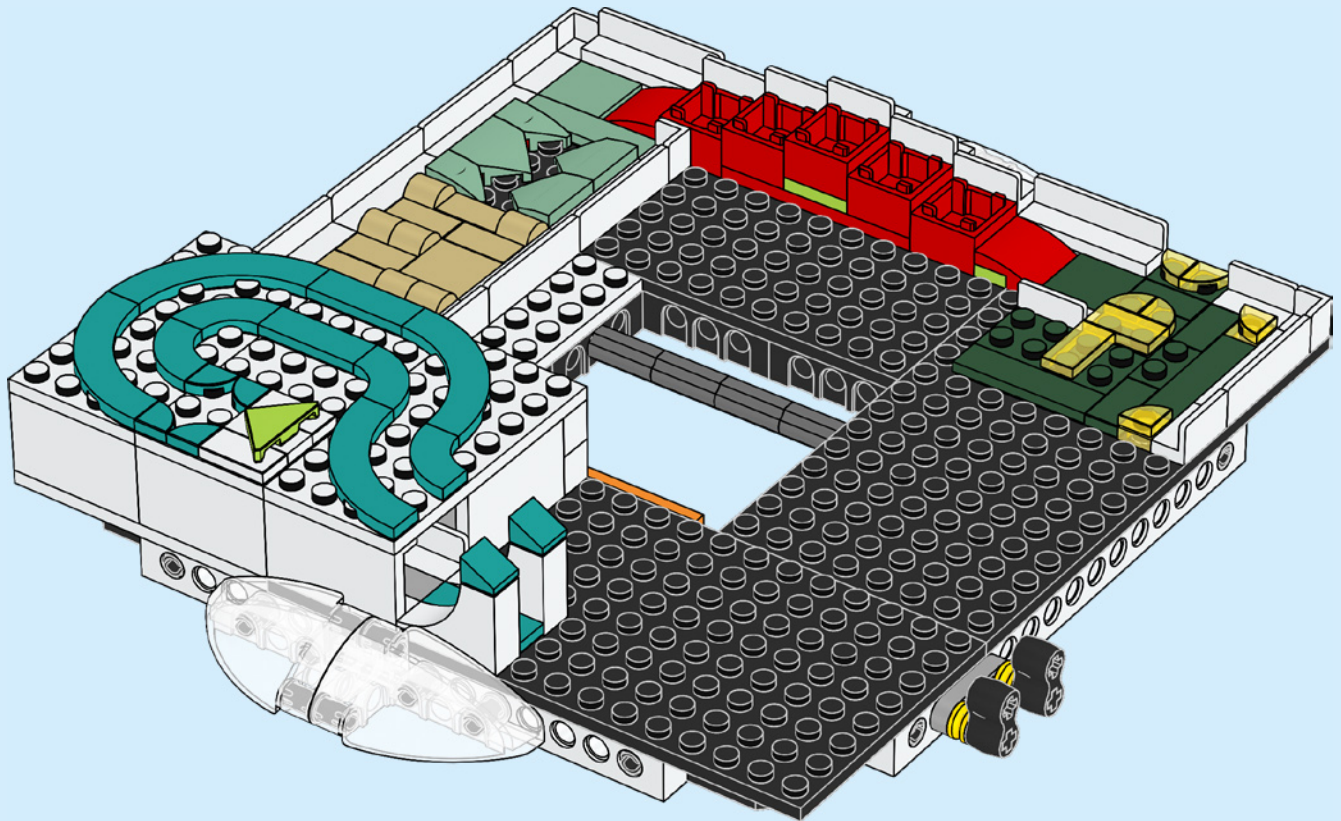



2x



5x

41

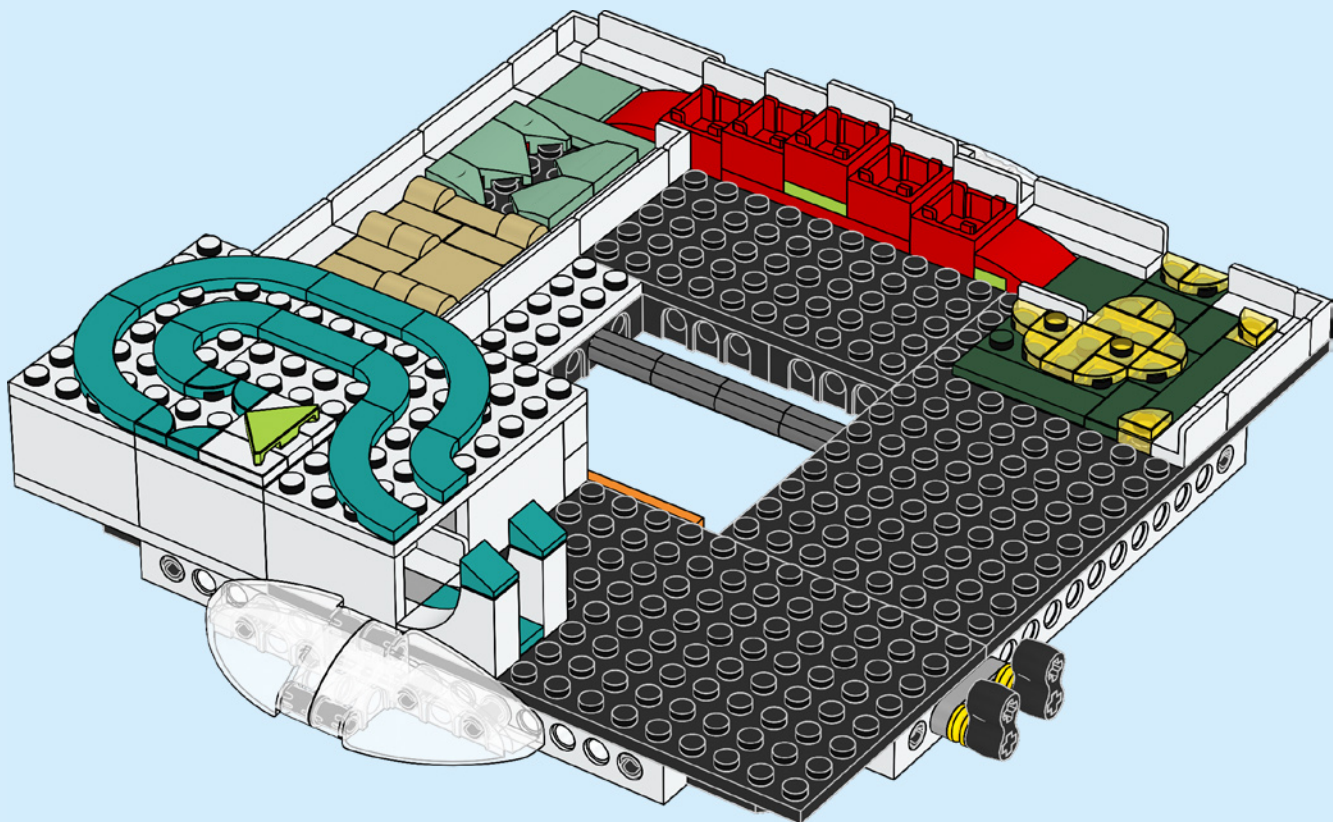

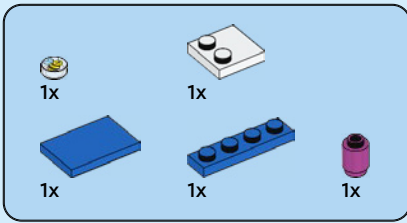

42

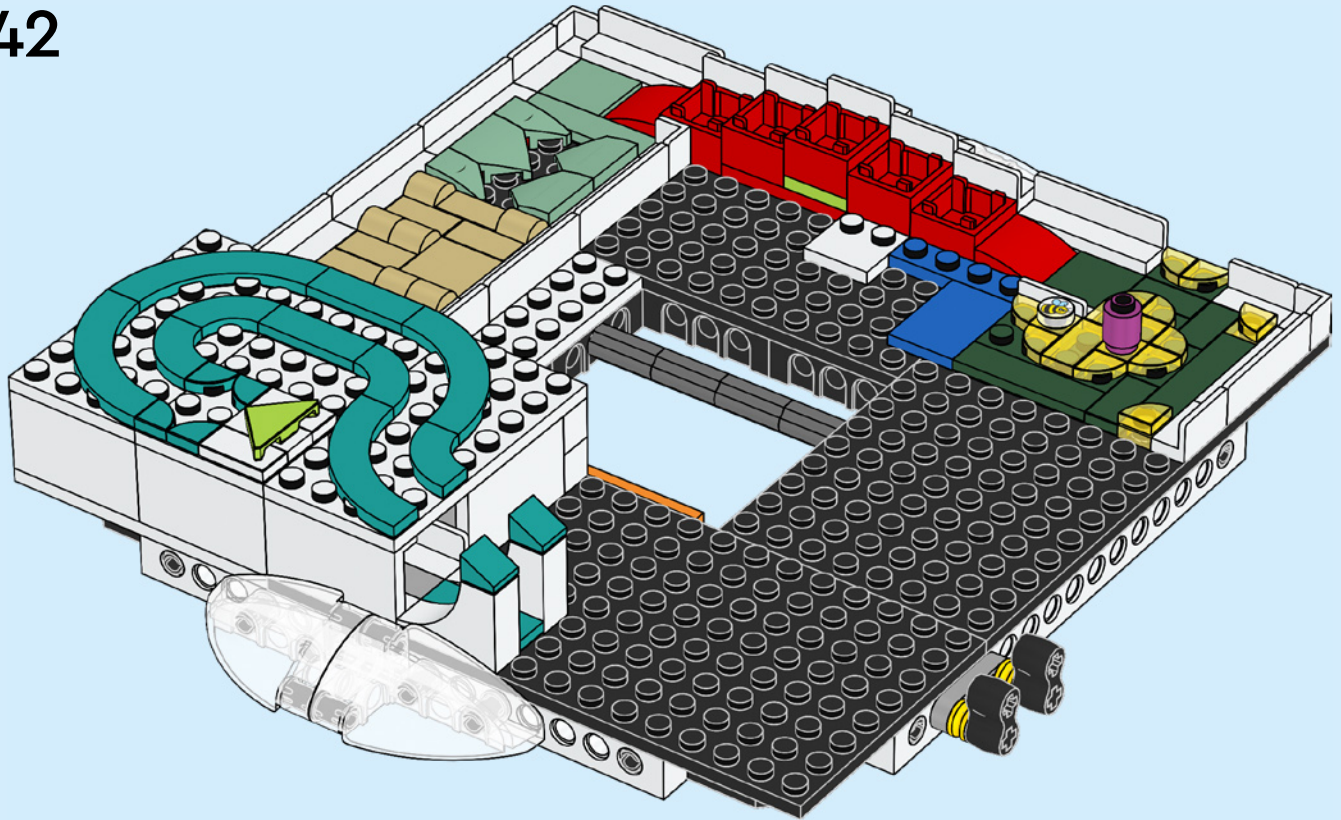

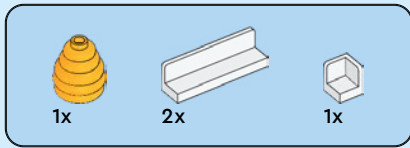

43

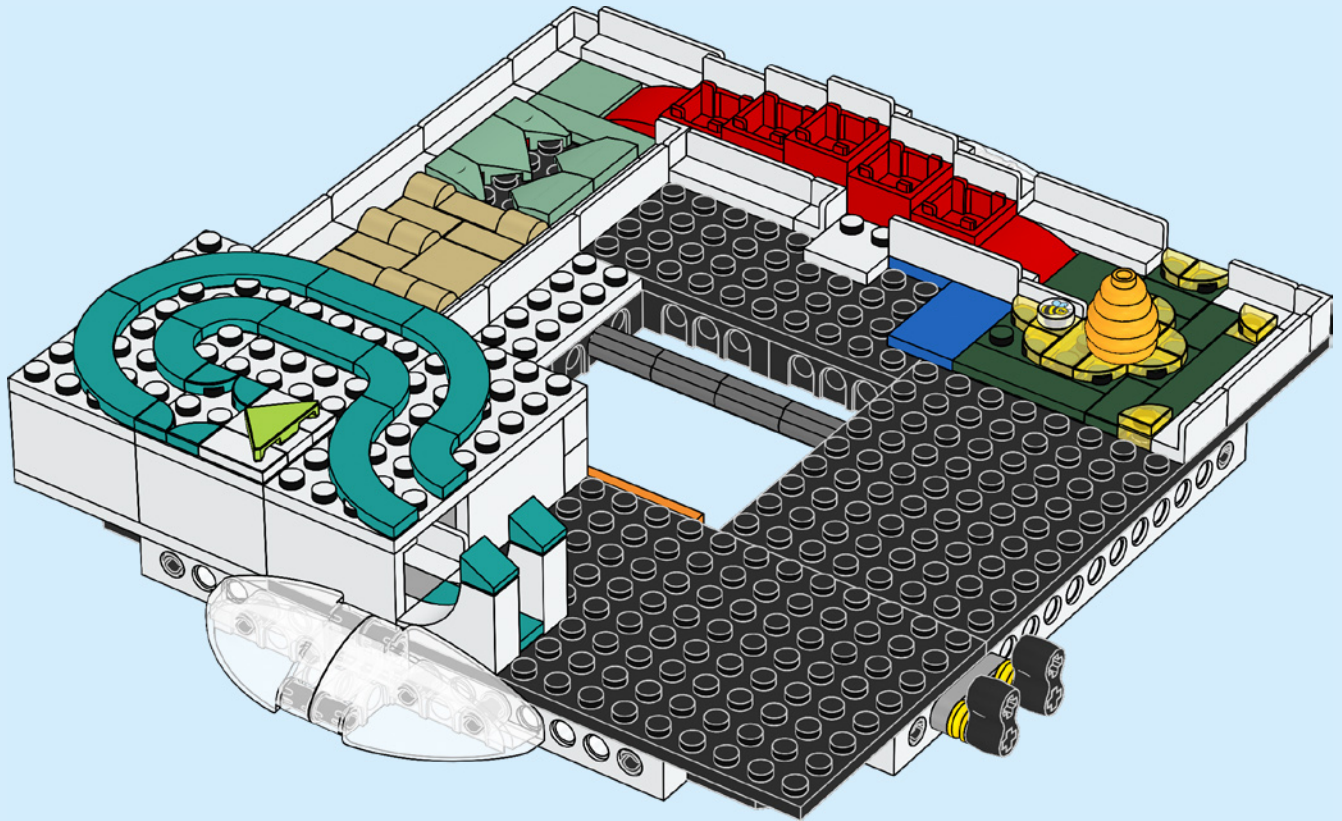

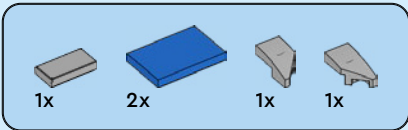

44

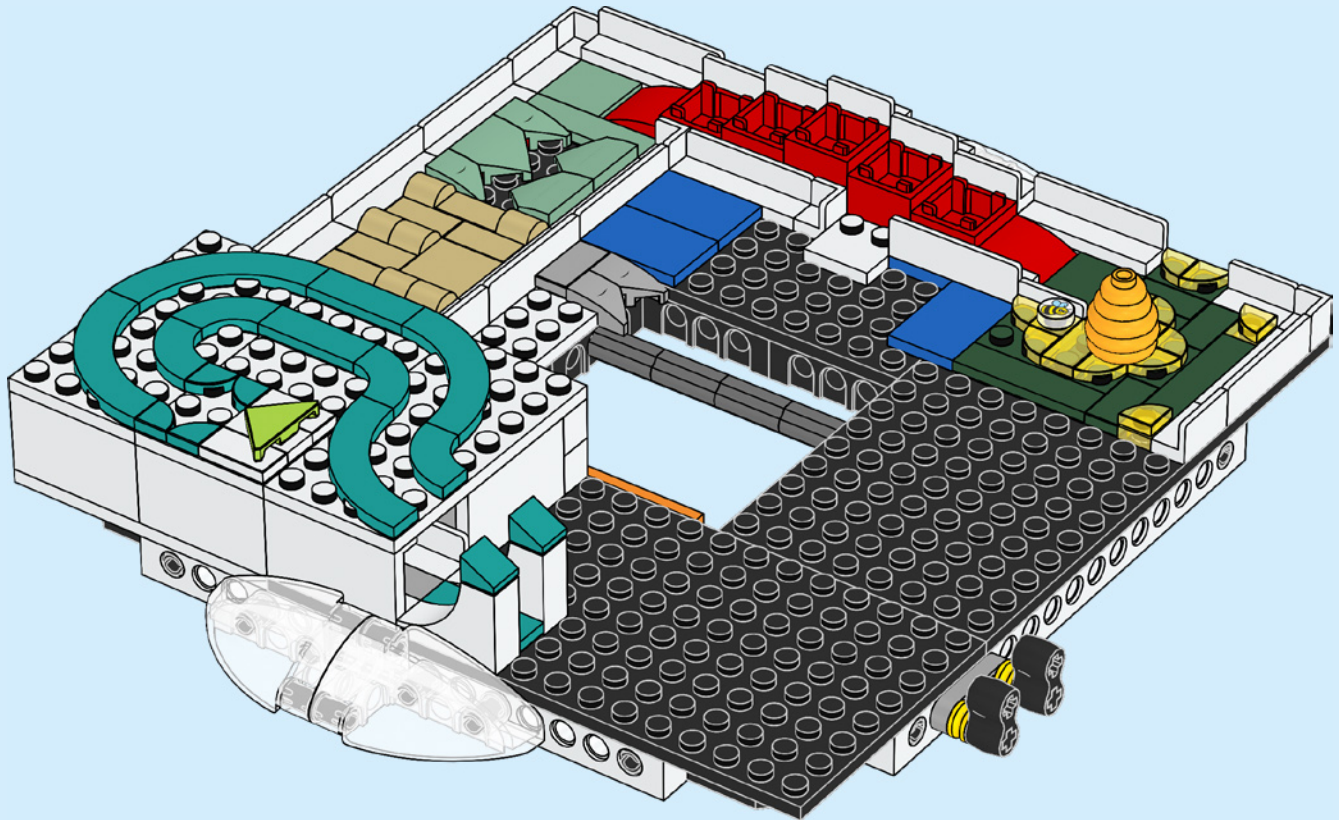

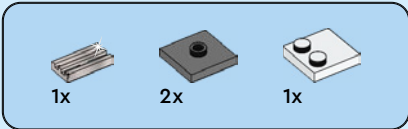

45

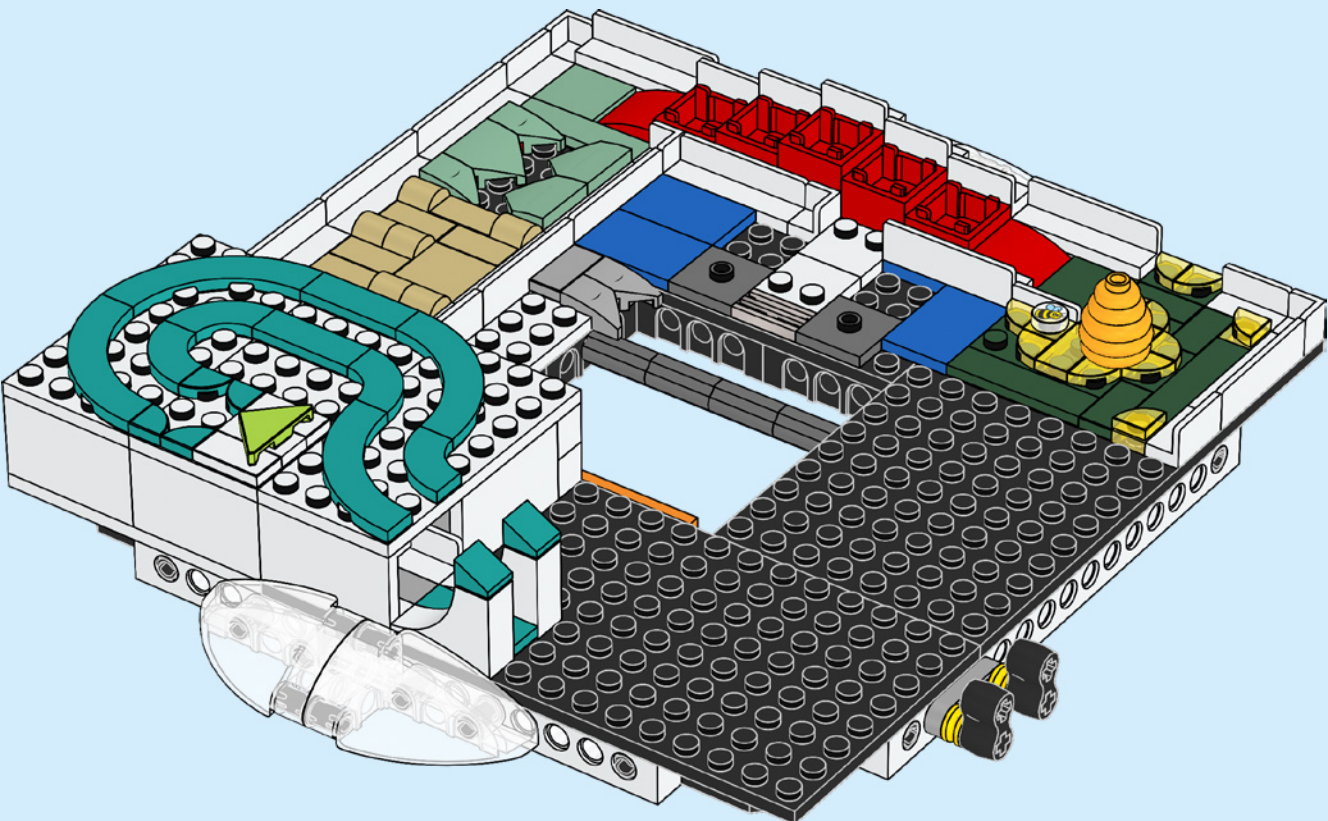

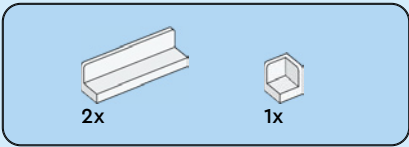

46

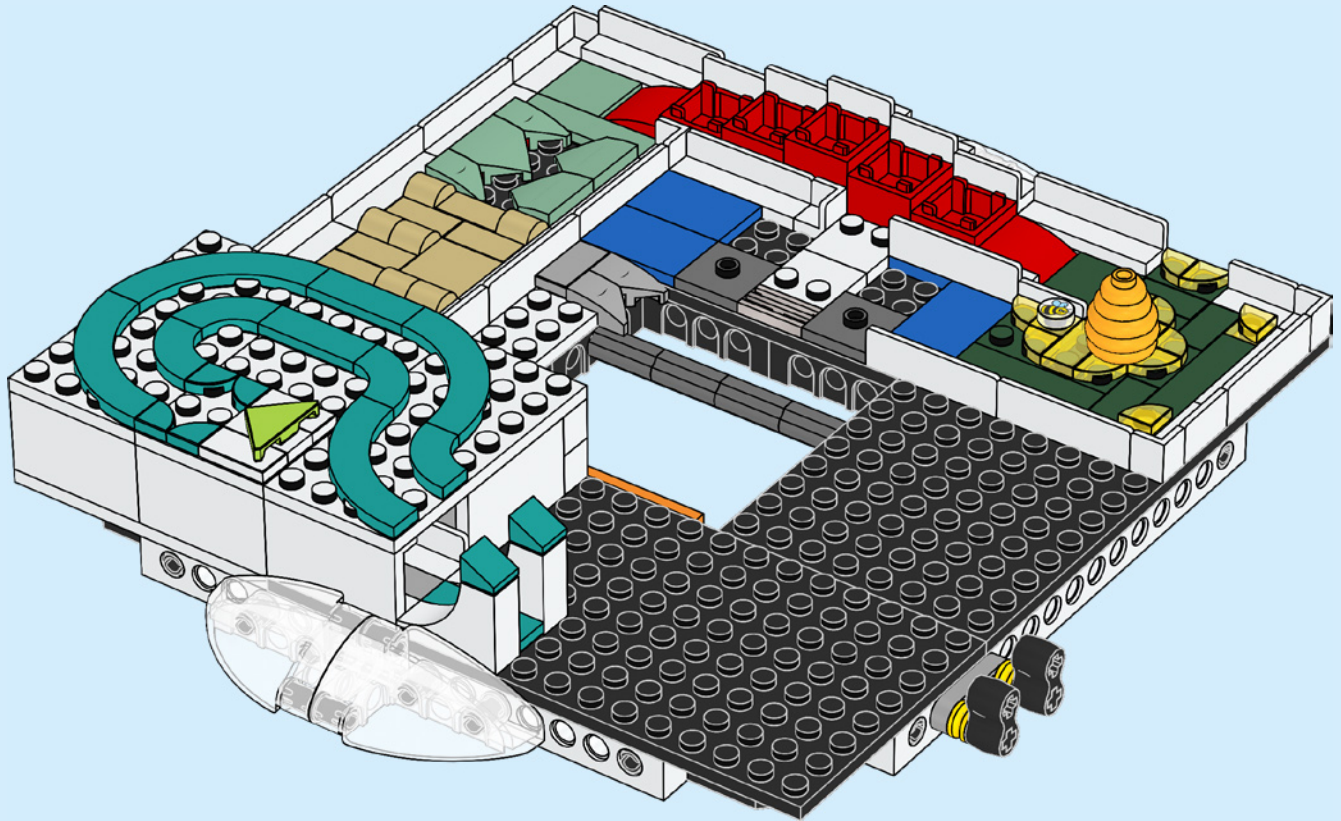

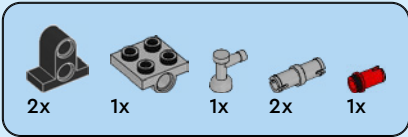

47

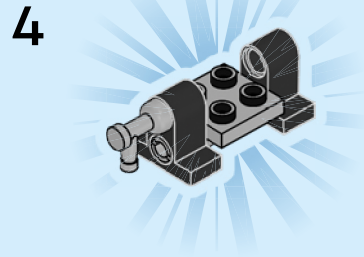
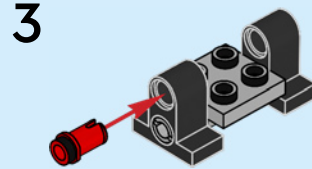
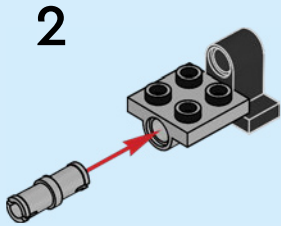
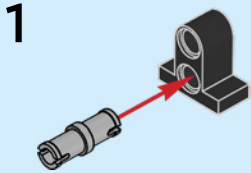

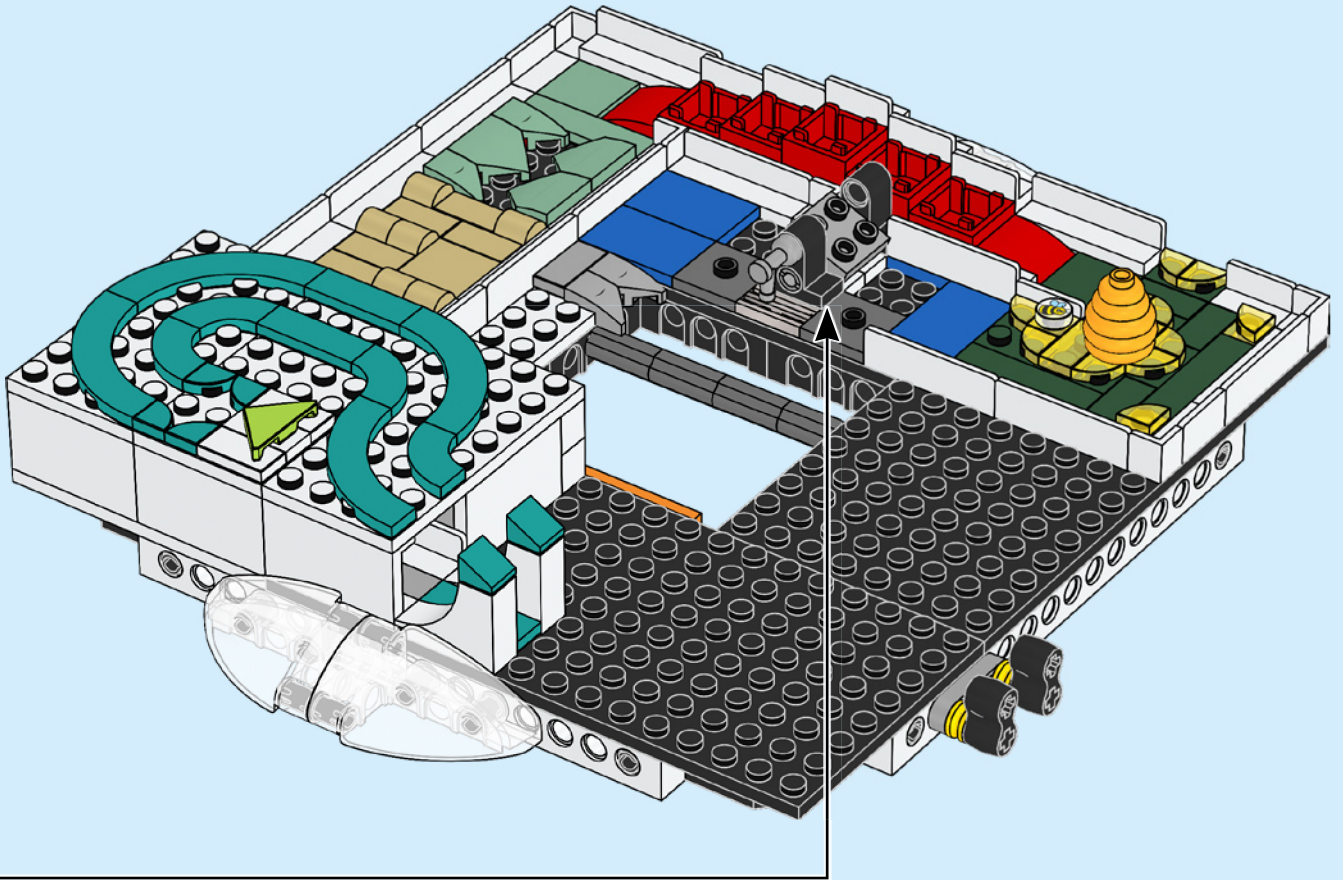

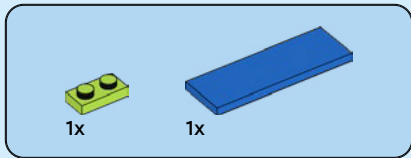

48

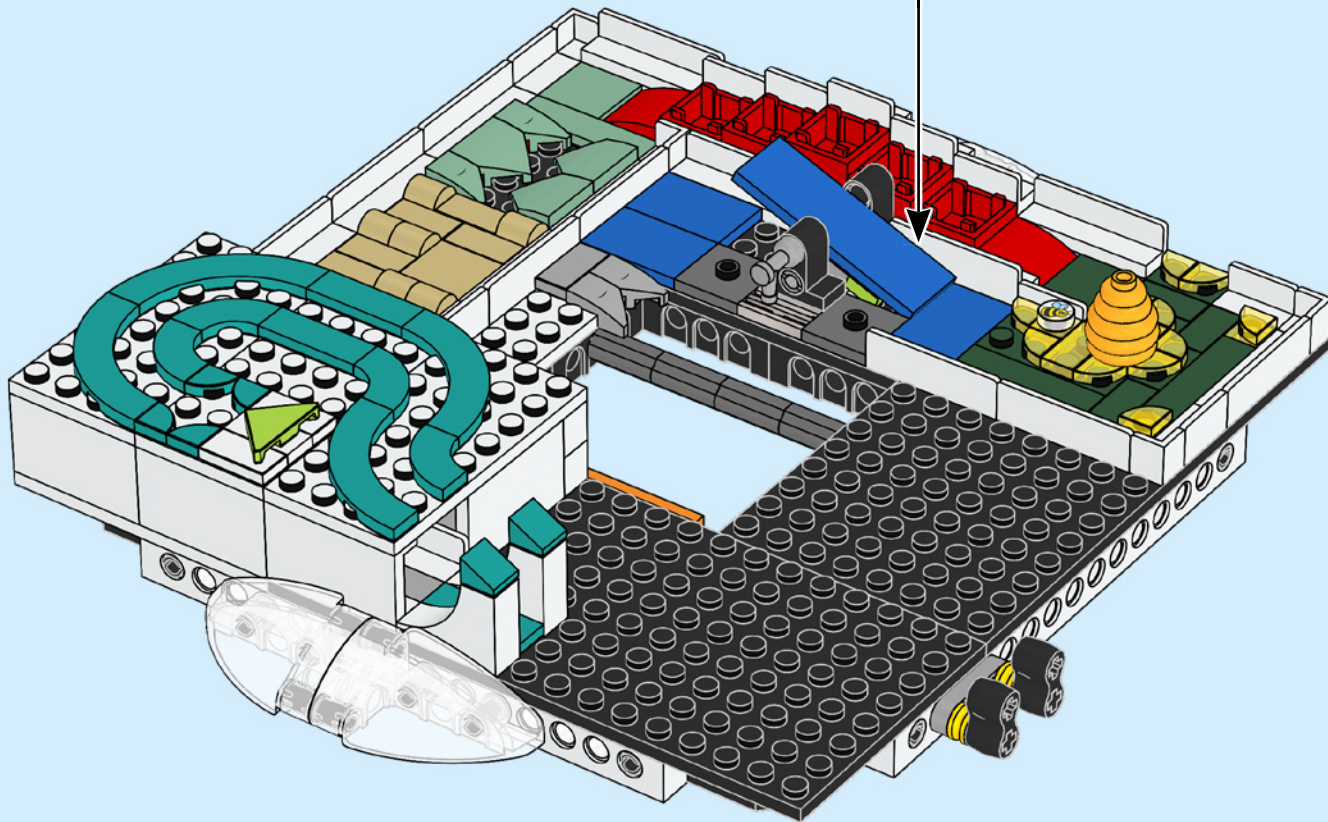
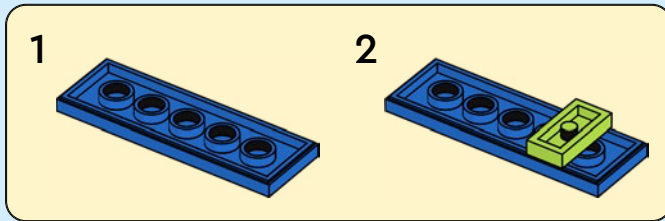

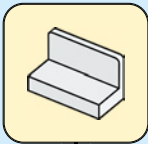
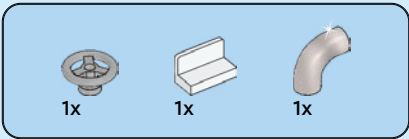

49

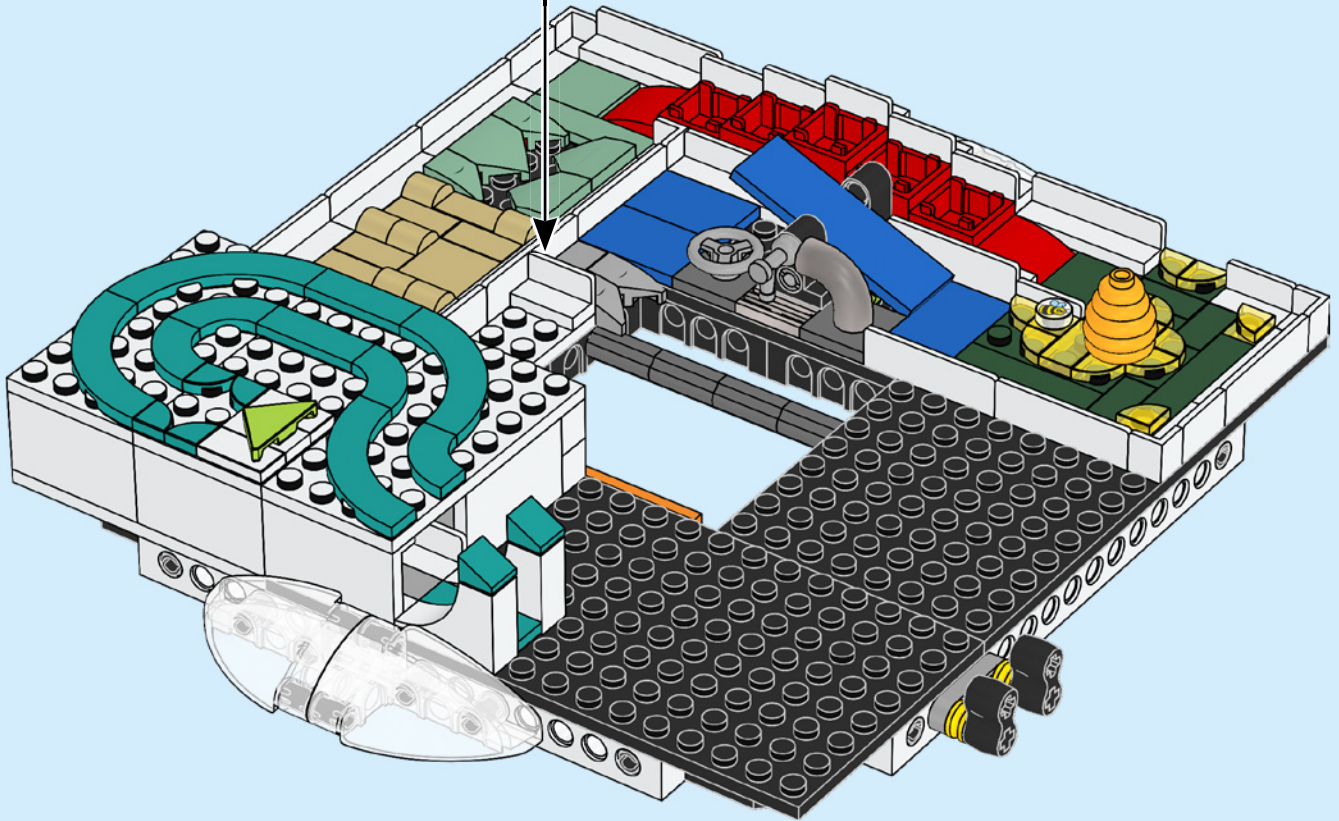

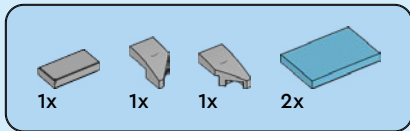

50

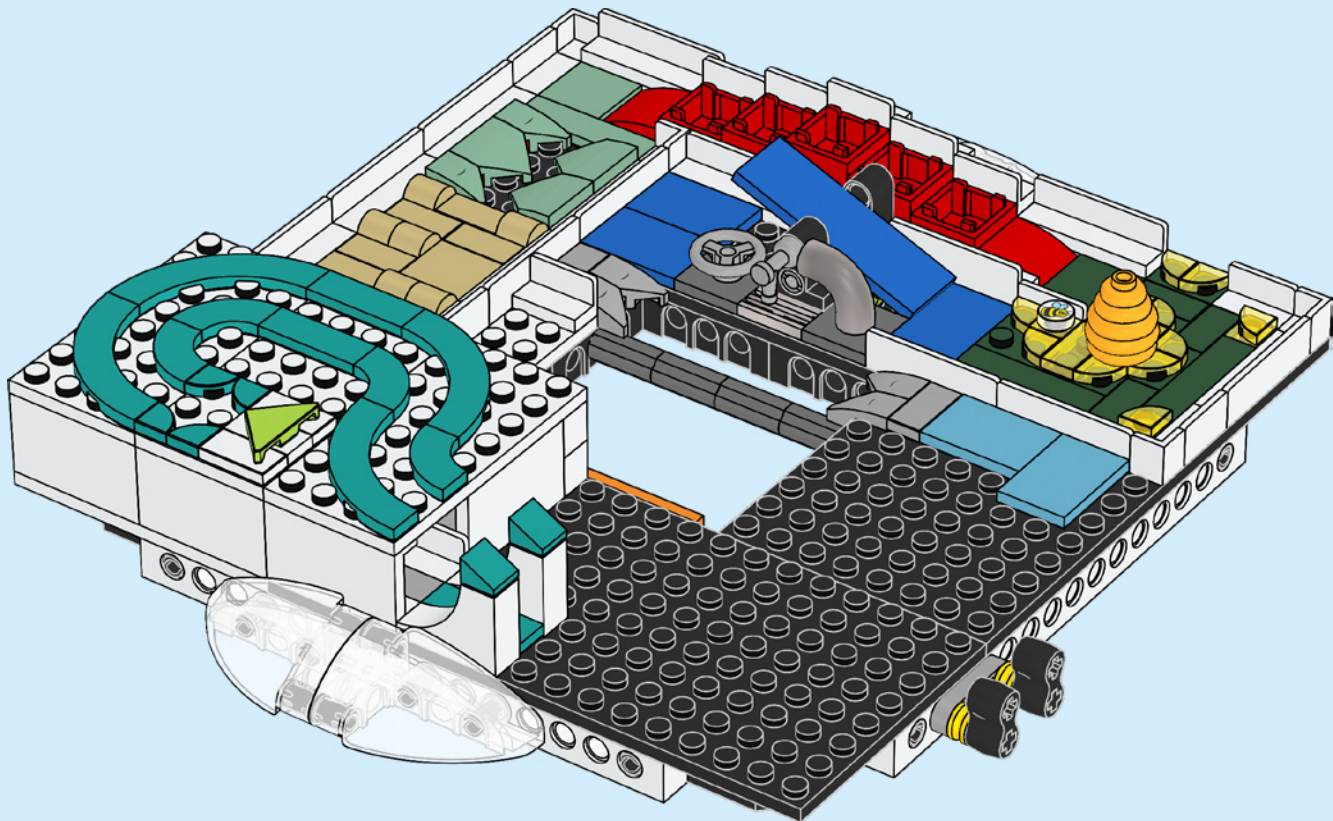

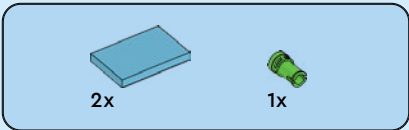

51

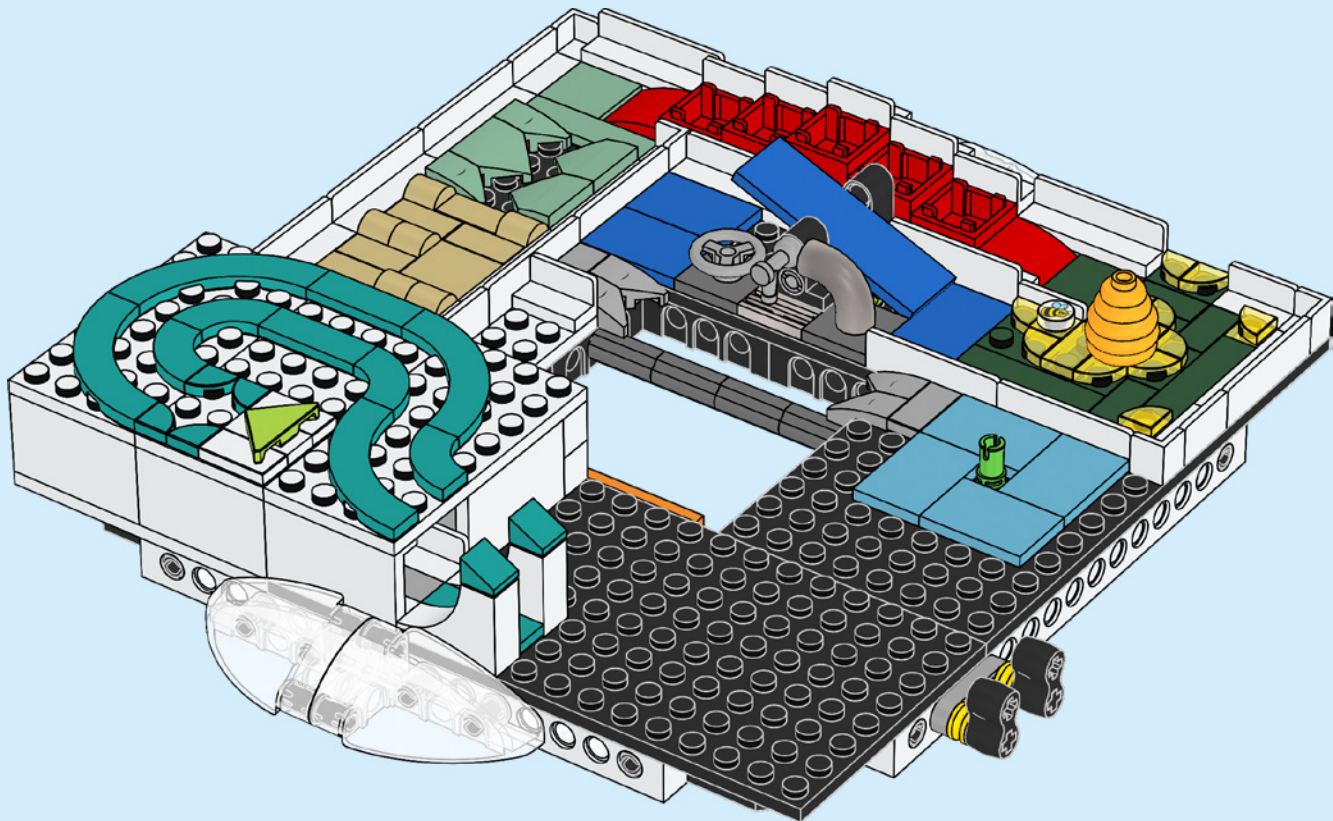

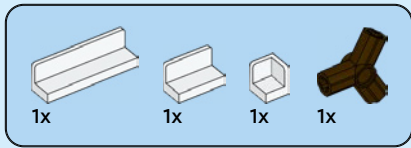

52

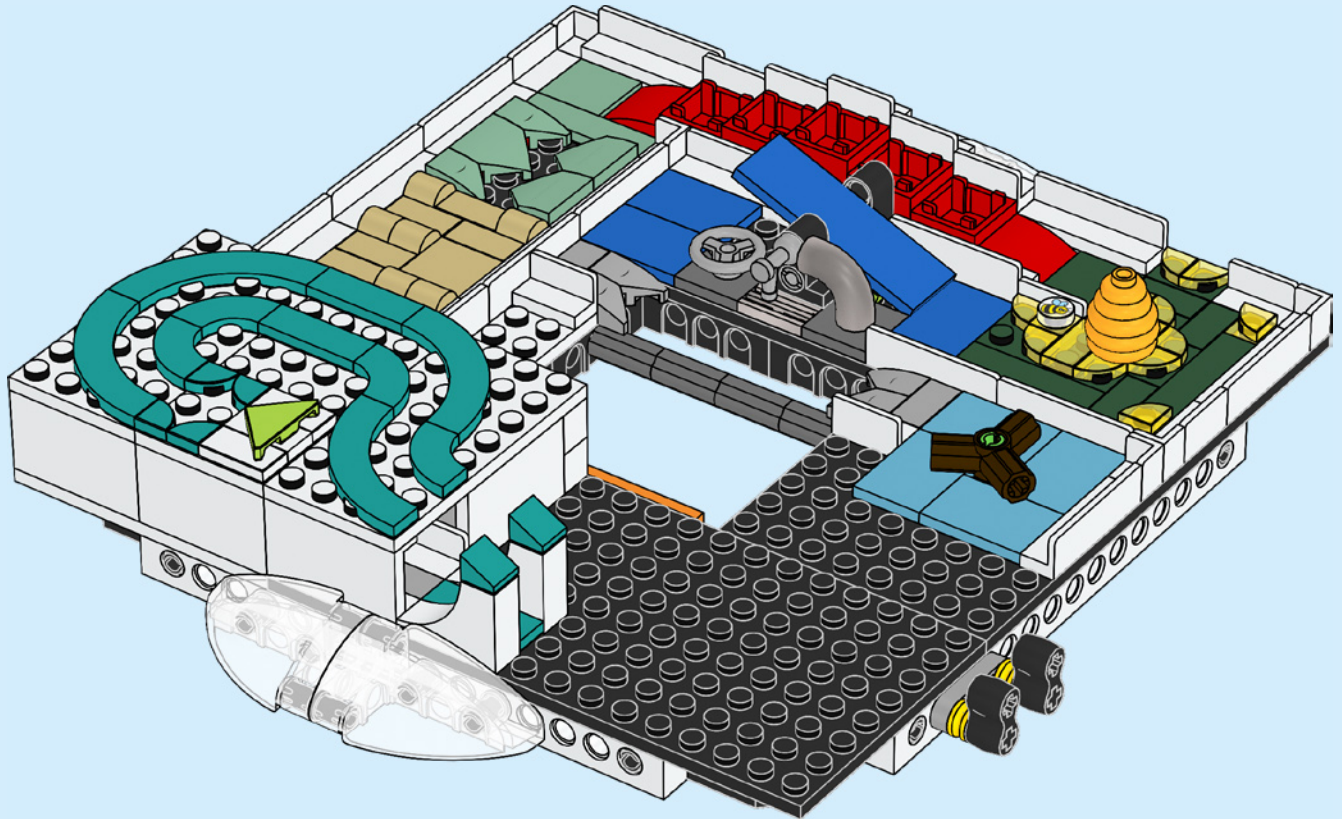

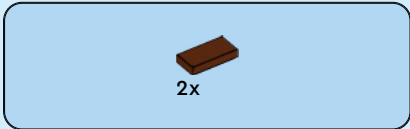

53

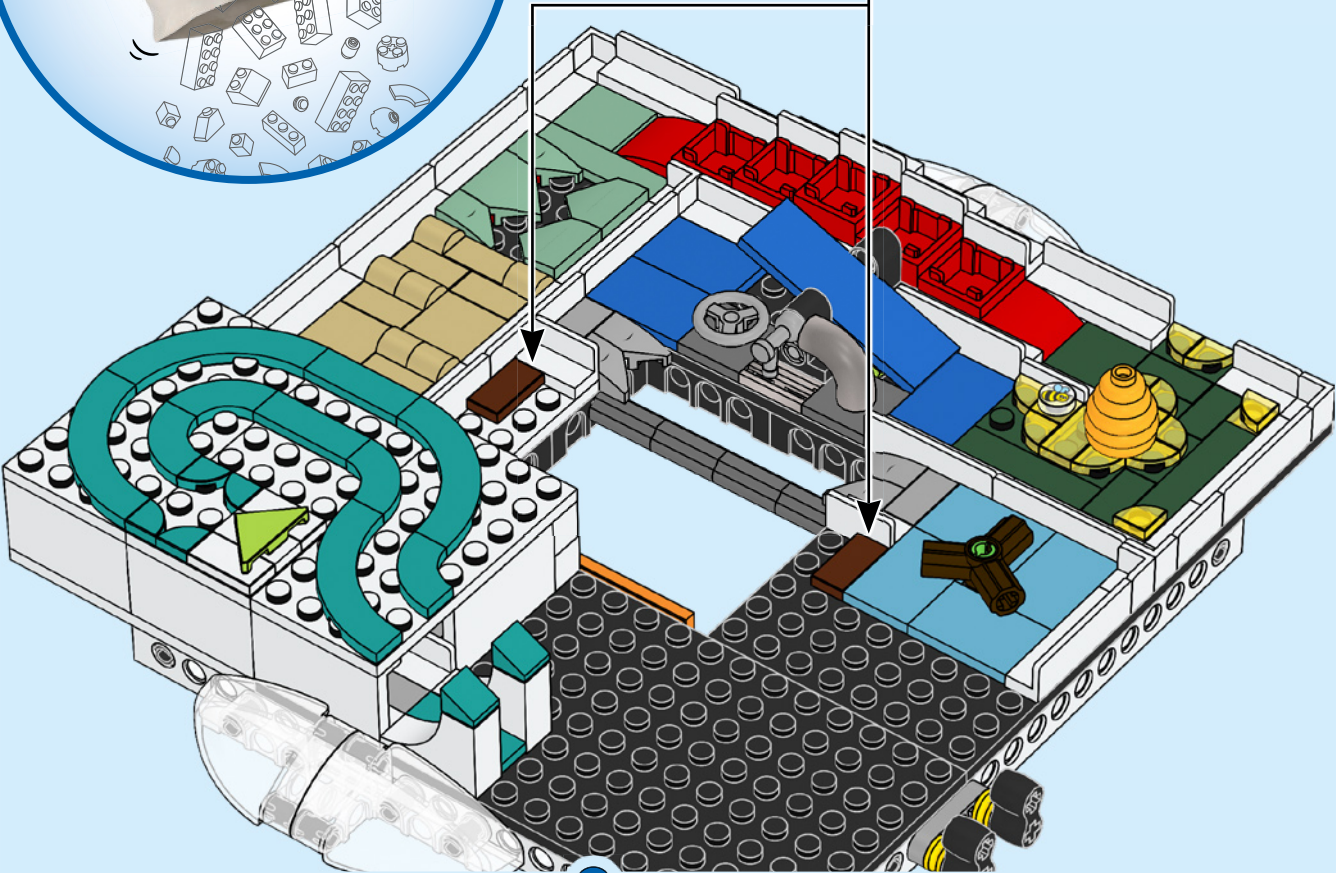

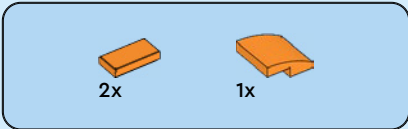

54

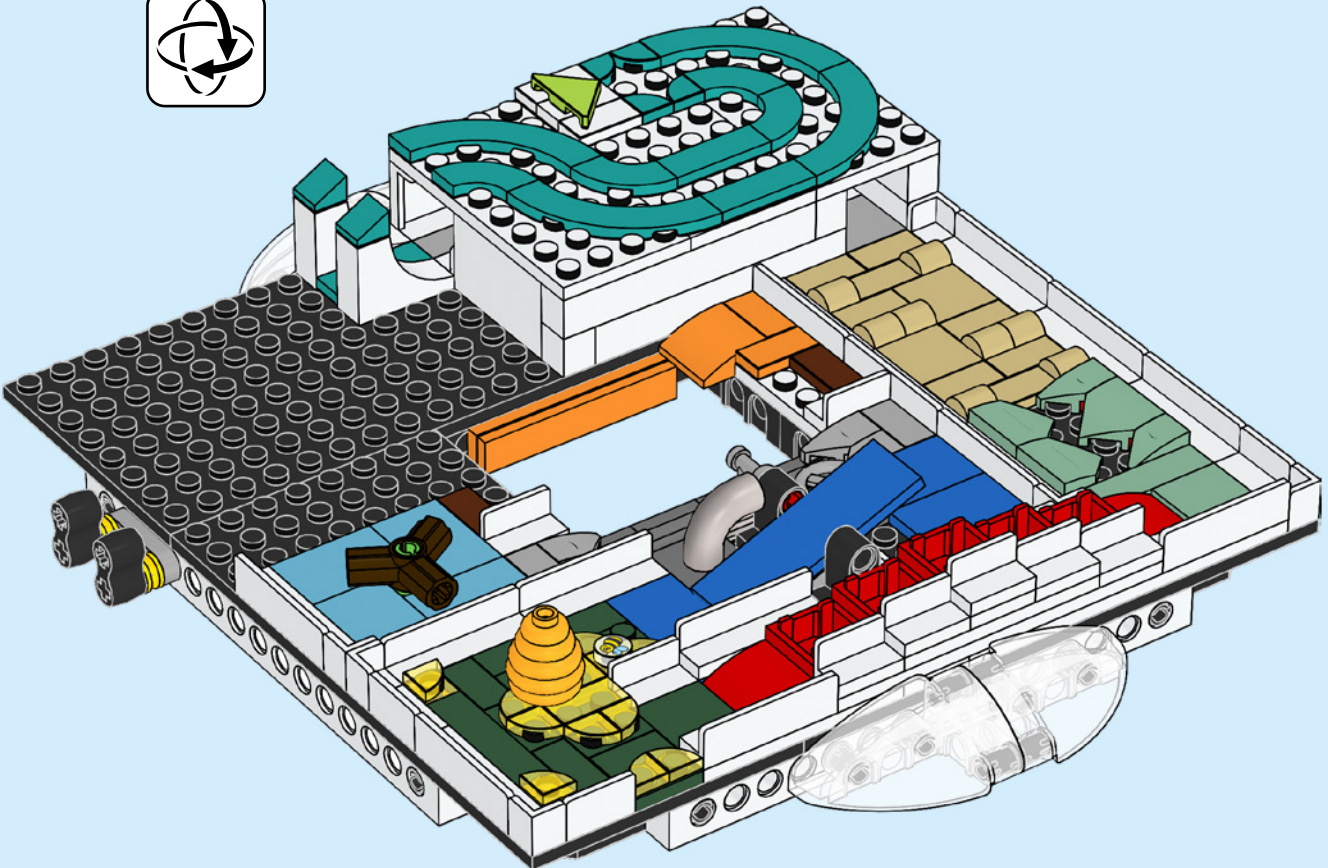

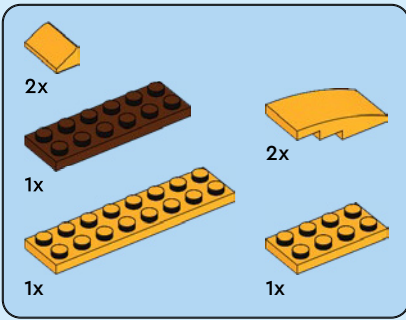

55

1

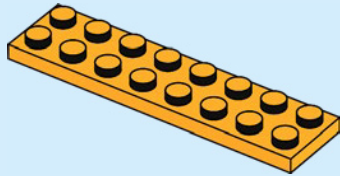

2

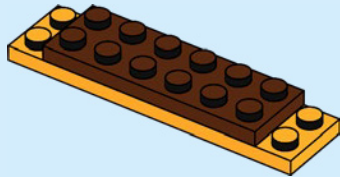

3

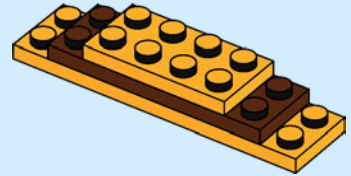

4

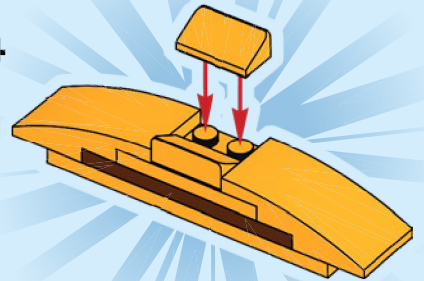

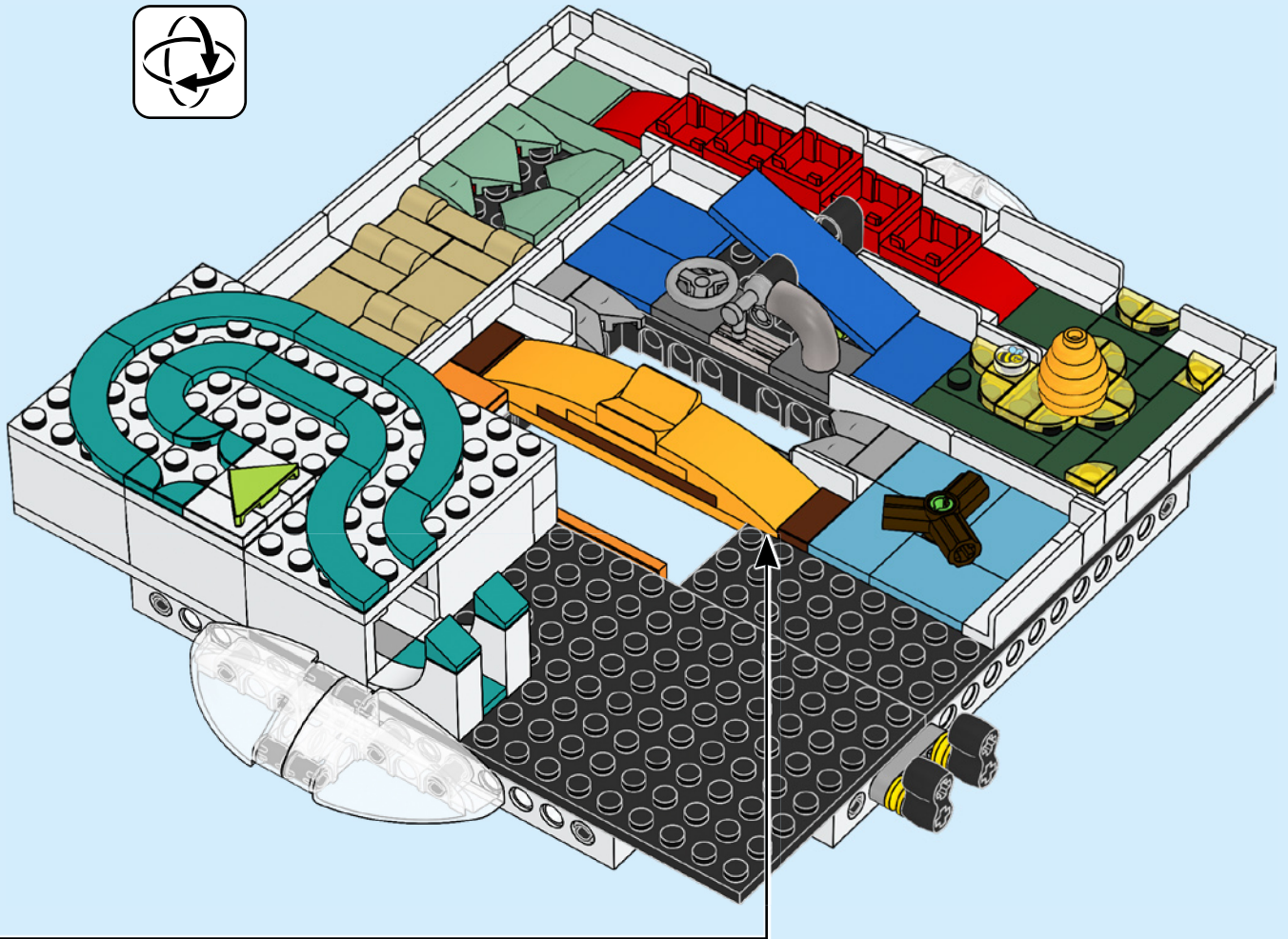

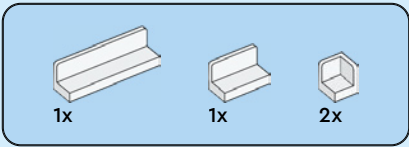

56

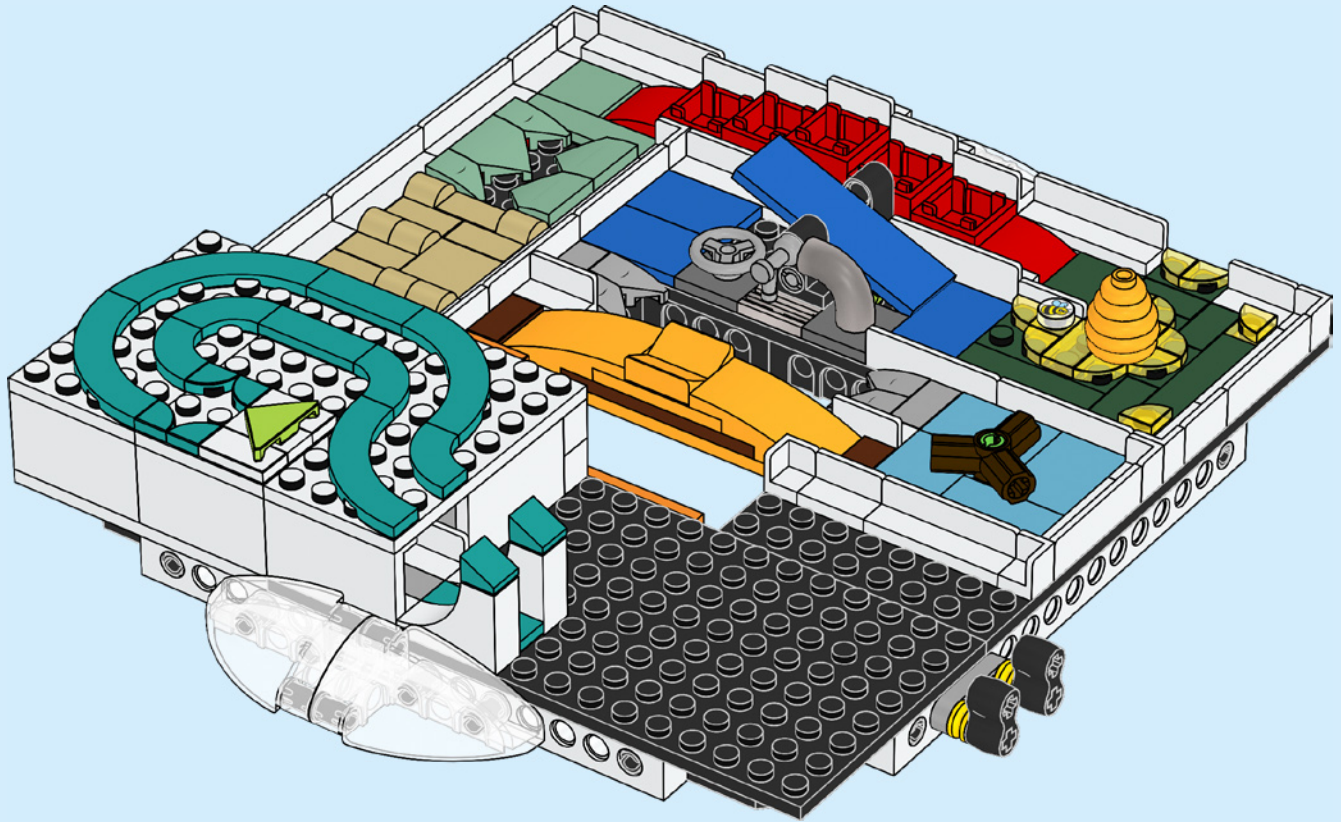

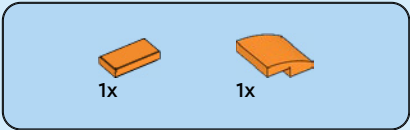

57

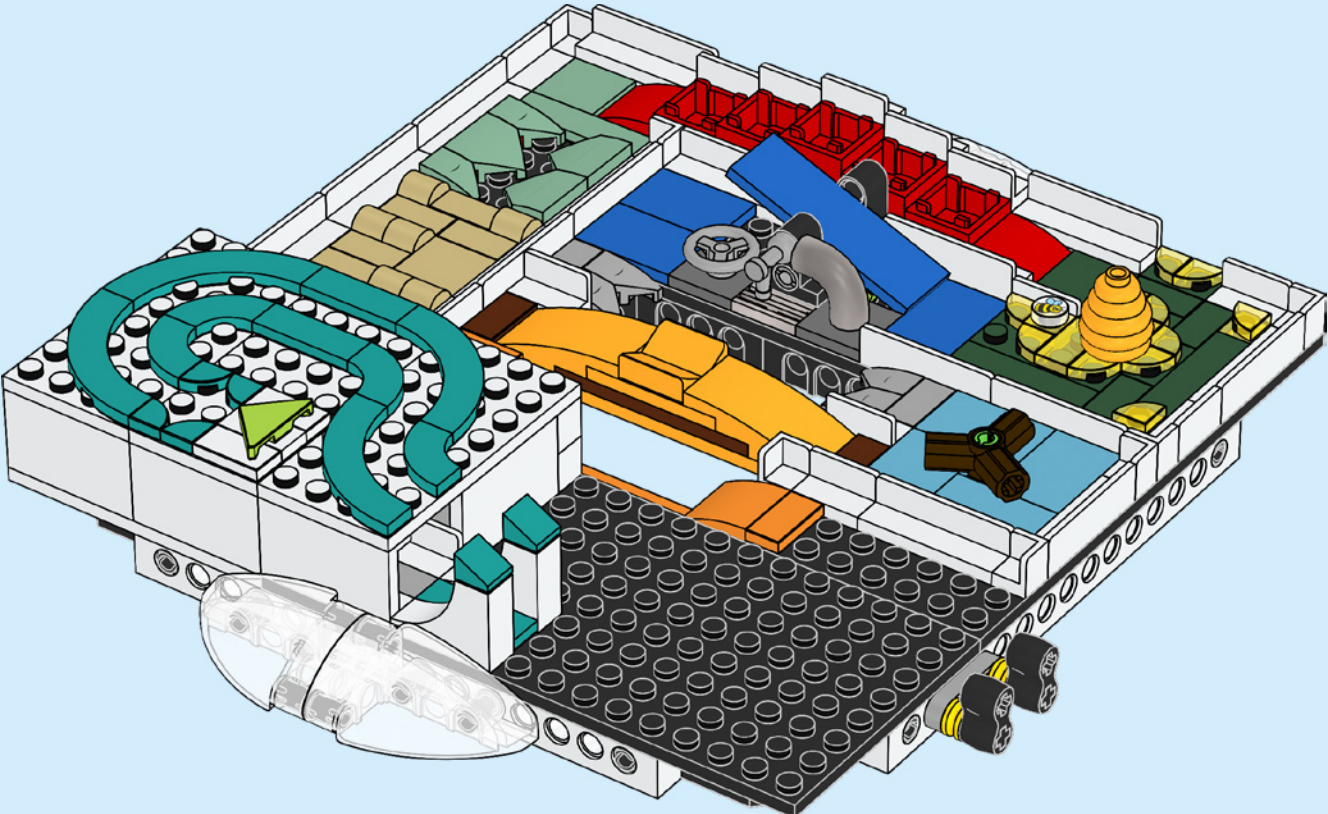

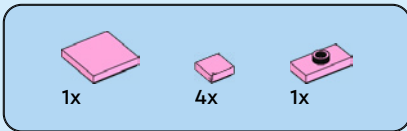

58

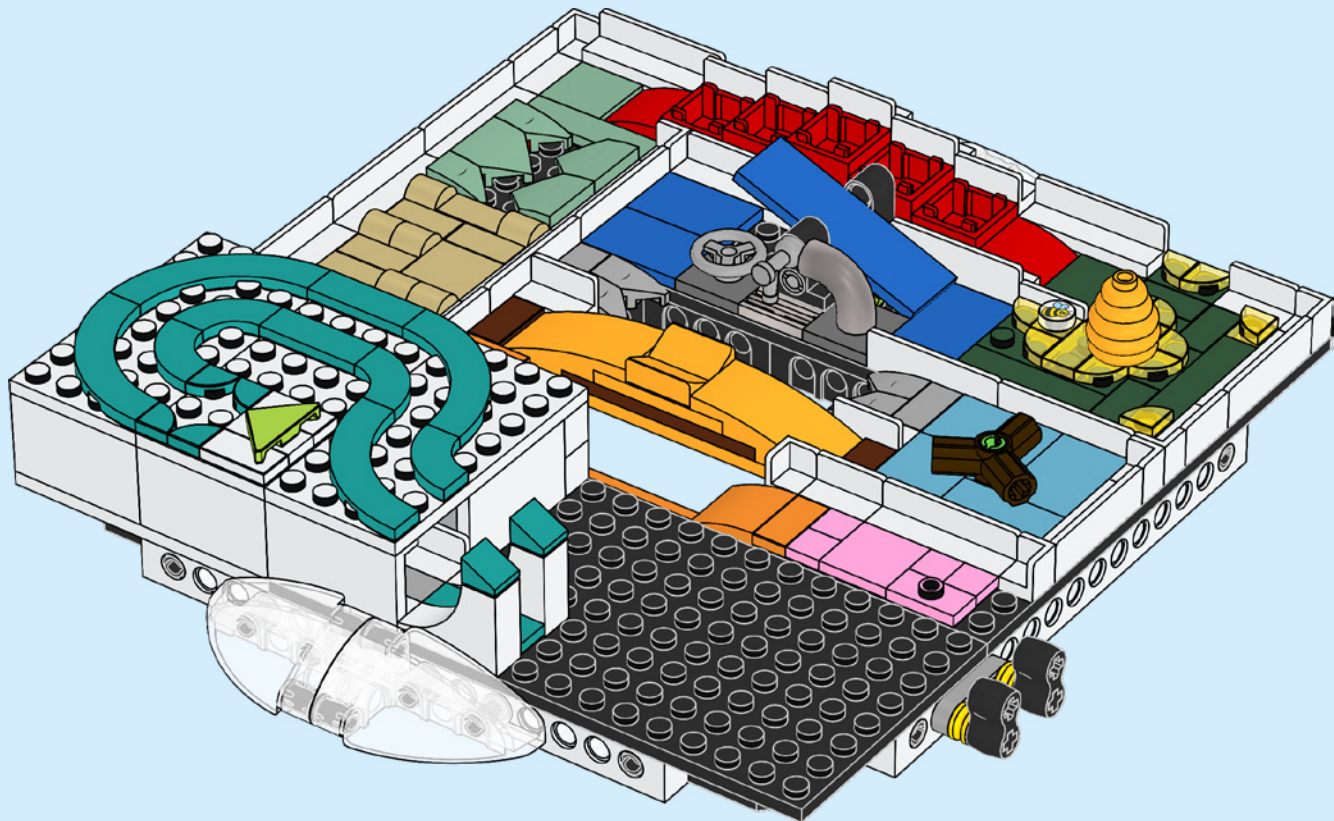

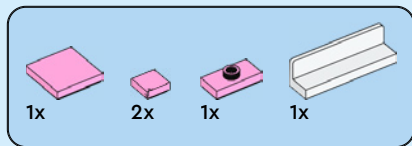

59

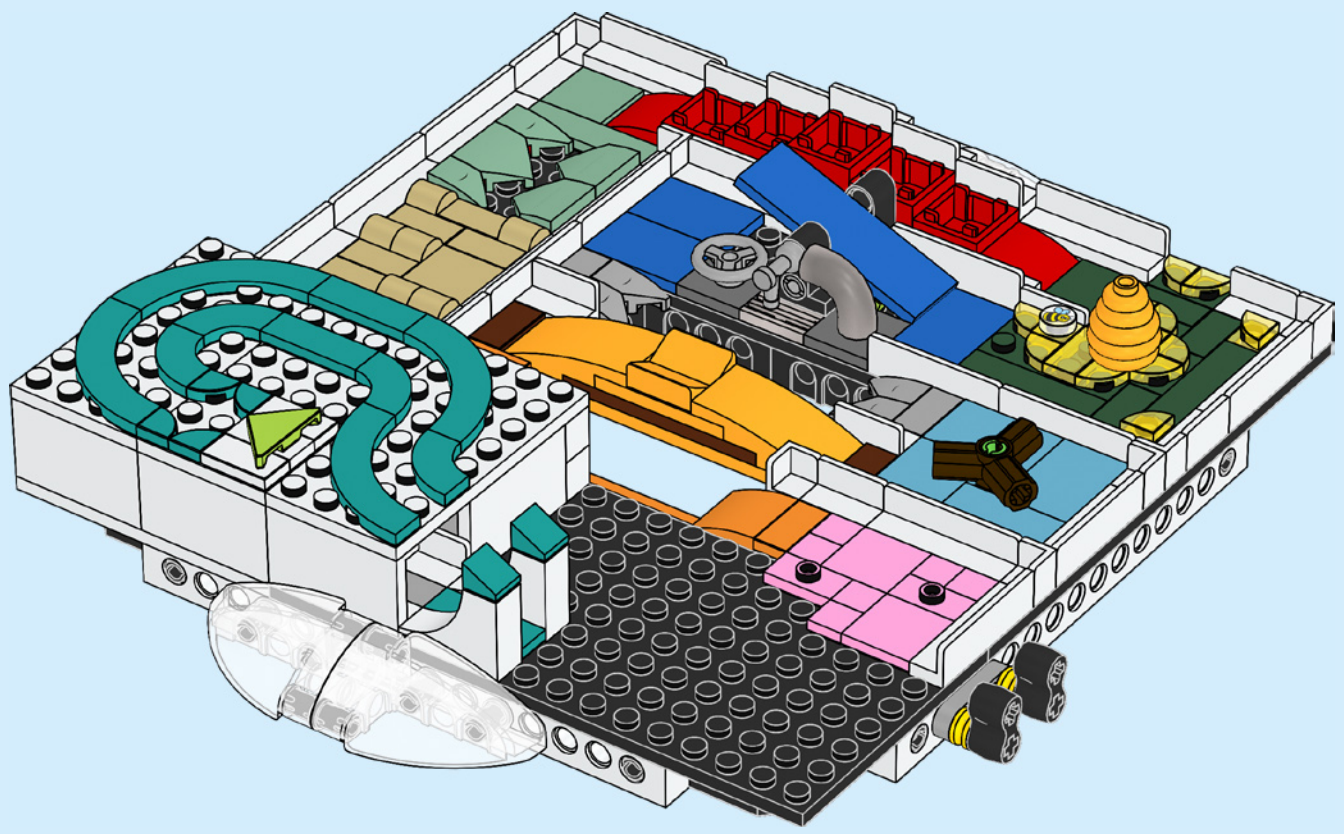

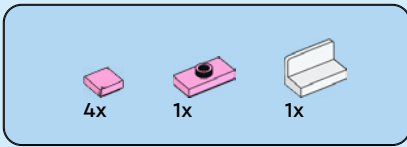

60

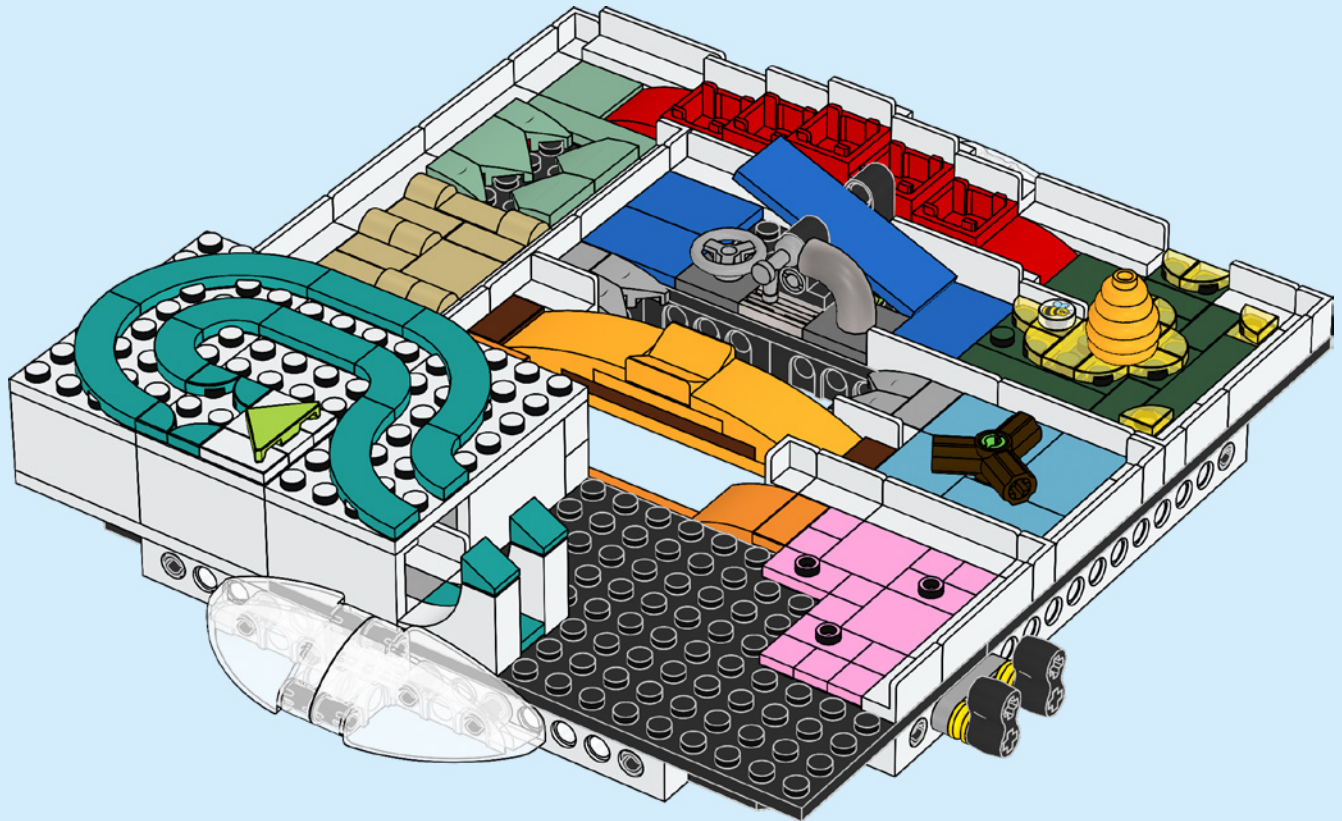

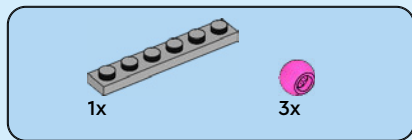

61

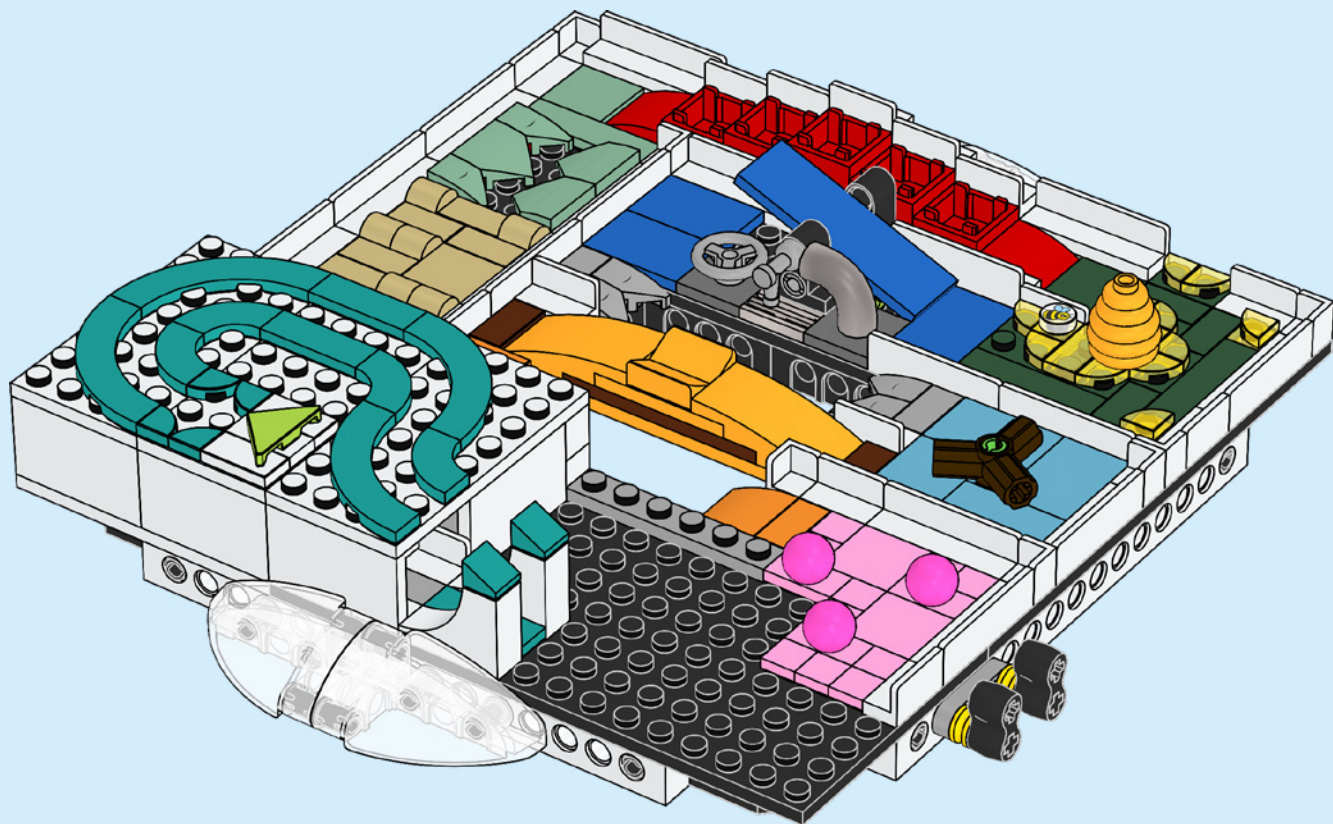

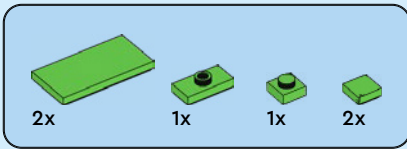

62

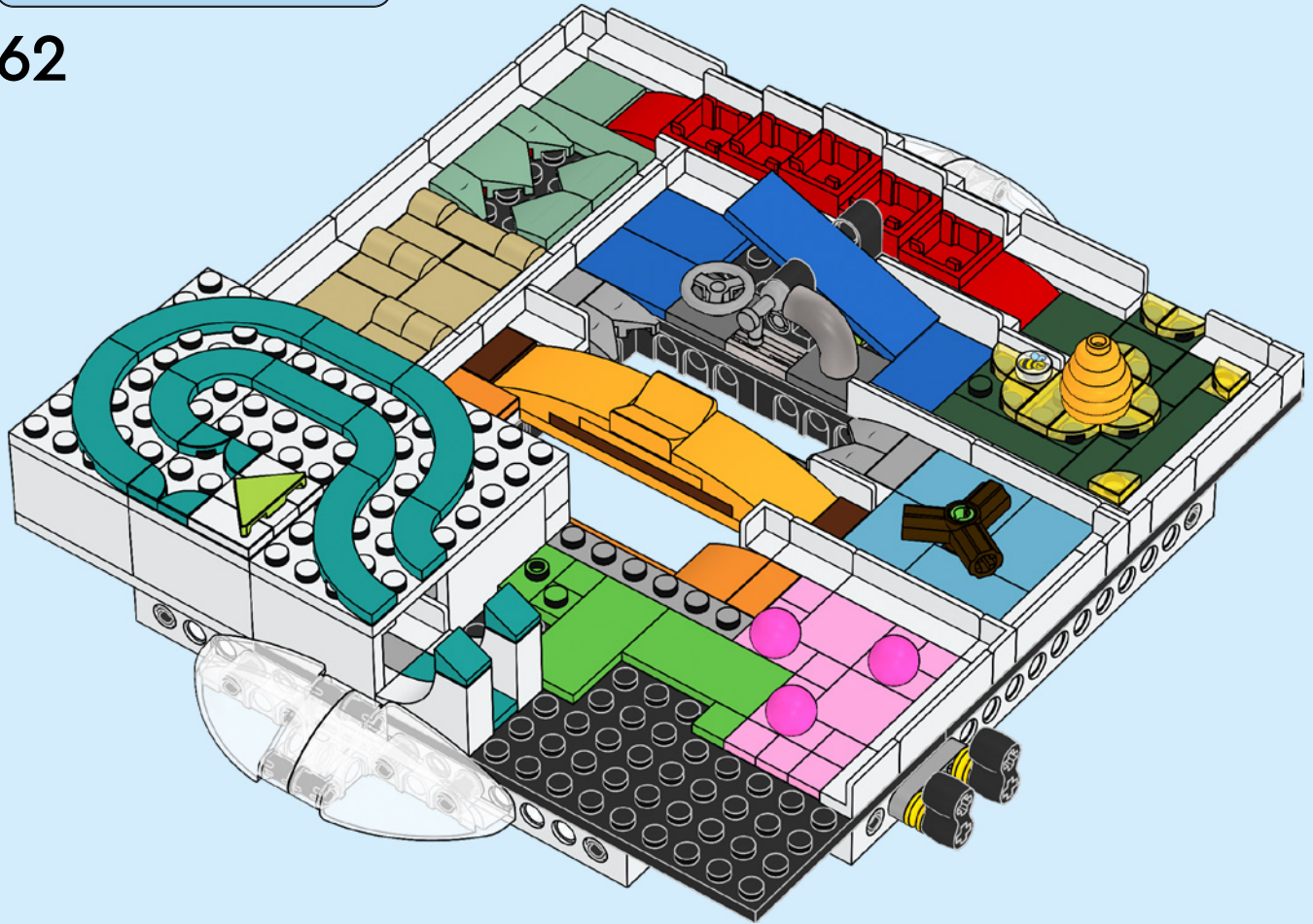

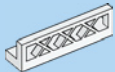

1x



2x

63

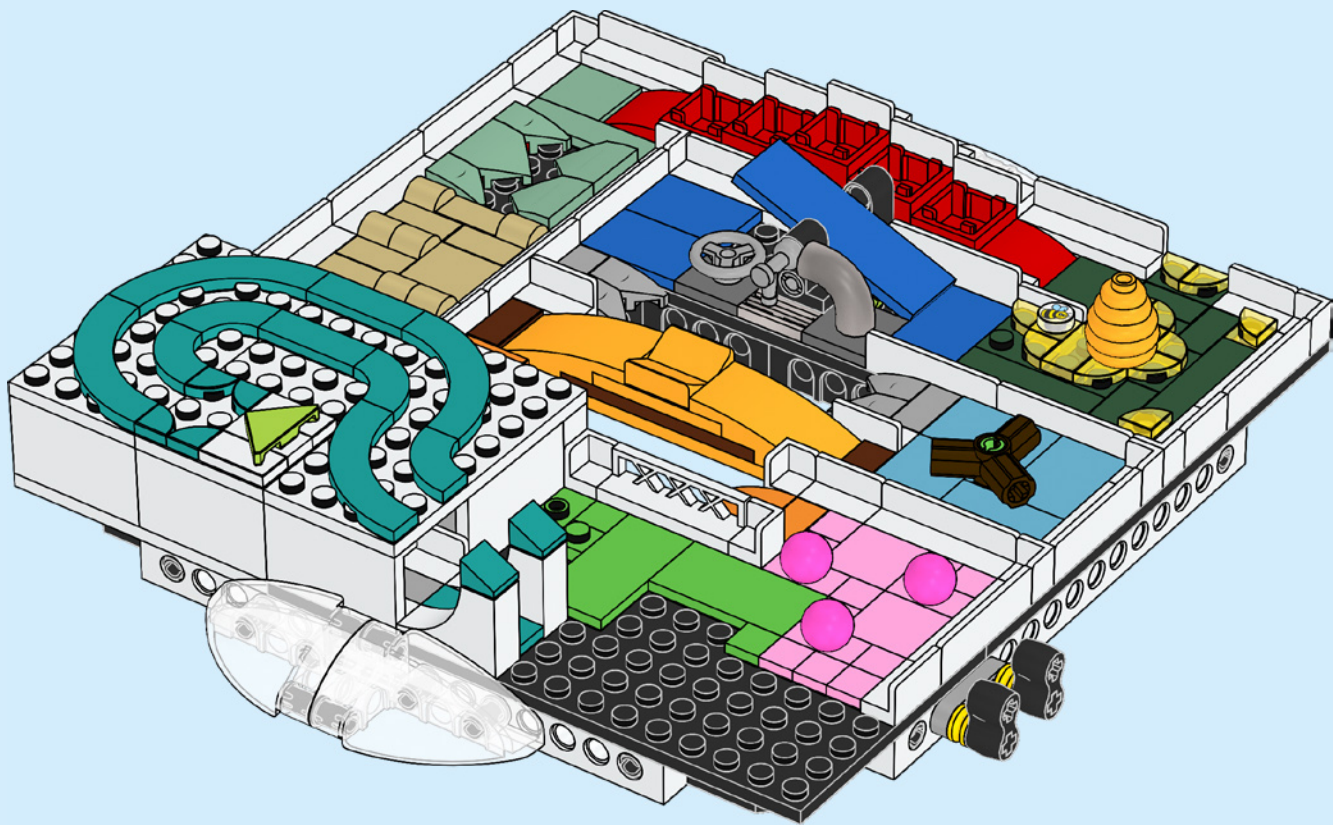

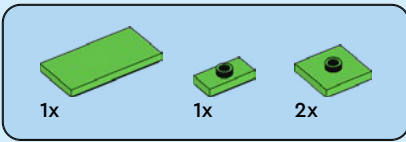

64

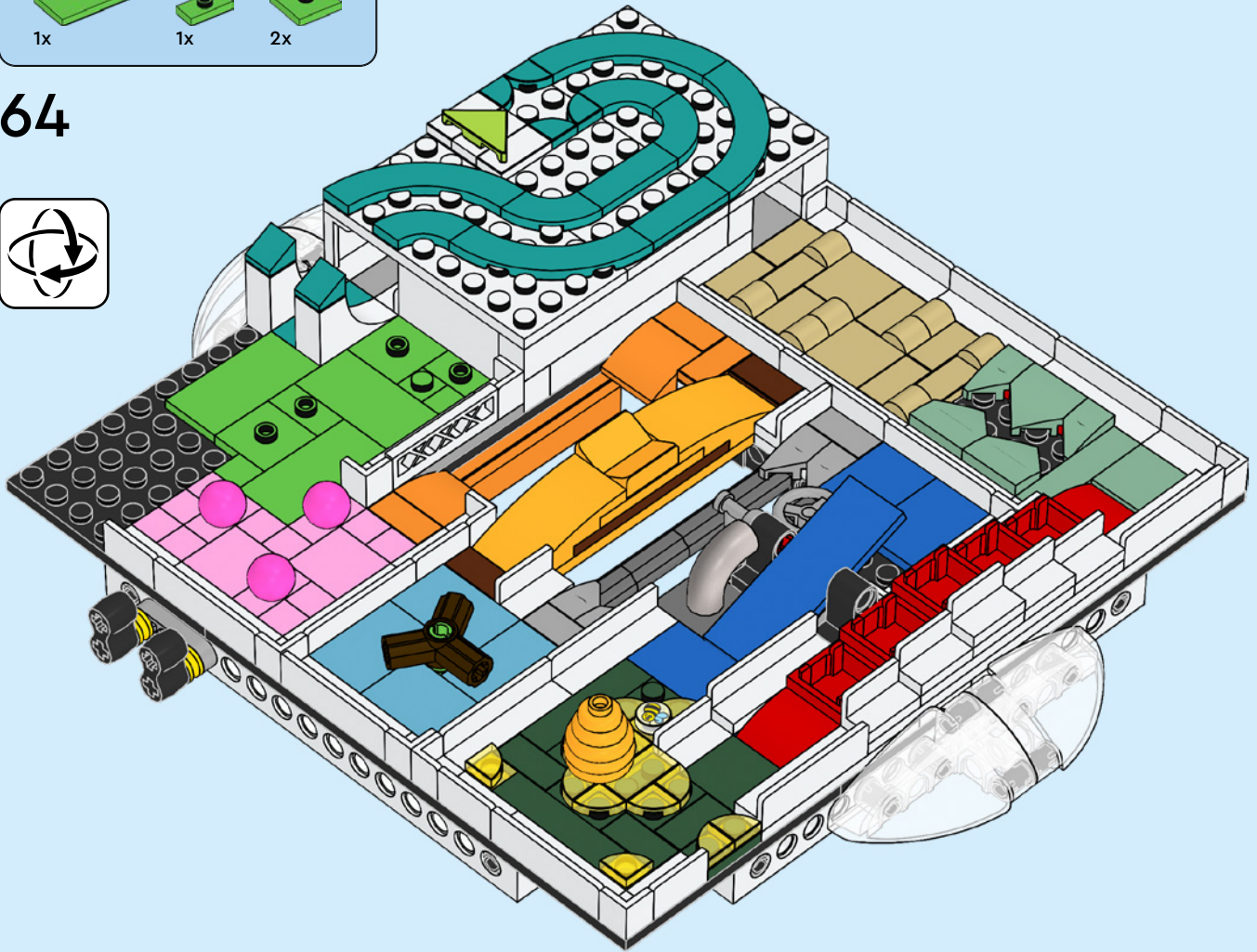

3x 1x 3x

3x

65

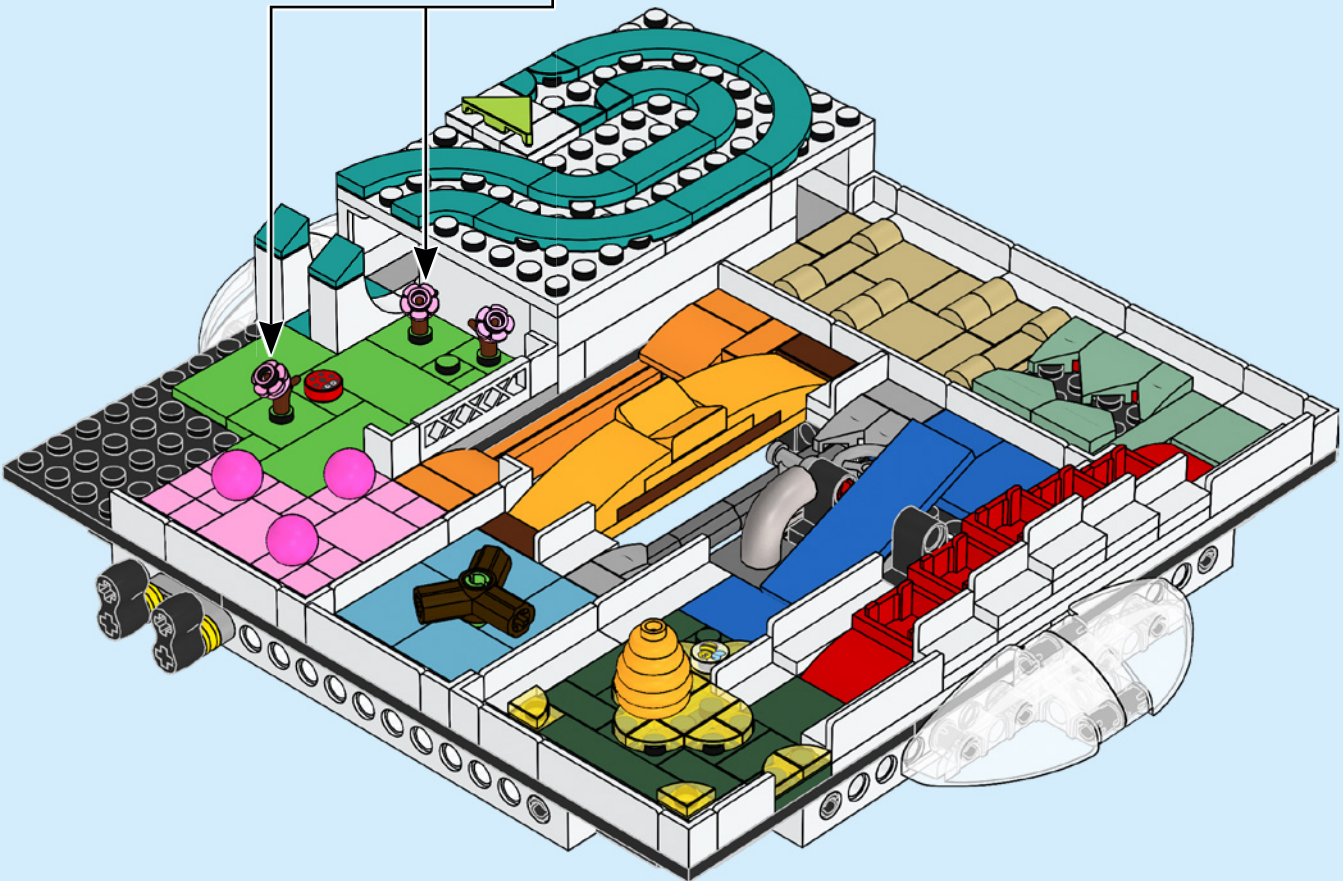

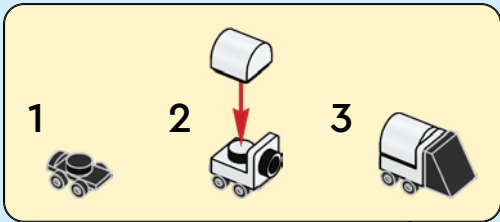
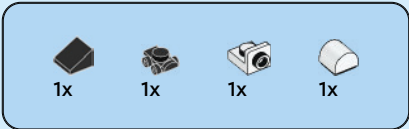

66

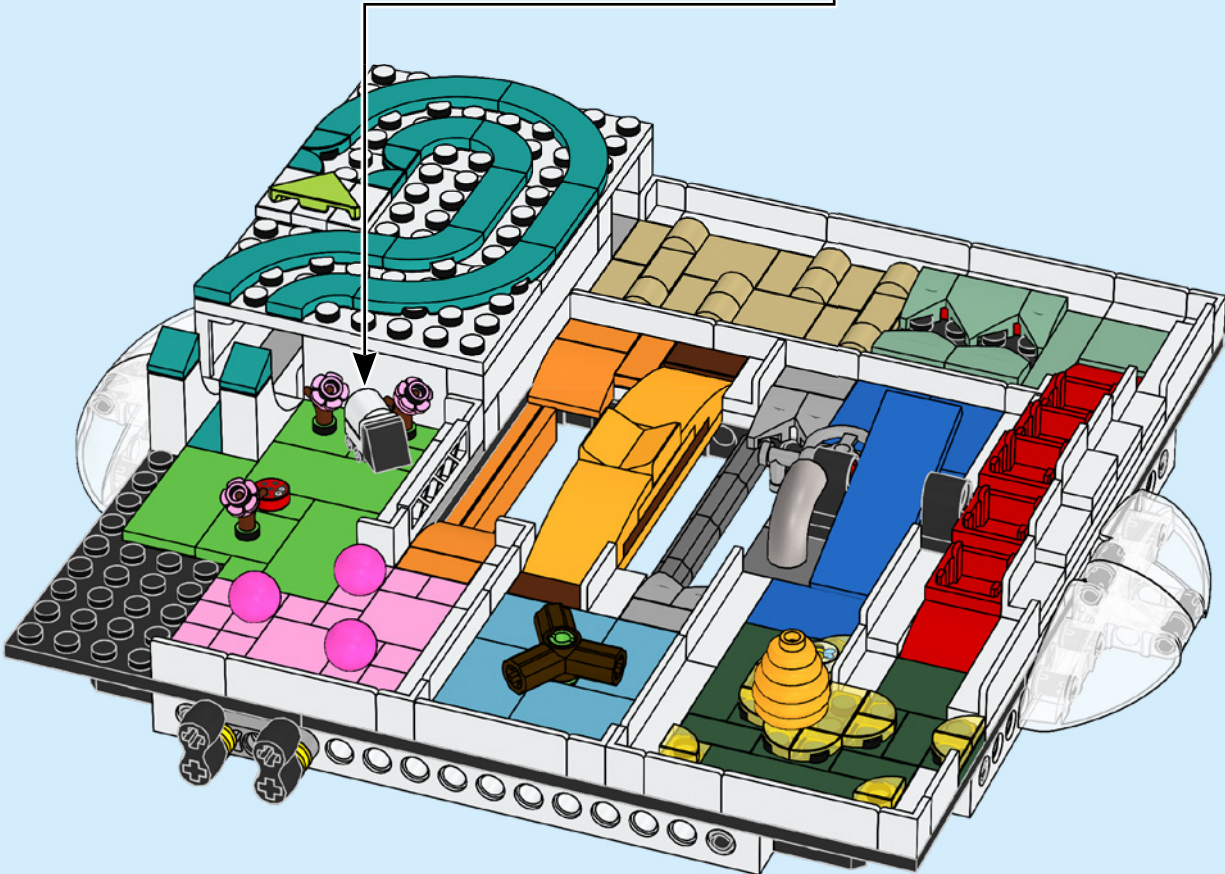

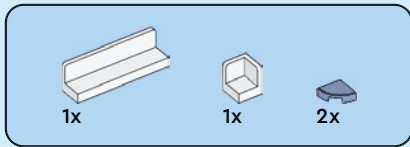

67



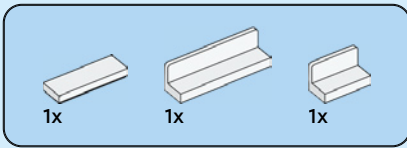

68

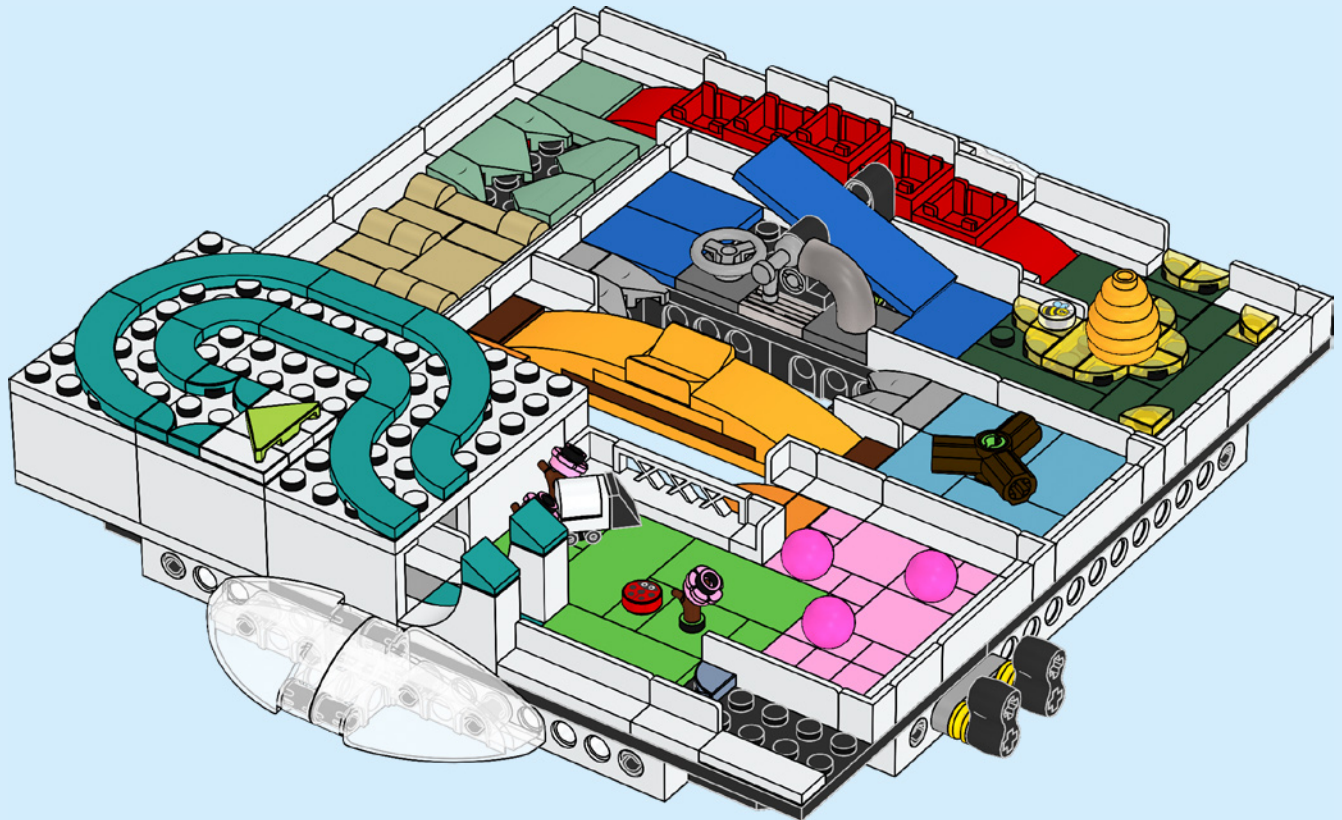

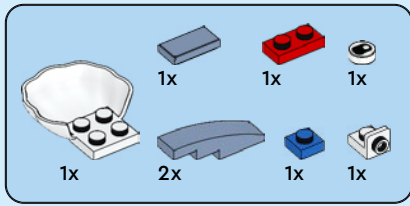

69

1



2



3

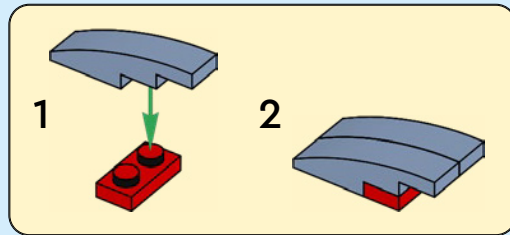
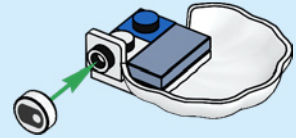

4

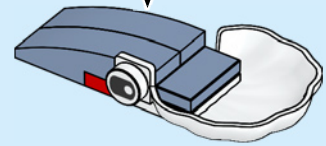

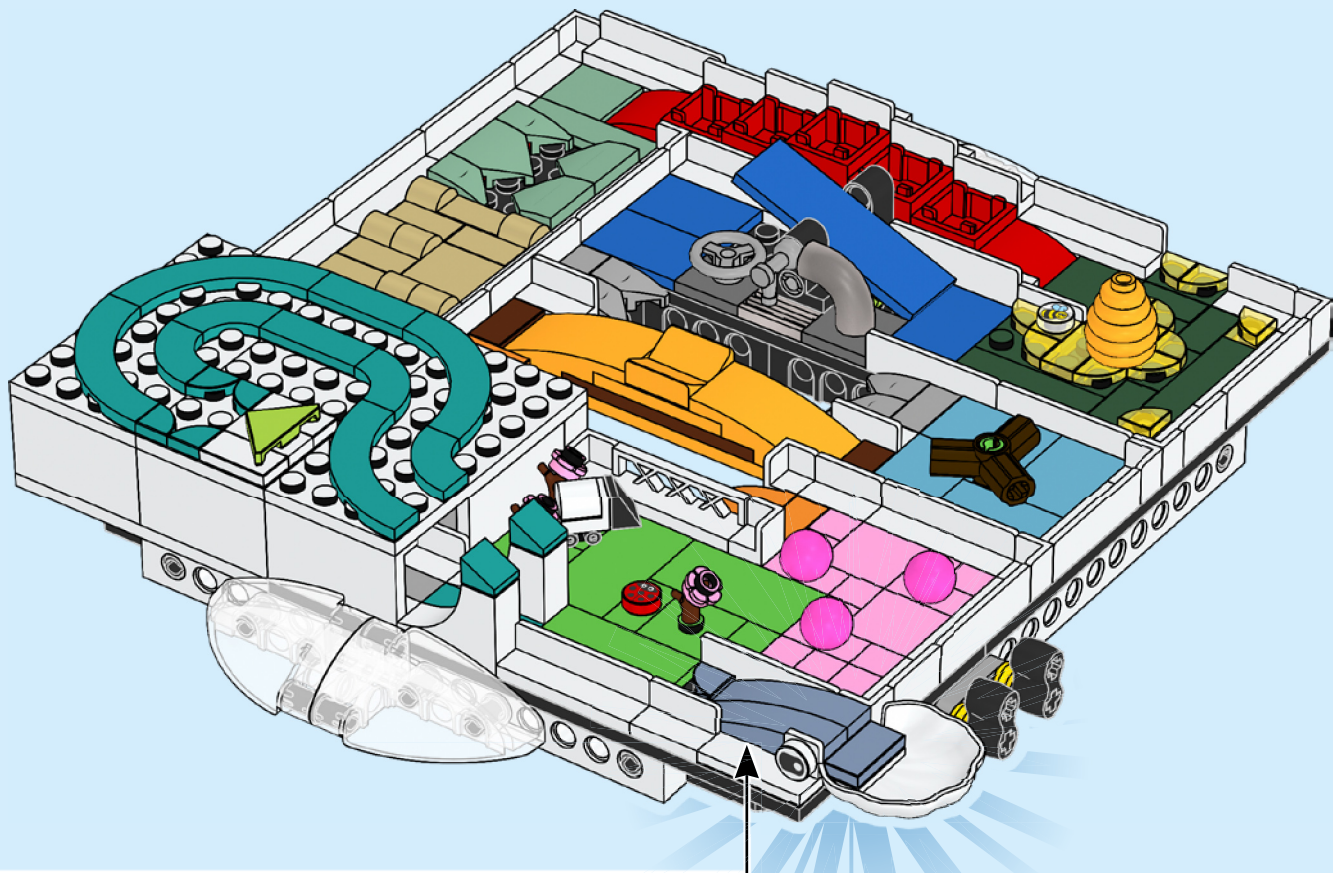



2x



2x

70

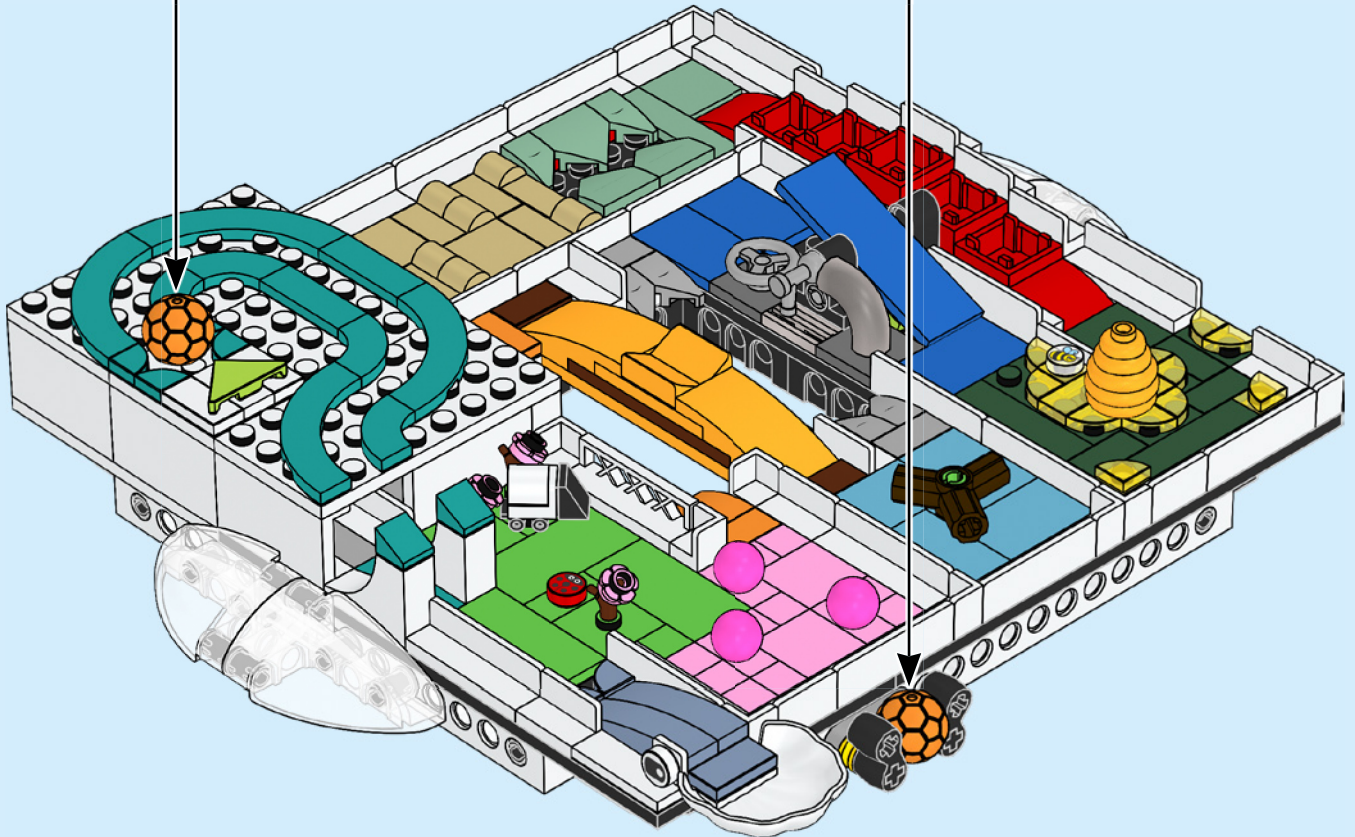



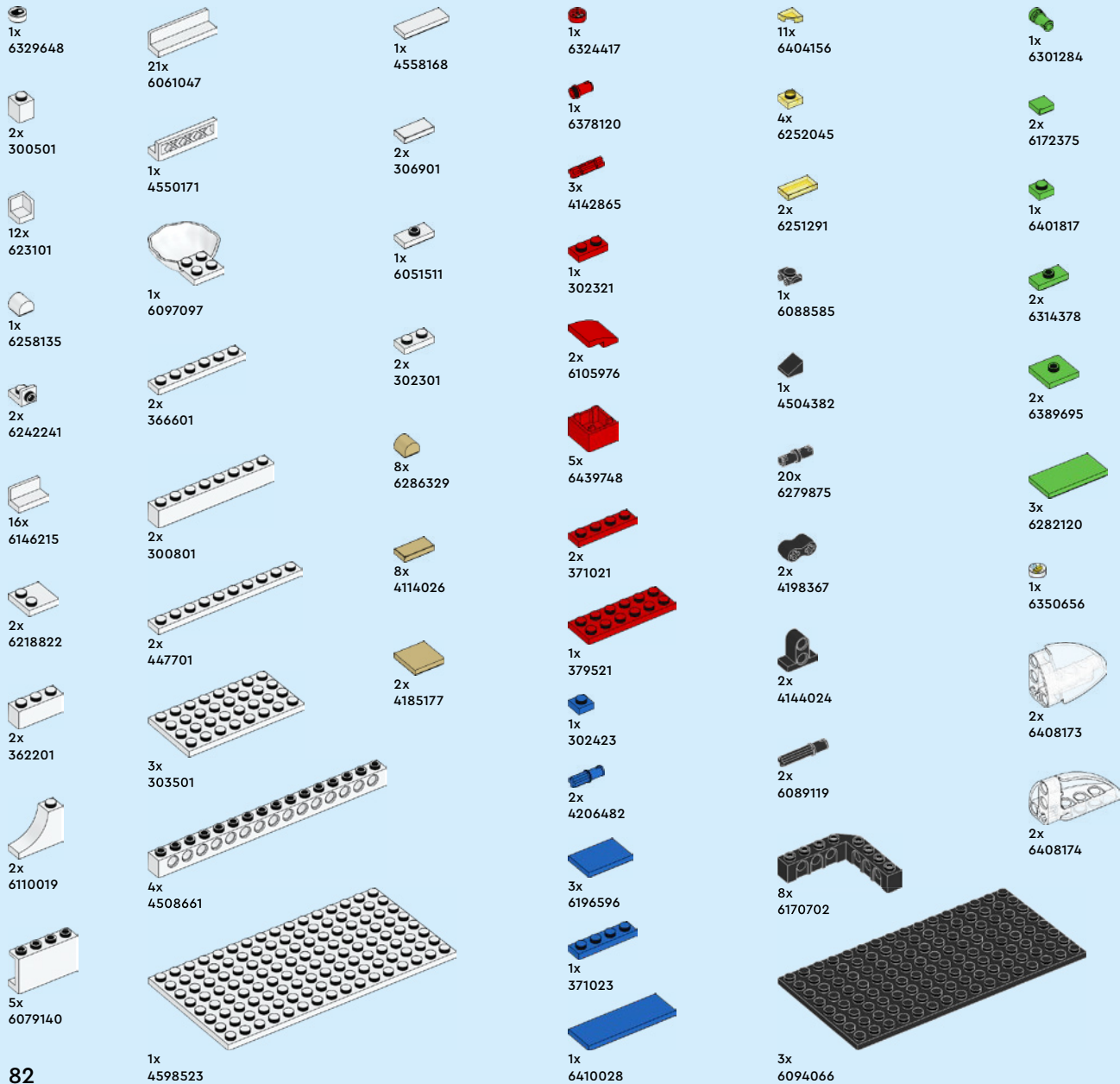

2x
6261264

3x
4188771

2x
6067913

1x
4173332

1x
4650690

4x
6240467

2x
6278172

4x
6213876

3x
6213787

4x
6458170

3x
4164037

1x
6247209

1x
4537937

2x
6400305

1x
6142505

2x
6431757

4x
6013102

3x
6326011

1x
4528778

2x
4543949

1x
4586057

1x
6221730

1x
6221729

3x
6416005

1x
6133896



1x
6192923

1x
6207256

2x
6024286

2x
6421207

1x
6097511

1x
6133817

3x
6345847

2x
4211151

1x
4211247

1x
4211503

2x
4211483

2x
6225139



2x
6225142



2x
4211807

3x
4211413

1x
4211376

4x
4211356

2x
4560183

1x
4211438

1x
6092956

4x
4211414

1x
6360043

4x
4516546

2x
6126083

1x
6172869

3x
6228091

3x
6212501

10x
6251940

3x
6264994

2x
4615728



4x
6233166

2x
6271167

1x
6273219

1x
4619636

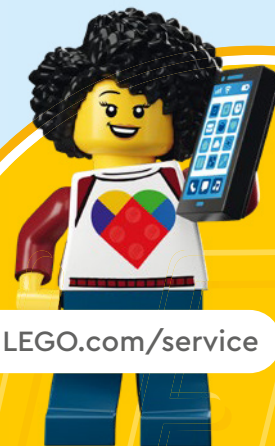
1x
6335563



 [LEGO.com/service](https://www.lego.com/service)

YOU COULD **WIN**



Scan this QR code or go to **LEGO.COM/PRODUCTFEEDBACK** and give us your short feedback about this LEGO® set for a chance to win a cool LEGO prize.

Terms and Conditions apply*

EN: YOU COULD WIN. Terms and Conditions apply* **DE: Du könntest GEWINNEN.** Es gelten die Teilnahmebedingungen* **FR: Tu pourrais GAGNER.** Des conditions s'appliquent* **IT: Potresti VINCERE tu.** Termini e condizioni sono applicabili* **ES: Puedes GANAR.** Aplican términos y condiciones* **PT: Poderá GANHAR.** Aplicam-se termos e condições* **ZH: 轻松获奖. 条款和条件适用*** **PL: Szansa na WYGRANĄ.** Obowiązują warunki korzystania* **CS: Máte šanci VYHRÁT.** Platí všeobecné smluvní podmínky* **SK: Máte šancu VYHRAŤ.** Platia všeobecné zmluvné podmienky* **HU: TE IS NYERHETSZ.** Felhasználási feltételek érvényesek* **RO: Ai putea CÂȘTIGA.** Se aplică termeni și condiții* **BG: Можете да СПЕЧЕЛИТЕ.** Има определени правила и условия* **LV: Tu vari LAIMĒT.** Ir spēkā noteikumi un nosacījumi.* **ET: Sul on võimalus VÕITA.** Kehtivad tingimused* **LT: Jūs galite LAIMĖTI.** Taikomos sąlygos*

*[LEGO.com/productfeedback-terms](https://www.lego.com/productfeedback-terms)

LEGO and the LEGO logo are trademarks of the/sont des marques de commerce du/son marcas registradas de LEGO Group. ©2023 The LEGO Group.

6480398