



40659



Booklet available in English on
Heft in deutscher Sprache erhältlich auf
Livret disponible en français sur
Libretto disponibile in italiano su
Folleto en español disponible en
如需中文版手册, 请访问

[LEGO.com/service/buildinginstructions](https://www.lego.com/service/buildinginstructions)



LEGO.com/sustainable-packaging



Rebuild
the
world™



Mini Steamboat Willie

Without a doubt, Disney's 1928 cartoon *Steamboat Willie* represents a series of culturally and historically significant firsts: The first cartoon with fully synchronised sound, one of the first fully post-produced soundtracks and the first public appearance of the cheeky hero that would go on to become one of the world's most beloved personalities. All in all, *Steamboat Willie* was a ground-breaking achievement.

Walt Disney was convinced that sound would bring a real sense of magic and humour to the cartoon... and it truly did. His sense of storytelling and drive for technical innovation prevailed and led to international fame for both himself and Mickey Mouse.

100 years later, The Walt Disney Company still represents the world's best storytelling and innovation in animation.

We are proud to present this **miniature** model and hope it builds a little of that sense of magic that *Steamboat Willie* did when it was first screened.

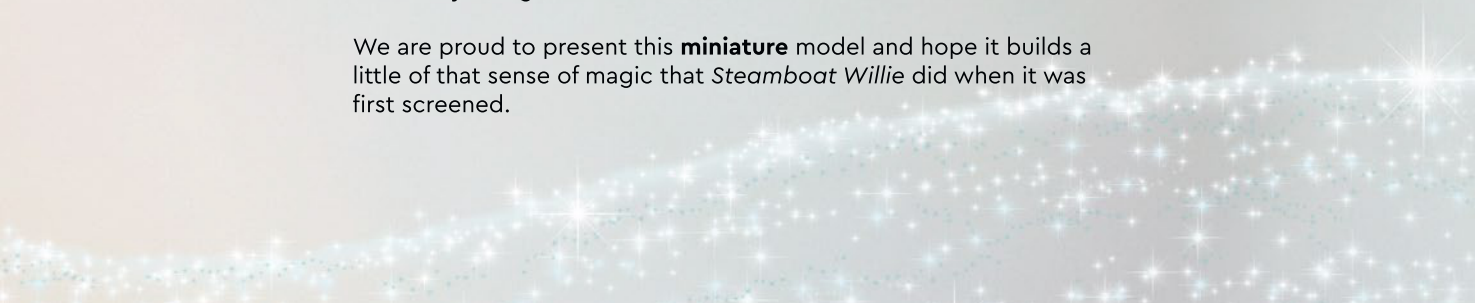

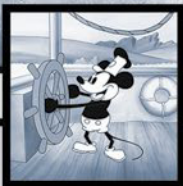

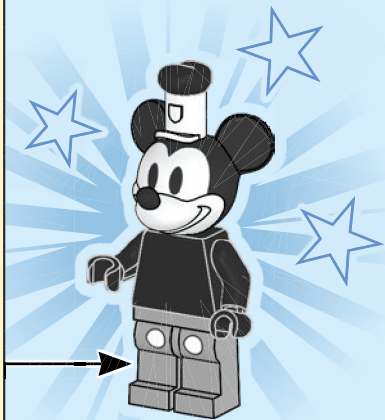
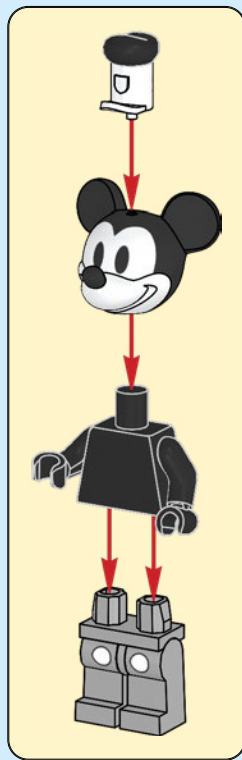

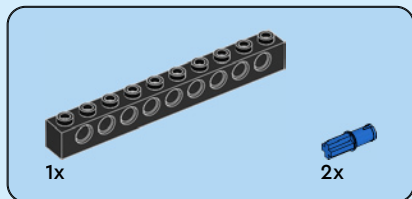
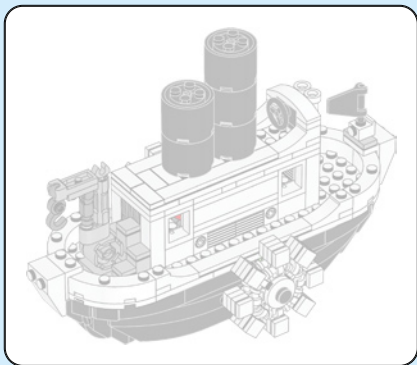

1

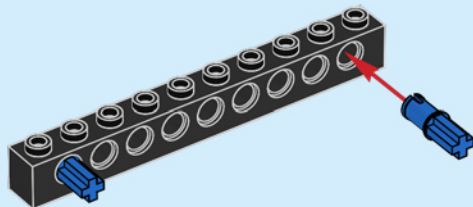

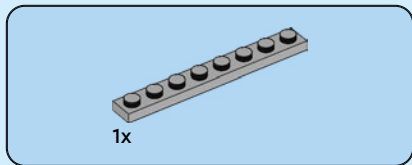

2

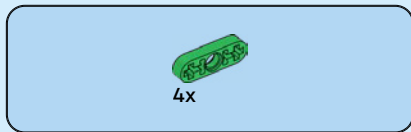
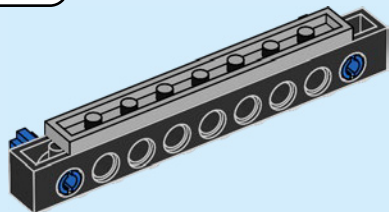

3

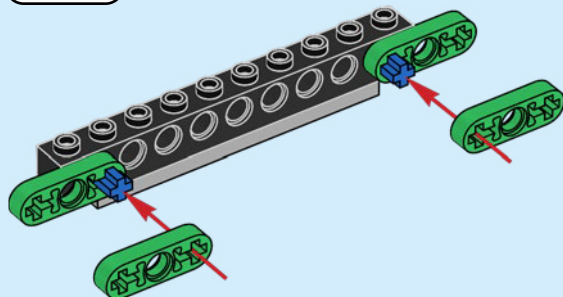
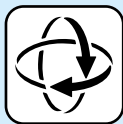



2x

4

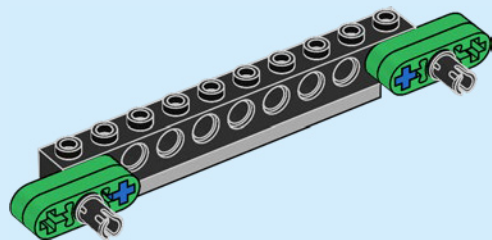

2x

5

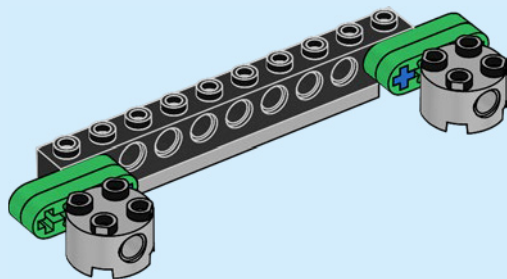

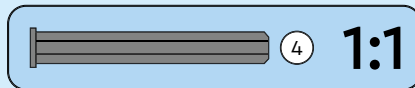
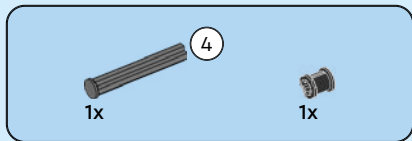

6

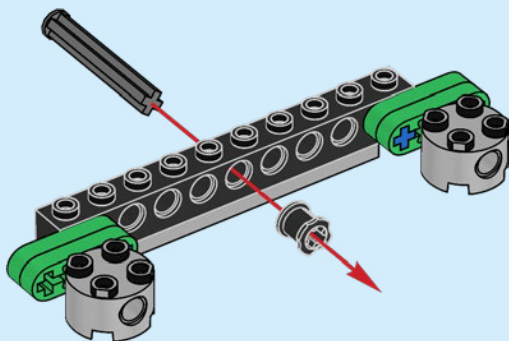

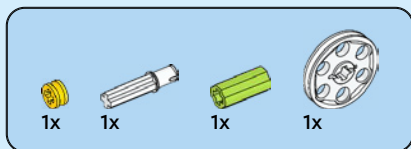

7

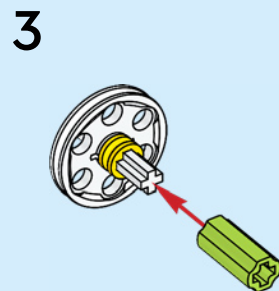
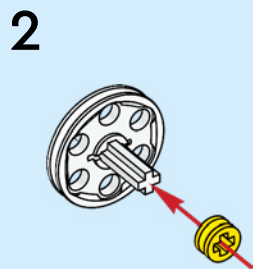
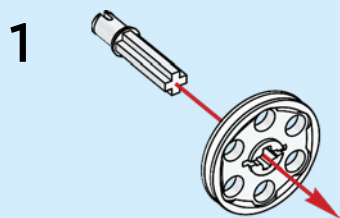

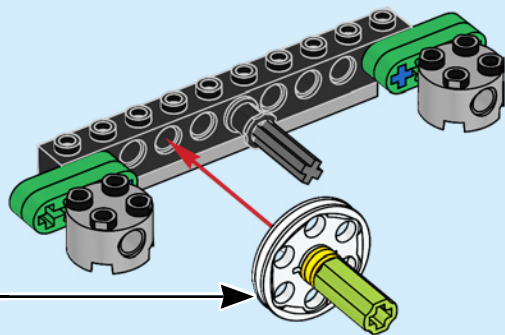

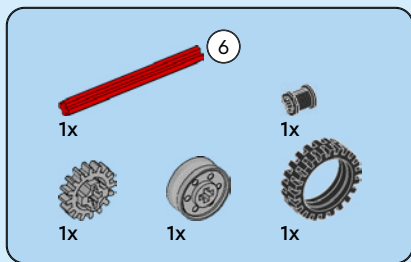

8

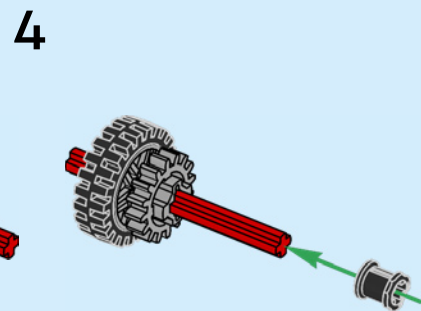
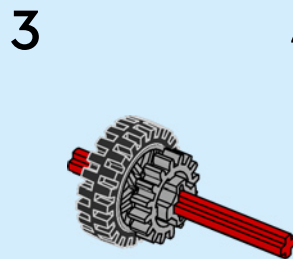
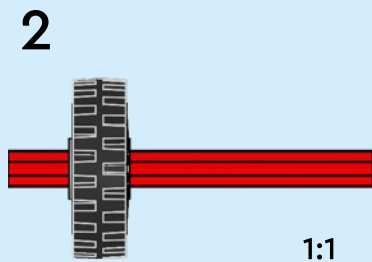
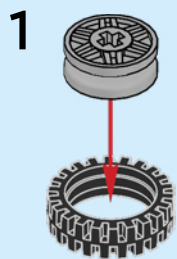

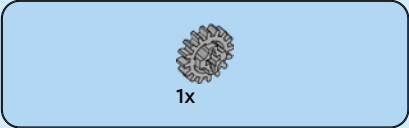

9

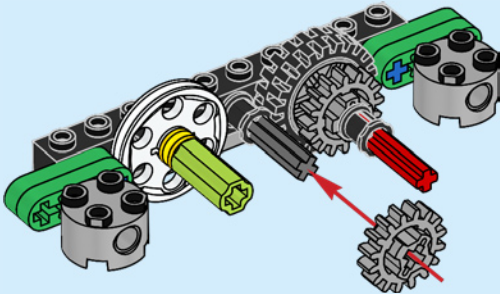
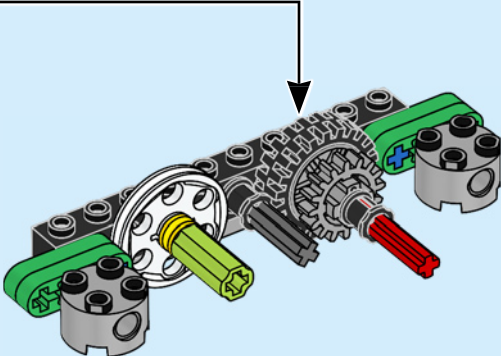

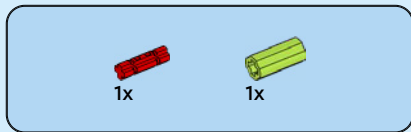

10

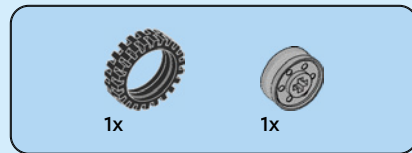
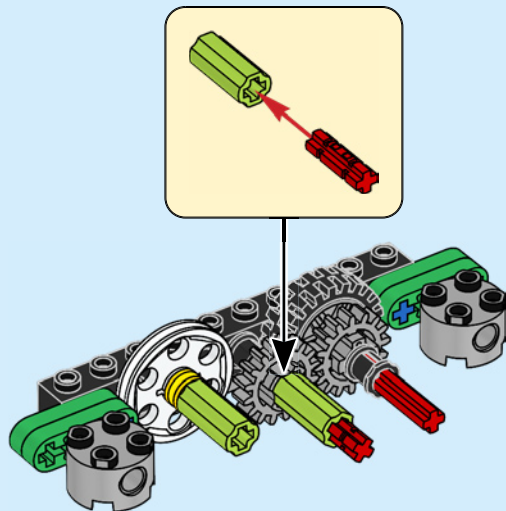

11

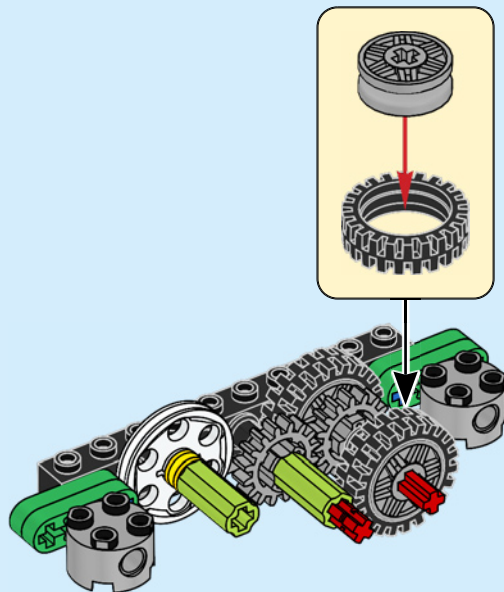

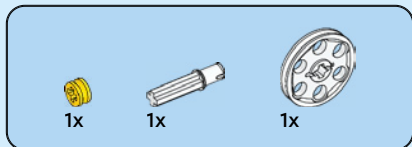

12

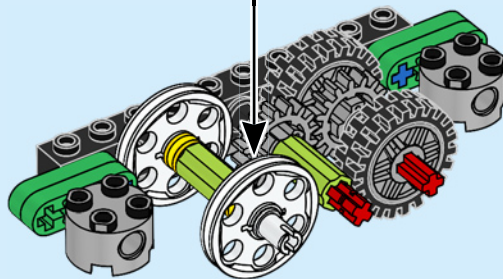
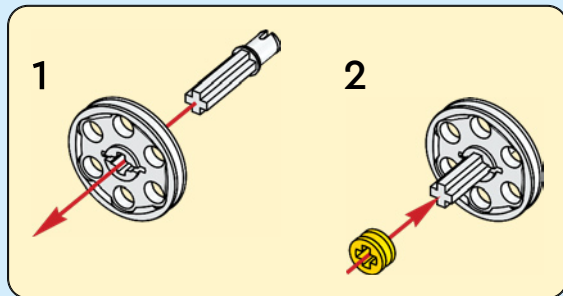

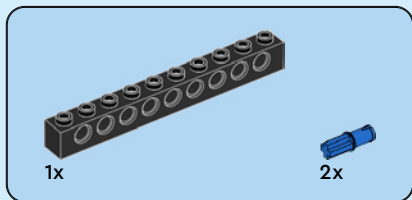
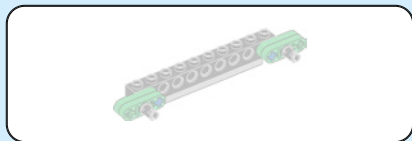

13

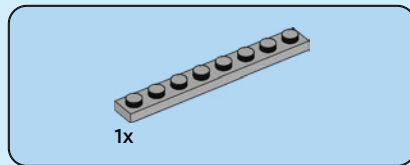
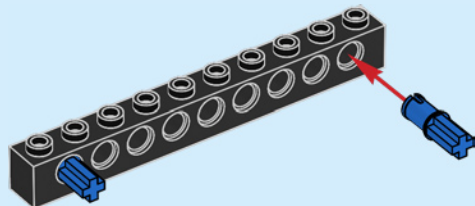

14

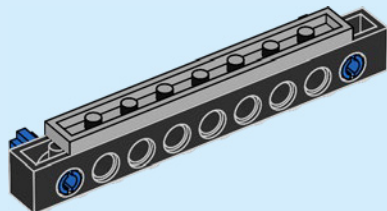
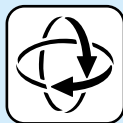

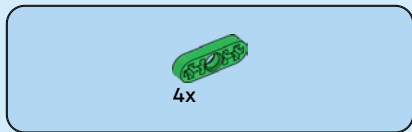

15

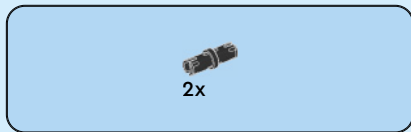
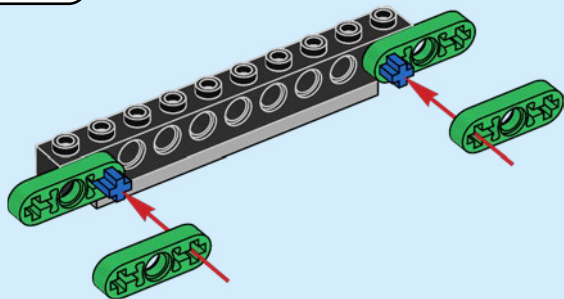

16

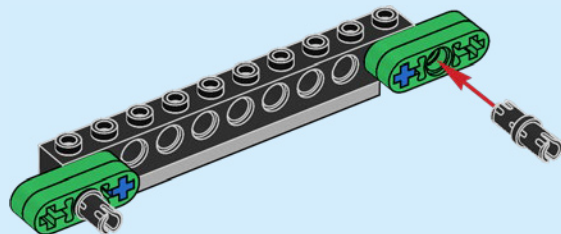

17

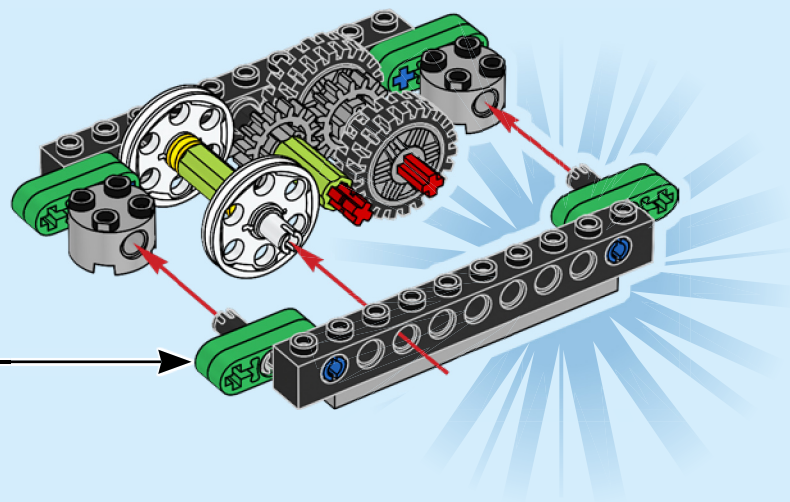



4x

18

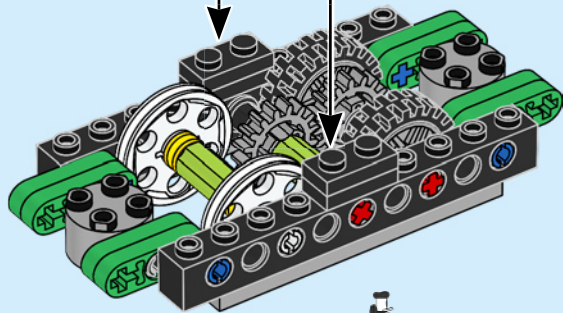
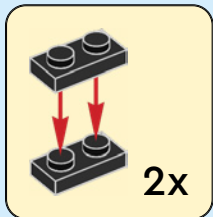

2x



2x

19

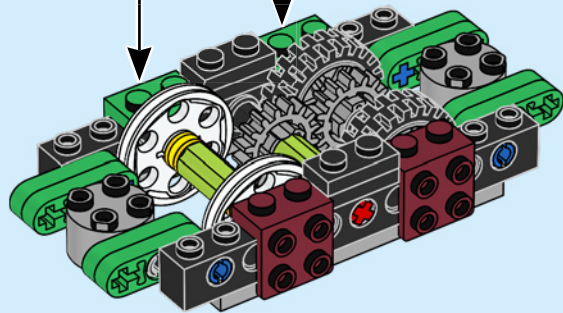
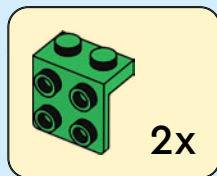

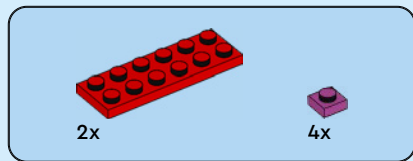

20

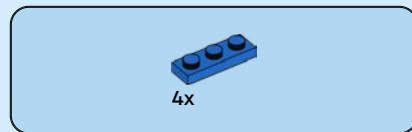
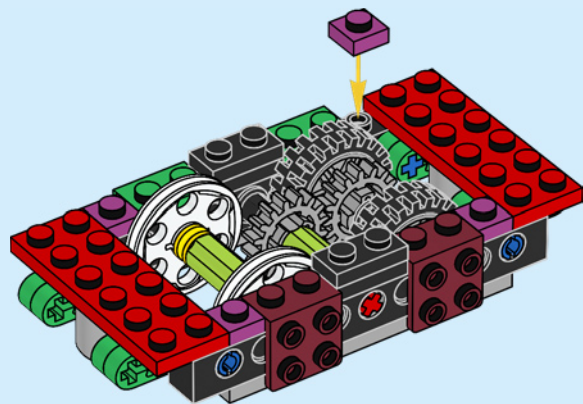

21

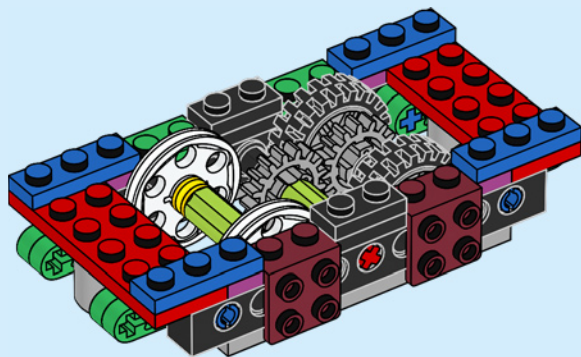



2x



2x



2x



2x

22

1

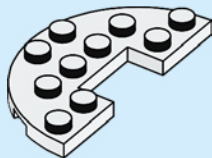

2

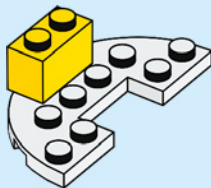

3

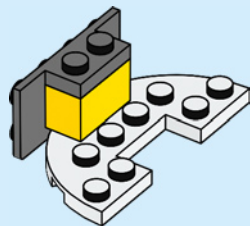

2x



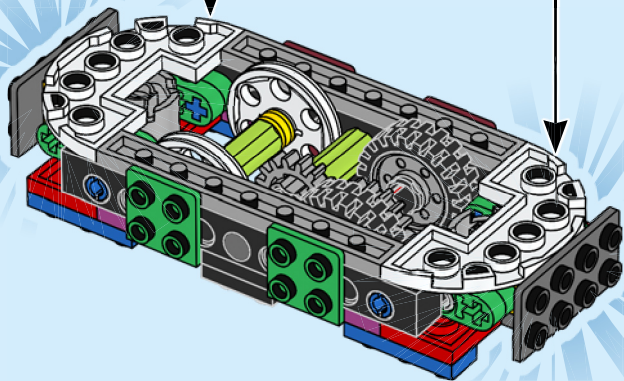
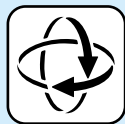



2x

23

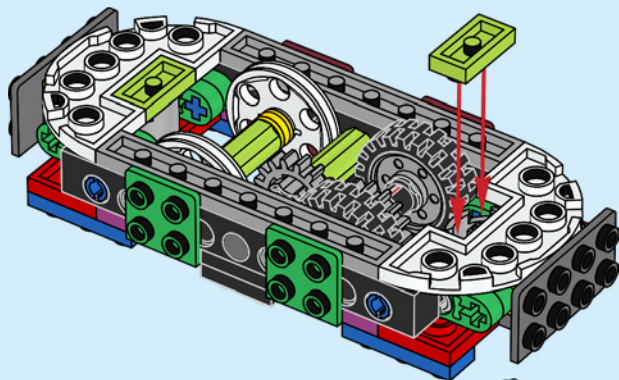

4x

24

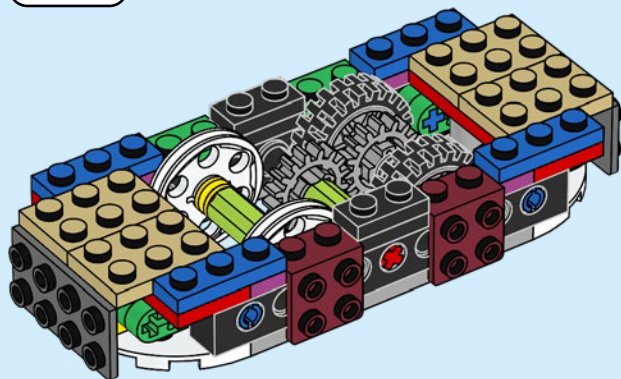



2x



2x

25

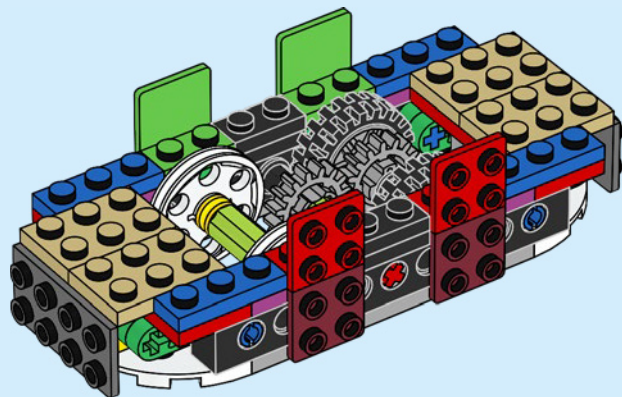

4x

26

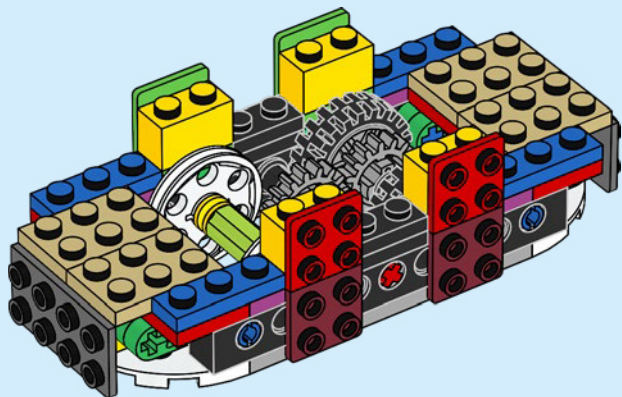

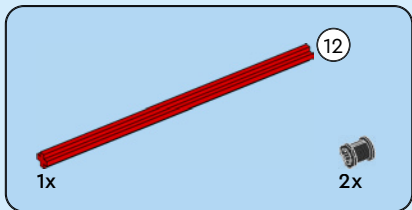
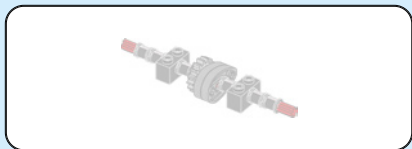

27



1:1

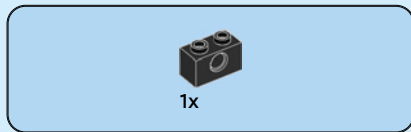

28

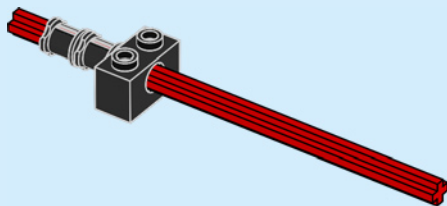



1x

29

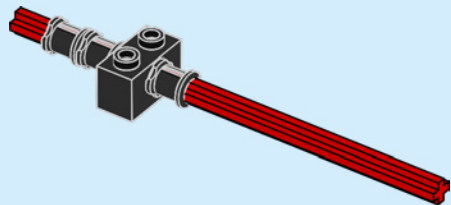

1x

30

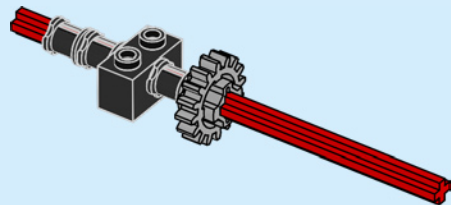



2x

31

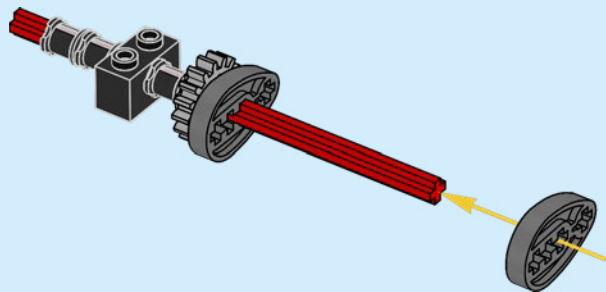
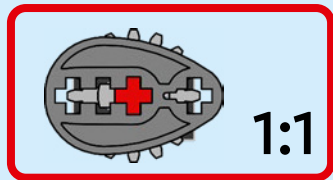

1x

32

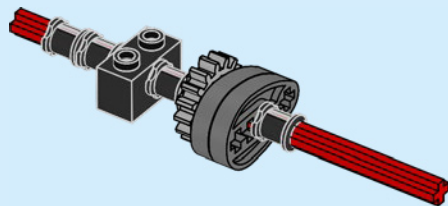



1x

33

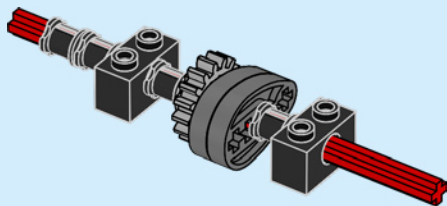

2x

34

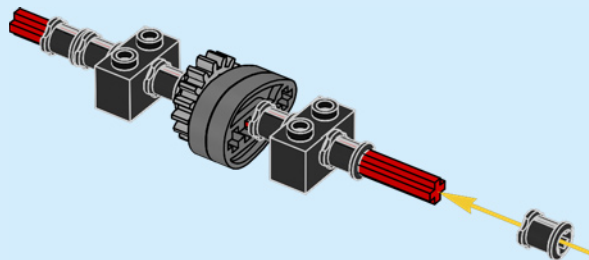

35

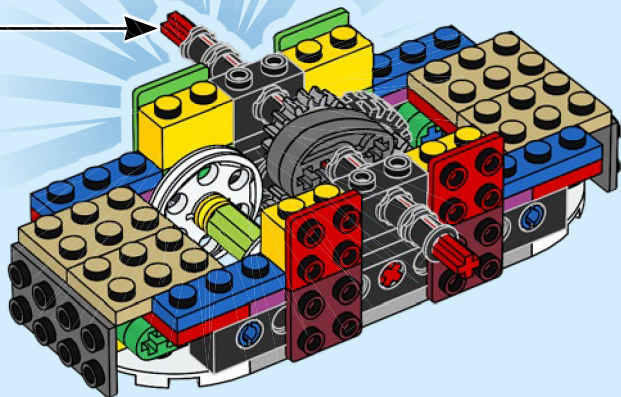



4x

38

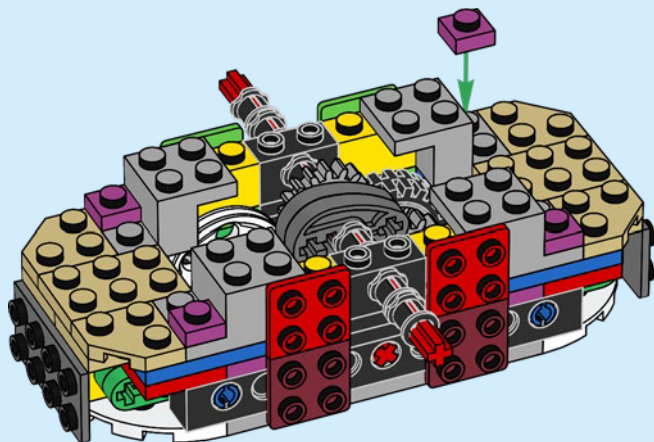



4x

39

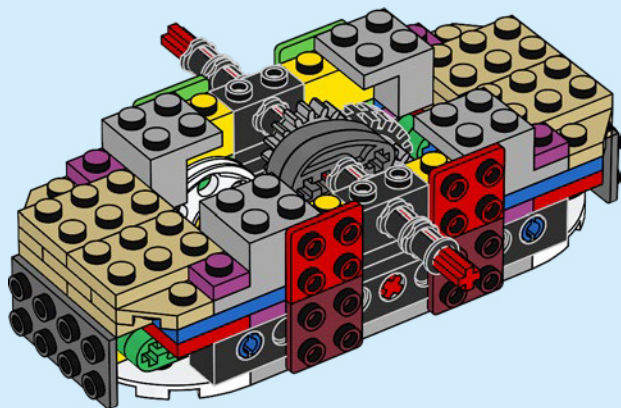

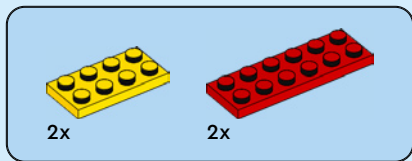

40

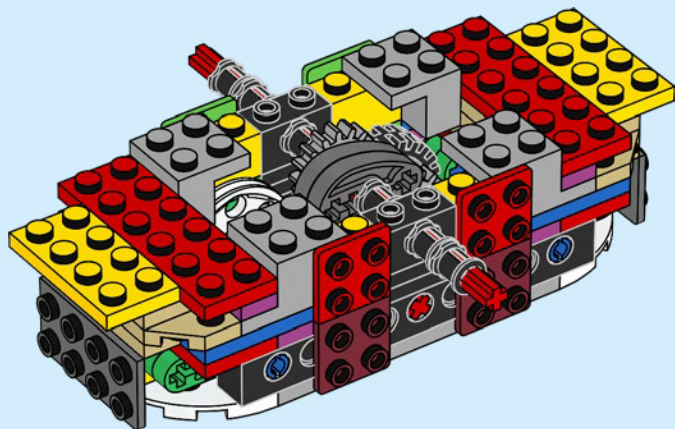

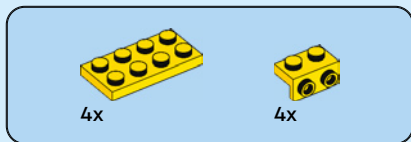

41

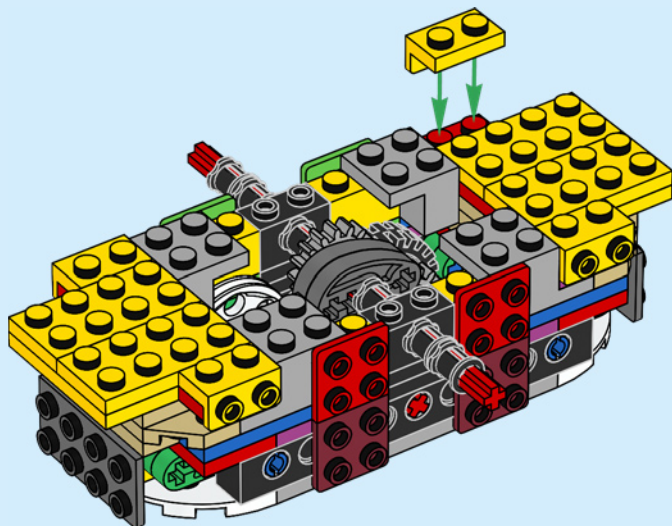

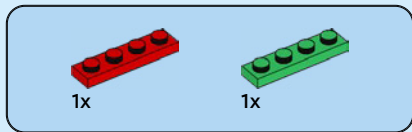

42

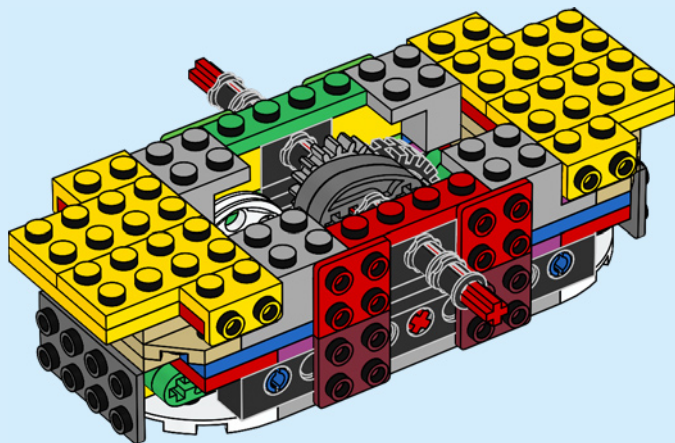



2x



1x



1x

43

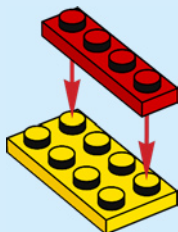

2x

44

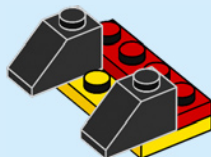

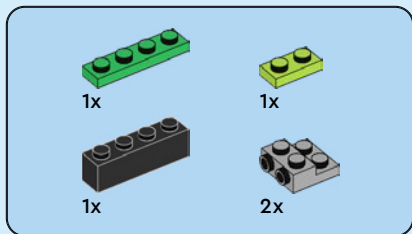

45

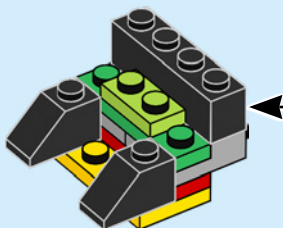
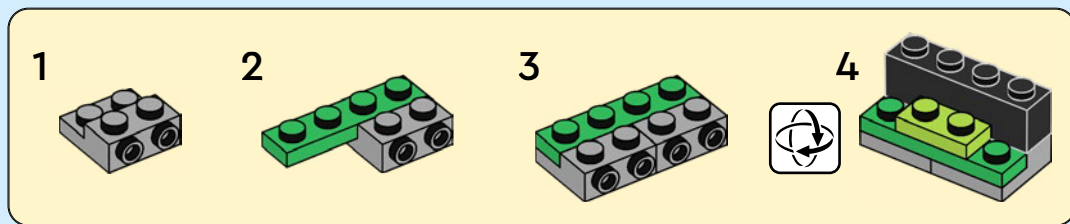



2x

46

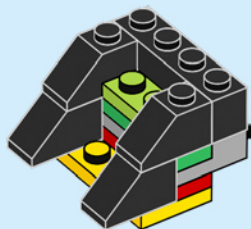

1x

47

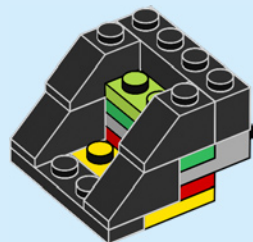



2x

48

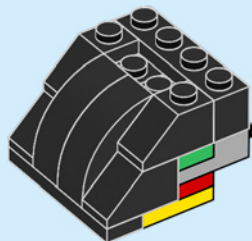

1x

49

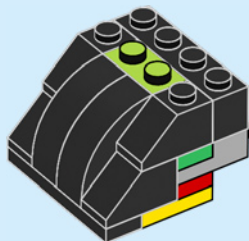



1x

50

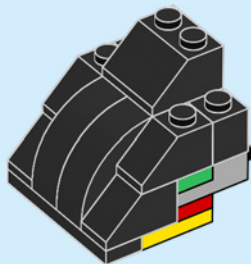

2x

51

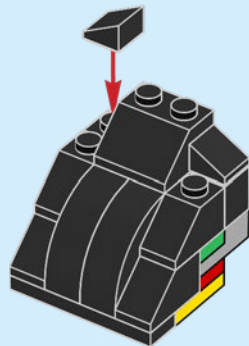

2x

52

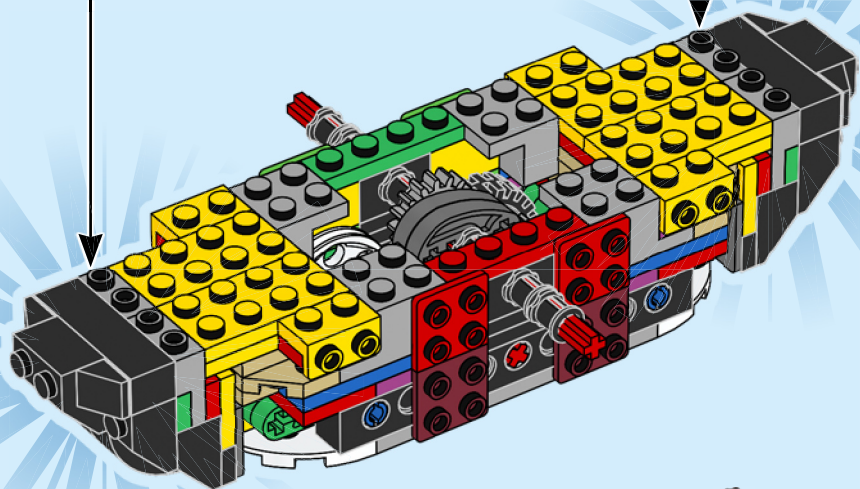



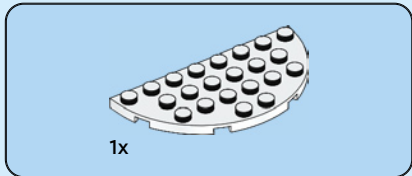
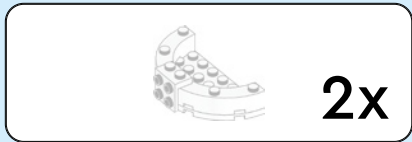

53

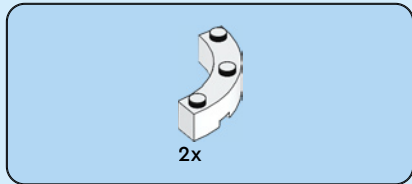
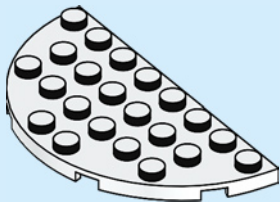

54

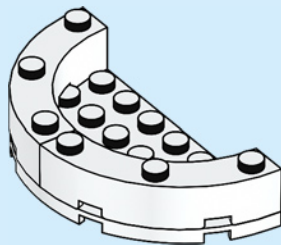



1x

55

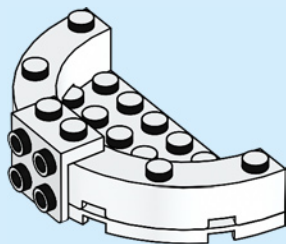

2x

56

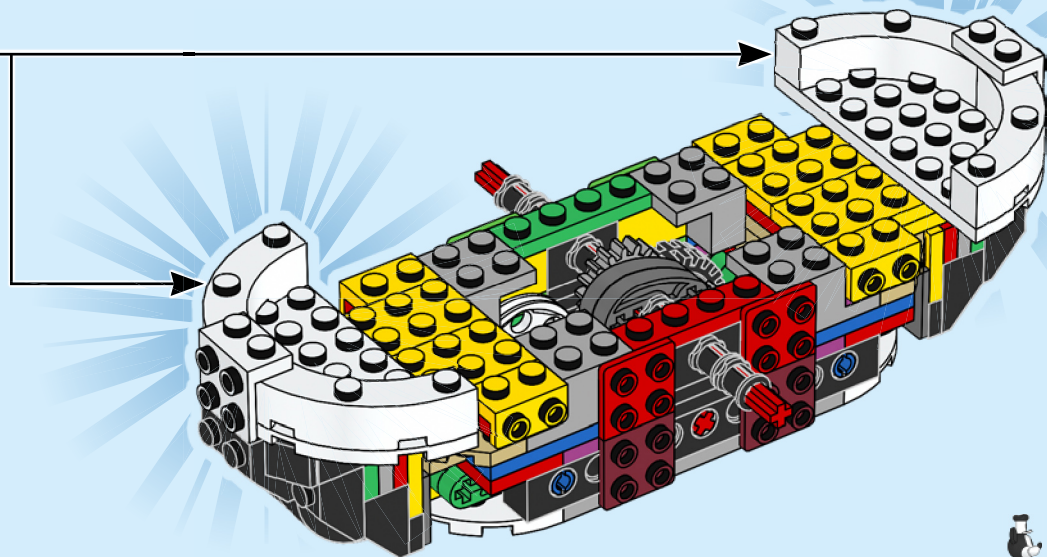

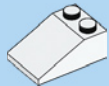

2x

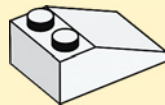

2x

57

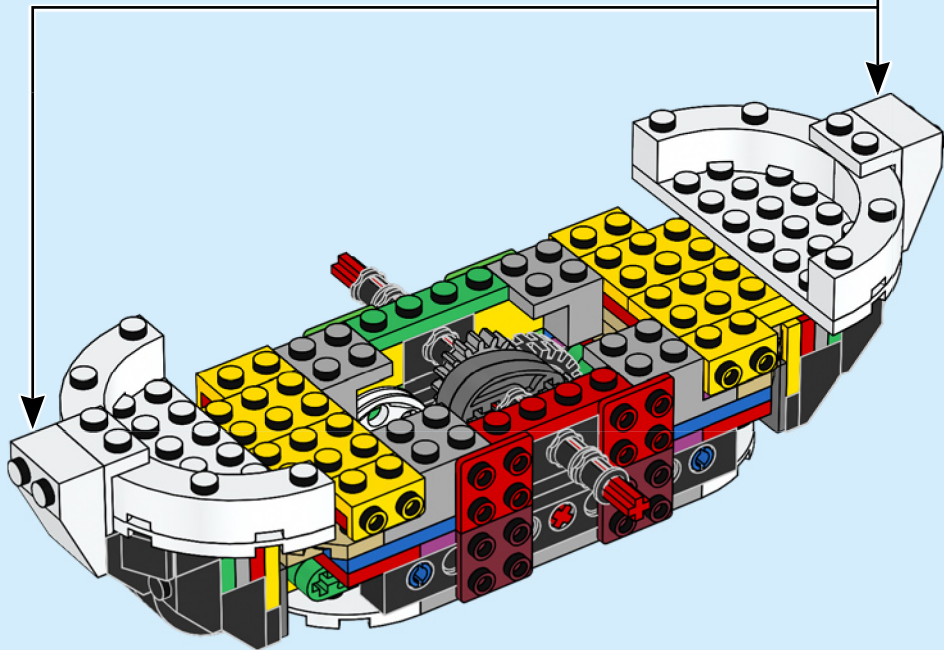



1x



1x

58

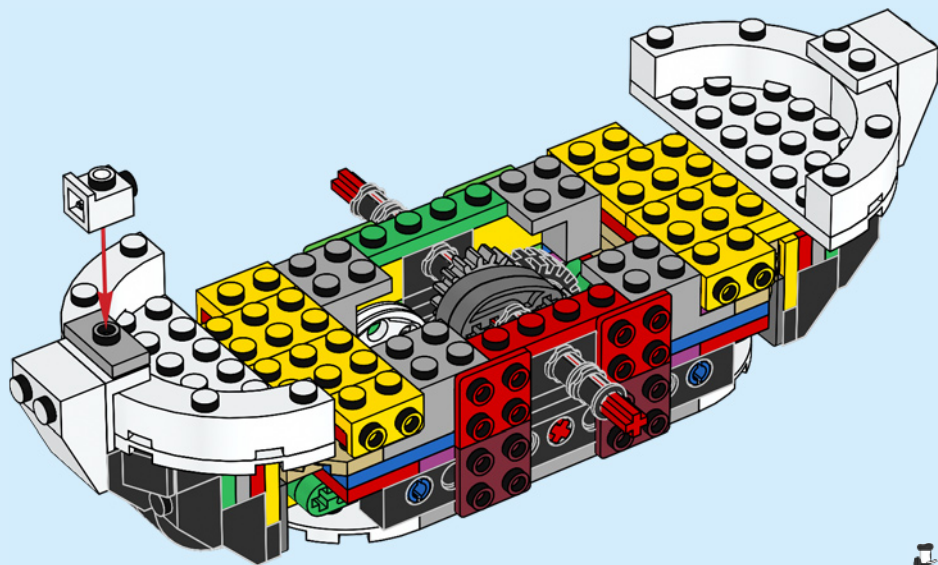

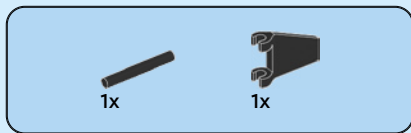

59

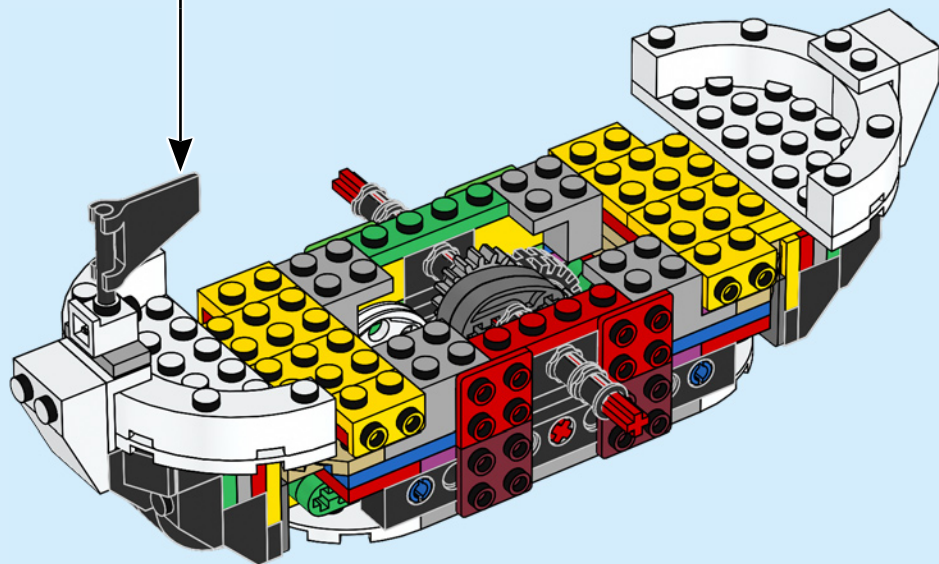
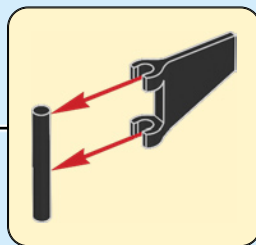

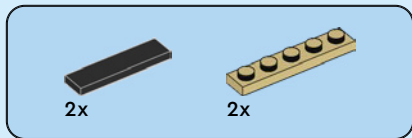

60

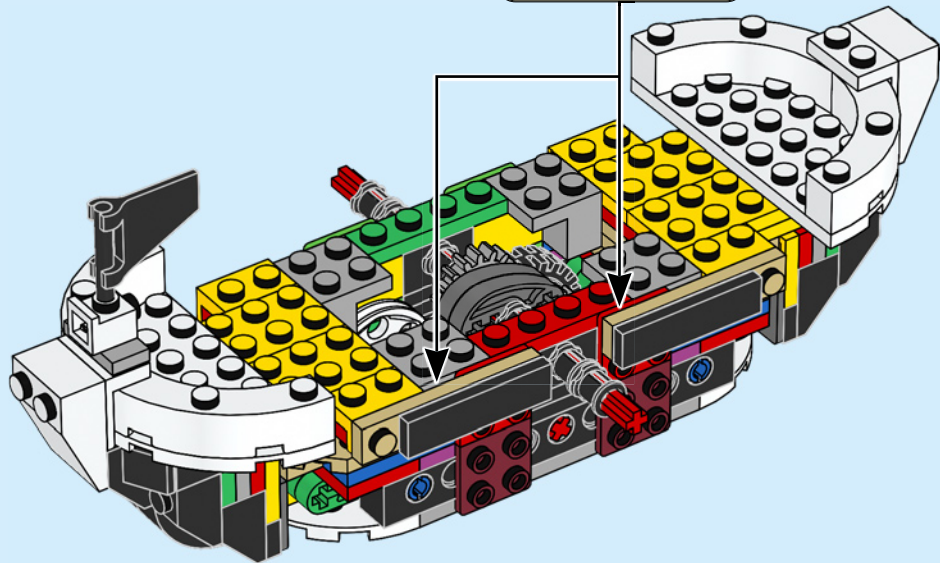
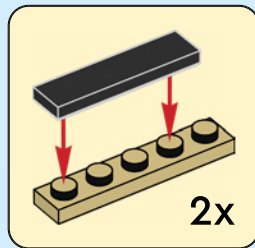

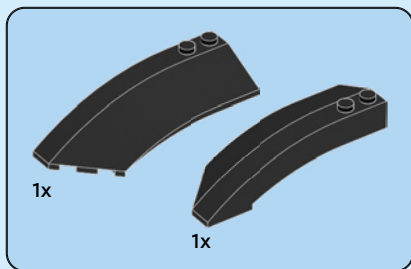

61

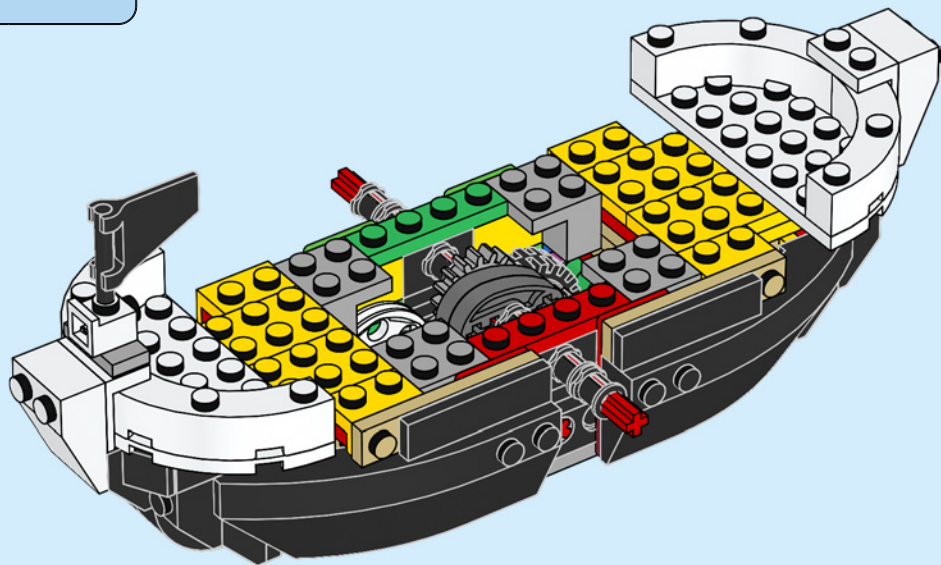

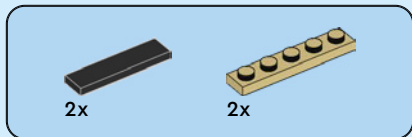

62

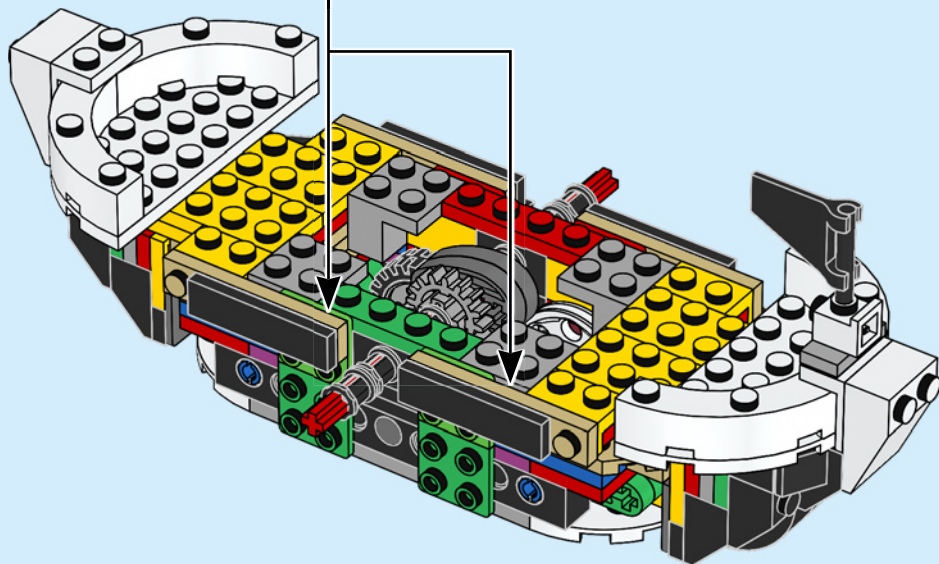
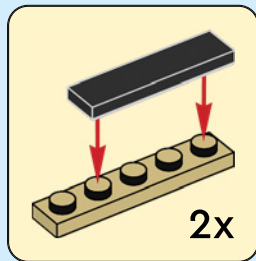

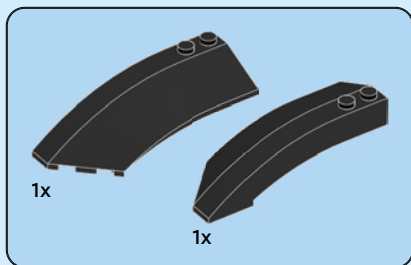

63

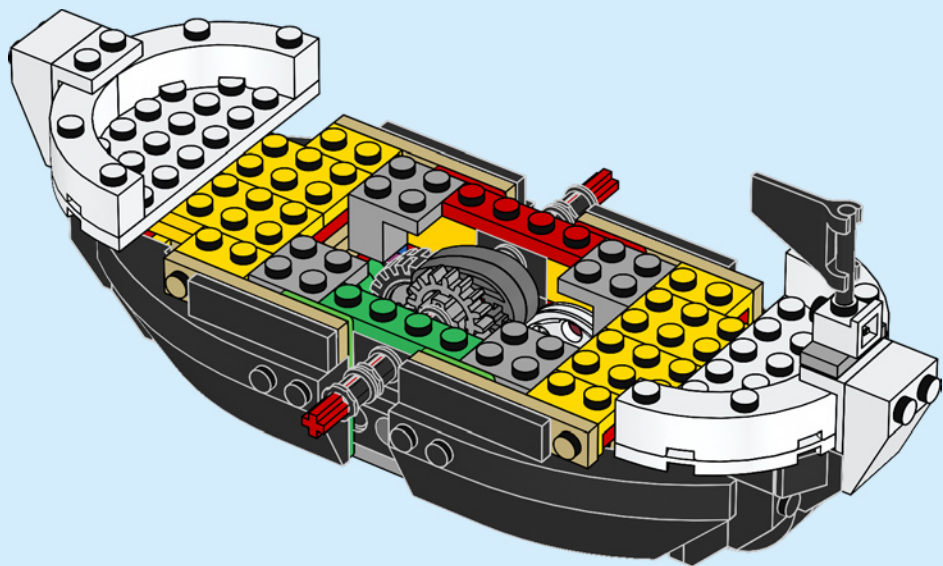



2x



2x



2x



2x



2x



2x

64

1



2

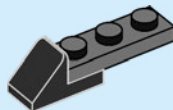

3

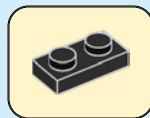
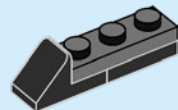

4

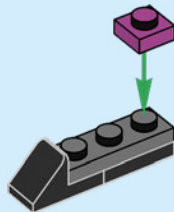

5

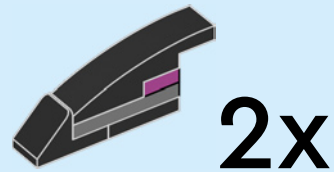

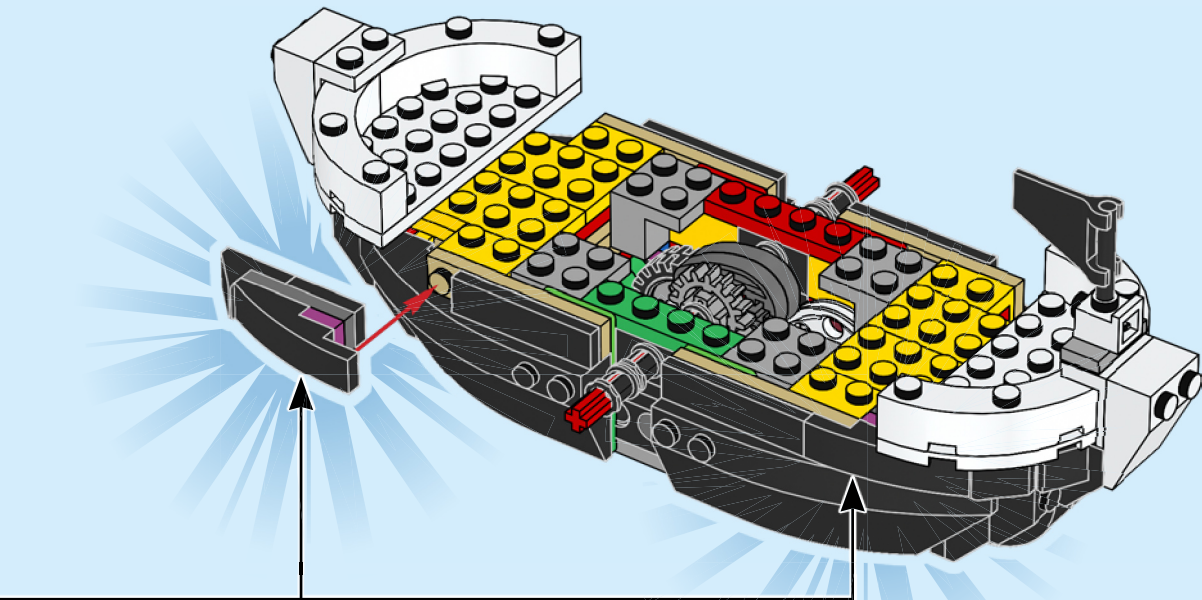

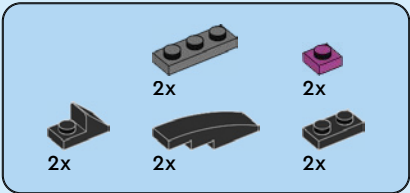

65

1



2

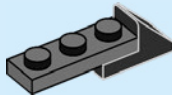

3

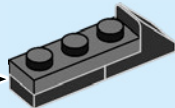
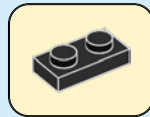

4

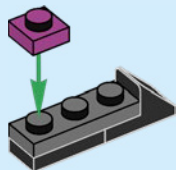

5

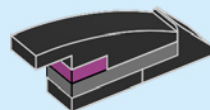

2x

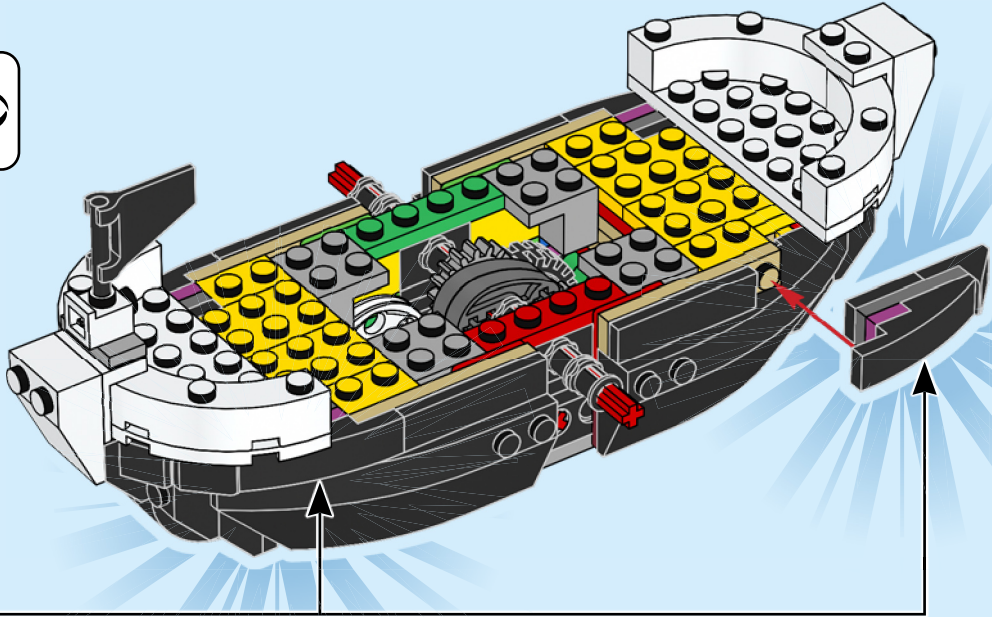



2x



16x



2x



2x



16x



32x



4x



2x

66

1

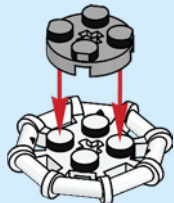

2

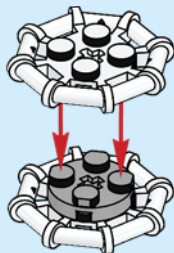

3

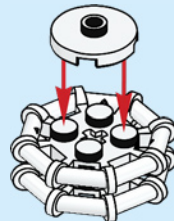

4

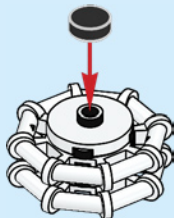

5

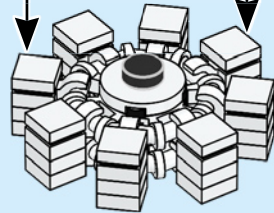
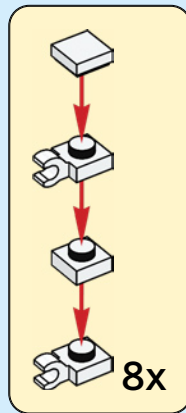

2x



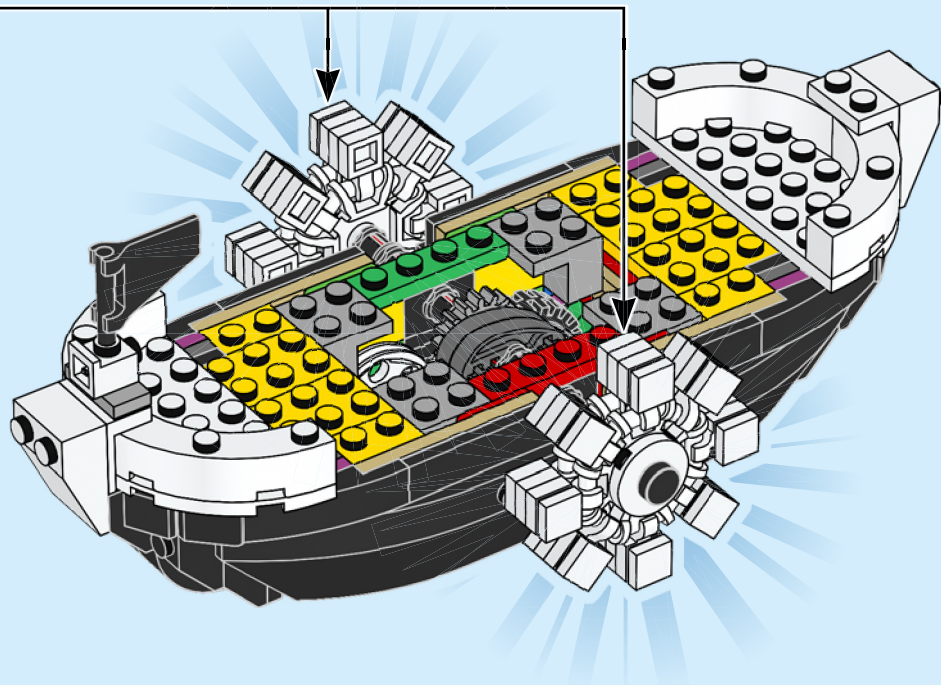



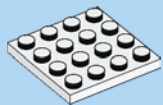

4x

67

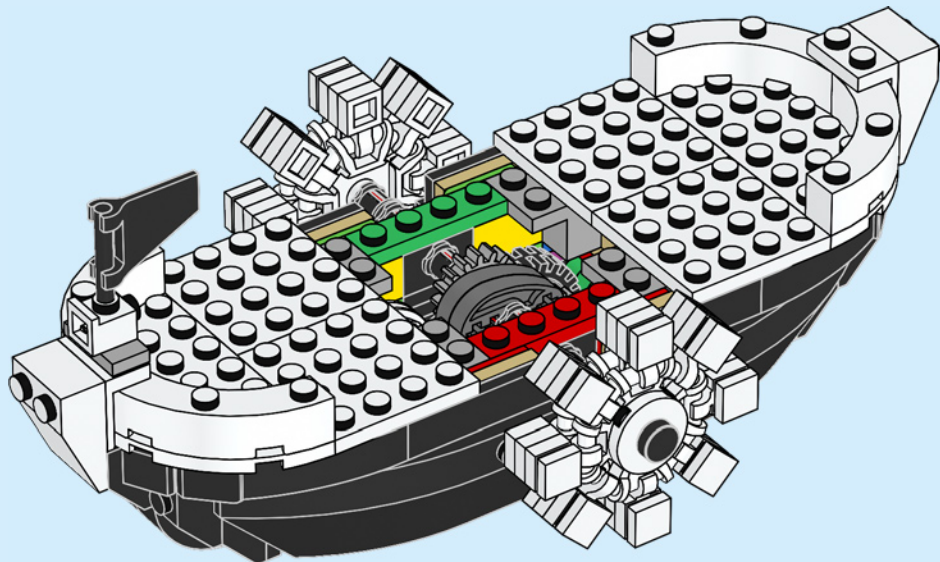



6x

68

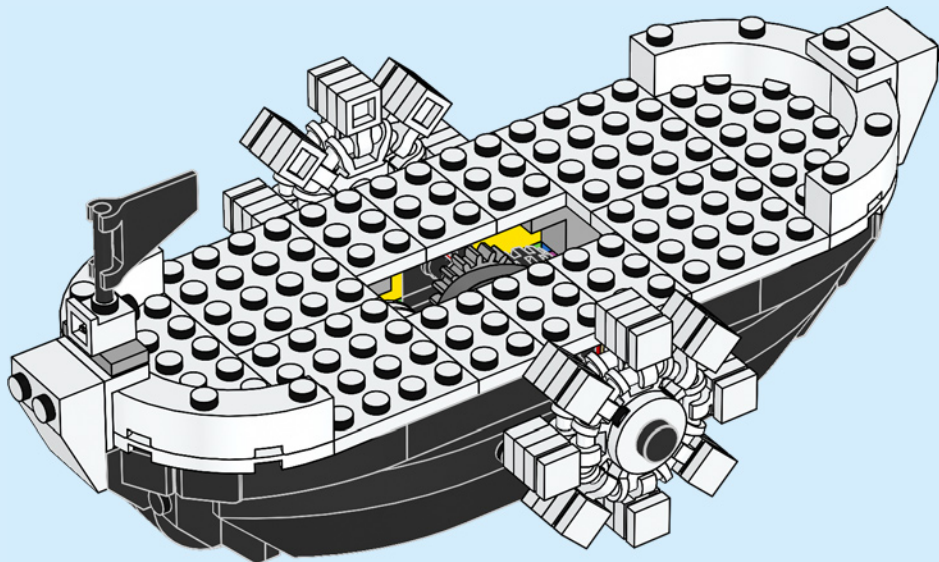



1x



1x

69

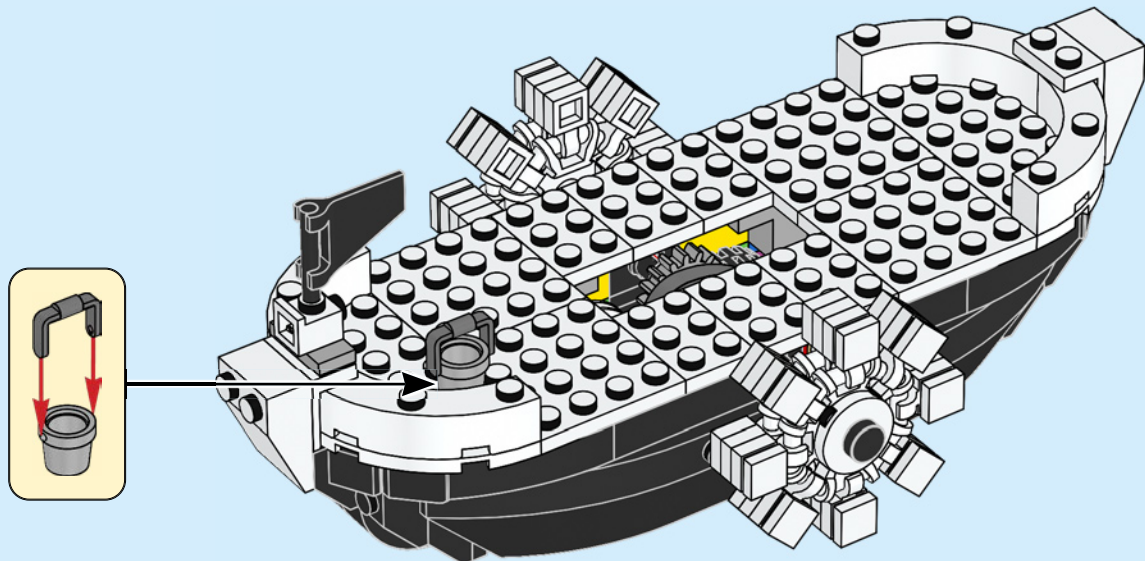



4x



4x

70



4x

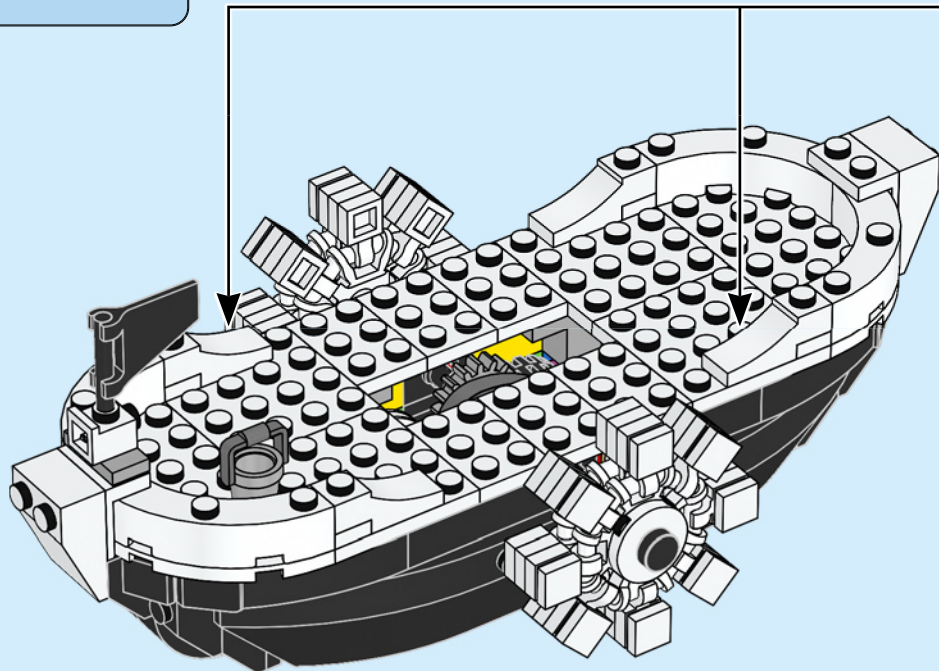

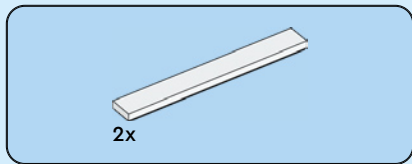

71

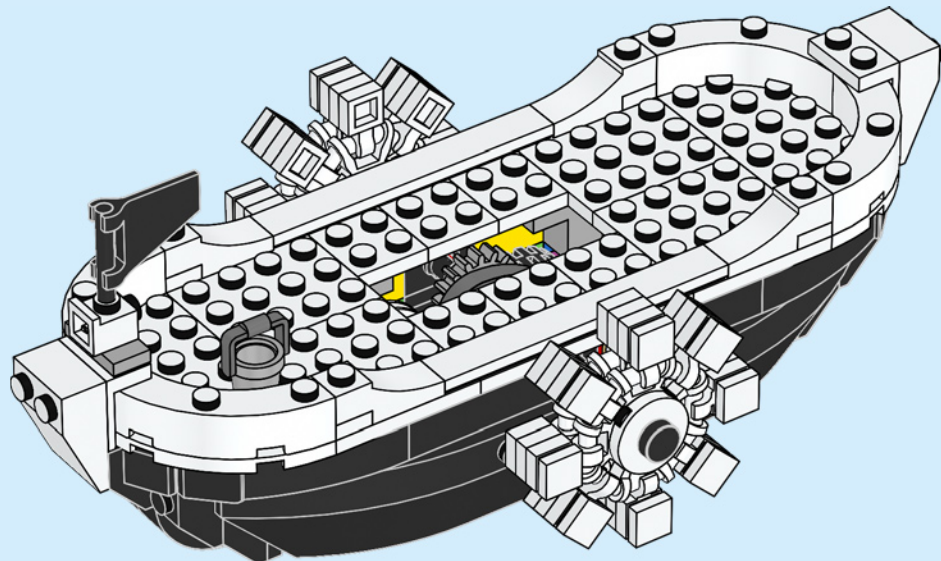



2x

72

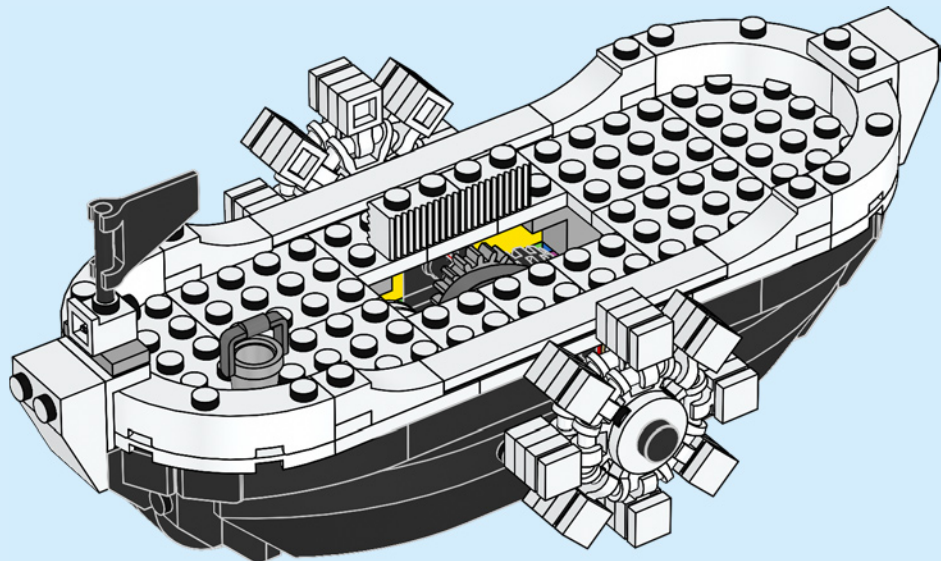



2x



4x



2x



2x



4x

73

1



2

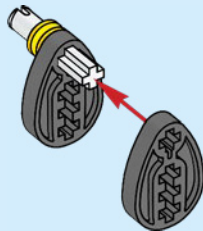

3



4

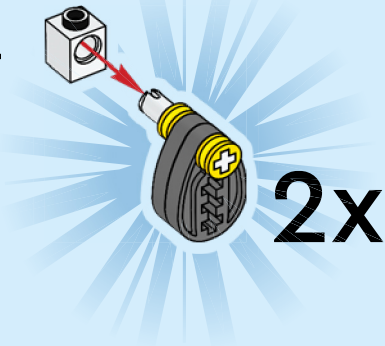

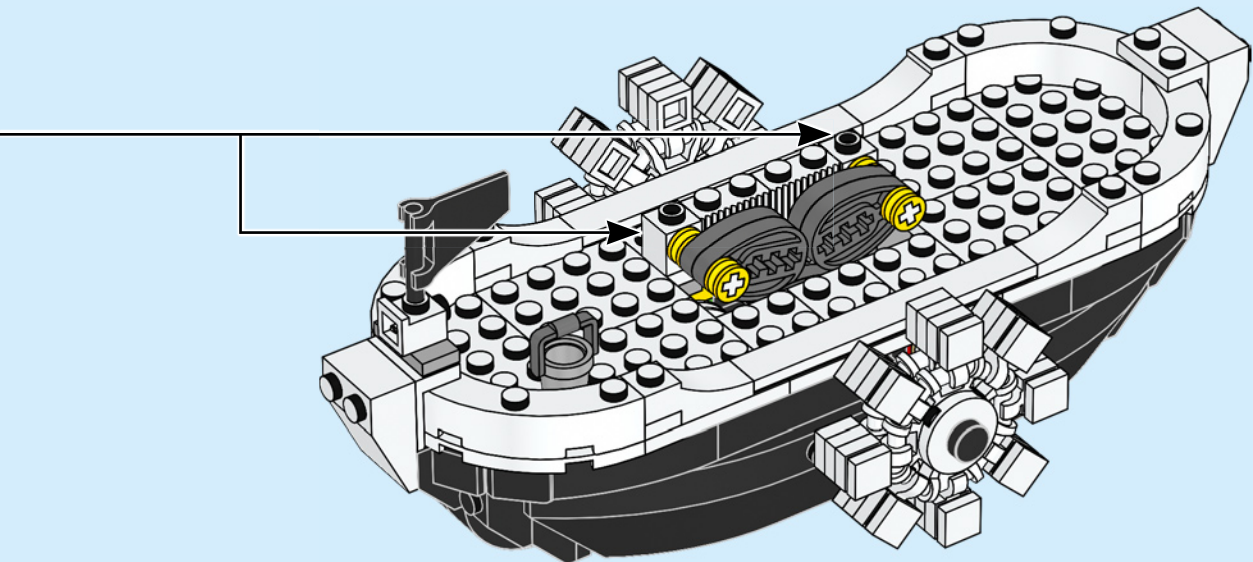



2x

74

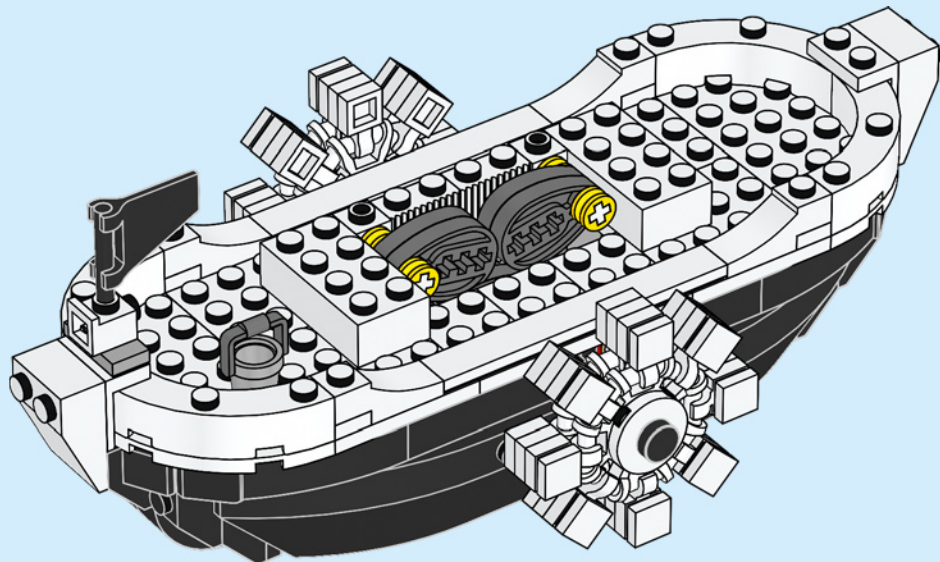



1x



1x

75

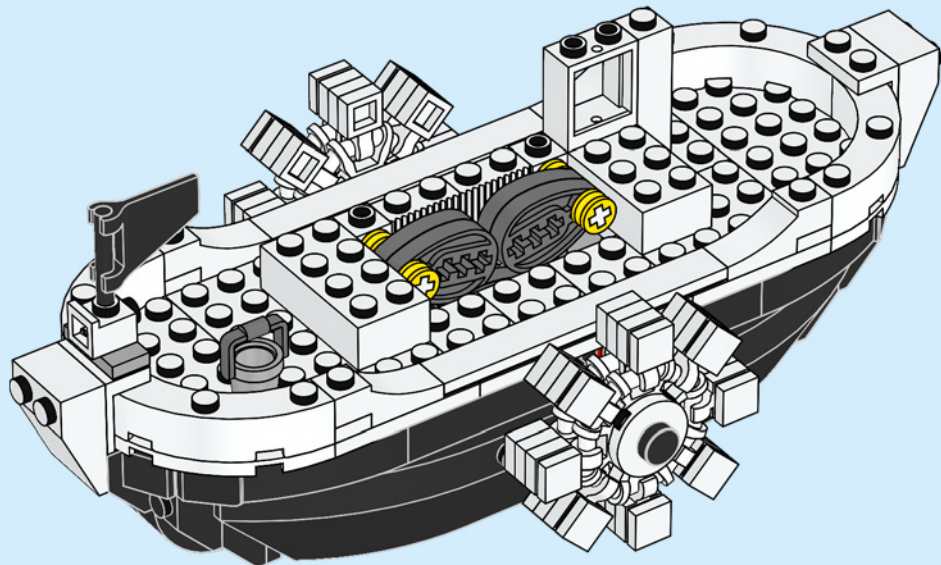

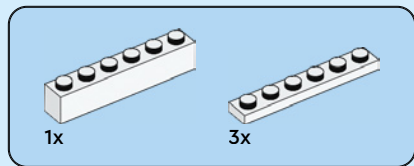

76

1

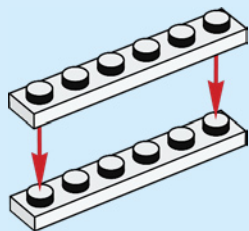

2

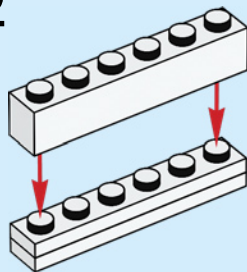

3

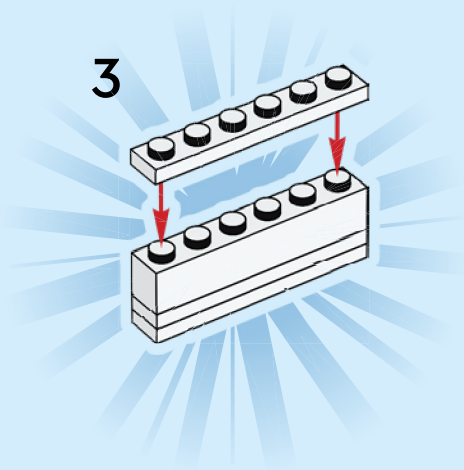

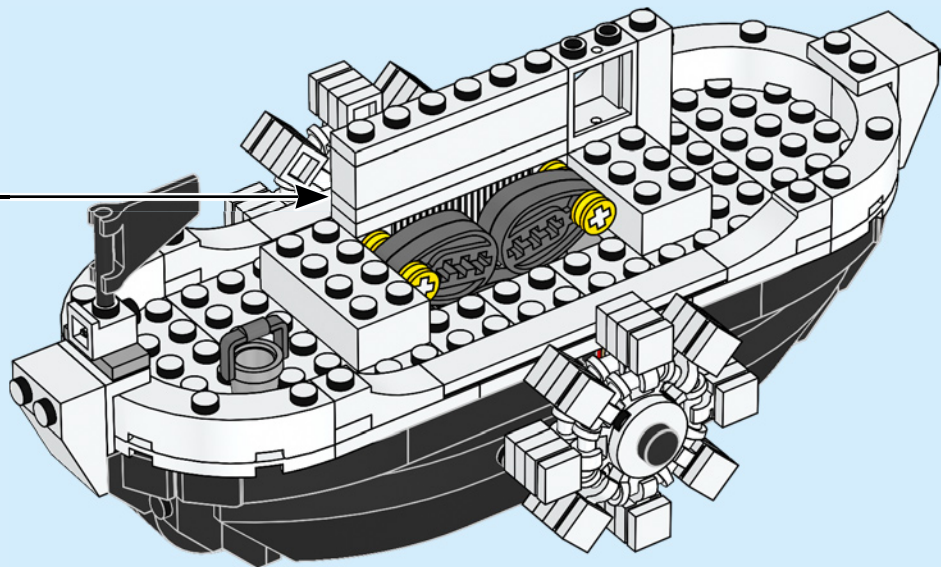

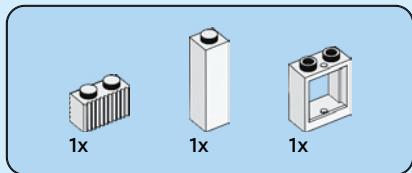

77

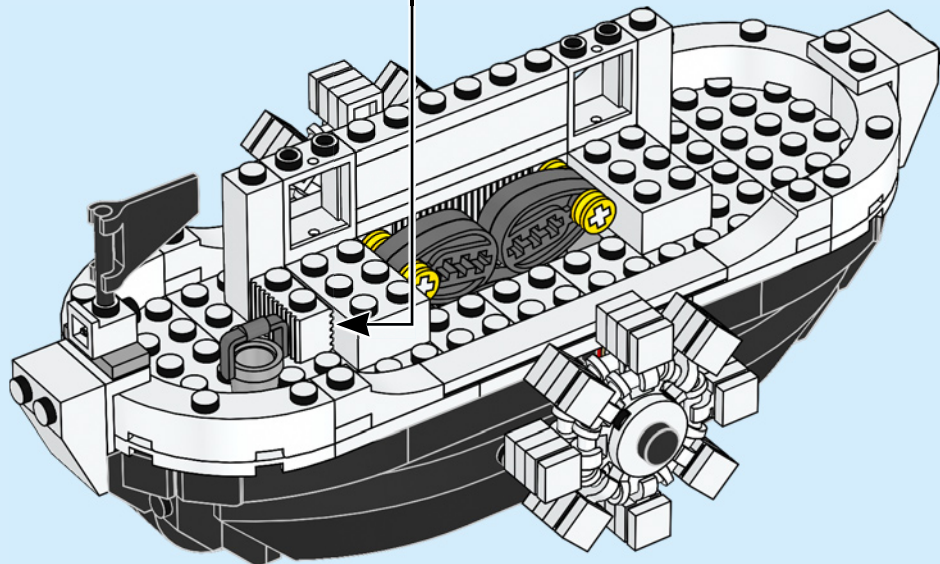
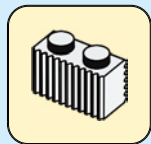



1x



1x

78

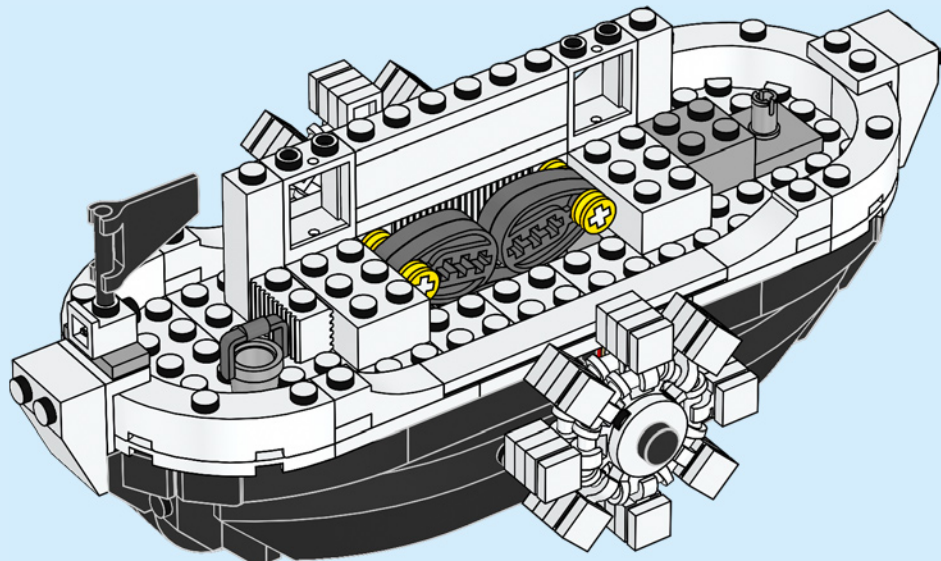



4x

79

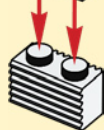
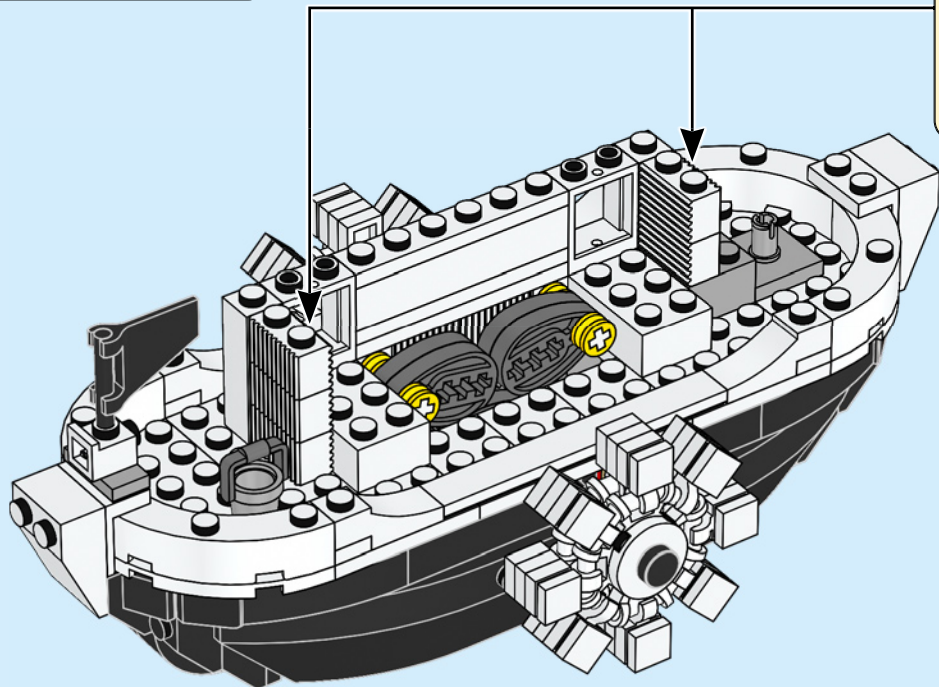

2x

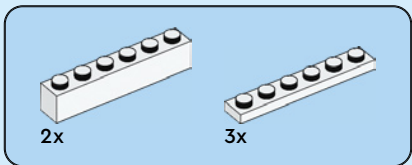

80

1

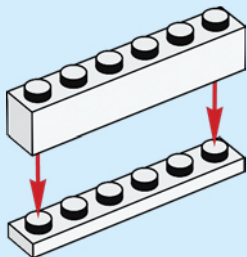

2

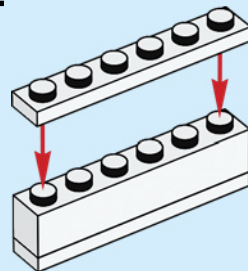

3

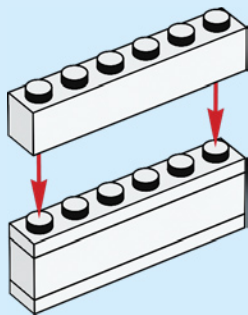

4

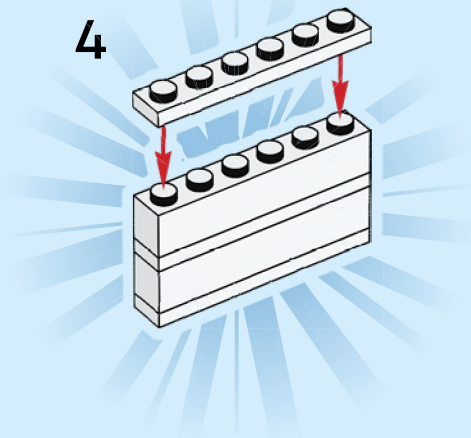

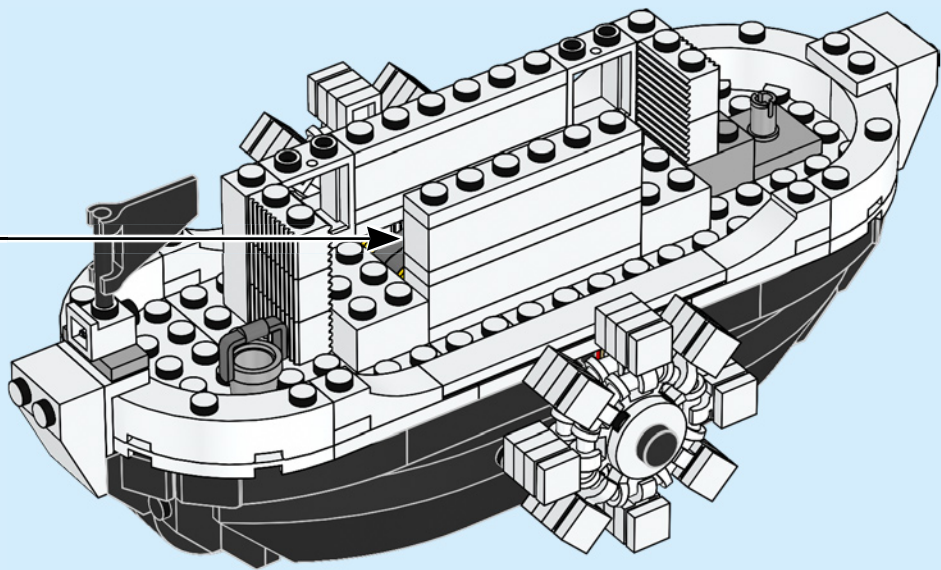



2x



2x

81

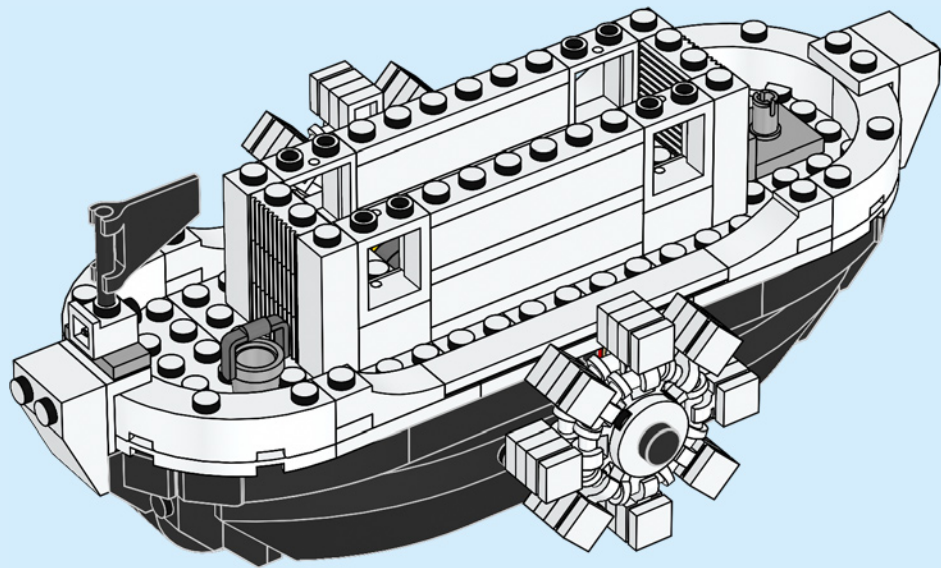

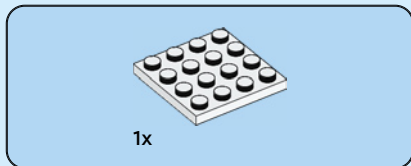
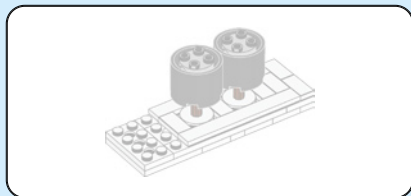

82

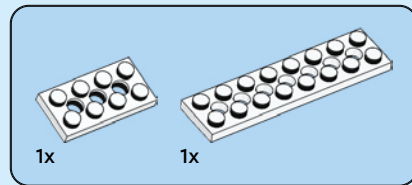
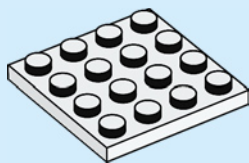

83

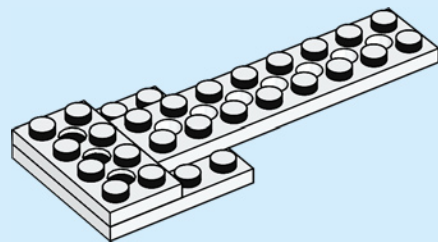

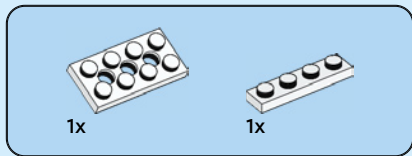

84

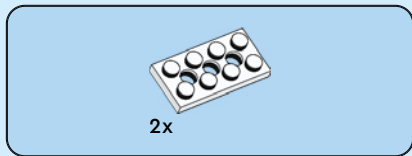
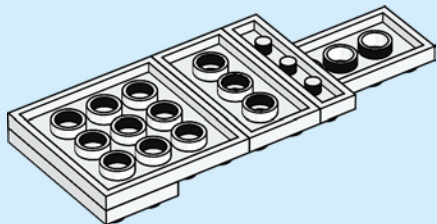

85

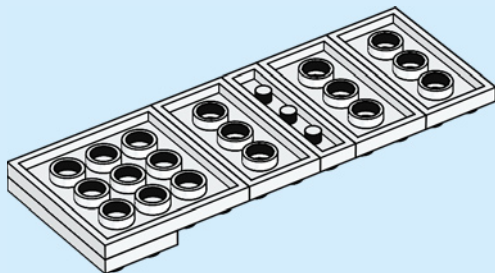

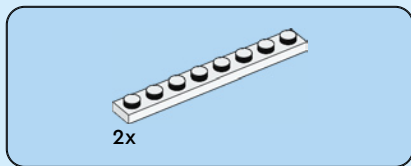

86

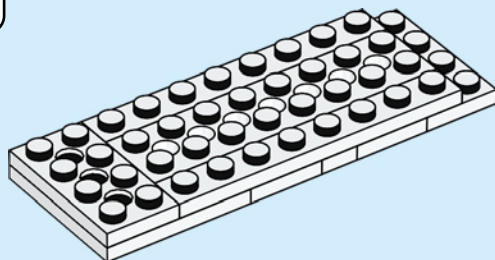

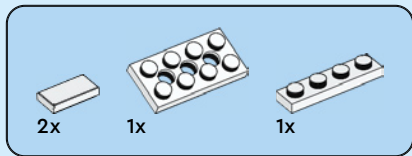

87

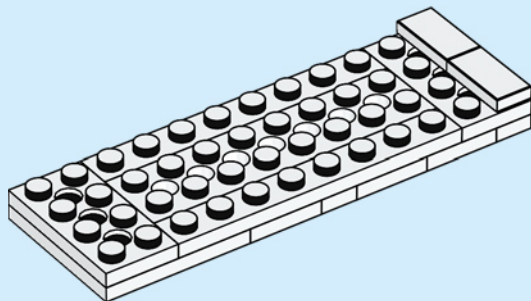
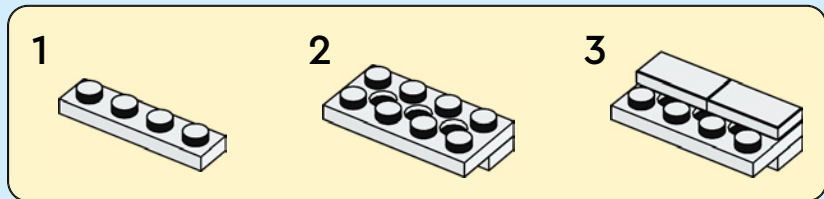

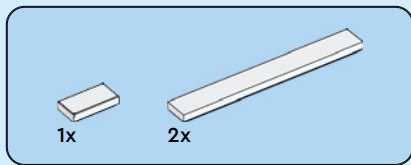

88

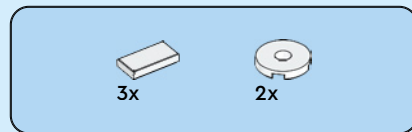
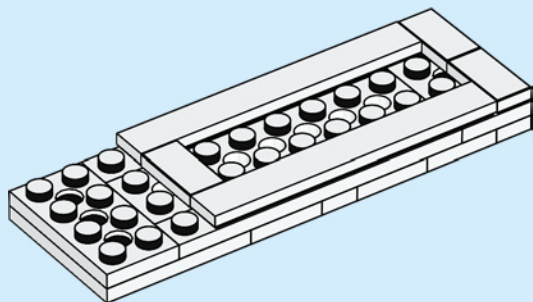

89

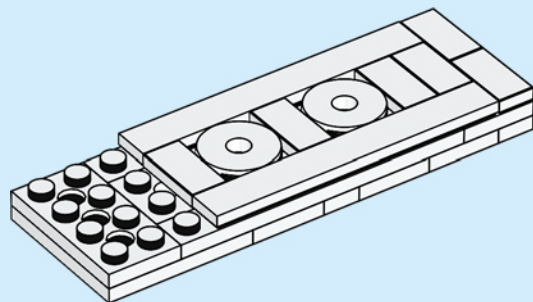

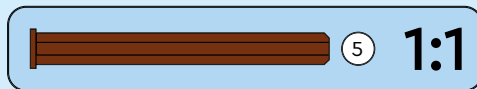
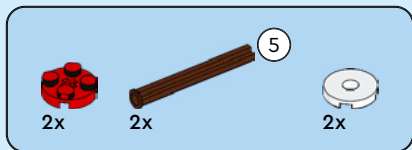

90

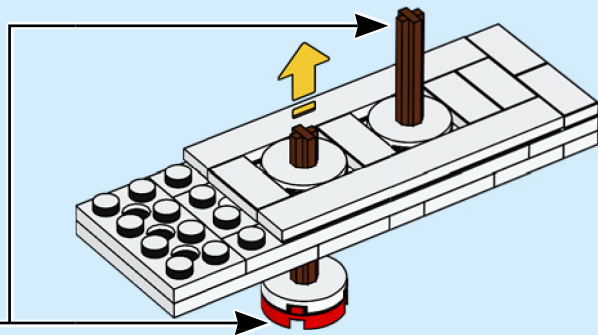
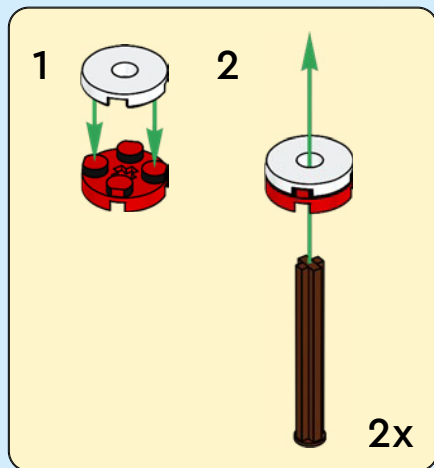

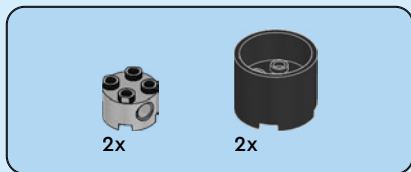

91

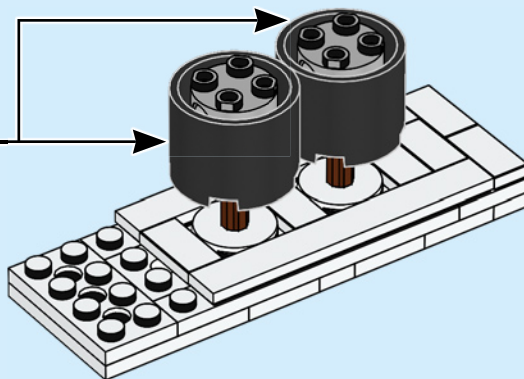
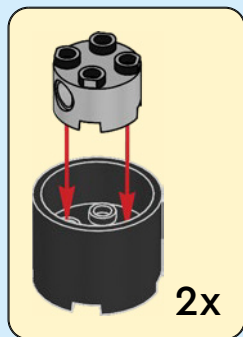

92

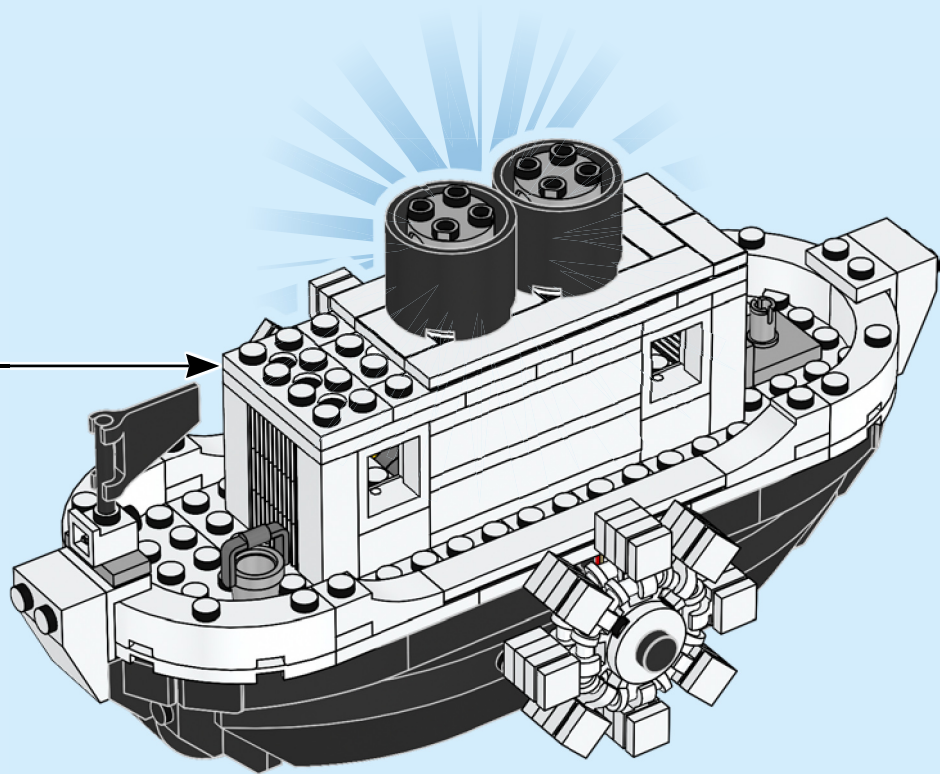



1x



1x

93

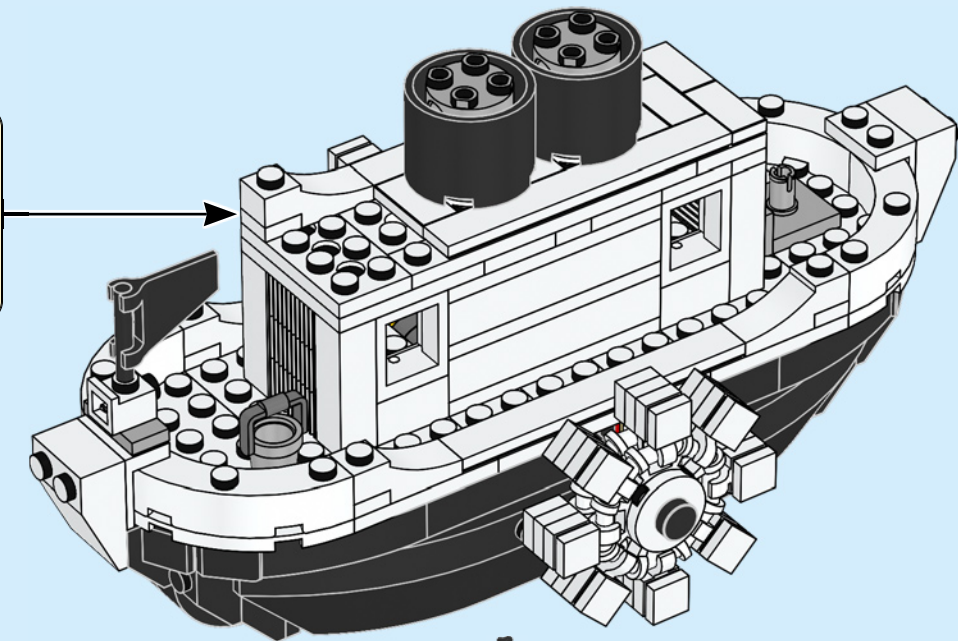
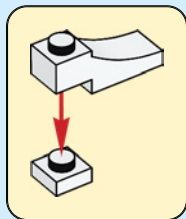



2x

94

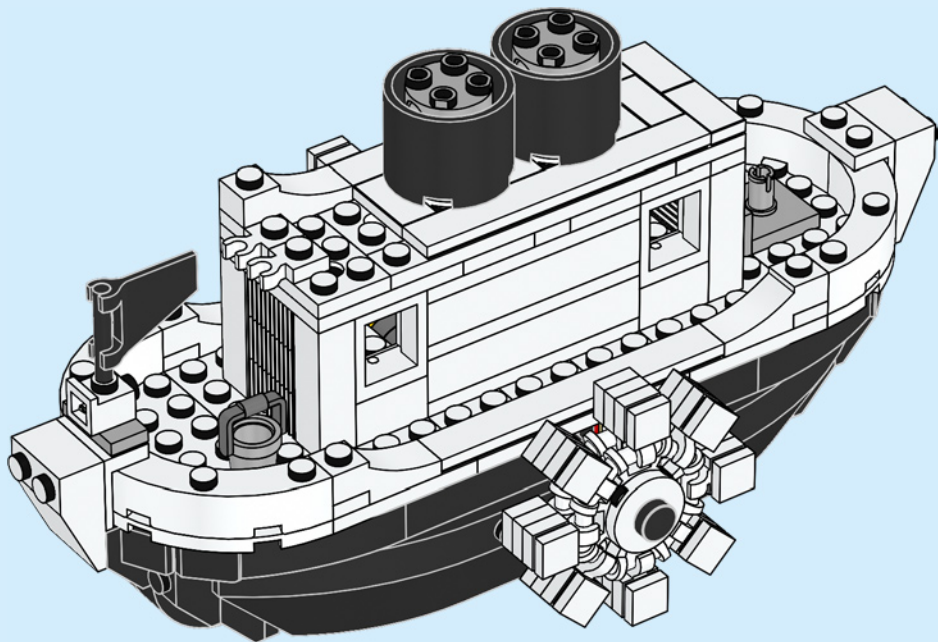

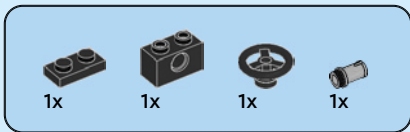

95

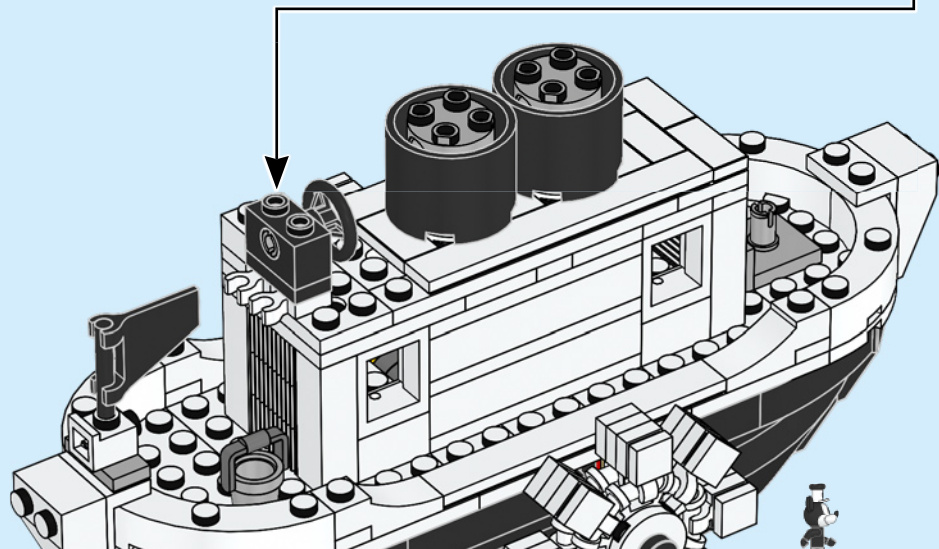
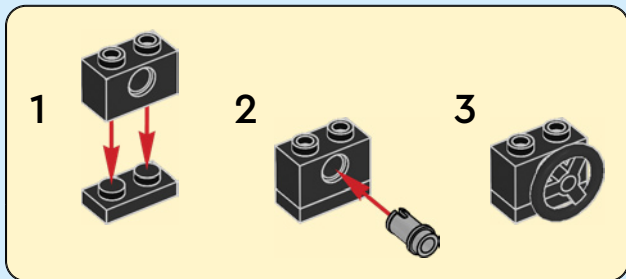



1x



1x

96

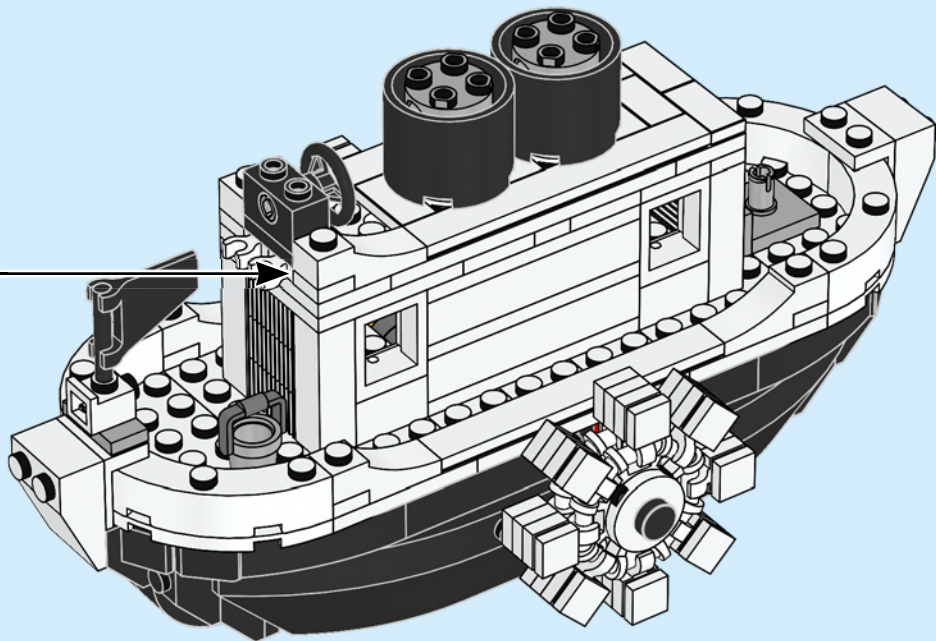
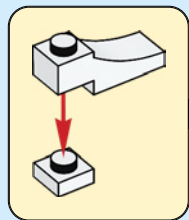



2x

97

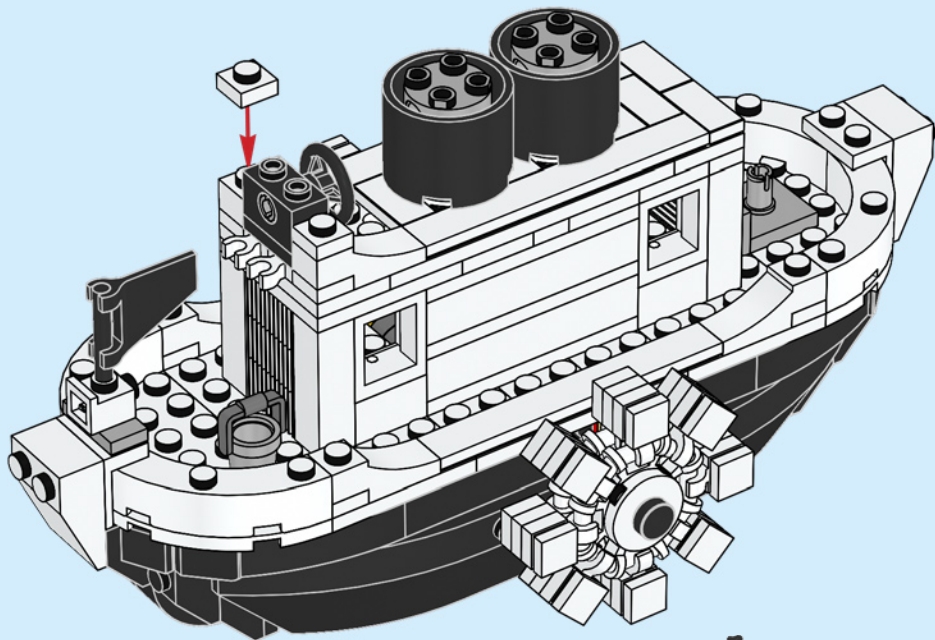



1x

98

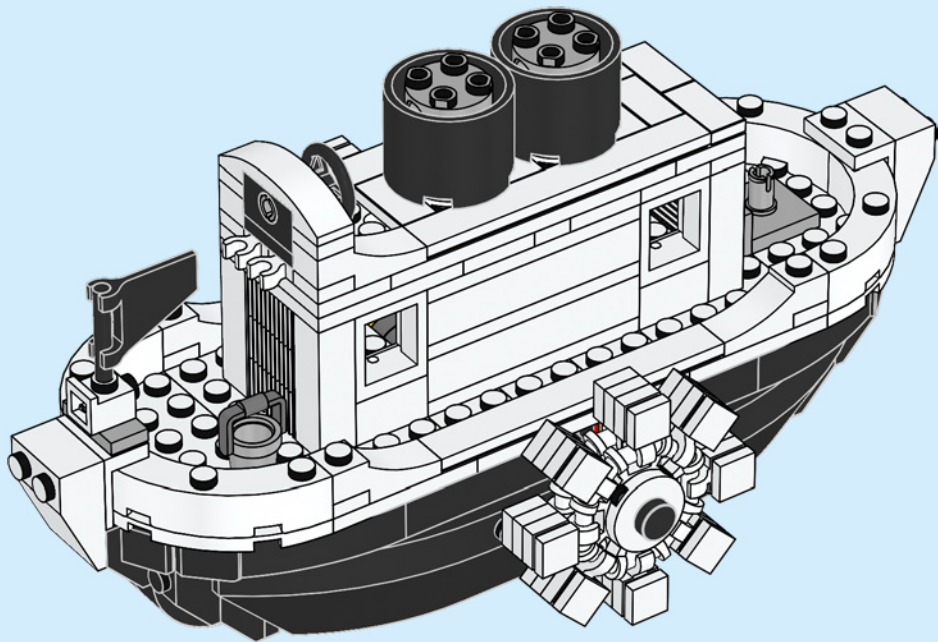



2x



2x

99

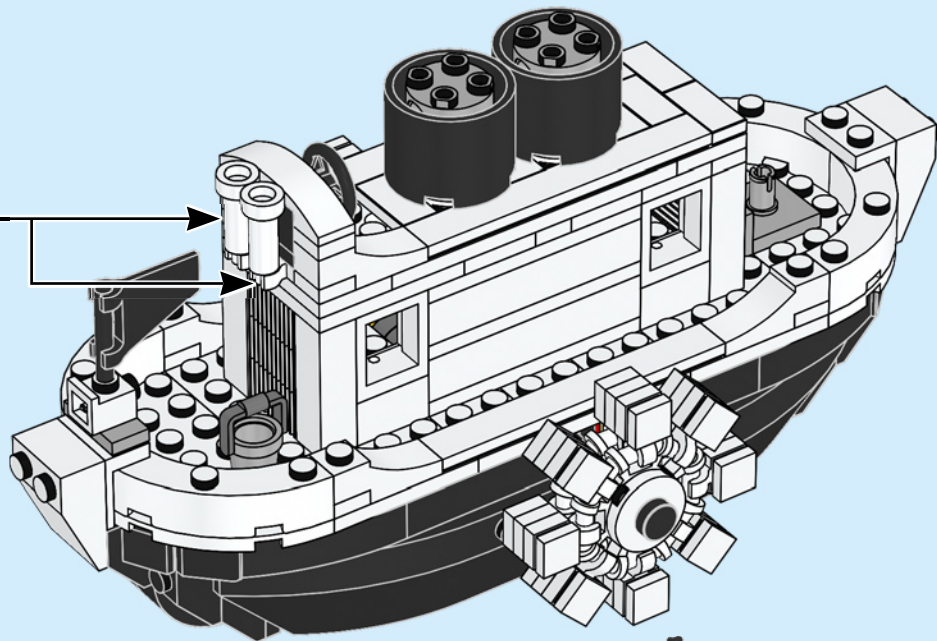
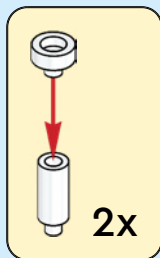

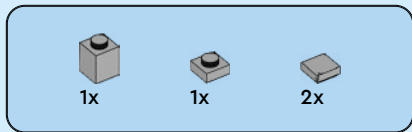

100

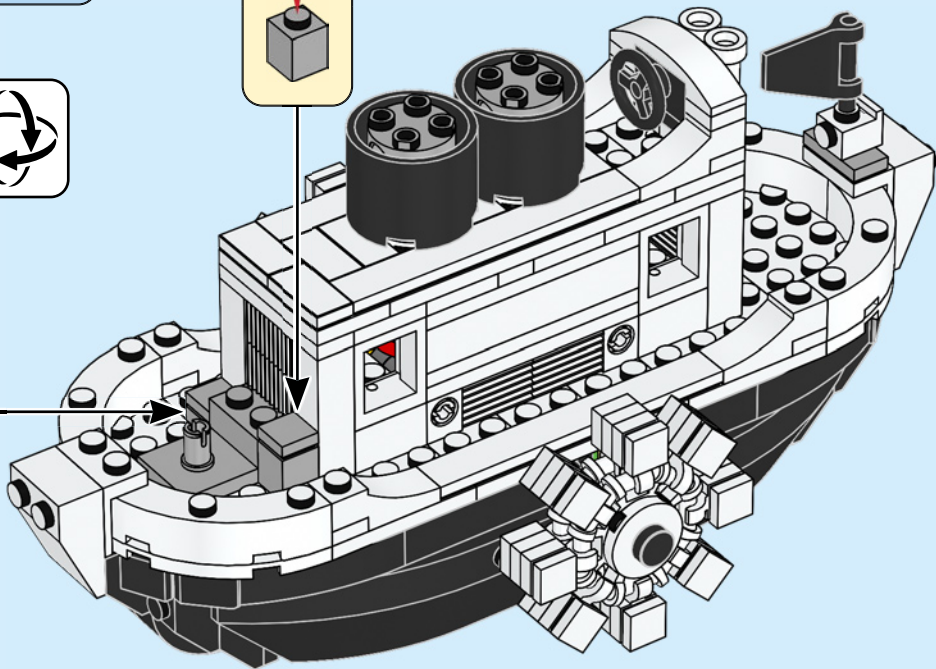
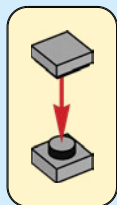
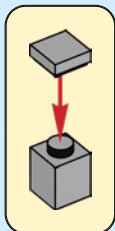



2x



2x

101

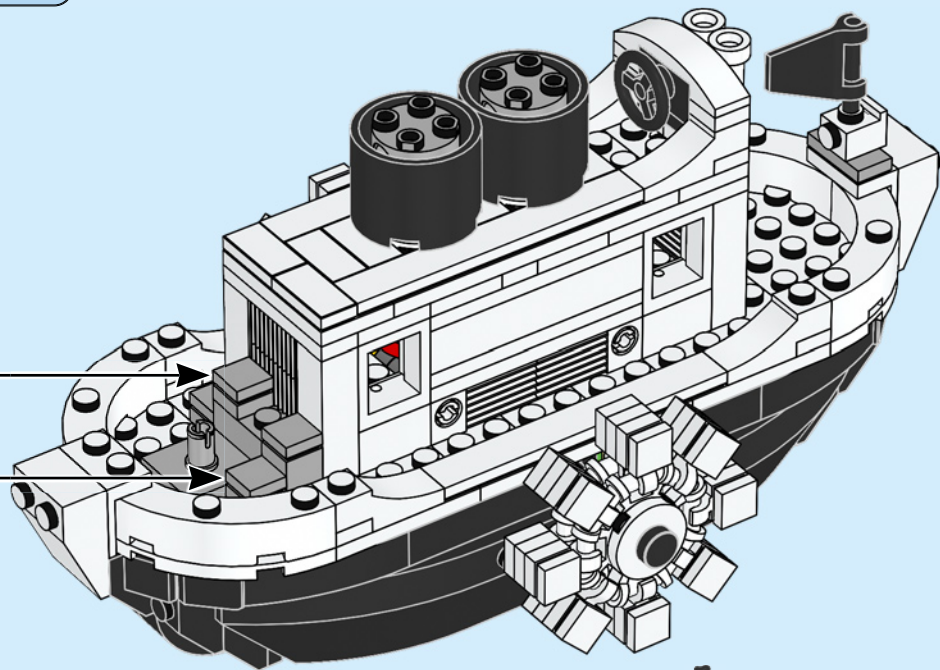
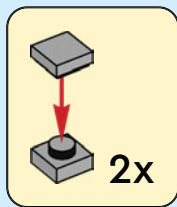



2x



2x

102

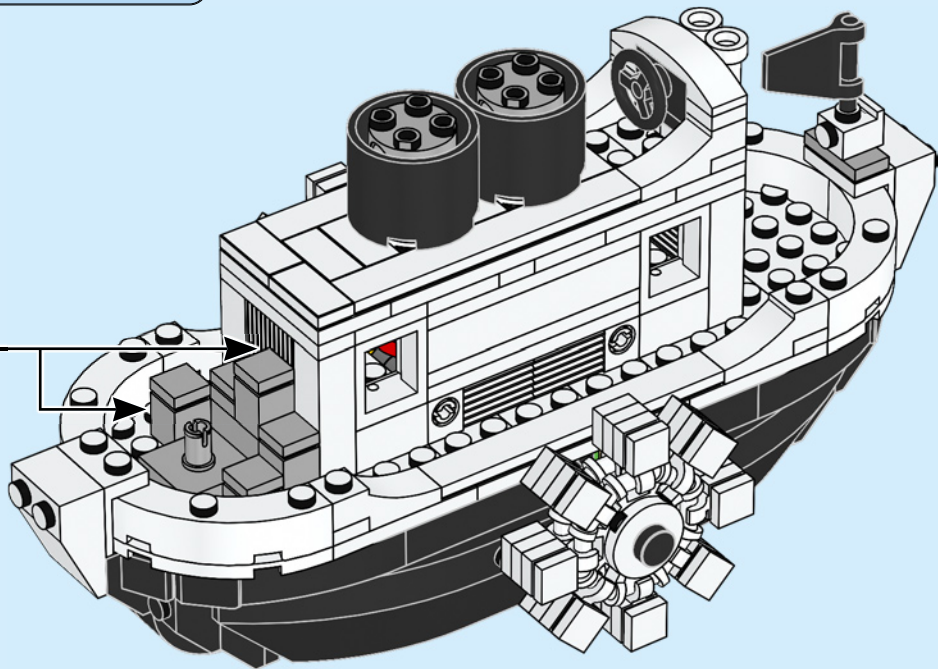
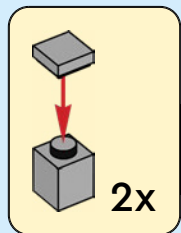



1x



1x

103

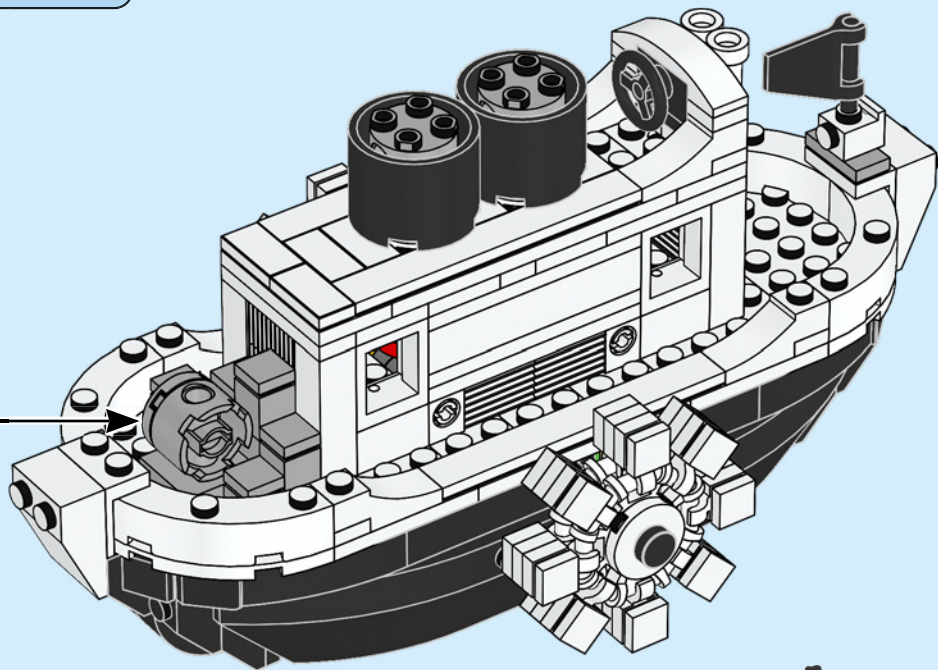
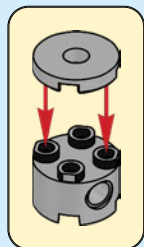

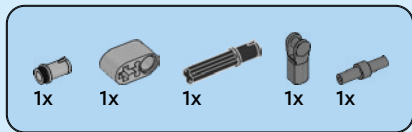

104

1

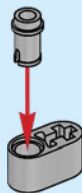

2



3



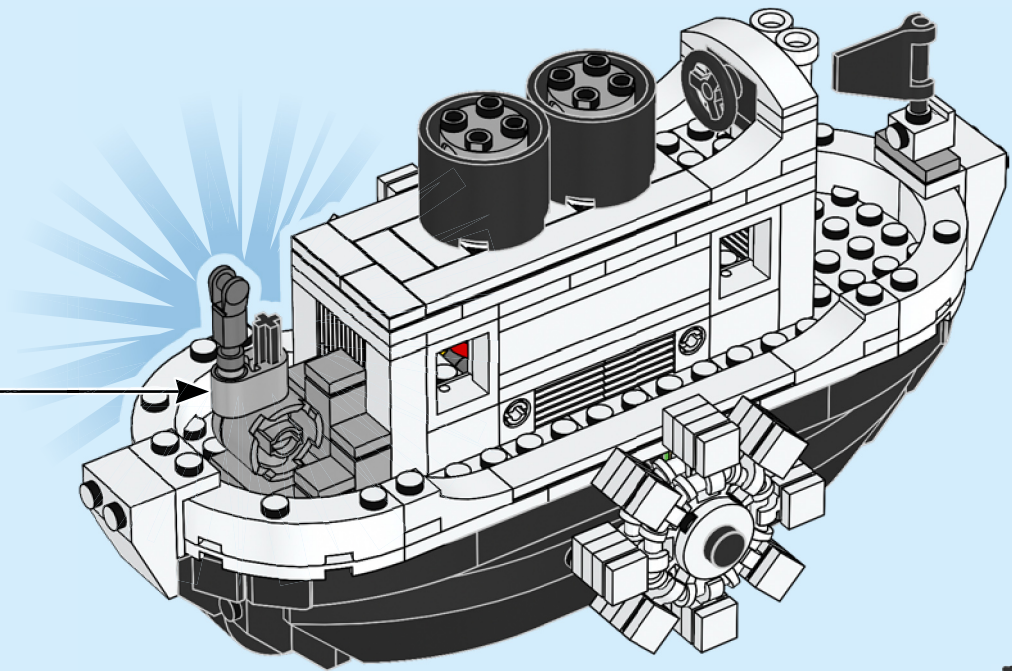



1x



1x



1x

105

1

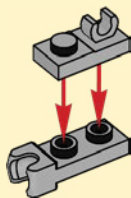

2

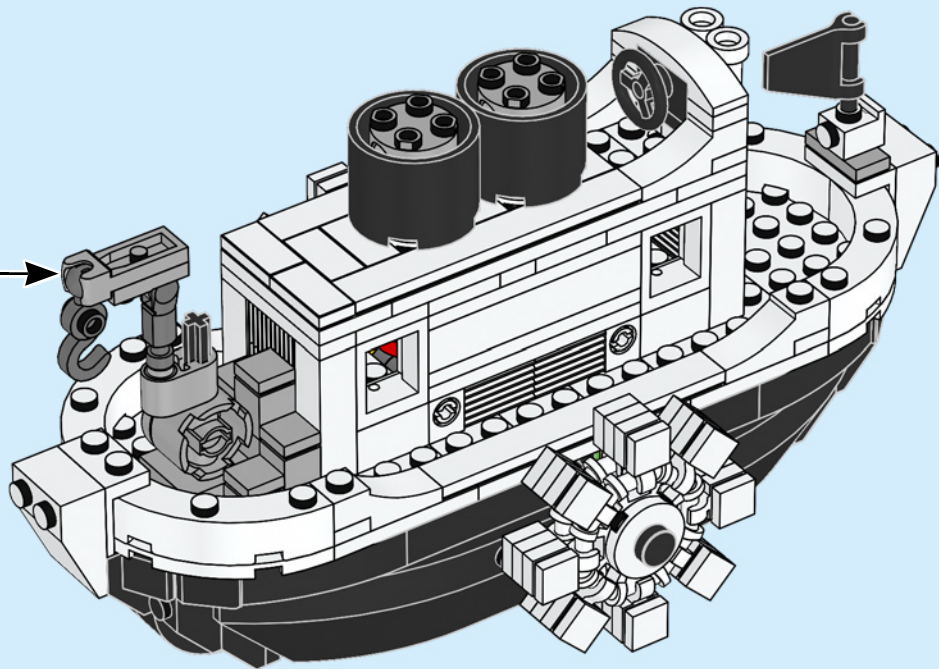



1x



1x

106

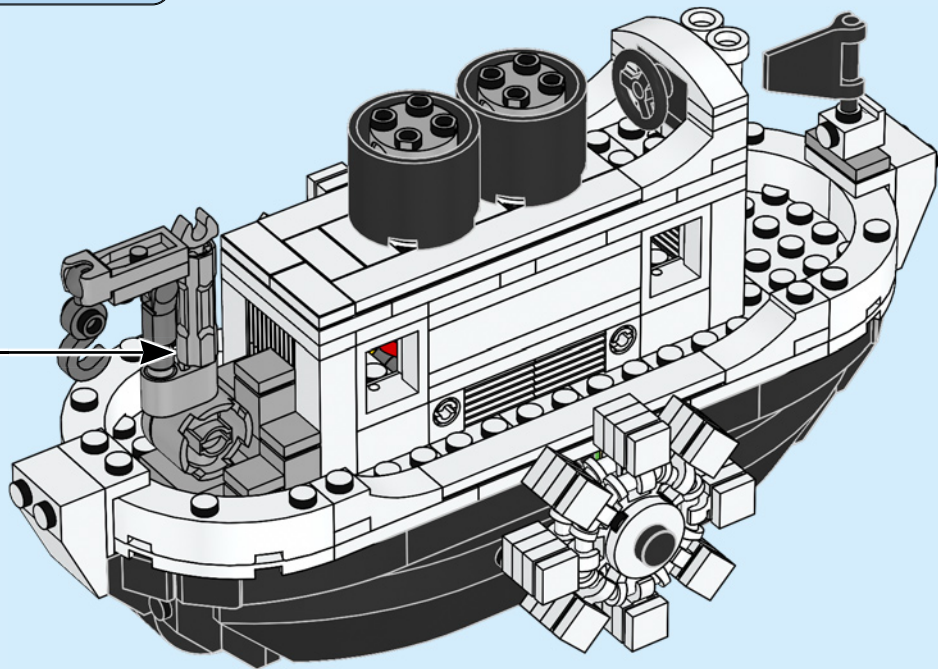
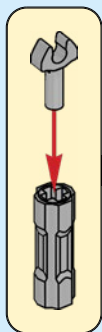

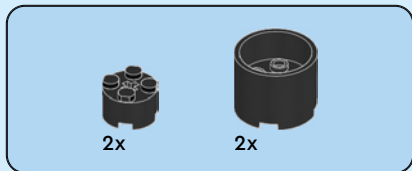

107

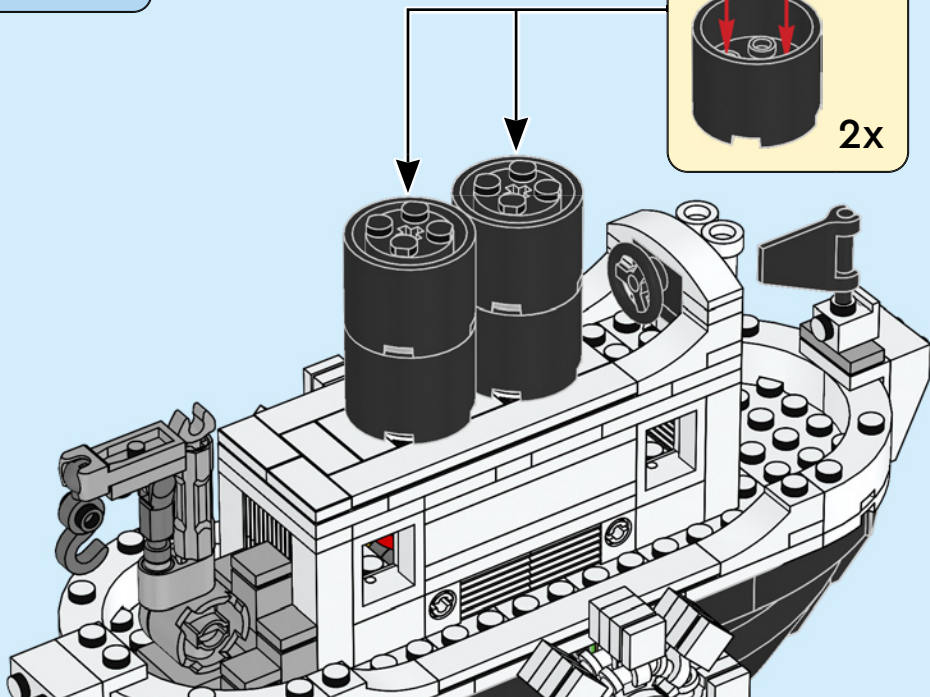
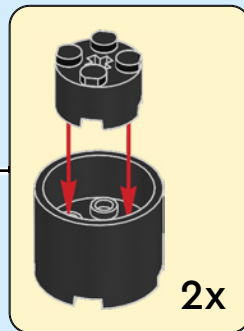

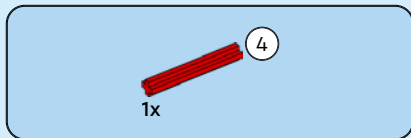

108

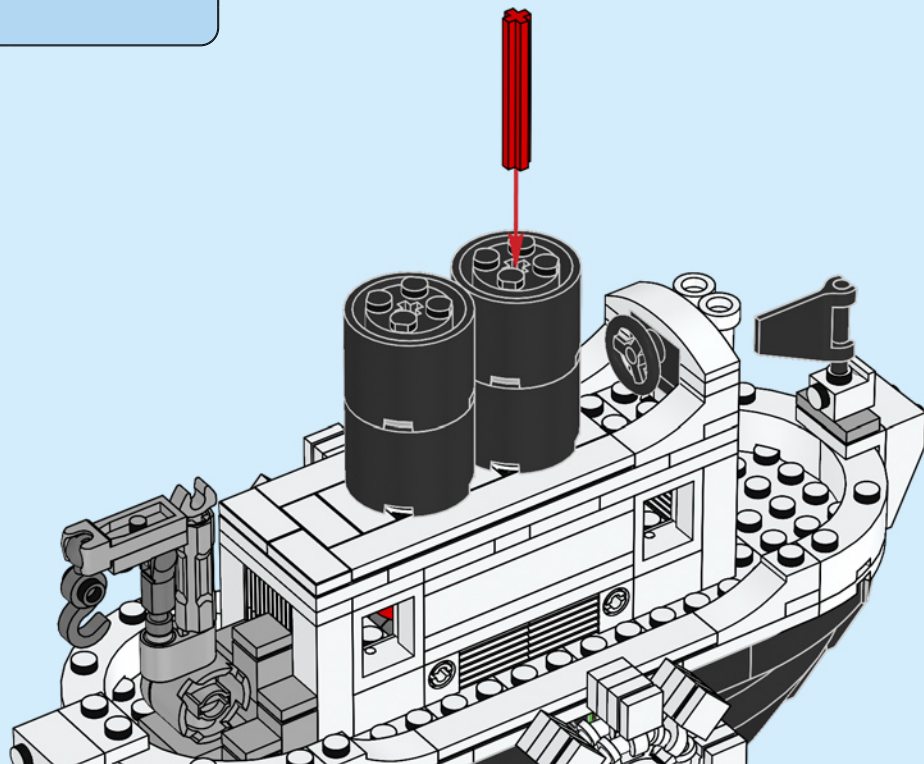

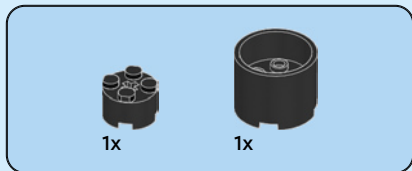

109

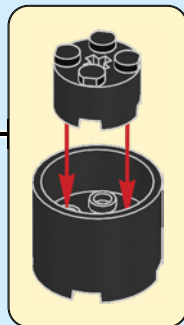
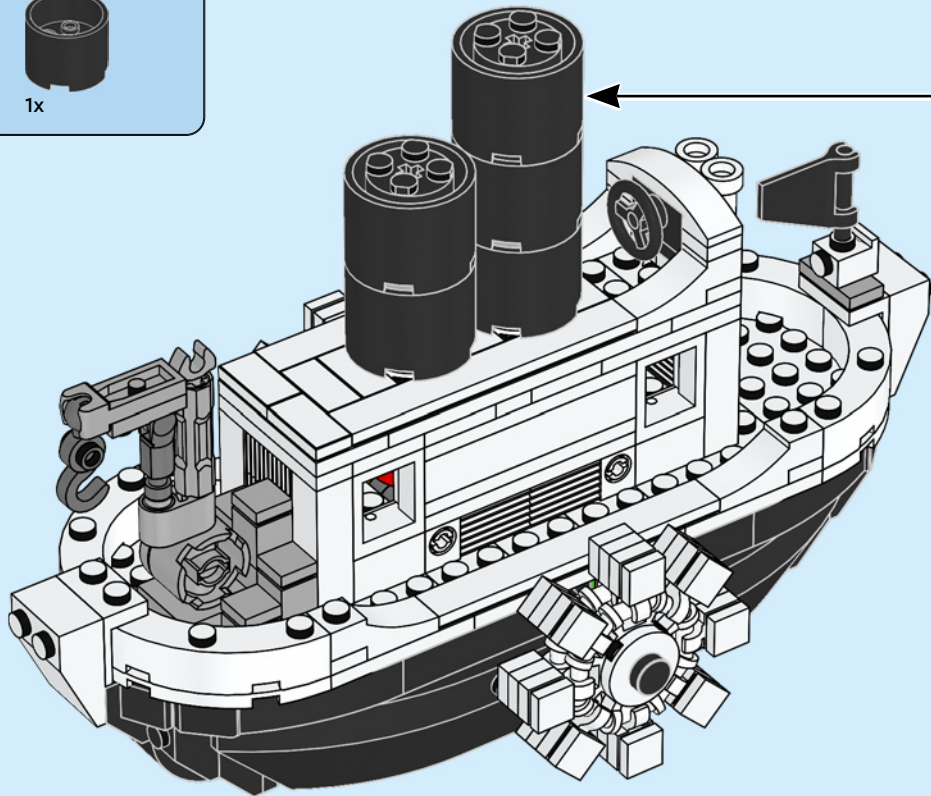

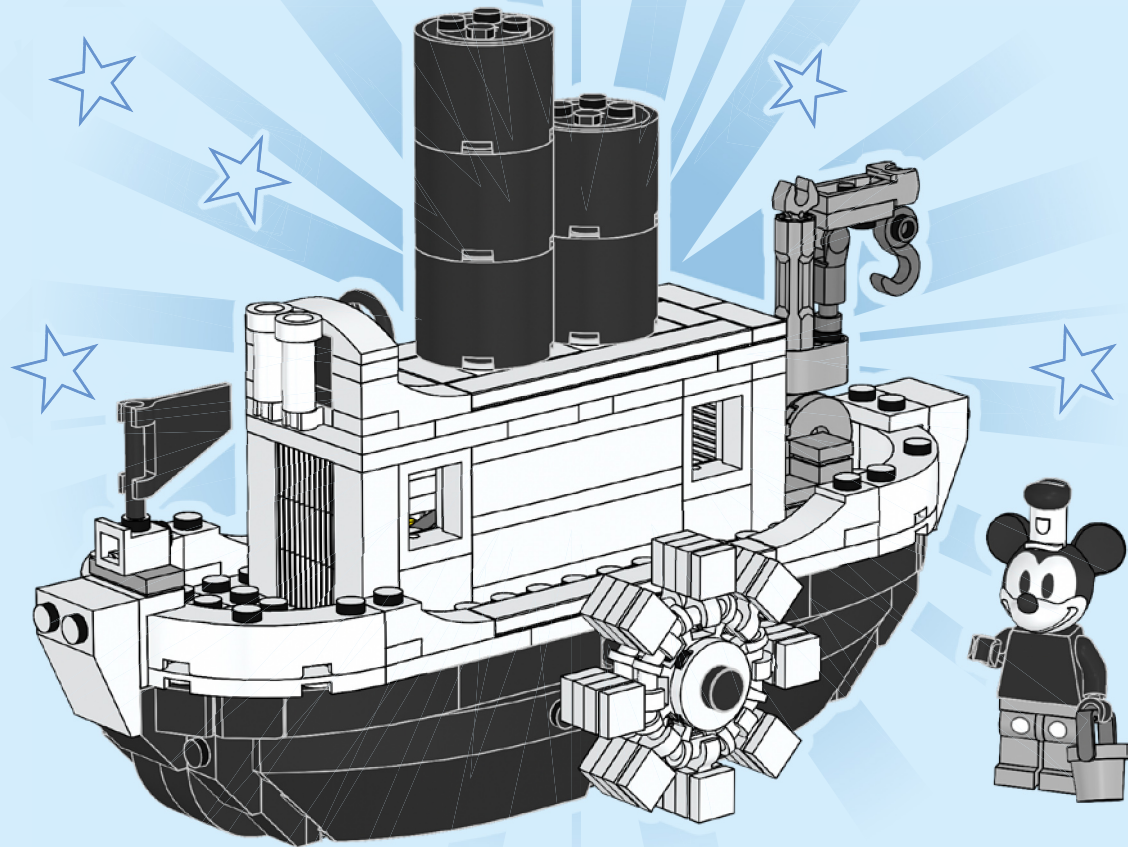



2x
6234807



2x
6186681



1x
6457301



4x
6055541



2x
654101



1x
407001



24x
302401



16x
307001



32x
6347293



2x
6330191



4x
6310185



2x
6093053



7x
287701



4x
6382045



6x
306901



4x
6337627



4x
6337627



2x
6117940



2x
6330136



2x
6330136



1x
6457511



4x
6289797



6x
6357598



6x
302101



2x
329801



4x
6009016



2x
371001



1x
6023806



5x
370901



2x
300101



1x
4527945



2x
6192352



6x
366601

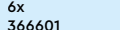

3x
300901



5x
4243812



2x
346001



4x
416201



1x
6138699

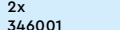

1x
4527945



1x
4527945

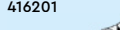

1x
4527945



1x
4527945

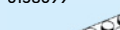

1x
4527945



1x
4527945



4x
6236914



10x
4118790



4x
6351905



2x
403221



1x
4142865



2x
6001806



1x
6129995



3x
371021



1x
6130002



1x
6130002



1x
6130002



4x
379521



1x
6147702



4x
4206482



4x
362323



6x
6271167



6x
300424



4x
6185994



8x
302024



8x
302024



2x
6284070



8x
6332148



4x
4504382



4x
6279875



3x
614326



1x
6057397



9x
302326



3x
370026



3x
370026



3x
370026



3x
370026

8x
4121966

4x
6069000

1x
6363033

1x
6093525

2x
303926

1x
6089119

2x
4541455

5x
6375973

4x
4618880

1x
6245788

2x
371026

2x
301026

4x
243126

4x
6037746

2x
6271278

2x
6271277

2x
273026

2x
6117971

8x
6374071

3x
371028

2x
6401818

2x
6267486

2x
6159763

2x
6302735

6x
4164037

1x
6439041

1x
6057487

2x
4211483

3x
4211389

6x
4211415

3x
4211399

2x
4211475

1x
6179186

5x
6372076

3x
4640536

1x
6265089

1x
6465490

1x
6326078

1x
6066097

2x
6357599

1x
6313188

1x
4211387

1x
6043639

4x
6469440

1x
6273212

4x
6347992

2x
4211425

12x
6096942

1x
6397633

1x
6245283

1x
6350724

6x
4210759

1x
6347464

4x
4211133

2x
6118832

1x
6083620

4

5



 [LEGO.com/service](https://www.LEGO.com/service)

YOU COULD **WIN**



Scan this QR code or go to **LEGO.COM/PRODUCTFEEDBACK** and give us your short feedback about this LEGO® set for a chance to win a cool LEGO prize.

Terms and Conditions apply*

EN: YOU COULD WIN. Terms and Conditions apply* **DE: Du könntest GEWINNEN.** Es gelten die Teilnahmebedingungen* **FR: Tu pourrais GAGNER.** Des conditions s'appliquent* **IT: Potresti VINCERE tu.** Termini e condizioni sono applicabili* **ES: Puedes GANAR.** Aplican términos y condiciones* **PT: Poderá GANHAR.** Aplicam-se termos e condições* **ZH: 轻松获奖. 条款和条件适用*** **PL: Szansa na WYGRANĄ.** Obowiązują warunki korzystania* **CS: Máte šanci VYHRÁT.** Platí všeobecné smluvní podmínky* **SK: Máte šancu VYHRAŤ.** Platia všeobecné zmluvné podmienky* **HU: TE IS NYERHETSZ.** Felhasználási feltételek érvényesek* **RO: Ai putea CÂȘTIGA.** Se aplică termenii și condiții* **BG: Можете да СПЕЧЕЛИТЕ.** Има определени правила и условия* **LV: Tu vari LAIMĒT.** Ir spēkā noteikumi un nosacījumi.* **ET: Sul on võimalus VÕITA.** Kehtivad tingimused* **LT: Jūs galite LAIMĖTI.** Taikomos sąlygos*

*[LEGO.com/productfeedback-terms](https://www.lego.com/productfeedback-terms)