



# NINJAGO

40704





### **Get excited about our new packaging!**

We're switching from plastic to paper-based packaging. That's why you might find a mix of paper and plastic in our boxes!

### **Nos nouveaux emballages vous emballeront !**

Nous passons des emballages en plastique aux emballages à base de papier. C'est pourquoi vous pourriez trouver un mélange de papier et de plastique dans nos boîtes !

### **¡Te presentamos nuestros nuevos empaques!**

Estamos sustituyendo las bolsas de plástico por bolsas con base de papel. ¡Por eso, puedes encontrar una mezcla de papel y de plástico en nuestras cajas!

**[LEGO.com/sustainable-packaging](https://www.lego.com/sustainable-packaging)**

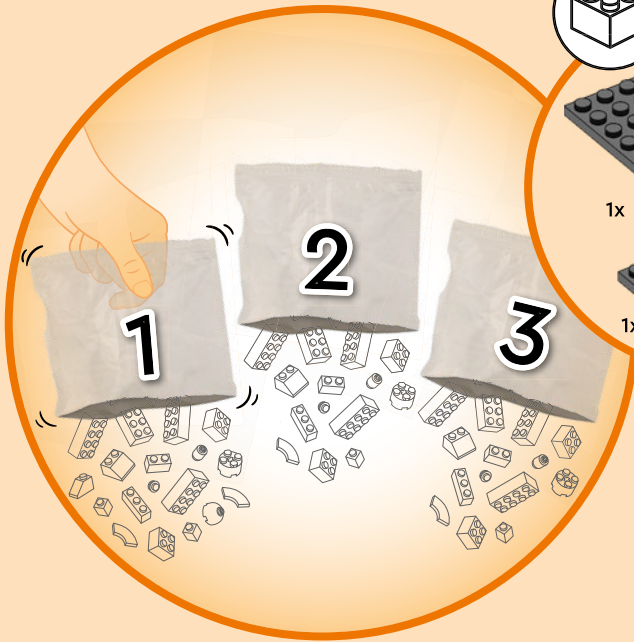

1x



1x

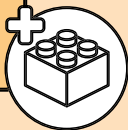
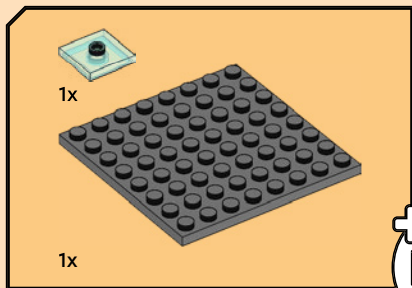

1

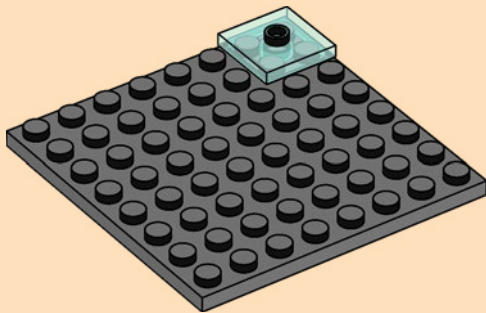



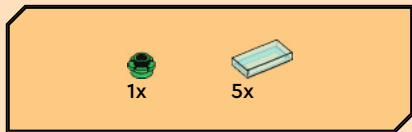

2

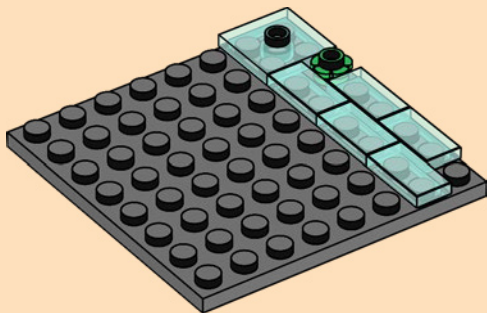

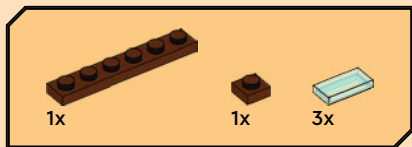

3

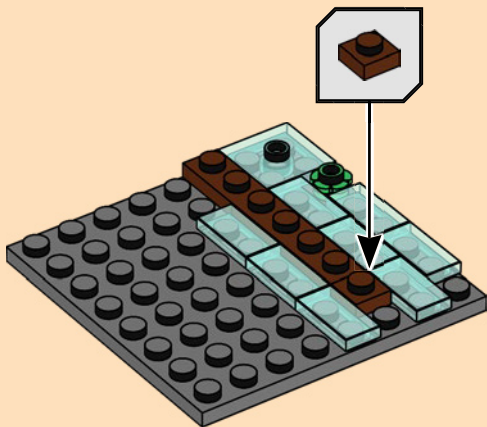

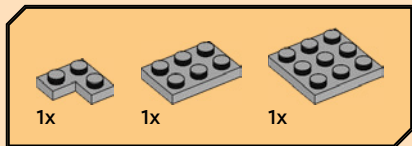

4





1x



3x

5

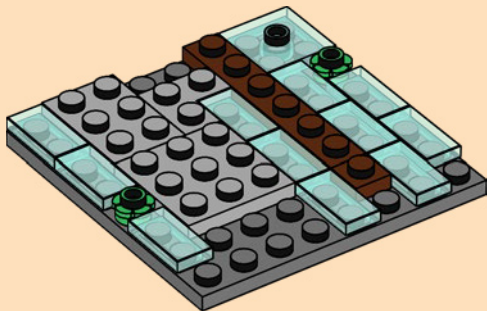

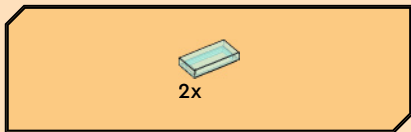

6

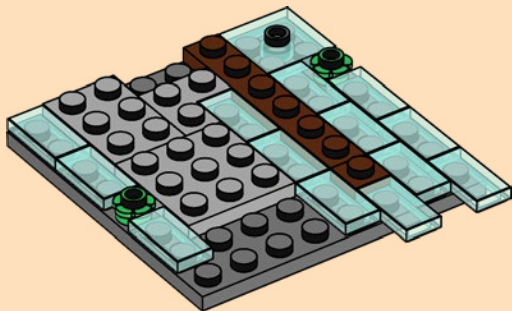

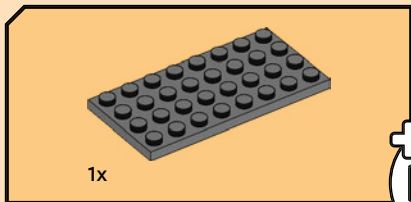

1x



7

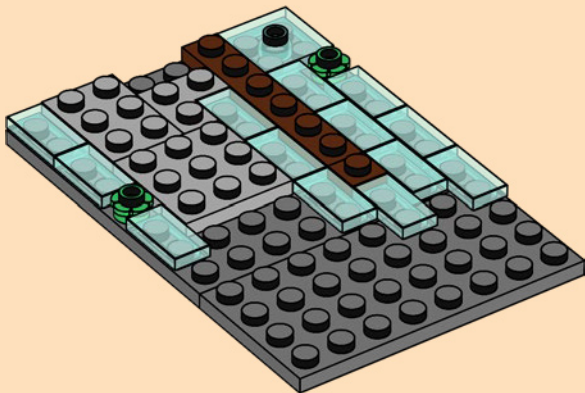

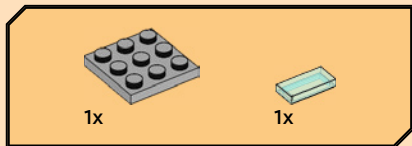

8

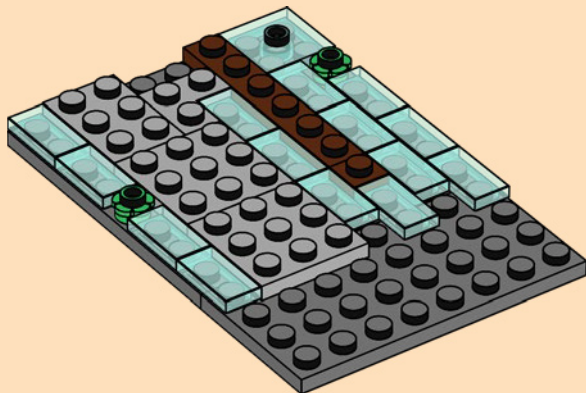

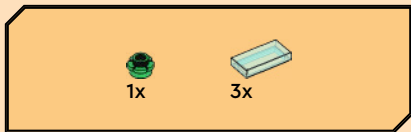

9

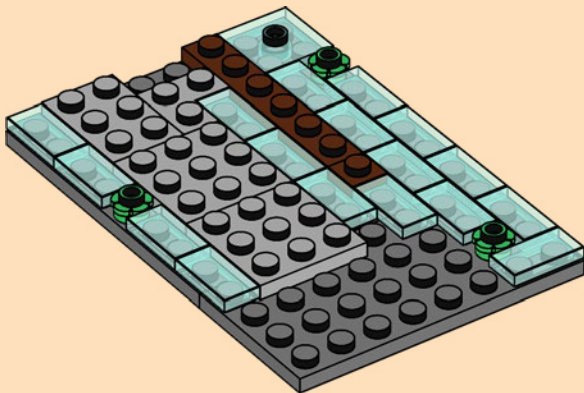



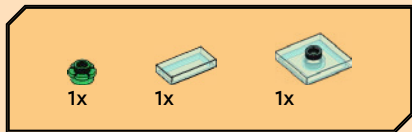

10

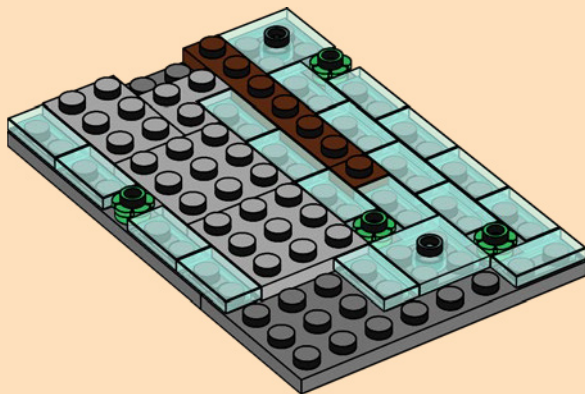

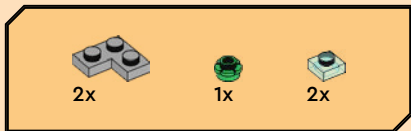

11

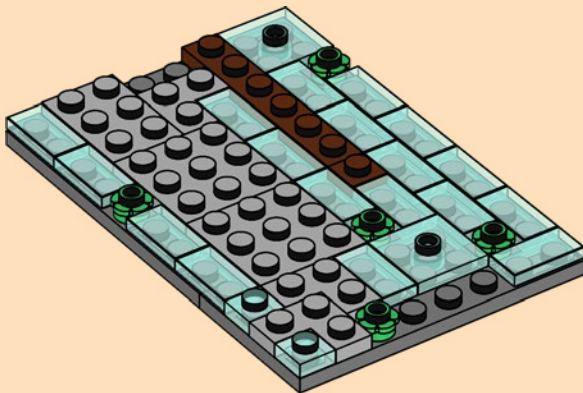

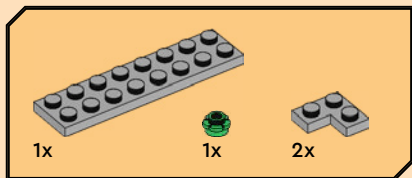

12

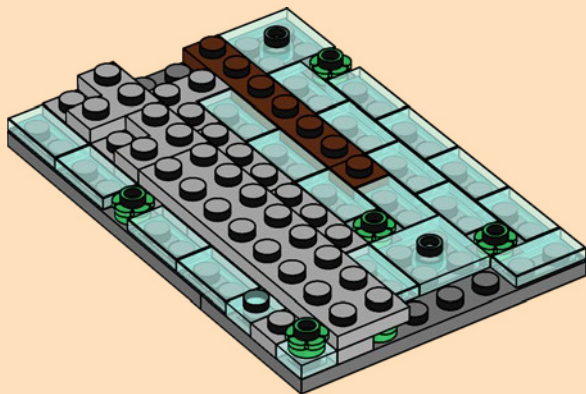

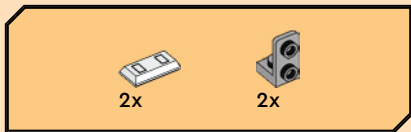

13

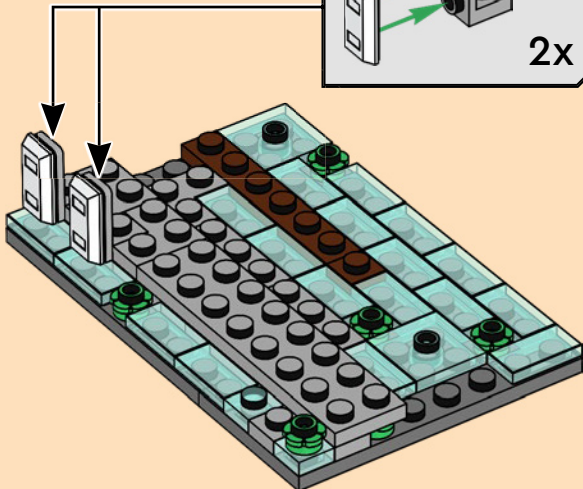
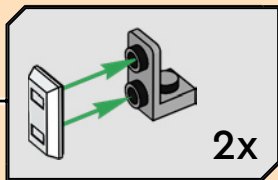

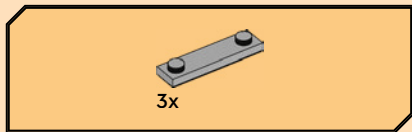

14

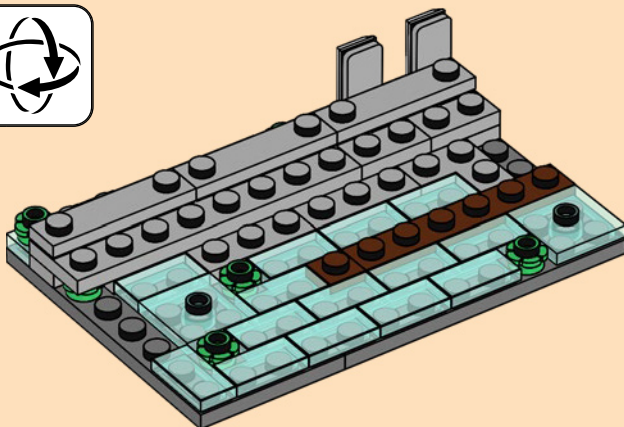
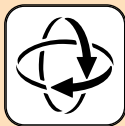

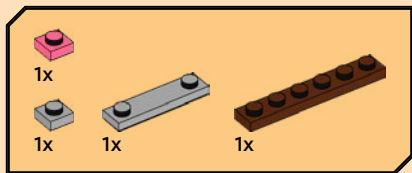

15

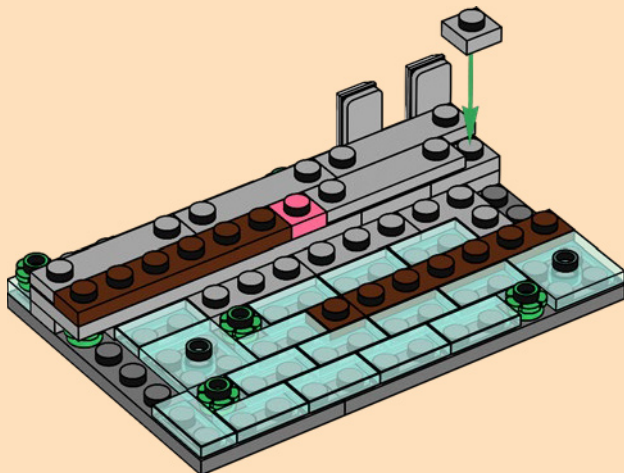

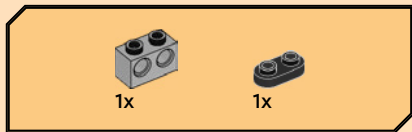

16

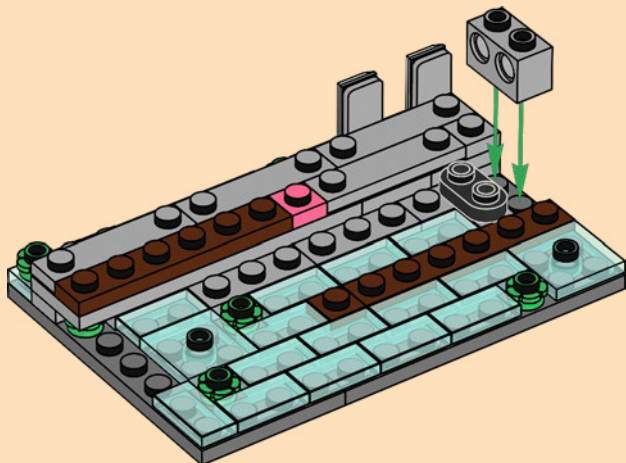

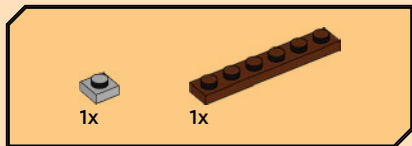

17

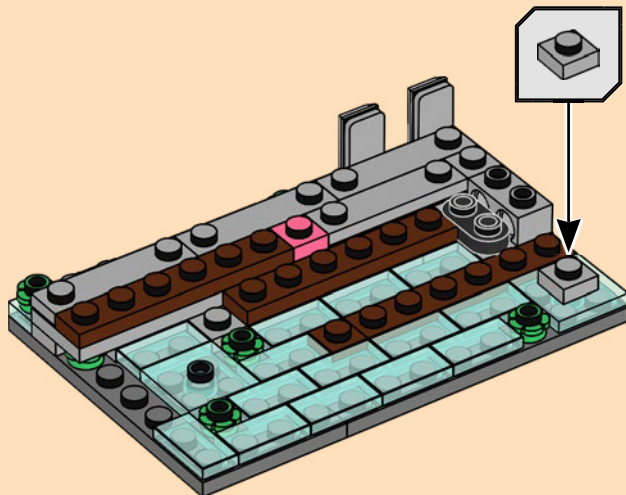



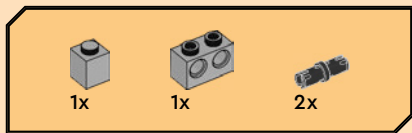

# 18

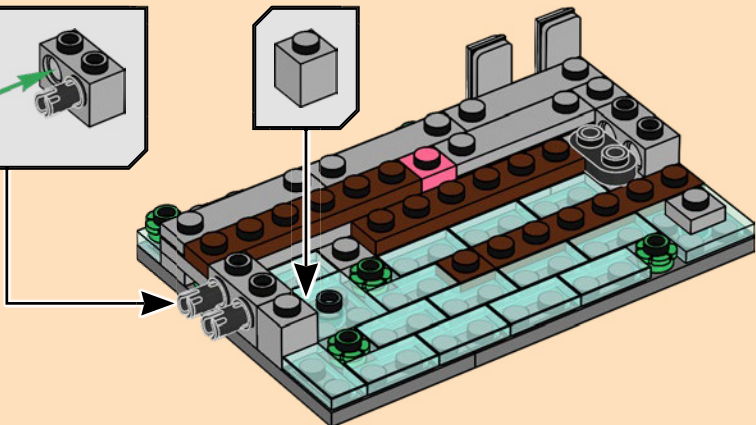
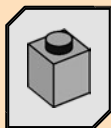
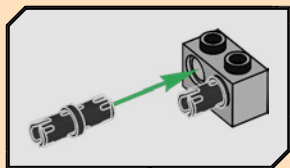

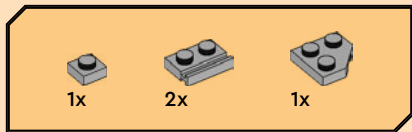

19

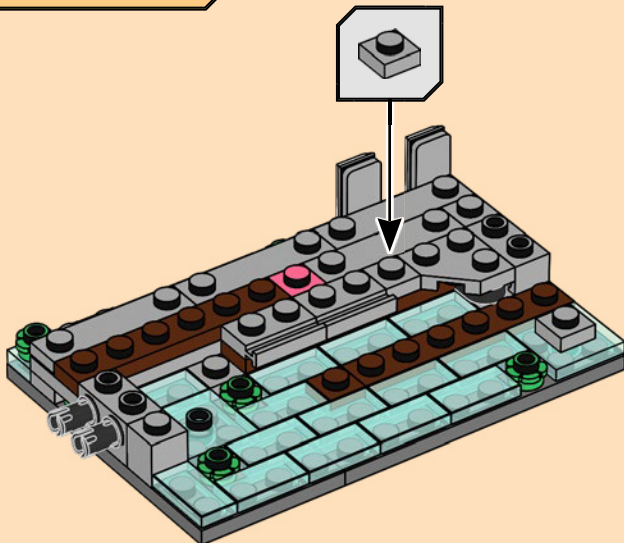

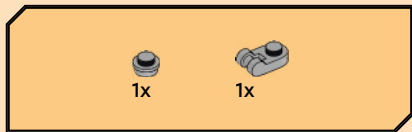

20

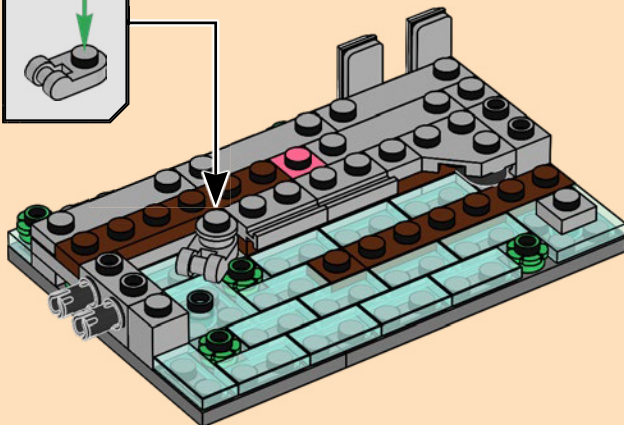
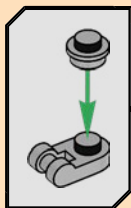



1x



1x

# 21

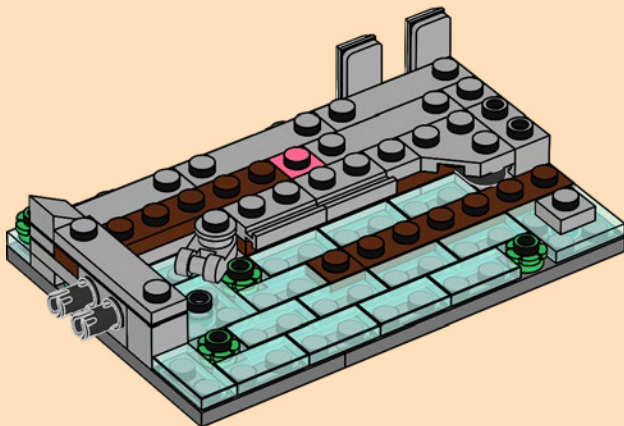

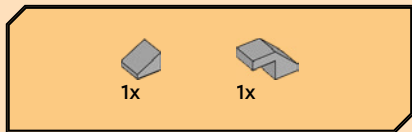

22

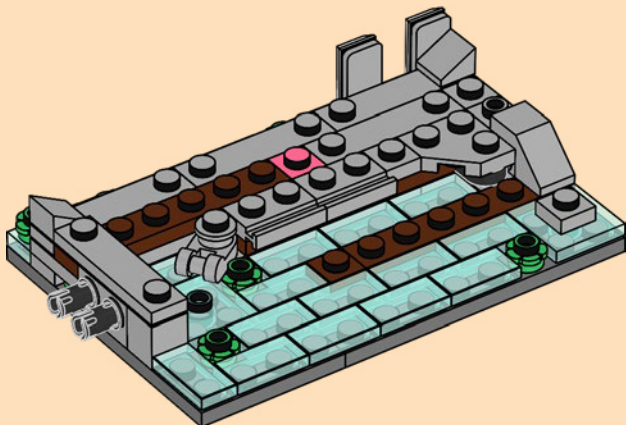



23

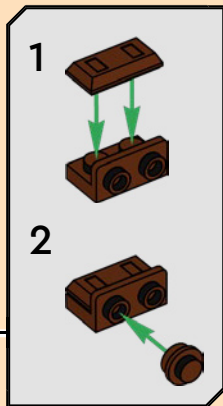
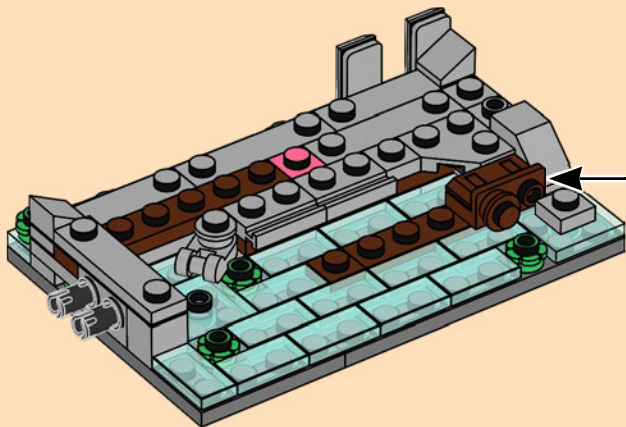

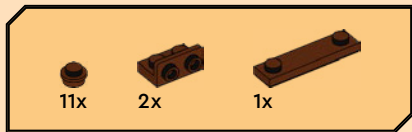

24

1

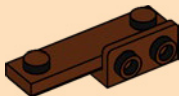

2

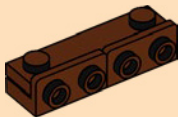

3

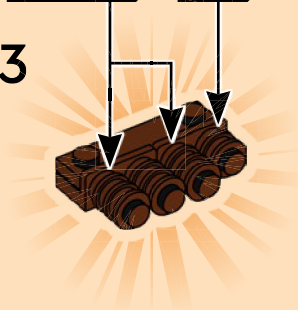
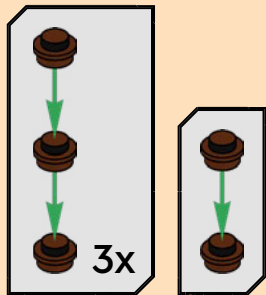

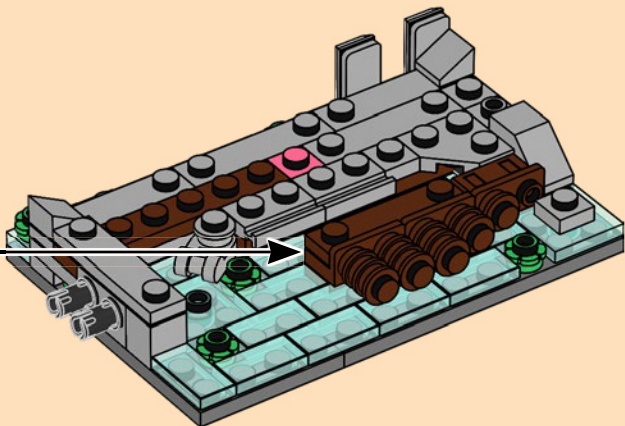



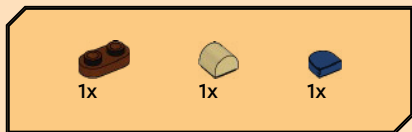

25

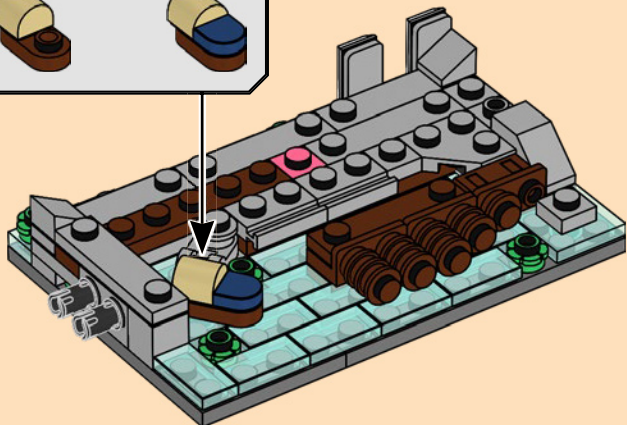
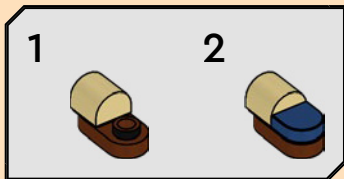

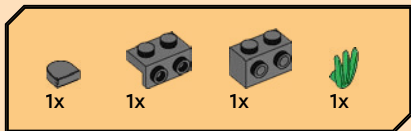

26

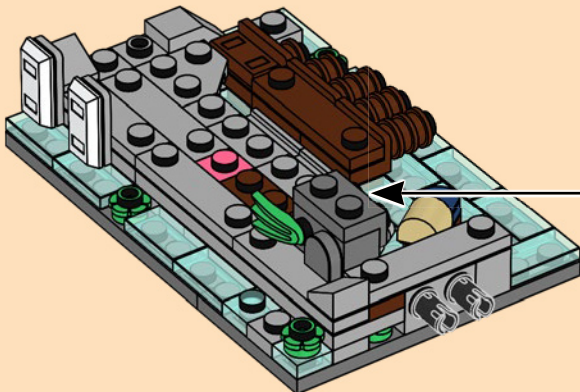
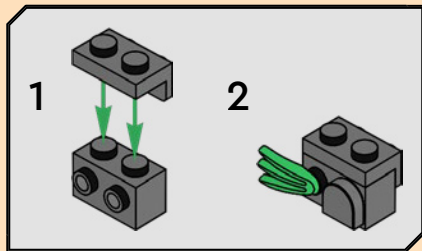

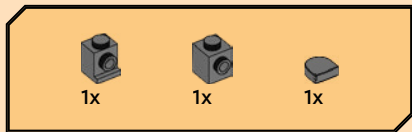

27

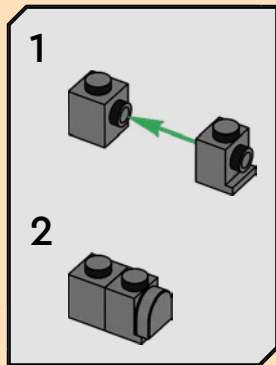
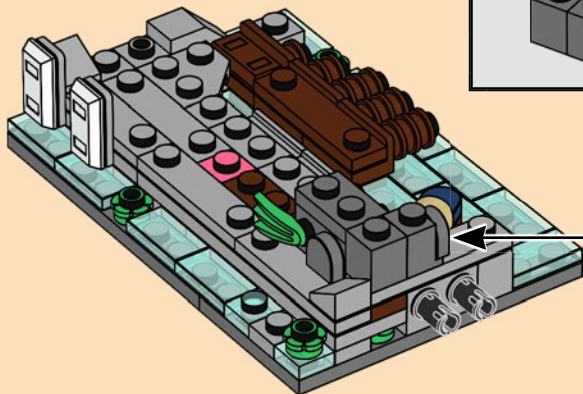

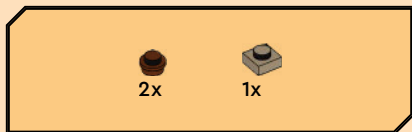

28

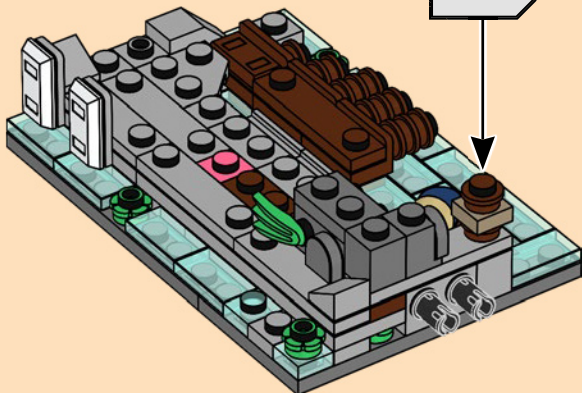
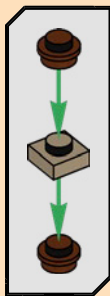

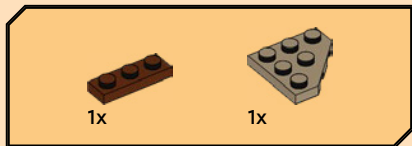

29

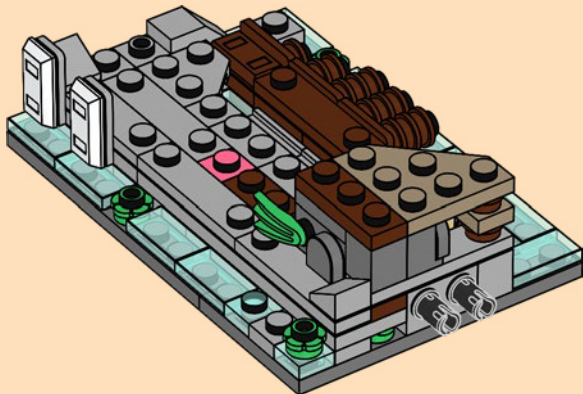



30

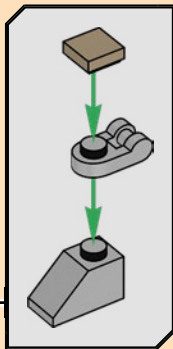
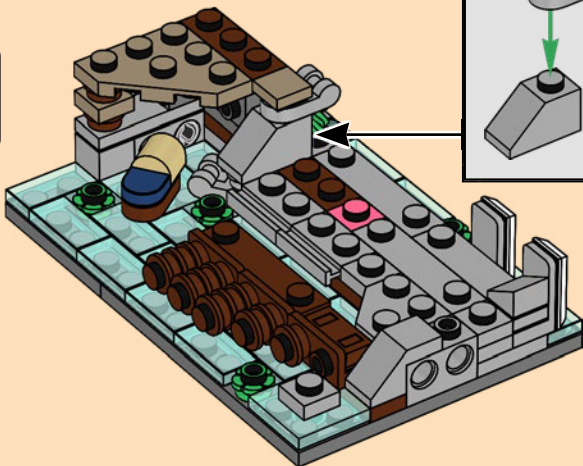

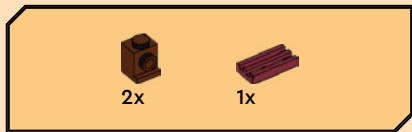

31

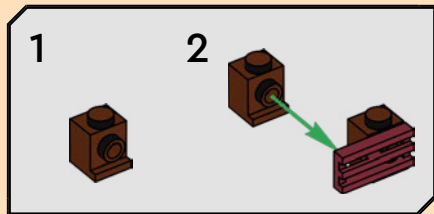

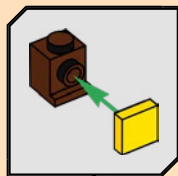
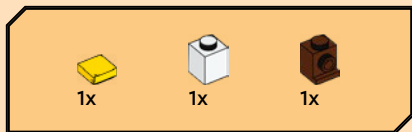

32

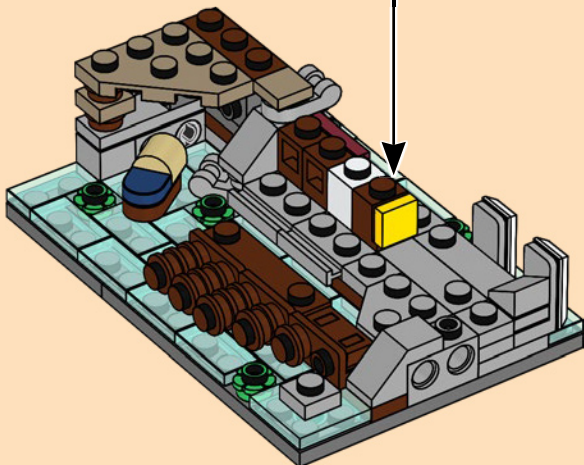





2x

33

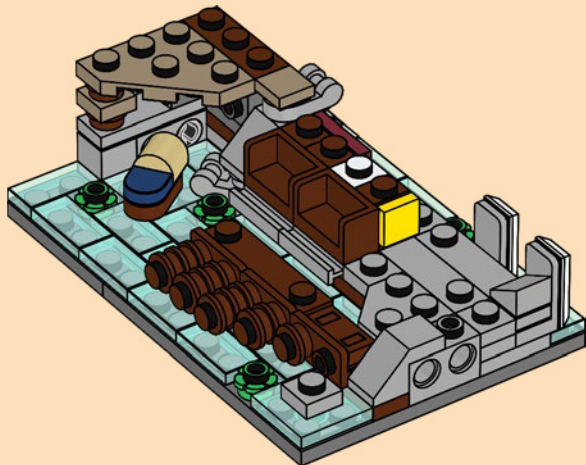



2x

34





1x



1x

# 35

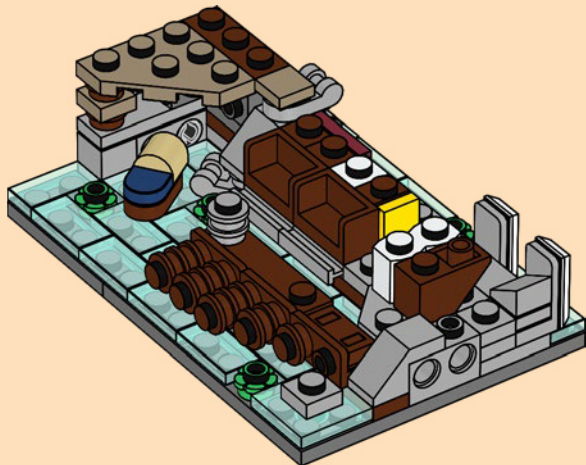



1x



1x

# 36



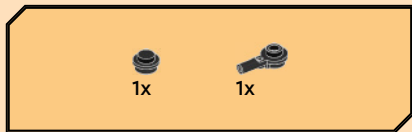

37





1x



1x



1x

# 38

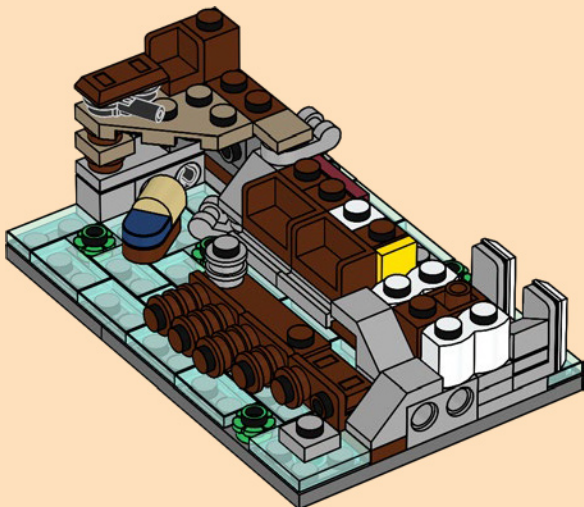

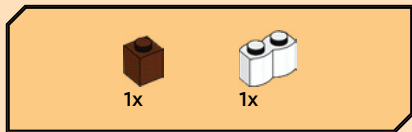

39

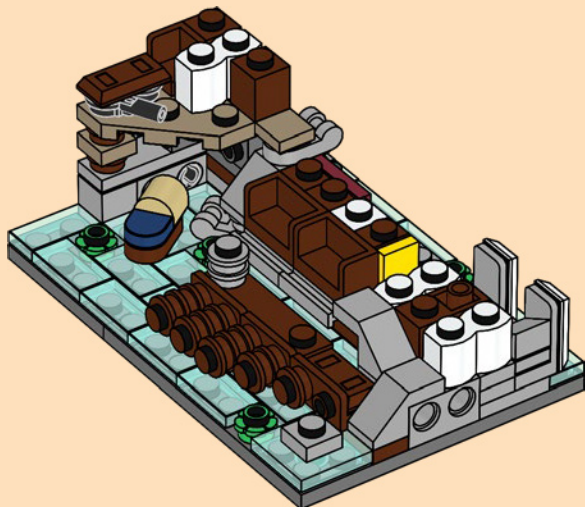



1x



1x

40

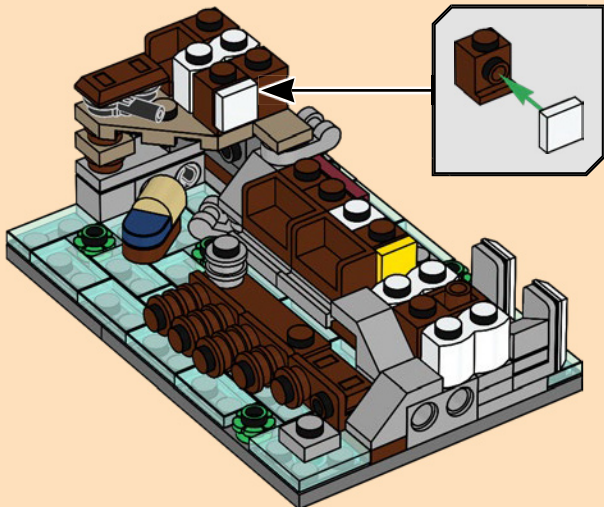





1x



1x

41

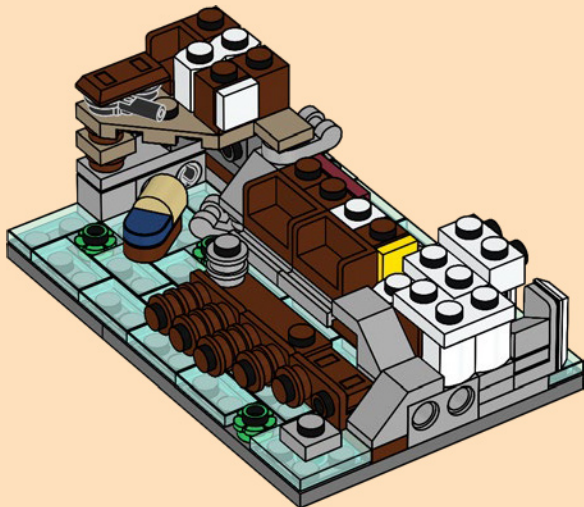

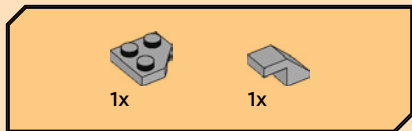

42

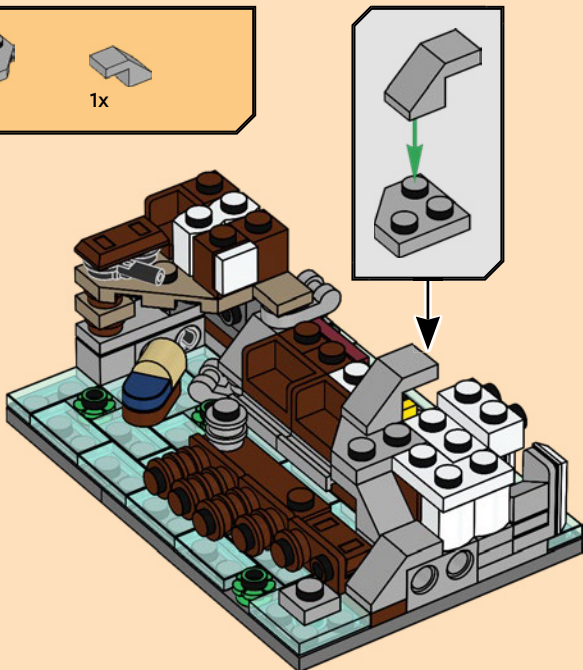



1x

43

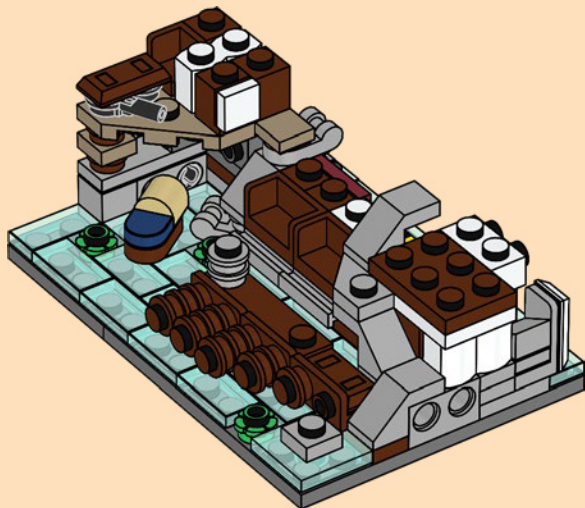



1x



1x

44

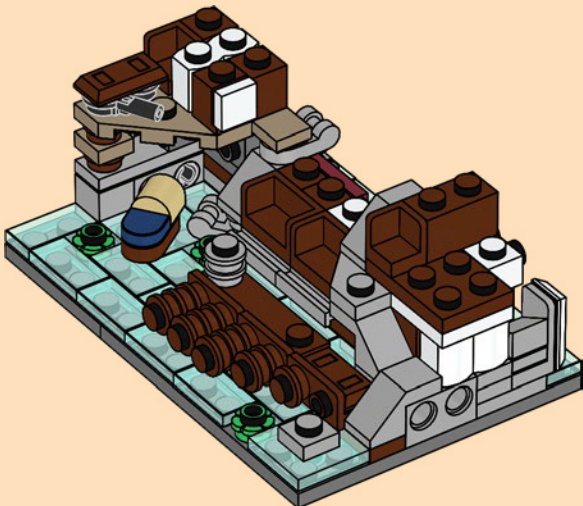



1x



1x



1x

45

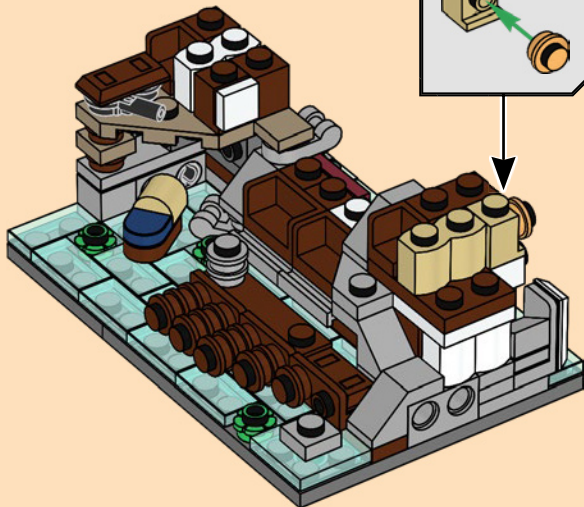



46

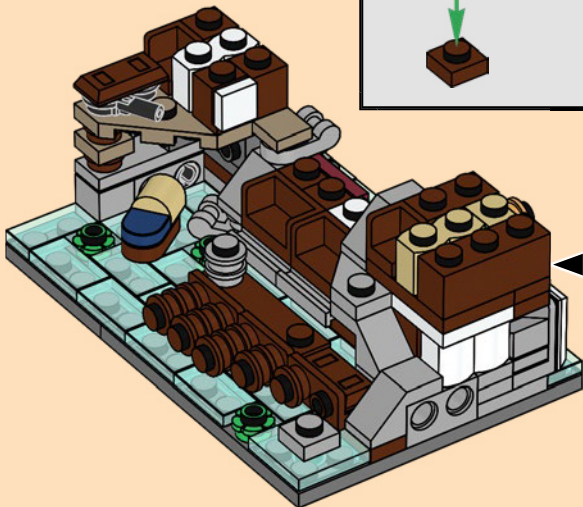
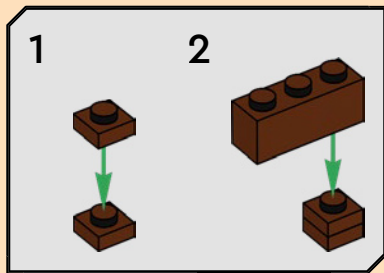

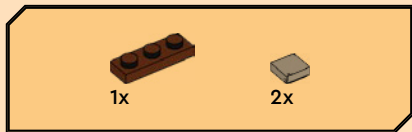

47

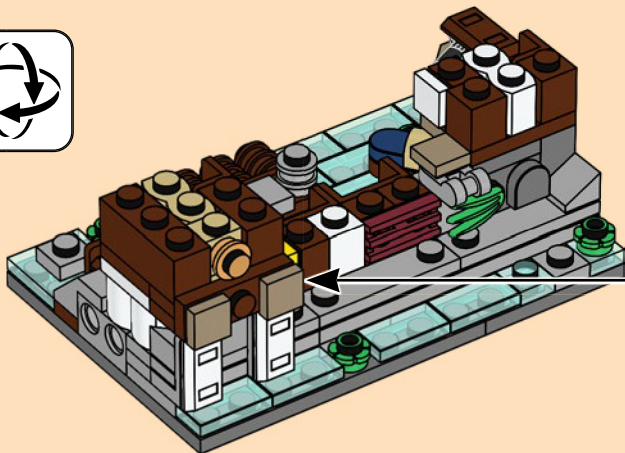
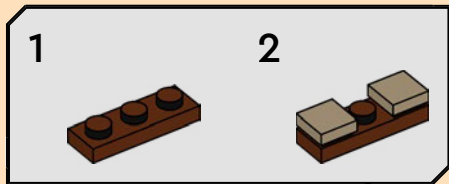

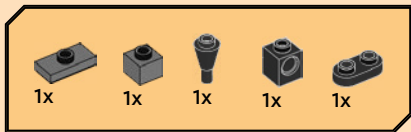

# 48

1

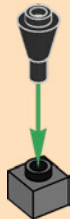

2



3



4

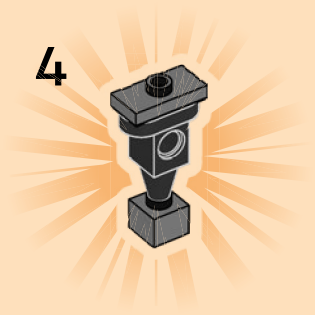



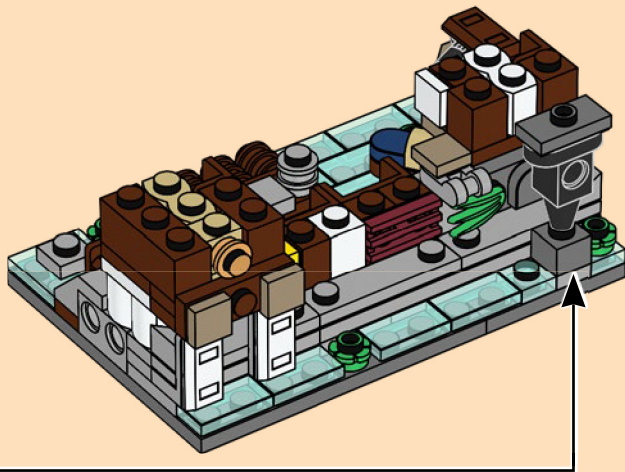



49

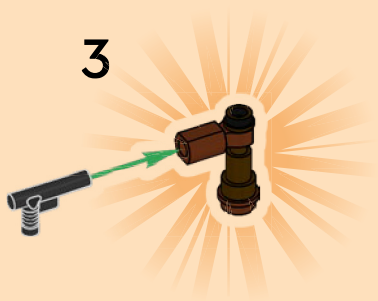
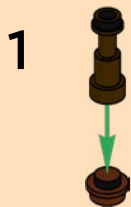

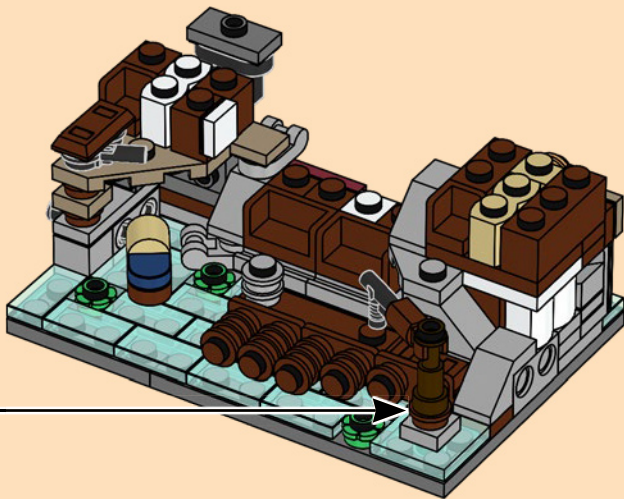



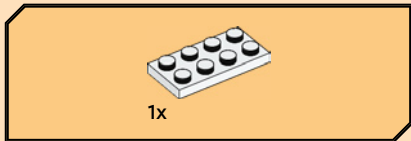

50

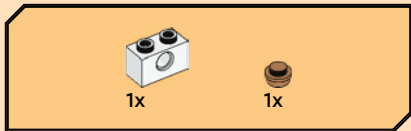

51

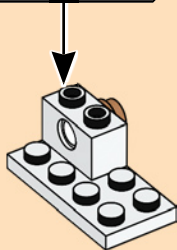
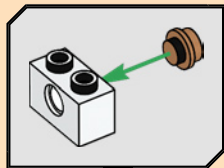



1x



1x

# 52

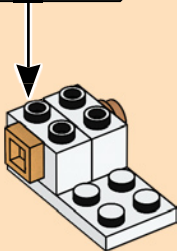
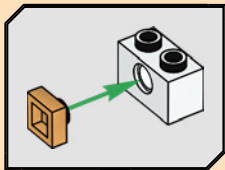

1x

# 53

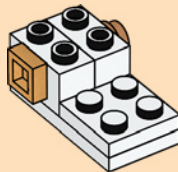



2x

54

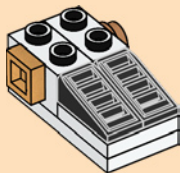

2x

55

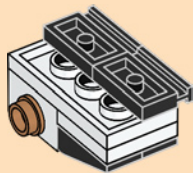



2x

56

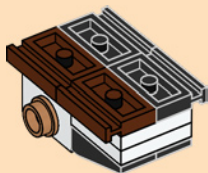

60



2x

57

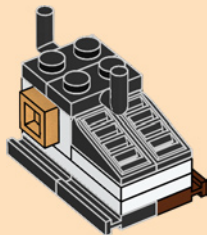
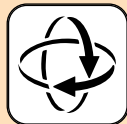



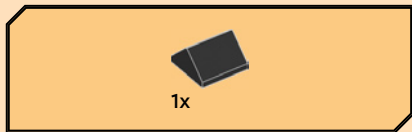

58

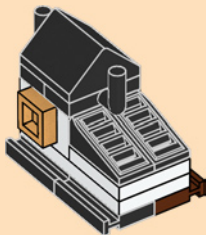

59

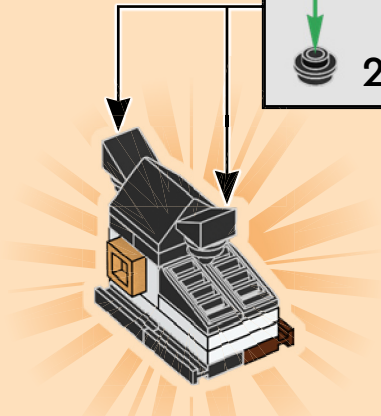
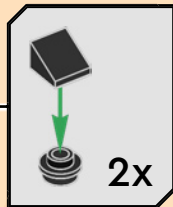

60

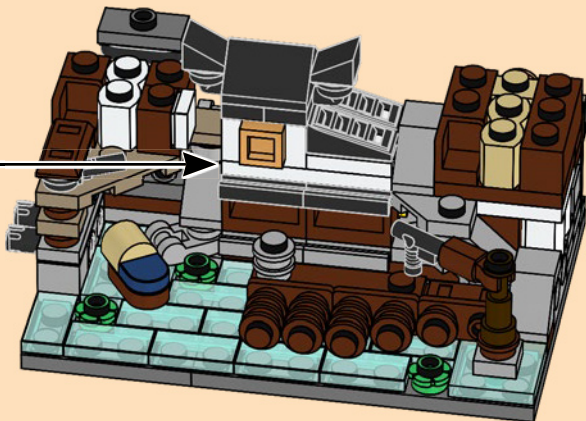



1x

61

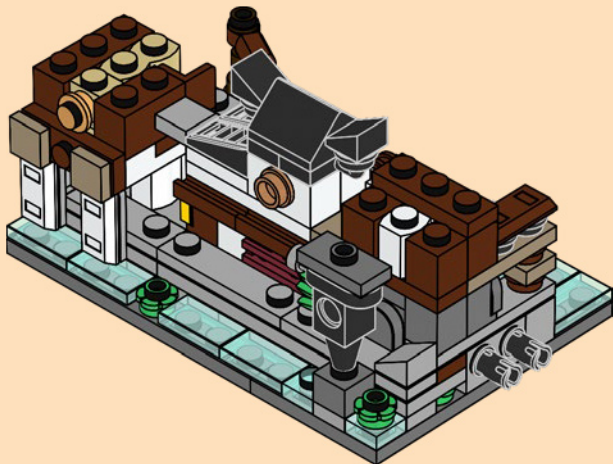

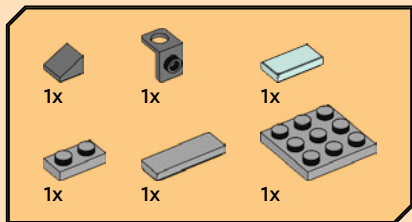

62

1

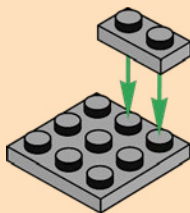

2

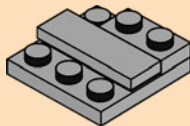

3

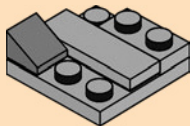

4

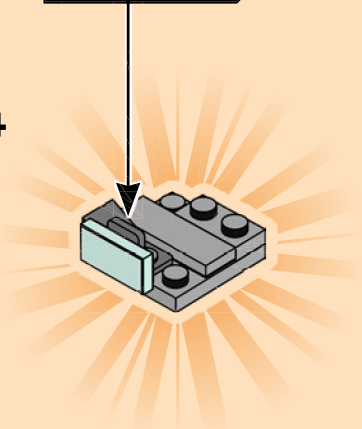
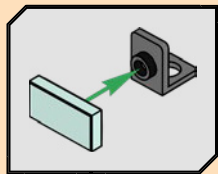

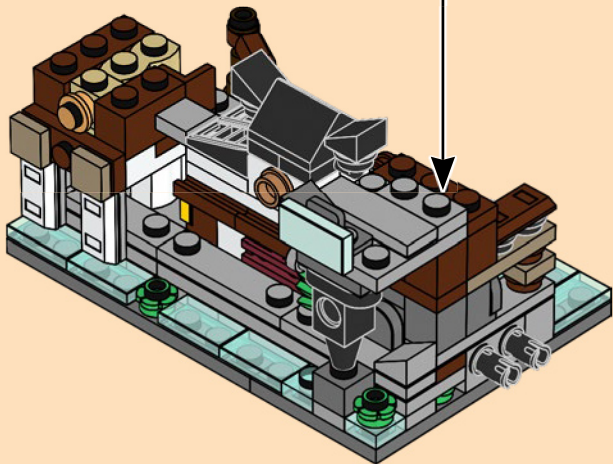



1x

63

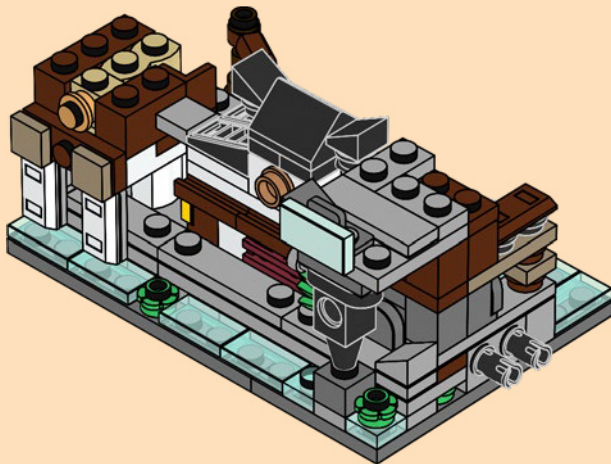

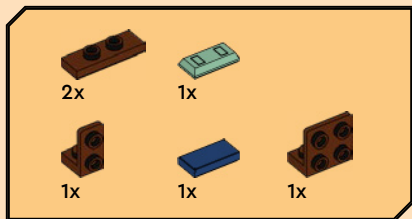

64

1



2

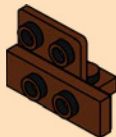



3

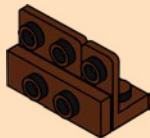

4

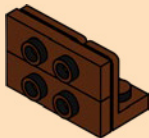

5



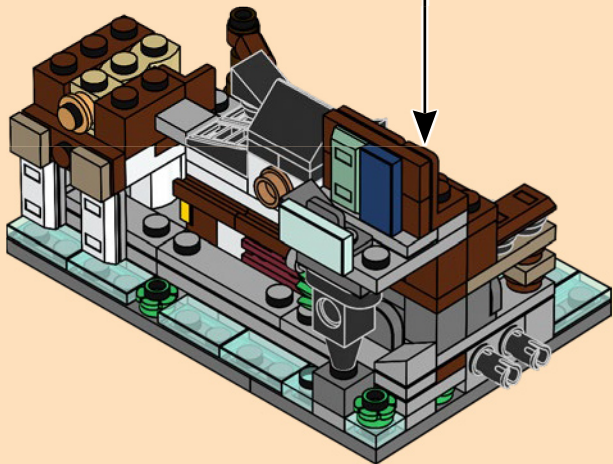

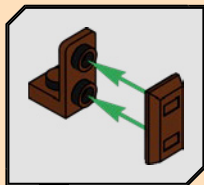
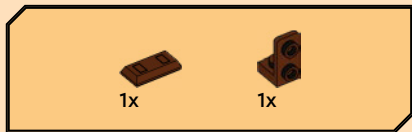

65

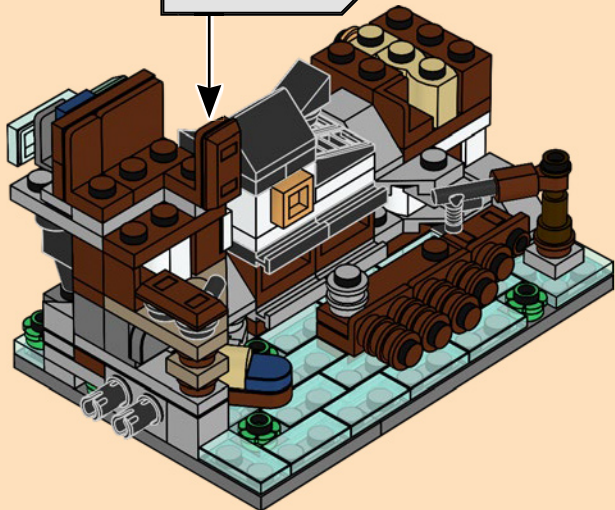



1x



1x

66



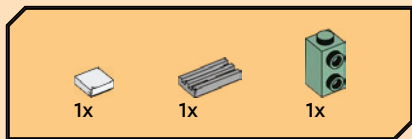

67

1



2

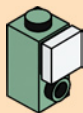

3

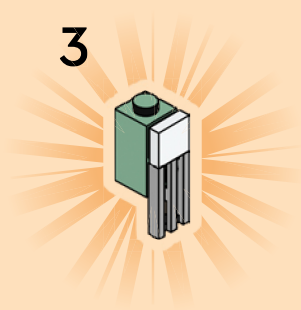

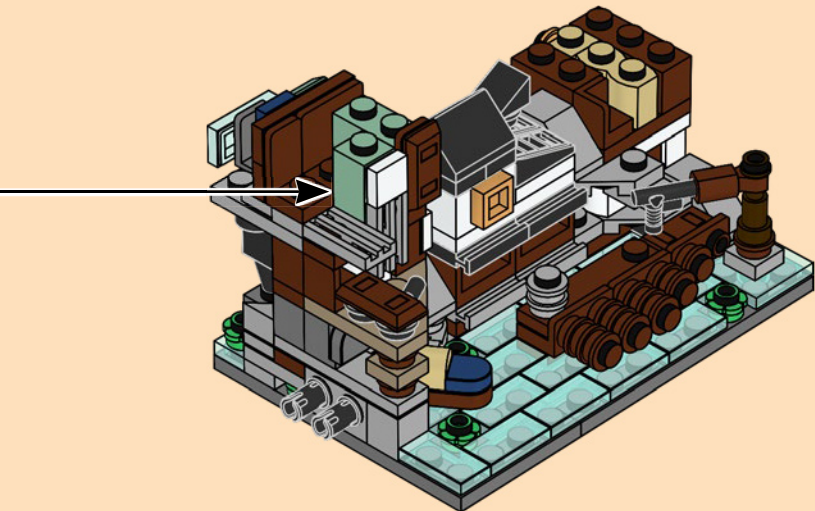

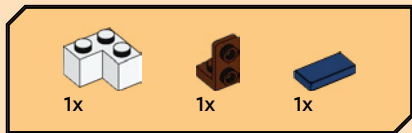

68

1

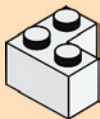

2



3

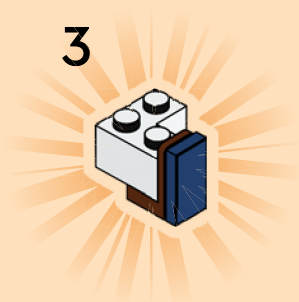

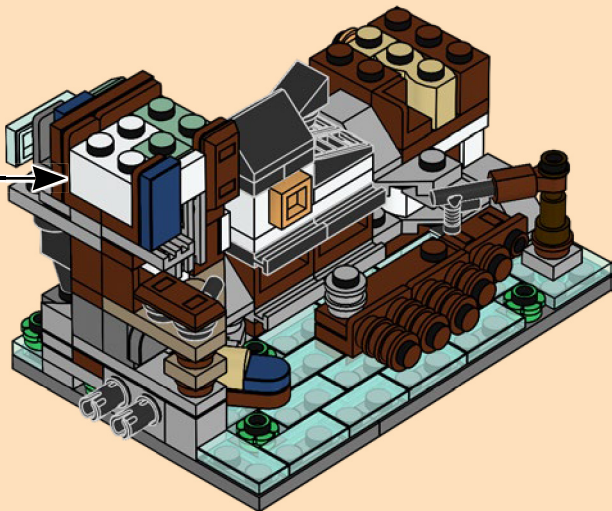





1x

69

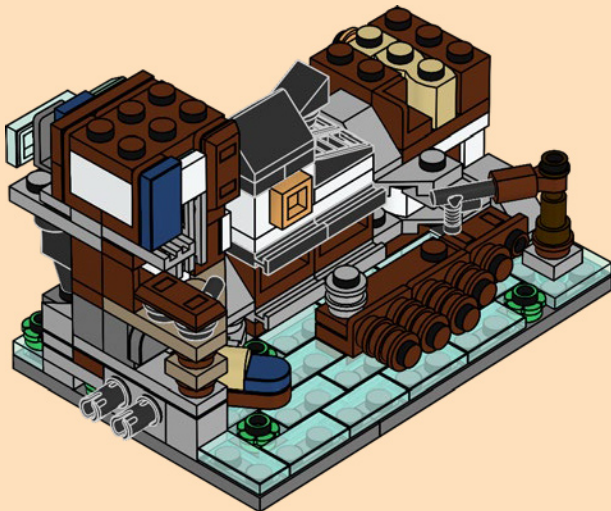



1x



1x

# 70

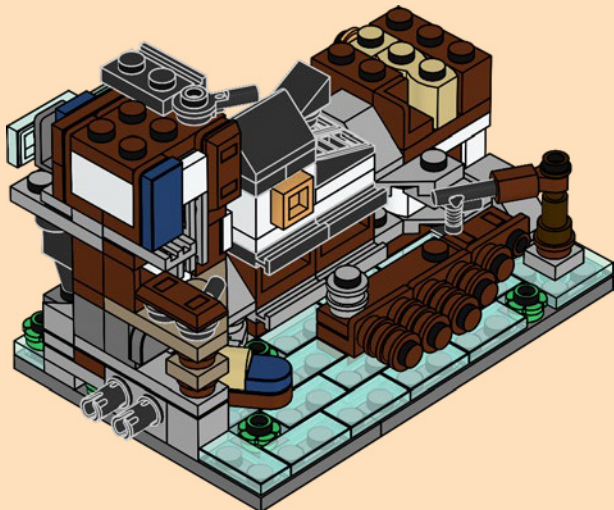



1x

71

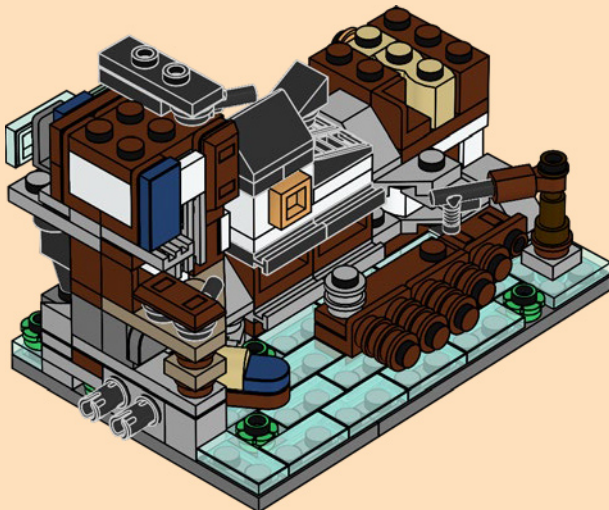

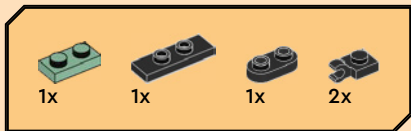

72

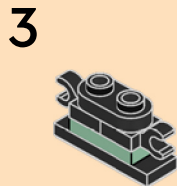
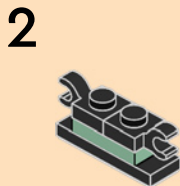
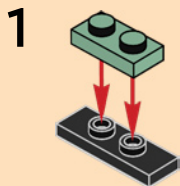

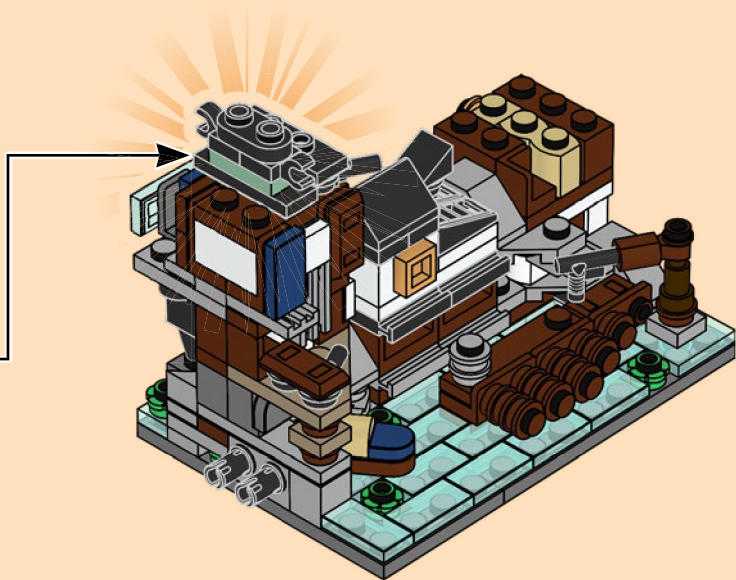



2x

# 73

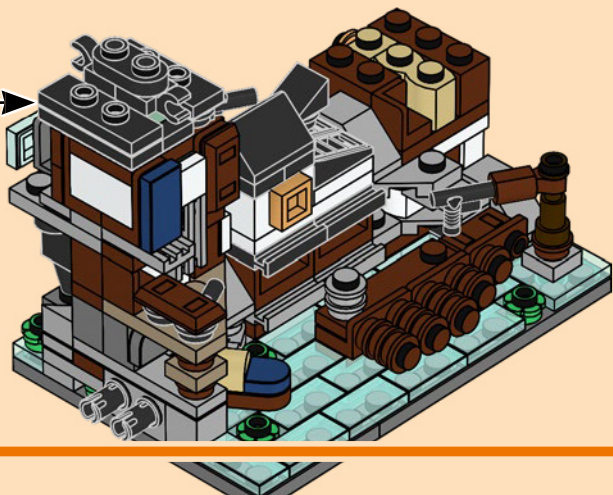
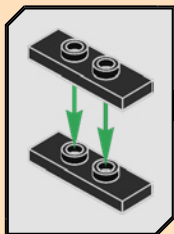



2x

74



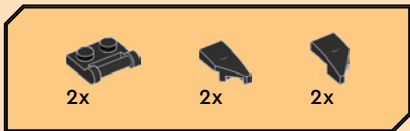

75

1



2

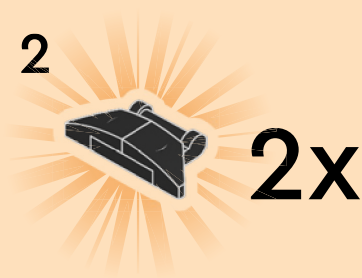



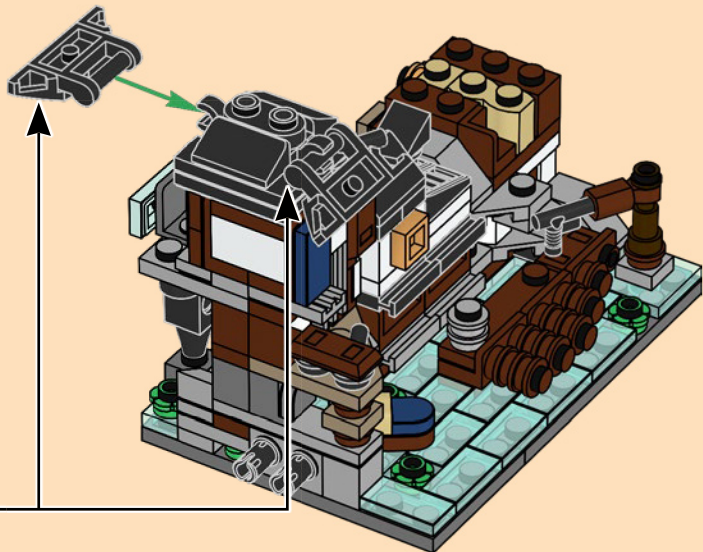



# 76

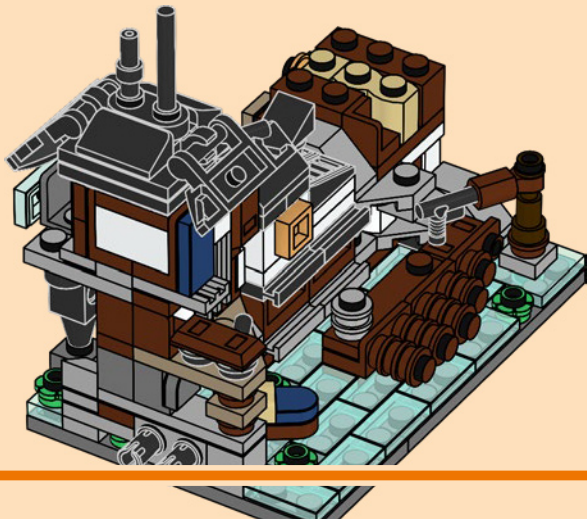



1x

77

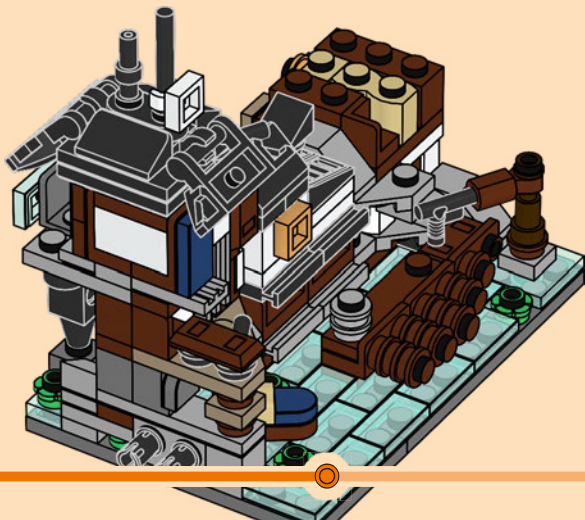



78

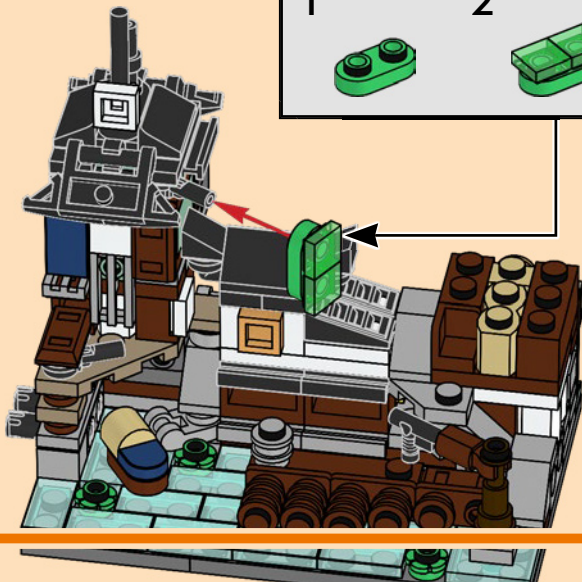
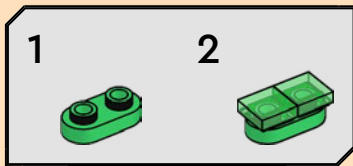

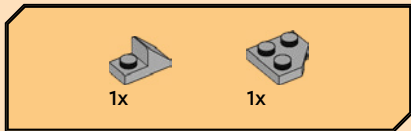

79

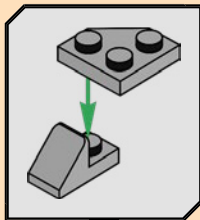
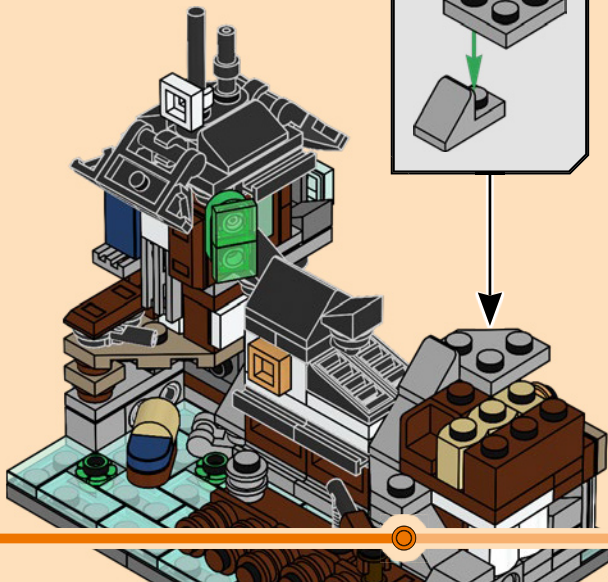

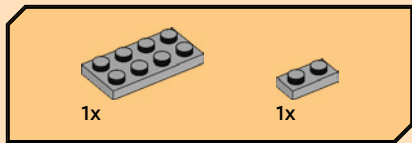

80



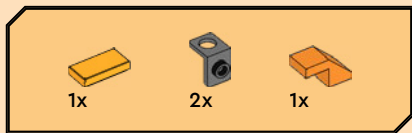

81

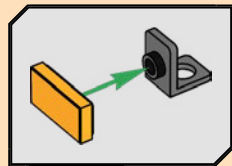
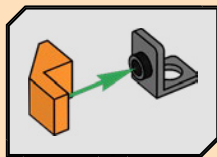



1x



1x

82





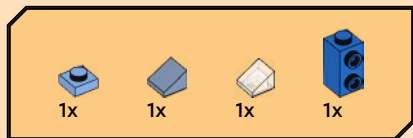

83

1



2

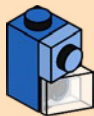

3

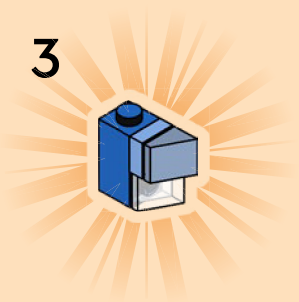

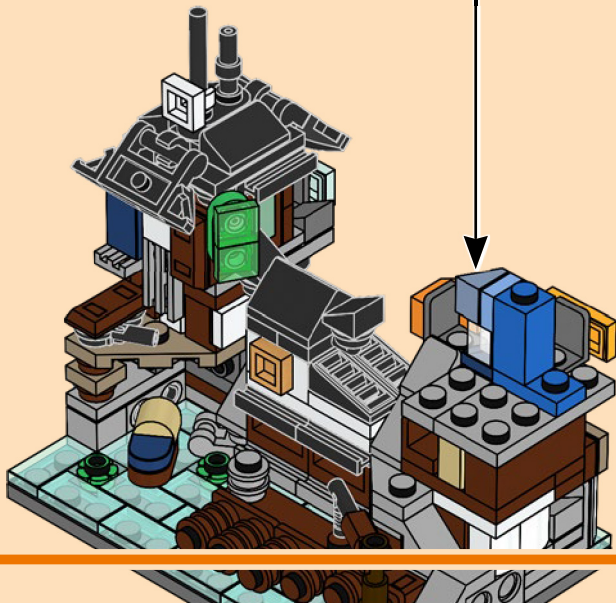



84

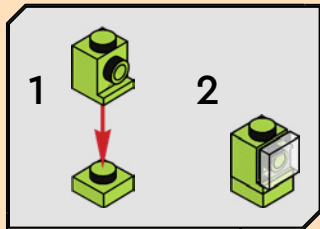

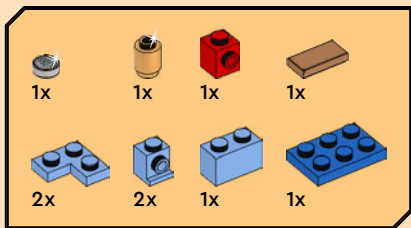

85

1

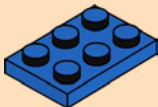

2

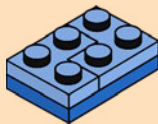

3

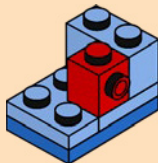

4

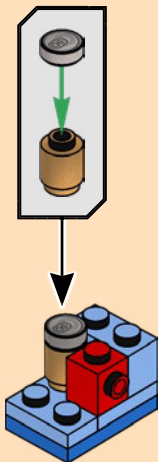

5

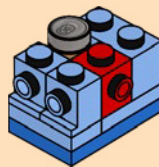

6







1x



1x

86



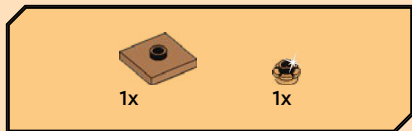

87

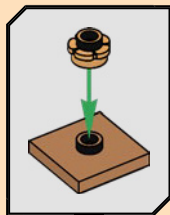





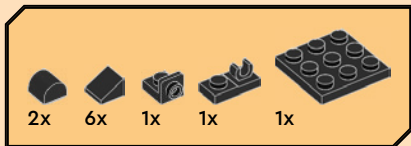

89

1

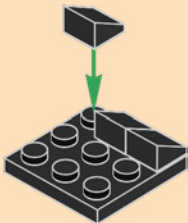

2

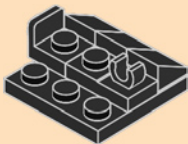

3

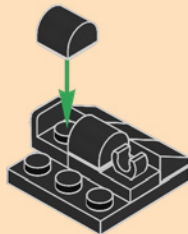

4

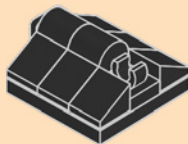



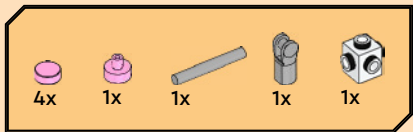

90

1



2

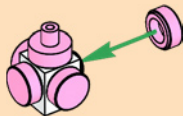

3

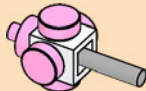

4

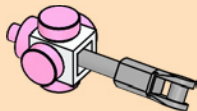



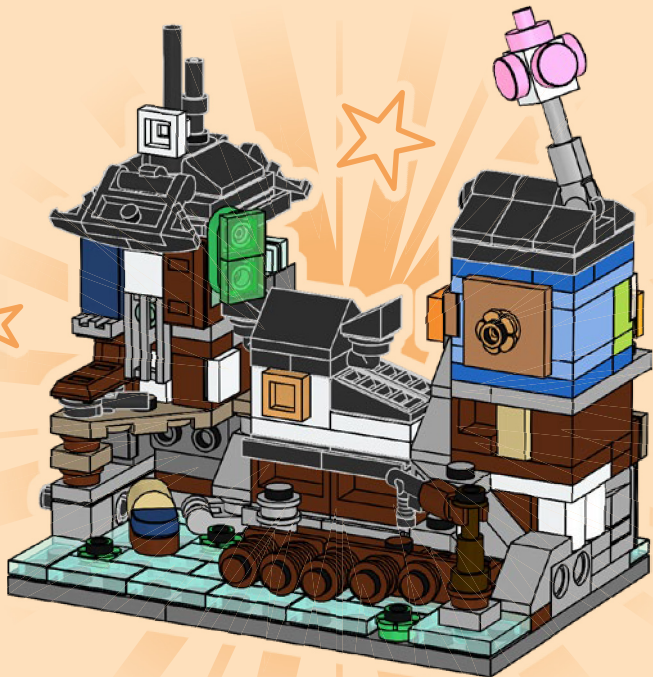



# NINJAGO

40704



40703

COLLECTIONNEZ LES 4  
COLECCIONA LOS 4

COLLECT ALL 4



40703

+



40704

+



40705

+



40706



1x  
300501



3x  
6059185



1x  
235701



1x  
4111971



2x  
370001



2x  
307001

108



1x  
302001



1x  
6348055



1x  
6469441



2x  
6210076



1x  
302201



1x  
242001



1x  
6290531



1x  
302423



3x  
302323



1x  
302123



1x  
6390153



1x  
654126



8x  
4504382



2x  
4548180



1x  
4163373



2x  
6273589



2x  
6181720



2x  
6181713



4x  
6199908



1x  
6174917



2x  
6308000



2x  
6196548



2x  
6261348



1x  
6347310



3x  
4107761



2x  
4225201



2x  
6168646



1x  
614126



1x  
6371584



1x  
6093525



1x  
4537551



1x  
6056234



2x  
4541191



2x  
6279875



3x  
6210270



1x  
6234695





1x  
6245250



1x  
6254254



2x  
6252043



18x  
6251295



2x  
6443647



1x  
6181314



1x  
6315194



1x  
4621557



1x  
6286329



1x  
4218749



1x  
4118793



1x  
6062686



3x  
6055172



1x  
6230579



4x  
6284587



1x  
4549436



2x  
6254249



1x  
4616581



1x  
6328131



1x  
4655080



1x  
6372467



3x  
6261744



2x  
4211242



1x  
4211149



1x  
4211220



4x  
4225469



1x  
4211222



3x  
4221744



2x  
6251470



3x  
4211152



2x  
4211189



1x  
6257604



3x  
4221590



3x  
6341553



3x  
6174856



1x  
6226436



2x  
4645103



15x  
4216581



1x  
6248944



2x  
4645400



2x  
6291040



1x  
6341968



1x  
6038637



1x  
4622062



1x  
4541506



2x  
4528488



1x  
6444941



1x  
6199890

110



1x  
6060800



1x  
6069887



1x  
4523159



1x  
6209691



1x  
6167641



1x  
6021997



1x  
6102994



1x  
6210271



6x  
6135287



1x  
6329651



1x  
307024



1x  
6258091



1x  
4558886



1x  
6322904

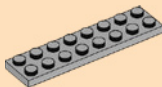

1x  
4211406



5x  
4211353



1x  
4179833



2x  
6070689



1x  
4179826



3x  
6332365



1x  
6170268



1x  
4211389



2x  
4211541



2x  
4521921



3x  
6213378



1x  
6093859



1x  
4211614



3x  
4211399



1x  
4558169



3x  
4211398



5x  
6257593



1x  
4538950



1x  
4211061



1x  
4210802



2x  
6345639



1x  
4211396



1x  
6133247



2x  
6362252



1x  
6092572



3x  
4211525



1x  
4211395



1x  
6214341



1x  
4504378



3x  
6186657



1x  
6093527



1x  
4211044



1x  
6388133



1x  
6093527



3x  
6015347



1x  
4558955



1x  
6230233



1x  
6343976



2x  
4211568



3x  
6170811



2x  
4211350



2x  
6225246



[LEGO.com/service](https://www.lego.com/service)

YOU COULD

WIN



Scan this QR code or go to  
**LEGO.COM/PRODUCTFEEDBACK** and give us  
your short feedback about this LEGO® set  
for a chance to win a cool LEGO prize.

Terms and Conditions apply\*

**EN: YOU COULD WIN.** Terms and Conditions apply\* **DE: Du könntest GEWINNEN.** Es gelten die Teilnahmebedingungen\* **FR: Tu pourrais GAGNER.** Des conditions s'appliquent\* **IT: Potresti VINCERE tu.** Termini e condizioni sono applicabili\* **ES: Puedes GANAR.** Aplican términos y condiciones\* **PT: Poderá GANHAR.** Aplicam-se termos e condições\* **ZH: 轻松获奖.** 条款和条件适用\* **PL: Szansa na WYGRANĄ.** Obowiązują warunki korzystania\* **CS: Máte šanci VYHRÁT.** Platí všeobecné smluvní podmínky\* **SK: Máte šancu VYHRÁT.** Platia všeobecné zmluvné podmienky\* **HU: TE IS NYERHETSZ.** Felhasználási feltételek érvényesek\* **RO: Ai putea CÂȘTIGA.** Se aplică termenii și condiții\* **BG: Можете да СПЕЧЕЛИТЕ.** Има определени правила и условия\* **LV: Tu vari LAIMĒT.** Ir spēkā noteikumi un nosacījumi.\* **ET: Sul on võimalus VÕITA.** Kehtivad tingimused\* **LT: Jūs galite LAIMĖTI.** Taikomos sąlygos\*

\*[LEGO.com/productfeedback-terms](https://www.lego.com/productfeedback-terms)

LEGO, the LEGO logo, NINJAGO and the NINJAGO logo are trademarks of the/son  
des marques de commerce du/son marcas registradas de LEGO Group.

©2024 The LEGO Group.

6497855