



40714





LEGO.com/sustainable-packaging



 ^{FR} **DONNEZ**
OU
RECYCLEZ

 OU  OU 

ASSOCIATION MAGASIN DÉCHÈTERIE

Adresses sur quefairedemesdechets.fr

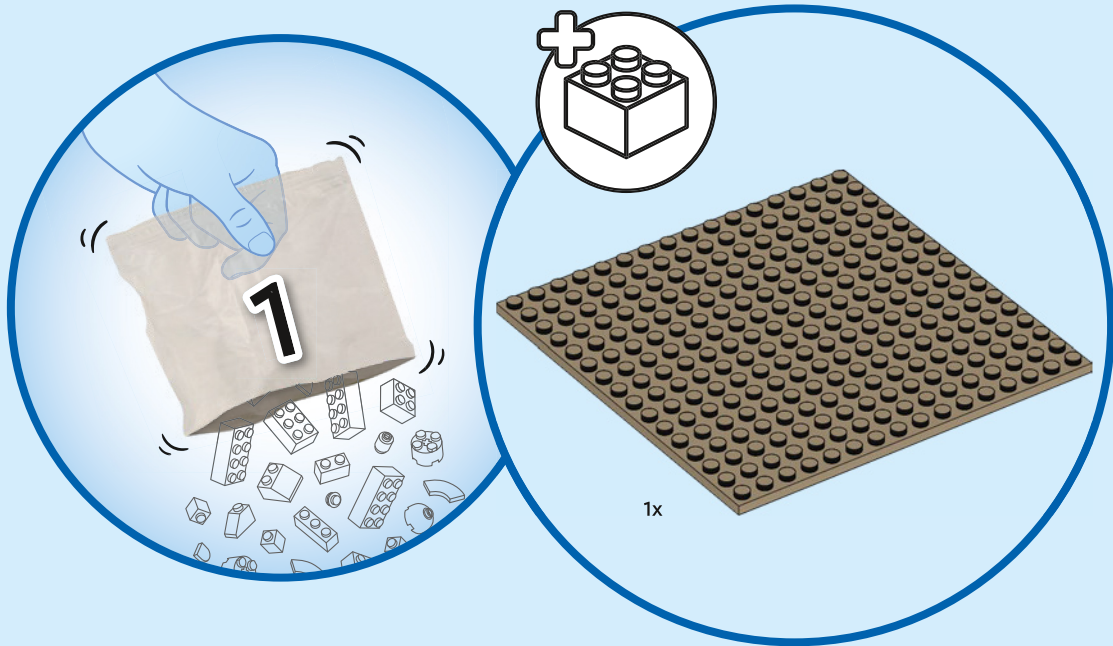

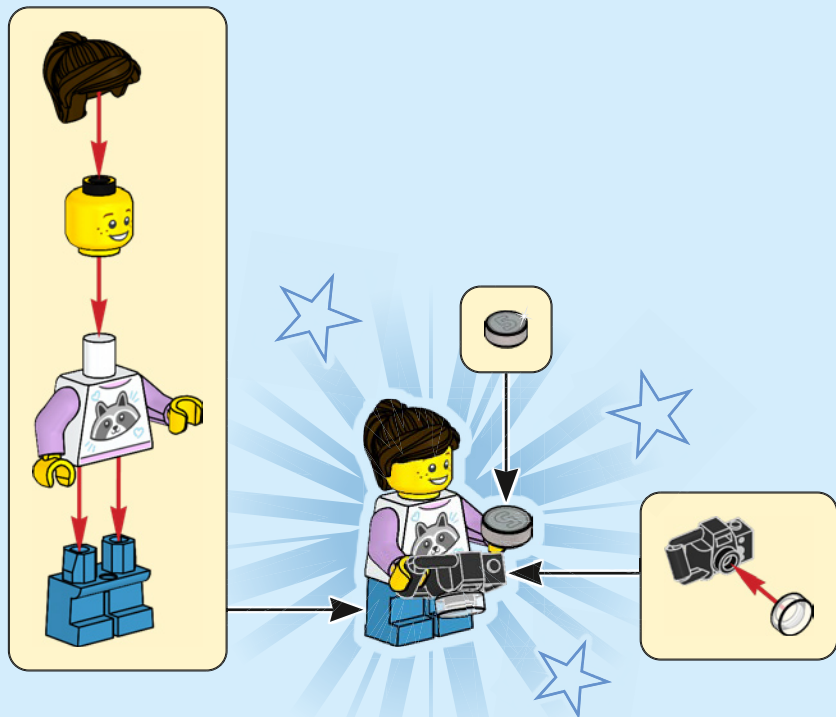

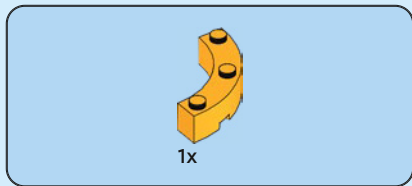

1

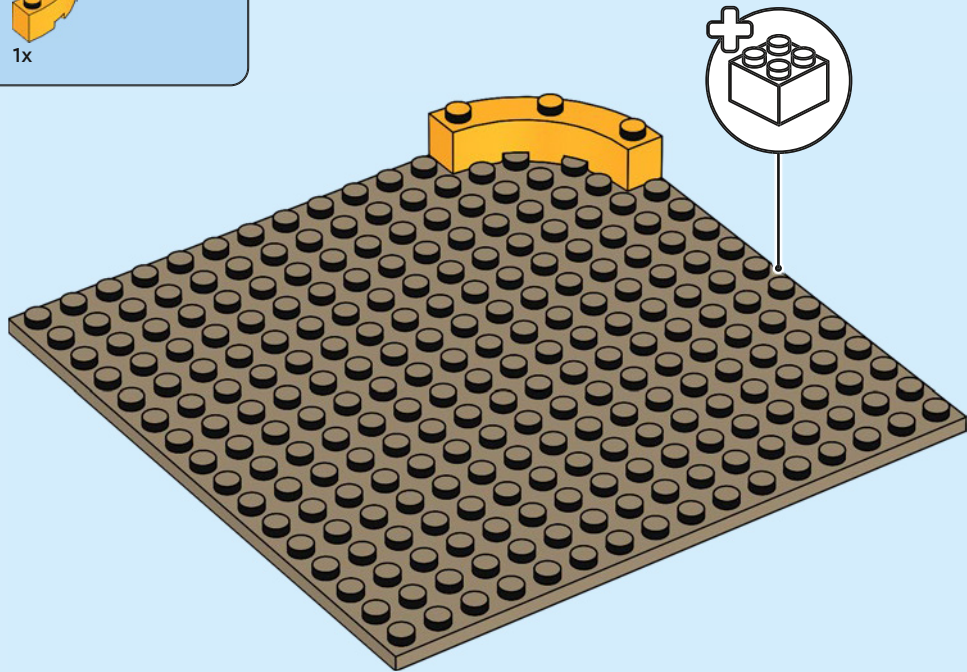



2x



1x

2

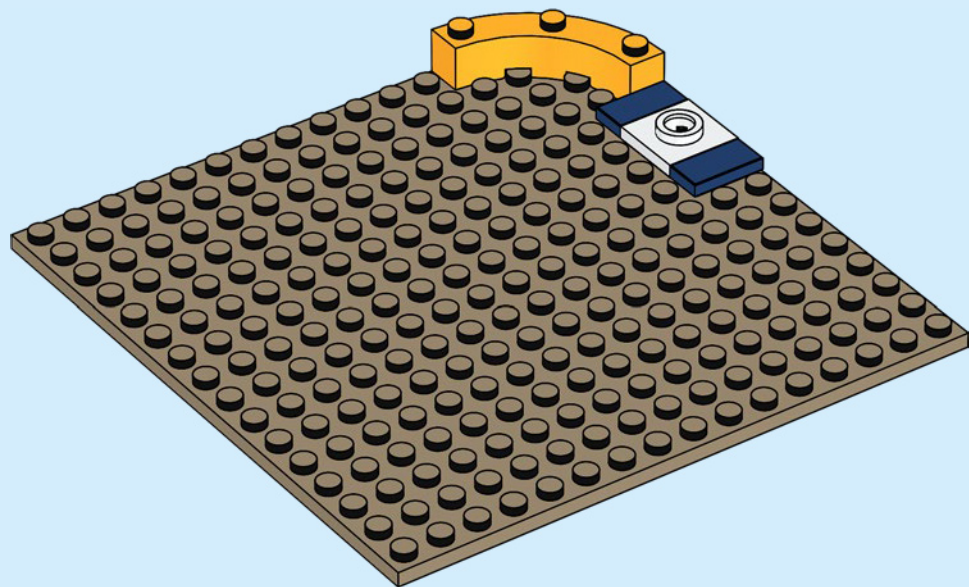

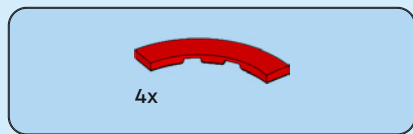

3

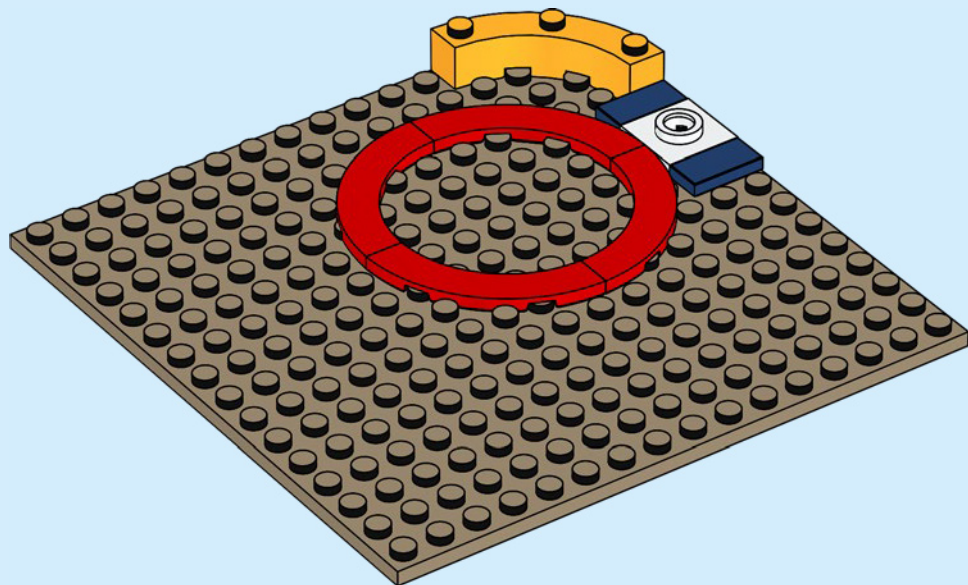

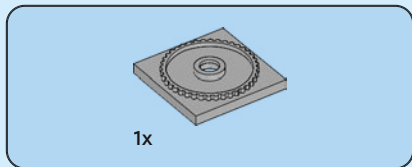

4

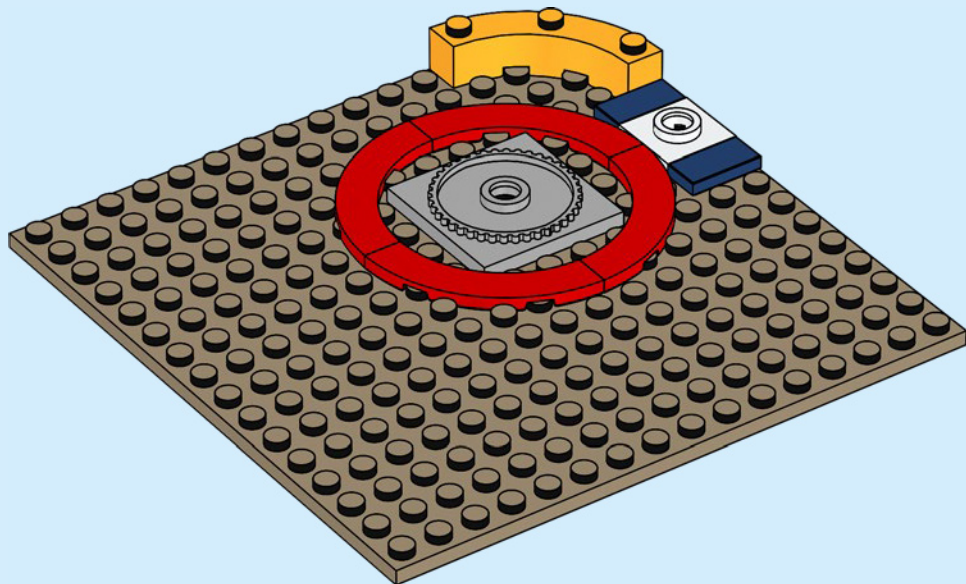

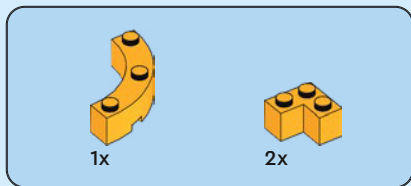

5

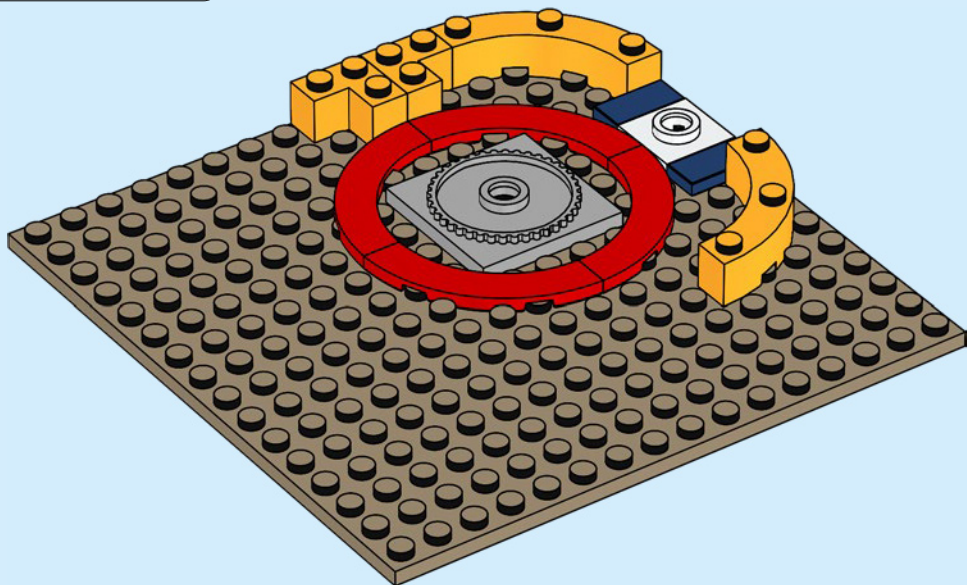



2x



1x

6

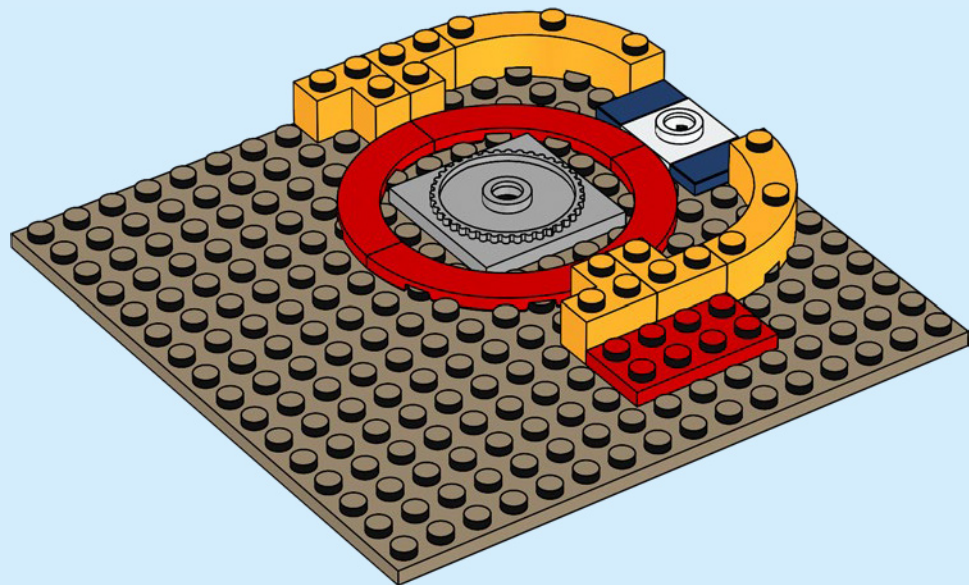

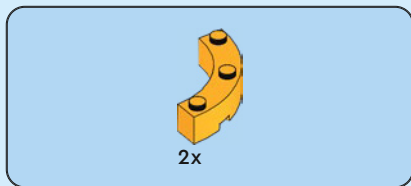

7

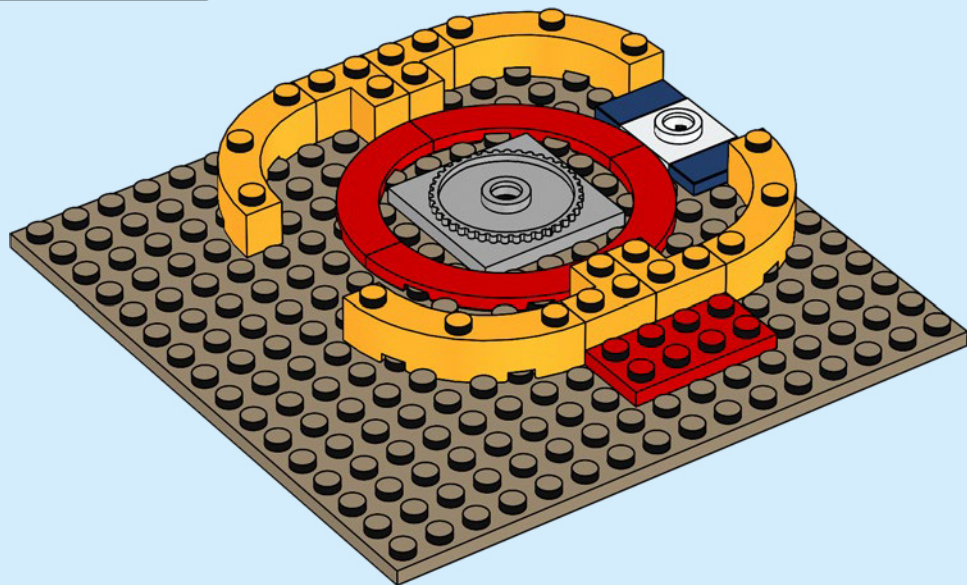



2x

8

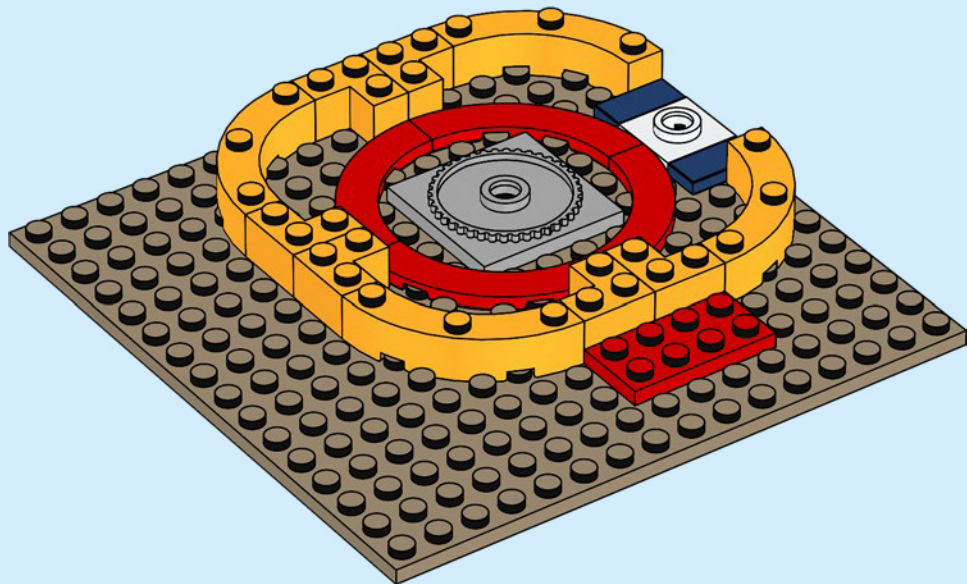

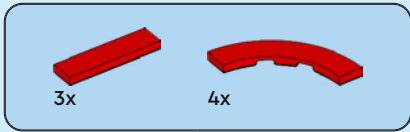

9

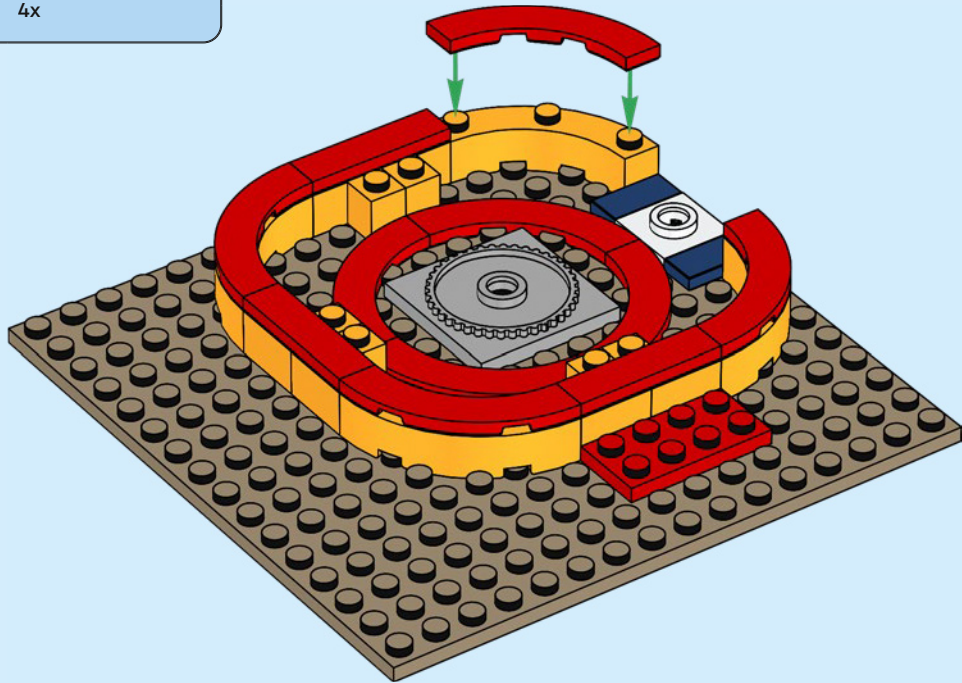



3x

10

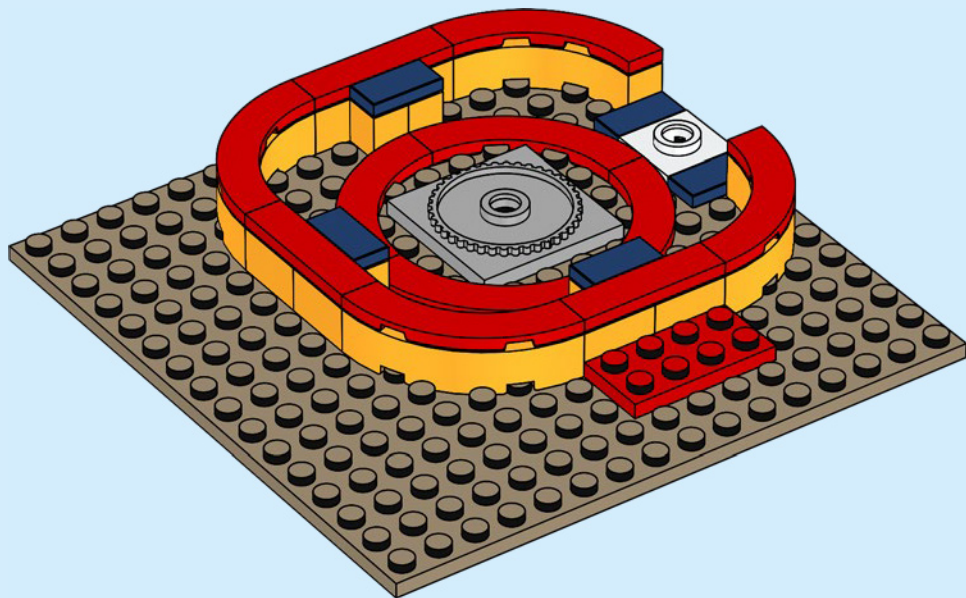

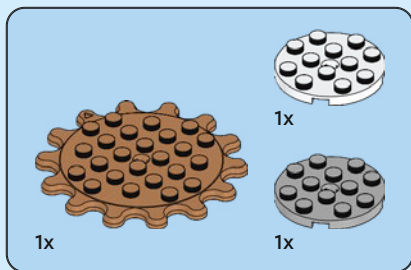

11

1

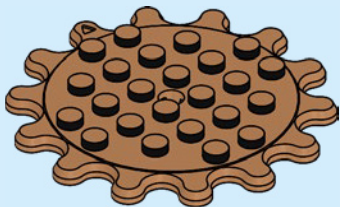

2



3

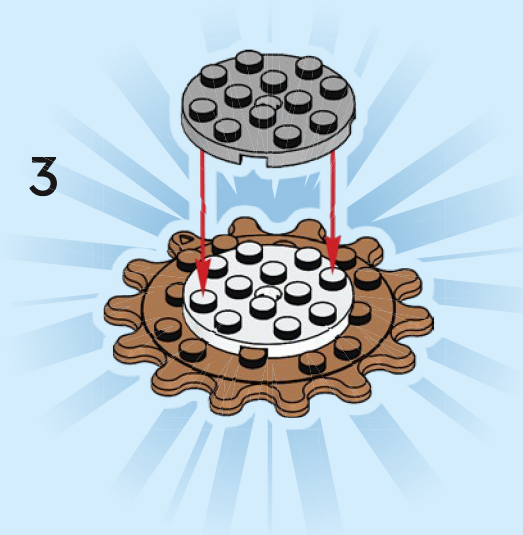

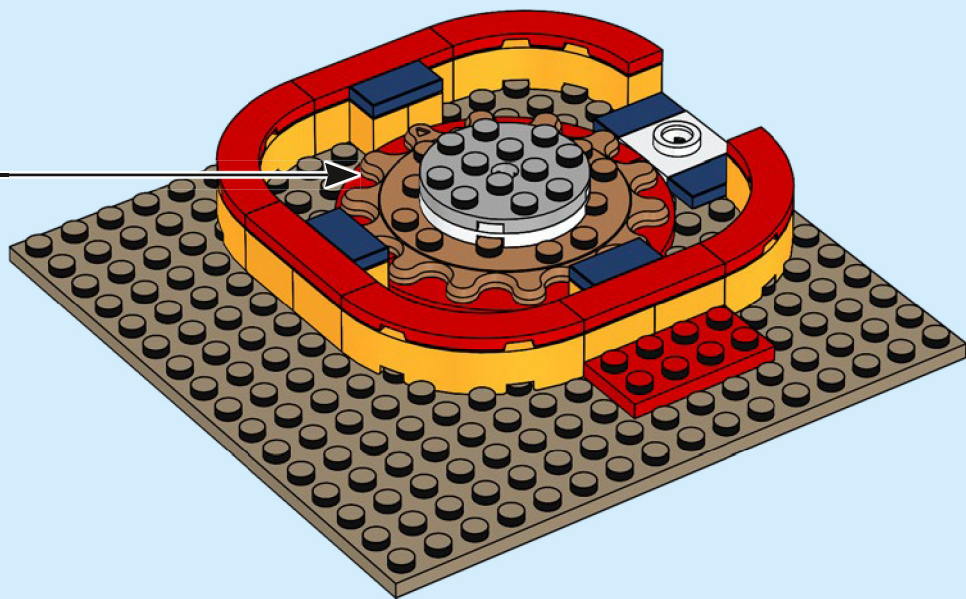



12

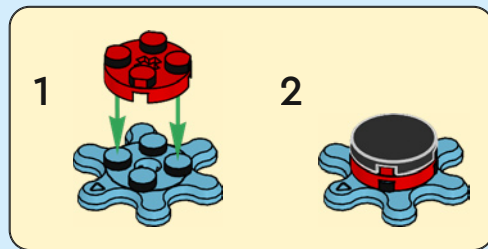



1x

13





1x



1x

14





1x

15



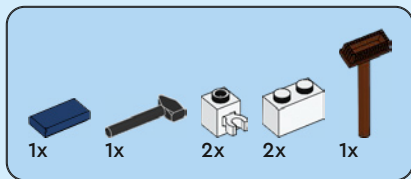

16

1

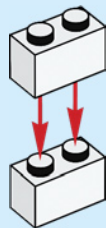

2

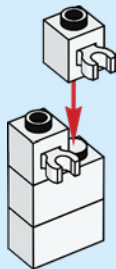

3

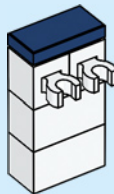

4

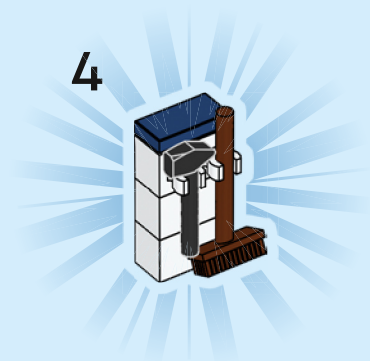



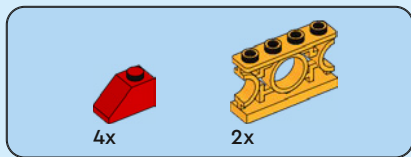

17





4x

18

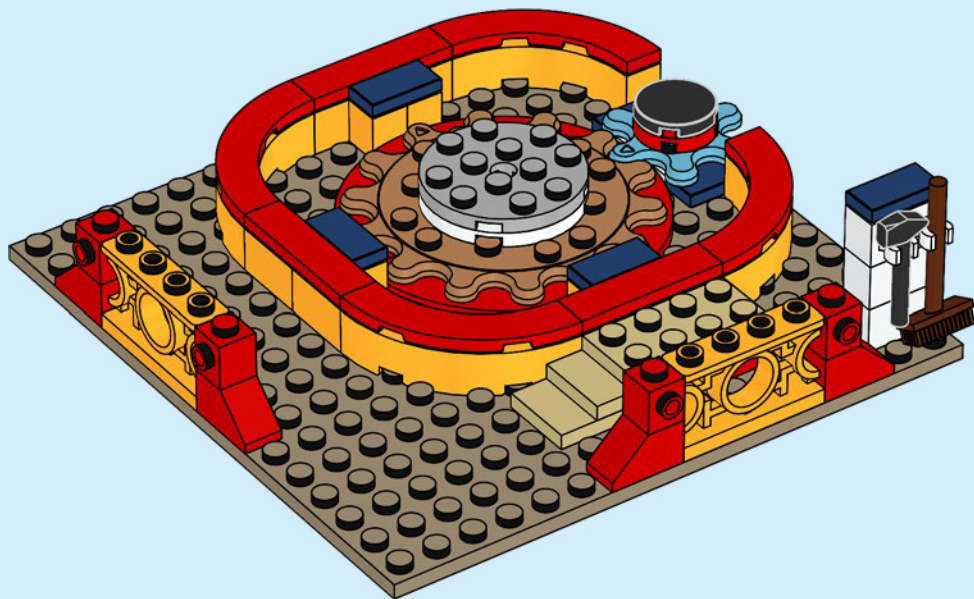

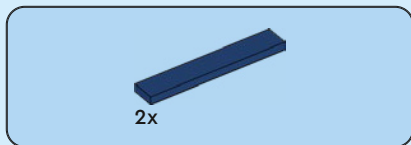

19





4x

20



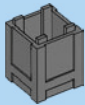

1x



1x

21

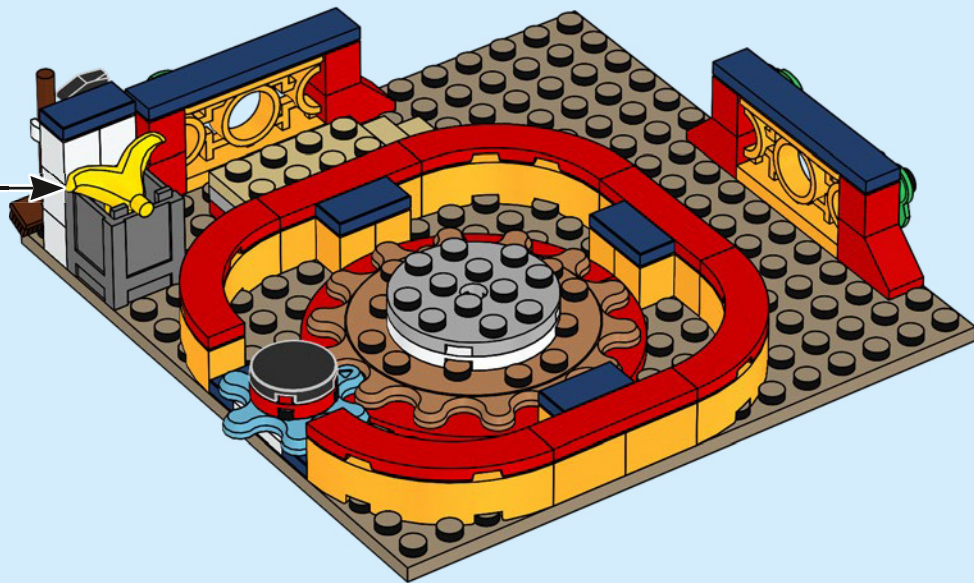

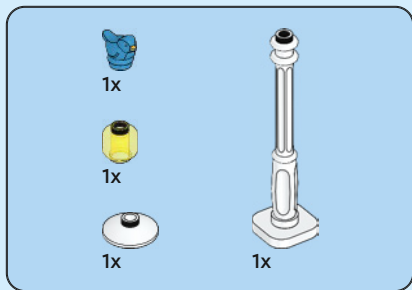

22

1

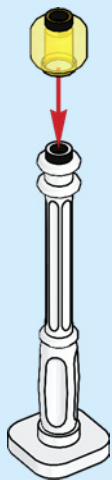

2

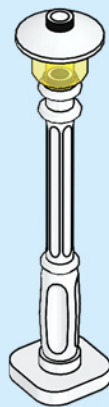

3

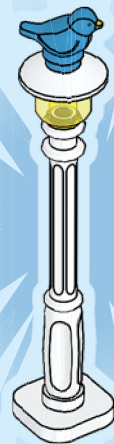



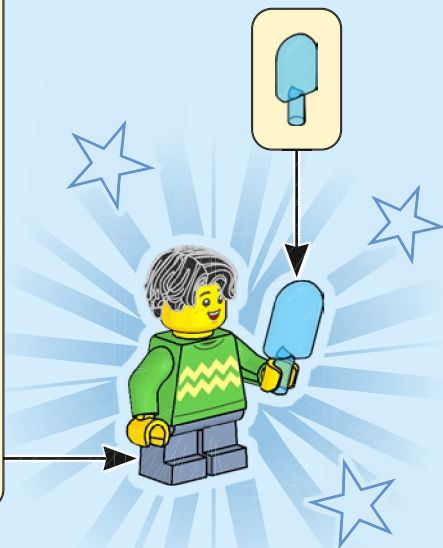
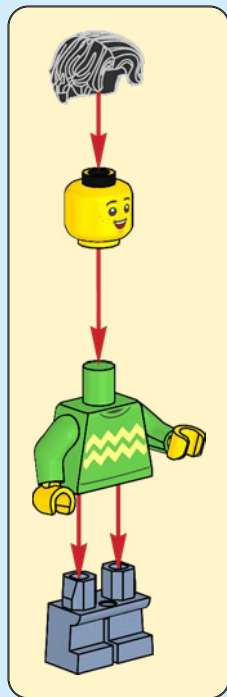

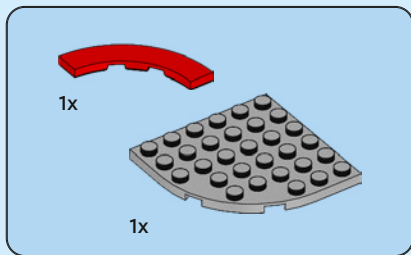
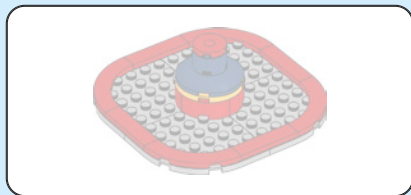

23

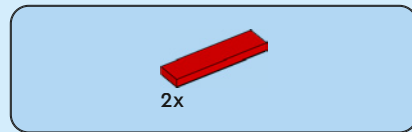
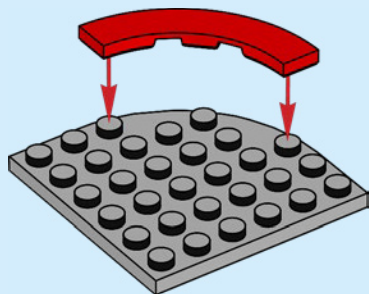

24

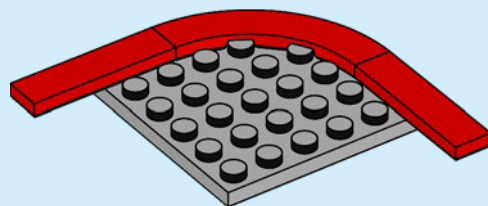

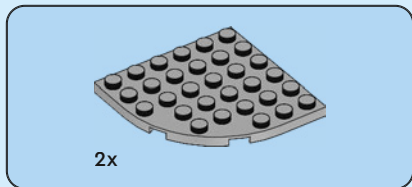

25

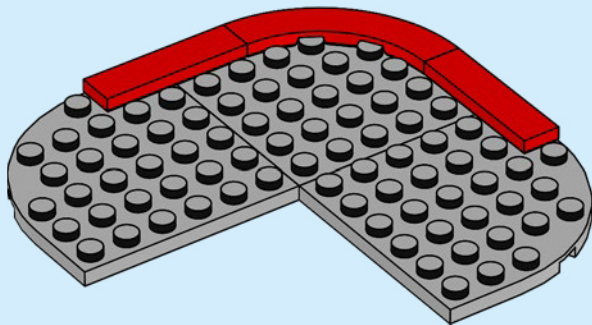

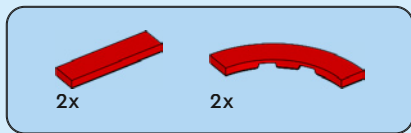

26

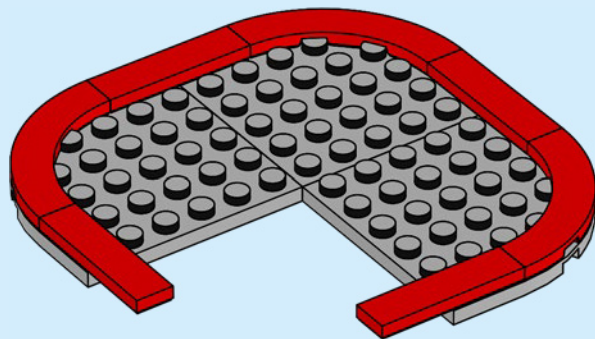

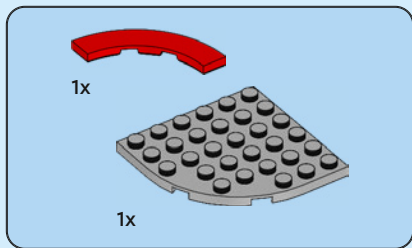

27

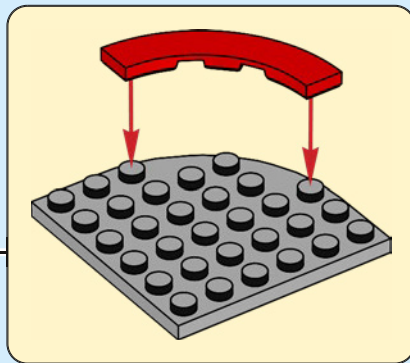
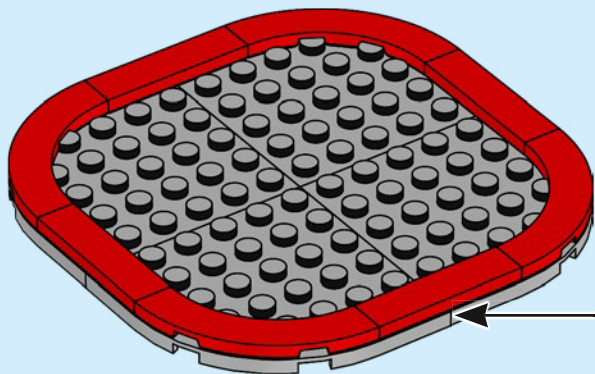



1x

28

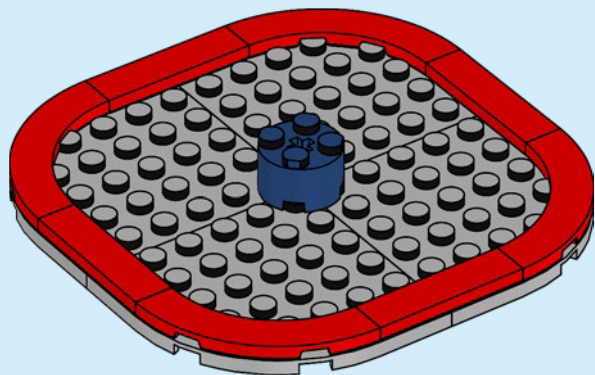

4x

29

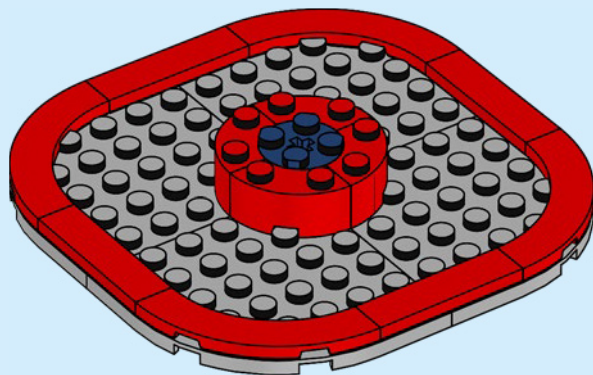



1x

30

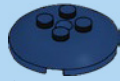
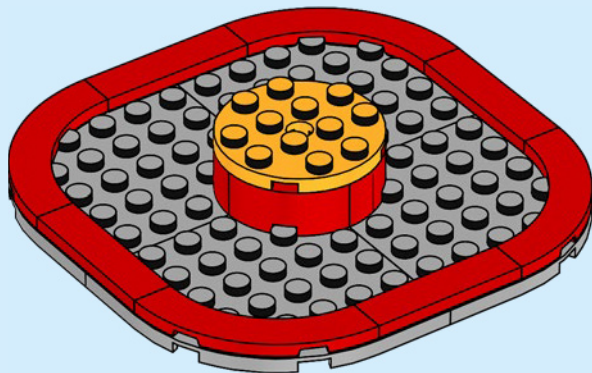

1x

31

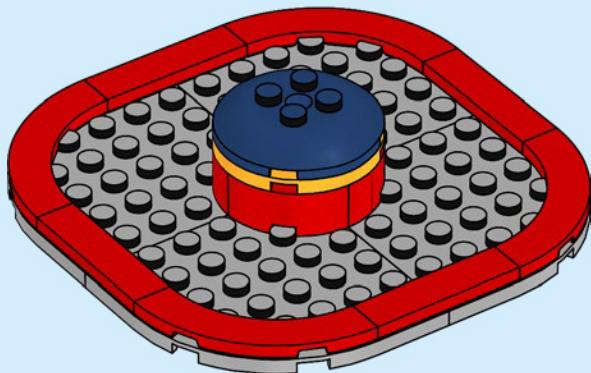

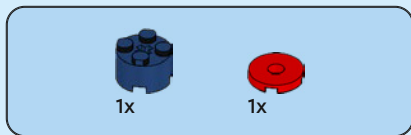

32

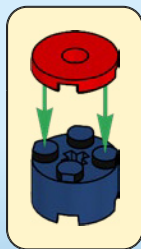

33

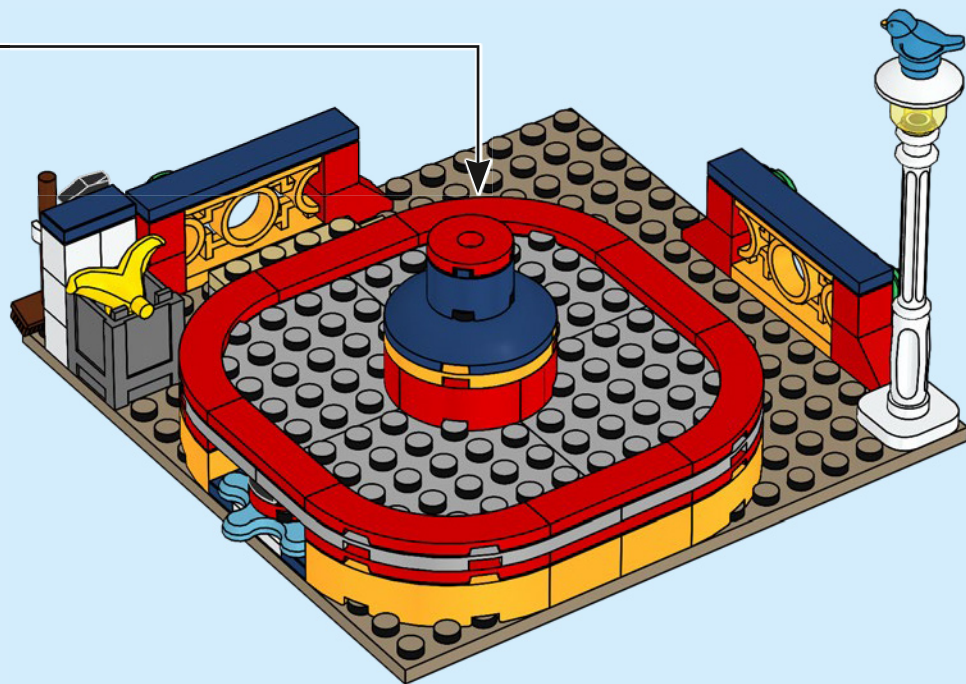



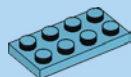

1x

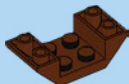

1x

34

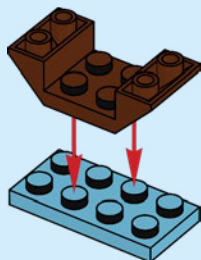

2x

35

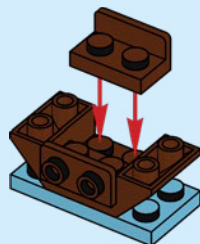



1x

36

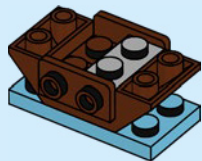

1x



1x

37

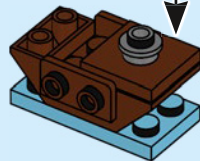
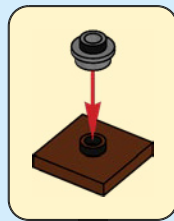



38

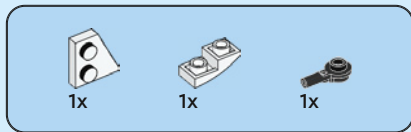
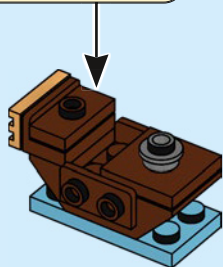
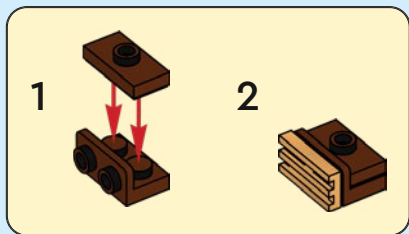

39

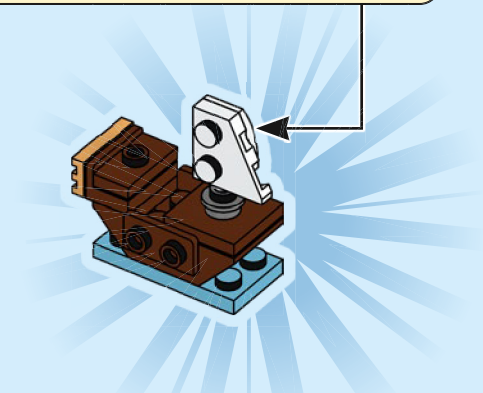
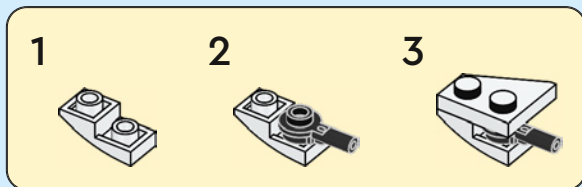

40

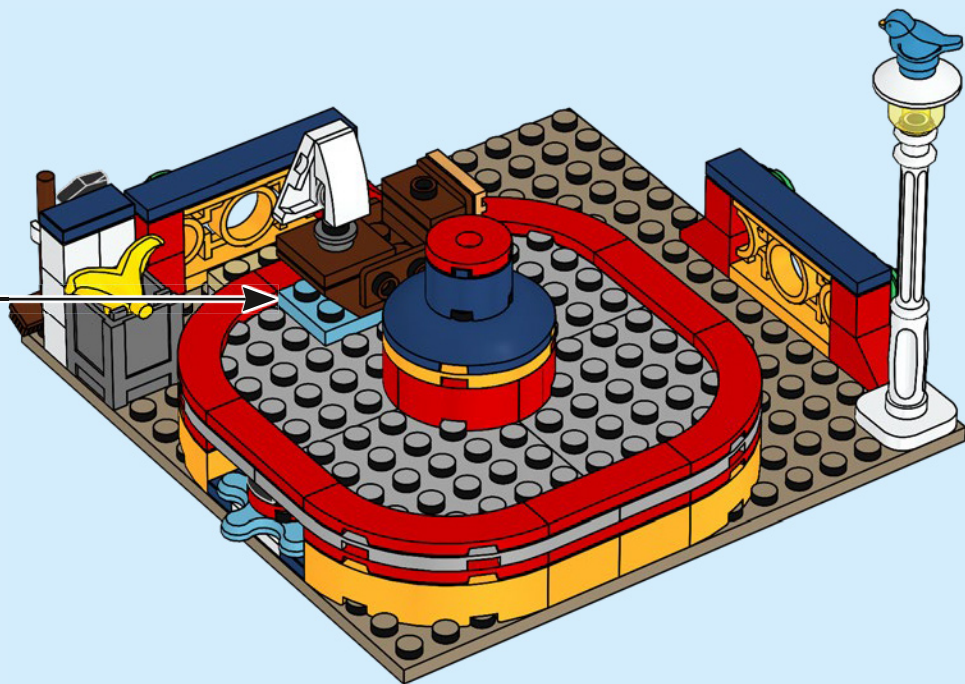

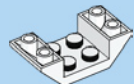

1x

41

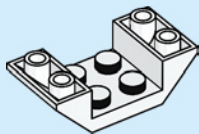

2x

42

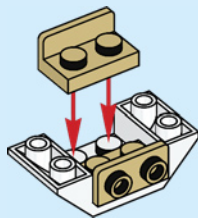



1x



1x

43

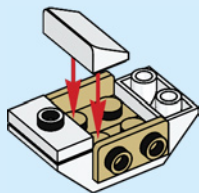

1x



1x

44

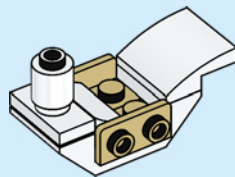

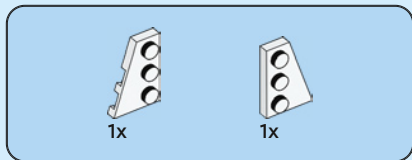

45

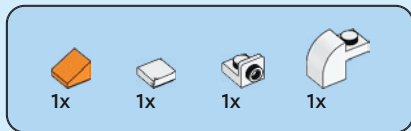
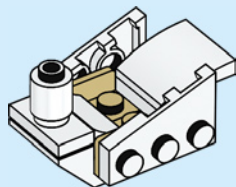

46

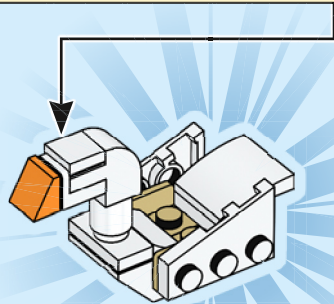
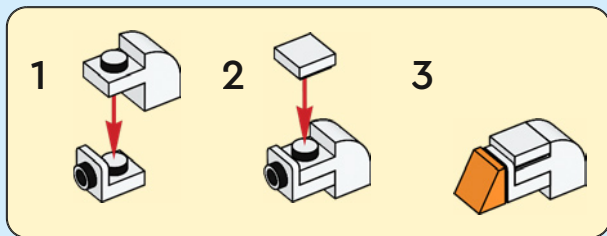

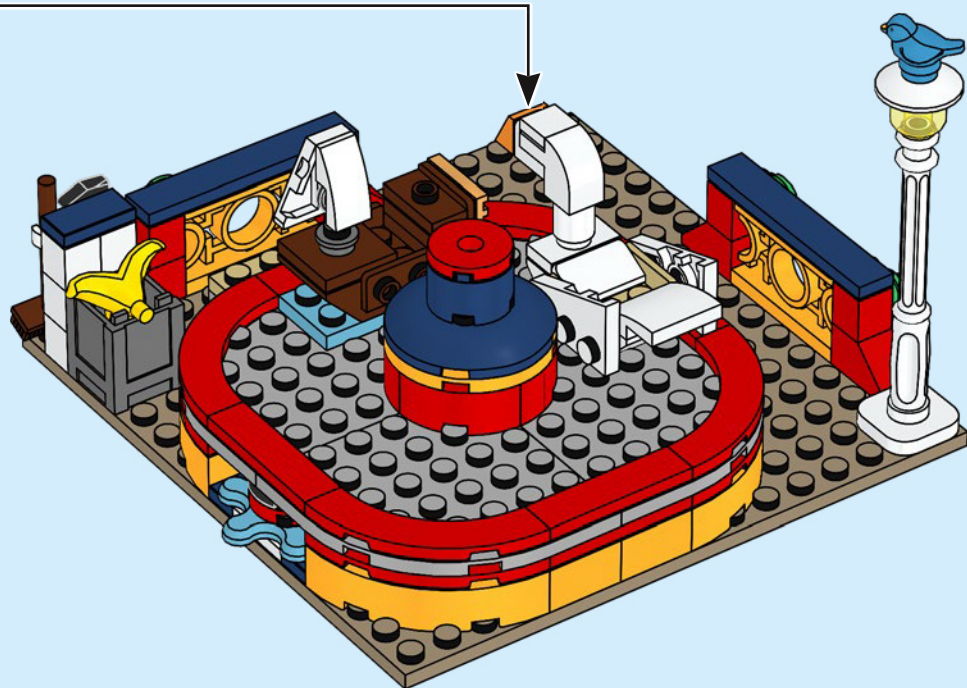

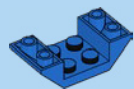

1x

48

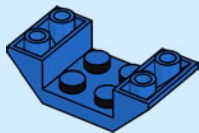

2x

49

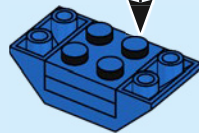
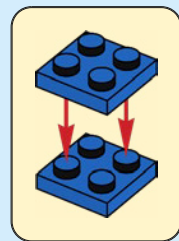



50

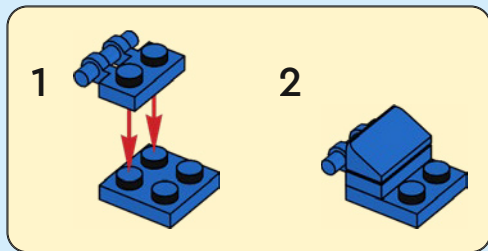

2

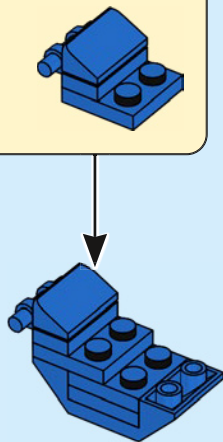



2x



2x

51

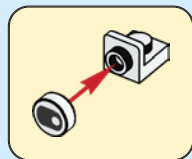
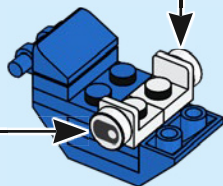
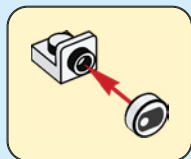

52



1x

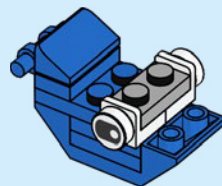



2x

53

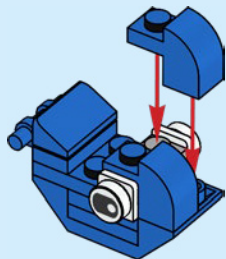

1x

54

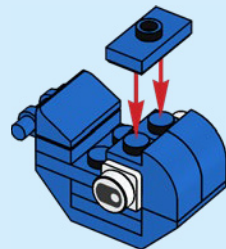



1x



1x

55

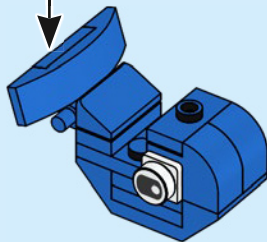
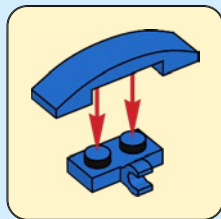

1x

56

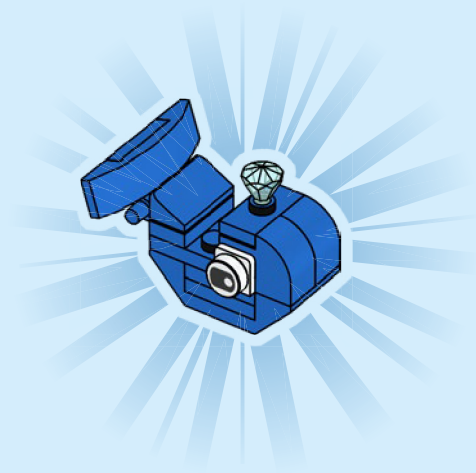

57

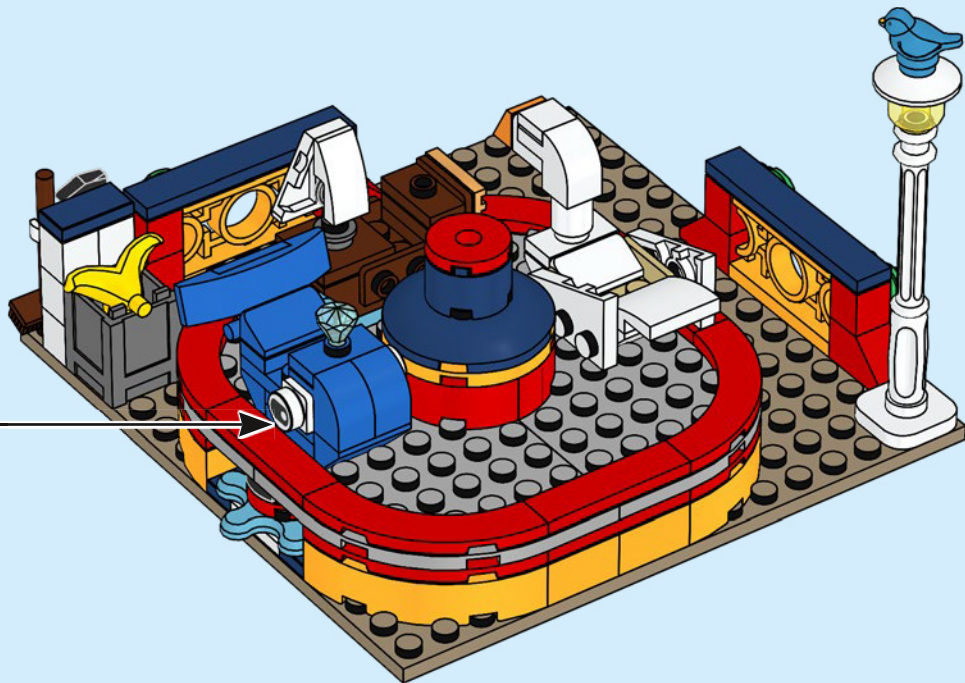



1x



1x

58

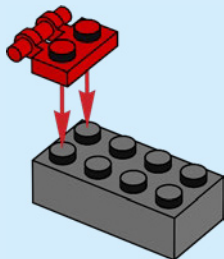

1x



2x

59

1



2

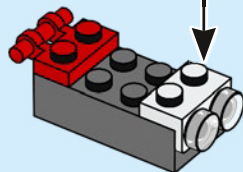
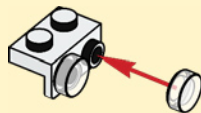

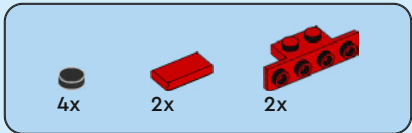

60

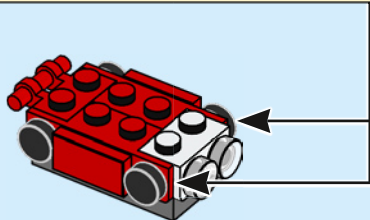
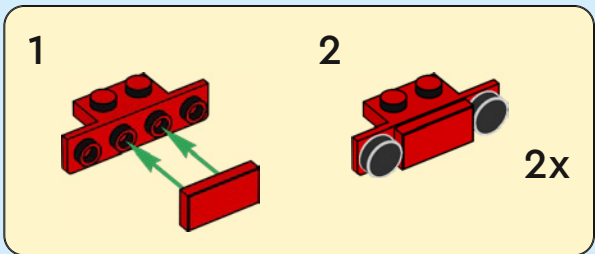



2x



1x



2x

61

1

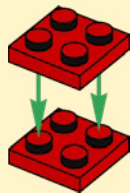

2



3

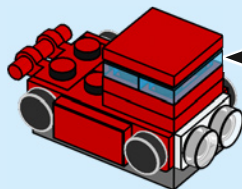
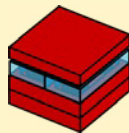

1x



1x

62

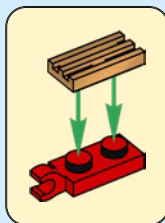

63

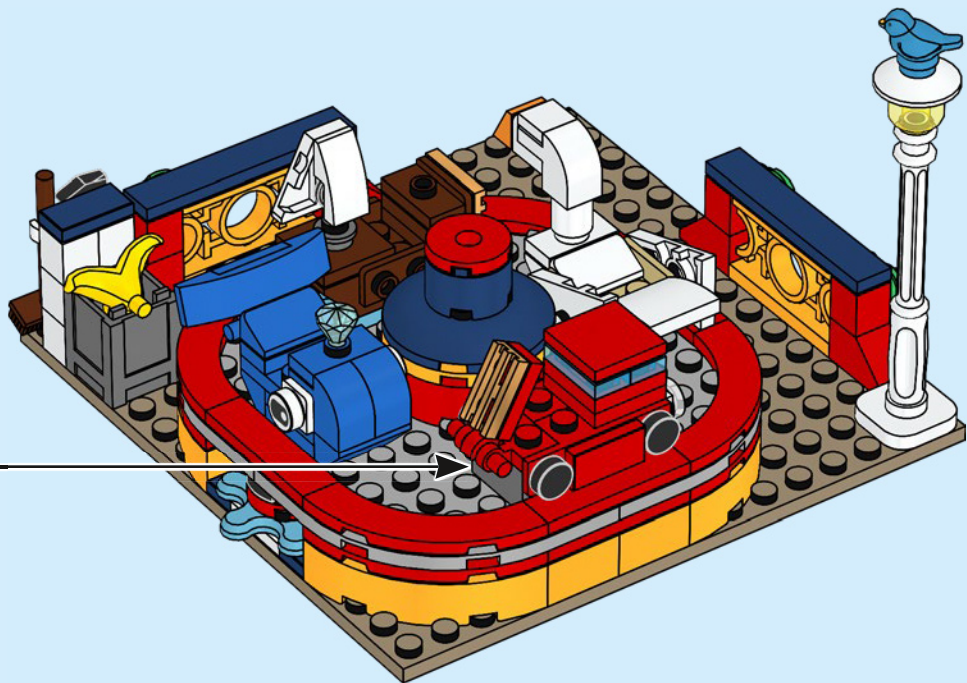

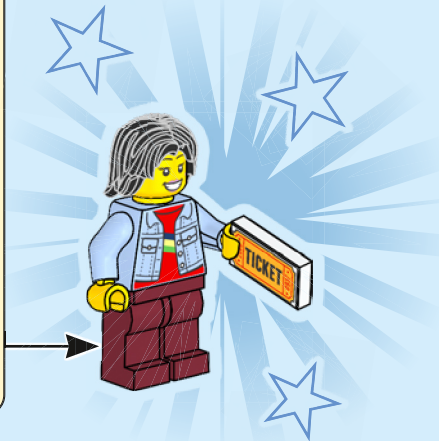
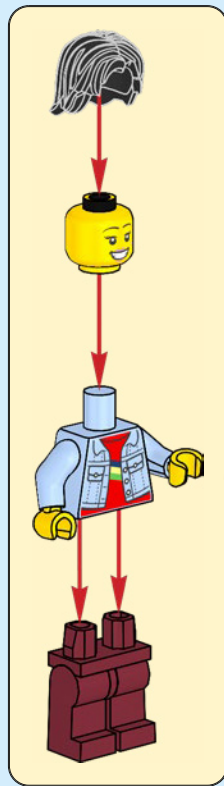
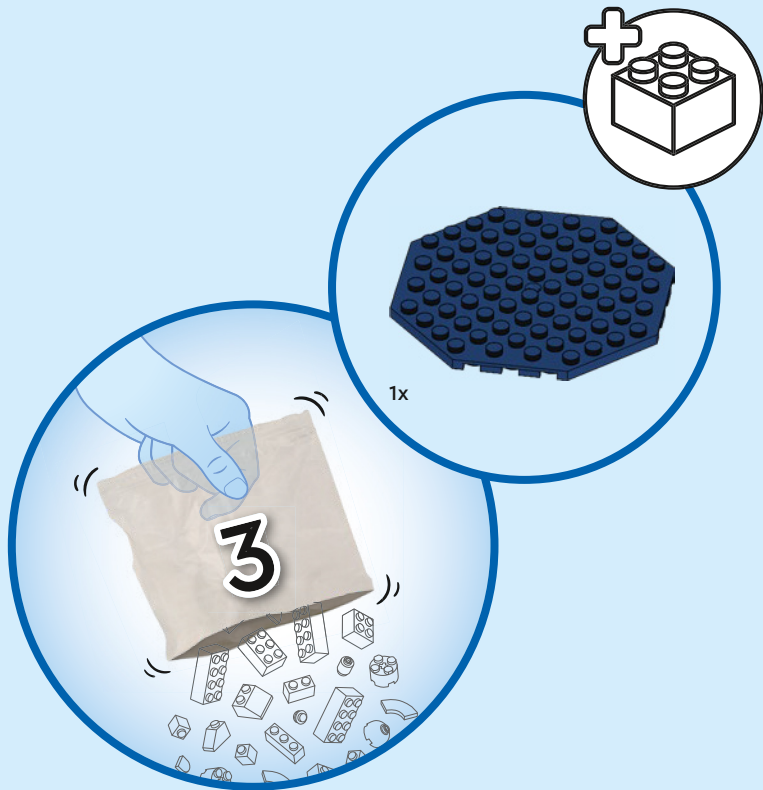

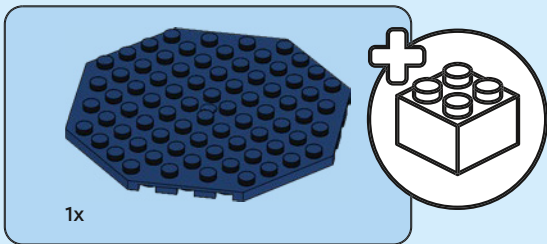
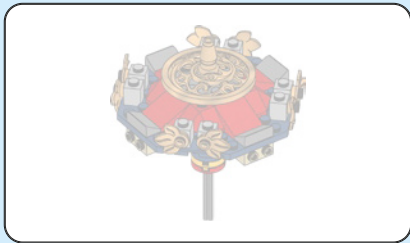

64

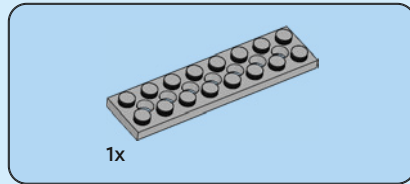
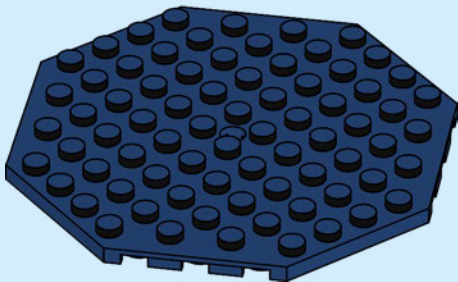

65

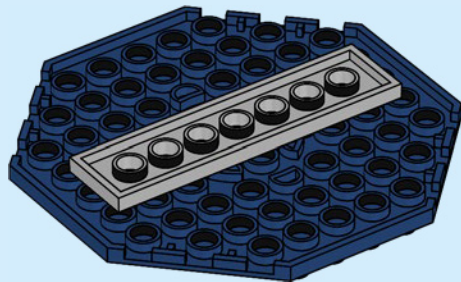



2x

66

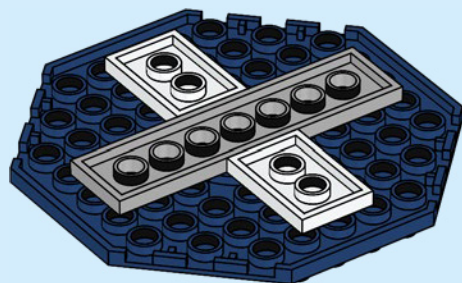



67

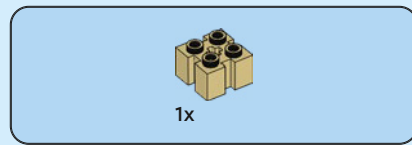
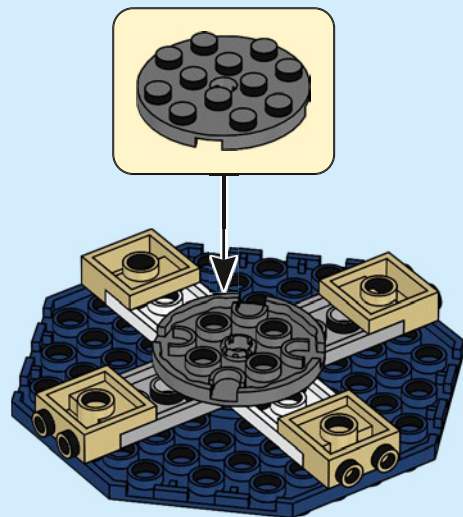

68

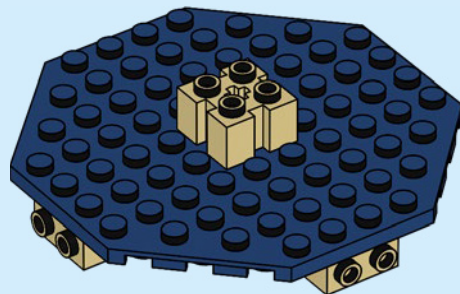

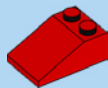

4x

69

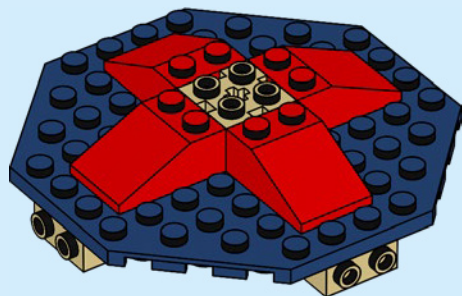



4x

70

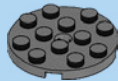
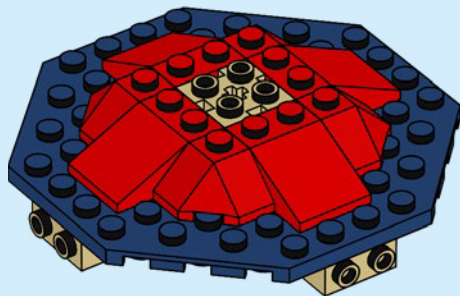

1x



4x

71

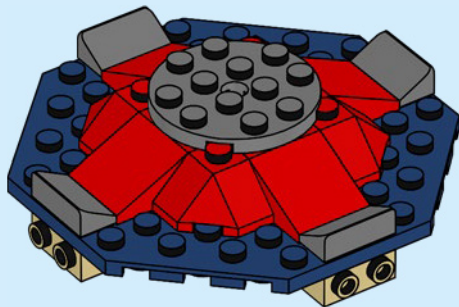



8x

72

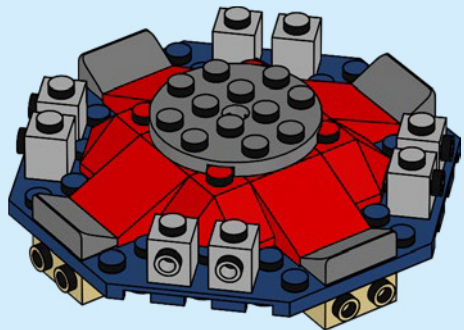

8x

73

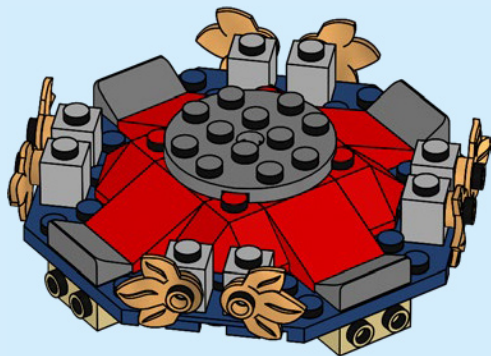

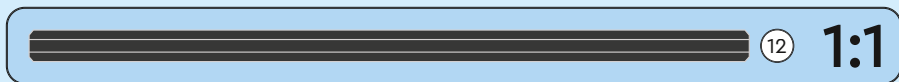
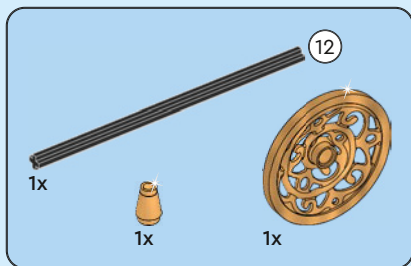

74

1

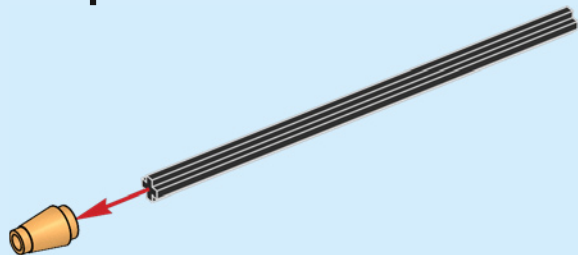

2

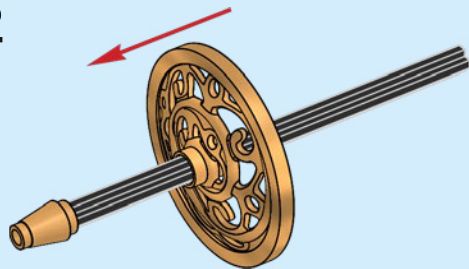

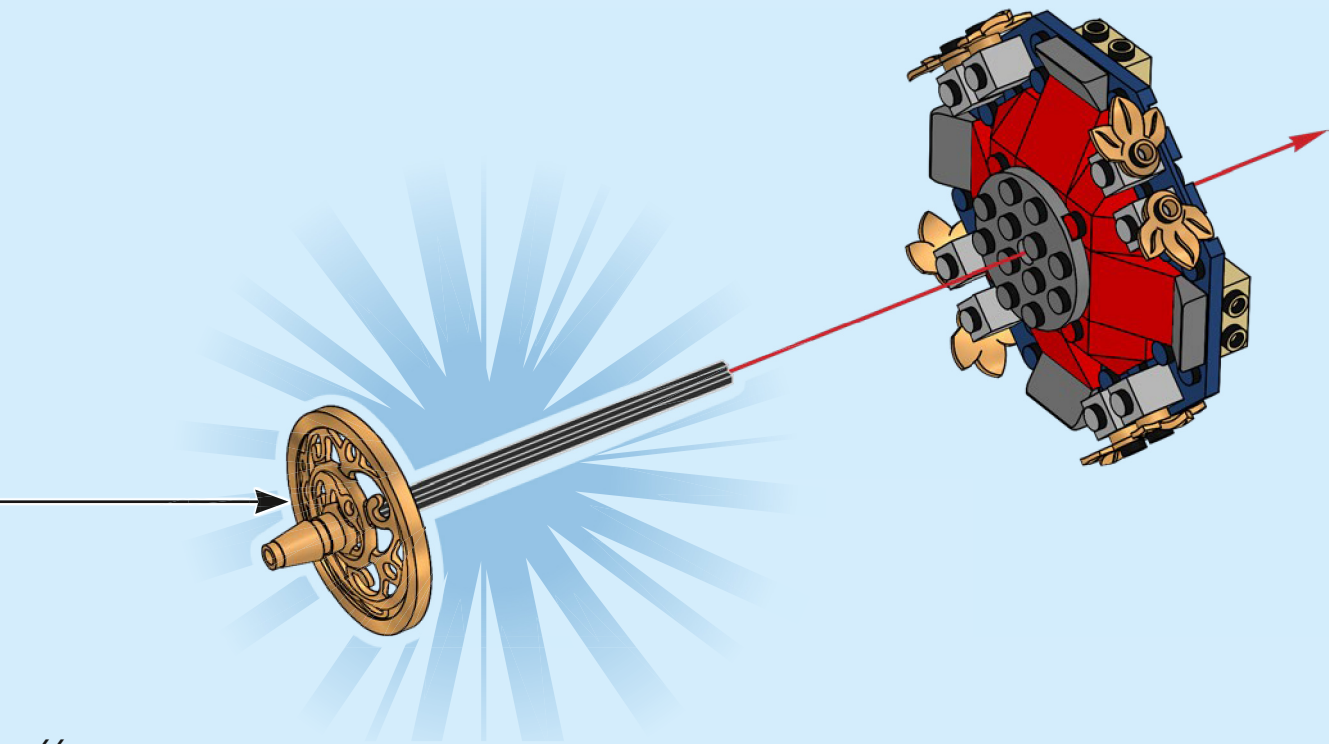



75

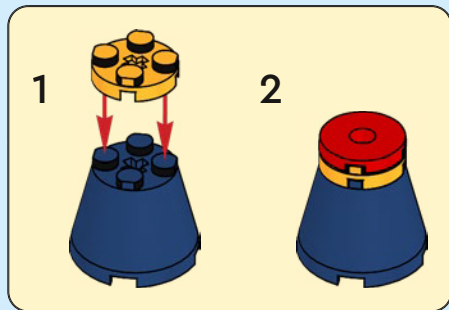
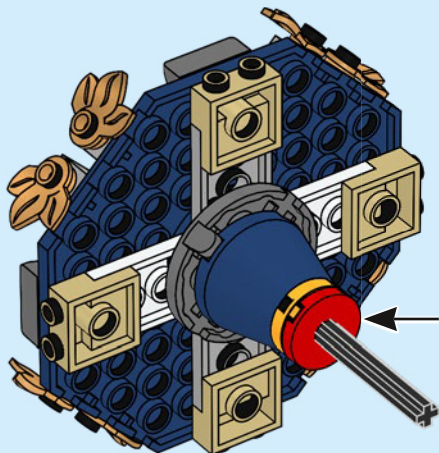

76

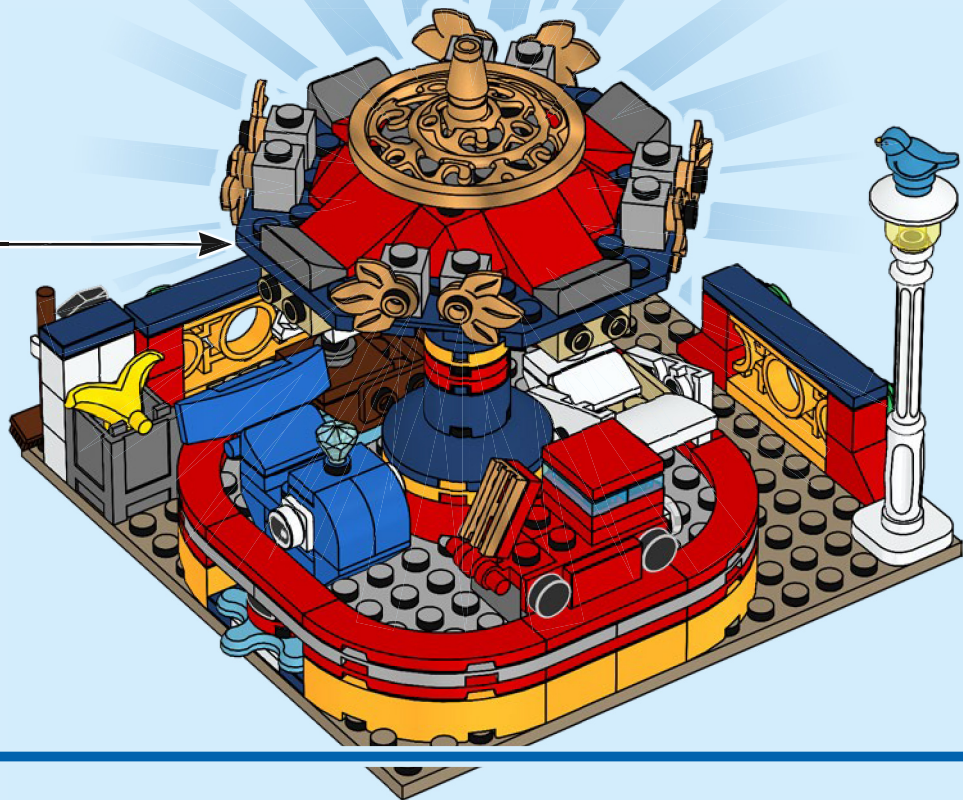

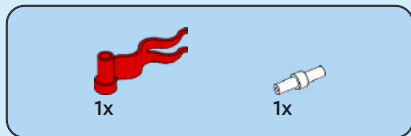

77

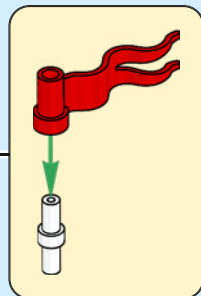

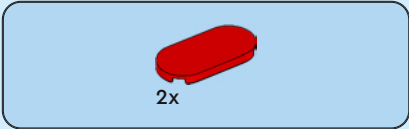

78

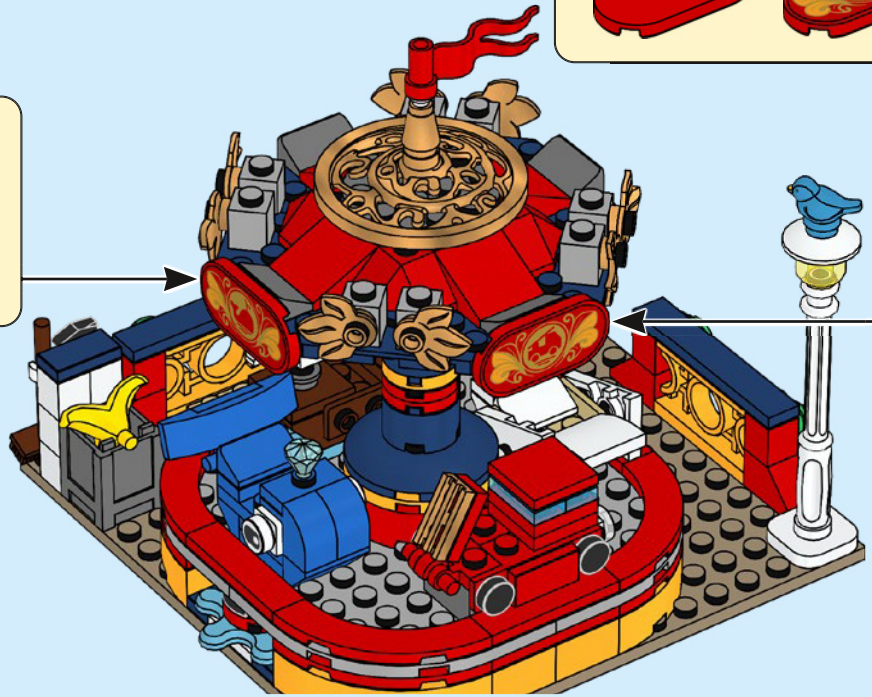
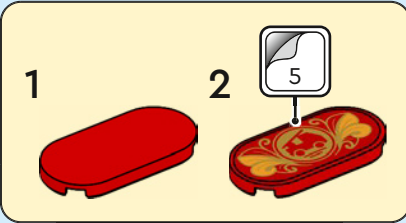
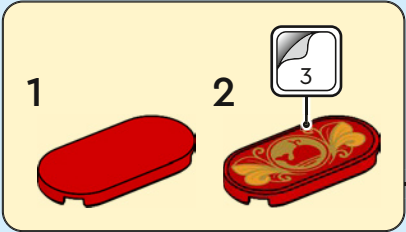

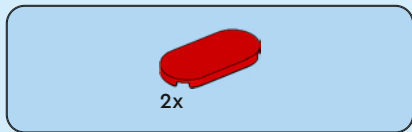

79

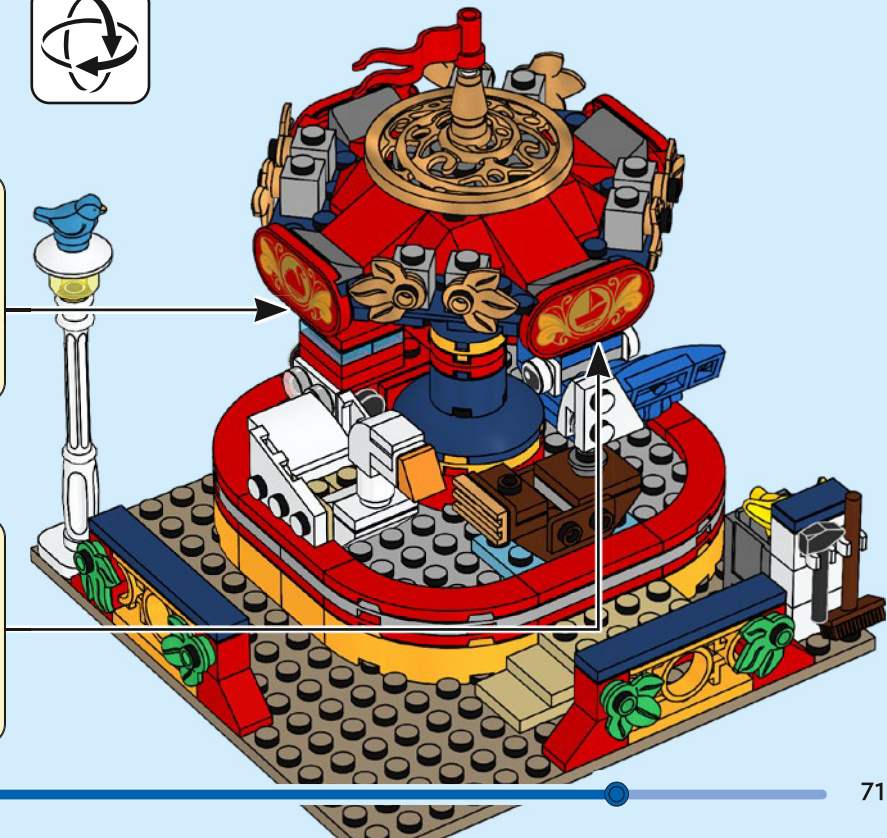
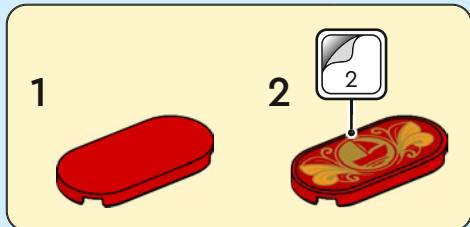
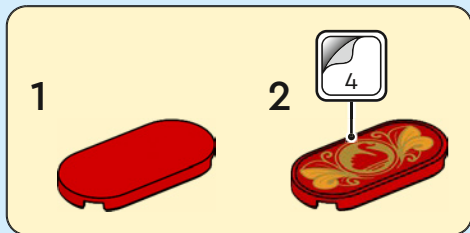



1x

80

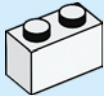

1x

81



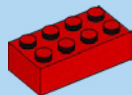

1x

82

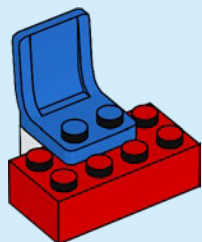

2x

83

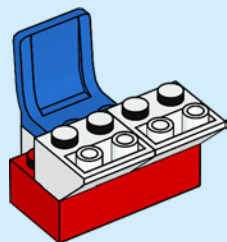

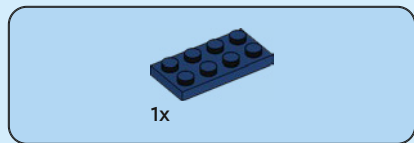

84

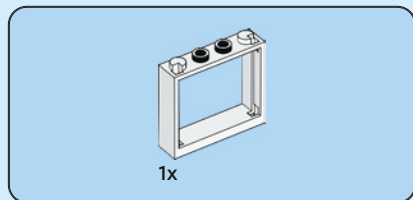
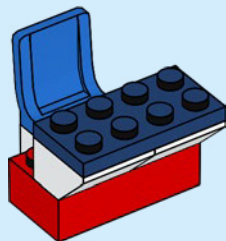

85

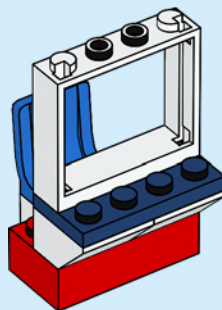

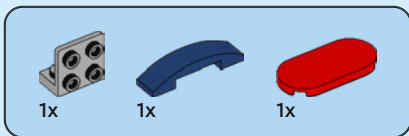

86

1

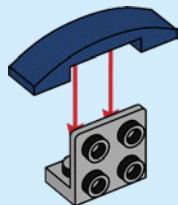

2

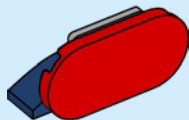

3

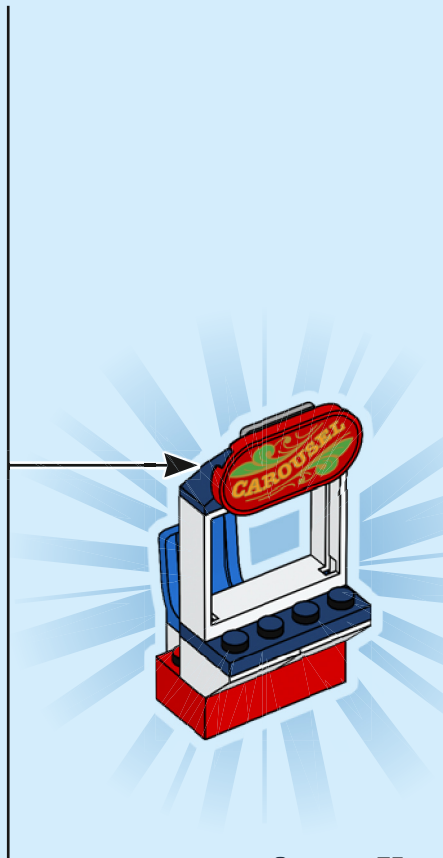

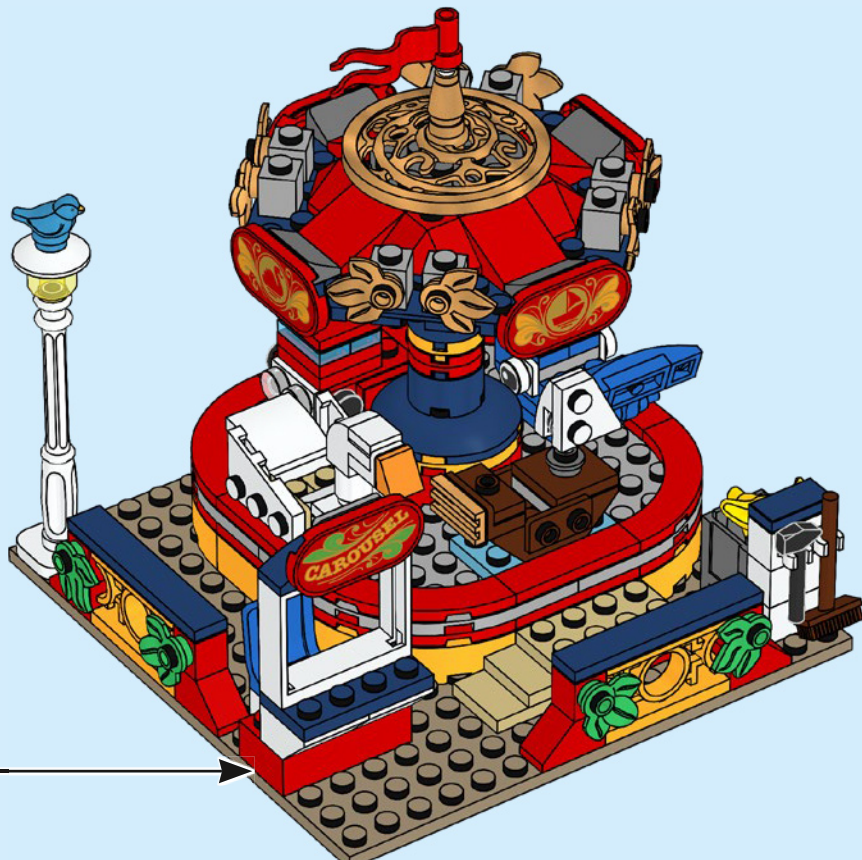



1x 306201	1x 6192534	2x 6329648	2x 6313611	7x 4140585	7x 243121	3x 302223	1x 6329604	4x 6229130
1x 307001	1x 474001	2x 6366391	1x 6454937	1x 6346804	1x 300121	1x 407923	3x 6274738	1x 6247792
3x 6242241	1x 6051511	1x 6238334	2x 6221467	2x 302221	1x 302021	1x 4649773	4x 6284070	1x 6267057
2x 6321349	1x 6285777	1x 6448189	2x 6469454	1x 306821	1x 302021	1x 4649773	1x 6420572	1x 6267057
1x 6132204	1x 6172927	1x 6448189	4x 6469454	4x 6301899	12x 6458177	1x 4656767	1x 4568933	2x 6240215
1x 4179874	3x 300401	2x 302101	1x 4114309	4x 4567445	1x 4651236	1x 6328341	1x 6196548	1x 6300208
1x 4179875	1x 6018774	1x 4530590	4x 4558886	1x 6268946	2x 6347945	1x 4584727	1x 6070695	1x 4504371
1x 6357680	1x 6014274	1x 4515347	1x 403221	2x 6168619	1x 6092582	1x 6306822	1x 6476480	1x 6121893
1x 4547489	1x 6047220	1x 4173943	2x 6102138	4x 329821	1x 6313131	1x 6464535	1x 6476480	1x 6271207
			2x 306921	5x 6438015	1x 4140586	1x 6392114	1x 452226	
			4x 4121934					



1x
6475327



1x
6037886



1x
6380116



1x
4667595



1x
6338455

1x
4613196



2x
4505985



6x
4528488



2x
4252437

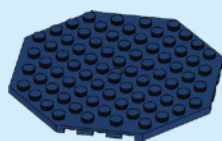

1x
6310977

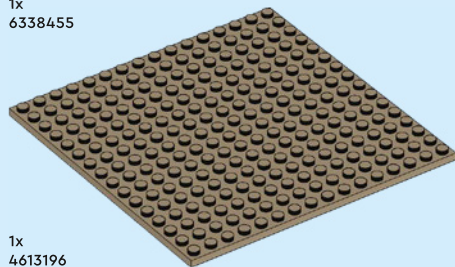

2x
6475189



1x
6385485



4x
6310615



1x
6115115



6x
6034175



1x
4541496



1x
4211157



1x
6092590



3x
6174856



1x
4565394



1x
6039192



8x
4558953



2x
4211398



1x
4654580



1x
4211396



4x
6368430



1x
6387994



1x
6093516



1x
6287960



1x
6031019



1x
4515351

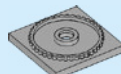

1x
6045718



1x
4211449



1x
6231765



4x
4567887



1x
4520307



2x
4528323



1x
4211085



1x
6330617



1x
4529247



8x
6219088



2x
4490599

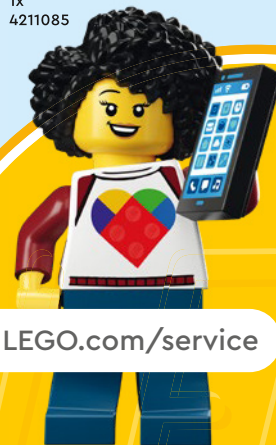

 [LEGO.com/service](https://www.LEGO.com/service)

YOU COULD **WIN**



Scan this QR code or go to **LEGO.COM/PRODUCTFEEDBACK** and give us your short feedback about this LEGO® set for a chance to win a cool LEGO prize.

Terms and Conditions apply*

EN: YOU COULD WIN. Terms and Conditions apply* **DE: Du könntest GEWINNEN.** Es gelten die Teilnahmebedingungen* **FR: Tu pourrais GAGNER.** Des conditions s'appliquent* **IT: Potresti VINCERE tu.** Termini e condizioni sono applicabili* **ES: Puedes GANAR.** Aplican términos y condiciones* **PT: Poderá GANHAR.** Aplicam-se termos e condições* **ZH: 轻松获奖. 条款和条件适用*** **PL: Szansa na WYGRANĄ.** Obowiązują warunki korzystania* **CS: Máte šanci VYHRÁT.** Platí všeobecné smluvní podmínky* **SK: Máte šancu VYHRAŤ.** Platia všeobecné zmluvné podmienky* **HU: TE IS NYERHETSZ.** Felhasználási feltételek érvényesek* **RO: Ai putea CÂȘTIGA.** Se aplică termenii și condiții* **BG: Можете да СПЕЧЕЛИТЕ.** Има определени правила и условия* **LV: Tu vari LAIMĒT.** Ir spēkā noteikumi un nosacījumi.* **ET: Sul on võimalus VÕITA.** Kehtivad tingimused* **LT: Jūs galite LAIMĖTI.** Taikomos sąlygos*

*LEGO.com/productfeedback-terms