



# Mixels

41571



**WARNING: CHOKING HAZARD.**

Toy contains small parts and a small ball.  
Not for children under 3 years.



LEGO.com

6157137

# 1

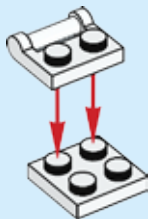

# 2

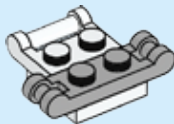

**AVERTISSEMENT : RISQUE D'ÉTOUFFEMENT.**

Le jouet contient des petites pièces ainsi qu'une petite boule.  
Il ne convient pas aux enfants de moins de 3 ans.



**ADVERTENCIA: PELIGRO DE ASFIXIA.**

Juguete que contiene partes pequeñas y una pelota pequeña.  
No recomendado para niños menores de 3 años.

**3**

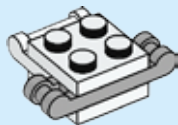

**4**

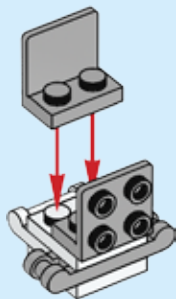

5

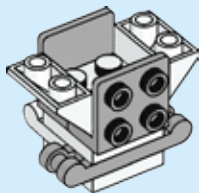

6

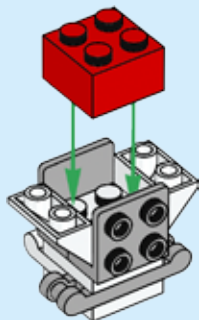

7

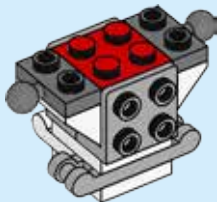

8

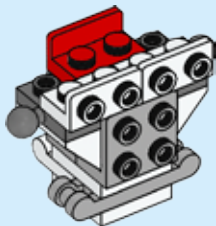

9

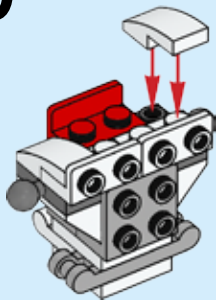

10

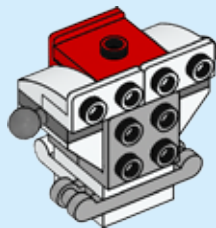



**11**



**12**

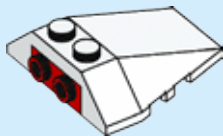

**13**

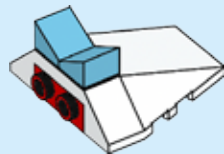

14

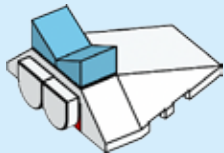

15

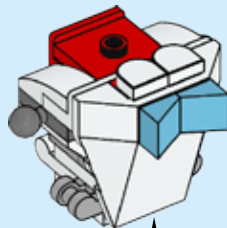



16

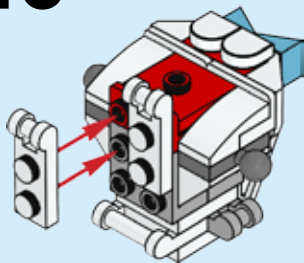

17

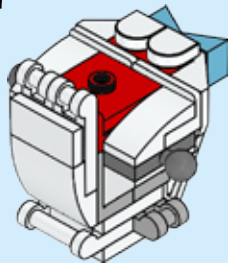

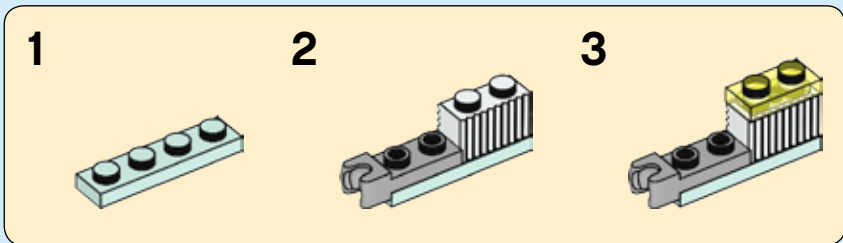

**18**

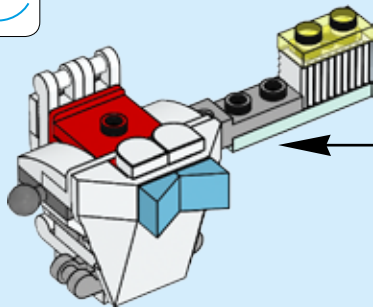

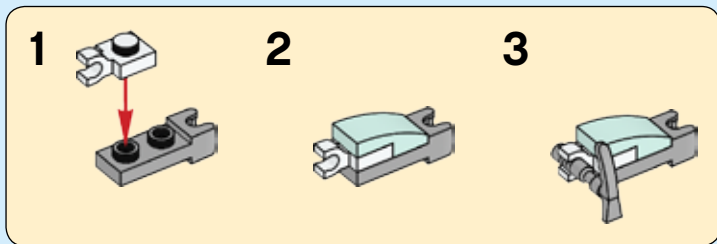

**19**

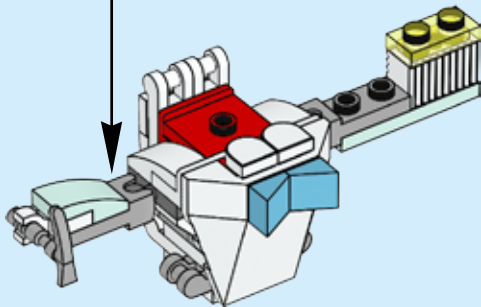



20

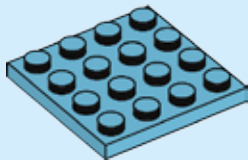

21



# 22

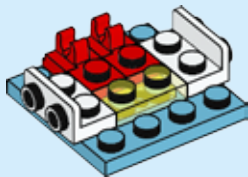

# 23

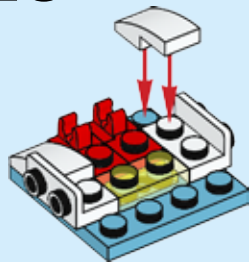

# 24

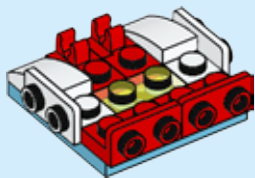

# 25

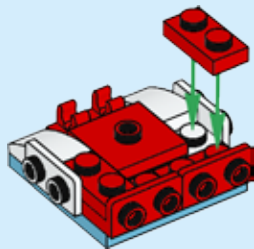

26

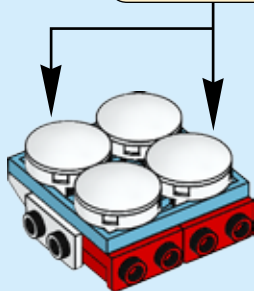
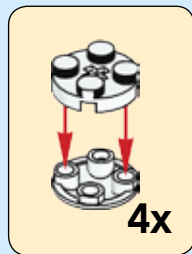

27

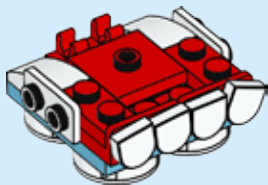

28

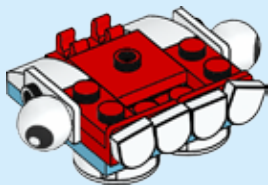



29

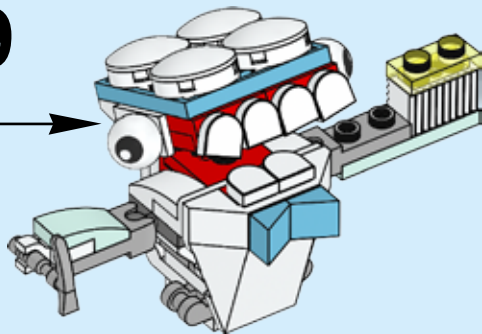

**30**

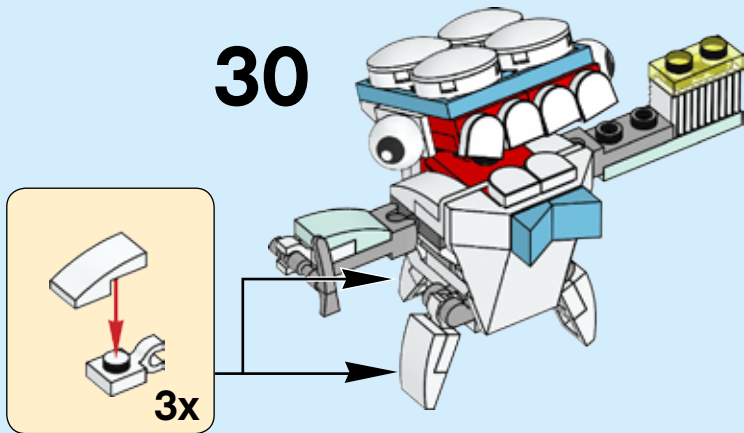



6x  
6131655



1x  
306901



2x  
4515364



2x  
302321



2x  
4654580



2x  
4619520



2x  
6056225



7x  
6034044



1x  
4173943



2x  
4597713



2x  
6043639

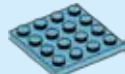

1x  
6141594



4x  
4538353



4x  
6070698



1x  
4264026



3x  
6089698



1x  
6093058



1x  
6141593



4x  
403201



1x  
4222017



2x  
6102038



2x  
4581308



2x  
6039479



1x  
6141592



4x  
4278271



1x  
6047220



1x  
300321  
6061711



1x  
287701



2x  
302201



1x  
6088382



**Customer Service**

**Kundenservice**

**Service Consommateurs**

**Servicio Al Consumidor**

**LEGO.com/service or dial**



**: 00800 5346 5555**



**: 1-800-422-5346**



**SURGEO  
41569**

**SKRUBZ  
41570**

**TUTH  
41571**

**MEDIX  
MAX!**

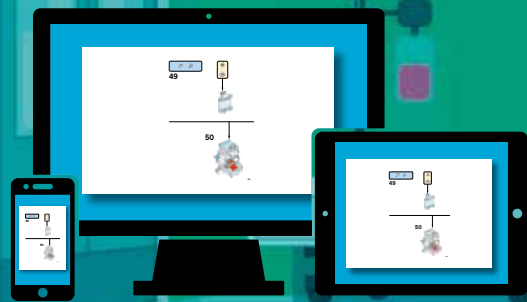

 **LEGO.com/mixels**



# Mixels

SERIES  
8

SERIES  
8

SERIES  
8

**SKULZY**  
41567



**AQUAD**  
41564



**SPLASHO**  
41563



**SKRUBZ**  
41570



**SHARK**  
41566



**SURGED**  
41569



**LEWT**  
41568



**TUTH**  
41571



**HYDRO**  
41565



[LEGO.com/mixels](http://LEGO.com/mixels)



# Mixels™

CALLING ALL MIXELS  
APPEL À TOUS LES MIXELS !  
¡¡LLAMANDO A TODOS LOS MIXELS!



NOW PLAY FOR FREE!  
JOUE MAINTENANT GRATUITEMENT !  
¡¡JUEGA GRATIS AHORA!

Download on the  
 App Store

Apple, the Apple logo, iPad, iPhone and iPod touch are trademarks of Apple Inc. Apple, le logo Apple, iPad, iPhone et iPod touch sont des marques de commerce d'Apple Inc. / Apple, el logotipo de Apple, iPad, iPhone e iPod touch son marcas comerciales de Apple Inc.

# Mixels™ RUSH



NOW PLAY FOR FREE!  
JOUE MAINTENANT GRATUITEMENT !  
¡¡JUEGA GRATIS AHORA!

ANDROID APP ON  
 Google play

Google Play is a trademark of Google Inc. Google Play est une marque de commerce de Google Inc. Google Play es una marca comercial de Google Inc.



**LEGO.com/mixels**

