



# BRICK HEADZ

41602



# STAR WARS™



[LEGO.com/brickheadz](https://www.LEGO.com/brickheadz)

REY

SERIES 2

25





SERIES 2  
REIHE 2  
SÉRIE 2  
SERIE 2  
2. SOROZAT  
系列 2

1

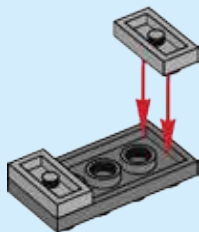



2

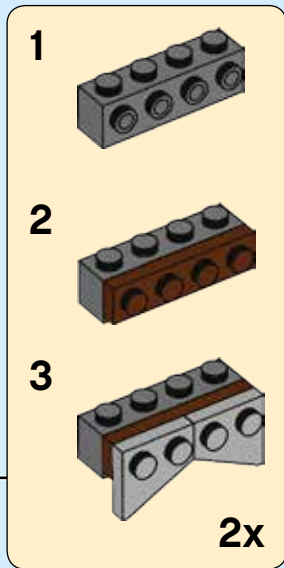
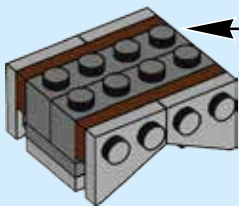
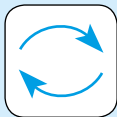

4

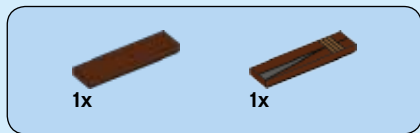

3

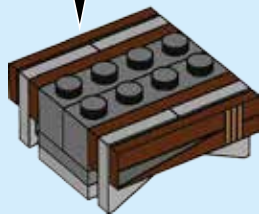
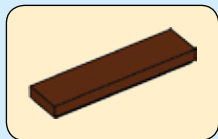



2x



1x

4

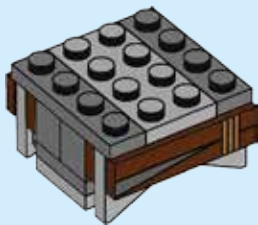

6

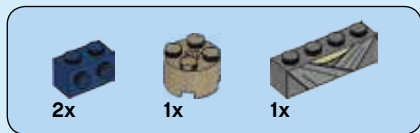

5

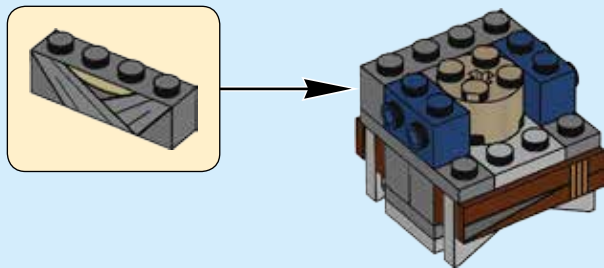



1x

6

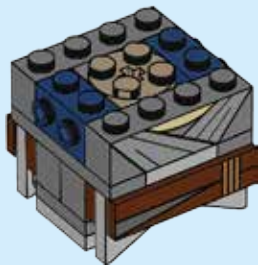

8



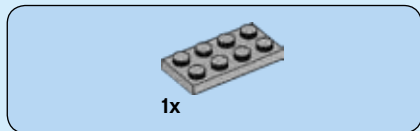

7

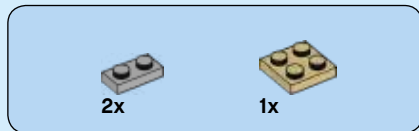

8

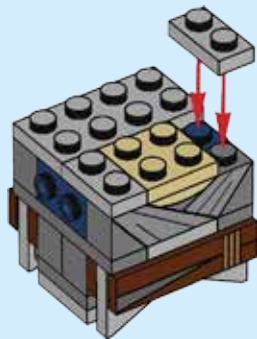

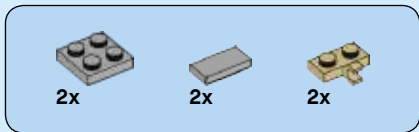

9

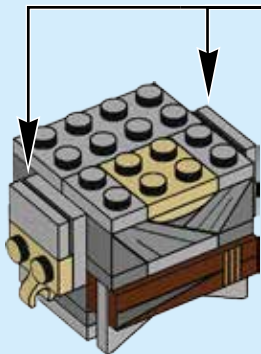
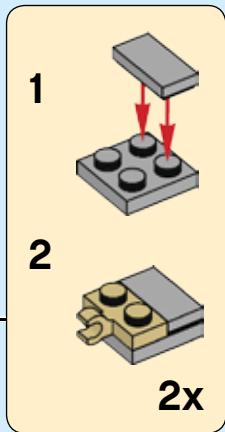

10



5x



1x

# 10

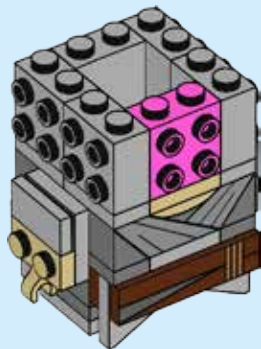



1x



2x



1x

# 11

1

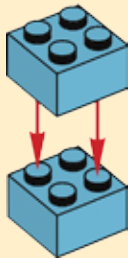

2

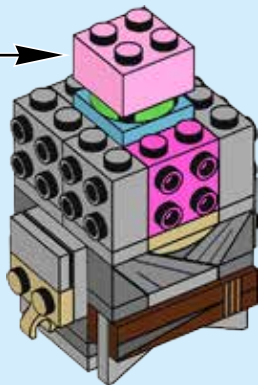
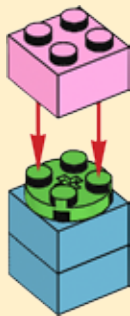

12



6x

12

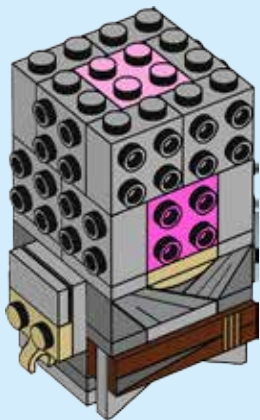

2x

13





1x



2x

# 14

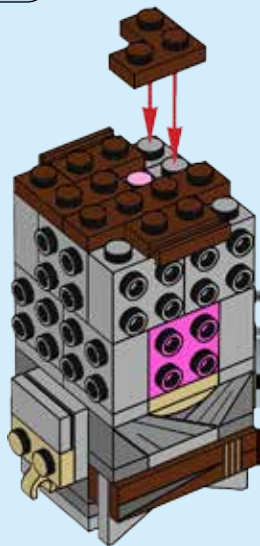



15

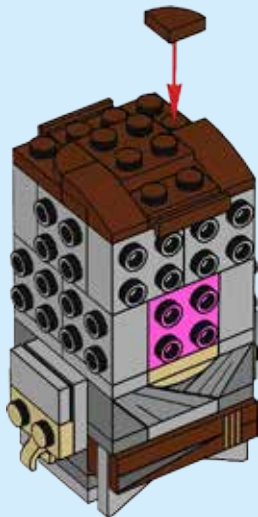

16





1x



1x

17

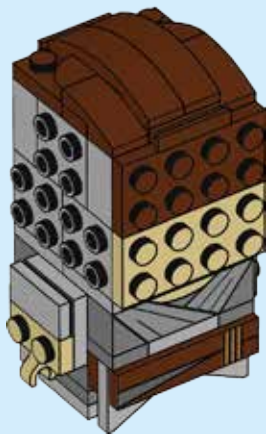

16



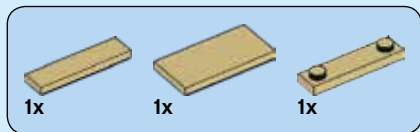

18

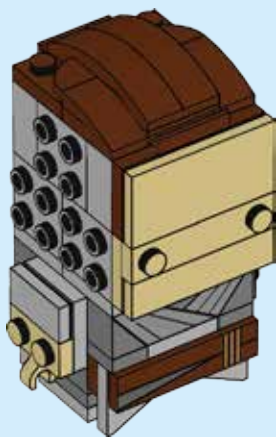



2x

19

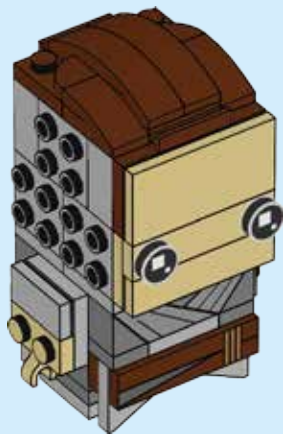

18



1x



1x



1x

# 20

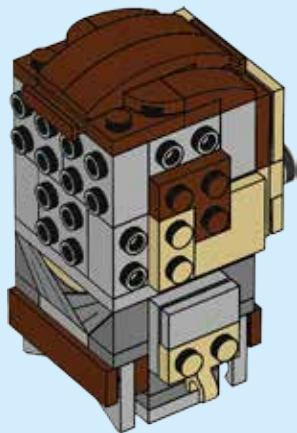
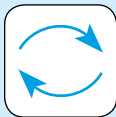



1x



1x



1x

# 21

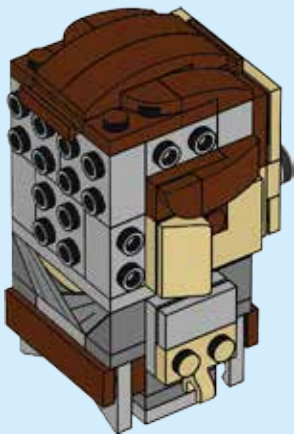

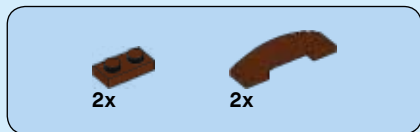

22

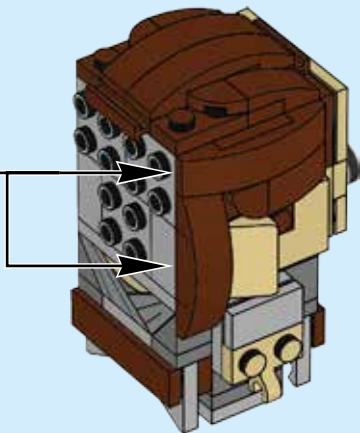
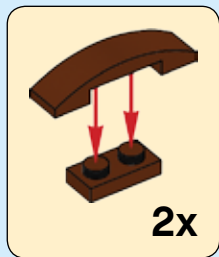



1x



1x

# 23





4x



2x

# 24





2x



2x

25



24





# 26

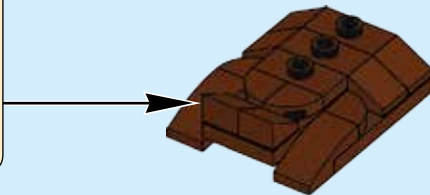
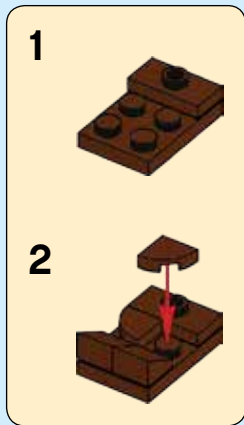

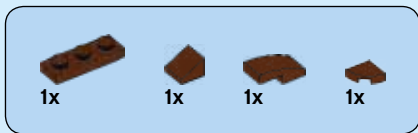

27

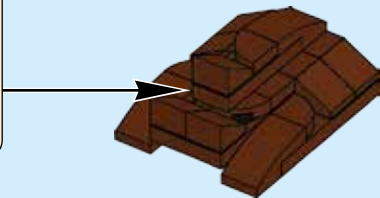
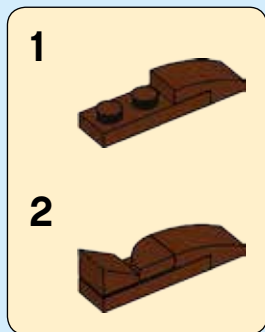

28

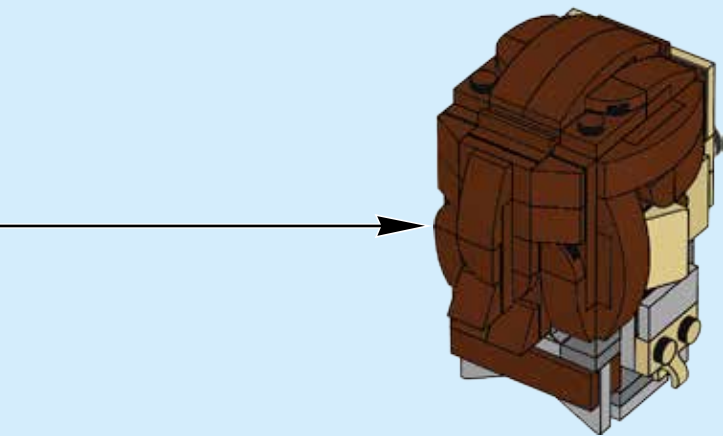



1x



1x



1x

# 29

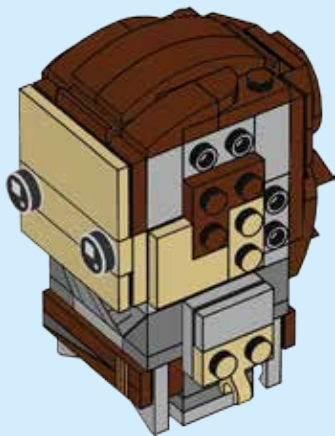
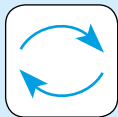



1x



1x



1x

# 30

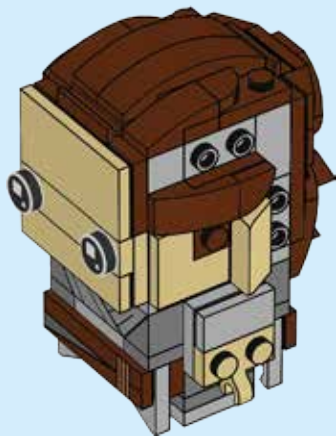



2x



2x

# 31

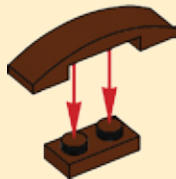
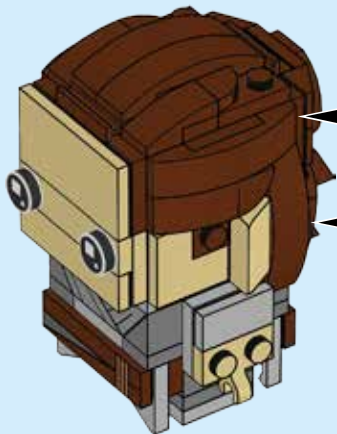

2x

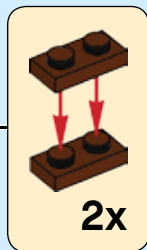

32

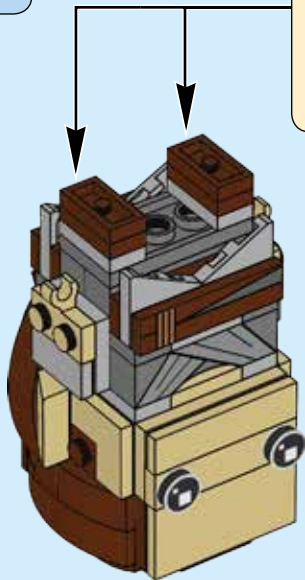
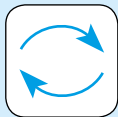

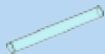

1x



1x

# 33

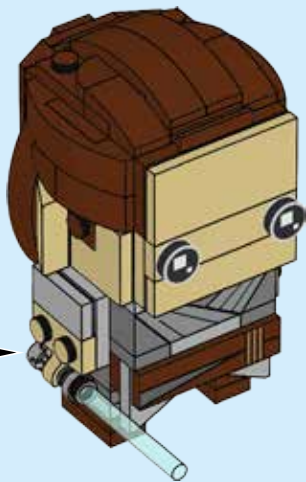
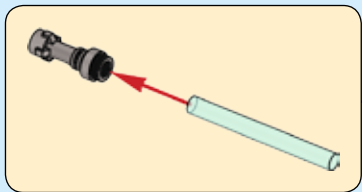
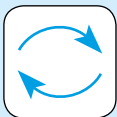

32



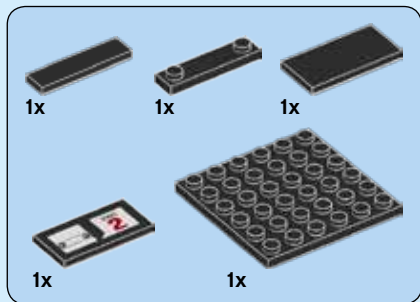

34

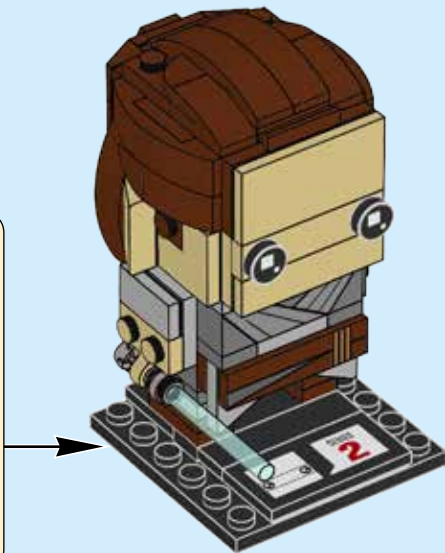
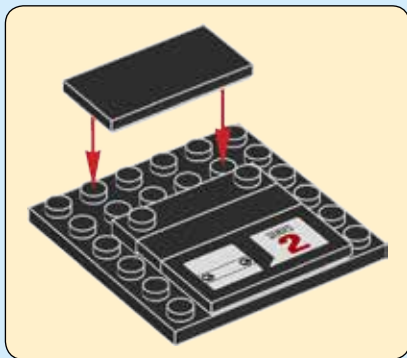



# BRICK HEADZ

# STAR WARS™

41602



**25** REY

41603



**26** KYLO REN™

Disney

SERIES 2



**Customer Service**

**Kundenservice**

**Service Consommateurs**

**Servicio Al Consumidor**

**LEGO.com/service or dial**



**: 00800 5346 5555**

**: 1-800-422-5346**



# WIN

GO TO [WWW.LEGO.COM/PRODUCTFEEDBACK](http://WWW.LEGO.COM/PRODUCTFEEDBACK) AND  
GIVE US YOUR SHORT **FEEDBACK** ABOUT THIS  
LEGO® SET FOR A CHANCE TO WIN  
A COOL LEGO PRIZE.

Terms & Conditions apply

## [LEGO.com/productfeedback](http://LEGO.com/productfeedback)

### GEWINNE

Erzähle uns auf  
[www.LEGO.com/productfeedback](http://www.LEGO.com/productfeedback)

etwas über die Erfahrungen, die du  
mit diesem LEGO® Set gemacht hast,  
und sichere dir die Chance auf einen  
coolen LEGO Preis!

Es gelten die Teilnahmebedingungen

### GAGNE

Rends-toi sur  
[www.LEGO.com/productfeedback](http://www.LEGO.com/productfeedback)

et donne-nous quelques commen-  
taires sur ce produit LEGO® pour  
avoir une chance de gagner un  
prix LEGO !

Voir Conditions Générales

### GANAN

Visita  
[www.LEGO.com/productfeedback](http://www.LEGO.com/productfeedback)

y envíanos tu opinión acerca de este  
set LEGO®. ¡Participarás en el sorteo  
de un premio LEGO!

Términos y Condiciones aplicables

### 获取奖品

登录  
[www.LEGO.com/productfeedback](http://www.LEGO.com/productfeedback)

给出关于此乐高®套装的简短反馈，  
就有机会获得炫酷乐高奖品

《条款及条件》适用

LEGO and the LEGO logo are trademarks of the LEGO Group. ©2018 The LEGO Group.  
© & ™ Lucasfilm Ltd.

6220570