



Friends

41760



2

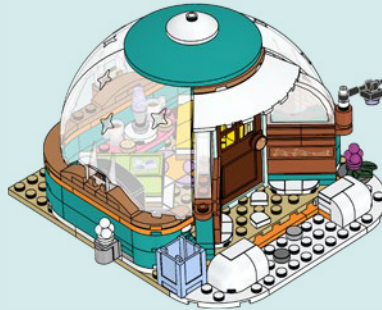
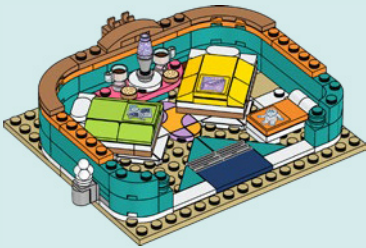

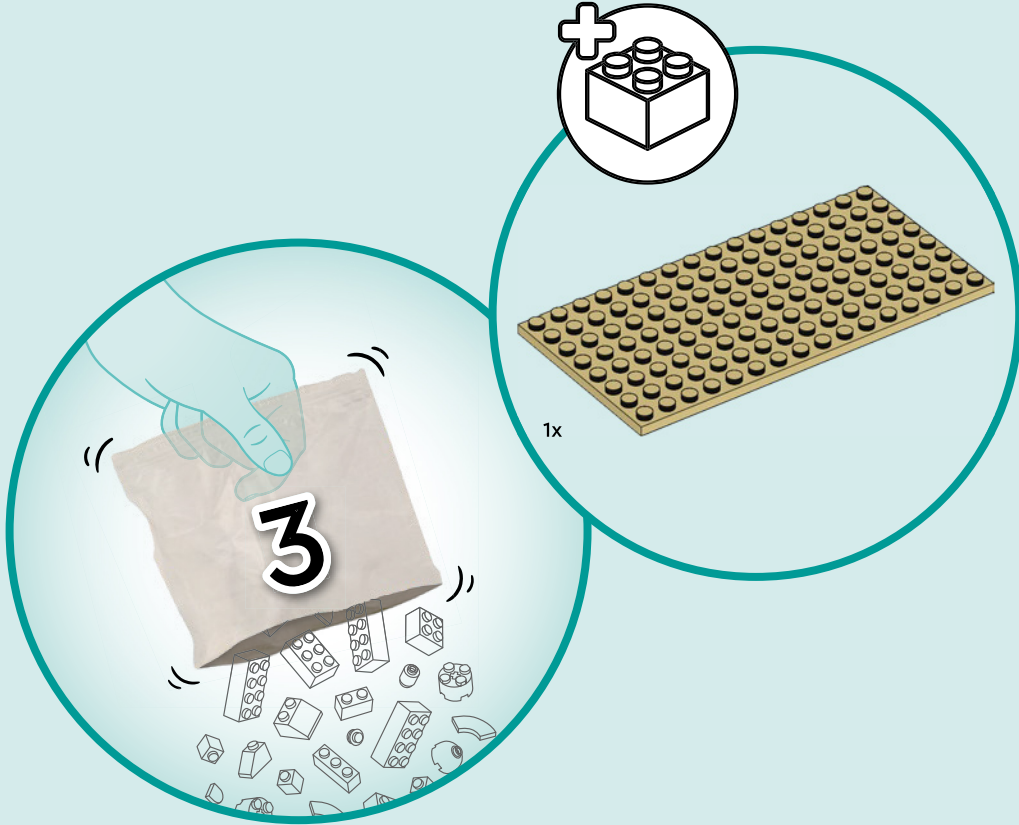

PAISLEY

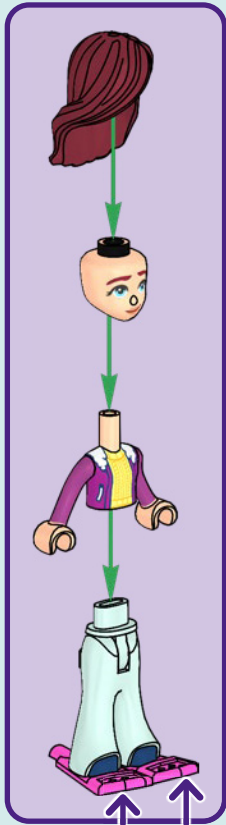

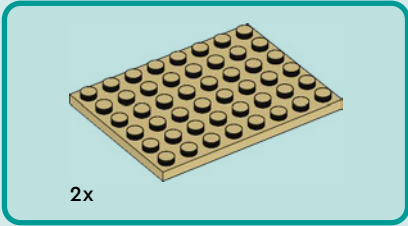
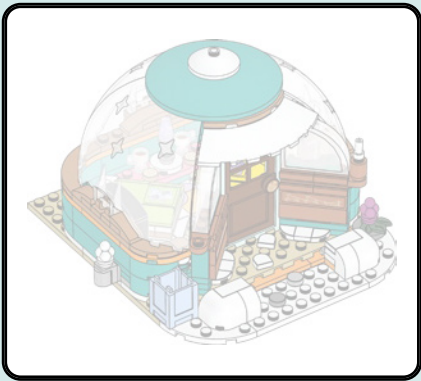

1

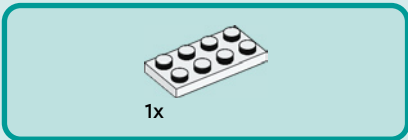

2

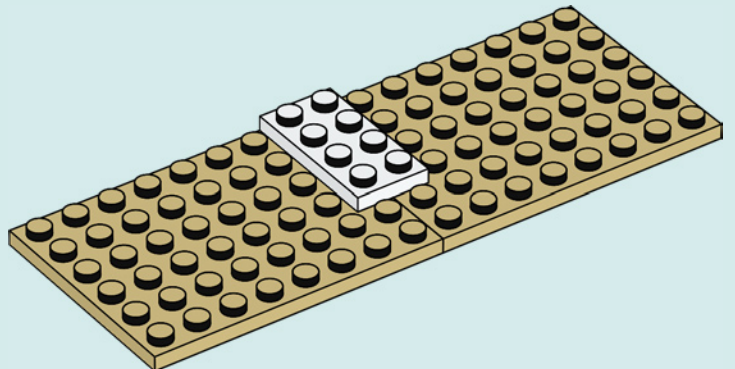
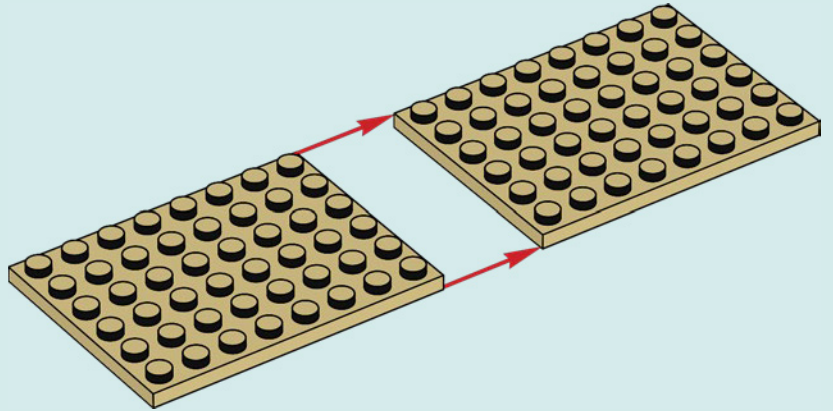

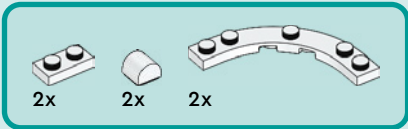

3

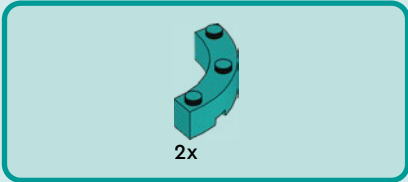
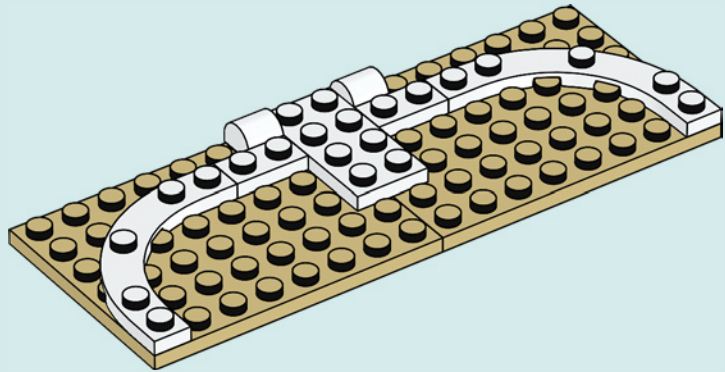

4

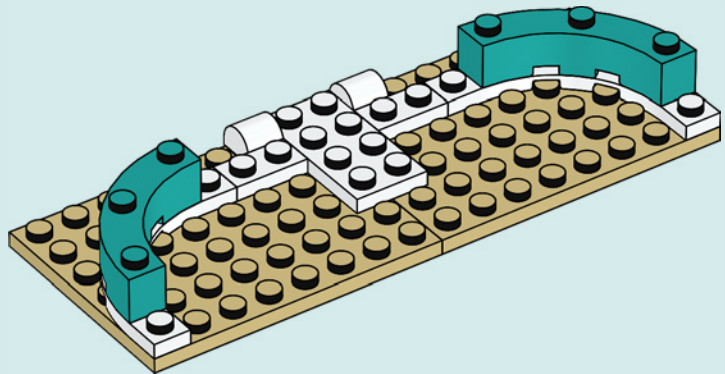



2x

5

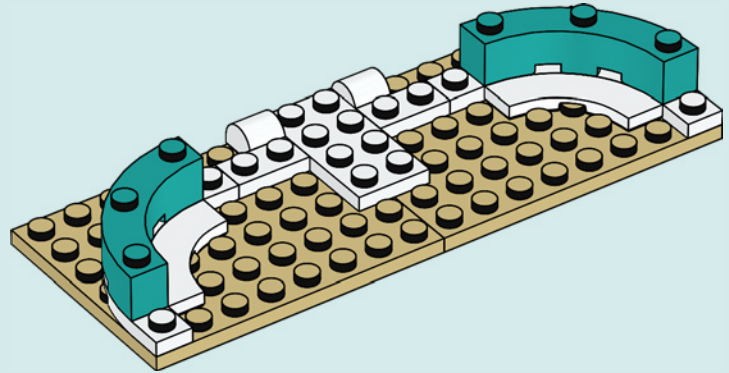

1x



1x



1x

6

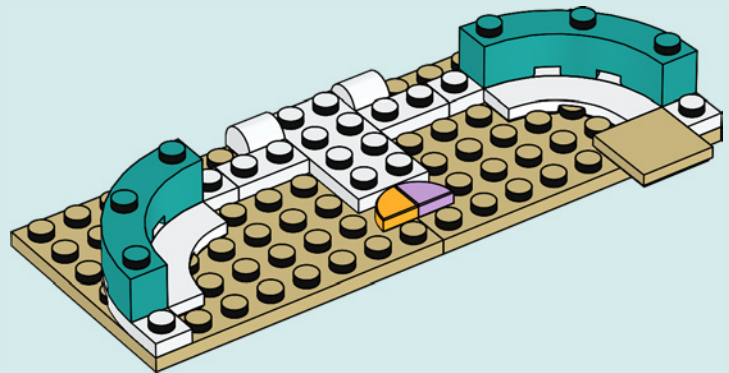

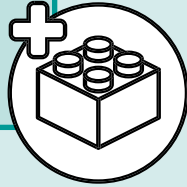
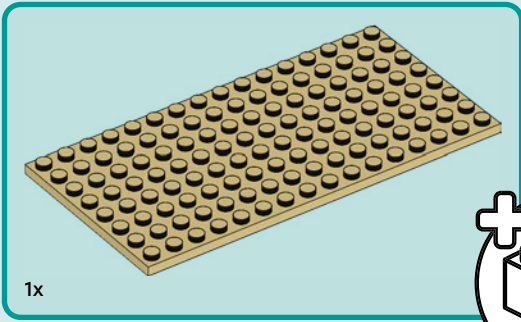

7

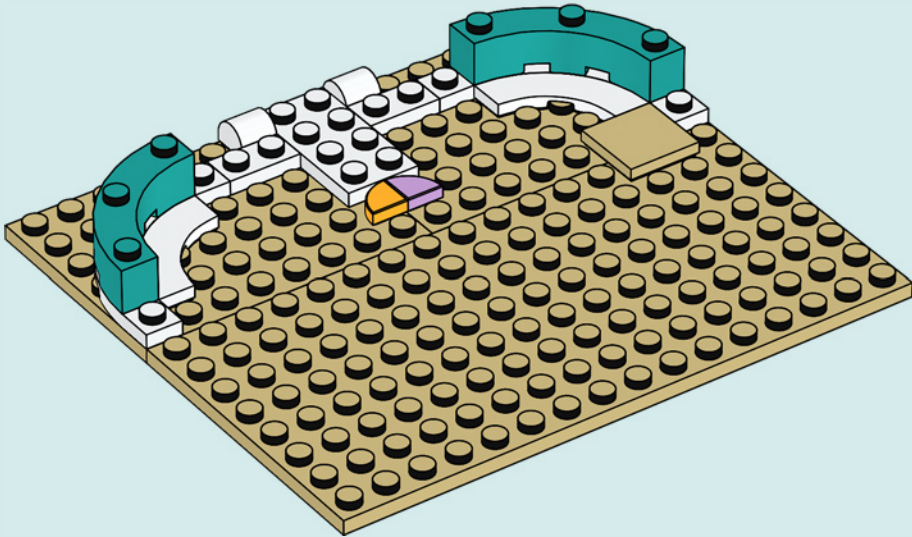



8

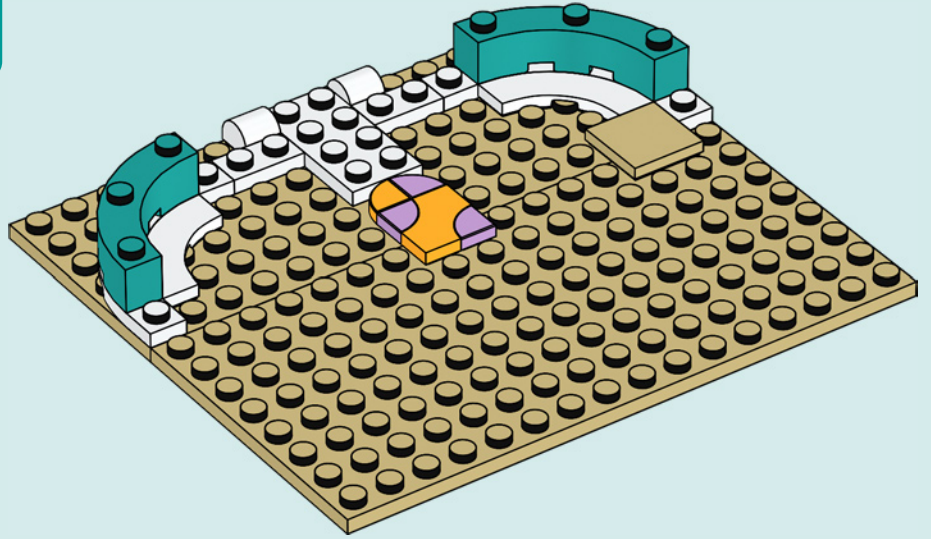

9

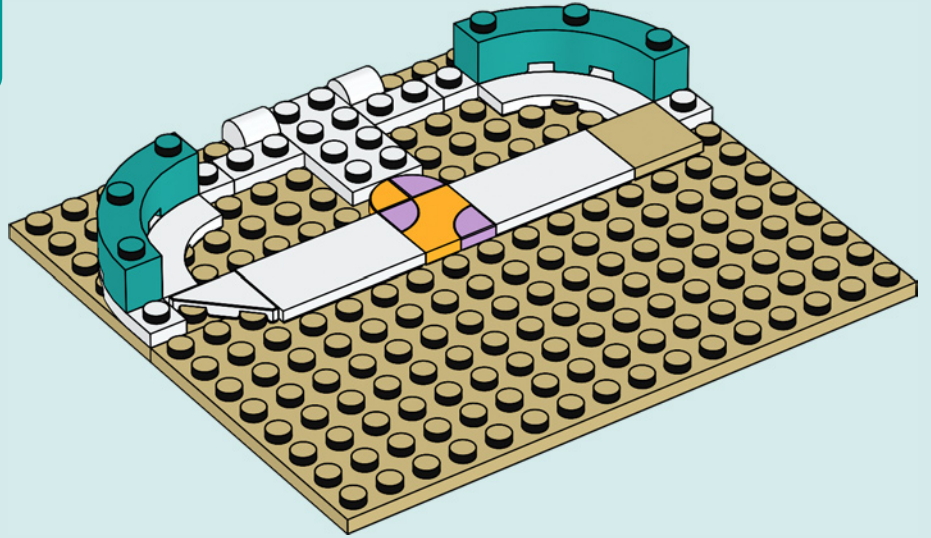

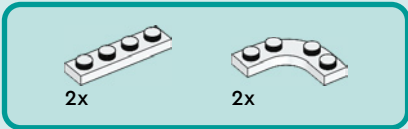

10

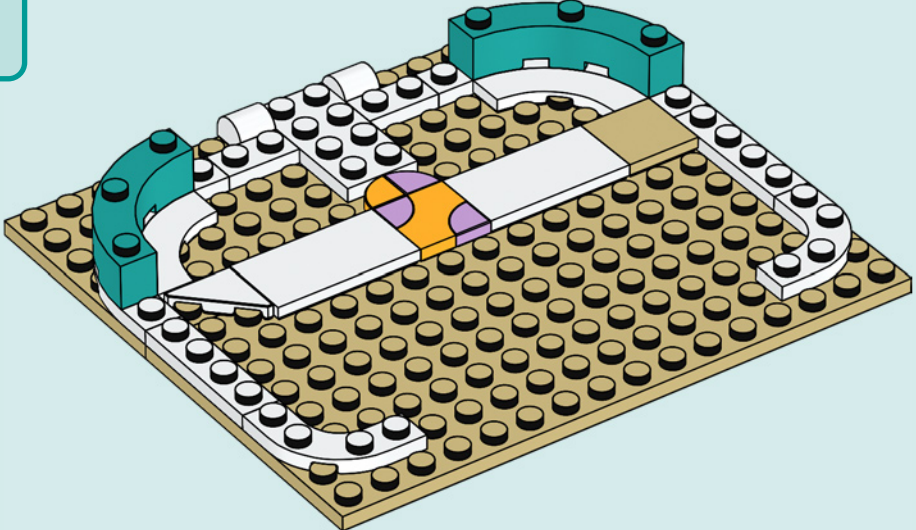

11

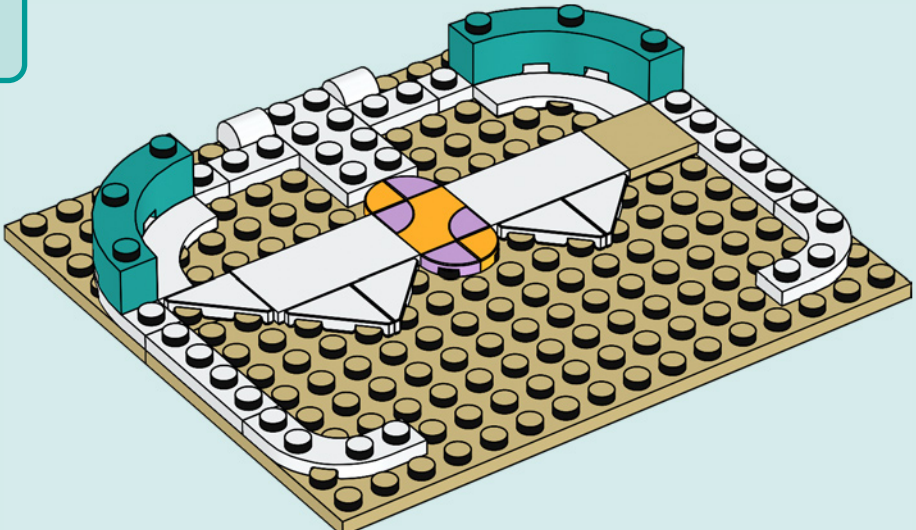

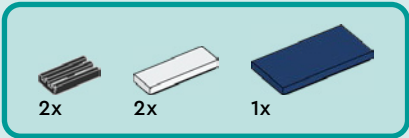

12

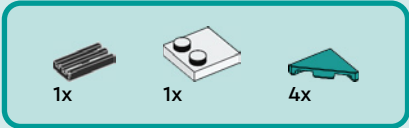
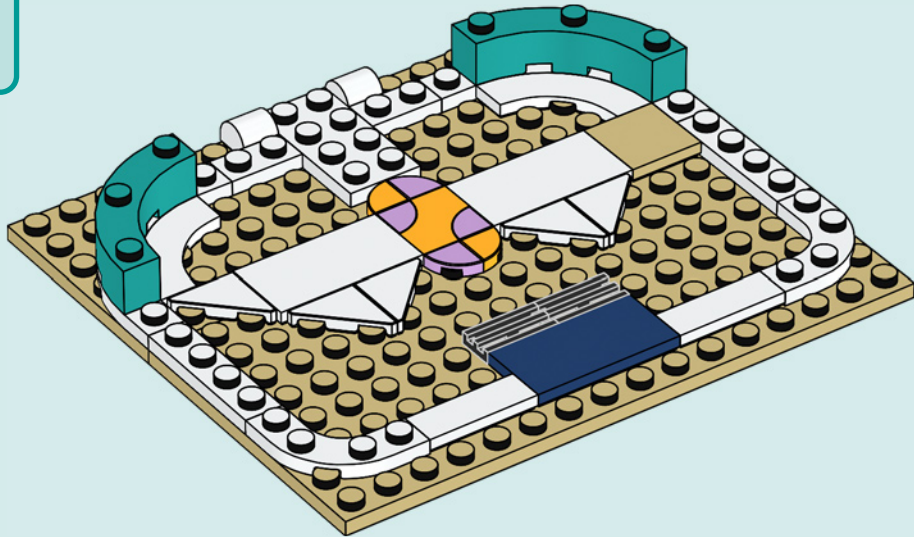

13

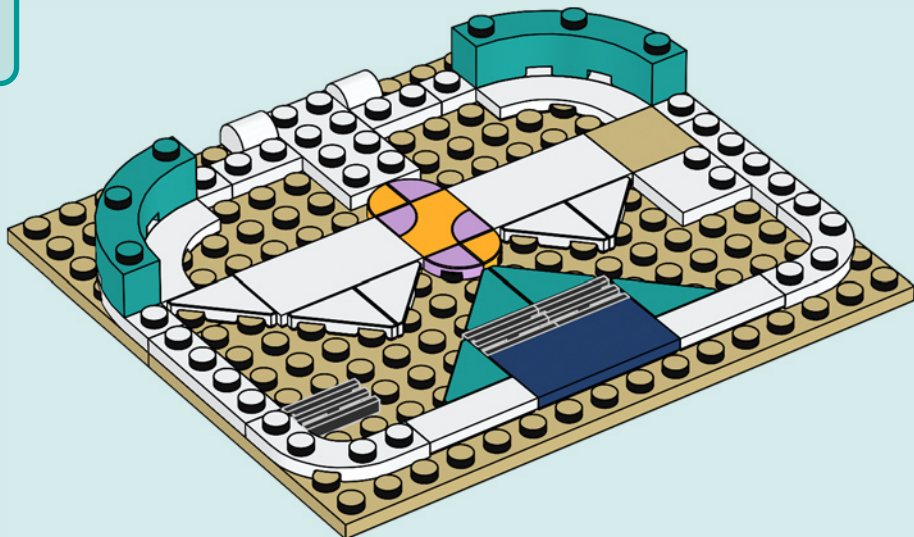

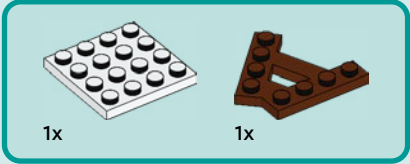
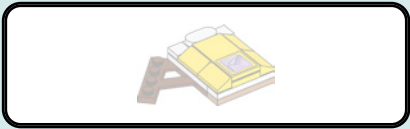

14

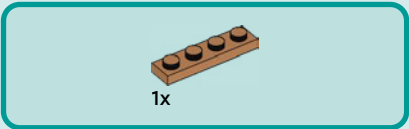
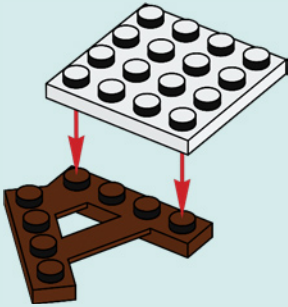

15

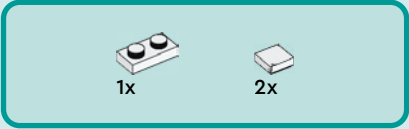

16



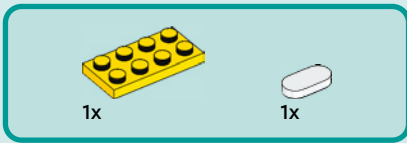

17

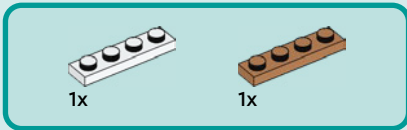
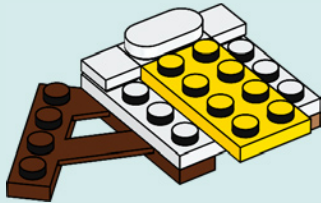

18

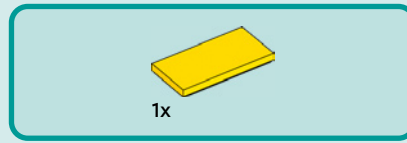
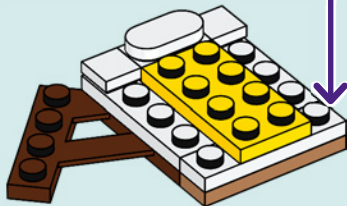
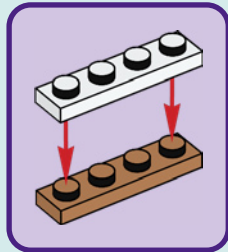

19

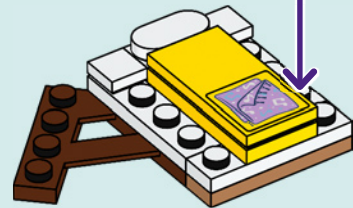
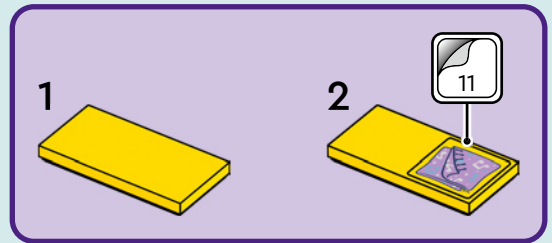



4x

20

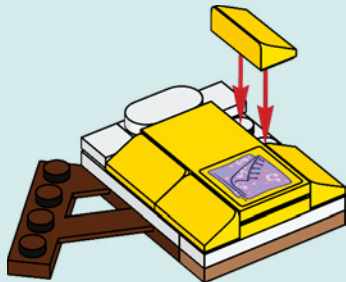

21

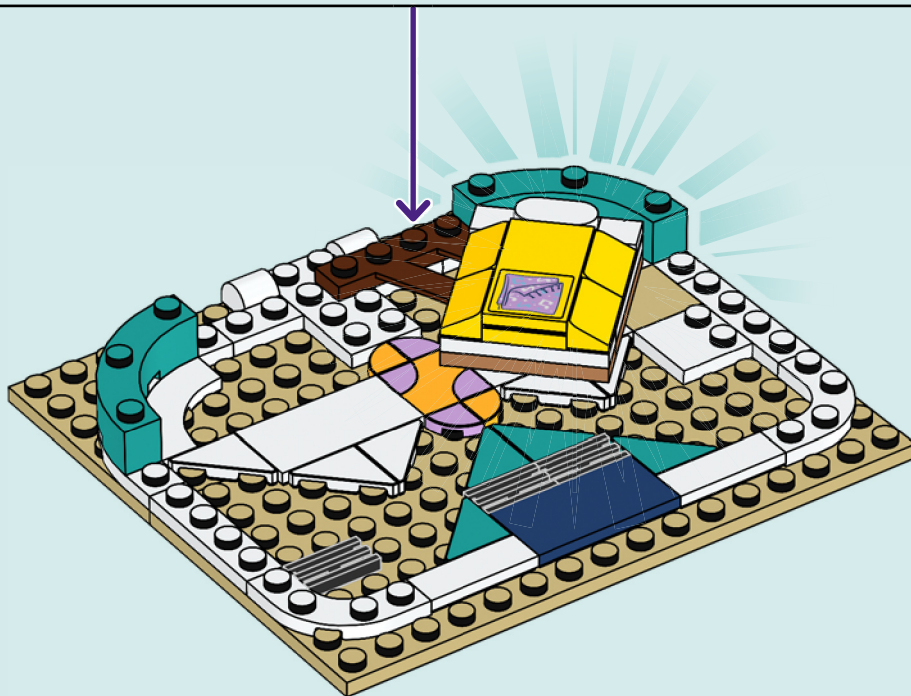

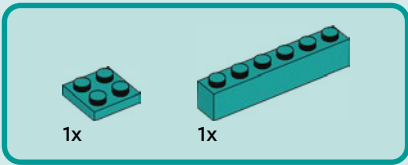

22



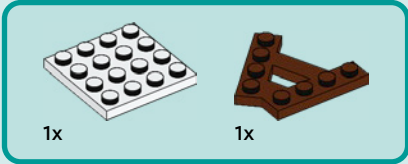
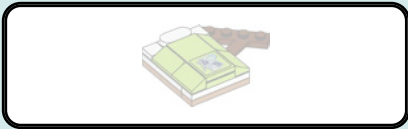

23

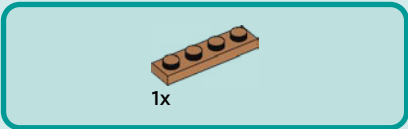
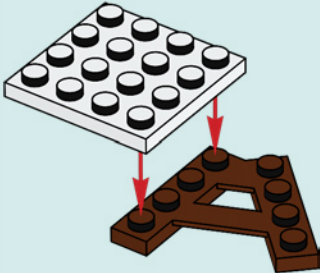

24

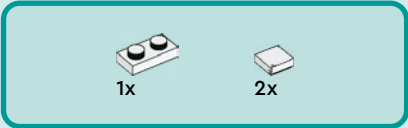

25

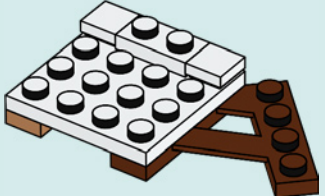

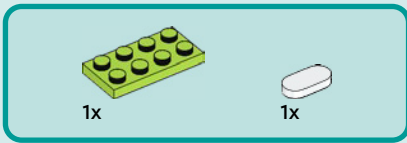

26

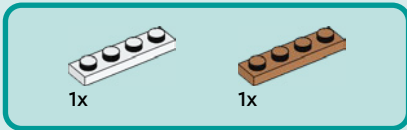
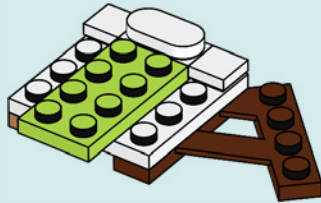

27

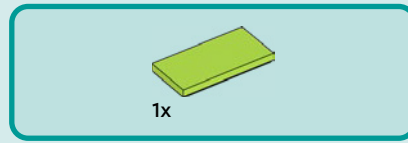
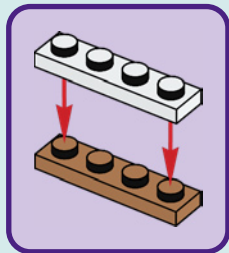

28

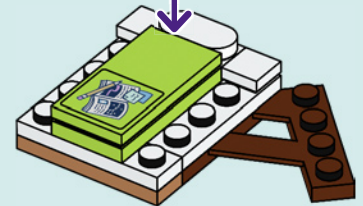
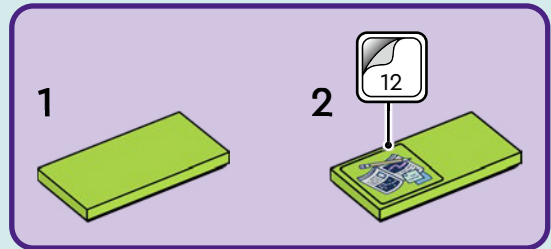



4x

29

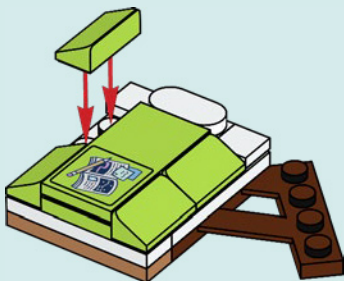

30

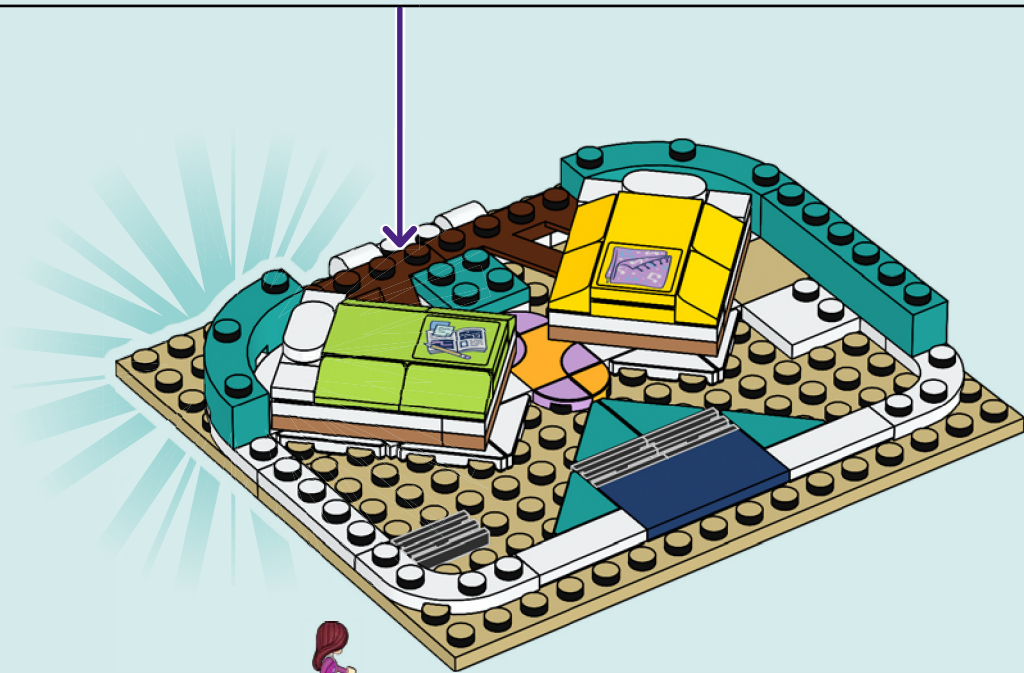

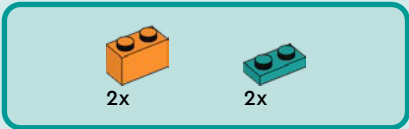

31

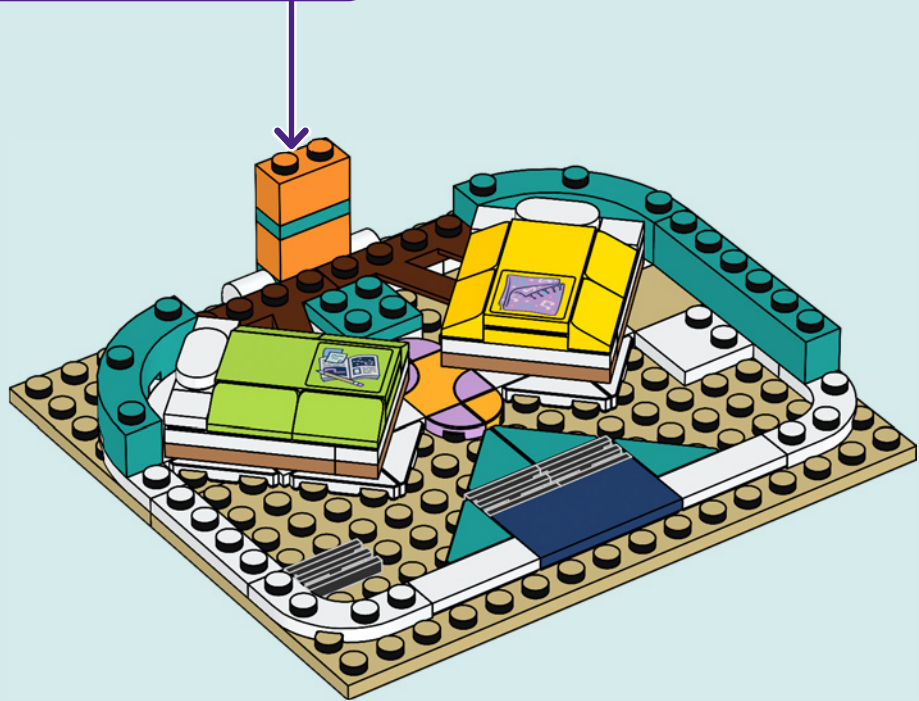
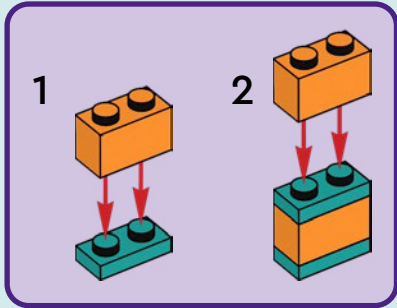

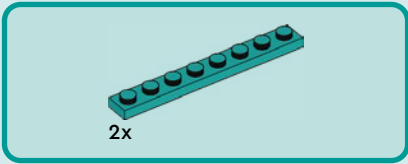

32

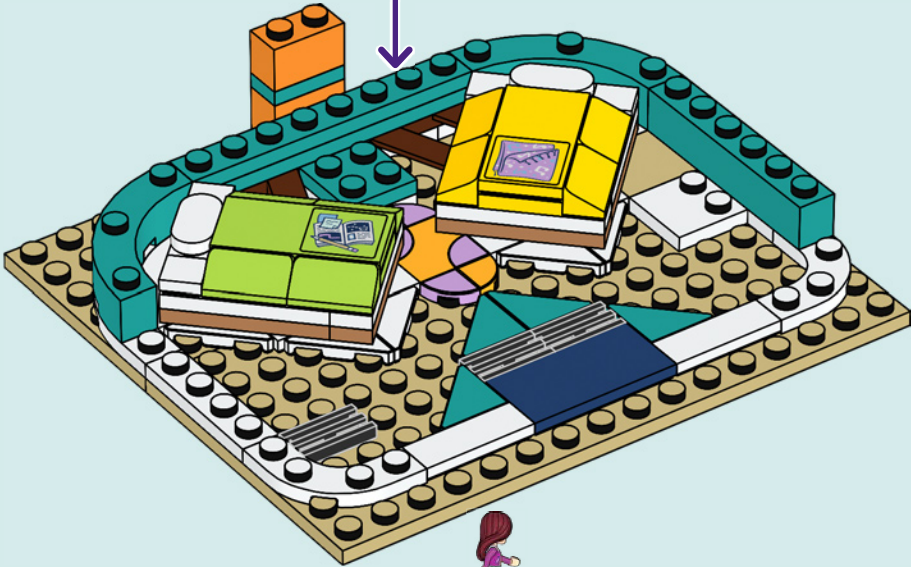
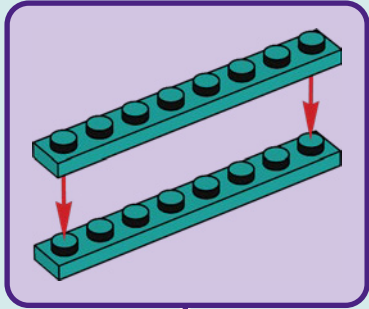

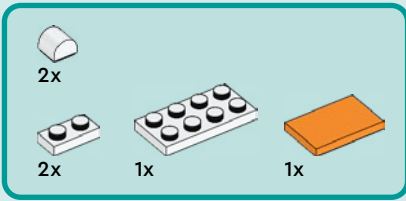

33

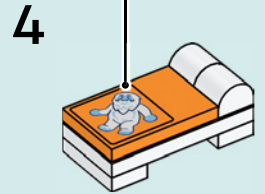
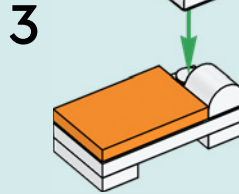
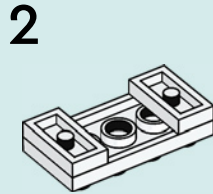
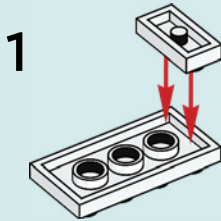

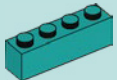

1x

34



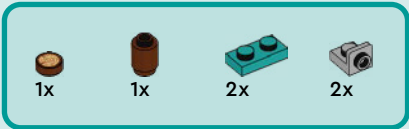

35

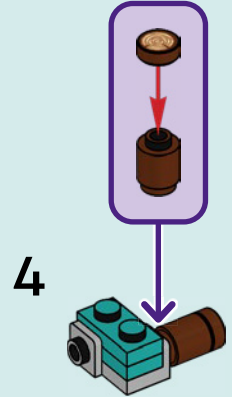
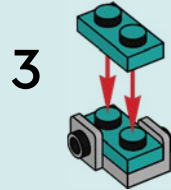
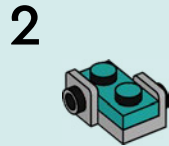
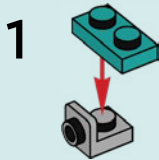



2x



2x

36



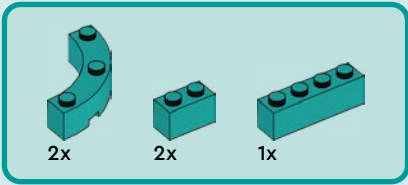

37

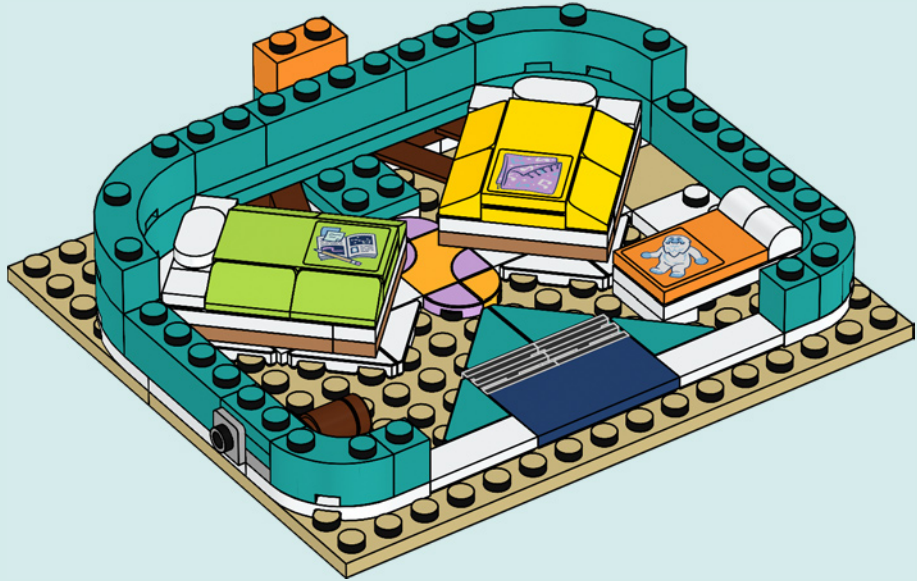

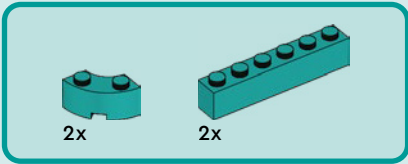

38

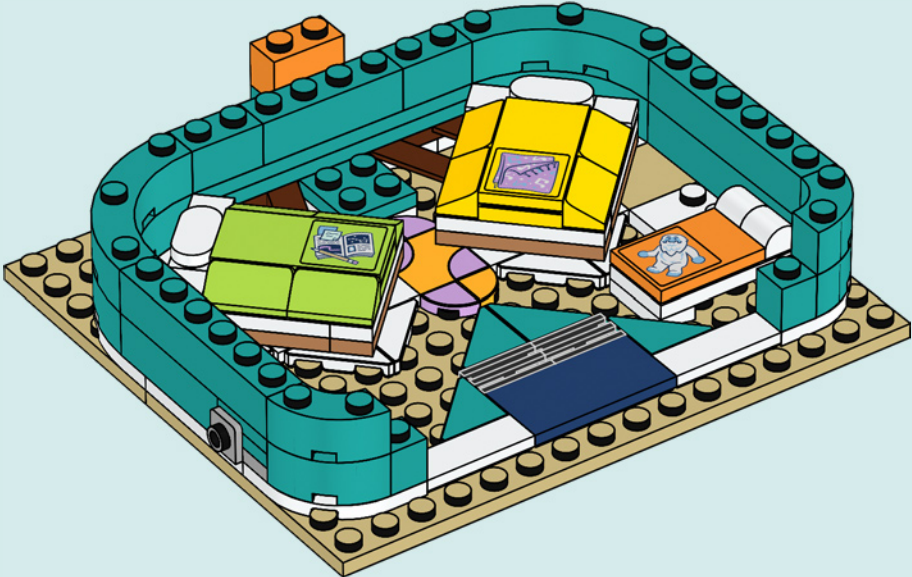



4x

39

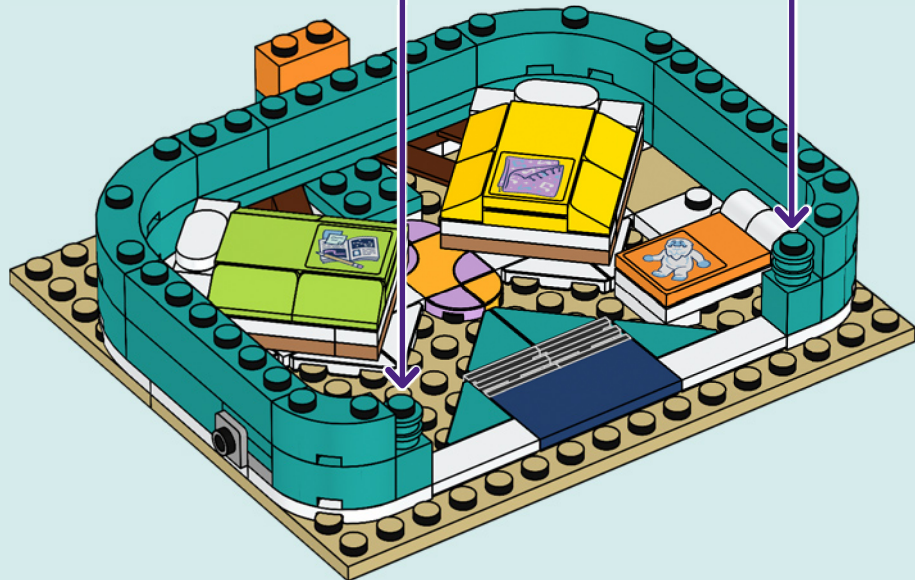
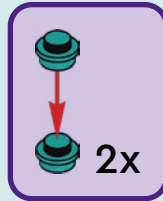

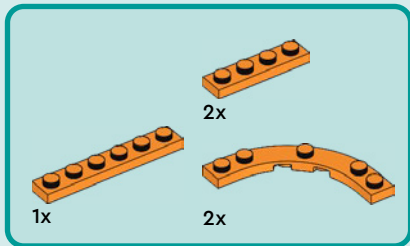

40

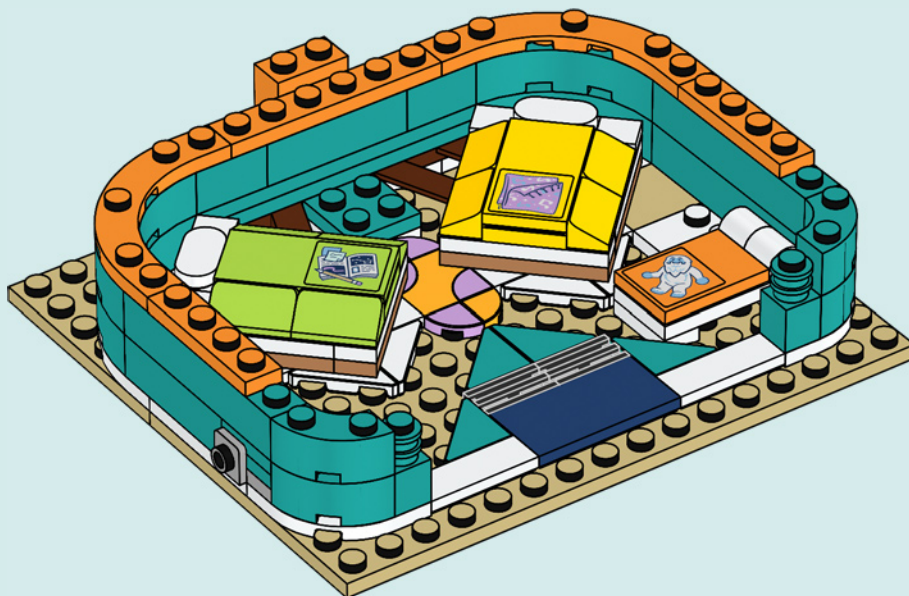



2x

42

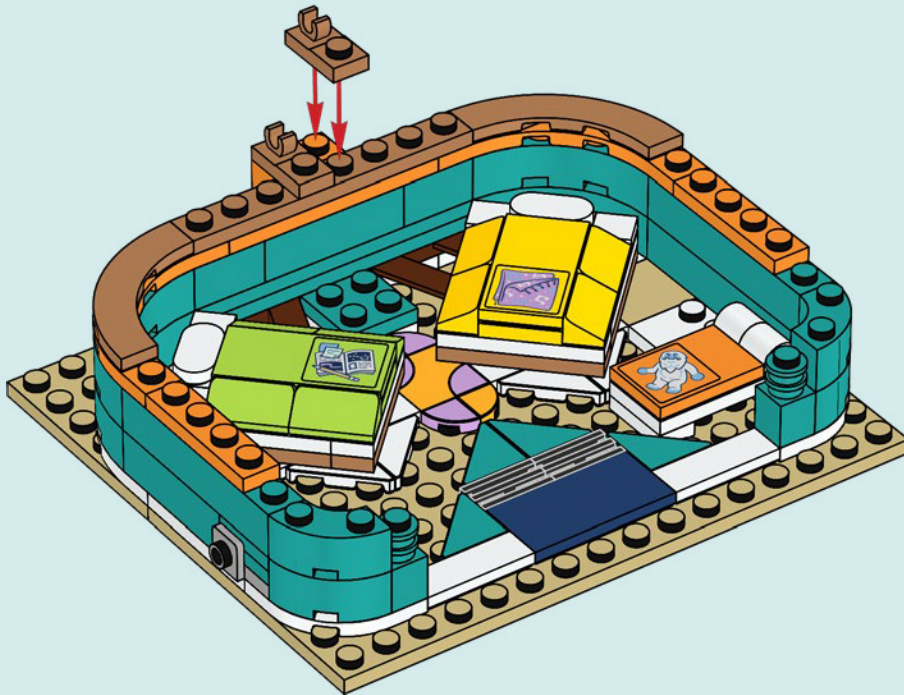



1x

43

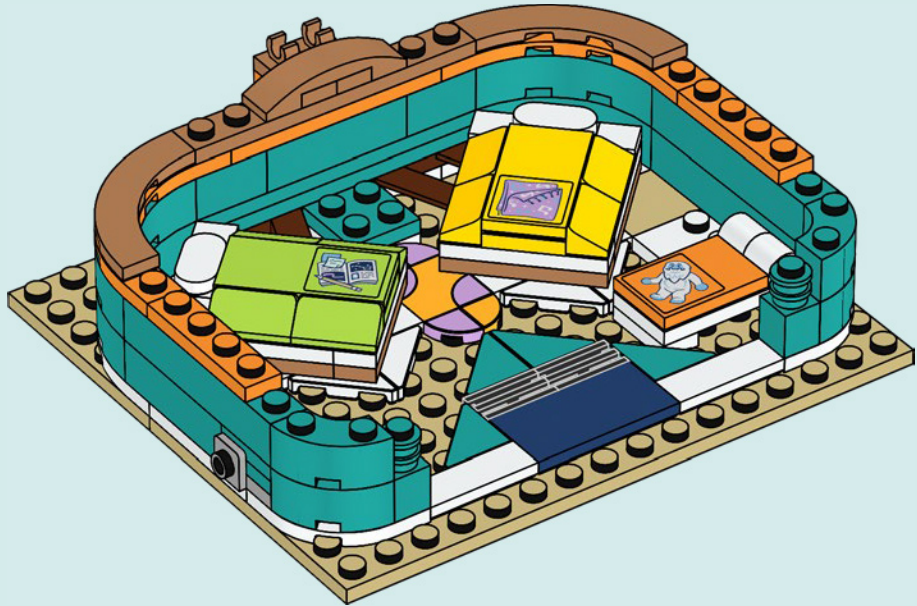

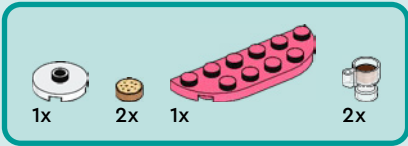

44

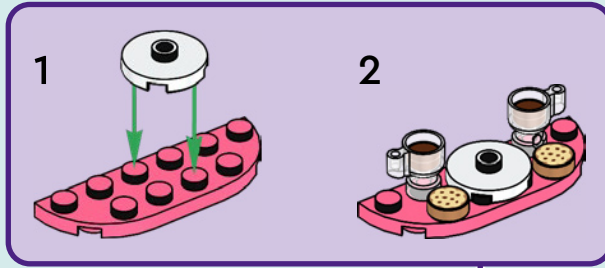



45

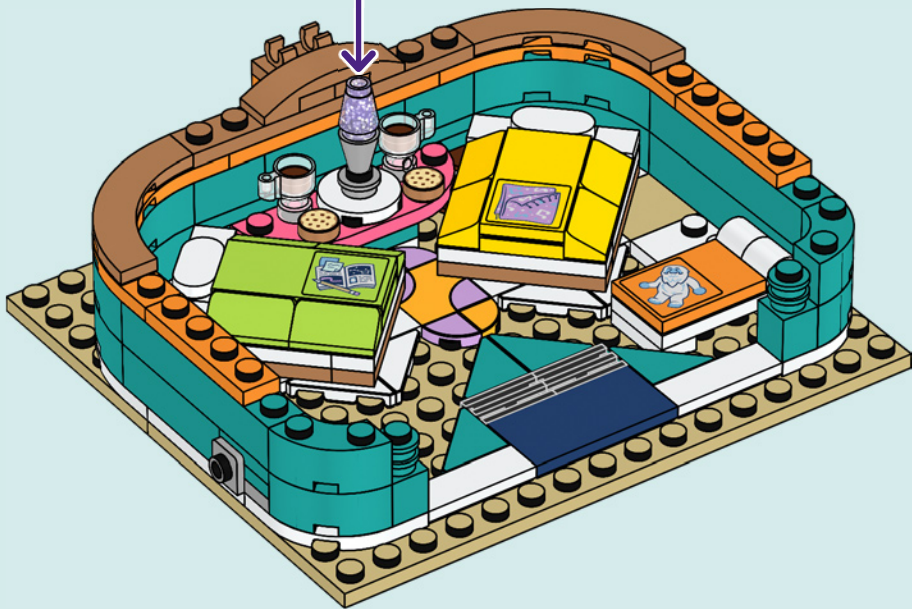
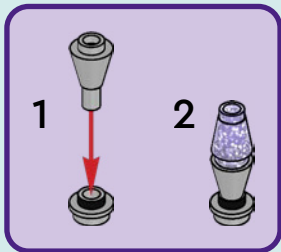



1x



1x



1x

46

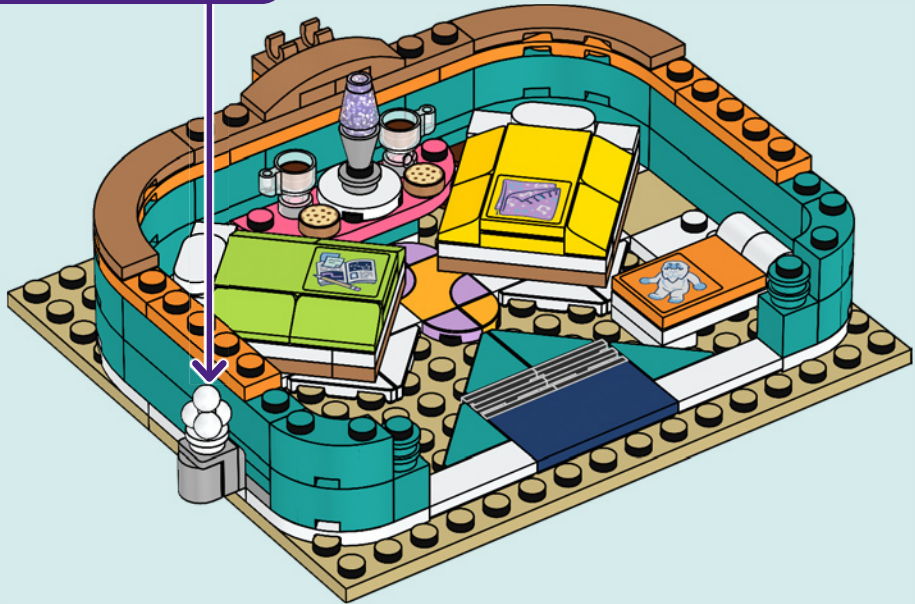
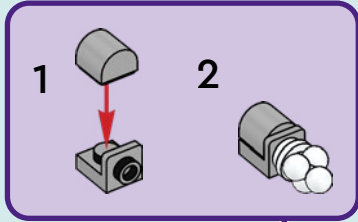

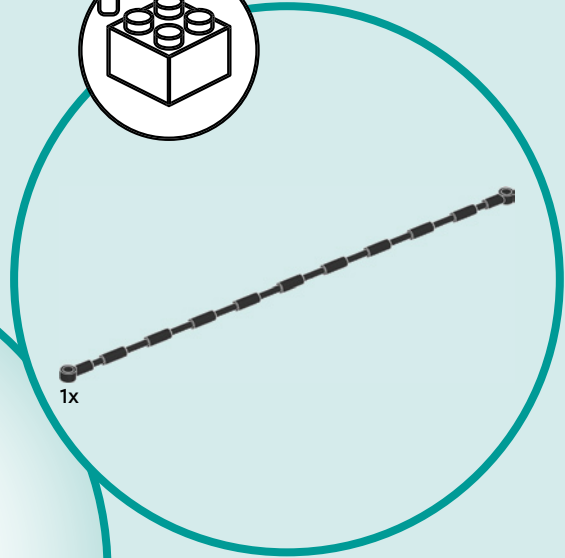
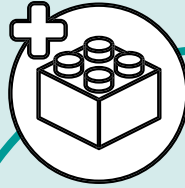



1x

47



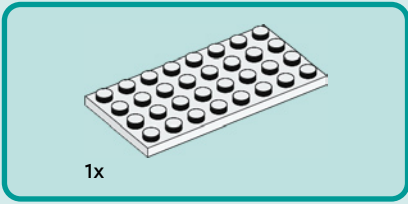

48





2x

49





2x

50



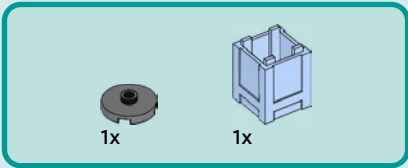

51





1x



1x

52

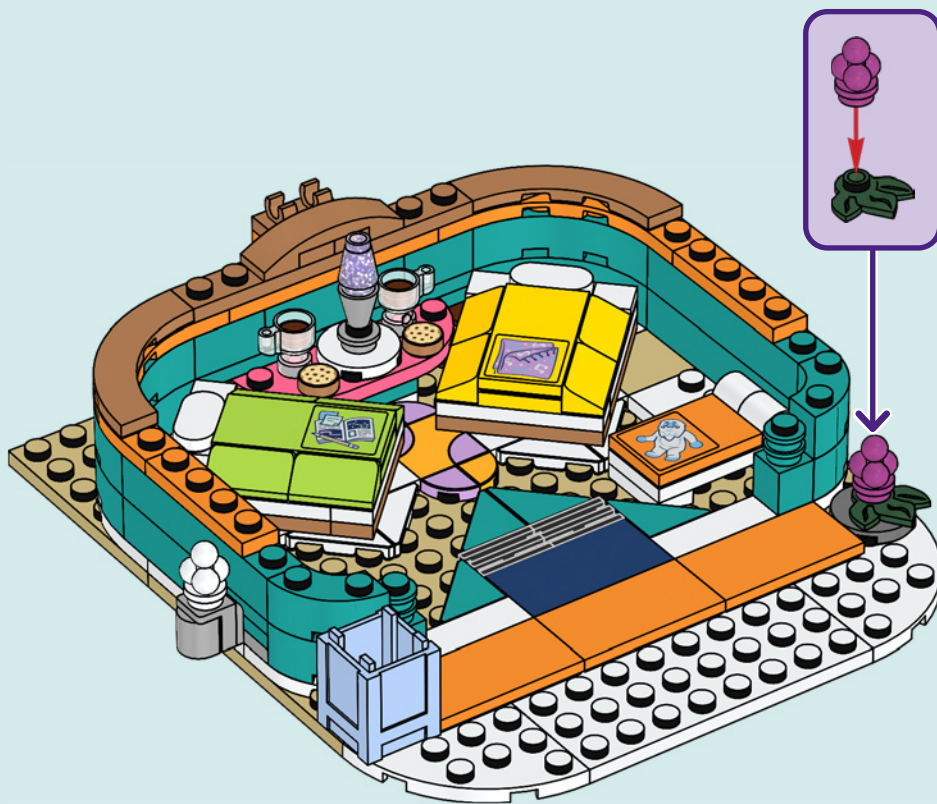



2x



2x

53



2x



2x

54





2x

55





2x

56



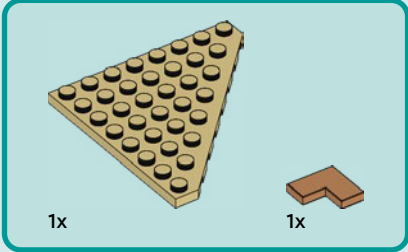
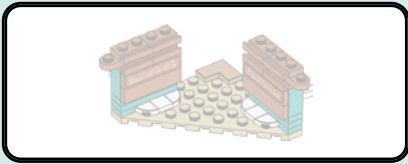

57

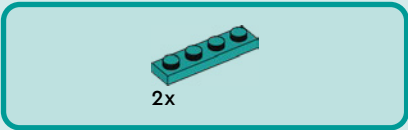
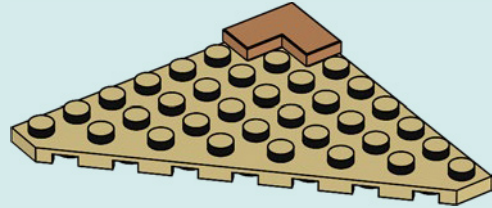

58

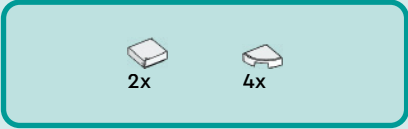
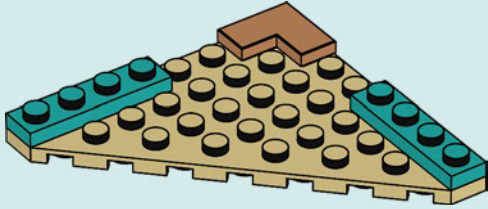

59

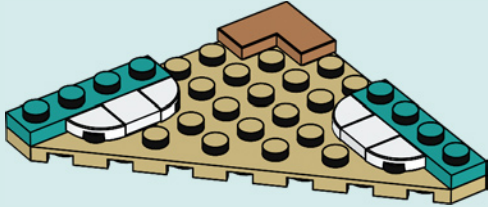

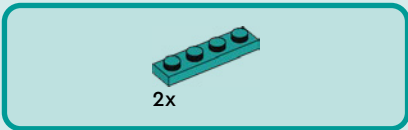

60

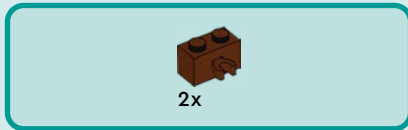
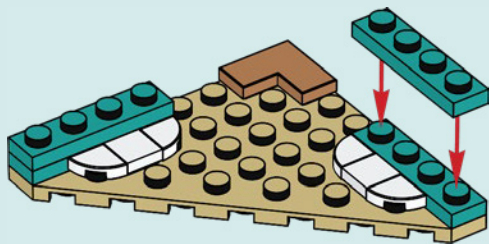

61

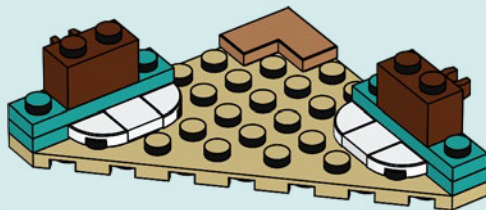

62

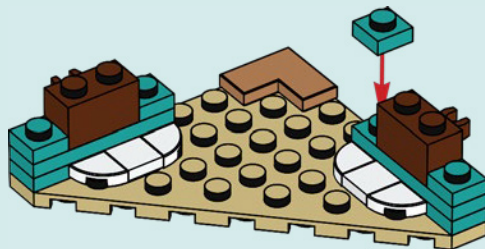



2x

63

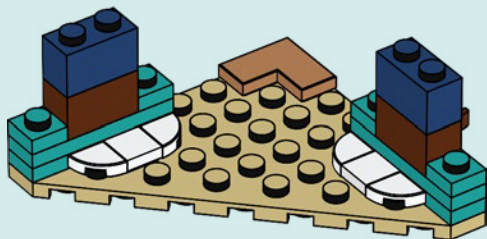

4x

64

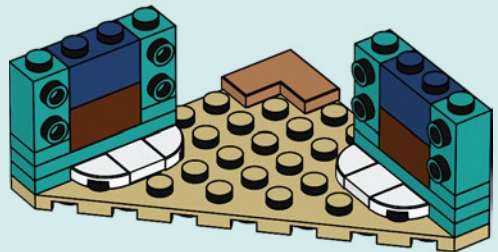

4x

65

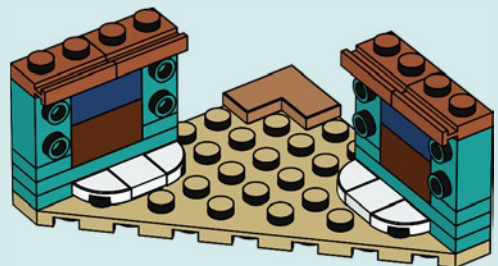

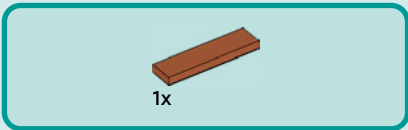

66

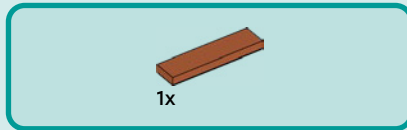
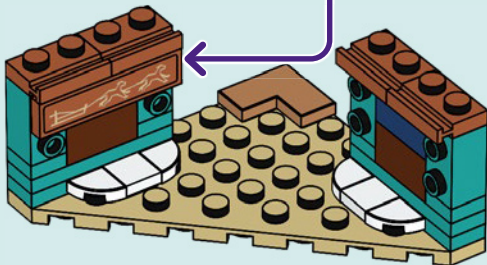
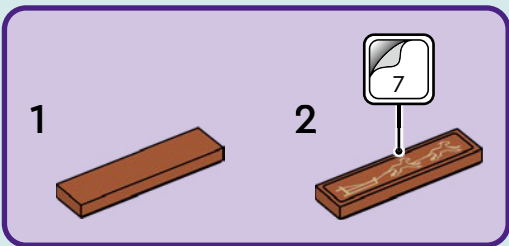

67

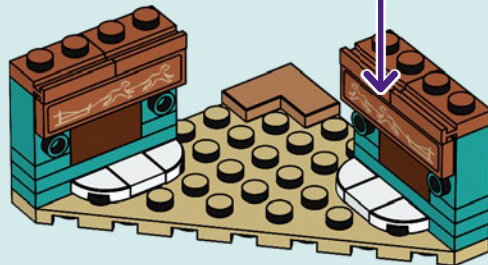
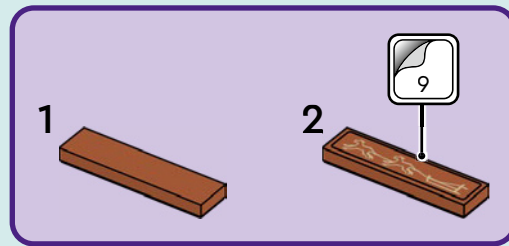



2x

68

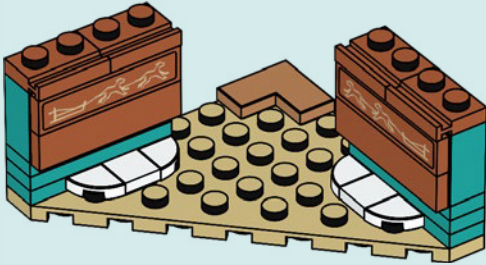

2x



2x

69

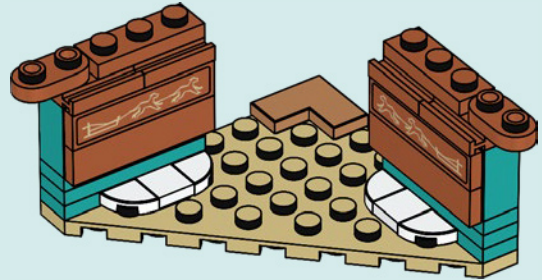

4x

70

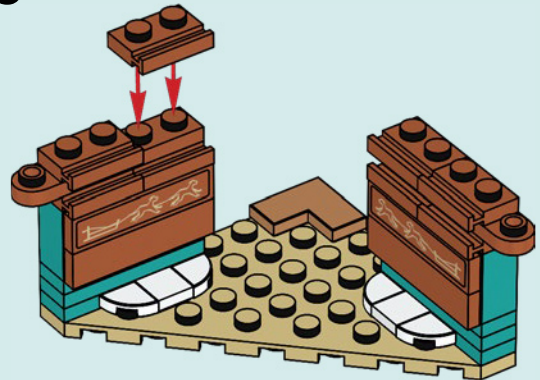



2x

71

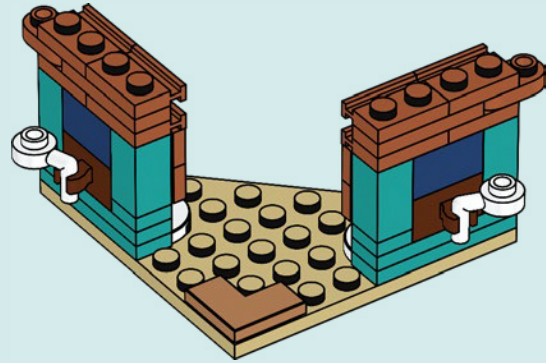

72





2x

73

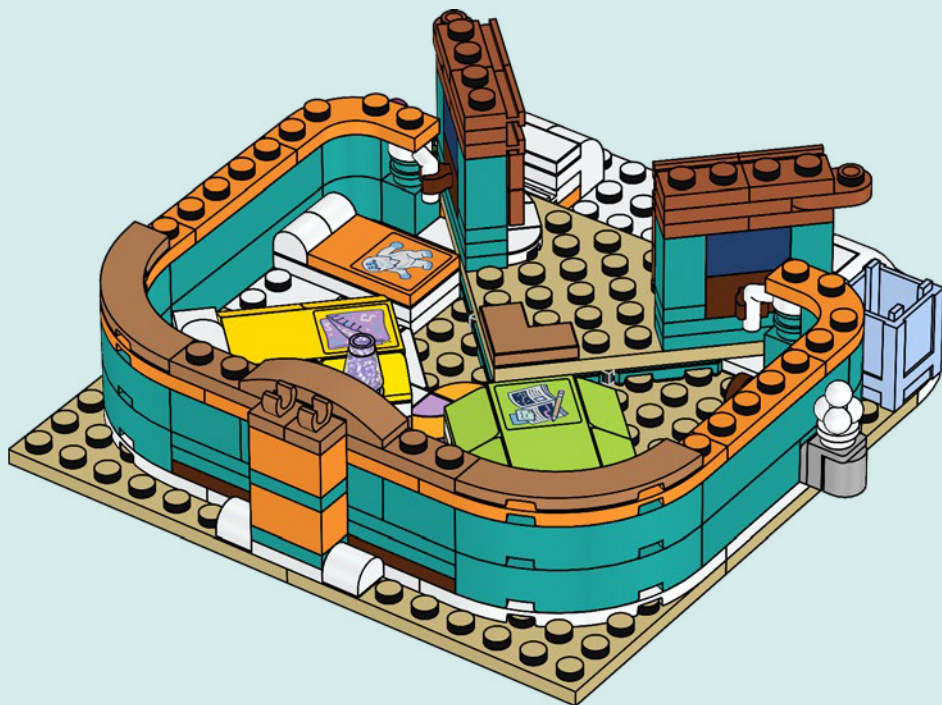

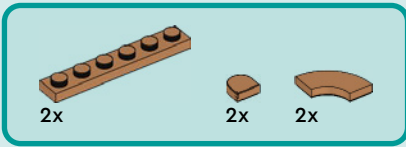

74

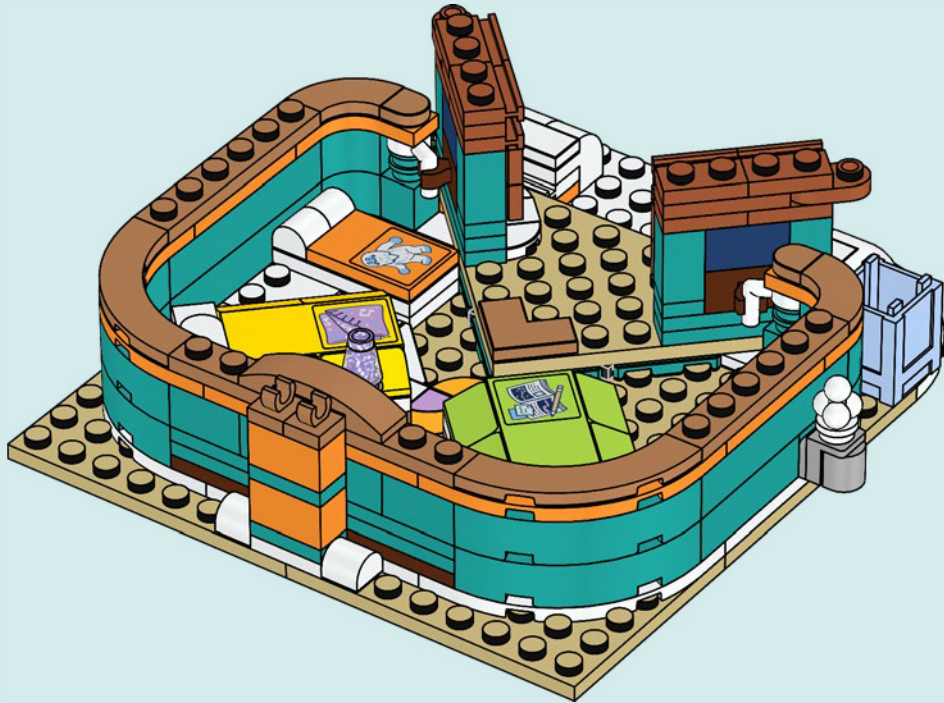

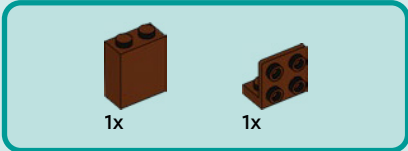
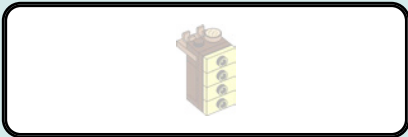

75

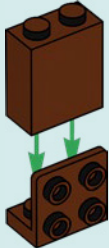

76

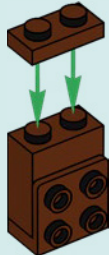

77

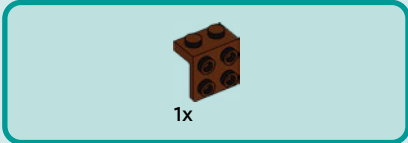
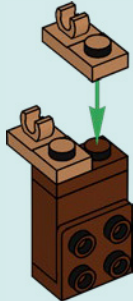

78





79

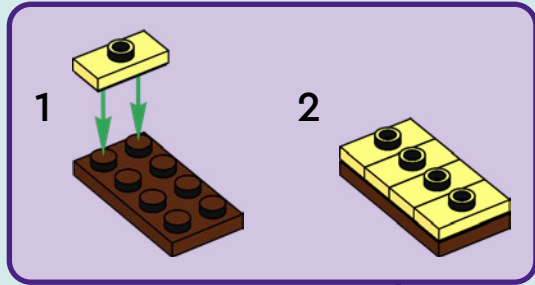

80



81

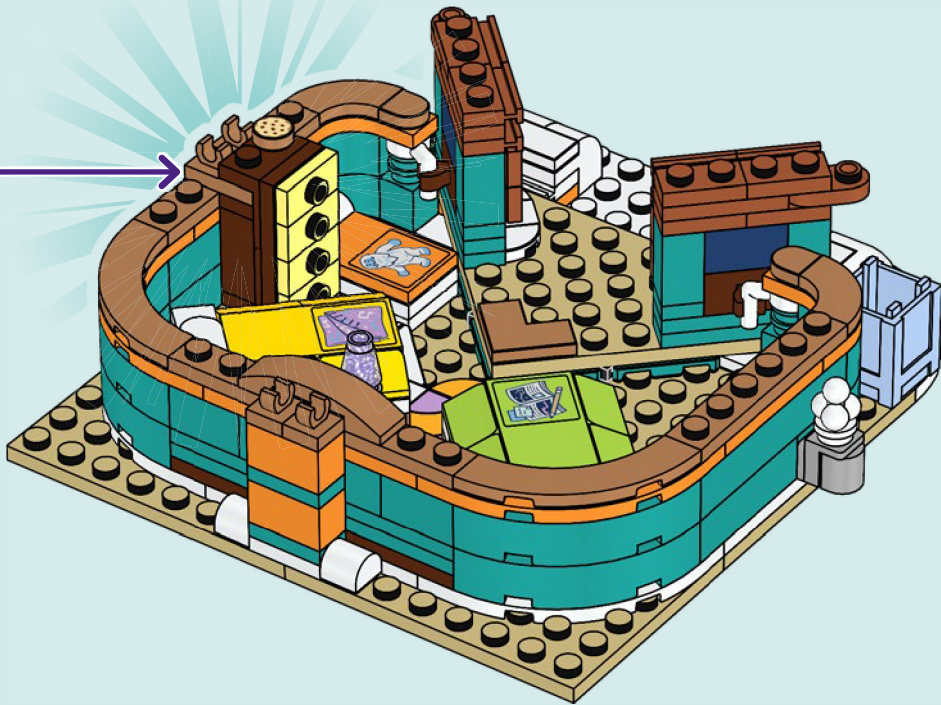

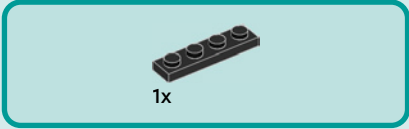

82

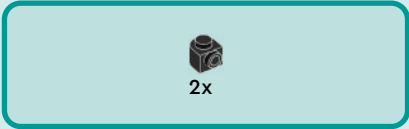
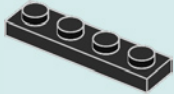

83

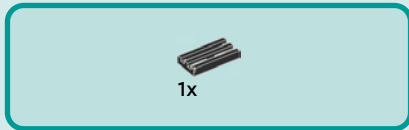
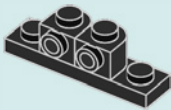

84

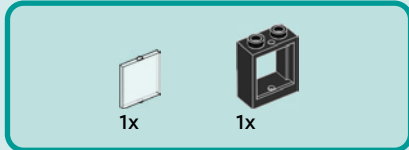
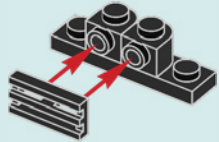

85

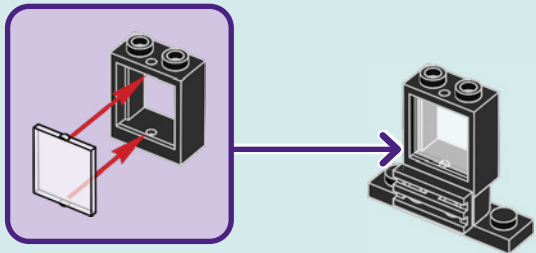



2x

86

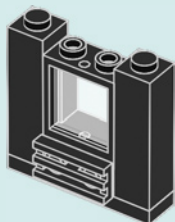

2x

87

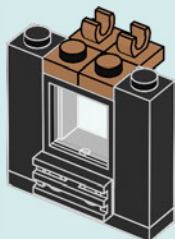

1x



1x

88

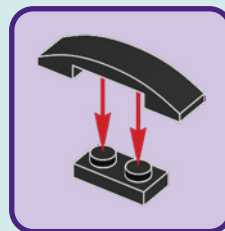

89

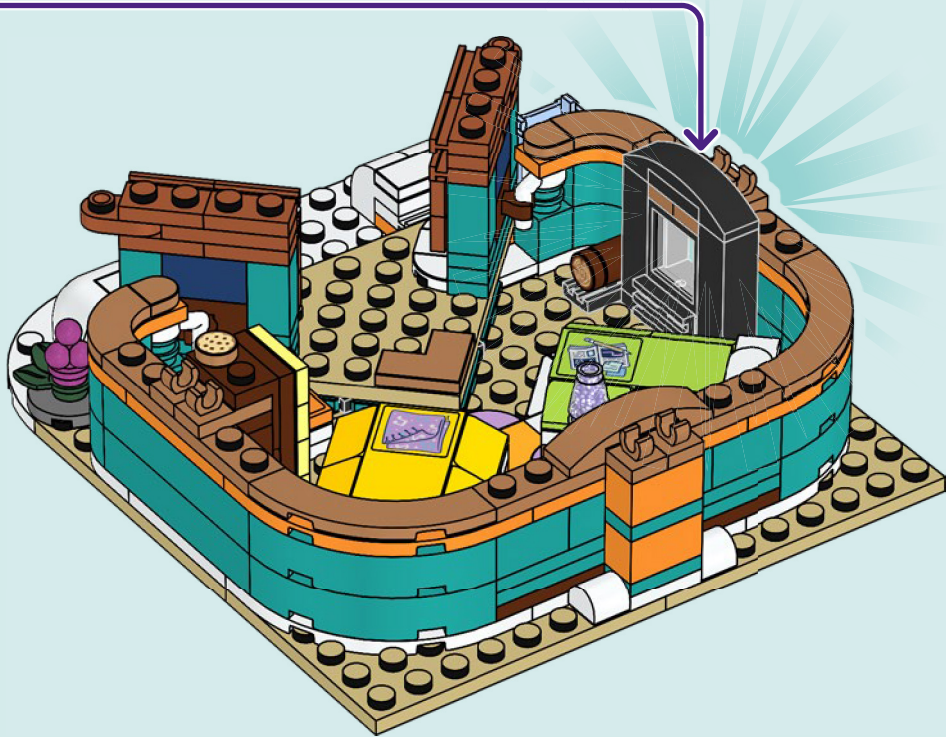



4x



4x

90

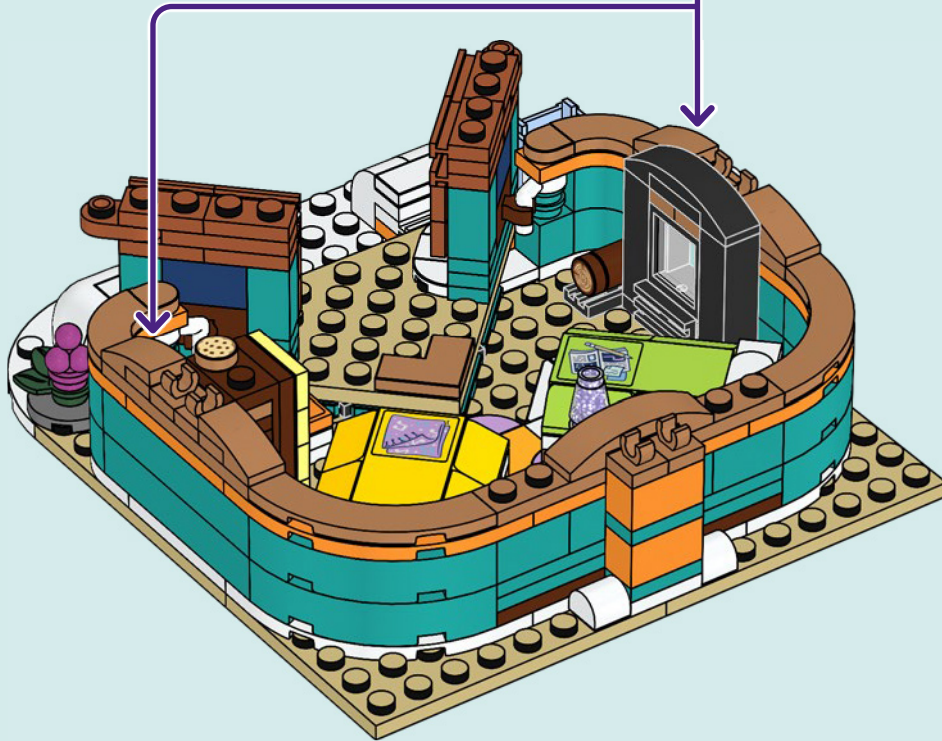
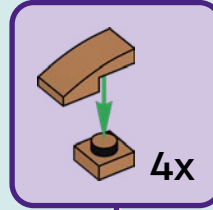

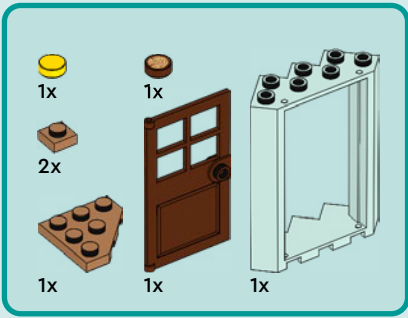

91

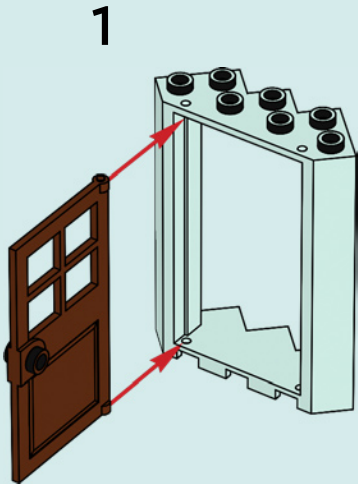



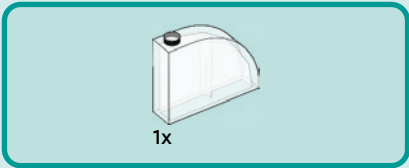

92

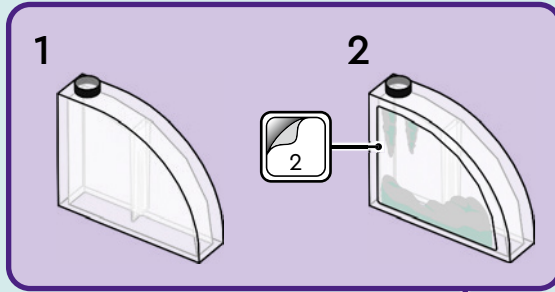

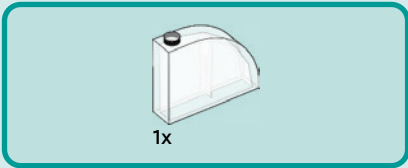

93

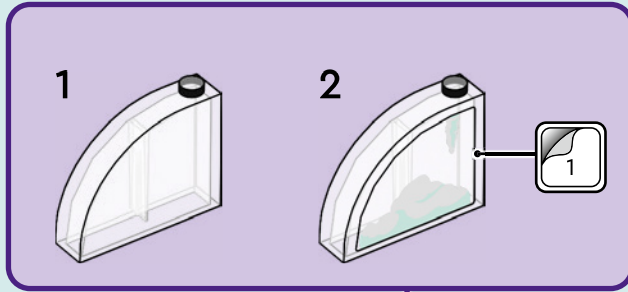

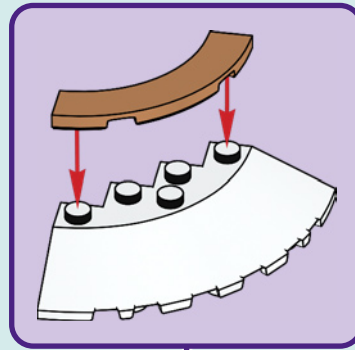
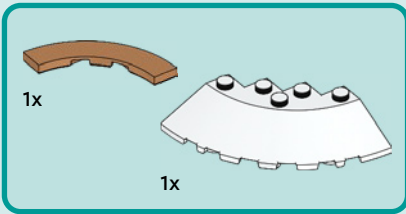

94





1x



1x

95

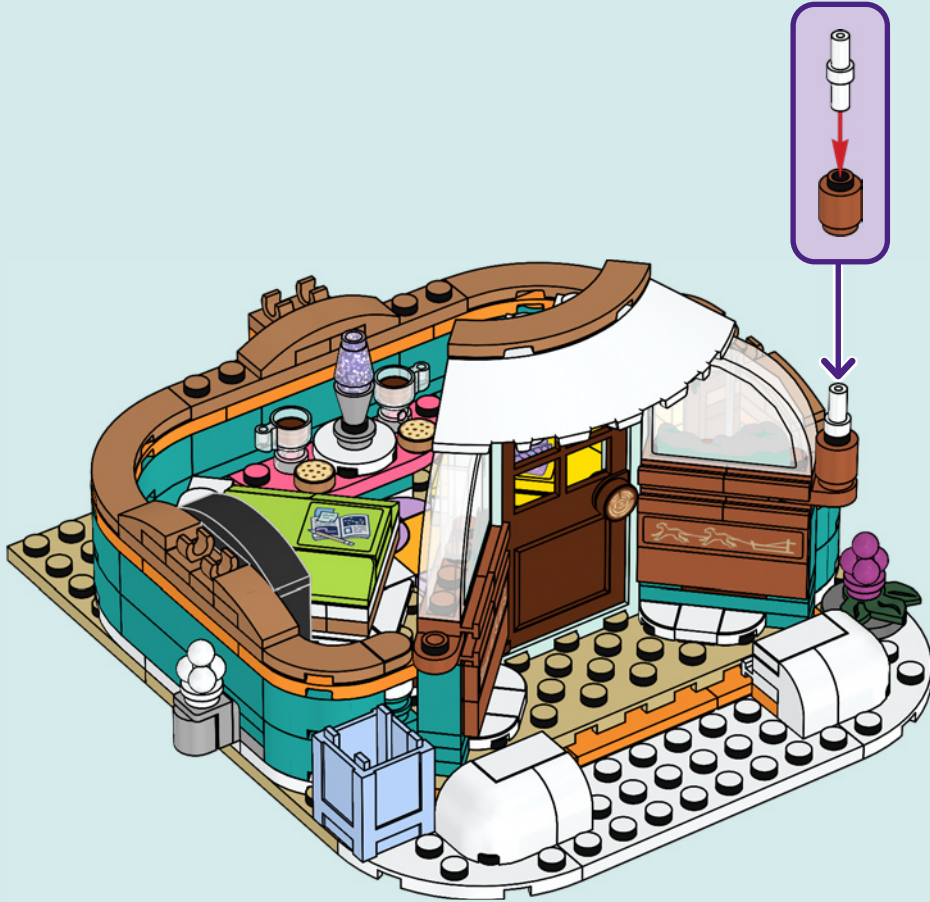



2x



1x



1x

96



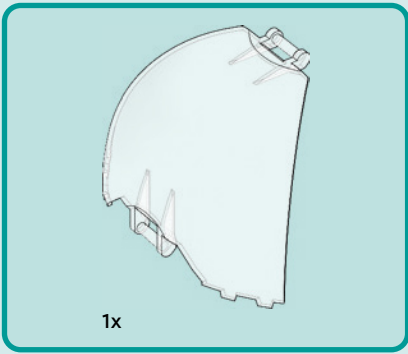

97

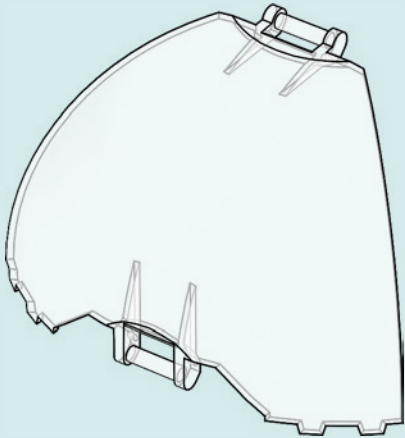

98

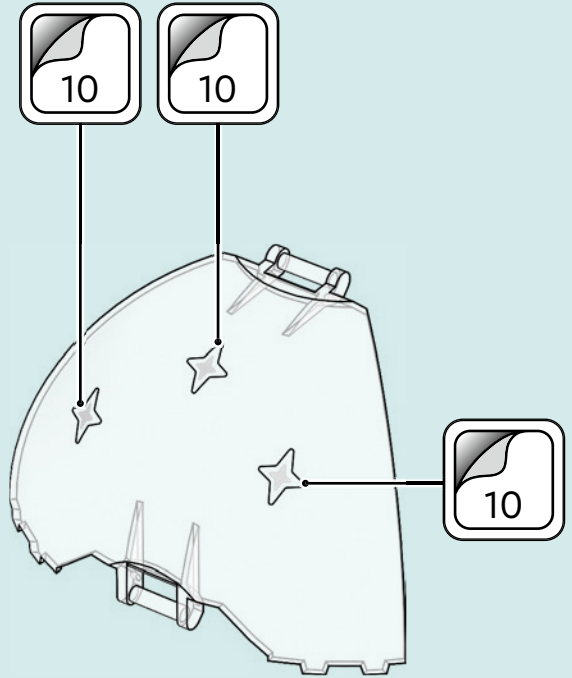

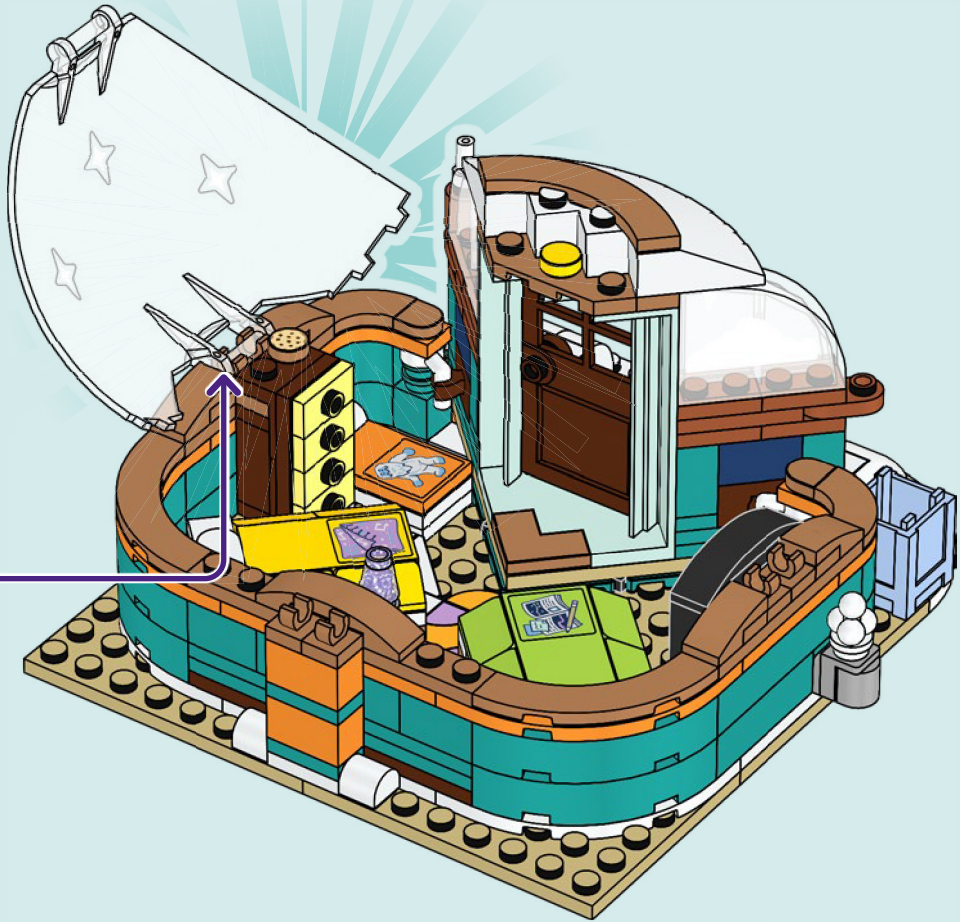

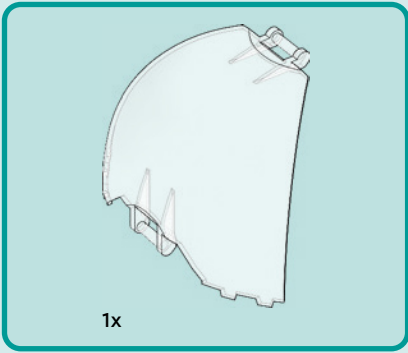

100

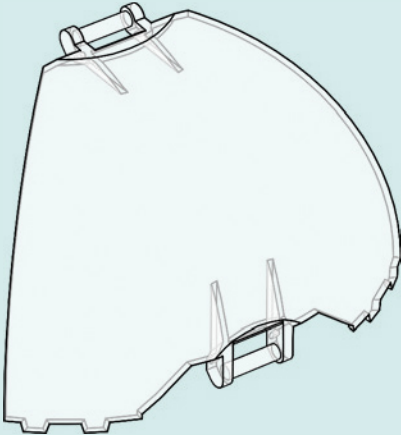

101

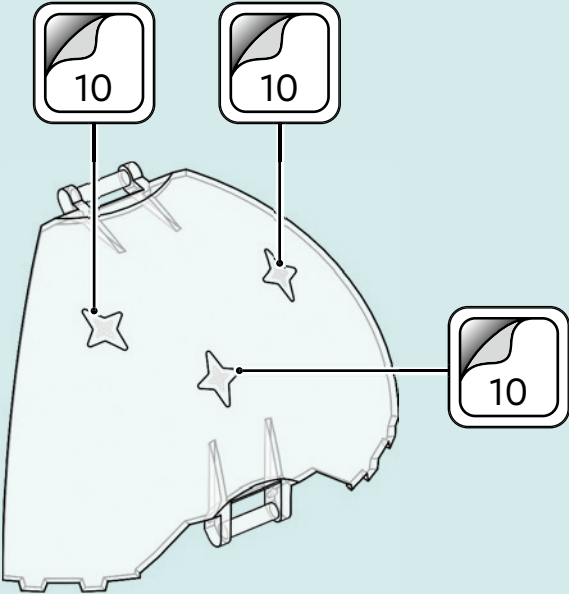

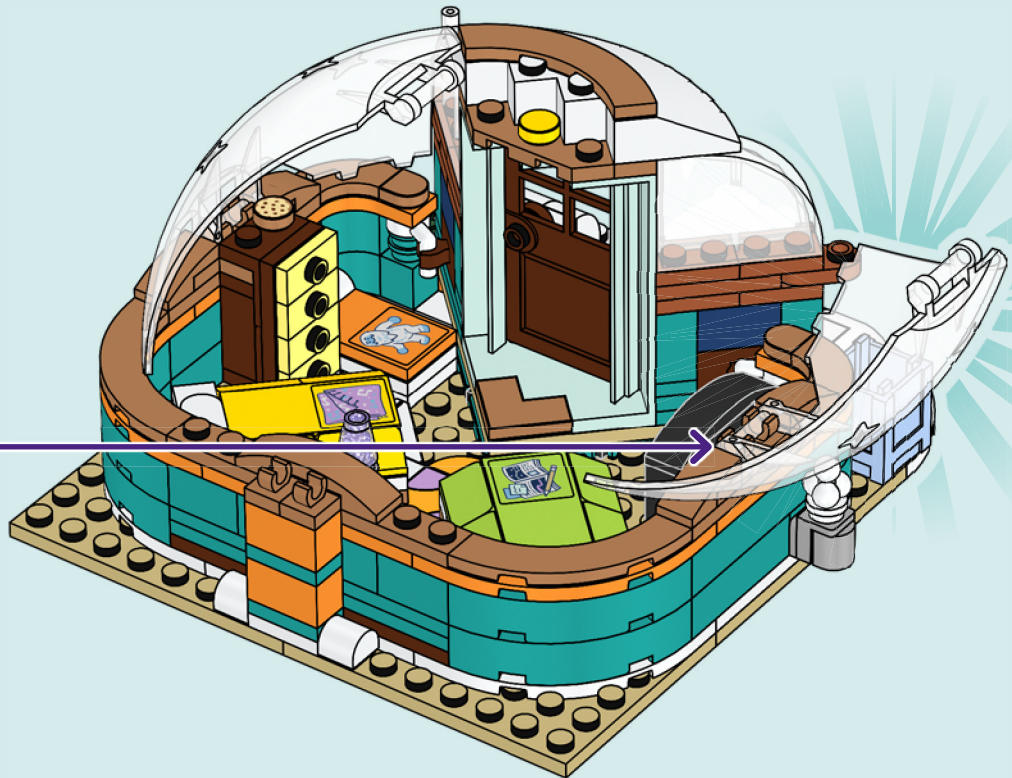

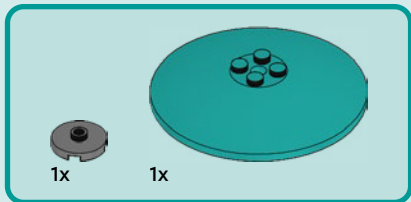
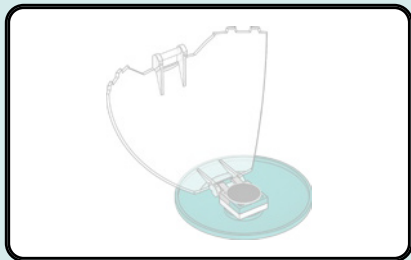

103

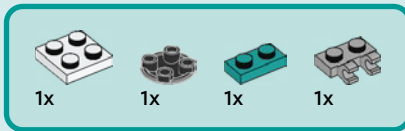
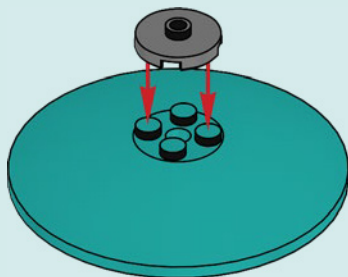

104

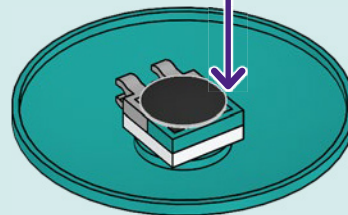
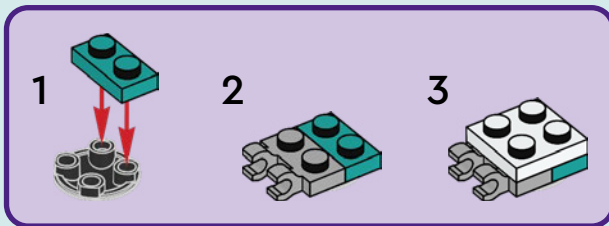

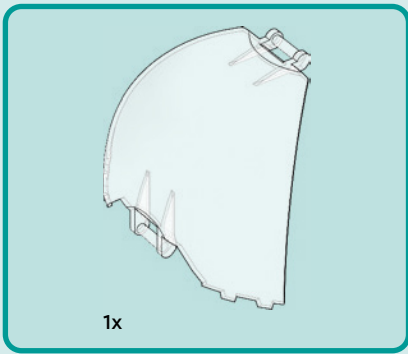

105

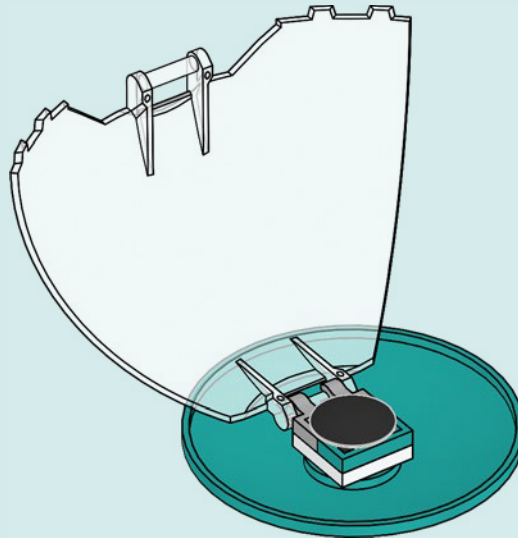

106

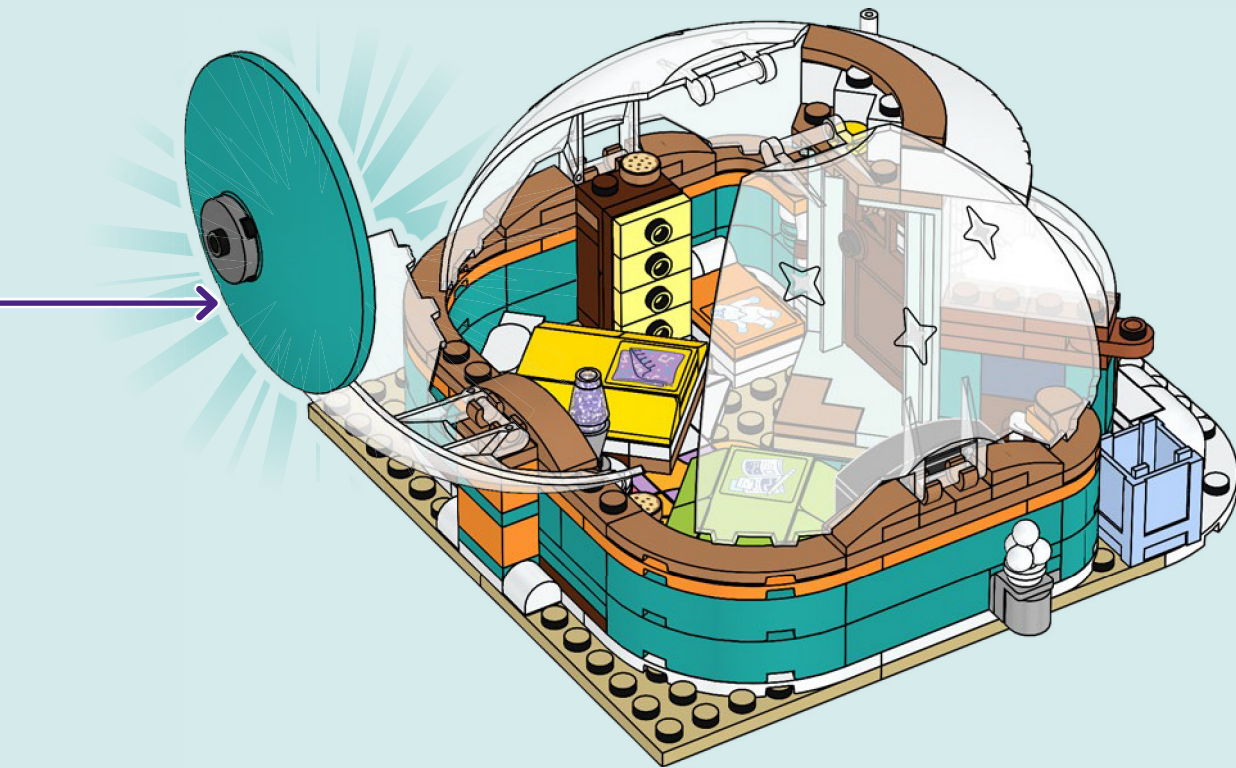



107

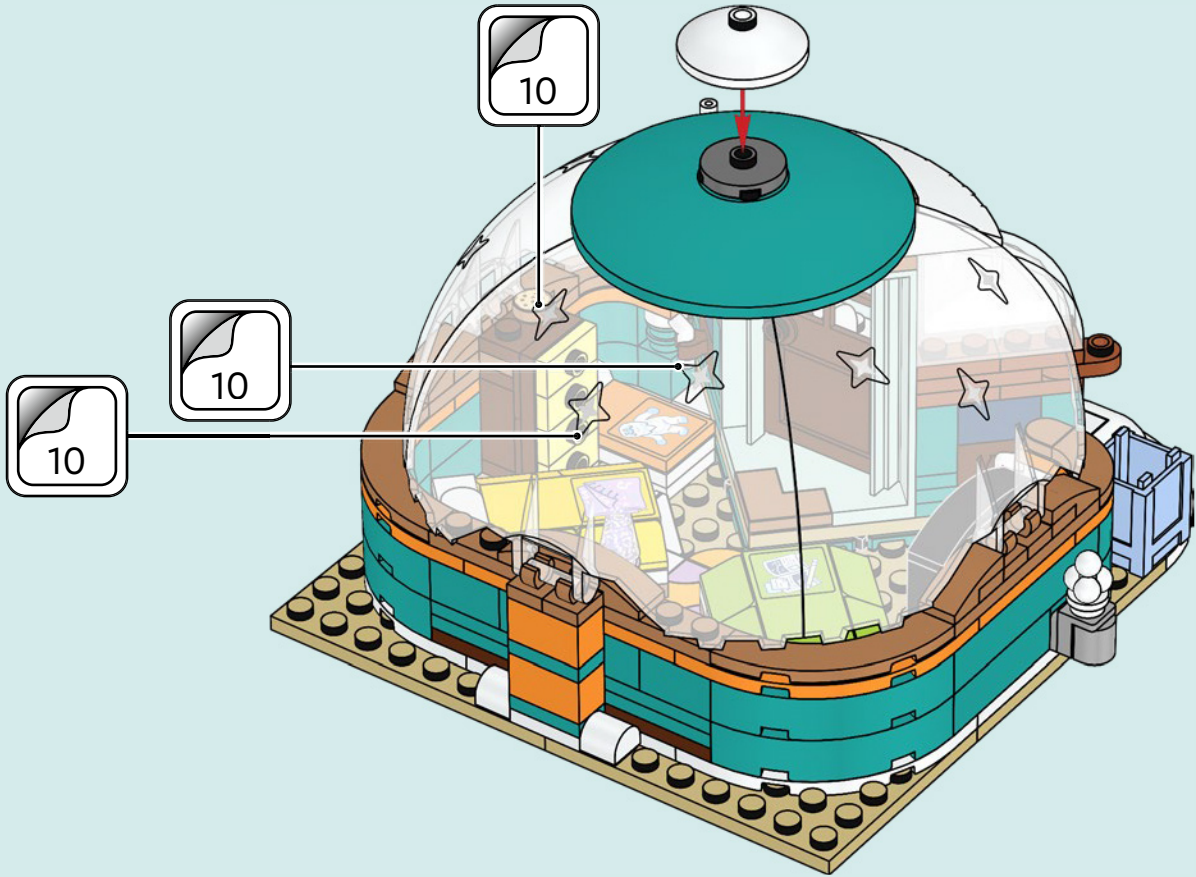

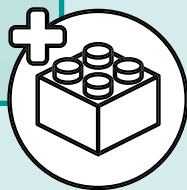
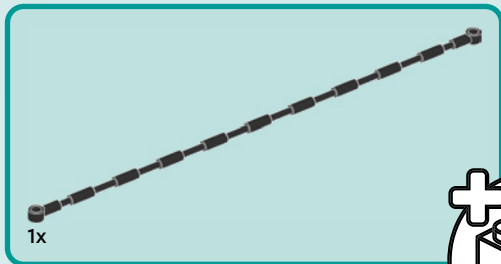

108

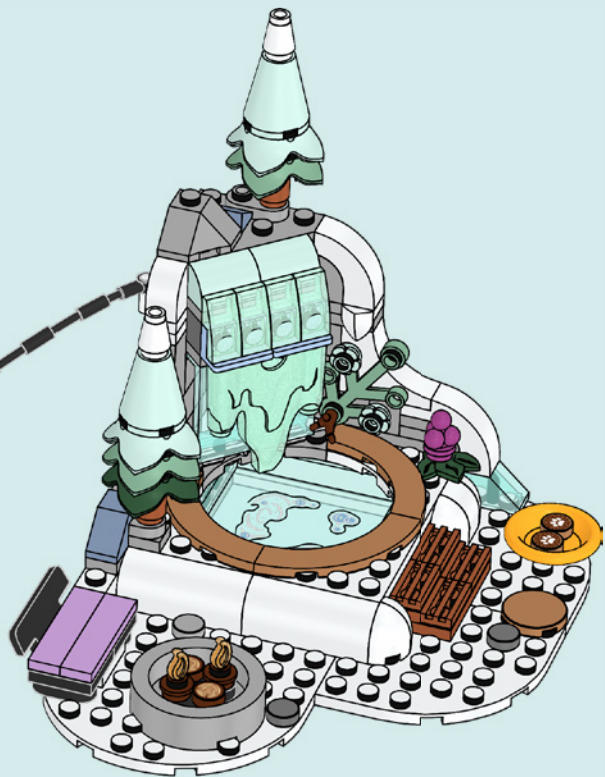
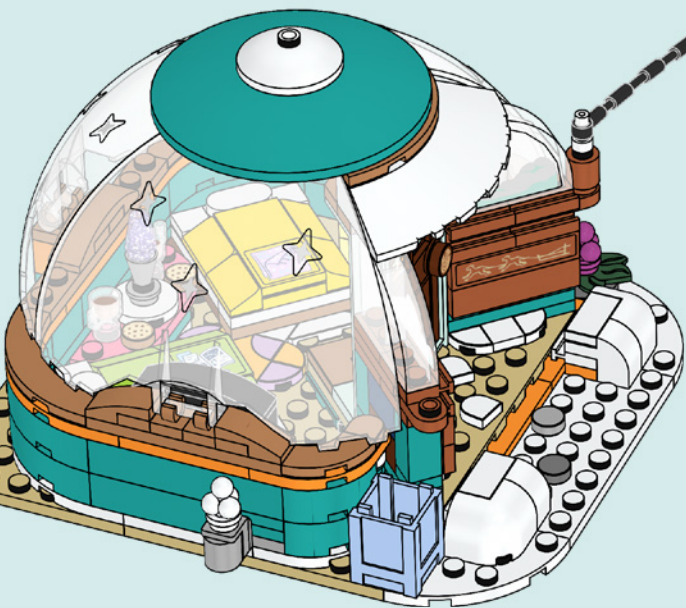



5x



4x



9x

109

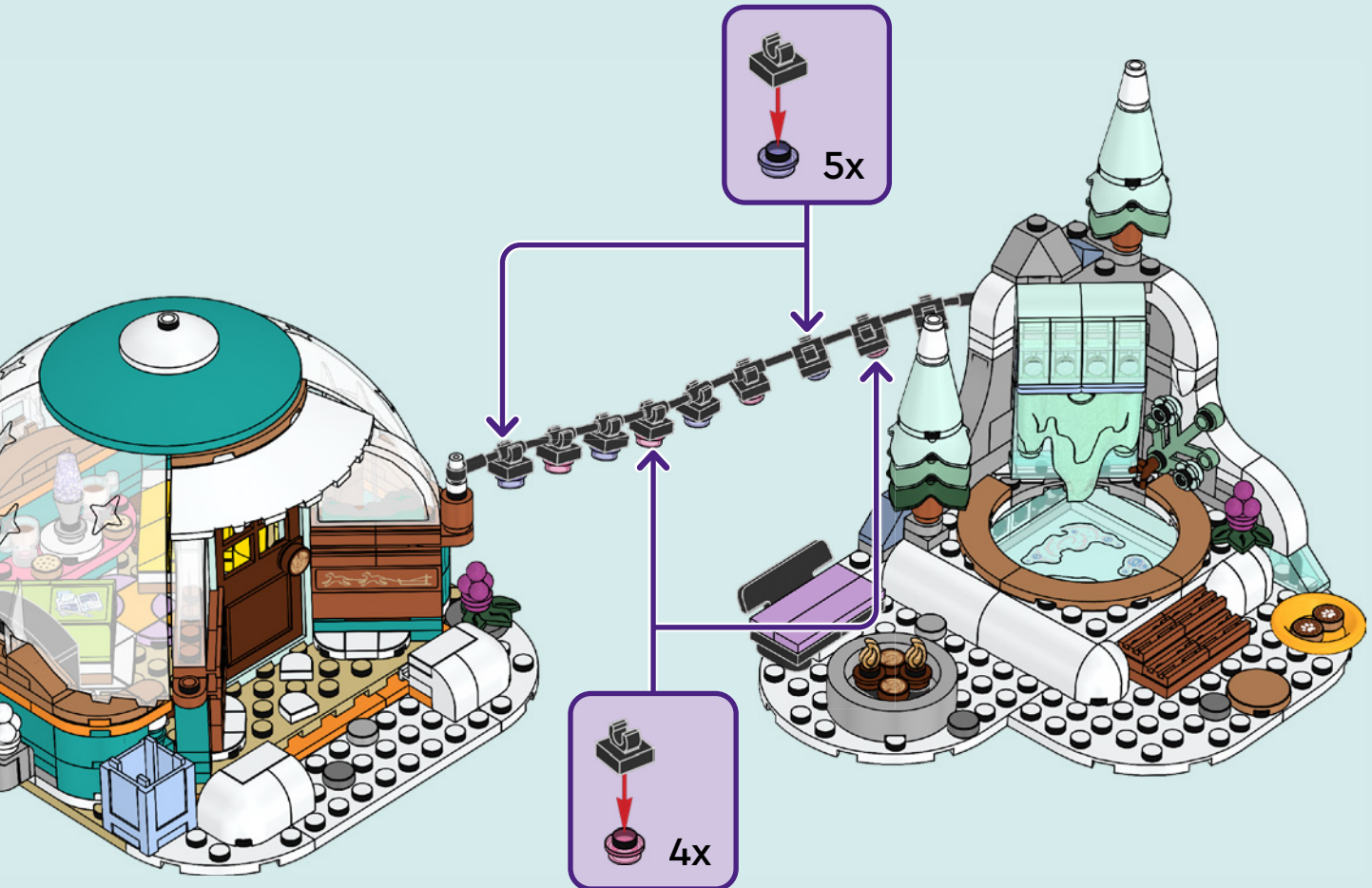





Friends

41745



41747



41748



41749



41744





Friends



2x
4518400



2x
6276148



1x
6458475



2x
6250591



4x
6172366



6x
307001



2x
302401



2x
407001



4x
6442360



7x
6258135



4x
6046905



2x
6170567



2x
6437184



2x
6448745

1x
6357680



1x
6093053



7x
302301



4x
6285777



2x
306901



2x
4249563



7x
6217875



2x
4140583



2x
302201



1x
6218822



1x
306801



2x
6299937



1x
4179580



2x
4558168

1x
6110019



2x
4629913



4x
371001



2x
301001



2x
6373439



2x
6339103



1x
6223667



2x
302001



2x
4560178



2x
608101



2x
6170419



2x
4243812

3x
6254335



2x
4178429



1x
379501



2x
6399559



3x
346001



1x
6033776



1x
6250286



2x
6057460



1x
303501



1x
6249095

1x
4185177



1x
4626948



2x
6070501



1x
4609726



2x
302423



2x
346023



1x
6284577



4x
4550348



1x
306924



1x
4218699



1x
302024

1x
4560181



2x
6451152



1x
6315887



1x
6321194



2x
6424674



9x
6335388



2x
6065496



4x
6210270



1x
4278359



4x
241226



2x
302326



1x
6382697



1x
6313116



2x
242026

- | | | | | | |
|---------------|---------------|---------------|---------------|---------------|---------------|
| 1x
6218700 | 1x
6274738 | 1x
6293710 | 1x
6213786 | 1x
4537936 | 2x
6447702 |
| 2x
6116604 | 1x
6254552 | 2x
4118782 | 4x
6213786 | 1x
6212989 | 1x
6328339 |
| 1x
371026 | 2x
6288587 | 2x
6457108 | 4x
6334128 | 2x
6459341 | 1x
6409769 |
| 1x
4613153 | | 3x
4648853 | 1x
6249390 | 5x
6240210 | 2x
6357747 |
| 1x
6440995 | | 1x
4173332 | 4x
6325429 | 1x
6337632 | 2x
6214457 |
| 3x
6074890 | 3x
6444502 | 2x
6457109 | 4x
6350418 | 1x
6062686 | 1x
6433937 |
| 2x
6369194 | 1x
6373578 | 4x
6325978 | 2x
6217660 | 1x
6248952 | 1x
4243920 |
| 5x
6228922 | 1x
6245267 | 4x
6439825 | 3x
6396079 | 1x
4528604 | 1x
6345847 |
| 8x
6228839 | 1x
6245267 | 4x
6213778 | 2x
6259921 | 1x
6356427 | 2x
6186673 |
| 2x
6186007 | 1x
6245257 | 2x
6213776 | 1x
6249387 | 1x
6459420 | 4x
6285623 |
| 4x
6074893 | 1x
6426239 | 1x
6435006 | 4x
6240230 | 2x
4249891 | 1x
4211183 |
| 1x
6074892 | 2x
4121739 | 5x
6213777 | 4x
6025026 | 1x
4569836 | 2x
6215659 |
| 1x
4535928 | 2x
4177932 | 2x
6217659 | 1x
6185108 | 2x
6400754 | 2x
6454153 |
| | | | | 5x
6238874 | 5x
6238874 |
| | | | | 1x
6426730 | 2x
6330202 |

1x 6172808
1x 4211150
1x 6092590
1x 6133860
1x 6226436
1x 6117976
1x 4271949
1x 6103769
1x 4211186
2x 6084573
1x 6167667
2x 6284071

1x 6168647
1x 6262085
5x 4211399
7x 4211389
3x 6335328
2x 6248890
1x 6383177
1x 6285778
1x 6337268
1x 6435163
1x 6435117
1x 6034676
2x 4211428
1x 4160560

6x 4211445
1x 4211636
1x 6031056
1x 6303438
1x 6310881
1x 6442144
1x 4211393
1x 6353802
1x 4211406

3x 6284596
2x 6115080
2x 4211088
1x 6092572
3x 4211133
1x 4210725
2x 6372232
1x 6383137
1x 6416490
1x 6416675
1x 6458419

3x 6287854
2x 6349124
6x 6215606
1x 6368592
6x 6347304
4x 6356566
2x 6347306
1x 6349274
2x 6375826
1x 6213276
1x 6187006
4x 6167700
1x 6273854
2x 6295464
6x 6387478

1x 6313600
1x 6347603
2x 6251854
1x 6416494
2x 6447700
2x 6236575
2x 6447701
1x 6355734

4x 6240465
2x 6101169
1x 6386989
4x 6449385
1x 6338003
1x 6416663
1x 6465886
2x 6097419
1x 6433304
1x 6409768
1x 6170292
2x 6287856
4x 6455624
4x 6195266

 [LEGO.com/service](https://www.LEGO.com/service)



YOU COULD

WIN



Scan this QR code or go to
LEGO.COM/PRODUCTFEEDBACK and give us
your short feedback about this LEGO® set for a
chance to win a cool LEGO prize.

Terms and Conditions apply*

EN: YOU COULD WIN. Terms and Conditions apply* **DE: Du könntest GEWINNEN.**
Es gelten die Teilnahmebedingungen* **FR: Tu pourrais GAGNER.** Des conditions
s'appliquent* **IT: Potresti VINCERE tu.** Termini e condizioni sono applicabili*
ES: Puedes GANAR. Aplican términos y condiciones* **PT: Poderá GANHAR.** Aplicam-se termos
e condições* **ZH: 轻松获奖. 条款和条件适用*** **PL: Szansa na WYGRANĄ.** Obowiązują
warunki korzystania* **CS: Máte šanci VYHRÁT.** Platí všeobecné smluvní podmínky* **SK:
Máte šancu VYHRAŤ.** Platia všeobecné zmluvné podmienky* **HU: TE IS NYERHETSZ.**
Felhasználási feltételek érvényesek* **RO: Ai putea CÂȘTIGA.** Se aplică termenii și condiții*
BG: Можете да СПЕЧЕЛИТЕ. Има определени правила и условия* **LV: Tu vari LAIMĒT.**
Ir spēkā noteikumi un nosacījumi.* **ET: Sul on võimalus VÕITA.** Kehtivad tingimused*
LT: Jūs galite LAIMĖTI. Taikomos sąlygos*

*[LEGO.com/productfeedback-terms](https://www.lego.com/productfeedback-terms)