



CITY

4203



1

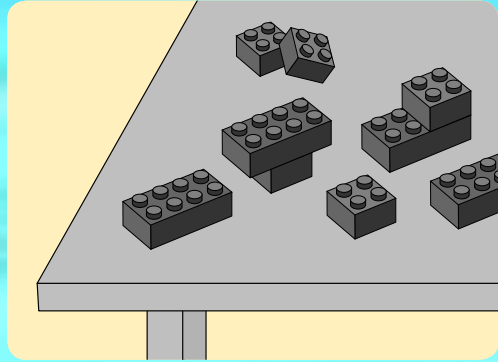
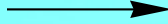
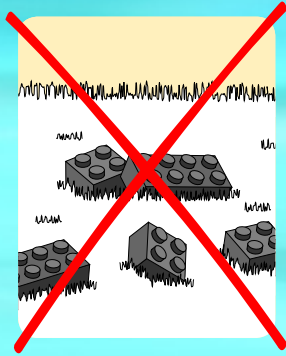

2

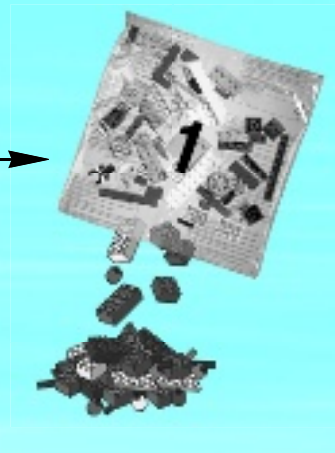

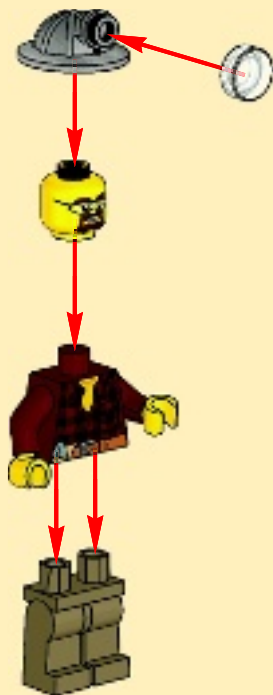

1



2

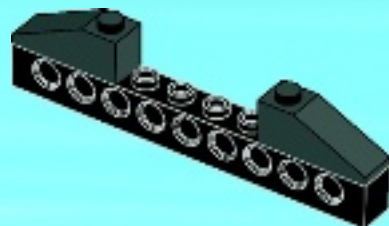

3

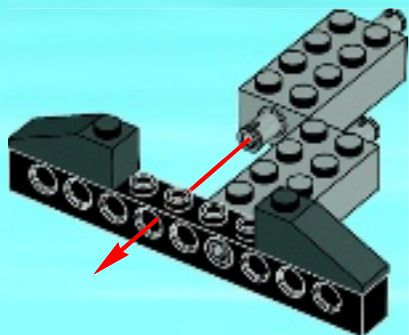

4



5

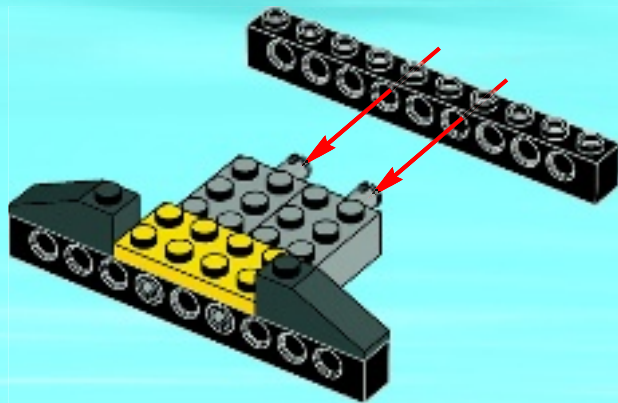

6

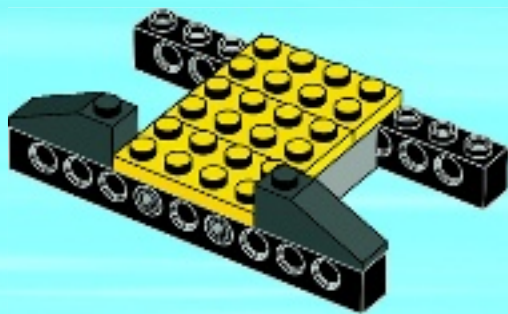

7

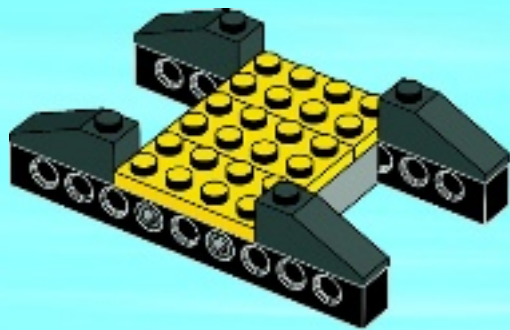

8

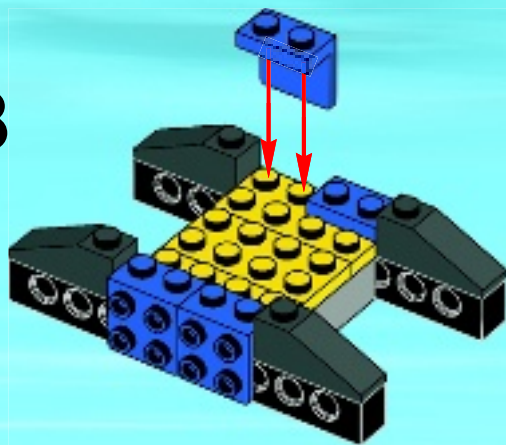

9



10

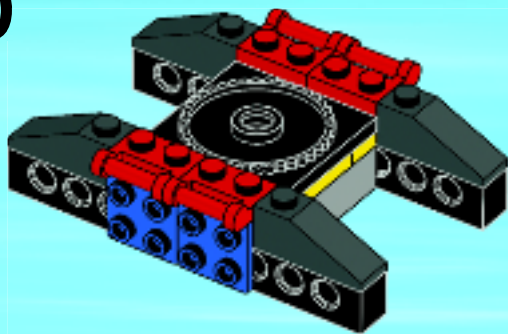

11



12

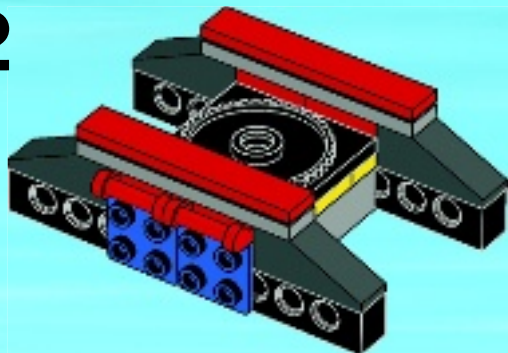

1



2

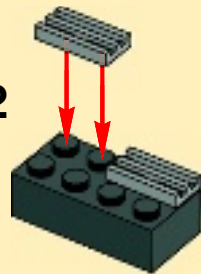

3

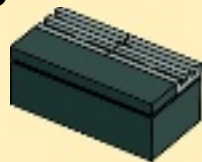

2x

13

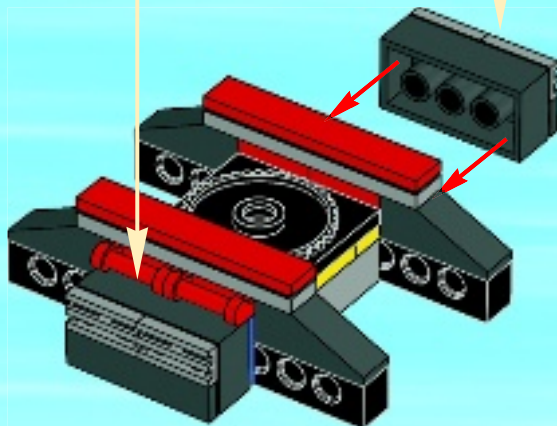



1



2

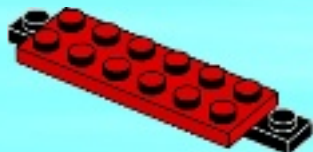

3



4



5

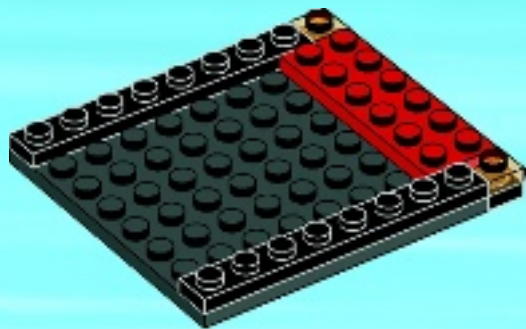

6



7

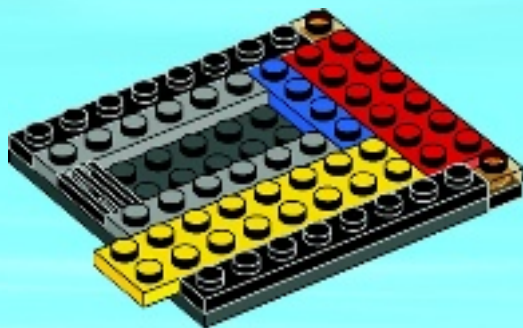

8

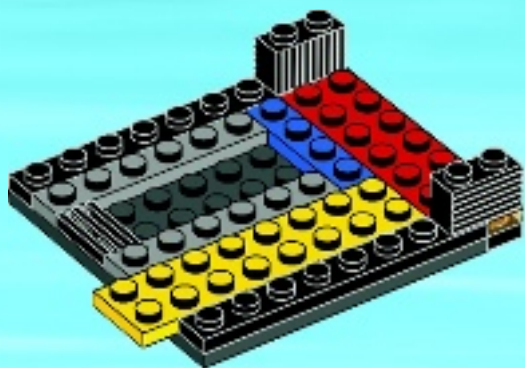

9

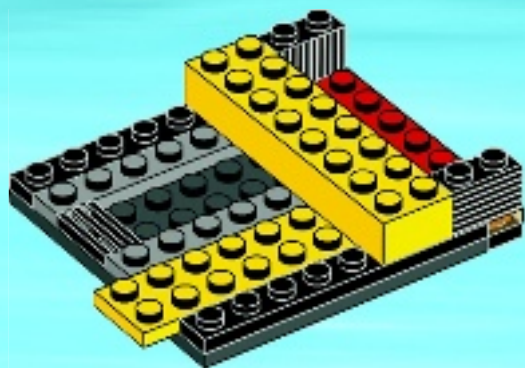

10

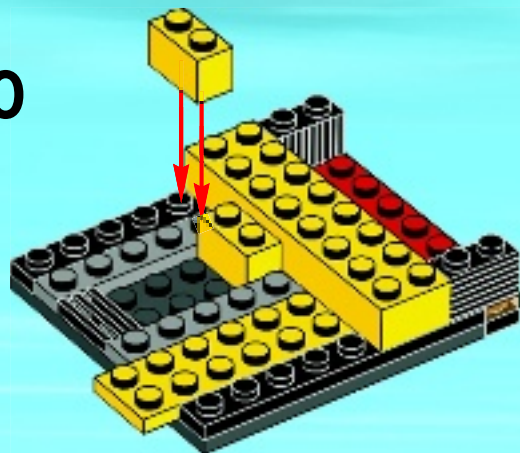

11

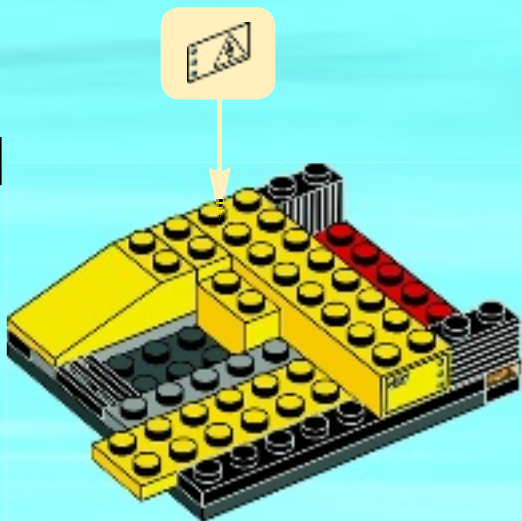

12

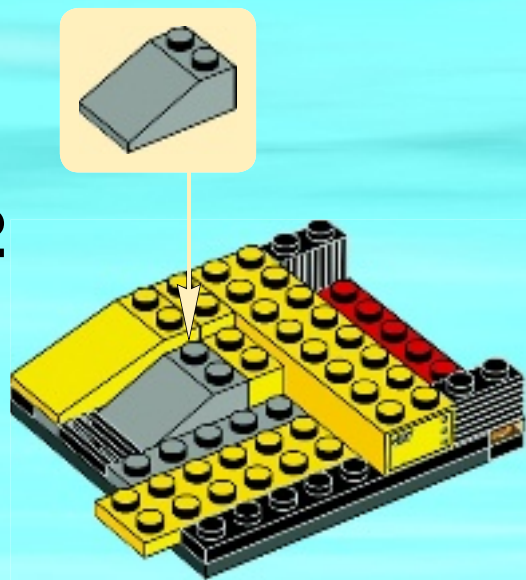

13

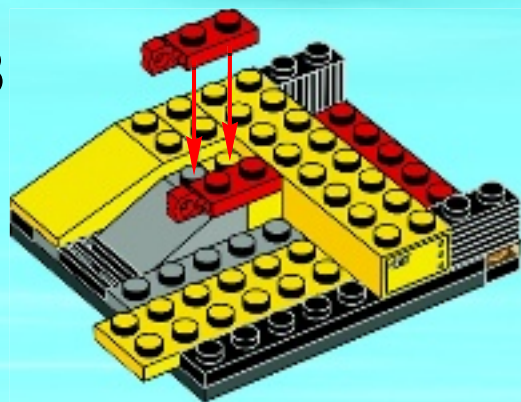

14

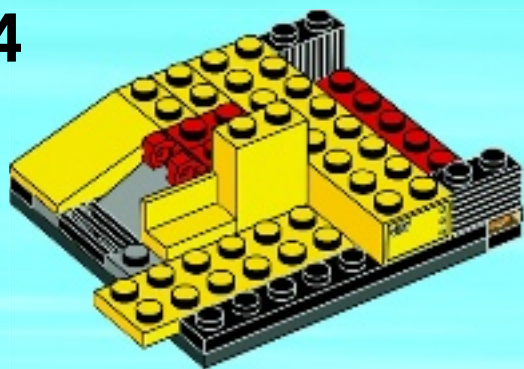

15

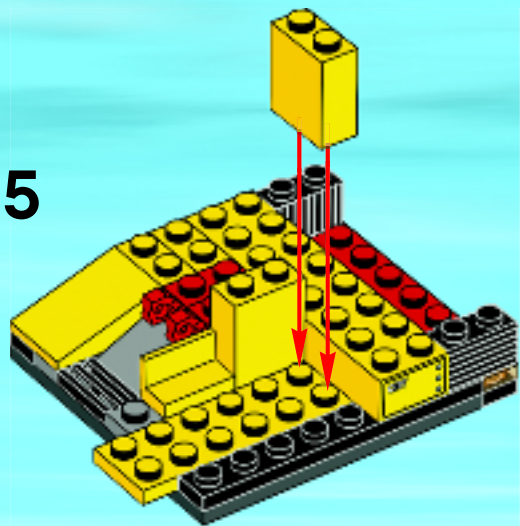

16

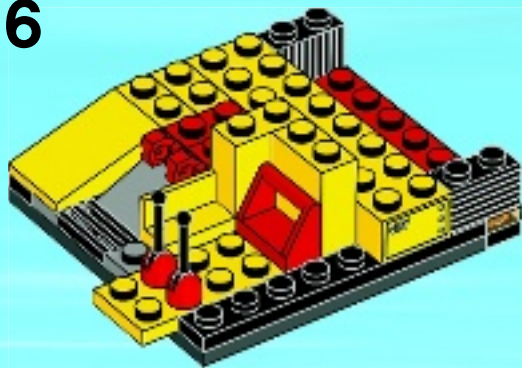

17

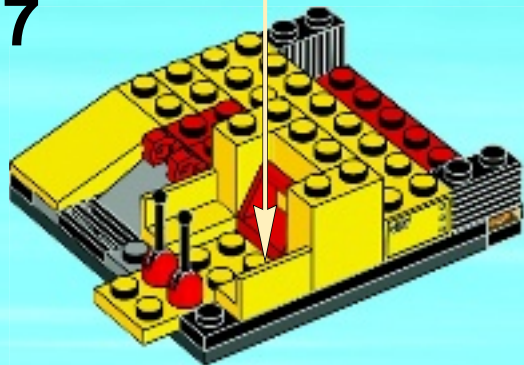
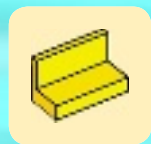

18



19

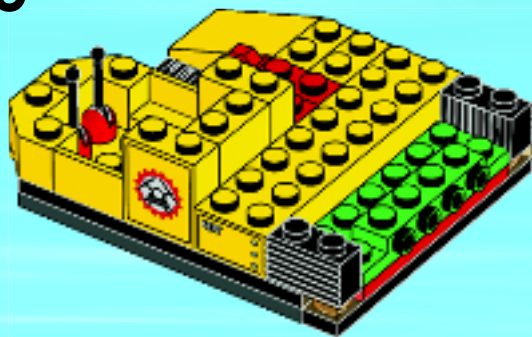

20

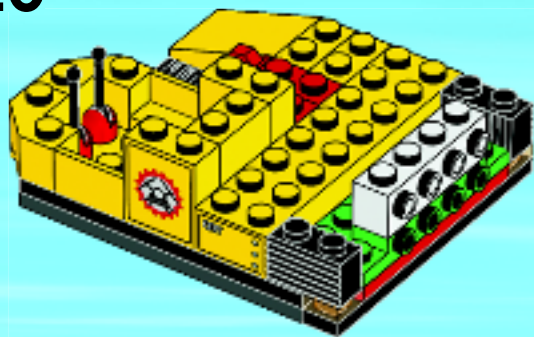

21

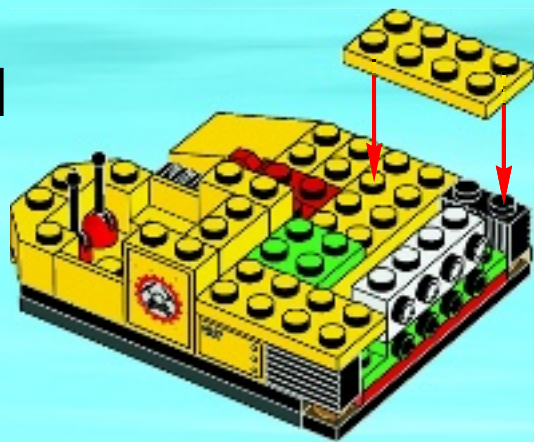



22

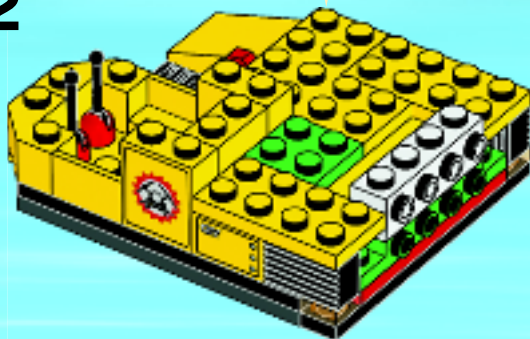

23

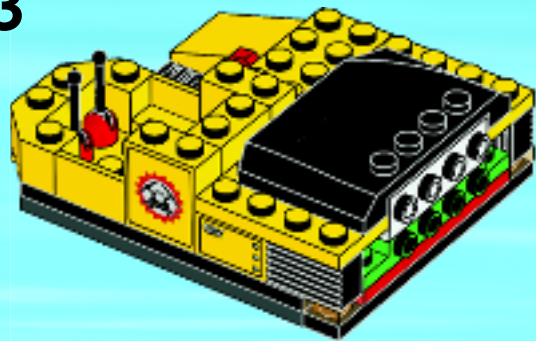

24

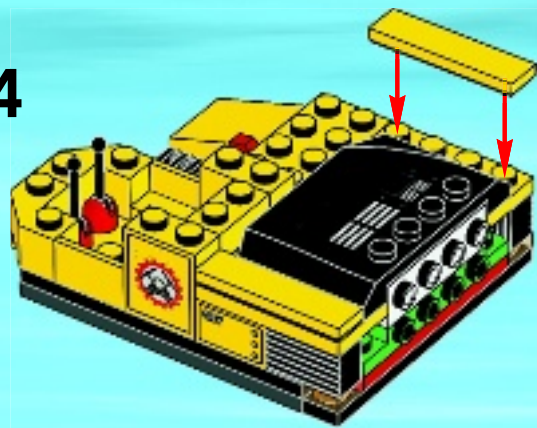



25

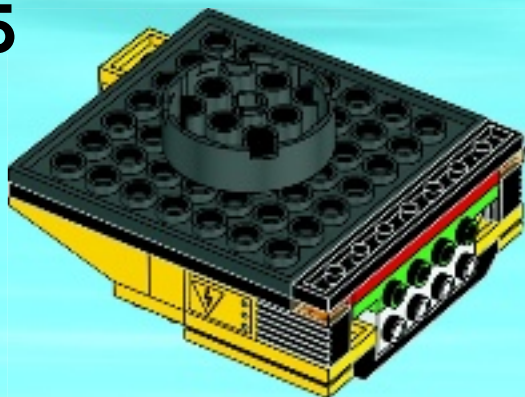

26

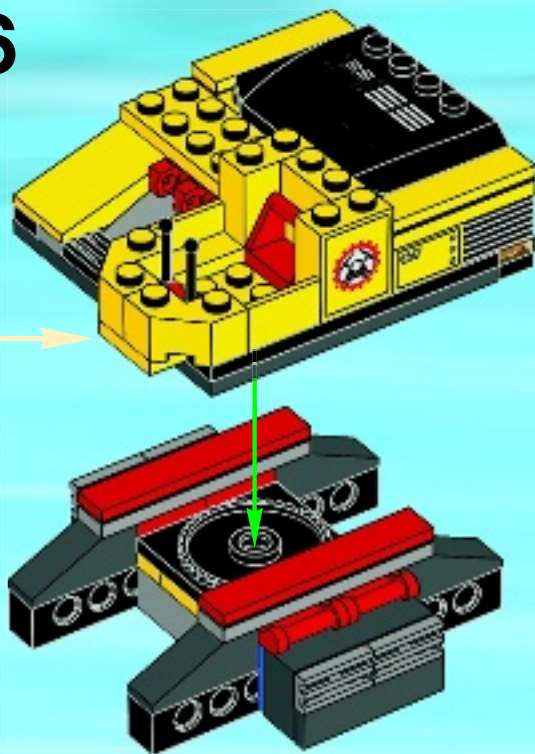



1

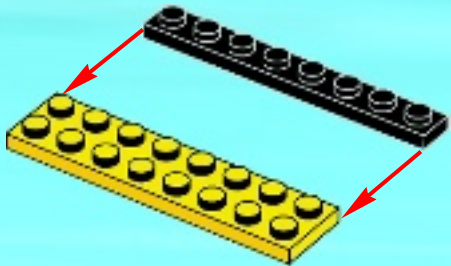

2

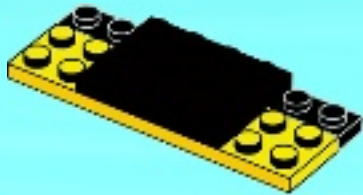

3

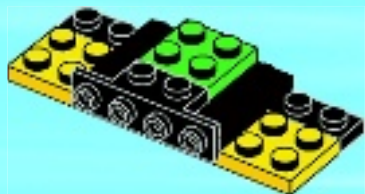

4

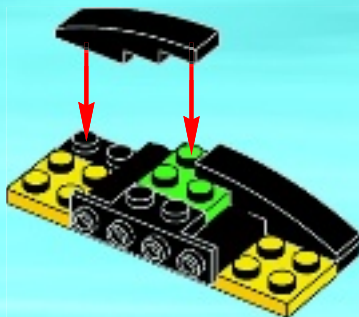

5

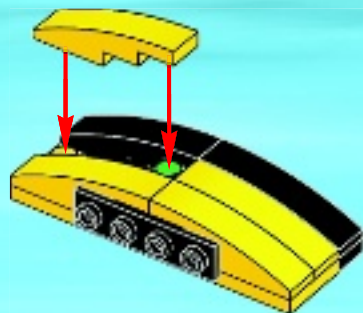

6

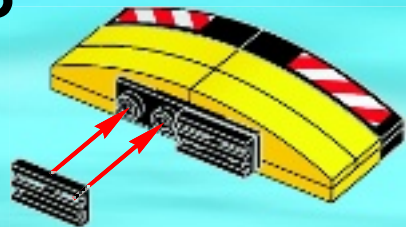

27

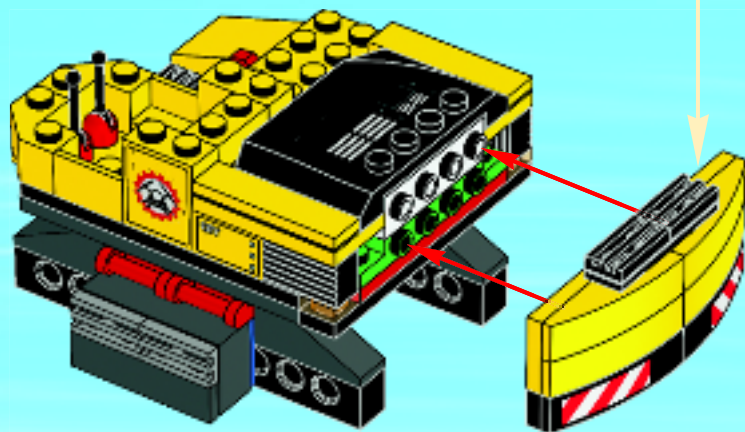



1

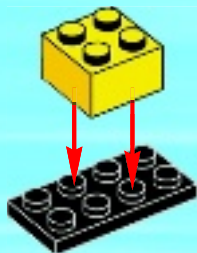

2

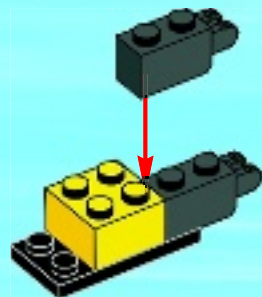

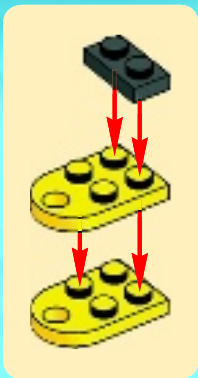

3

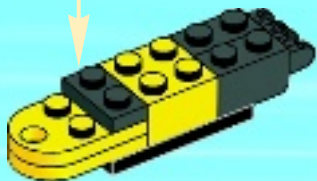

4



1

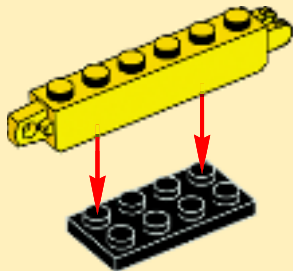

2

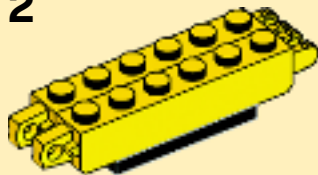

3

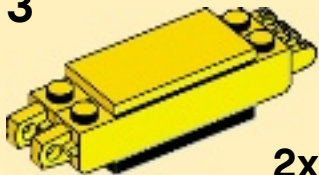

2x

5

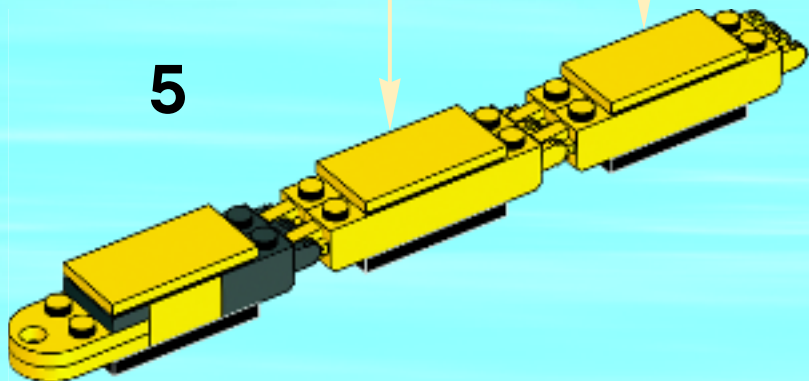

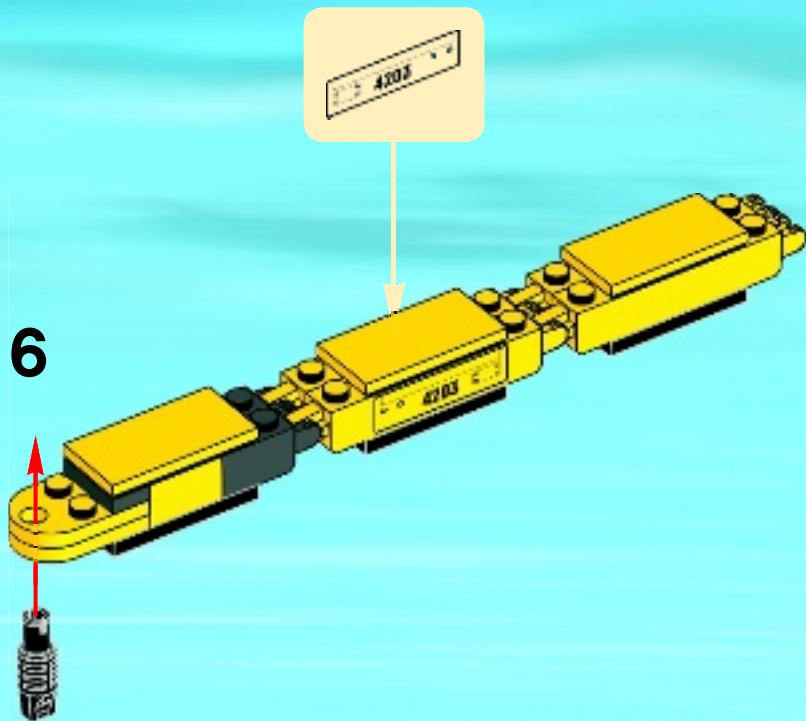

7

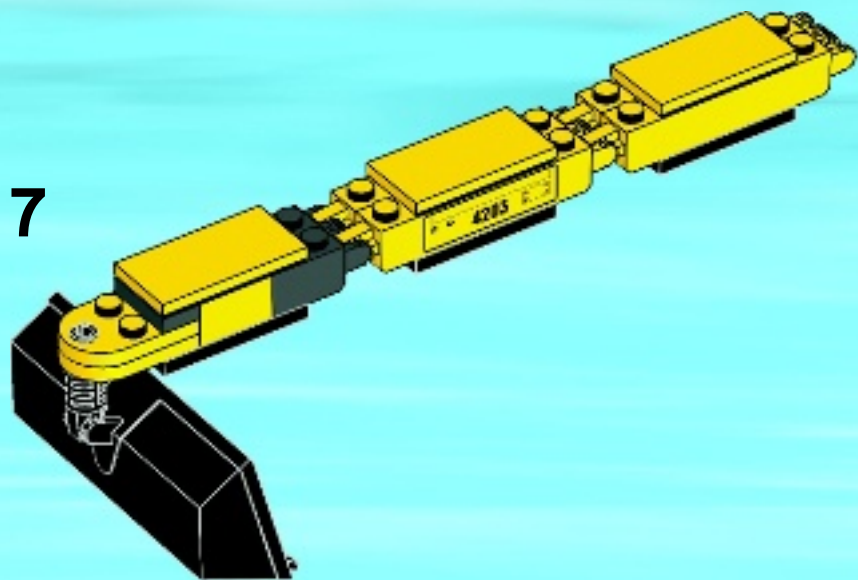

28

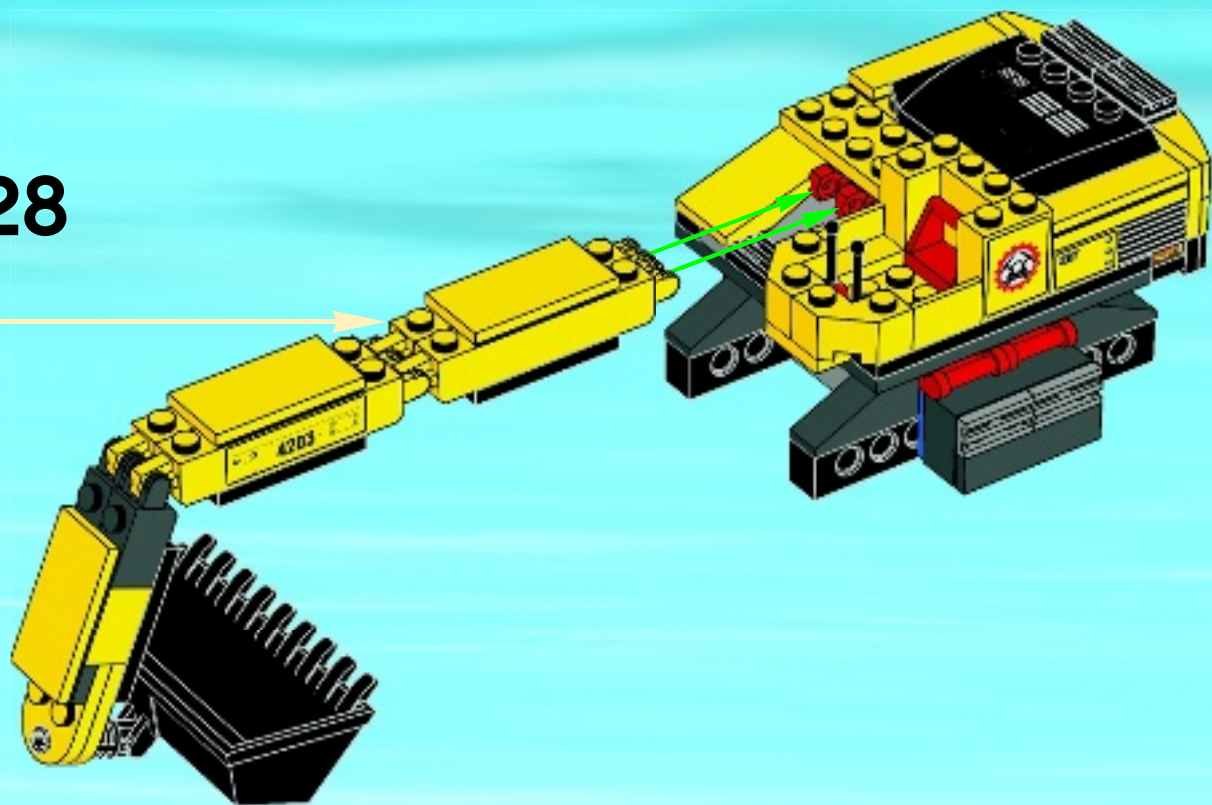

29

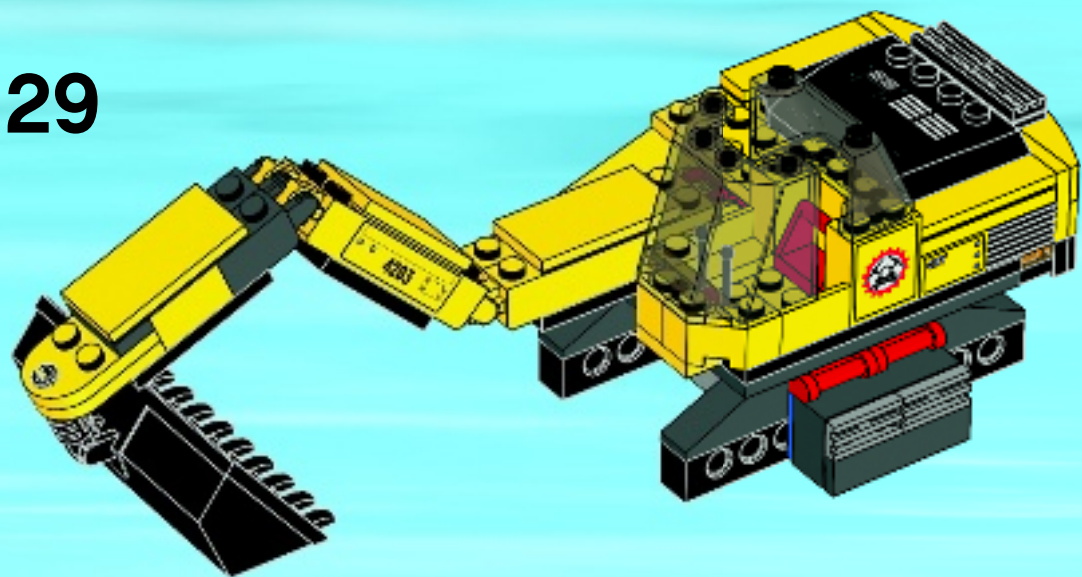

30

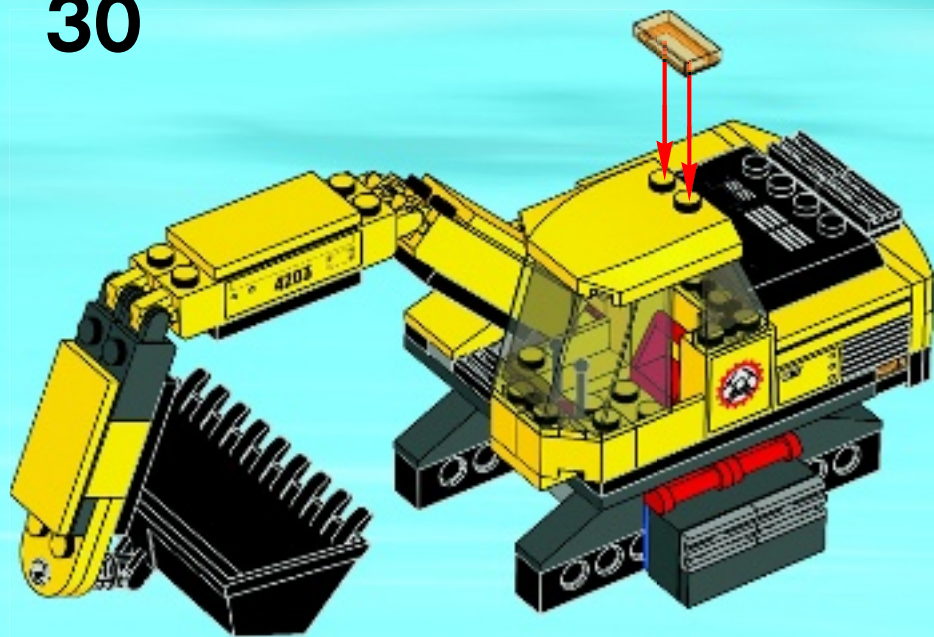

31

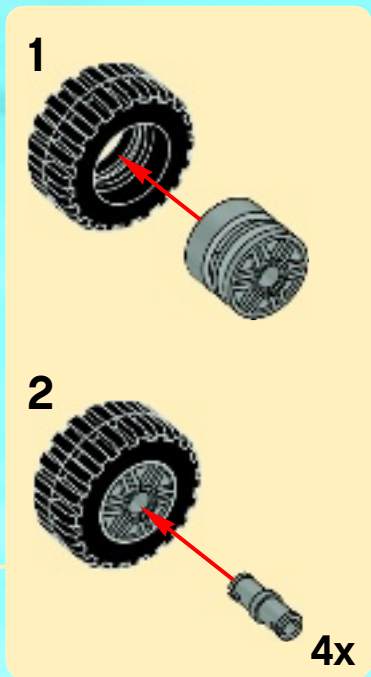
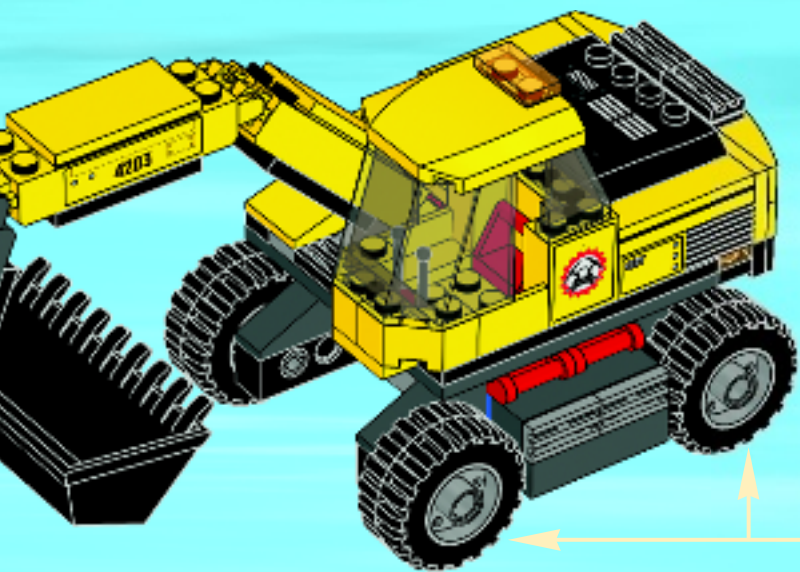

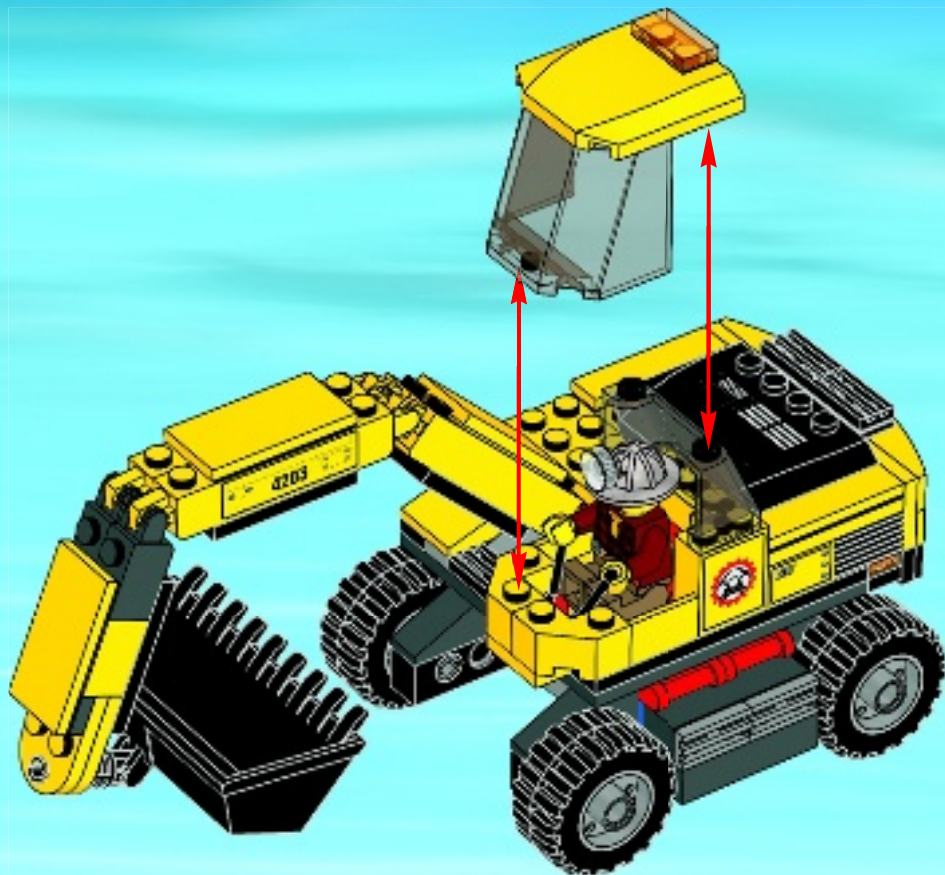



www.LEGOclub.com/Max

LEGO club™

FREE*! GRATIS! GRATUIT!

*Paid subscription in Australia and New Zealand.
*Abonnement payant en Australie et Nouvelle-Zélande.

©2012 The LEGO Group.





WIN!

Go to www.LEGOsurvey.com/product to fill out a survey for a chance to win a cool LEGO® Product.

No purchase necessary.

Open to all residents where not prohibited.



www.LEGOsurvey.com/product

GEWINNE!

Nimm an der Umfrage auf www.LEGOsurvey.com/product teil und hab die Chance ein cooles LEGO® Produkt zu gewinnen!

Die Teilnahme am Gewinnspiel führt zu keinerlei Kaufverpflichtungen. Teilnahme in allen nicht ausgeschlossenen Ländern möglich.

WIN!

Ga naar www.LEGOsurvey.com/product, vul een enquêteformulier in en maak kans op een cool LEGO® product.

Geen aankoopverplichting. Iedereen mag deelnemen, uitgezonderd ingezetenden van landen waar een enquêteverbod geldt.

GAGNE!

Visite www.LEGOsurvey.com/product pour répondre à un questionnaire et avoir une chance de gagner un produit LEGO® très cool!

Aucune obligation d'achat. Ouvert à tous les résidents des pays autorisés.

当てよう!

www.LEGOsurvey.com/product にアクセスして、アンケートにご記入ください。当選者にはレゴ®製品を差し上げます。

お買い上げの必要はありません。禁止されていない限り、すべての皆様にご利用いただけます。



www.LEGO.com

6012713

LEGO and the LEGO logo are trademarks of the LEGO Group. ©2012 The LEGO Group.