



# Friends

42603



# 2

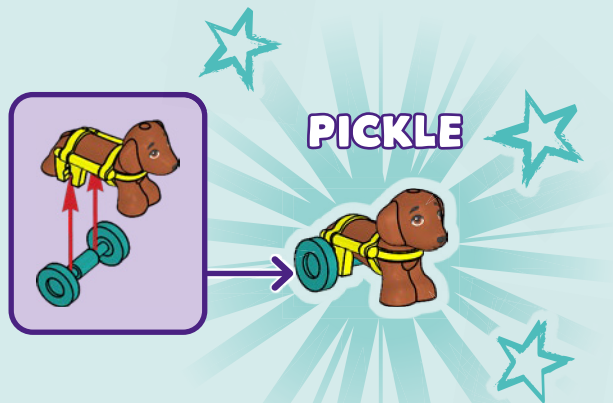

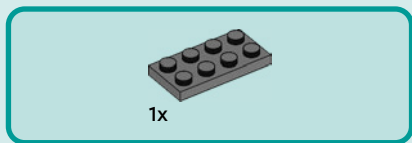
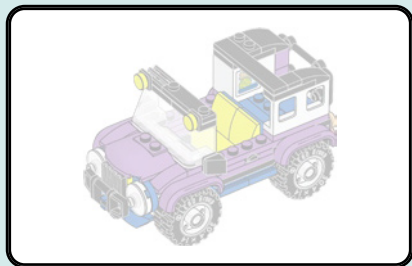

1

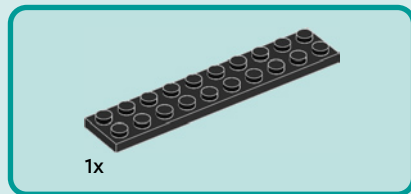
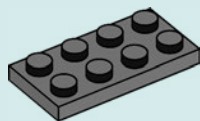

2

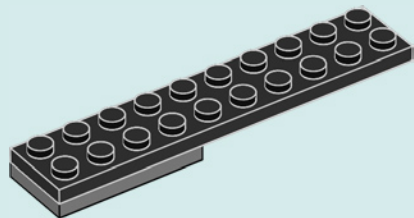



1x

3

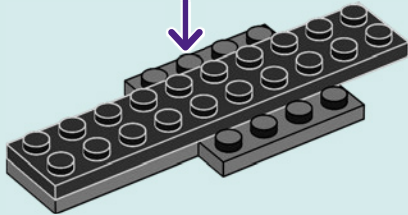
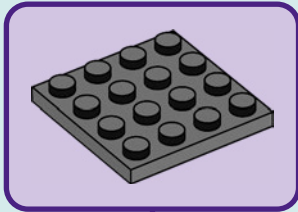

2x

4

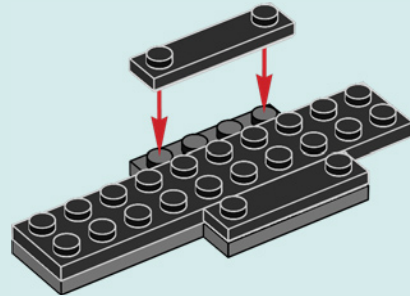

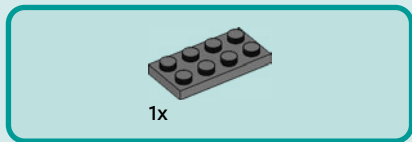

5

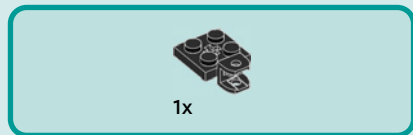
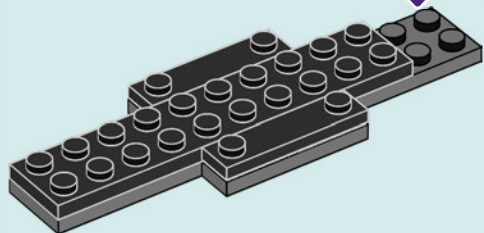
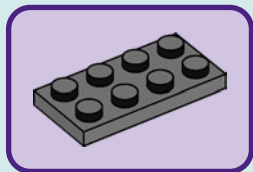

6

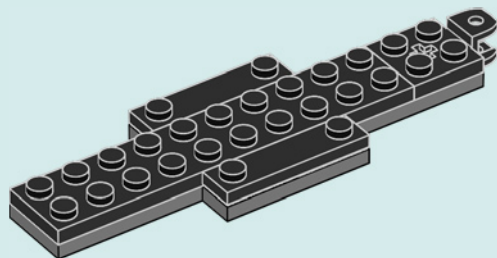



1x

7

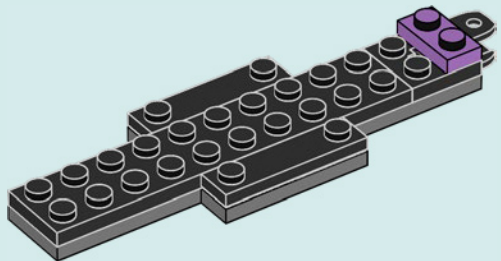

1x



1x

8

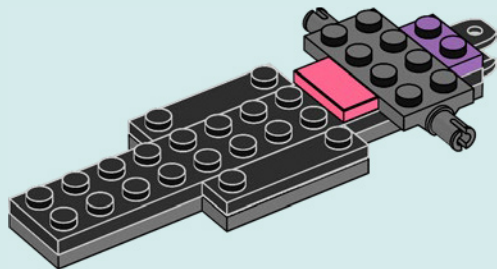

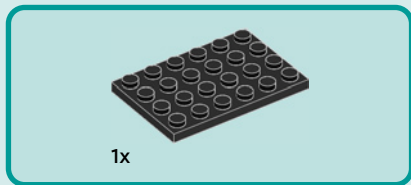

9

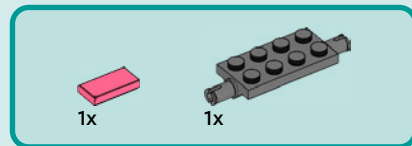
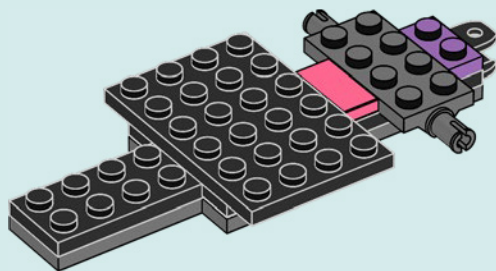

10

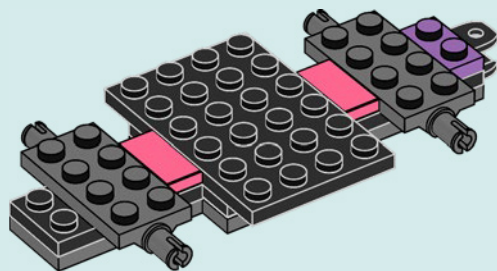

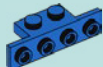

1x

11

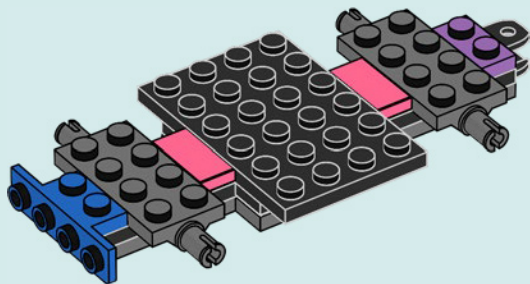

2x

12

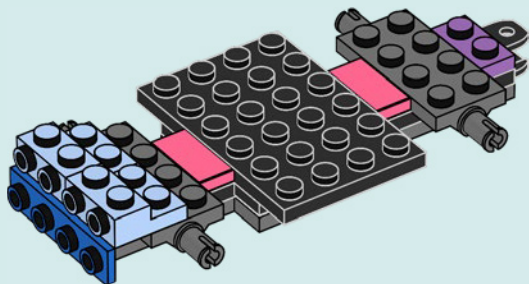



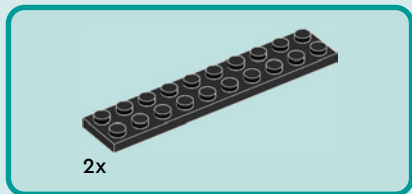

13

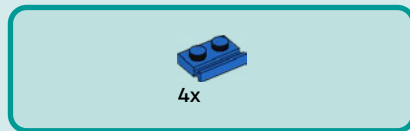
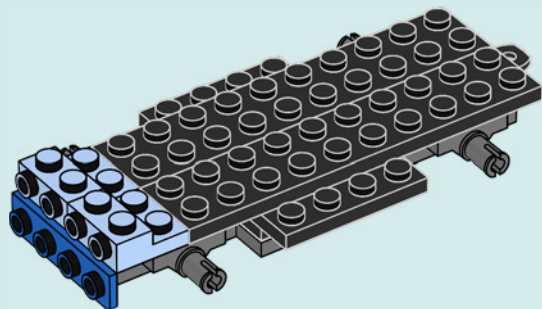

14

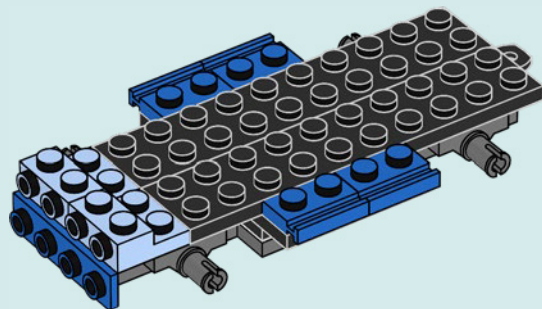



1x



1x

15

1

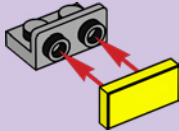

2

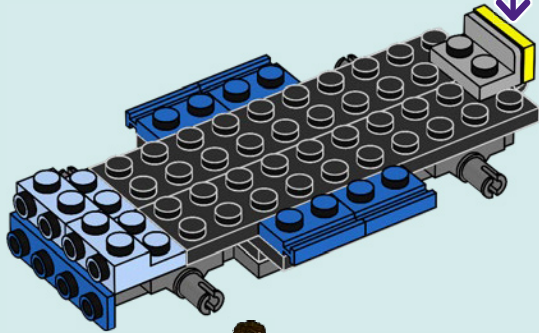

2x

16

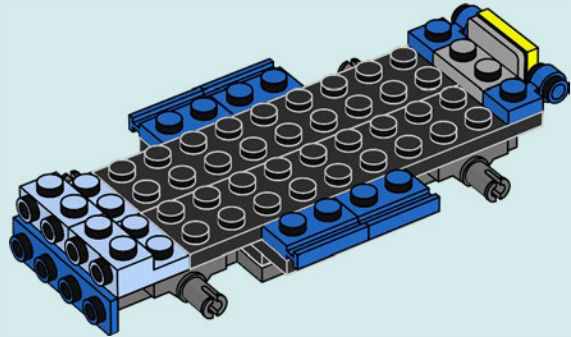



1x

17

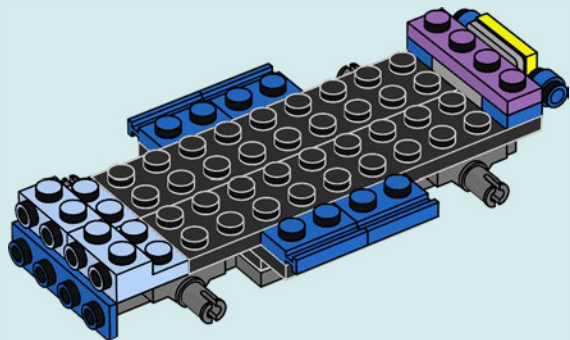

1x

18

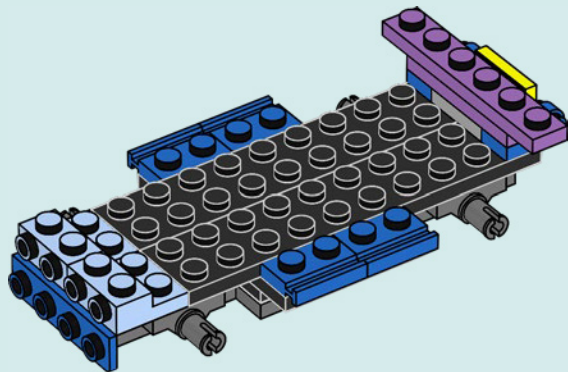

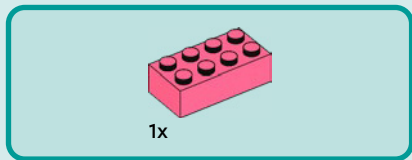

19

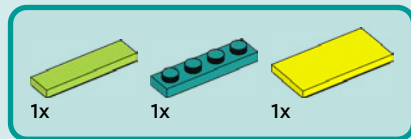
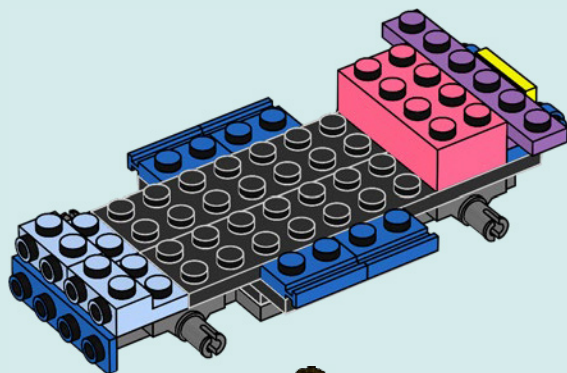

20

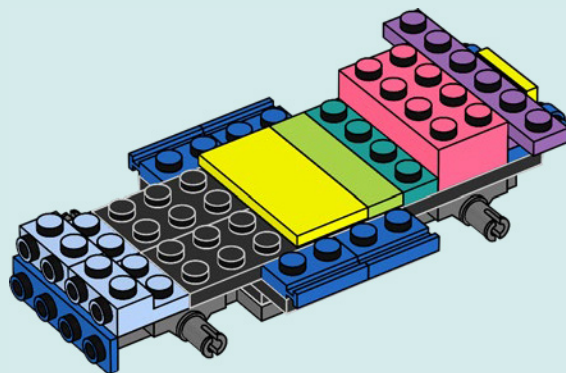

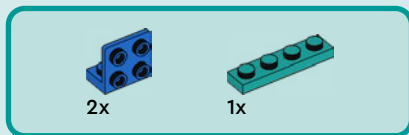

21

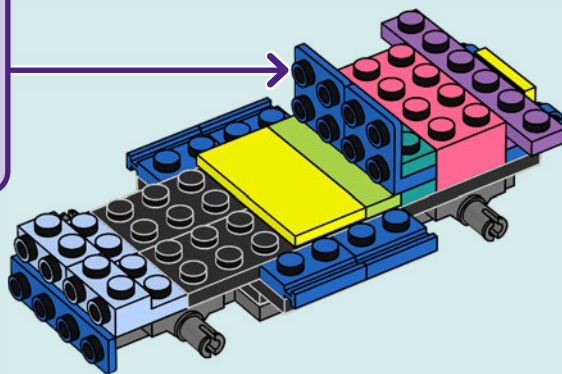
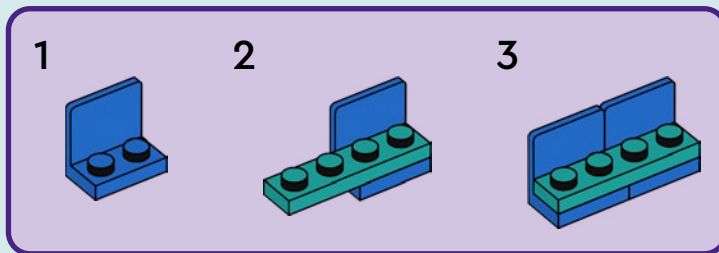

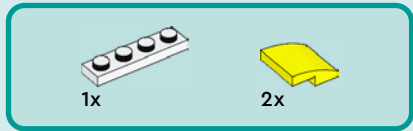

22

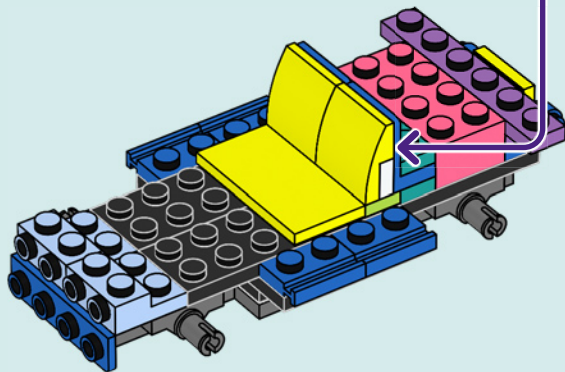
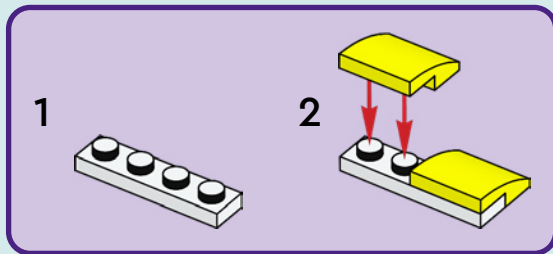



2x

23

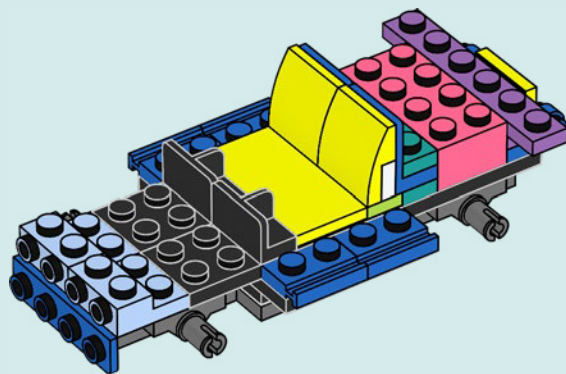



1x



1x

# 24

1

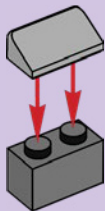

2

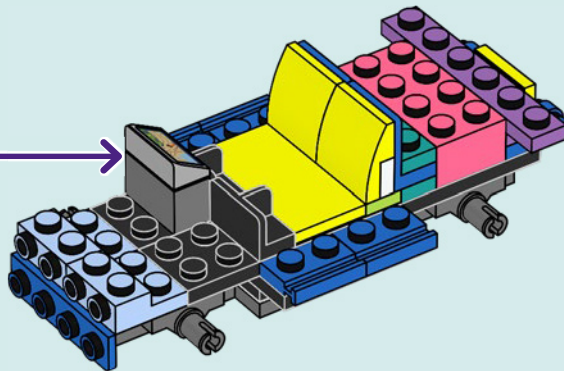





1x

25

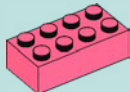
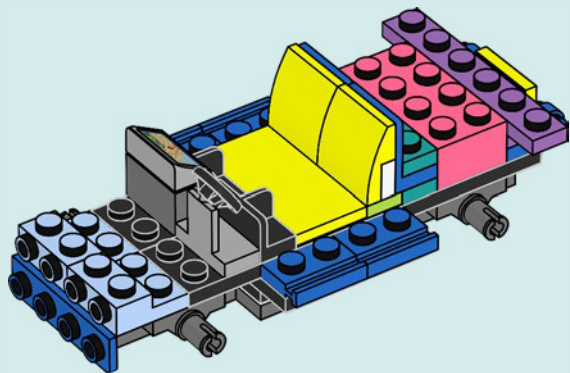

1x

26

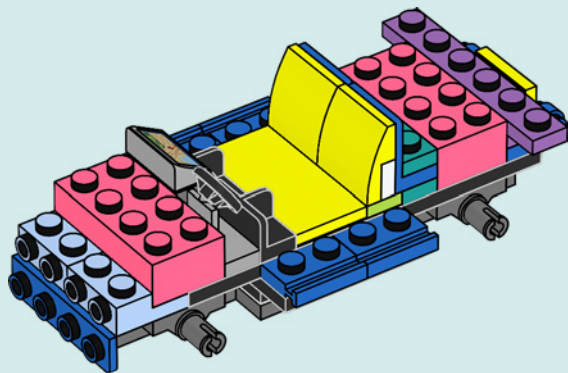

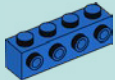

1x

27

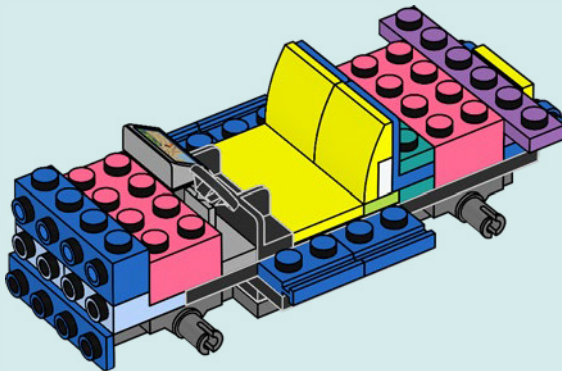

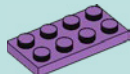

1x



2x

28

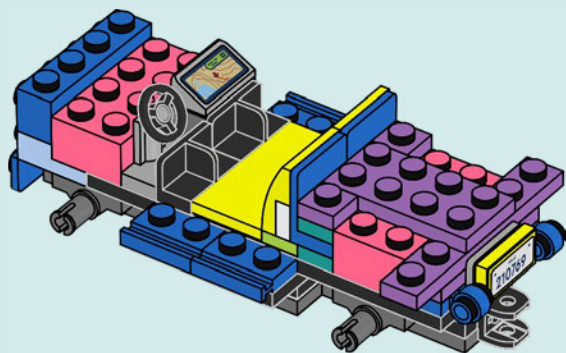

2x

29

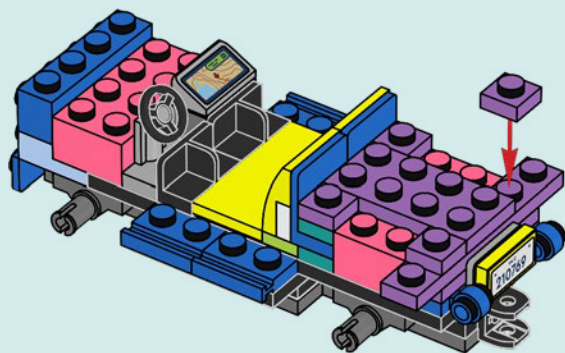

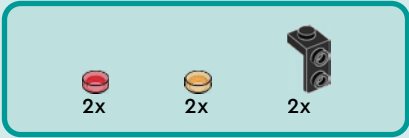

30

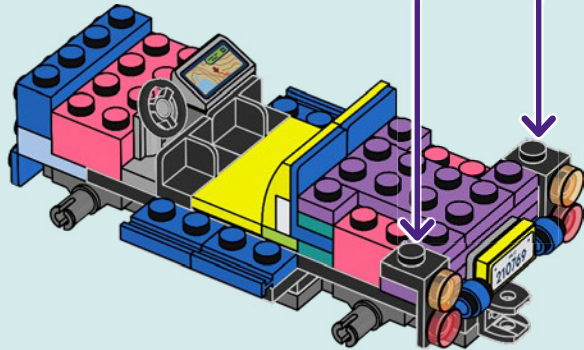
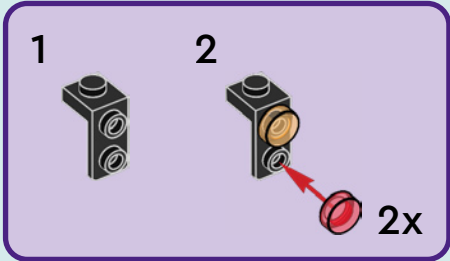

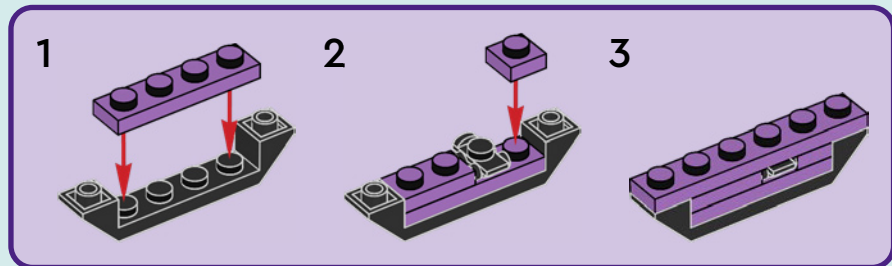
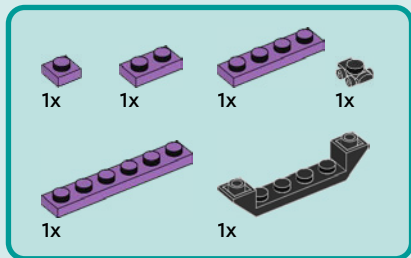

31

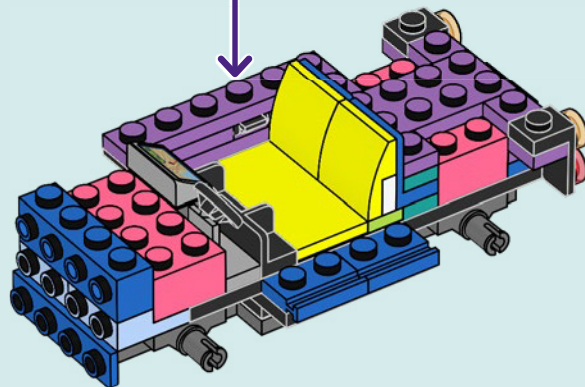

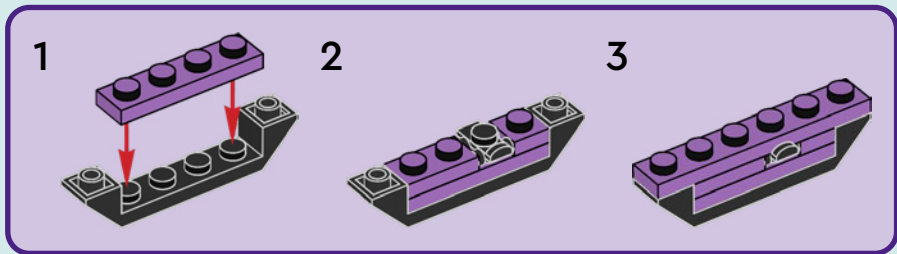
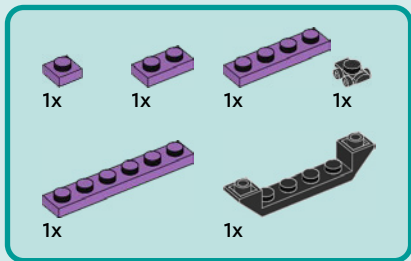

32

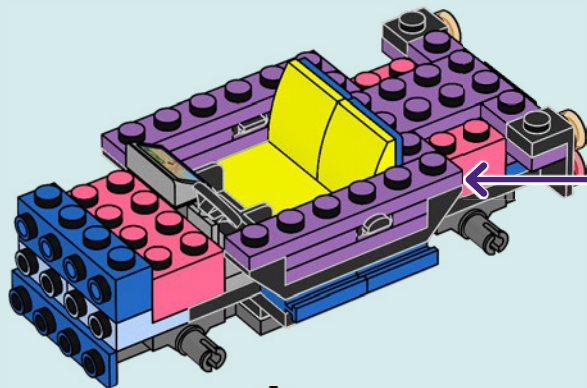



2x

33

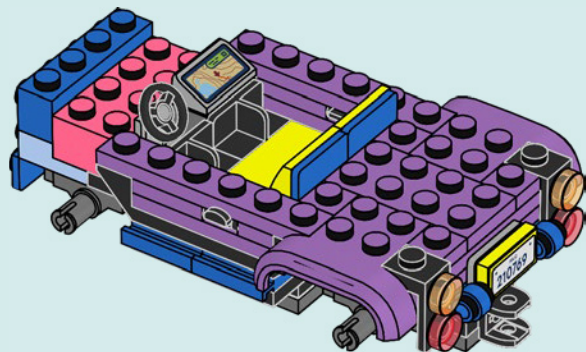

1x

34

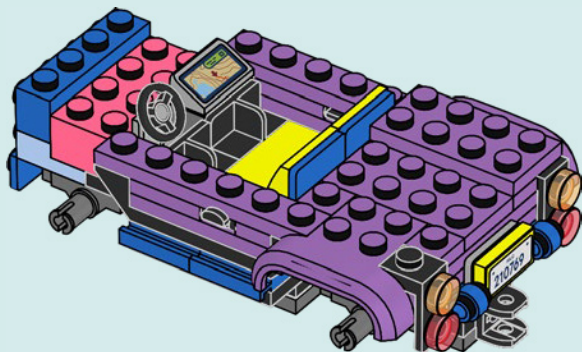

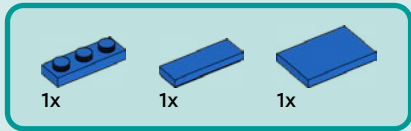

35

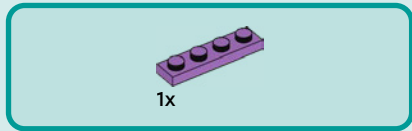
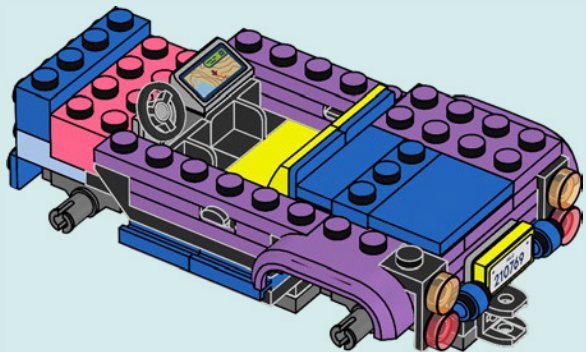

36

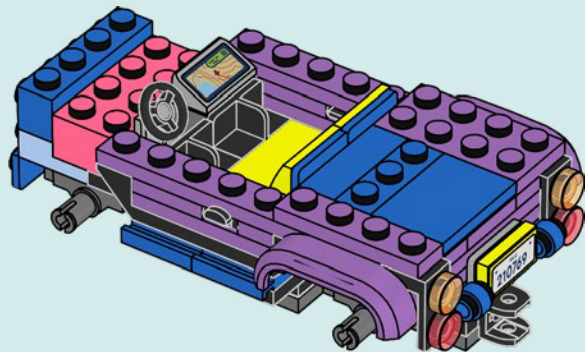



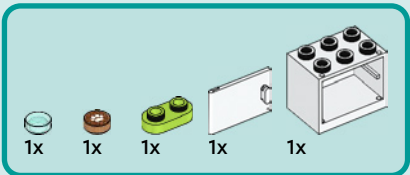

37

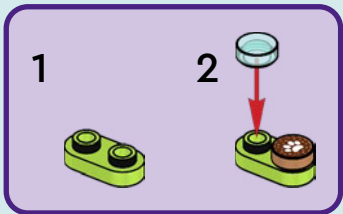

1

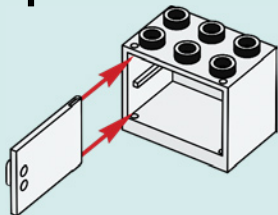

2



3



4





2x



# 38

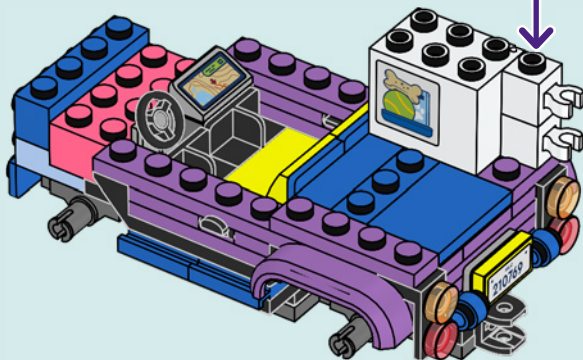
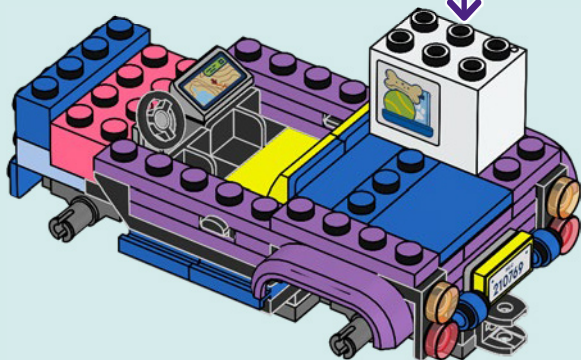



2x

39

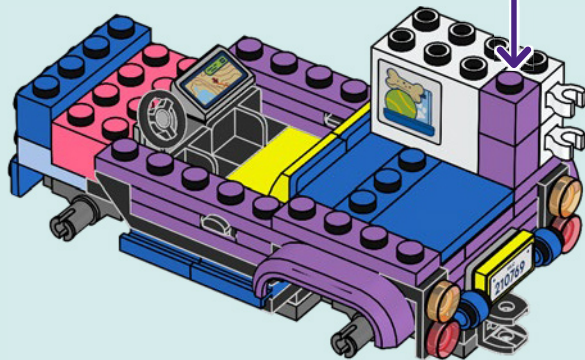
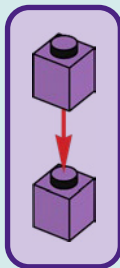



1x

40

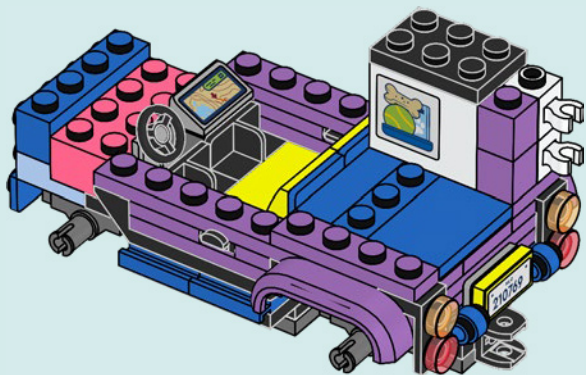

1x



1x

41

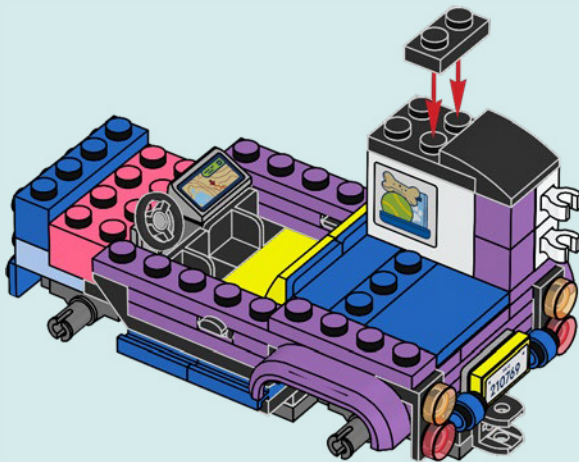

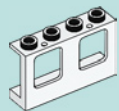

1x

42

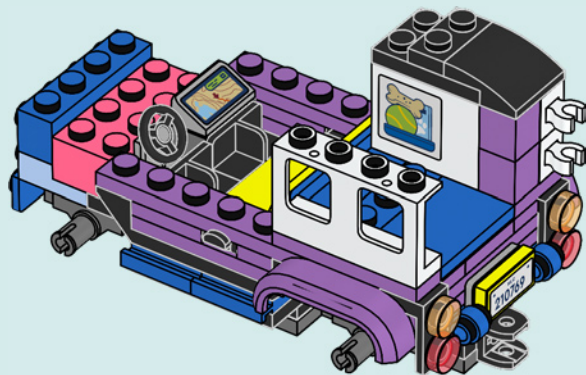

1x

43

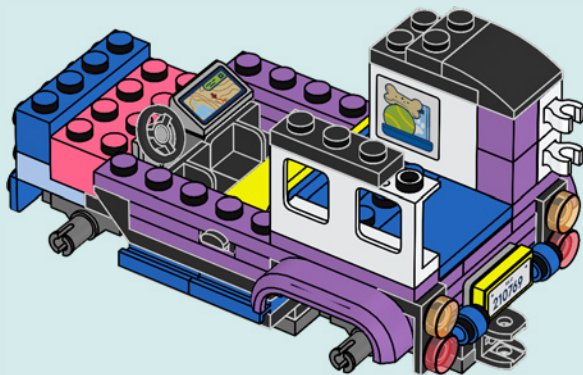



1x



1x

# 44

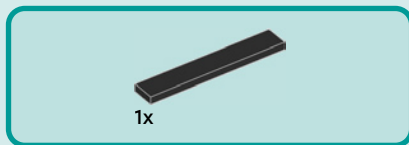
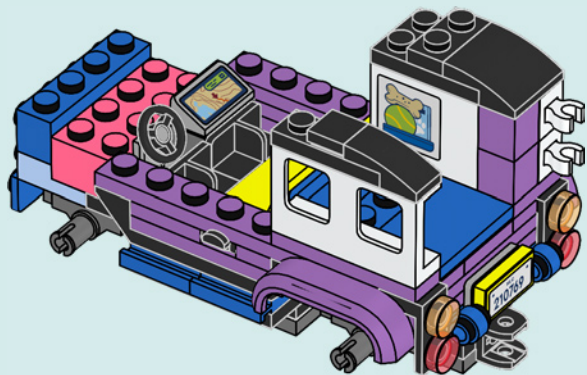

1x

# 45

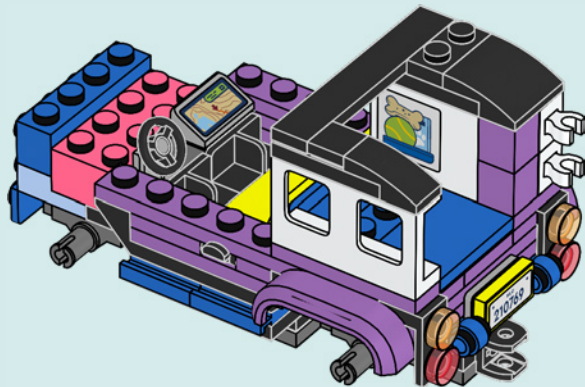



1x

46

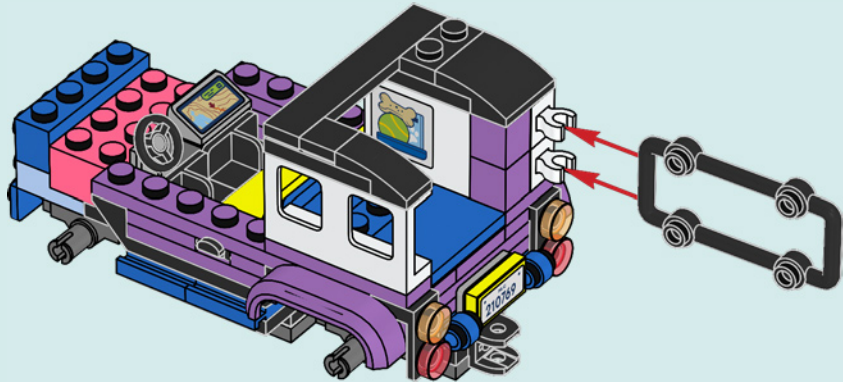



1x

47

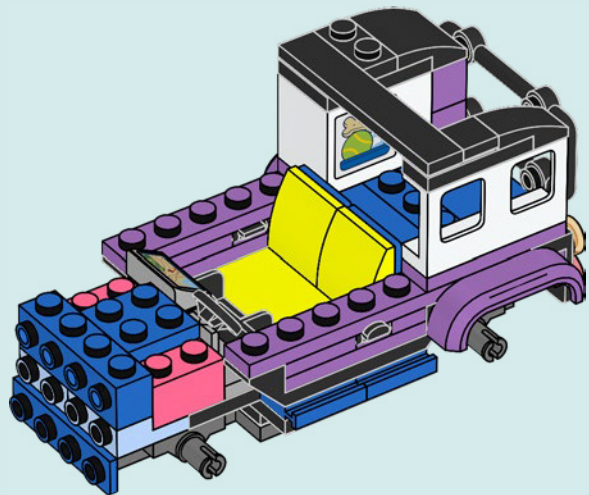

32



2x

48

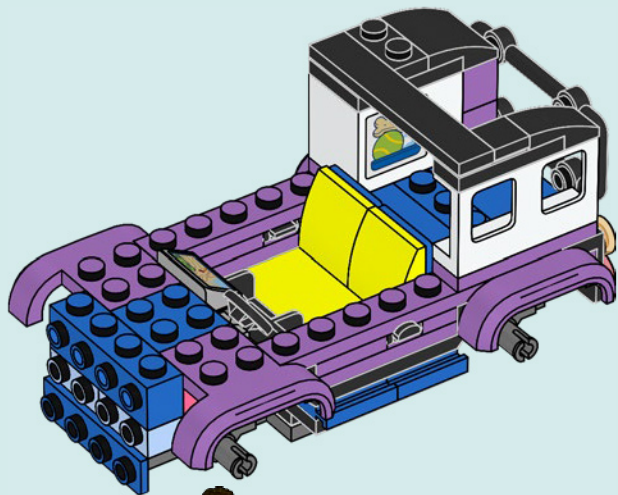



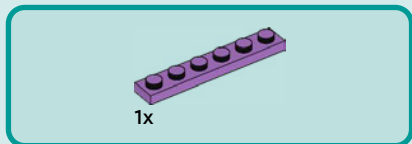

49

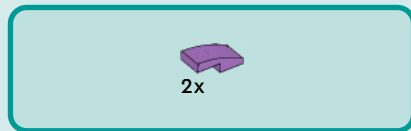
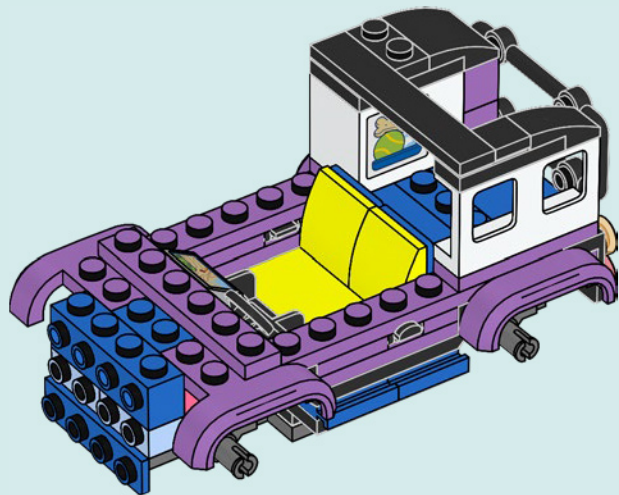

50

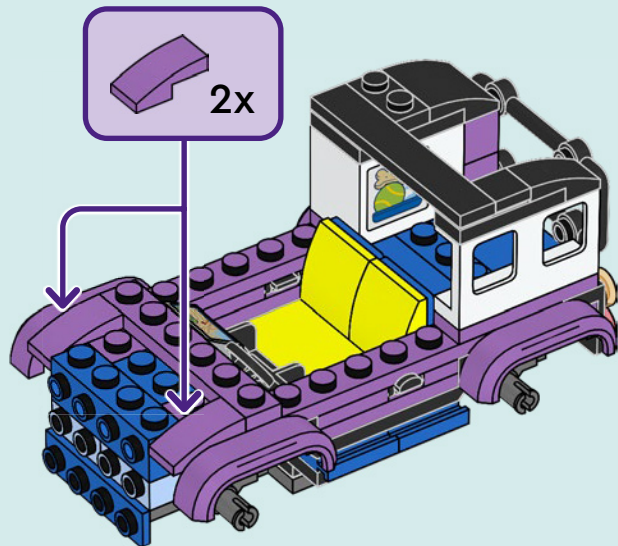

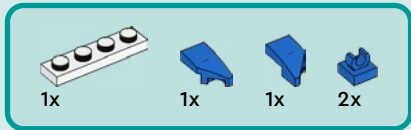

# 51

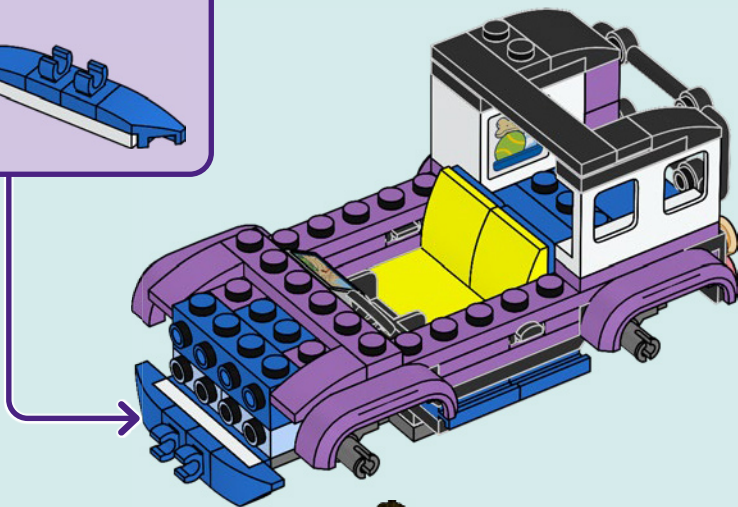
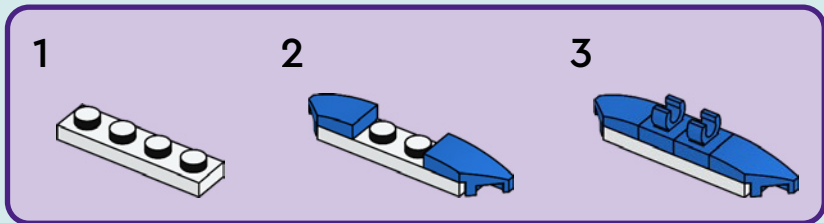



52

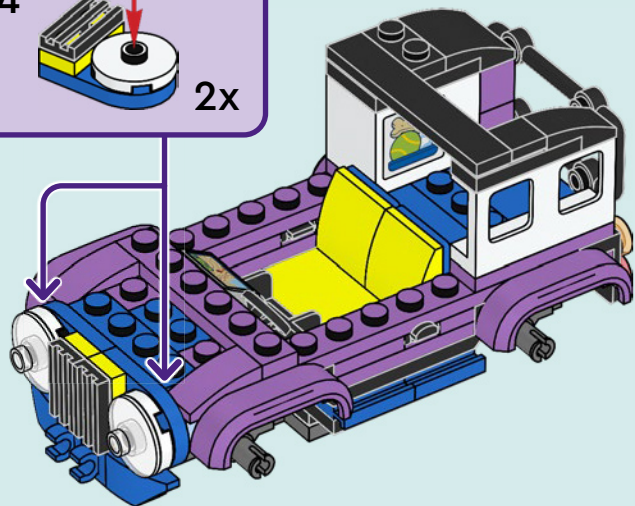
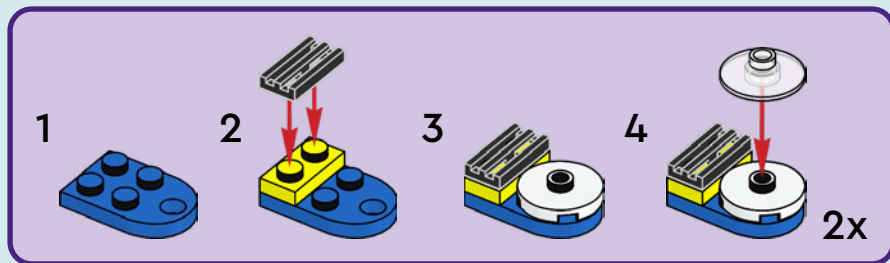



1x

53

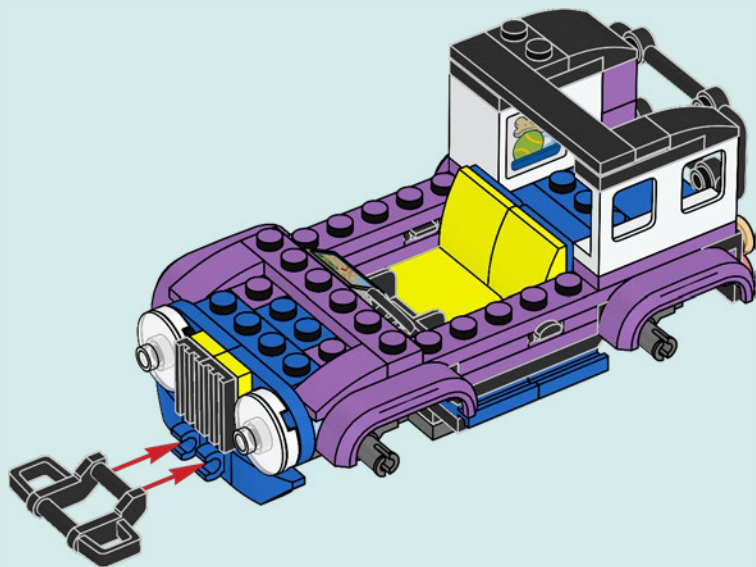

54

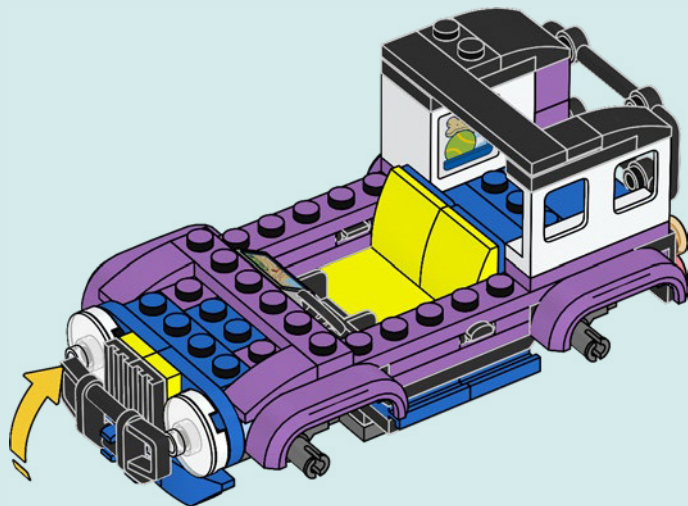

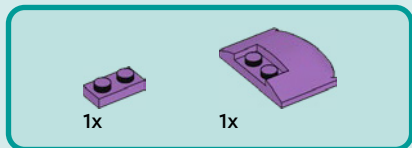

55

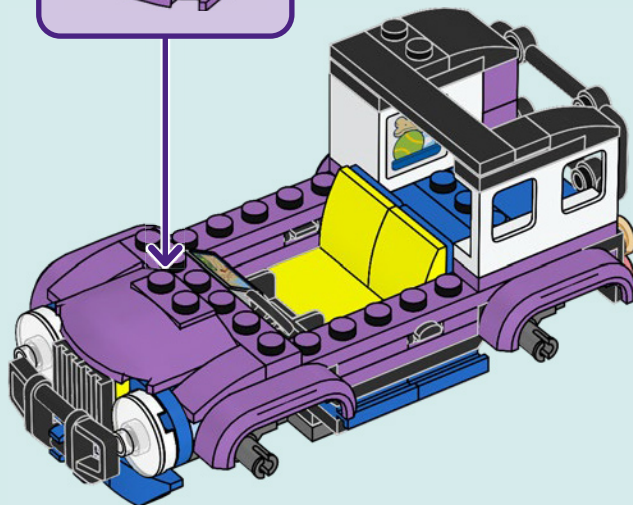
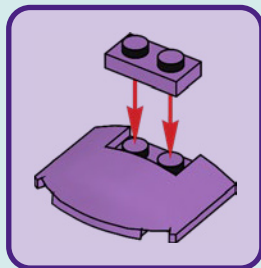



2x



2x

# 56

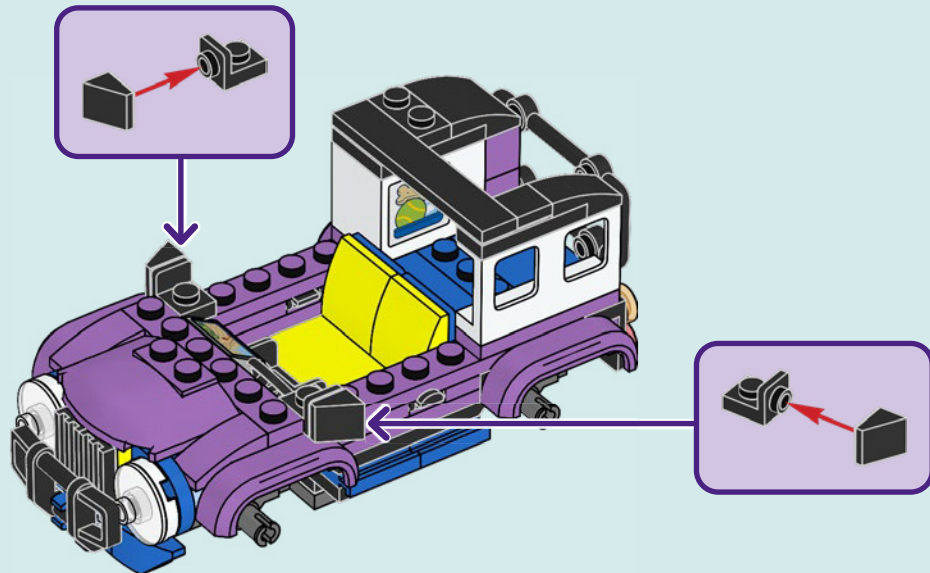

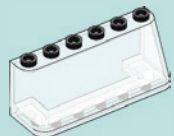

1x

57

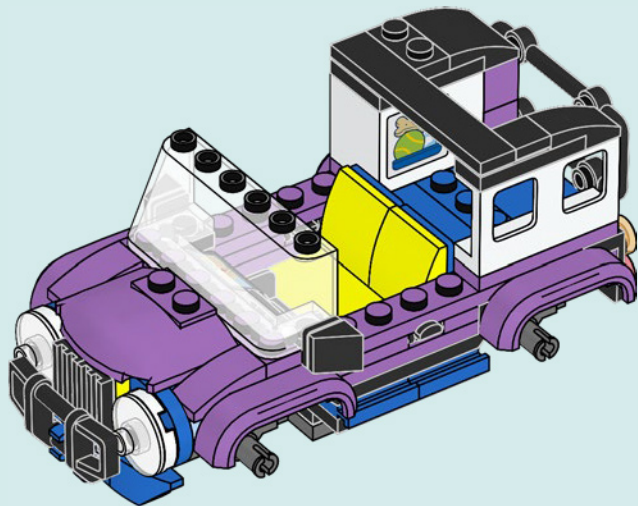

2x

58

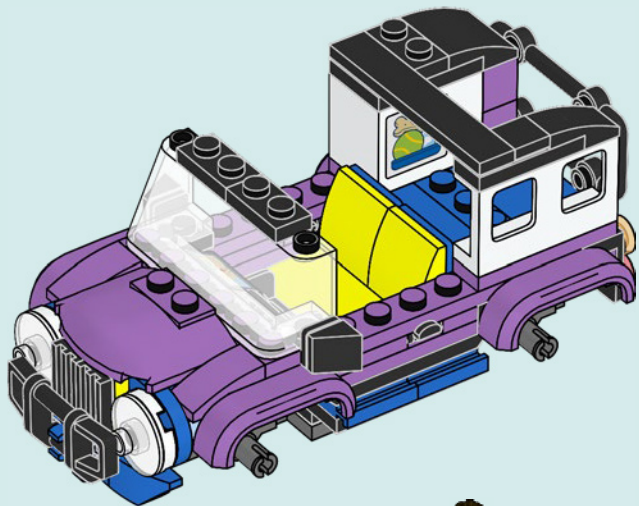





2x



2x

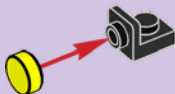

2x

59

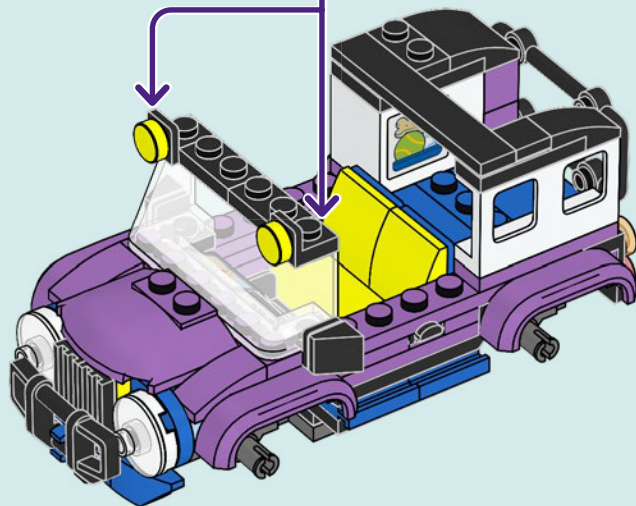



1x



1x

60

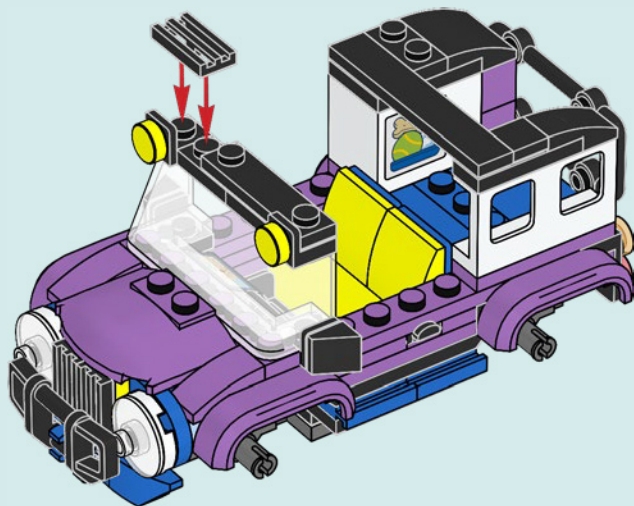

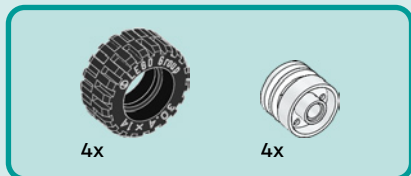

61

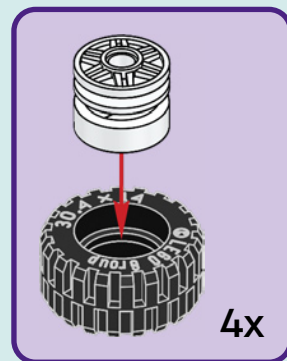
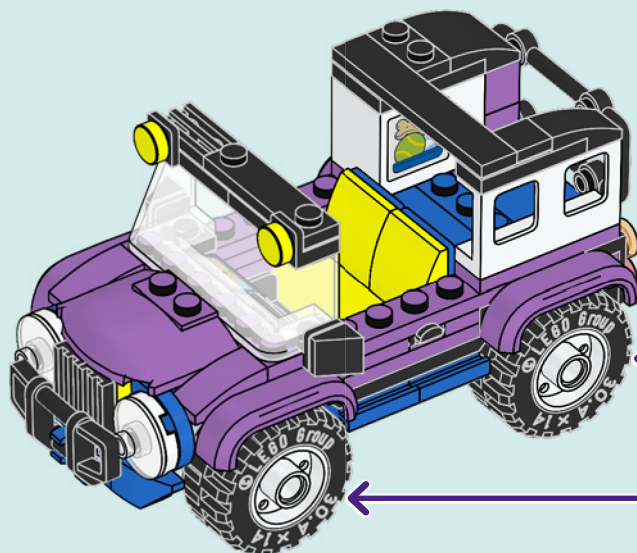

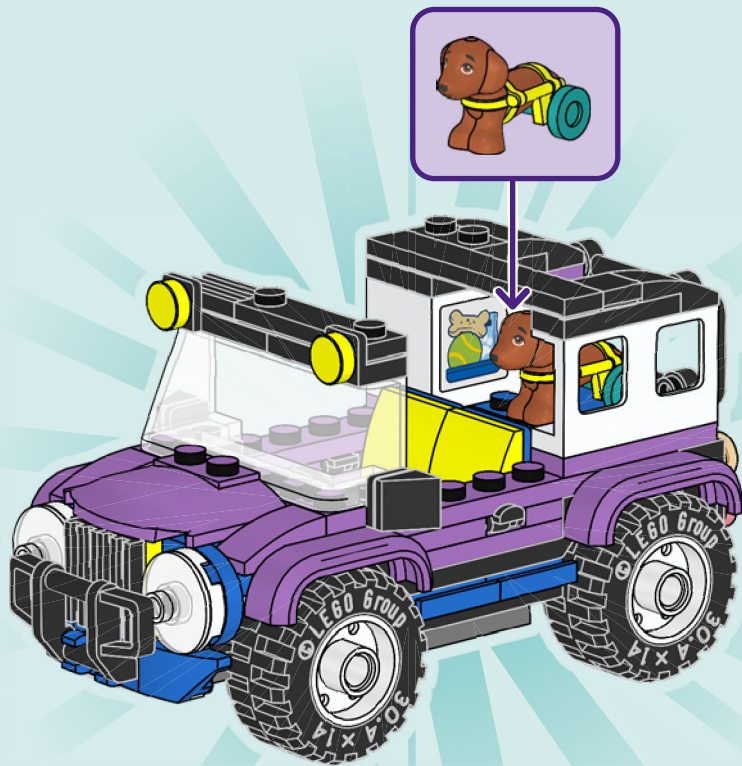

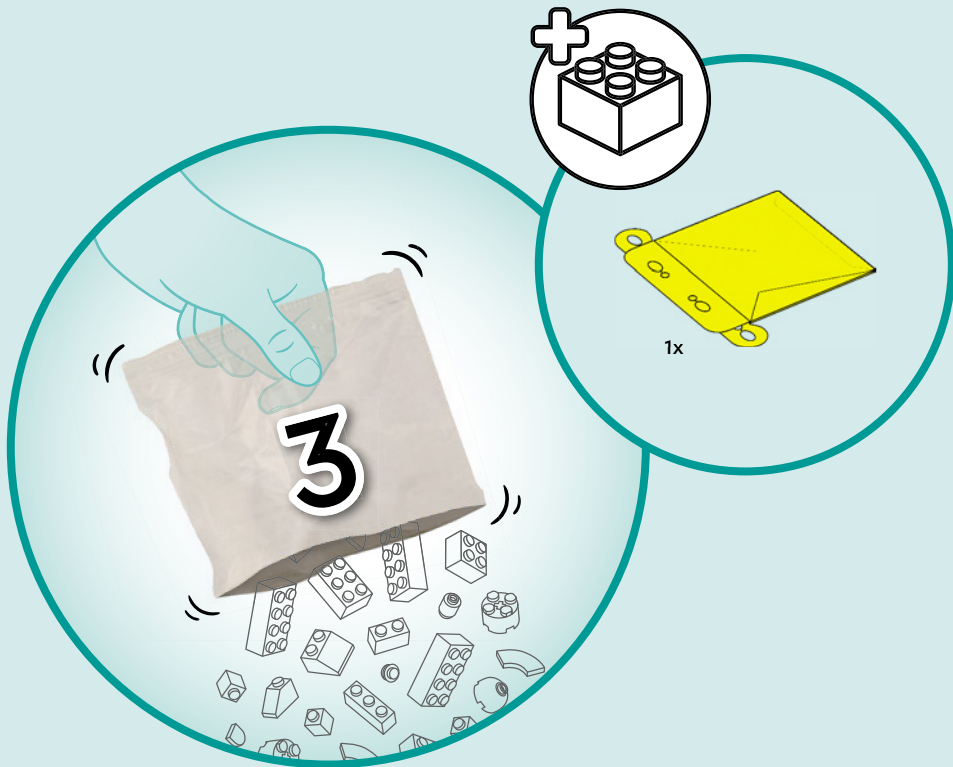

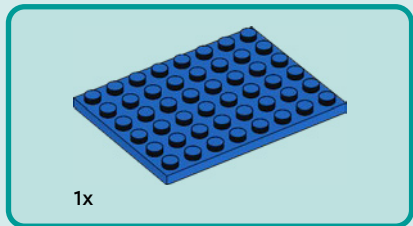
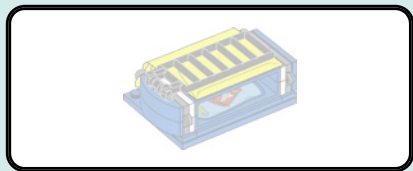

62

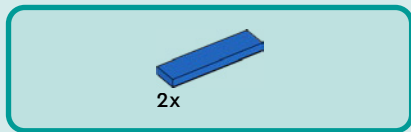
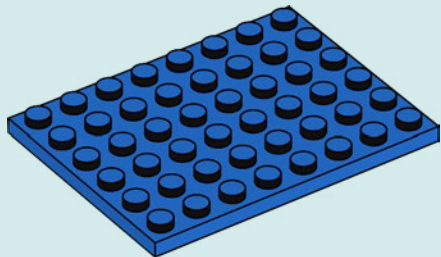

63

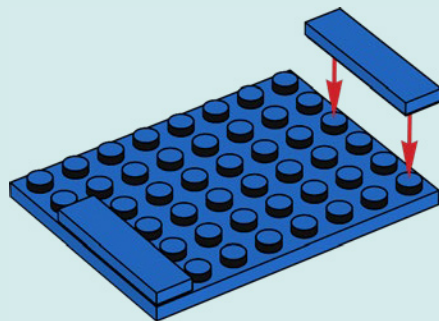

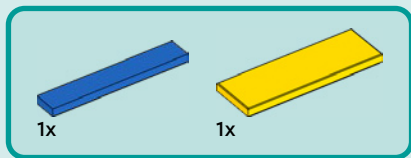

64

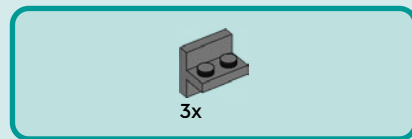
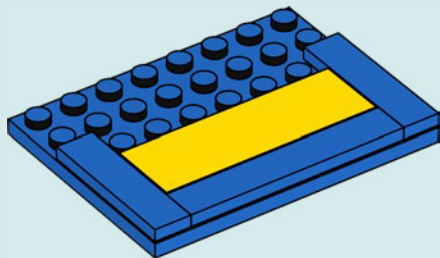

65

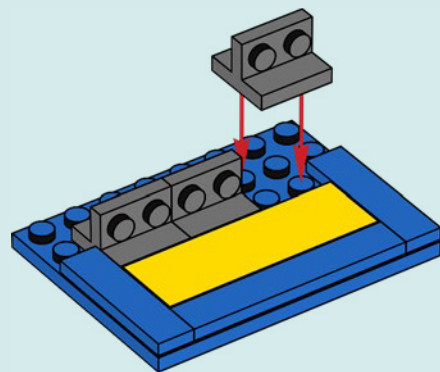

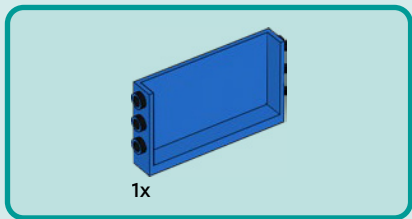

66

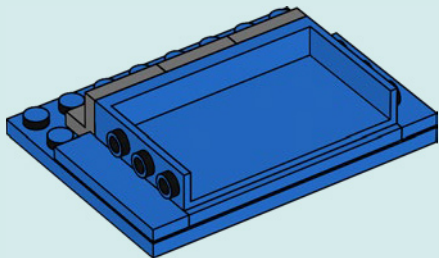

67

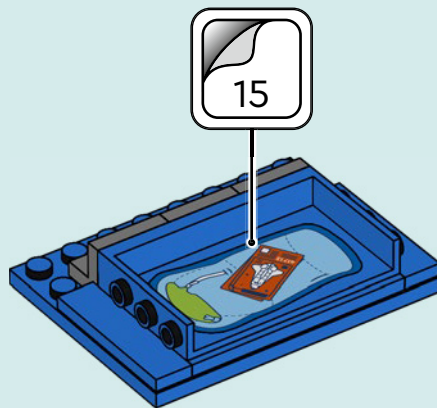



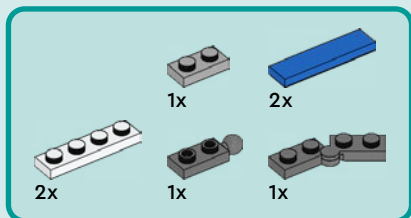
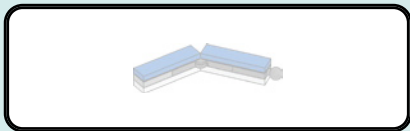

68

1

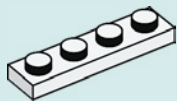

2

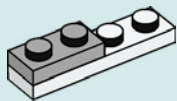

3

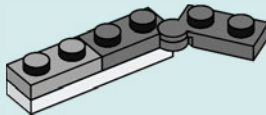

4

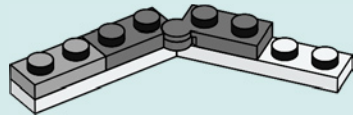

5

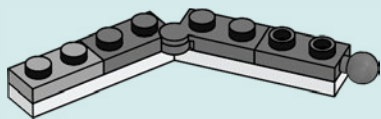

6

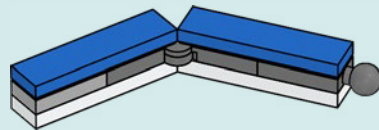

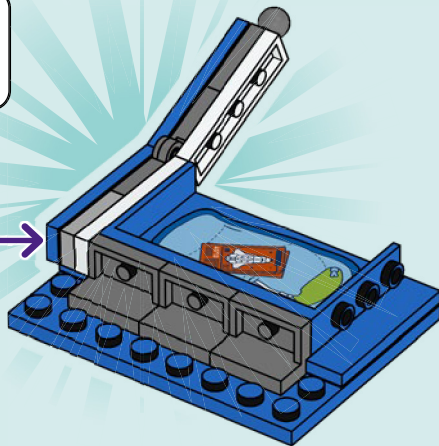
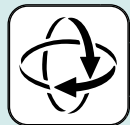

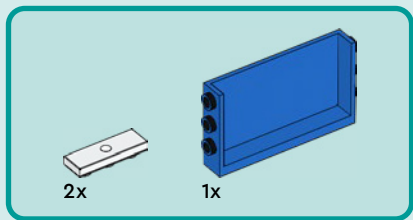

69

1

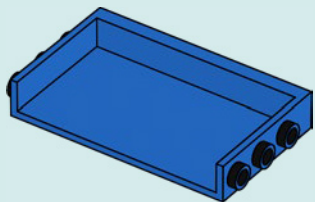

2

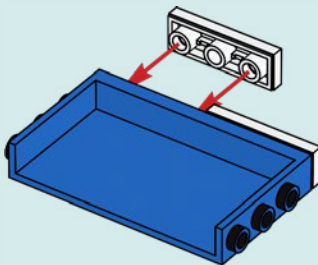

3

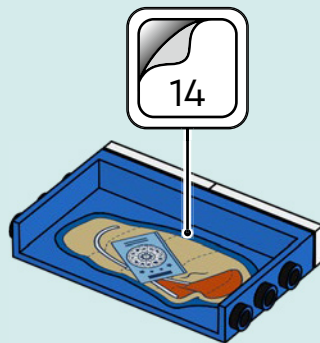

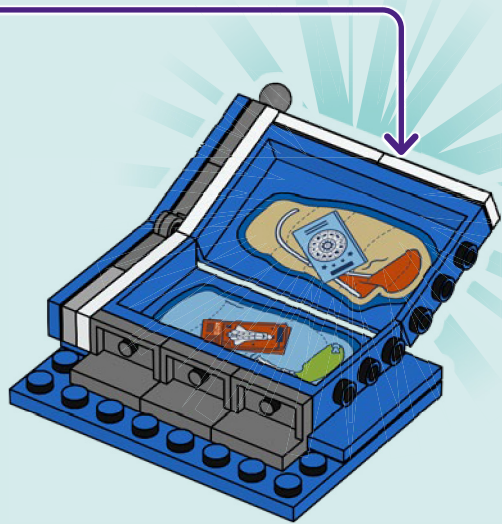

70

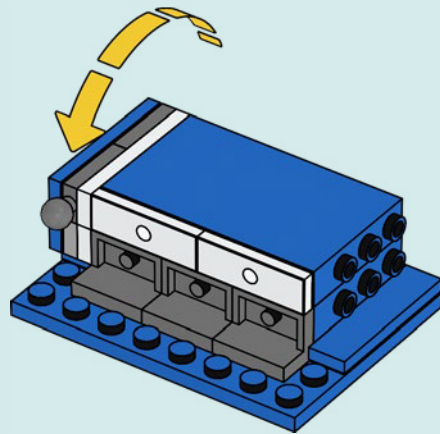

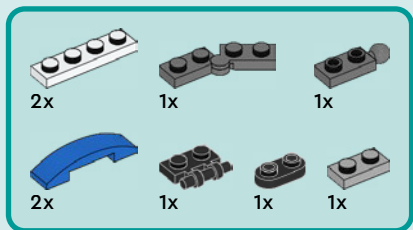

71

1

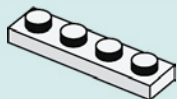

2

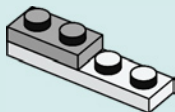

3

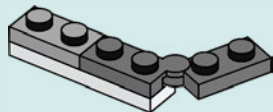

4

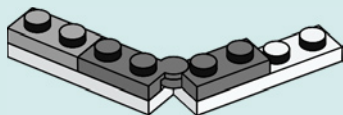

5

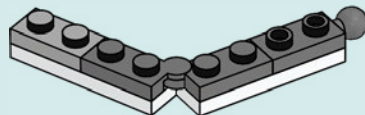

6

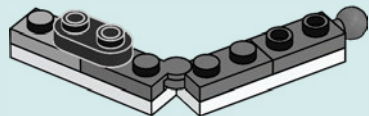

7

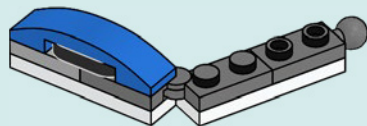



8

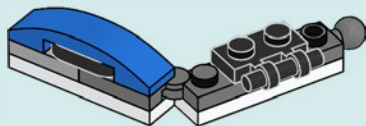

9

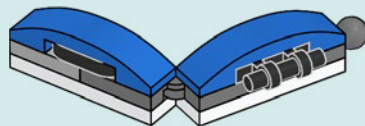

10

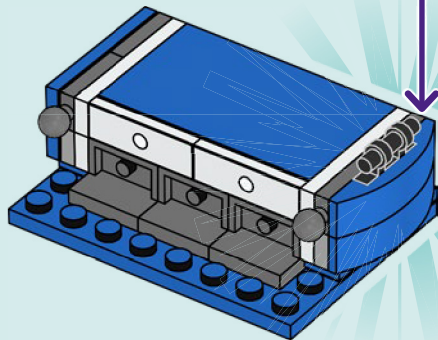
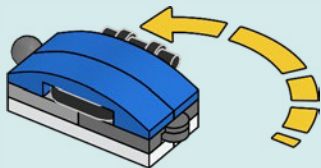

72

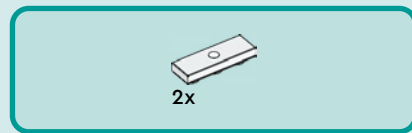
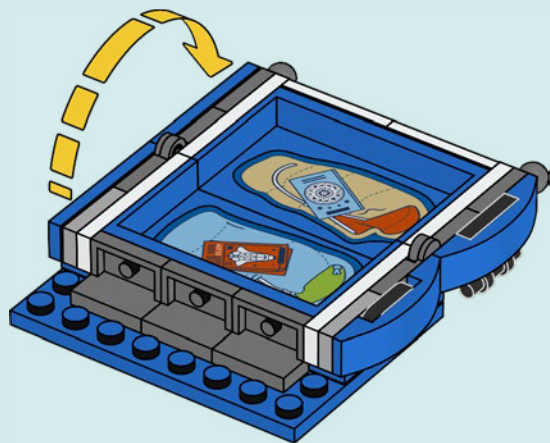

73

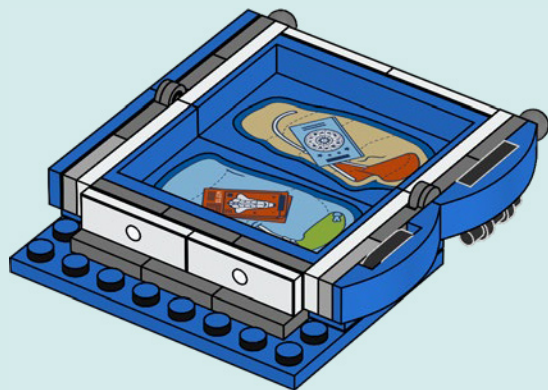



2x

74



75

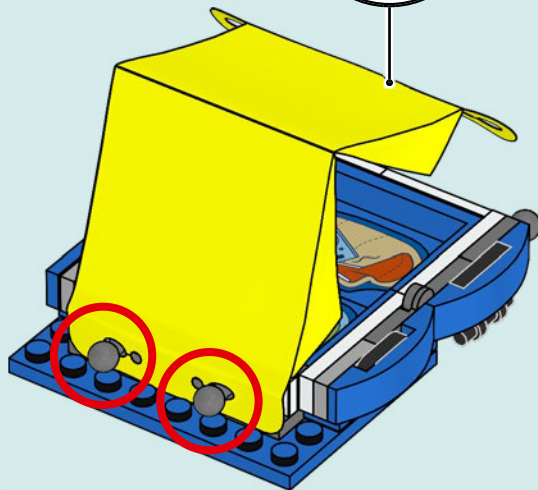
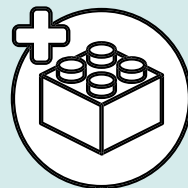

76

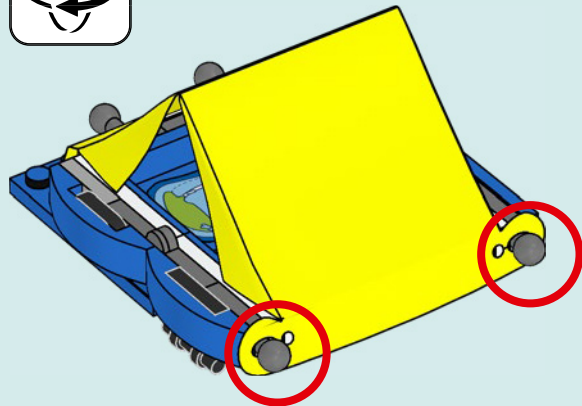

77

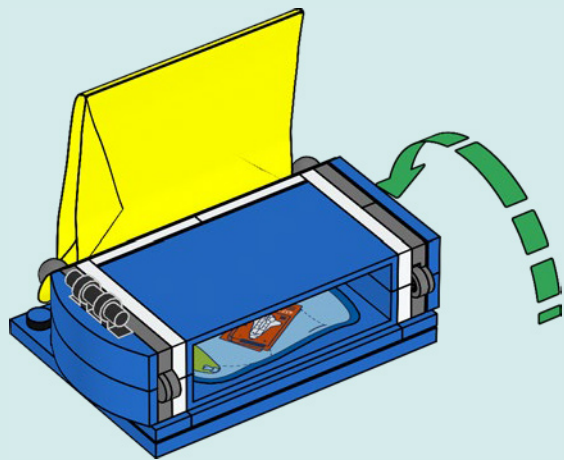

78

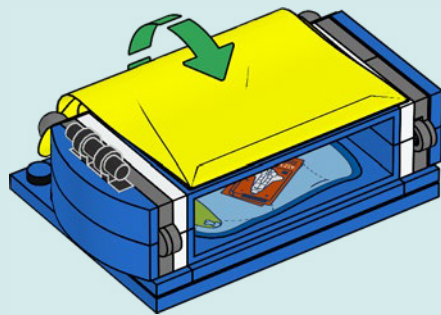

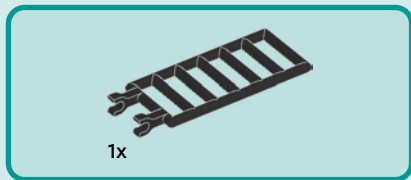

79

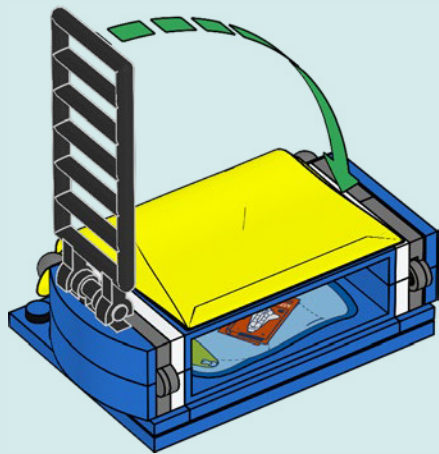

80

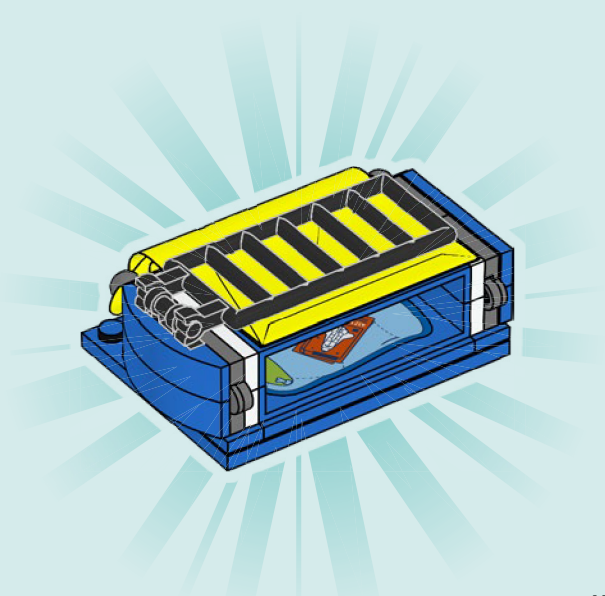

81

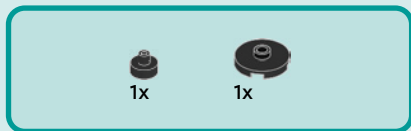
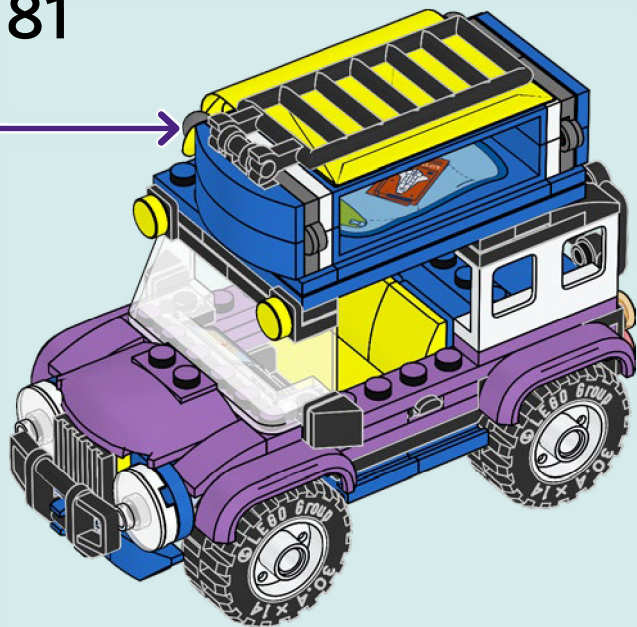

82







1x

83



1x

84





85

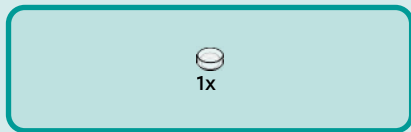
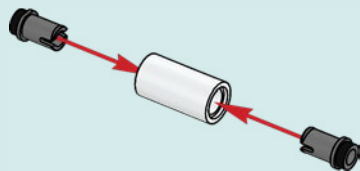

86

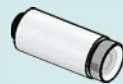



1x



1x

87

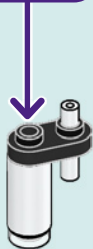
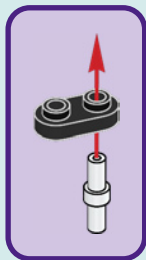

1x

88

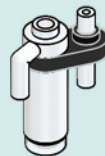



1x

89

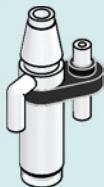

1x

90





91



92

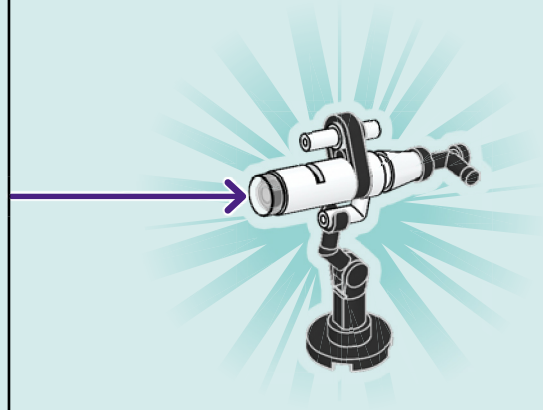

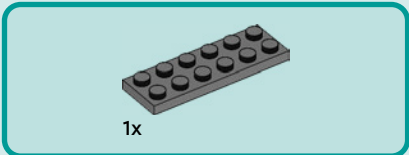
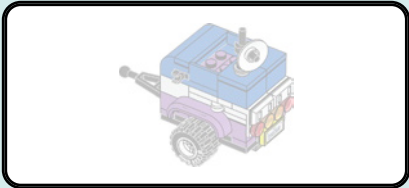

93

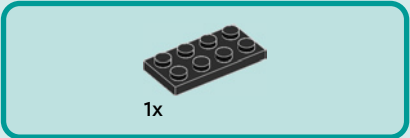
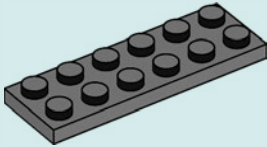

94

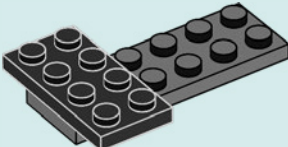



2x

95

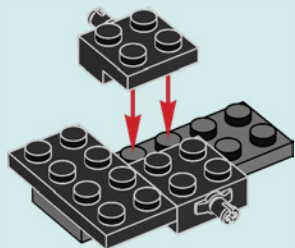

1x

96

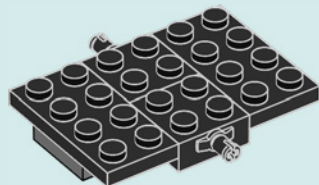



1x

97

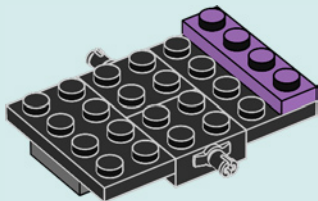

2x



1x

98

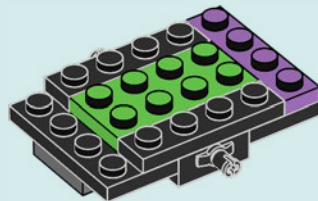



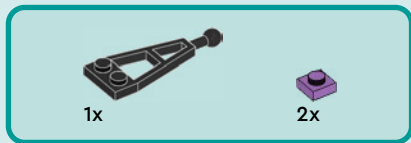

99

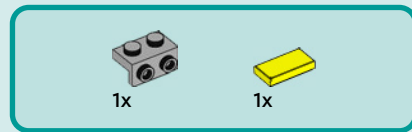
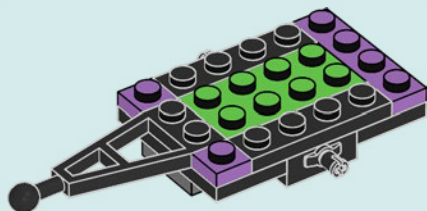

100

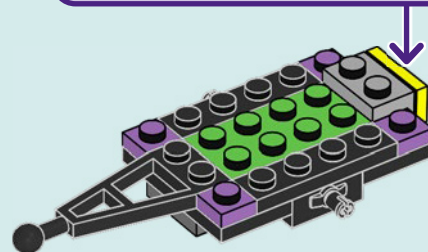
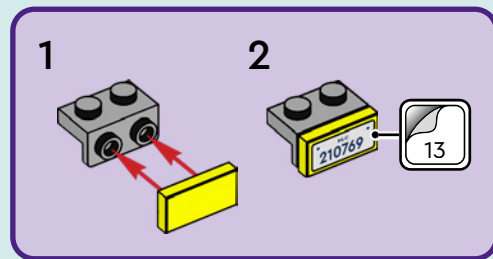



1x



1x

# 101

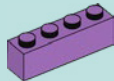
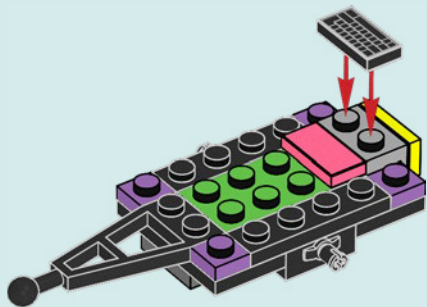

2x



1x

# 102

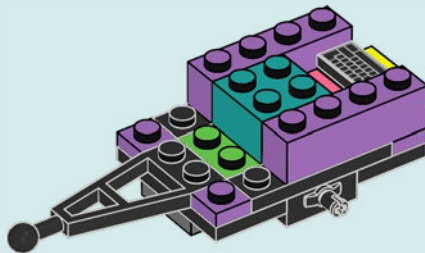

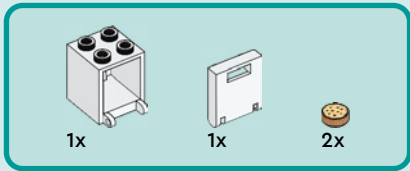

103

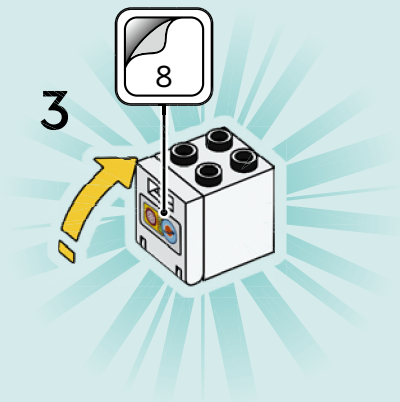
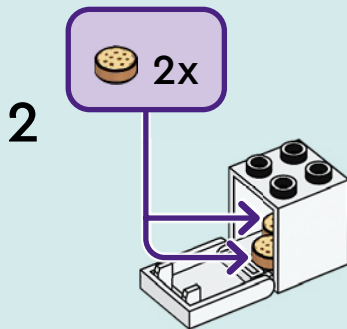
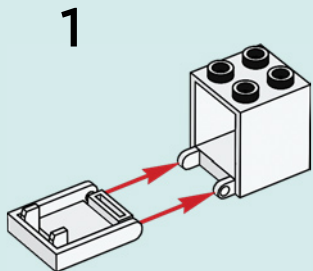

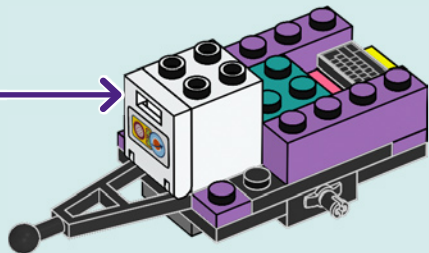



2x



2x

# 104

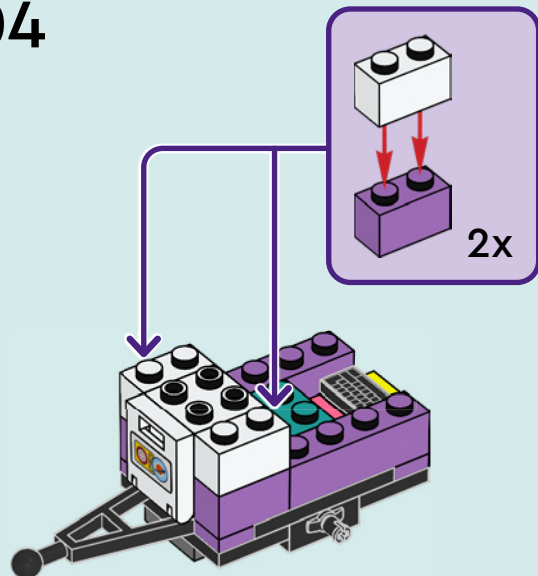

2x



2x

# 105

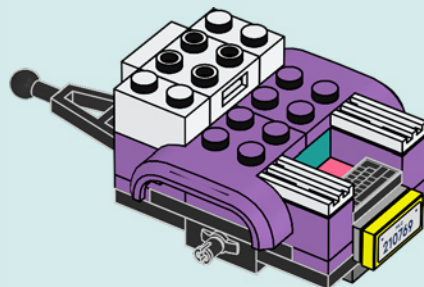



1x



1x

# 106

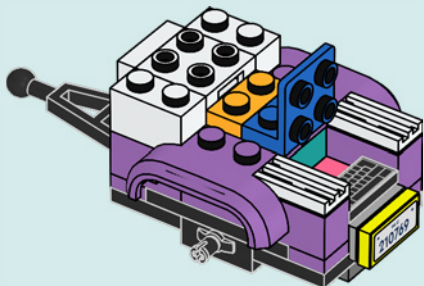

2x

# 107

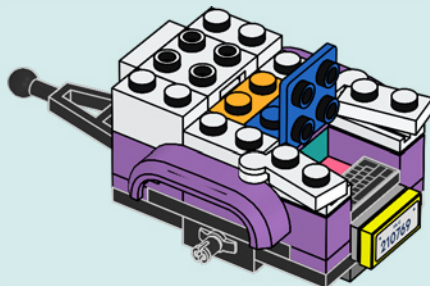



1x

108

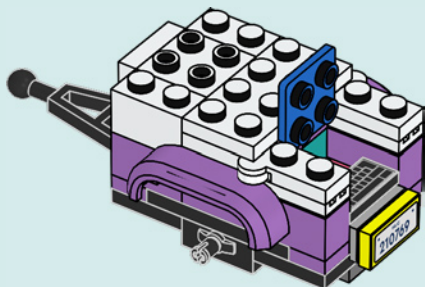

2x

109

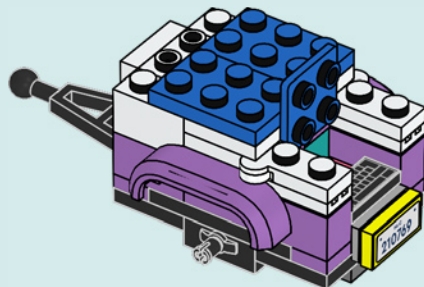



2x

110

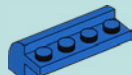
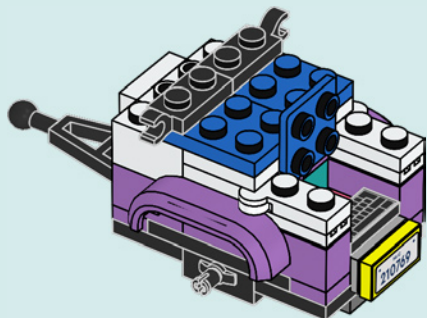

1x

111

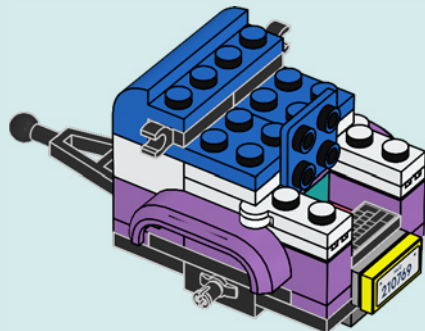





2x



2x

# 112

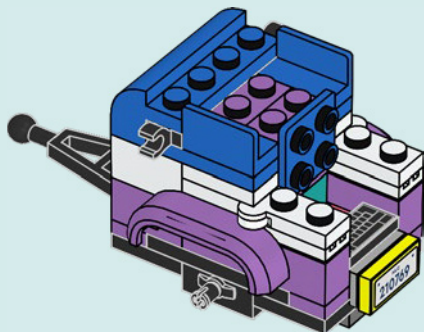

1x

# 113

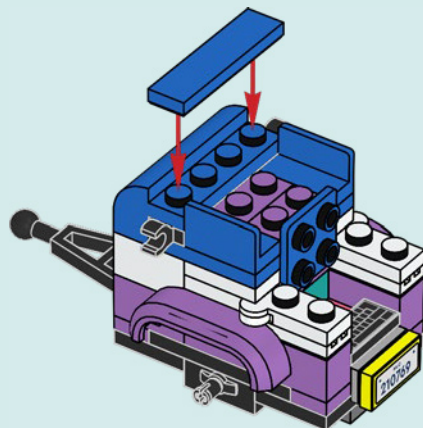



1x

114

1



2

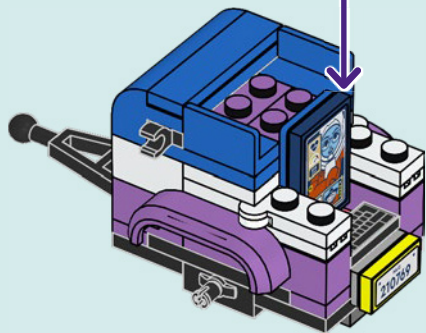

2x

115



2x

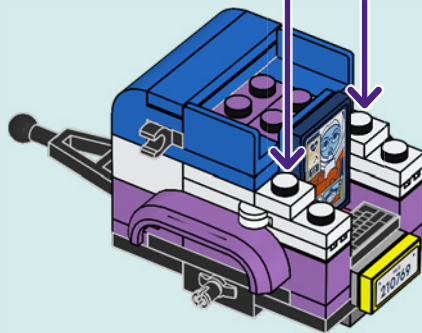

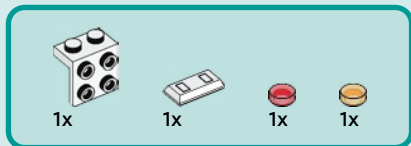

116

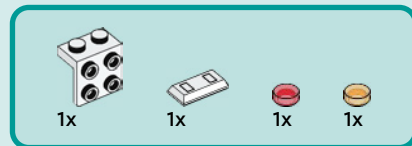
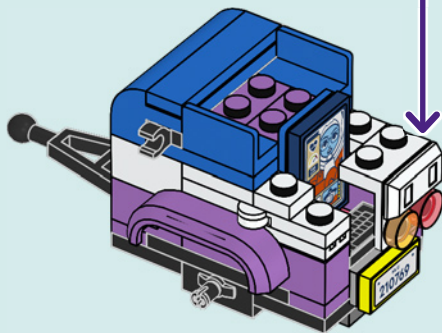

117

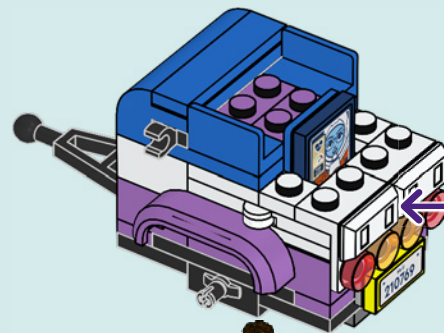
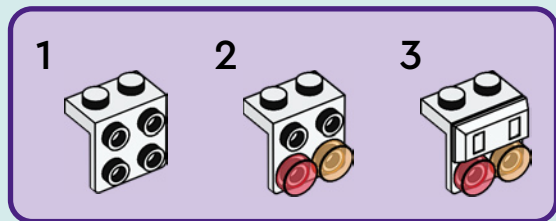



2x

118

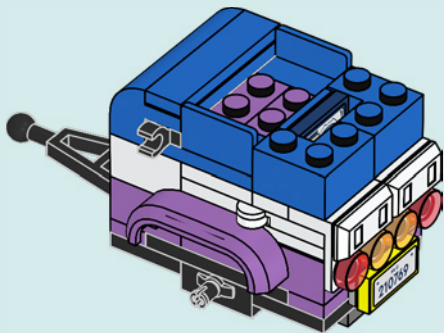

2x

119

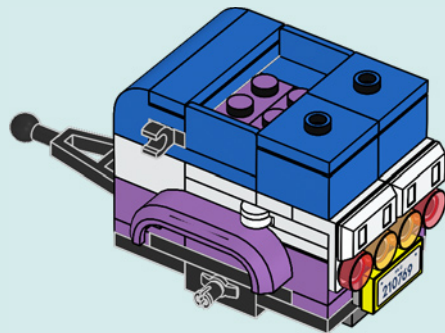



1x

120

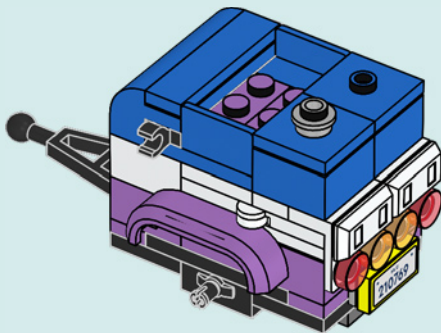

1x



1x



1x

121

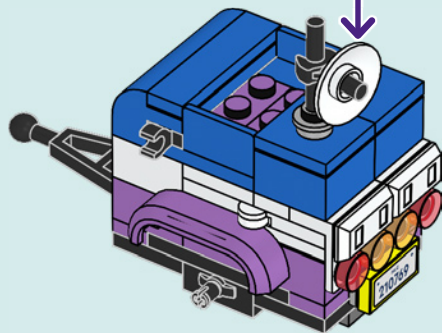
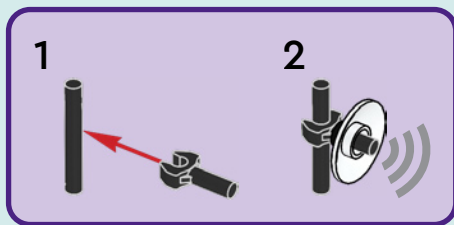



1x

# 122

1



2

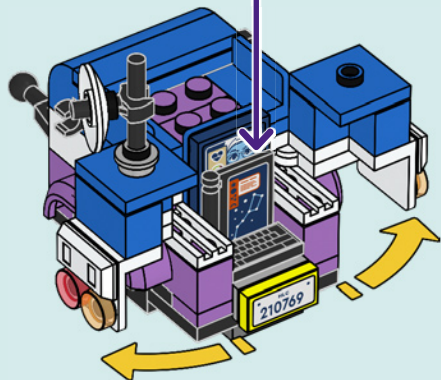

2x



2x

# 123



2x

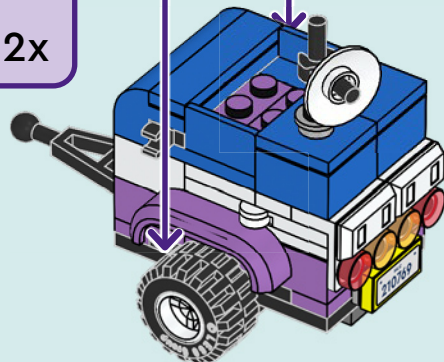
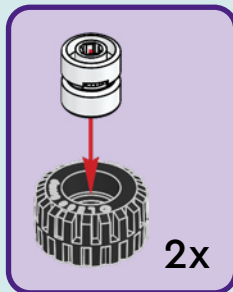

124

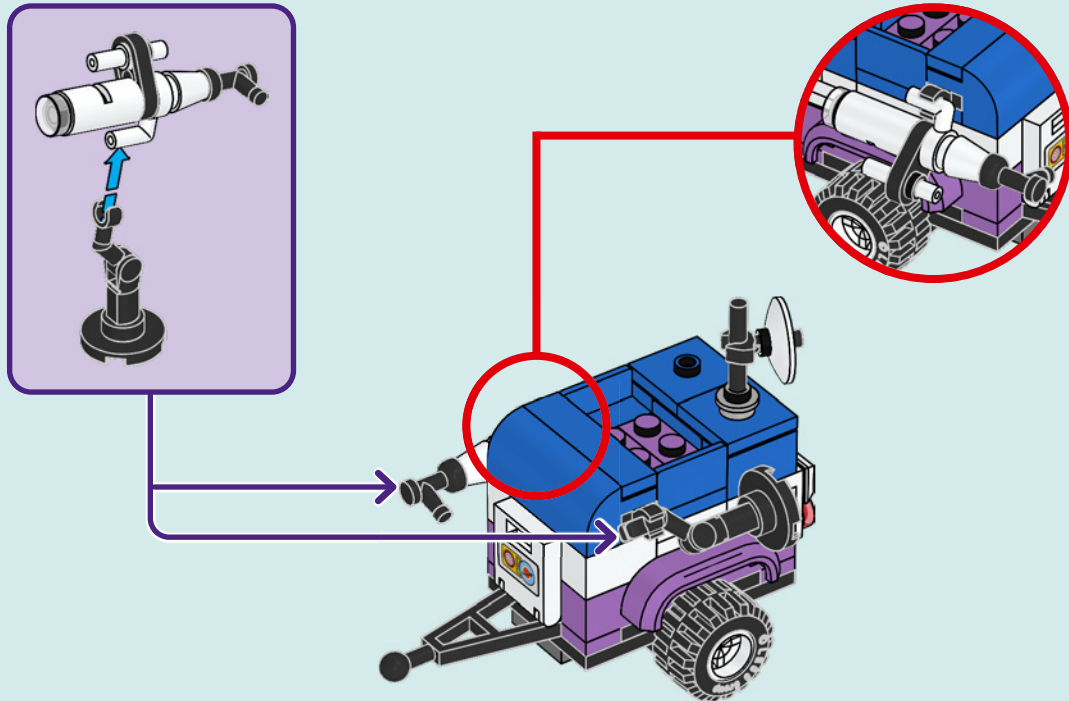

125

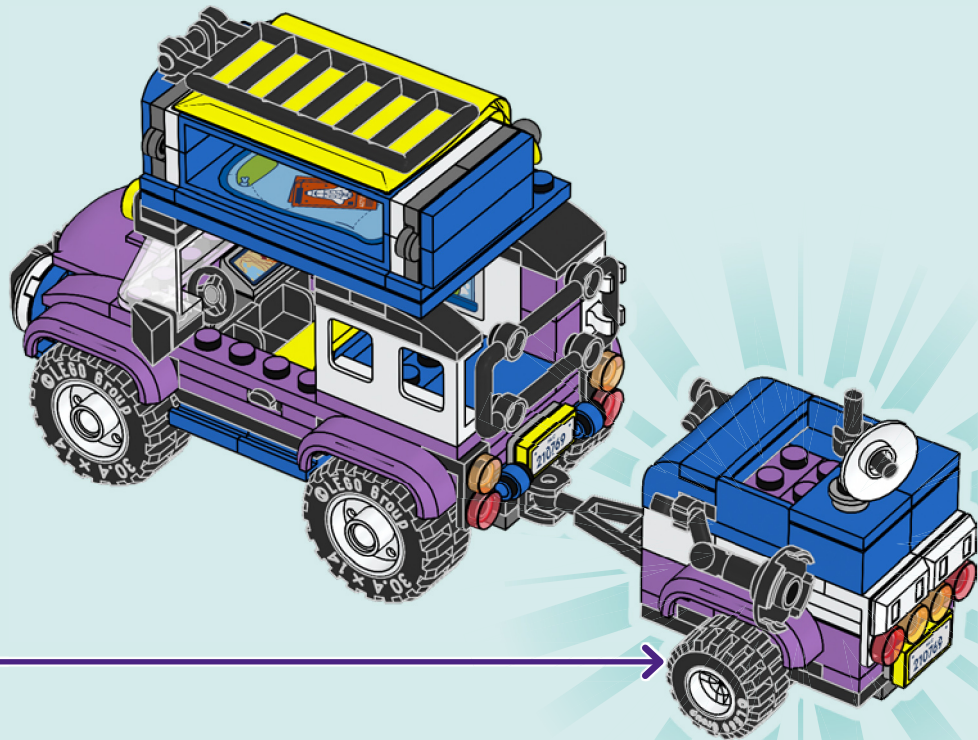





1



2



# 126

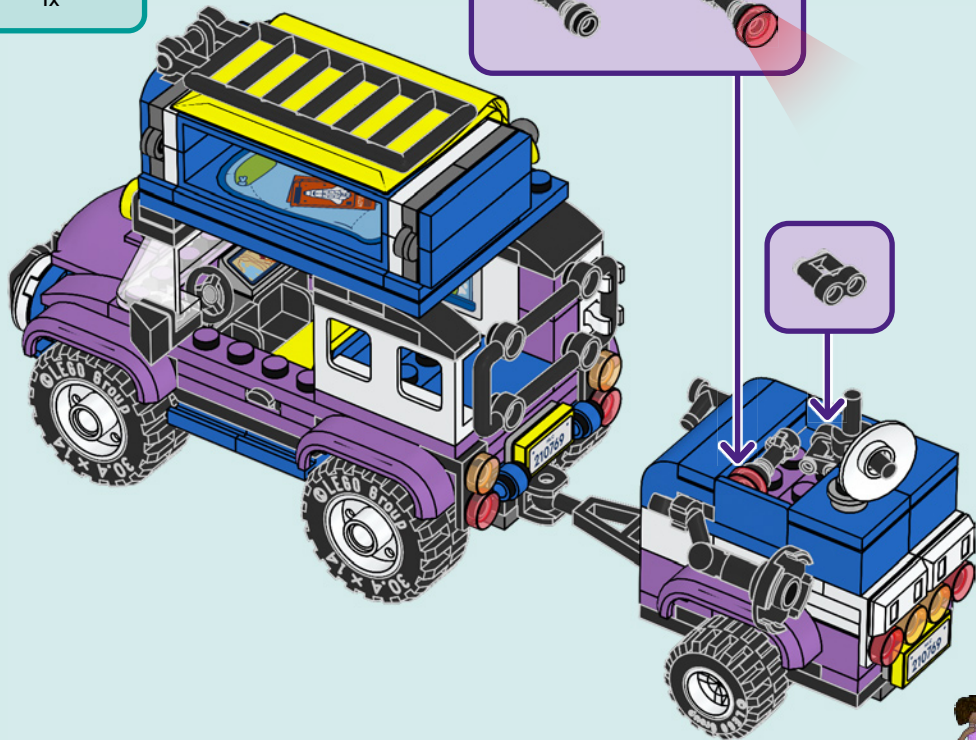

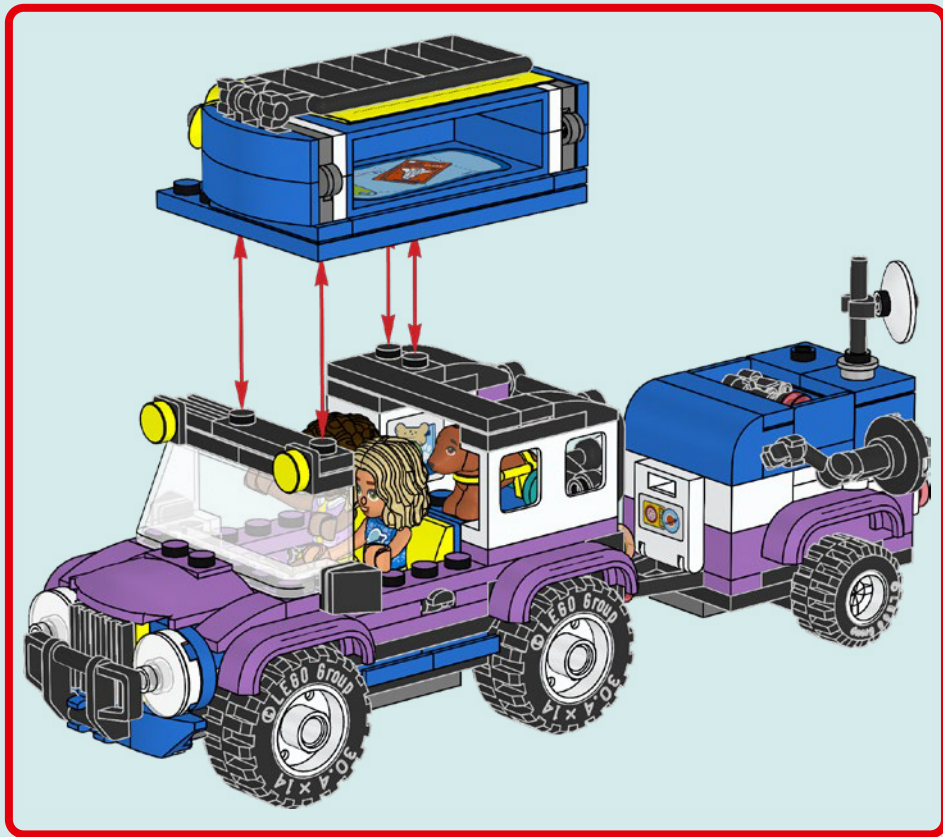







































































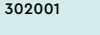

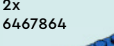









**LEGO** Friends

WATCH  
SERIES  
ONLINE

REGARDEZ  
LA SÉRIE  
EN LIGNE

MIRA  
LA SÉRIE  
EN INTERNET



 1x 6284572	 2x 241201	 4x 6223491	 1x 6470958	 2x 4558606	 1x 6196596	 1x 389924	 4x 6234695
 1x 4518400	 2x 300401	 1x 4619665	 1x 306221	 2x 6126049	 1x 4212411	 1x 6440426	 2x 6380236
 10x 6469041	 2x 6210076	 6x 371001	 2x 6344028	 1x 4587840	 2x 4649773	 1x 6329869	 1x 6283610
 2x 302401	 1x 6173116	 1x 4521846	 1x 6172414	 1x 362323	 1x 6427428	 1x 4598897	 1x 6003301
 2x 6437184	 1x 4261470	 1x 4521846	 1x 6172411	 2x 317623	 1x 6427428	 1x 6321194	 2x 6210270
 2x 6321349	 2x 6117940	 2x 6416527	 2x 6281991	 2x 317623	 1x 4118785	 1x 6186675	 1x 6302313
 1x 6357680	 2x 6117940	 1x 302001	 2x 6146218	 1x 6271125	 2x 6467864	 1x 6439039	 1x 6195325
 2x 4170457	 4x 6260609	 1x 302001	 3x 6133720	 2x 302123	 1x 303623	 1x 459926	 3x 302326
 1x 434601	 1x 434501	 1x 6409761	 4x 6179330	 2x 302123	 1x 303623	 2x 6088585	 3x 241226
 2x 6093053	 1x 6300017	 1x 6466332	 1x 302223	 5x 243123		 2x 4504382	 2x 6115086
 1x 474001						 1x 307026	



1x  
4226995



1x  
6047276



1x  
6403650



1x  
4140588



1x  
6093525



1x  
6273226



1x  
6053077



2x  
4568644



1x  
362326

94



2x  
6482959



1x  
6359942



1x  
302126



3x  
6254045



2x  
371026



4x  
4619323



2x  
302026



2x  
6336989



1x  
4274405



1x  
6172984



1x  
663626



2x  
6064228



1x  
303226



1x  
602026

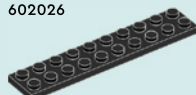

3x  
383226



1x  
4546705



2x  
300528



2x  
4107736



1x  
4107758



1x  
6062166



2x  
302028



1x  
6141590



1x  
4116671



2x  
6021999



3x  
6069259



1x  
6416764



2x  
6441766



1x  
6274738



2x  
6245306



1x  
6245195



5x  
6258607



1x  
6274739



1x  
6421682



3x  
6273853



1x  
6314091



2x  
6350418



1x  
6264062



1x  
4164021



4x  
6299536



1x  
6389684



1x  
6186974



2x  
4569836



2x  
6027625



2x  
6023154



1x  
6250216



2x  
6037887



3x  
6027627



3x  
6400754



1x  
6101285



2x  
4543949



1x  
6174940

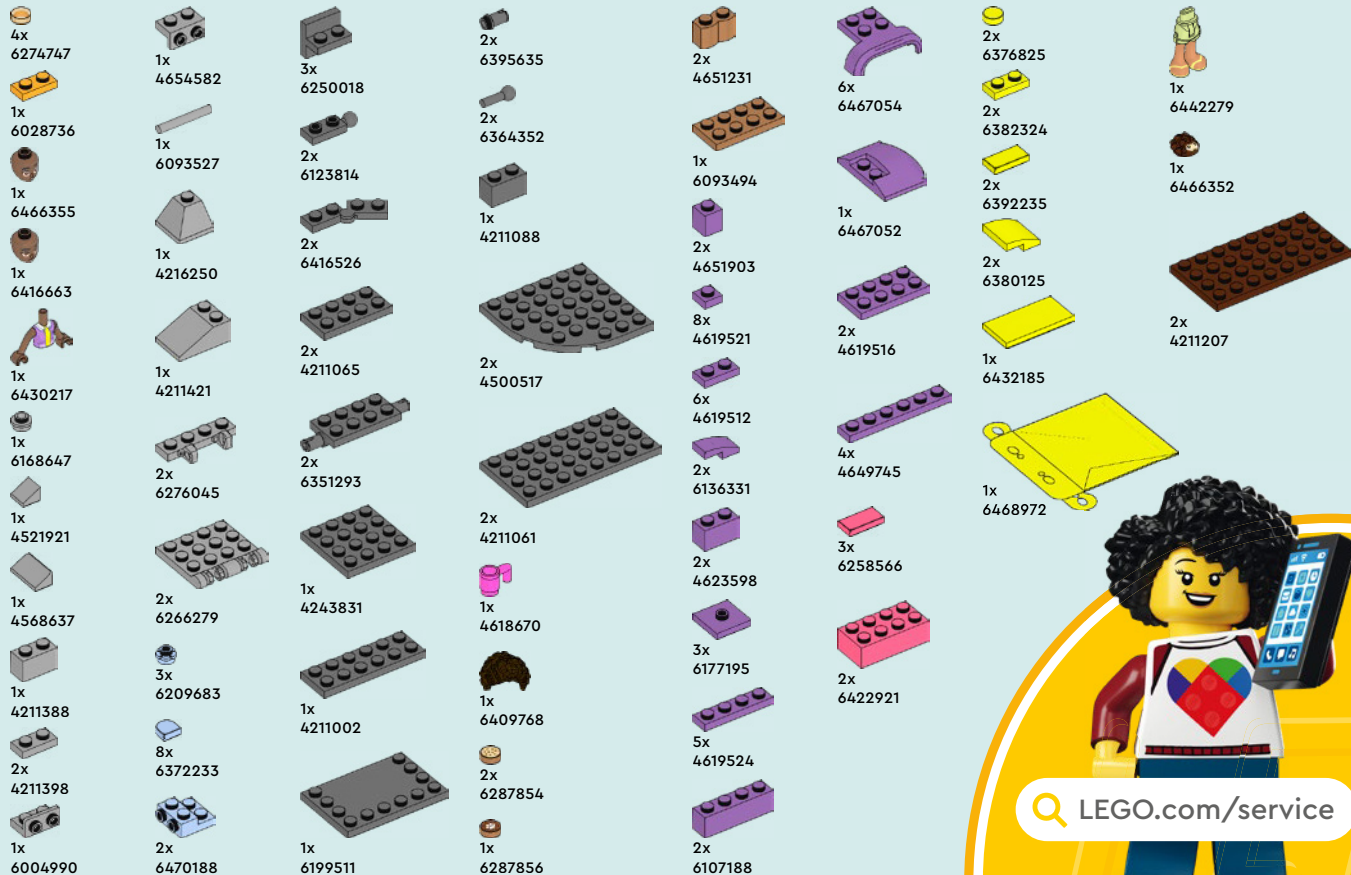

 [LEGO.com/service](https://www.LEGO.com/service)

YOU COULD  
**WIN**



Scan this QR code or go to  
**LEGO.COM/PRODUCTFEEDBACK** and give  
us your short feedback about this LEGO® set  
for a chance to win a cool LEGO prize.

Terms and Conditions apply\*

**EN: YOU COULD WIN.** Terms and Conditions apply\* **DE: Du könntest GEWINNEN.** Es gelten die Teilnahmebedingungen\* **FR: Tu pourrais GAGNER.** Des conditions s'appliquent\* **IT: Potresti VINCERE tu.** Termini e condizioni sono applicabili\* **ES: Puedes GANAR.** Aplican términos y condiciones\* **PT: Poderá GANHAR.** Aplicam-se termos e condições\* **ZH: 轻松获奖. 条款和条件适用\*** **PL: Szansa na WYGRANĄ.** Obowiązują warunki korzystania\* **CS: Máte šanci VYHRÁT.** Platí všeobecné smluvní podmínky\* **SK: Máte šancu VYHRAŤ.** Platia všeobecné zmluvné podmienky\* **HU: TE IS NYERHETSZ.** Felhasználási feltételek érvényesek\* **RO: Ai putea CÂȘTIGA.** Se aplică termenii și condiții\* **BG: Можете да СПЕЧЕЛИТЕ.** Има определени правила и условия\* **LV: Tu vari LAIMĒT.** Ir spēkā noteikumi un nosacījumi.\* **ET: Sul on võimalus VÕITA.** Kehtivad tingimused\* **LT: Jūs galite LAIMĖTI.** Taikomos sąlygos\*

\*[LEGO.com/productfeedback-terms](https://www.lego.com/productfeedback-terms)

LEGO, the LEGO logo and the FRIENDS logo are trademarks of the/son des marques de commerce du/son marcas registradas de LEGO Group. ©2024 The LEGO Group.

6493660