



# Friends

42615



**WARNING: CHOKING HAZARD.**  
Toy contains small parts and a small ball.  
Not for children under 3 years.



LEGO® Builder



### **Get excited about our new packaging!**

We're switching from plastic to paper-based packaging. That's why you might find a mix of paper and plastic in our boxes!

### **Nos nouveaux emballages vous emballeront !**

Nous passons des emballages en plastique aux emballages à base de papier. C'est pourquoi vous pourriez trouver un mélange de papier et de plastique dans nos boîtes !

### **¡Te presentamos nuestros nuevos empaques!**

Estamos sustituyendo las bolsas de plástico por bolsas con base de papel. ¡Por eso, puedes encontrar una mezcla de papel y de plástico en nuestras cajas!

**[LEGO.com/sustainable-packaging](https://www.lego.com/sustainable-packaging)**

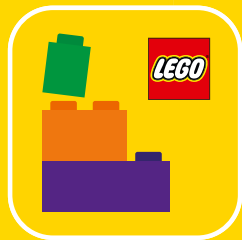

Q LEGO® Builder

# BUILDER



Apple and the Apple logo are trademarks of Apple Inc., registered in the U.S. and other countries and regions. App Store is a service mark of Apple Inc. Google Play and the Google Play logo are trademarks of Google LLC. Tencent and the Tencent logo are trademarks of Tencent Inc.

Q [LEGO.com/devicecheck](https://LEGO.com/devicecheck)

**EN** Ask parents' permission before going online | **DE** Eltern um Erlaubnis bitten, bevor du online gehst | **FR** Demande l'autorisation d'un parent avant d'aller en ligne | **IT** Chiedi il permesso ai tuoi genitori prima di andare online | **ES** Pídeles permiso a tus papás antes de conectarte a Internet | **PT** Pede autorização aos pais antes de acederes online | **ZH** 上网前应先征得父母的同意 | **PL** Poproś rodziców o zgodę, zanim wejdiesz do Internetu | **CS** Než půjdeš na internet, požádej rodiče o svolení | **SK** Skôr než pôjdeš na internet, vypýtaj si povolenie od rodičov | **HU** Kérj szülői engedélyt, mielőtt online csatlakoznál! | **RO** Cere permisiunea părinților înainte de a te conecta online | **BG** Поискайте разрешение от родител, преди да влезете онлайн | **LV** Pirms došanās tiešsaistē palūdz atļauju vecākiem | **ET** Enne Interneti kasutamist küsi vanematelt luba | **LT** Prieš prisijungdami prie interneto, atsiklauskite tėvų



**AVERTISSEMENT :**  
**RISQUE D'ÉTOUFFEMENT.**  
Le jouet contient des petites  
pièces ainsi qu'une petite boule.  
Il ne convient pas aux enfants  
de moins de 3 ans.



**ADVERTENCIA:**  
**PELIGRO DE ASFIXIA.**  
Juguete que contiene partes  
pequeñas y una pelota pequeña.  
No recomendado para niños  
menores de 3 años.



# PAISLEY

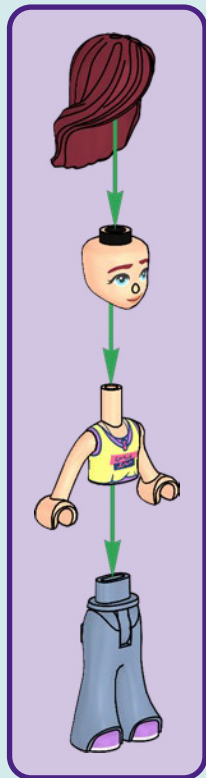

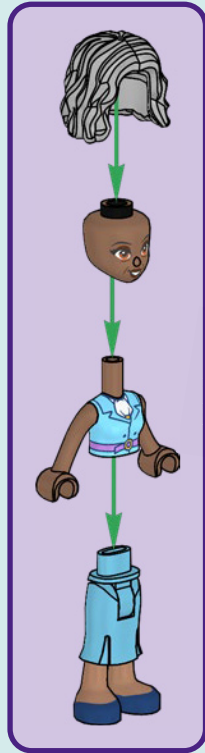

**IRIS**

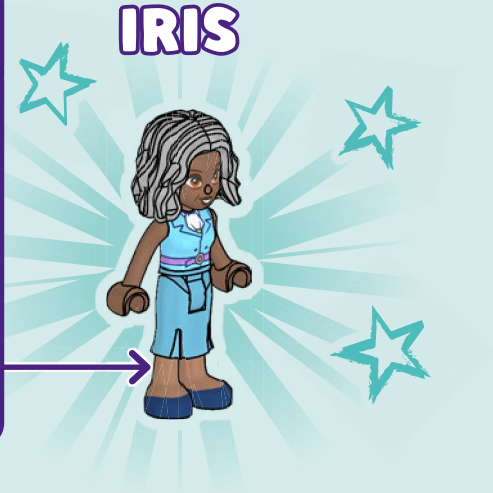

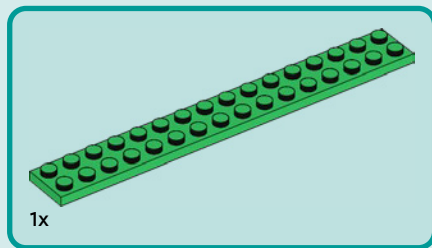
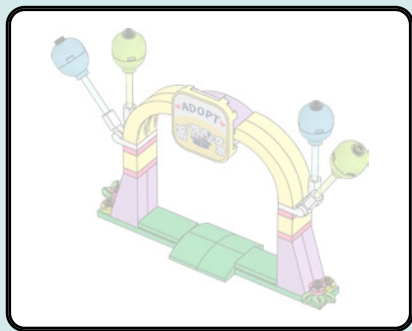

1

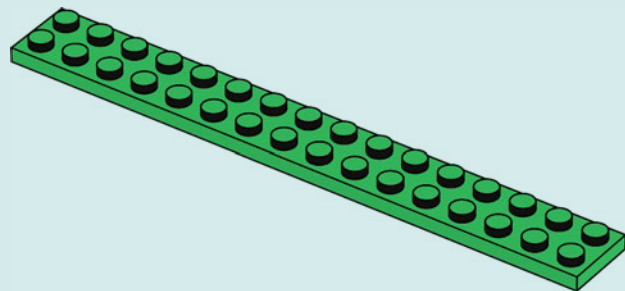



2x

2

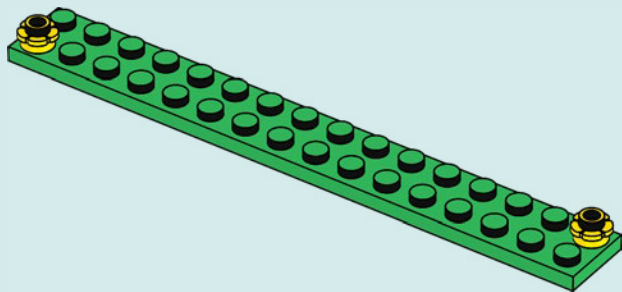



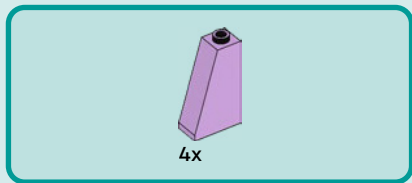

3

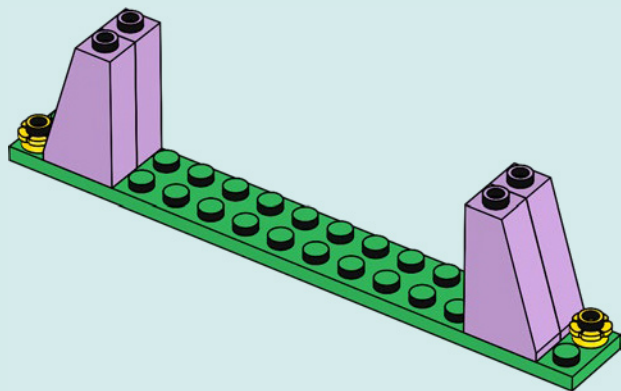

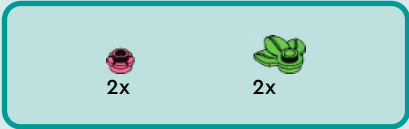

4

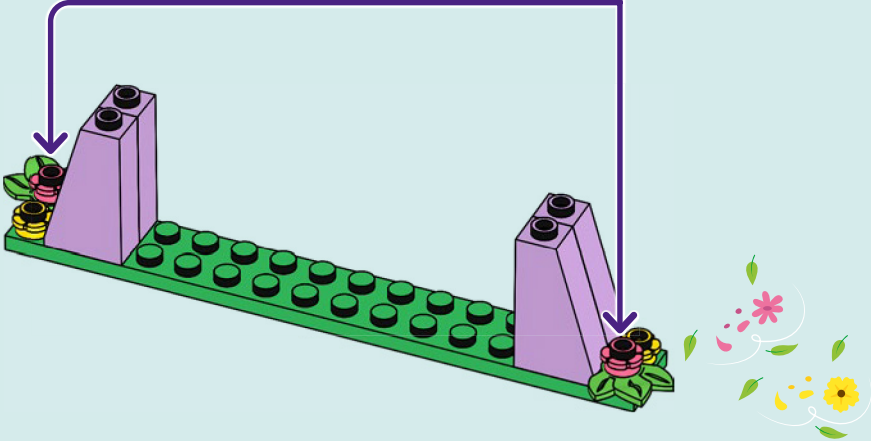
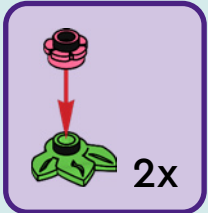

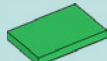

2x

5

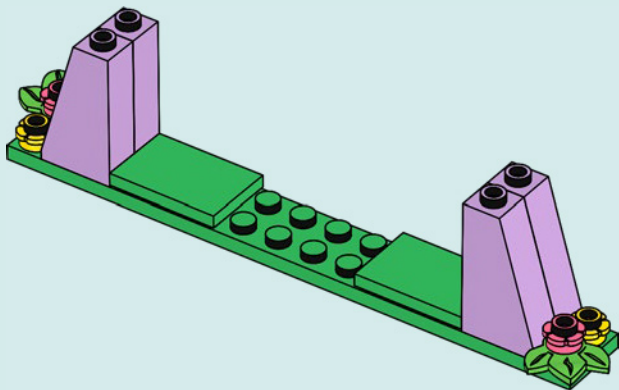



4x

6

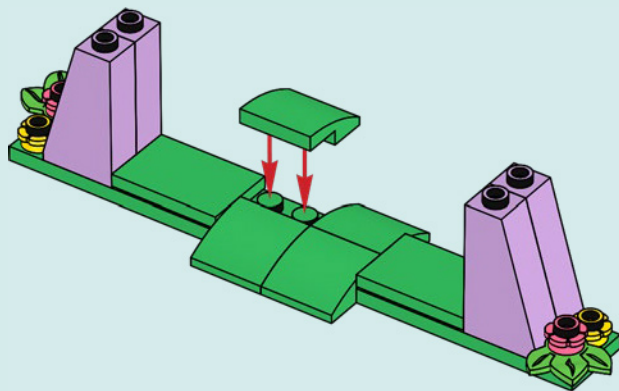

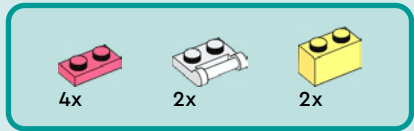

7

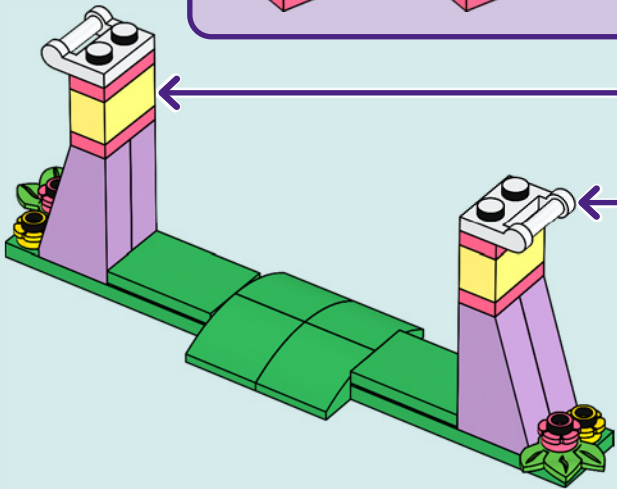
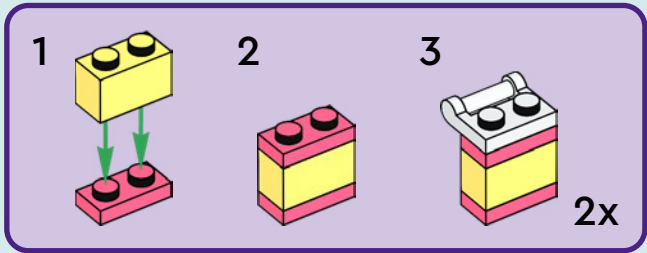

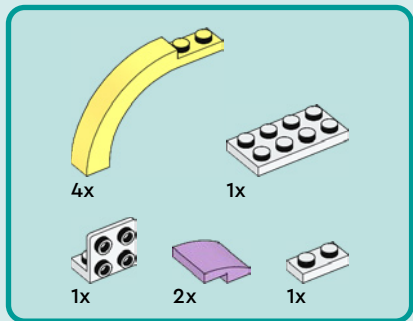

8

1

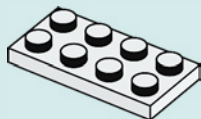

2

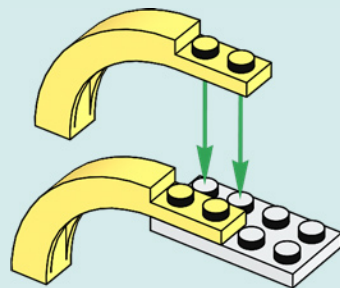

3

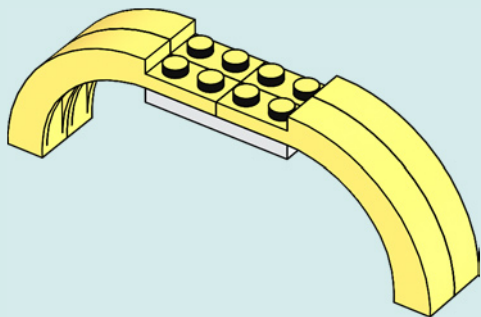

4

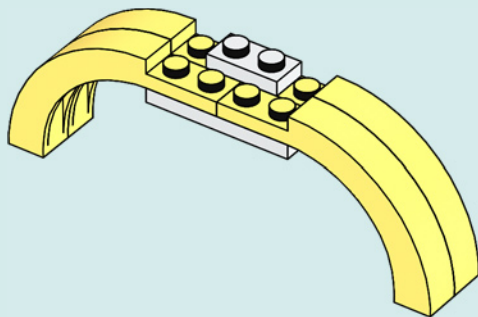

5

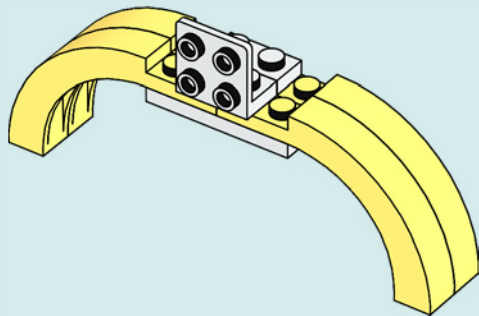

6

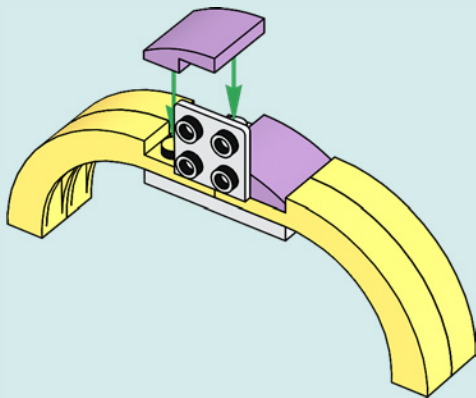



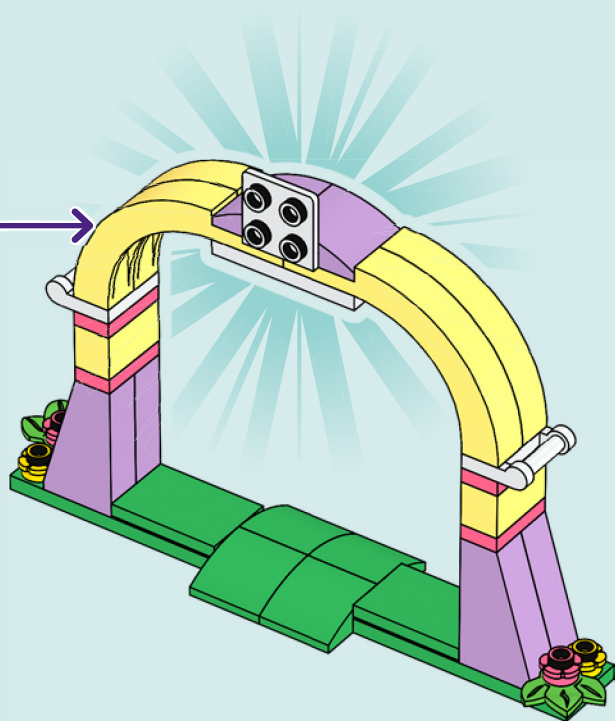

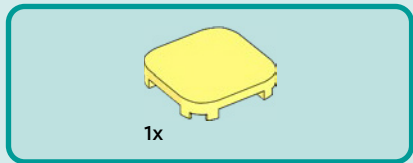

9

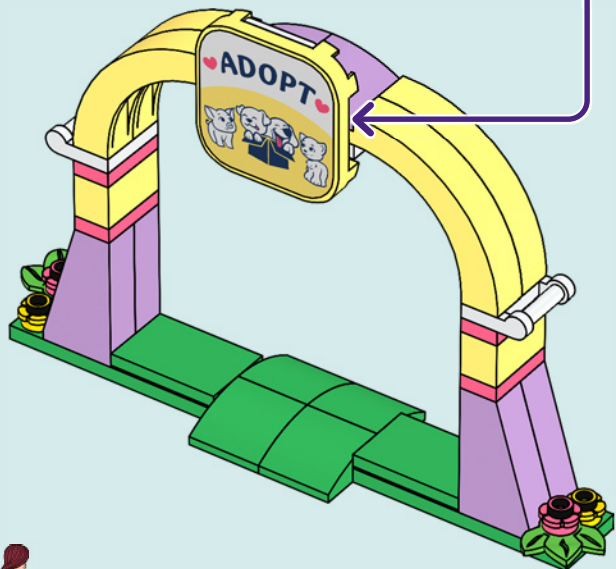
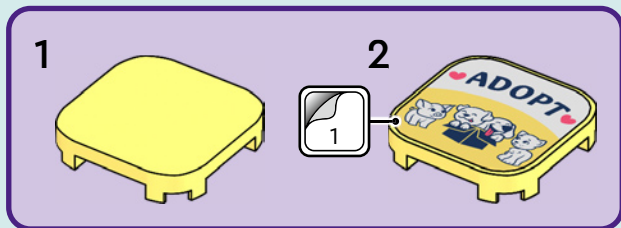

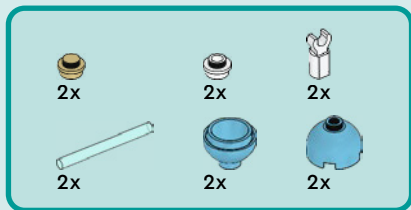

10

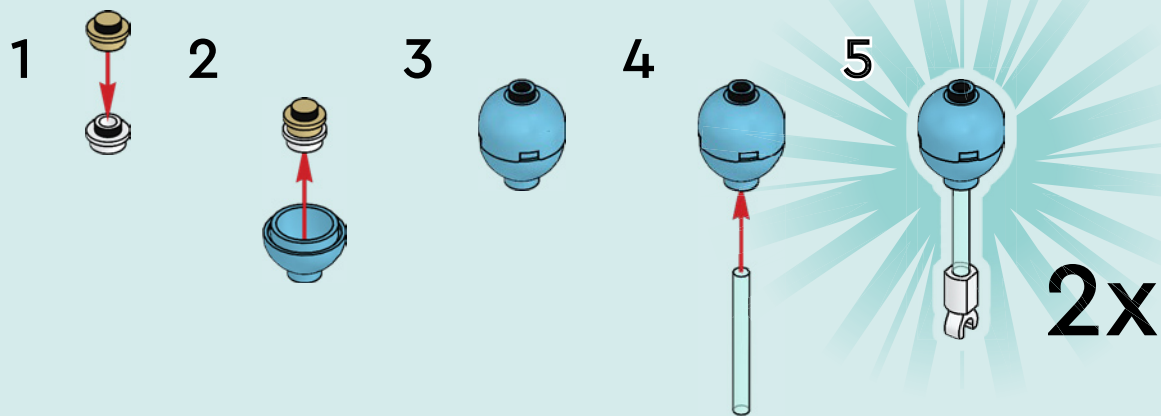

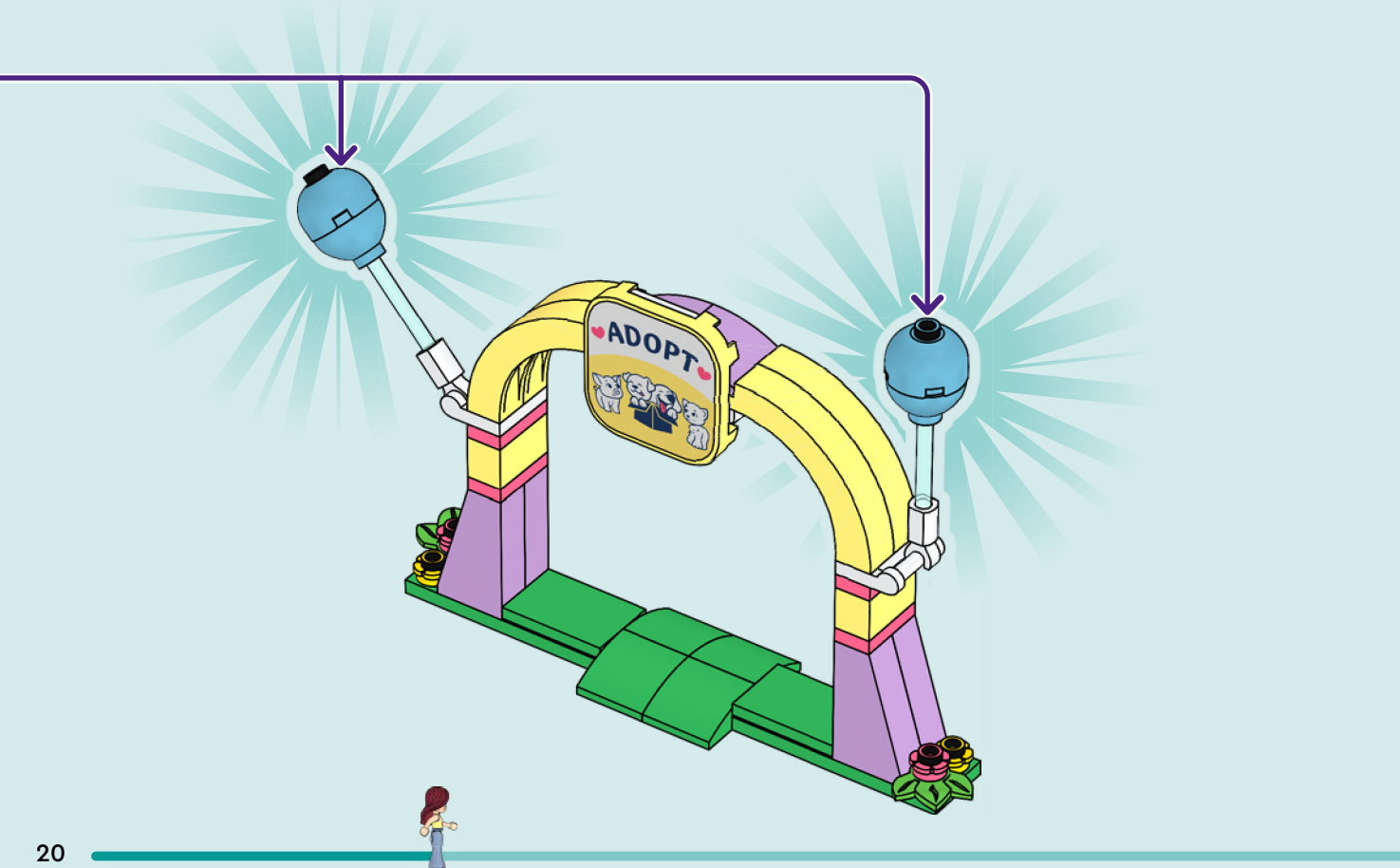



2x



2x



2x



2x



2x



2x



2x

11

1



2



3



4



5



2x

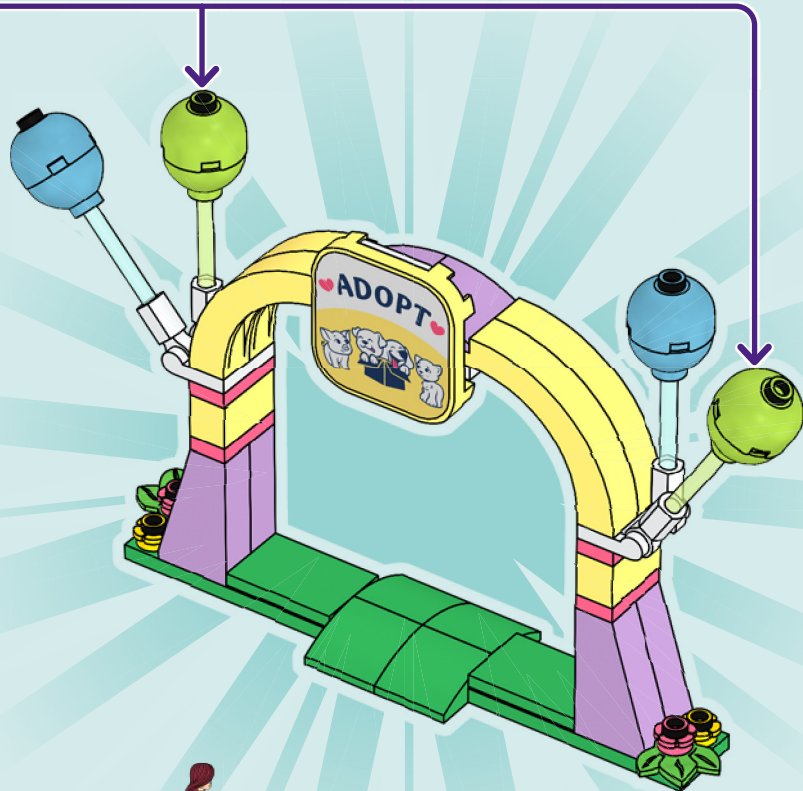

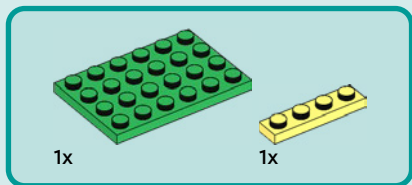

1

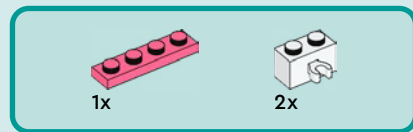
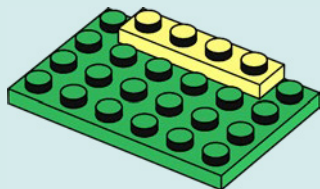

2

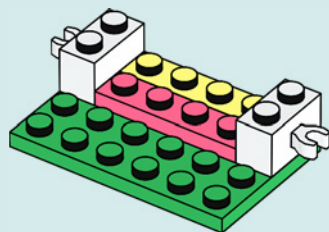



1x

3

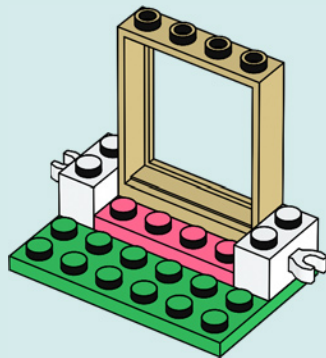





2x

4

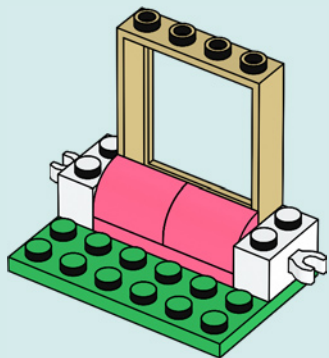

2x

5

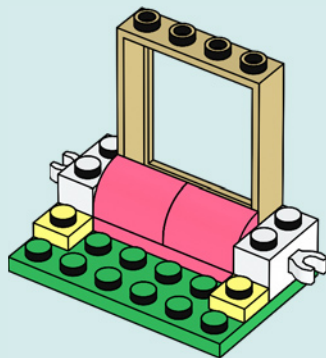



1x



3x

6

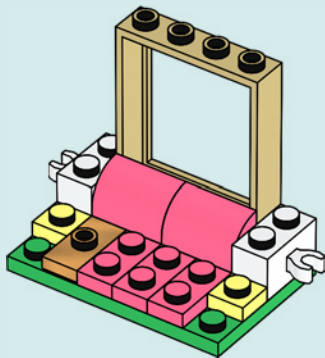



2x



1x

7

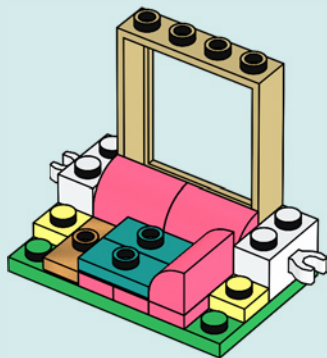

1x

8

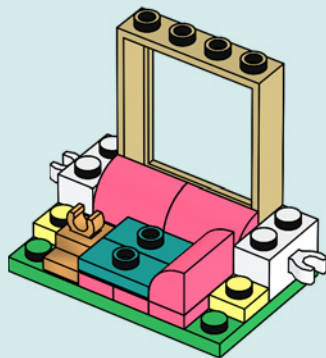



1x

9

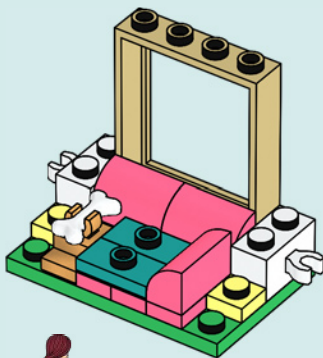



2x



2x

10

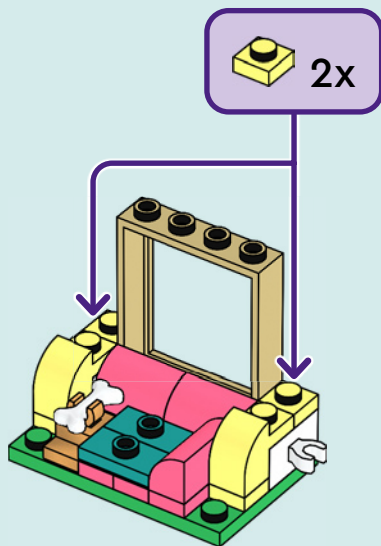

2x



4x

11

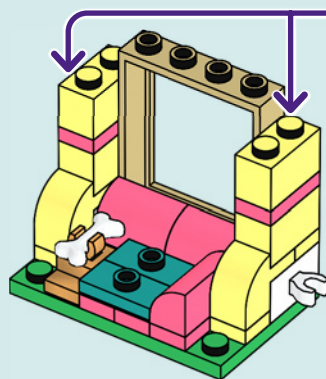
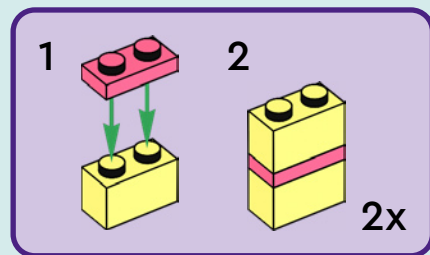



1x

12

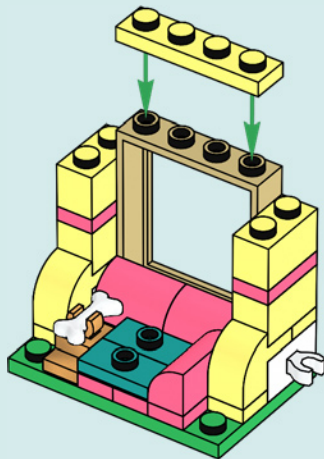



1x



1x

# 13

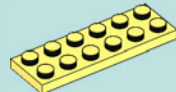
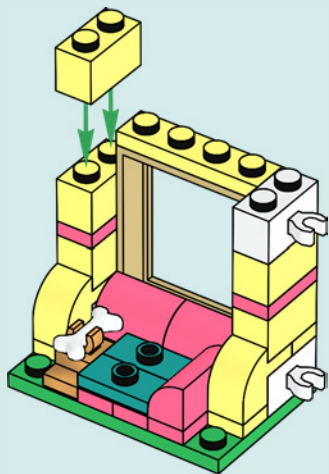

1x

# 14

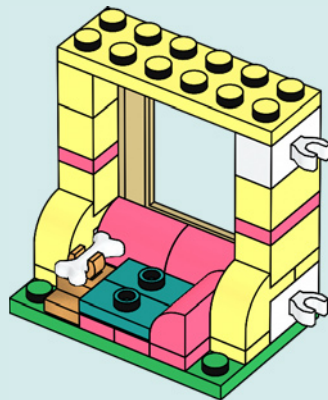



1x

15

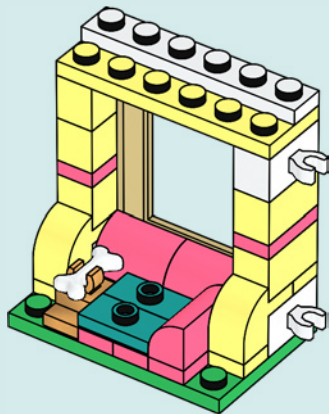





3x



3x

16

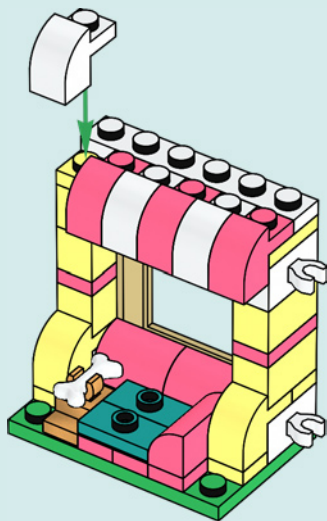

2x

17

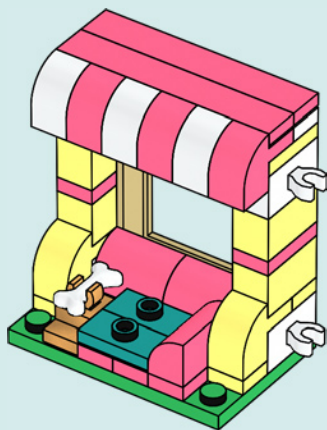



1x



1x

# 18

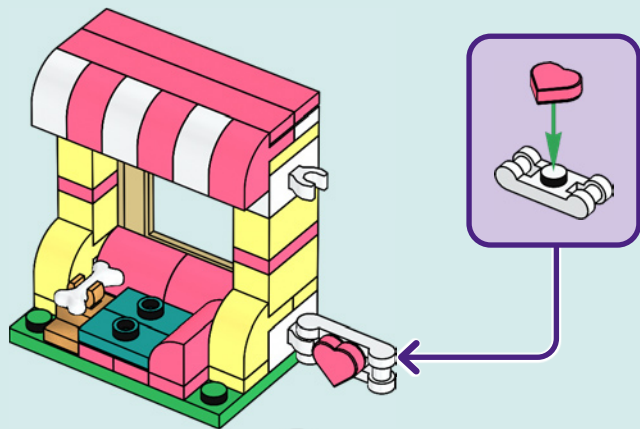



1x

19

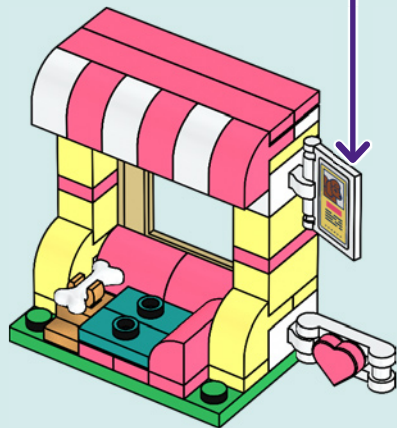
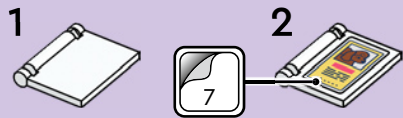

1x

20

HARLEY

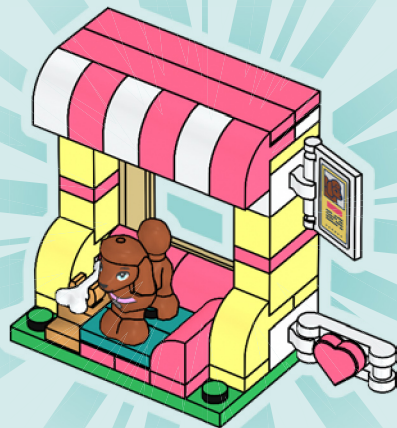

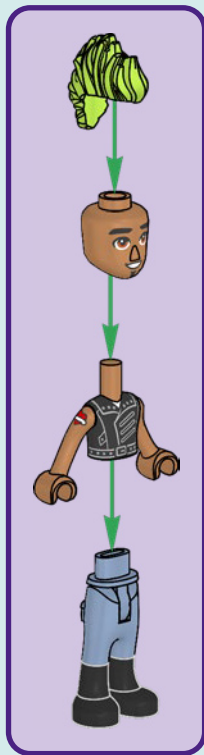

**ANTHONY** ★

**ELLA**



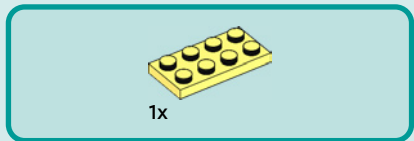

1

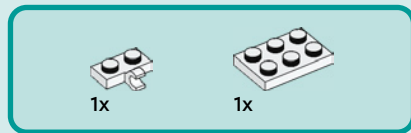
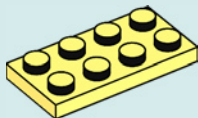

2

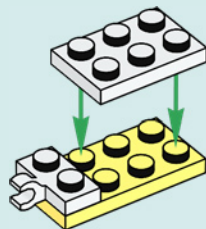



1x

3

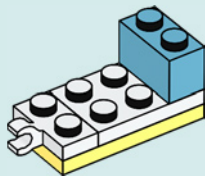



2x



1x

4

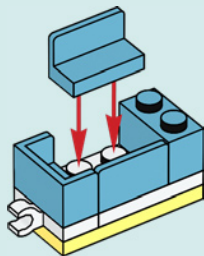

2x

5

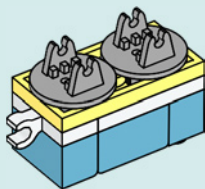



2x

6

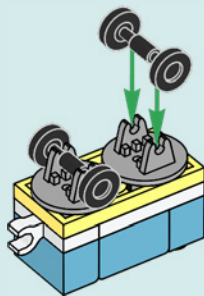





2x

7

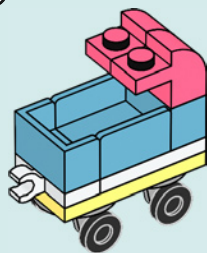

1x

8

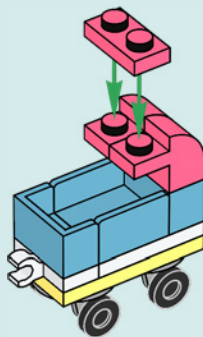



1x

9

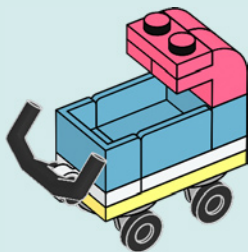



1x

10

**ROY**

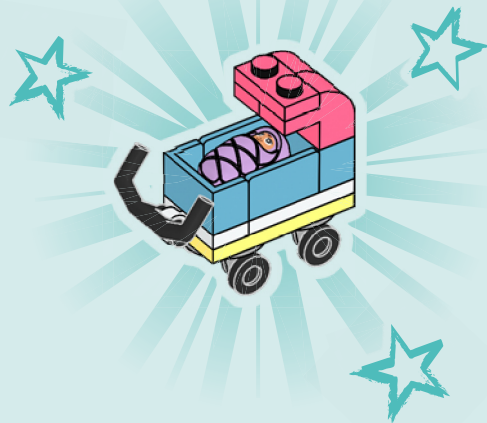

11

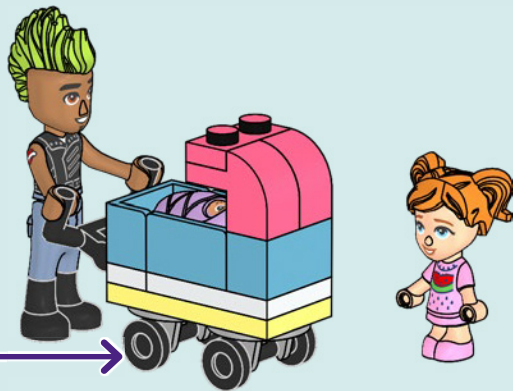

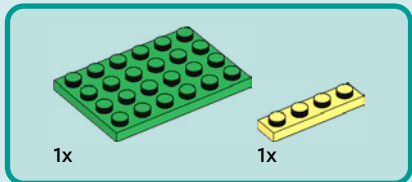

1

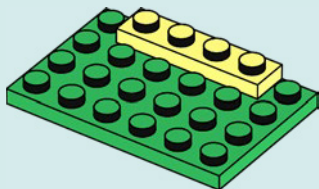



2x



2x

2

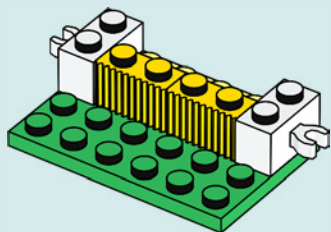

2x

3

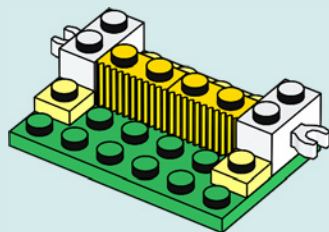

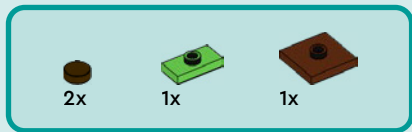

4

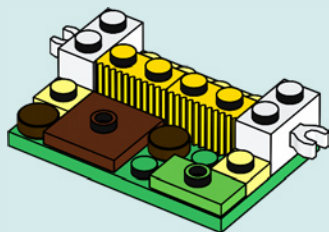



2x



2x

5

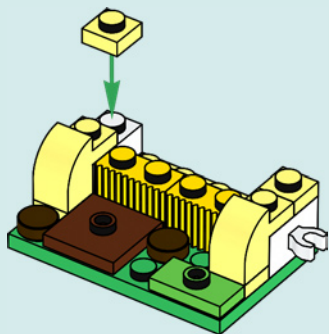

1x

6

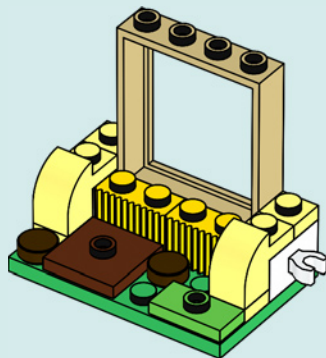



1x



1x

7

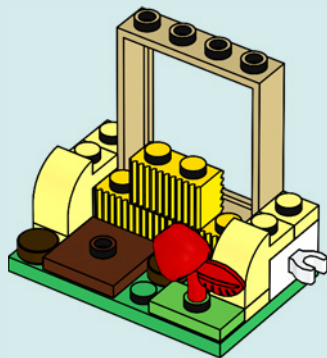





2x



4x

8

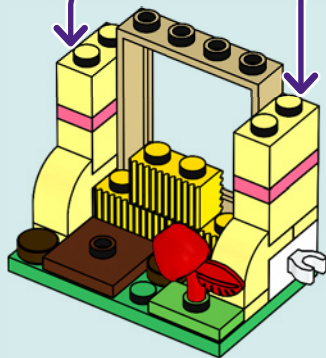
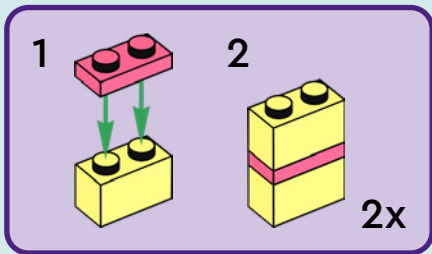

1x

9

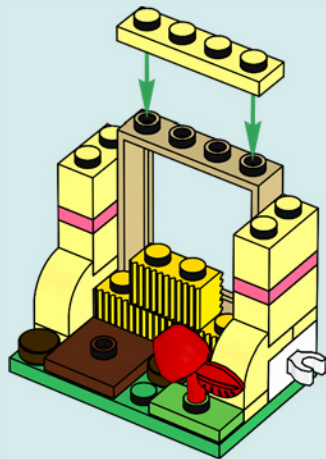



1x



1x

10

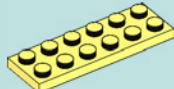
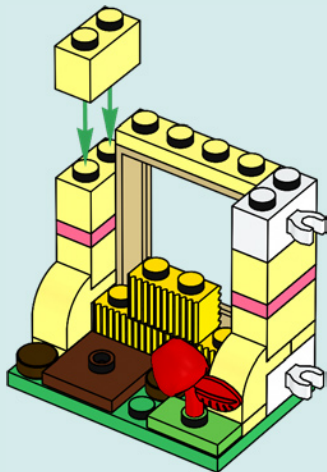

1x

11

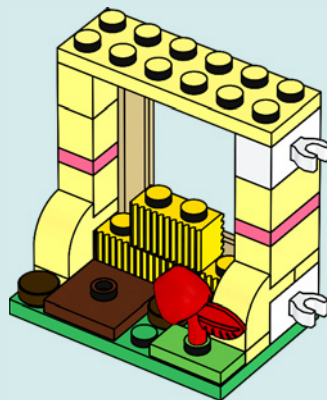

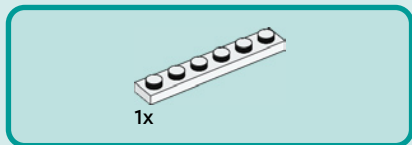

12

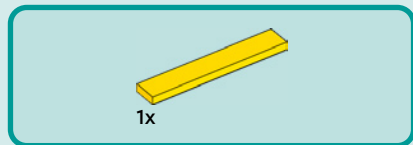
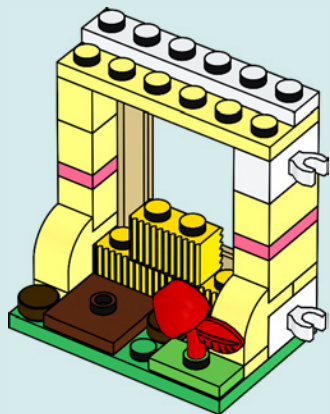

13

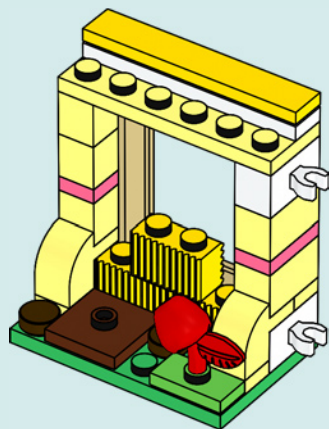



3x



3x

# 14

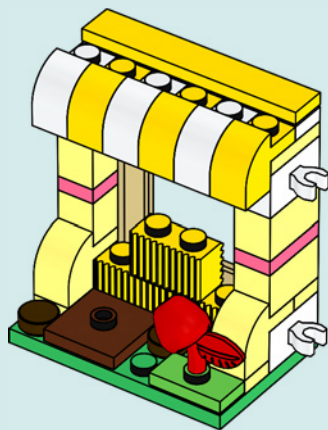

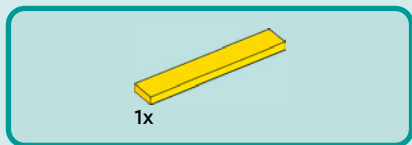

15

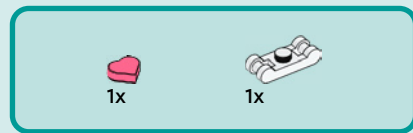
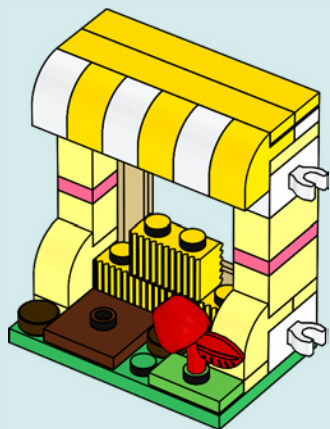

16

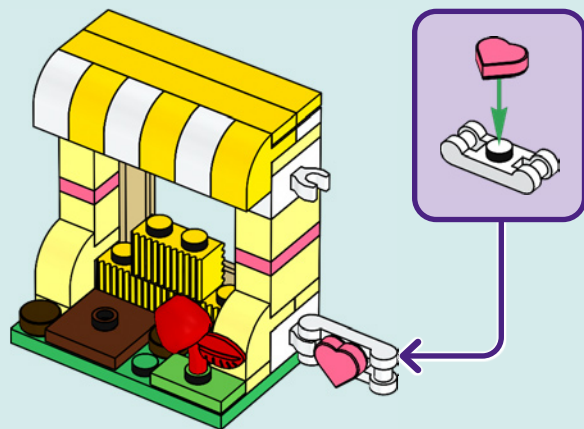



1x

17

1



2

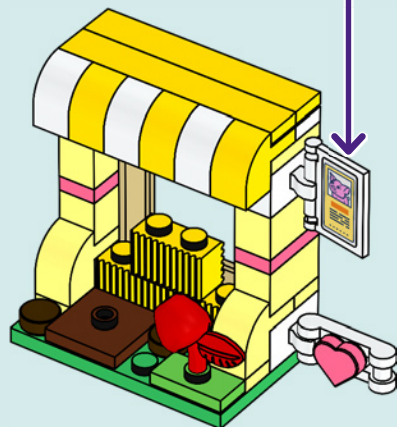

1x

18

HAMLET

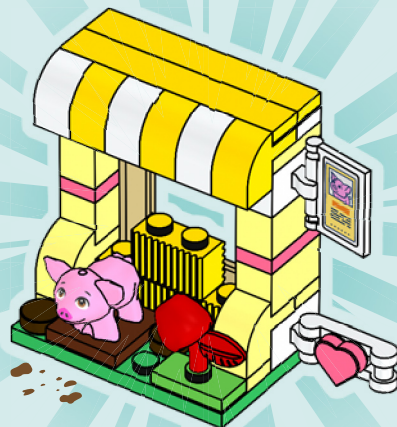

19

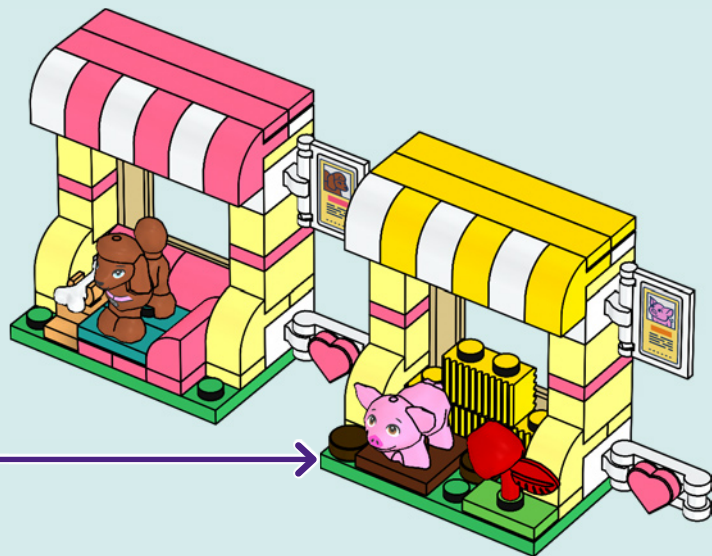

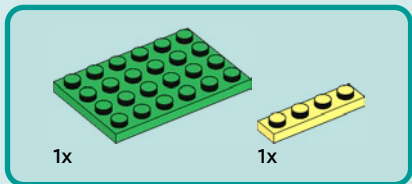

1

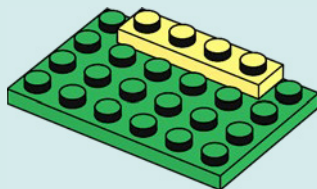



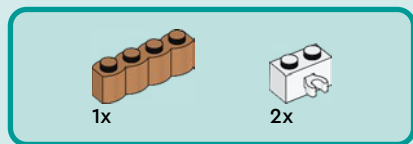

2

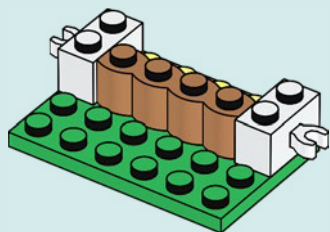

3

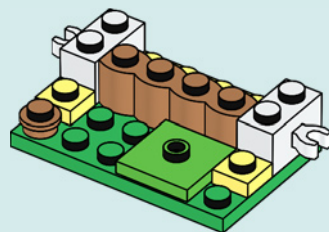



2x



2x

4

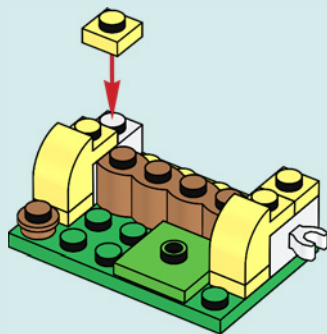



1x



1x

5

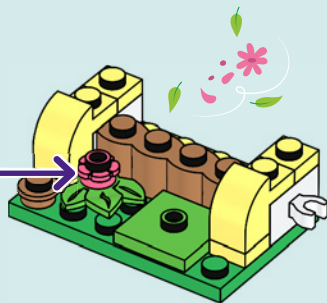
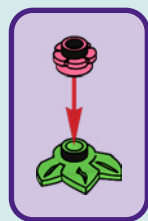

1x



1x

6

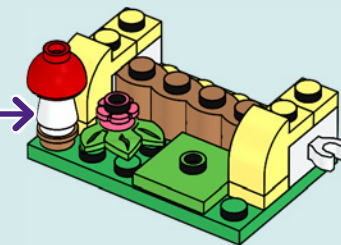
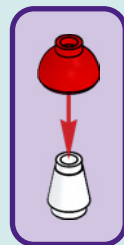



2x

7

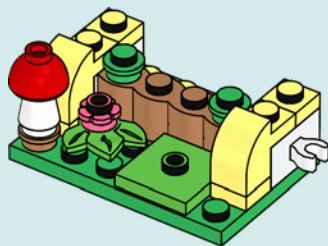



1x

8

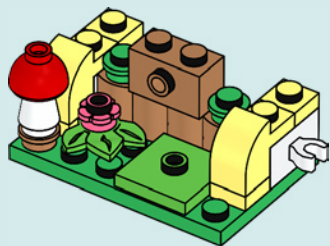

2x

9

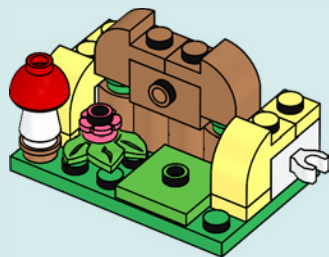



1x

10

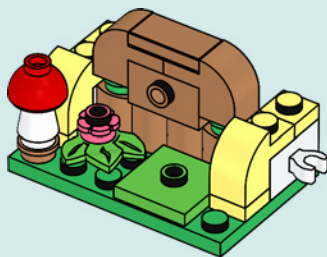

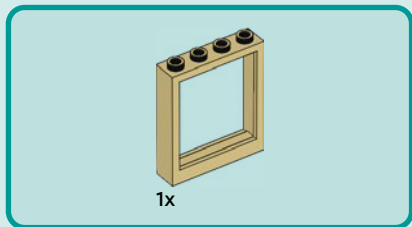

11

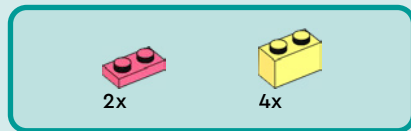
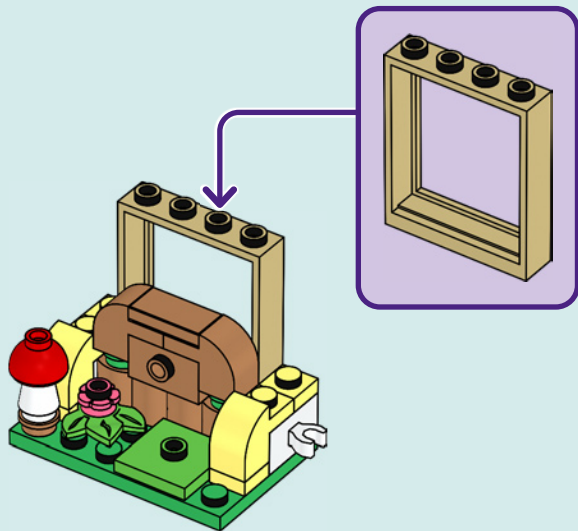

12

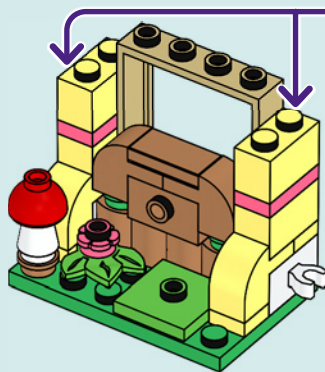
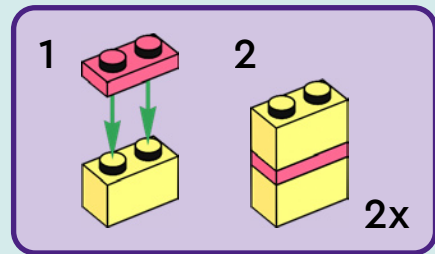



1x

13

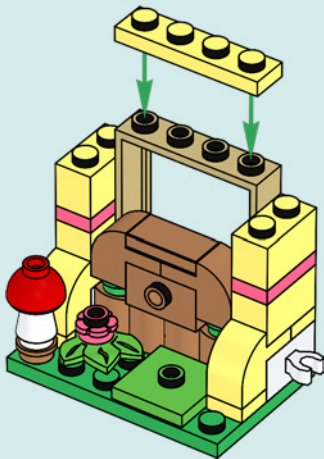





1x



1x

14

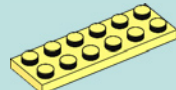
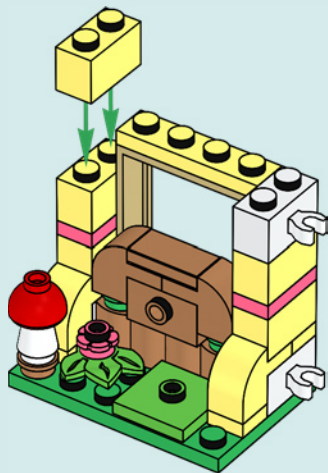

1x

15

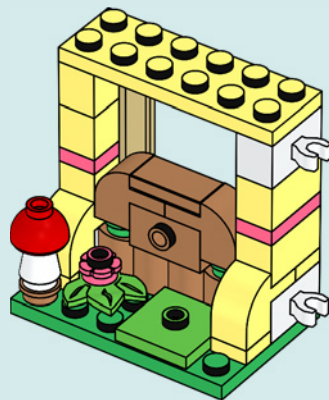



1x

16

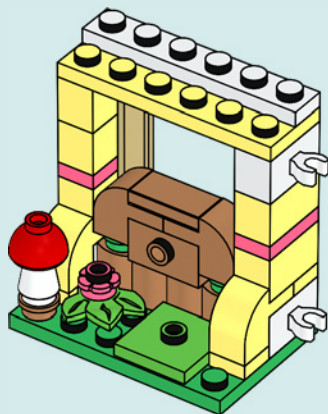



3x



3x

17

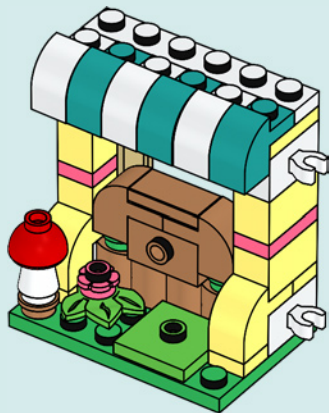

3x

18

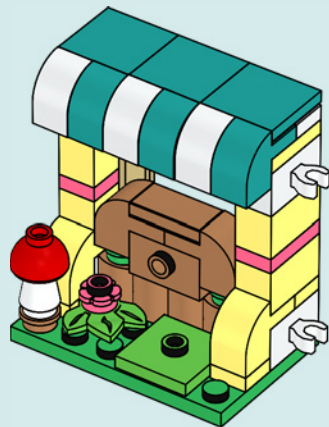



19

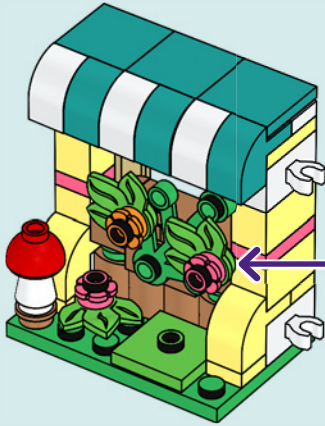
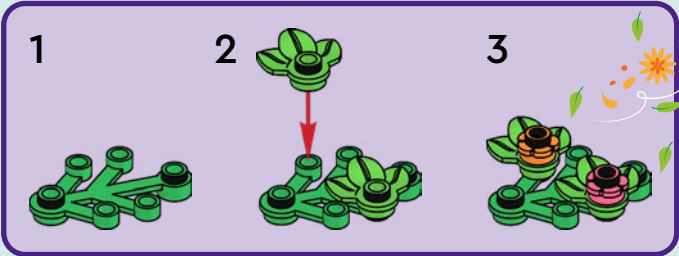



1x

20

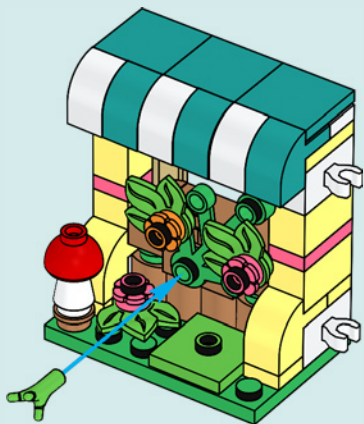

1x



1x

21

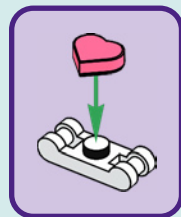
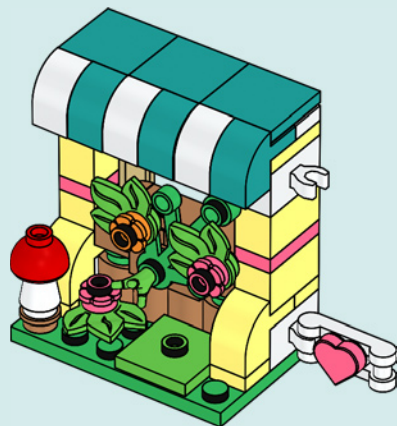



1x

22

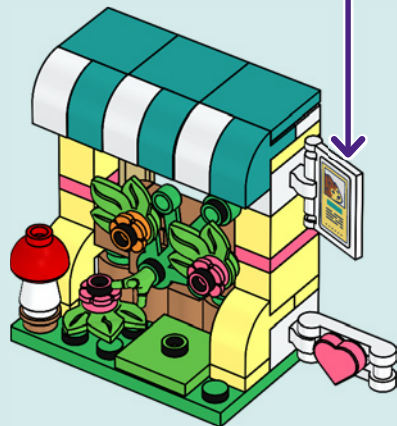

1x

23

**MARSHMALLOW**

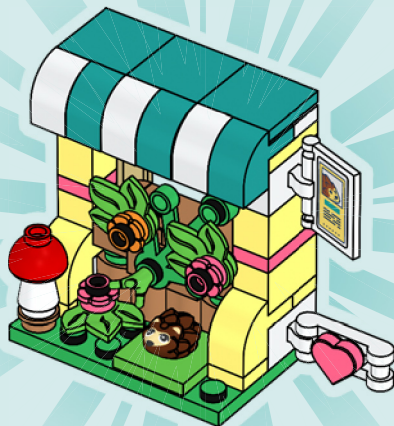

24

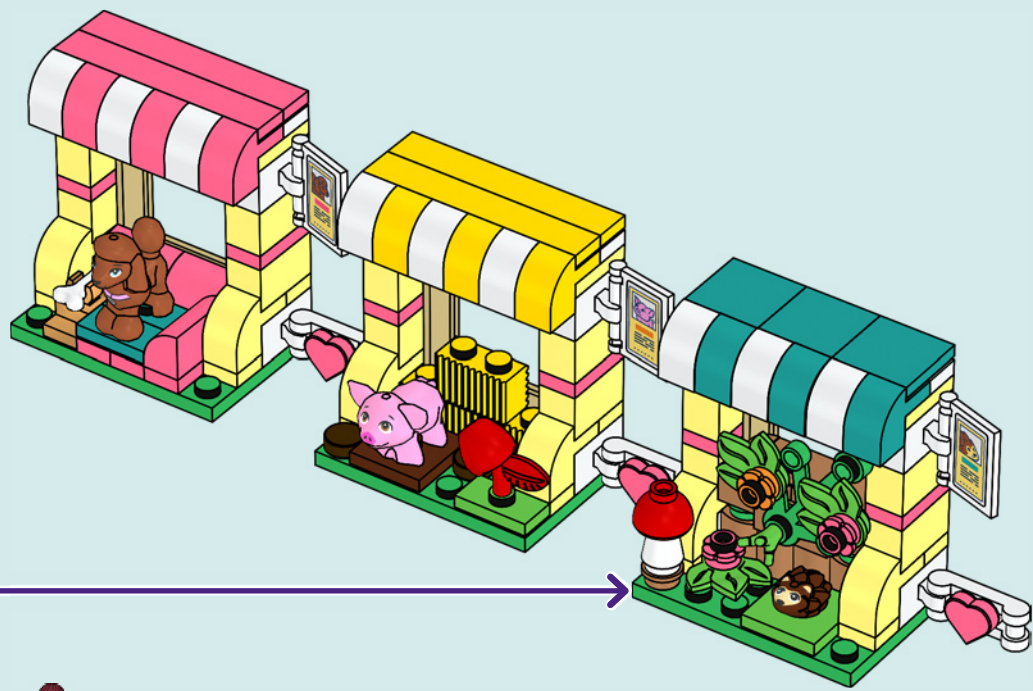

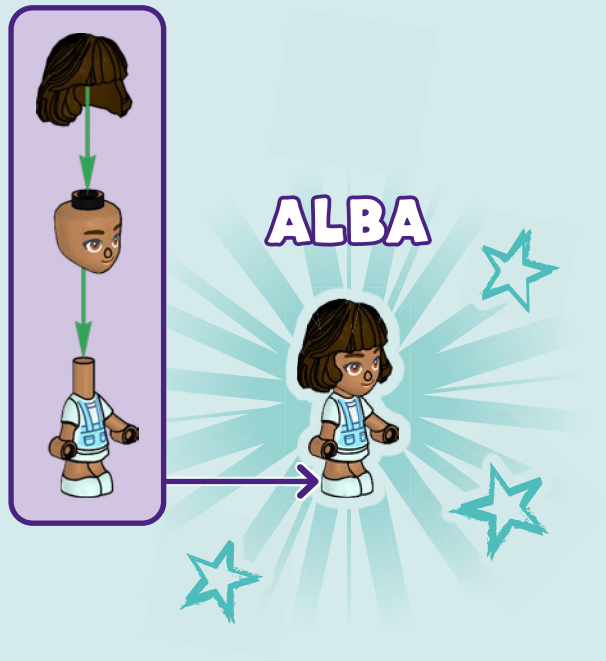



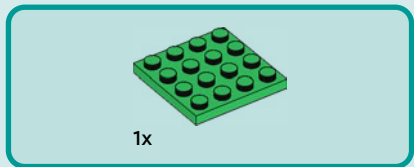
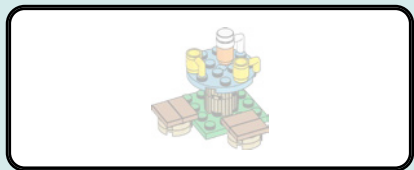

1

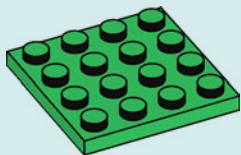

2

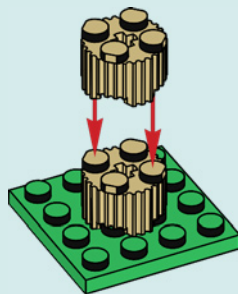

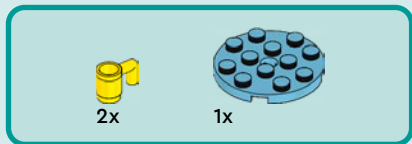

3

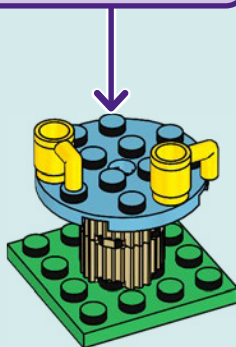
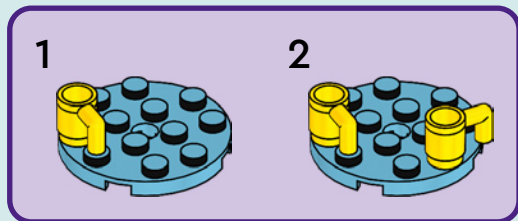

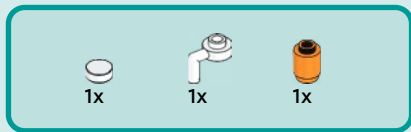

4

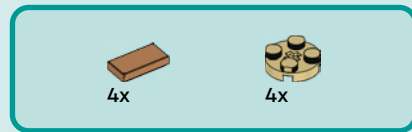
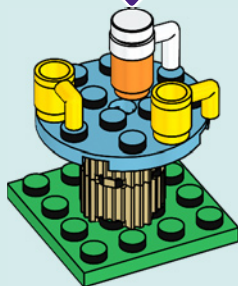
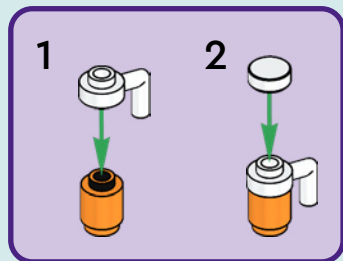

5

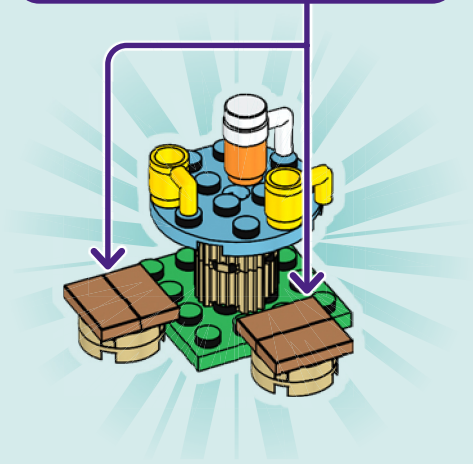
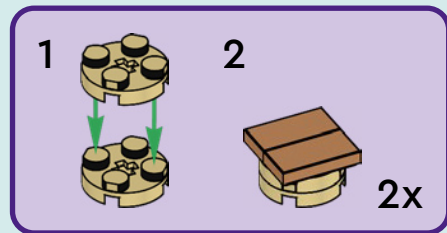

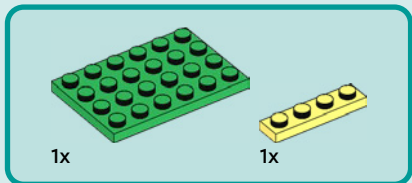
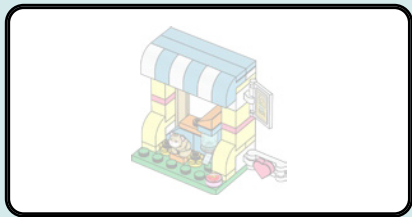

1

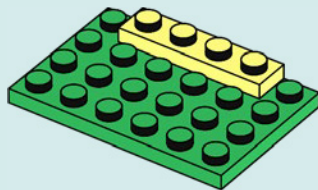



1x



2x

2

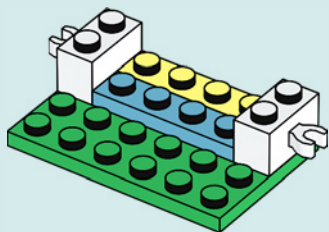

2x

3

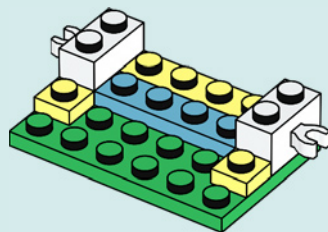



2x



1x



1x

4

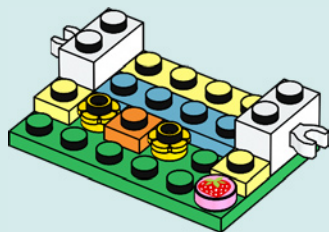

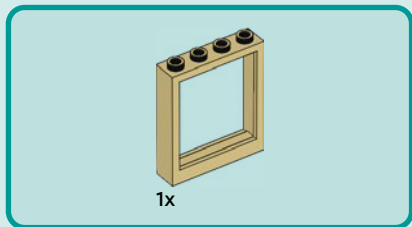

5

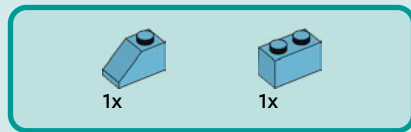
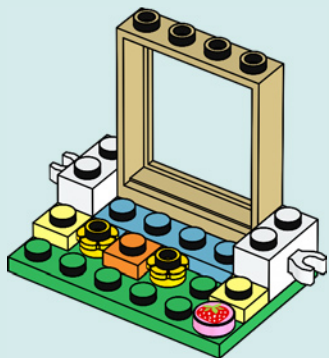

6

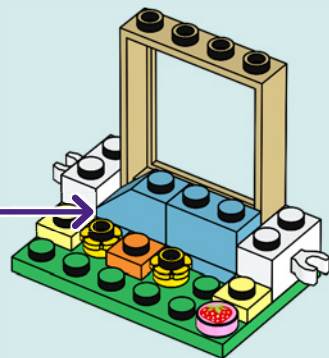
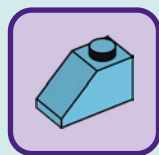



1x



1x

7

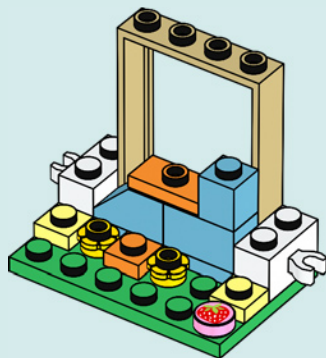





2x



2x

8



2x

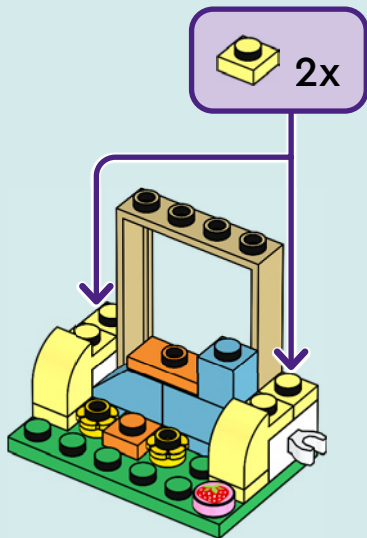



9

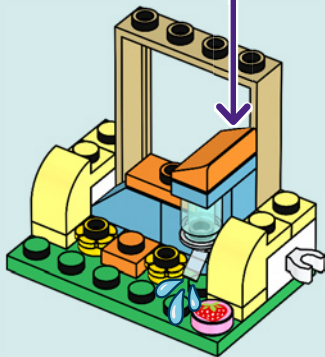
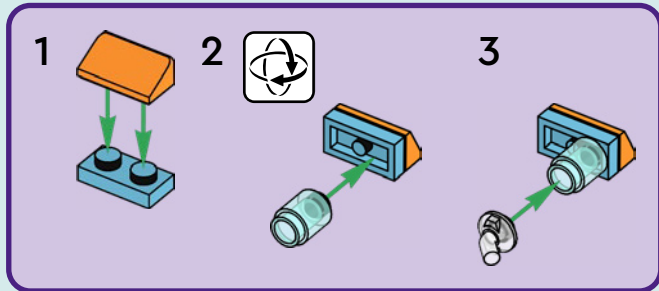



2x



4x

10

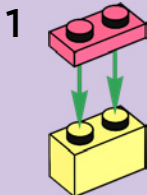

2x

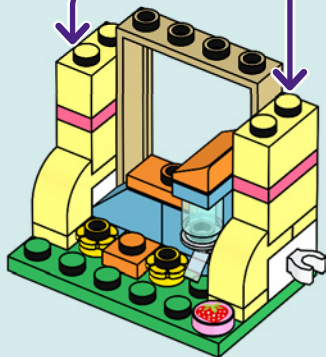

1x

11

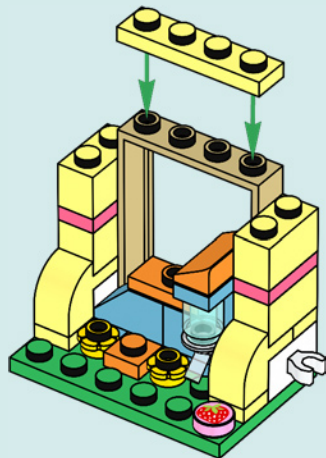



1x



1x

# 12

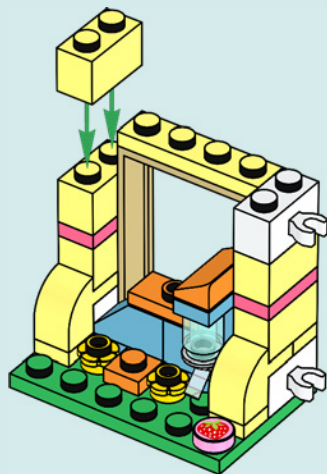

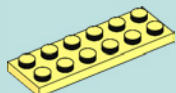

1x

13

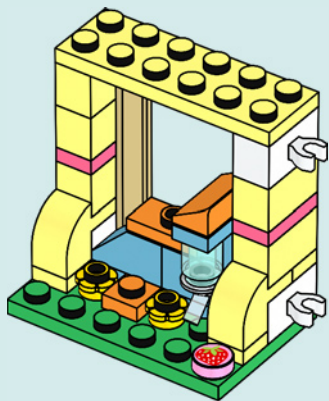

1x

14

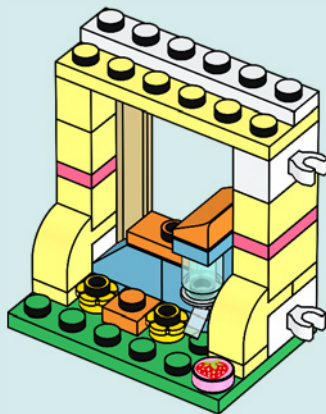



3x



3x

15

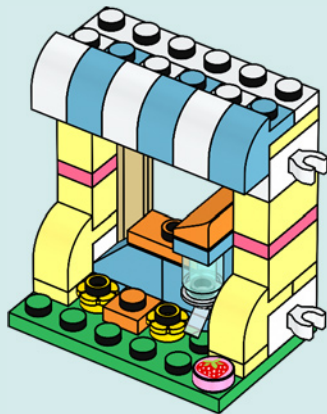

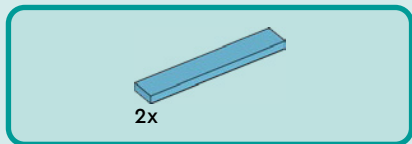

16

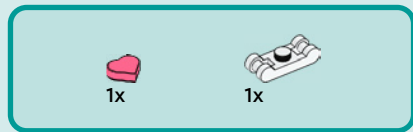
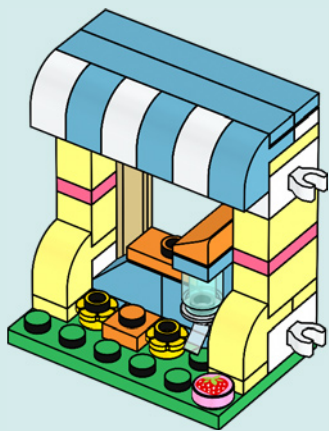

17

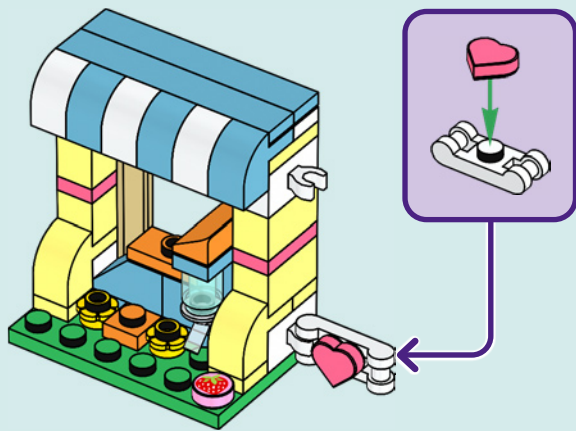



1x

18

1



2

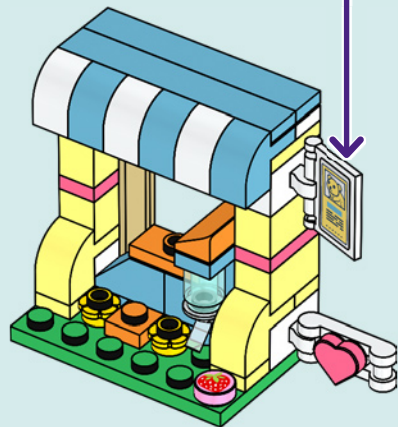

1x

19

JELLYBEAN

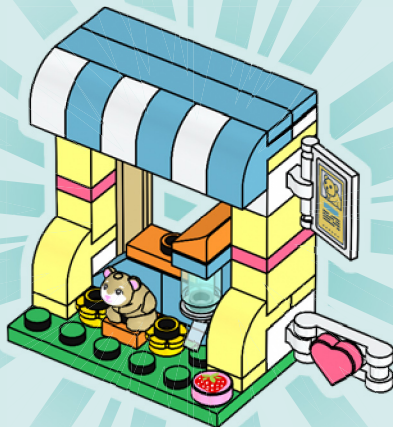



20

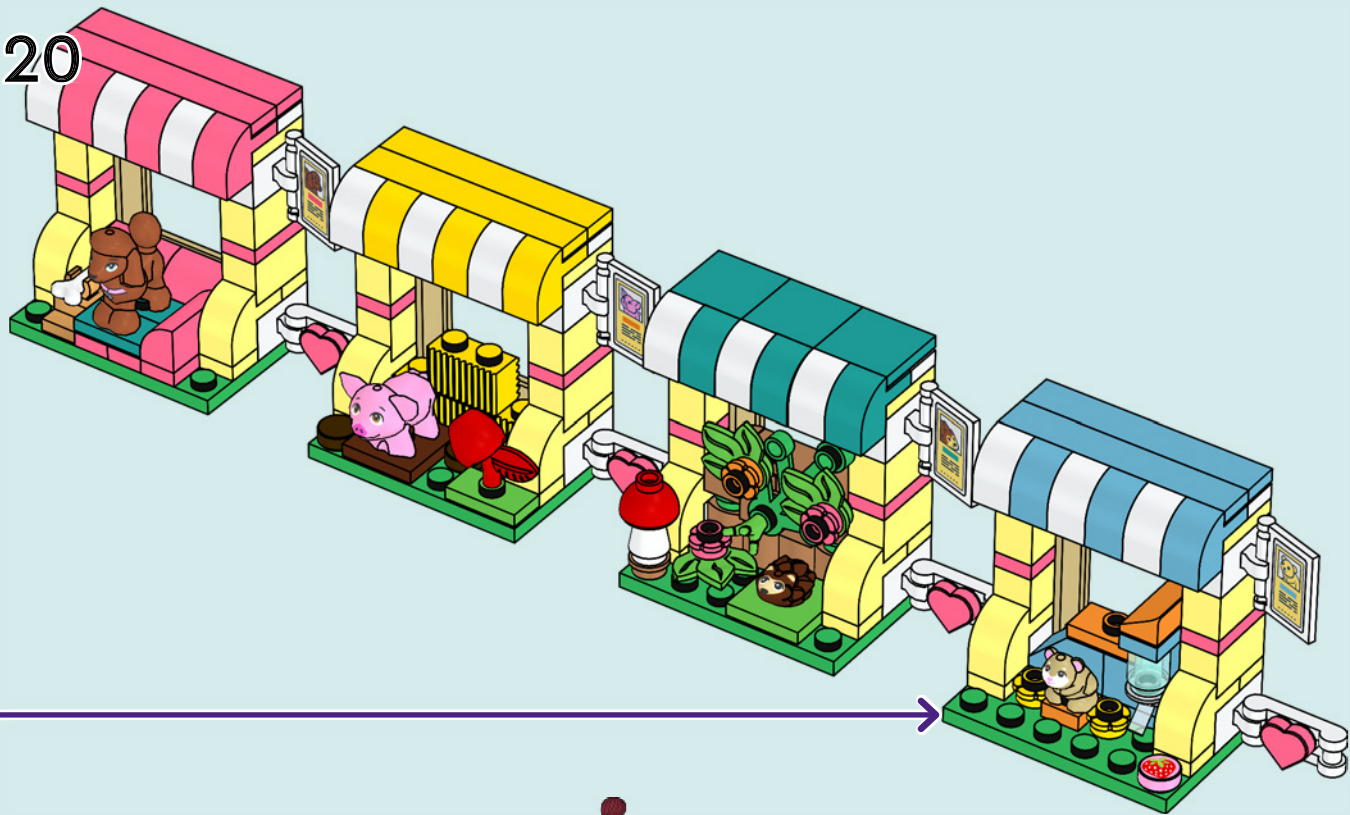

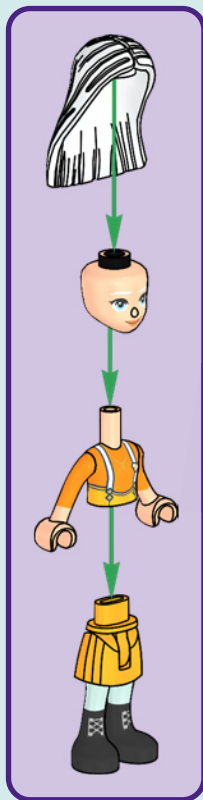

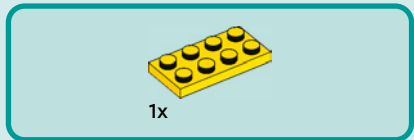
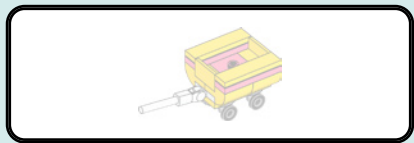

1

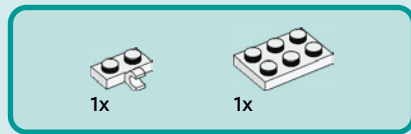
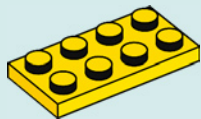

2

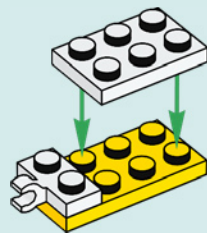



4x

3

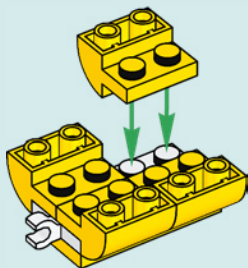



2x



1x

4

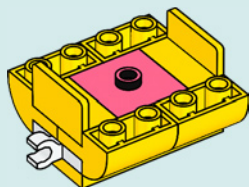

2x



2x

5

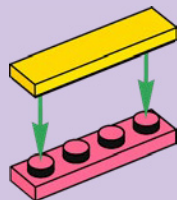
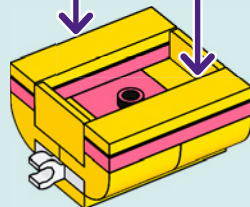

2x





2x

6

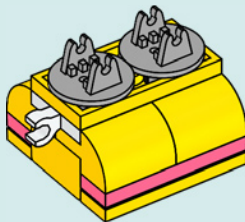



2x

7

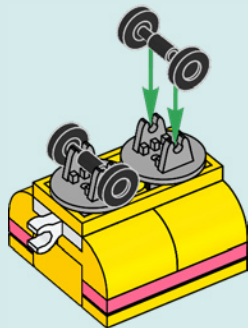

1x



1x

8

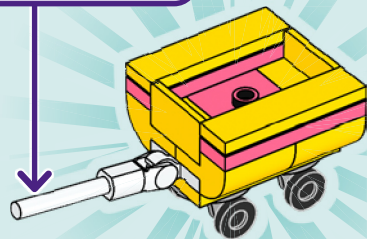
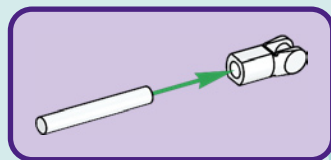

9

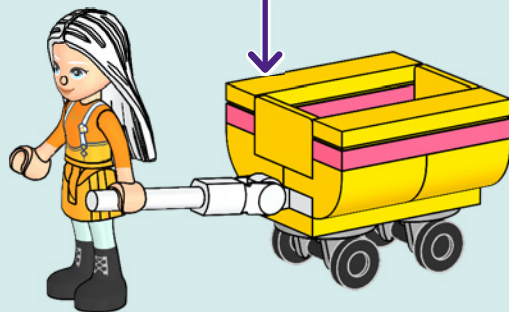



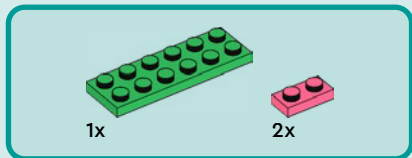
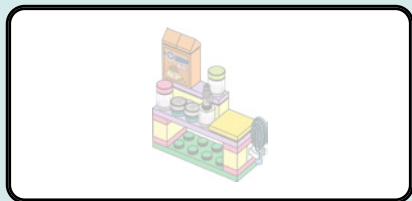

1

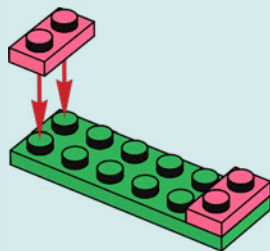

2

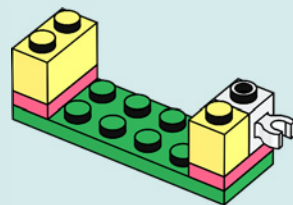



2x

3

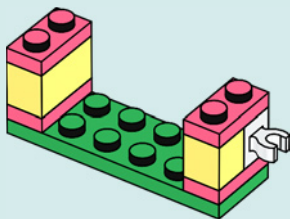

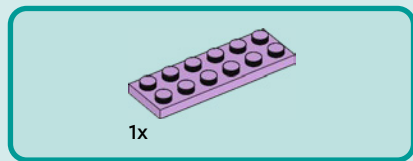

4

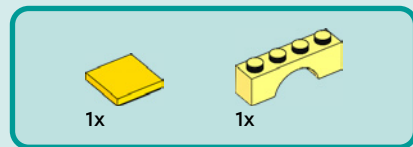
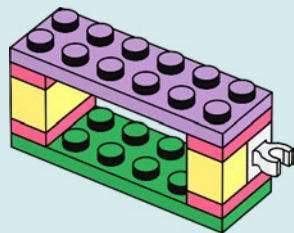

5

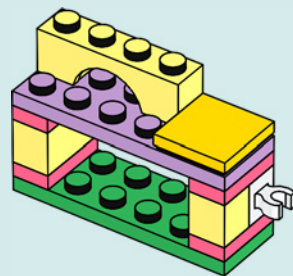



1x

6

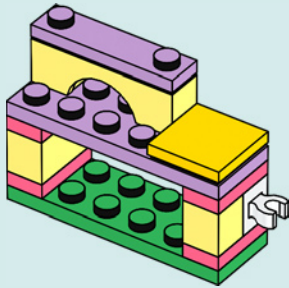

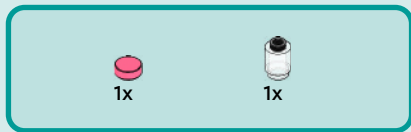

7

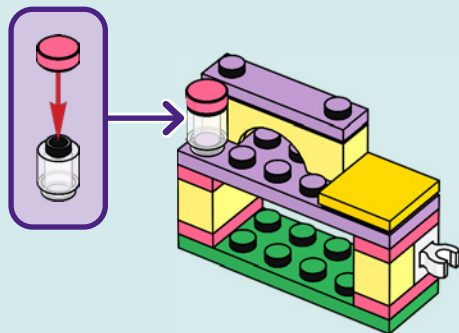

8

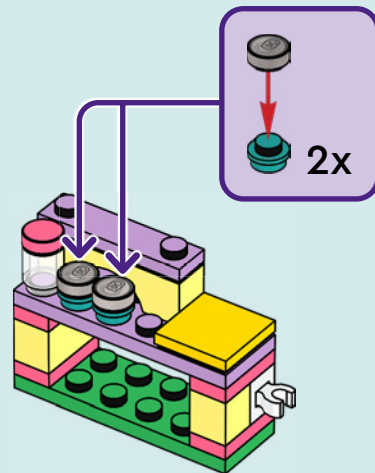



1x



1x

9

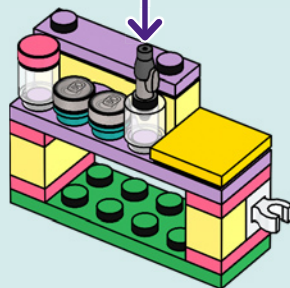
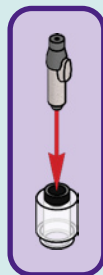



10

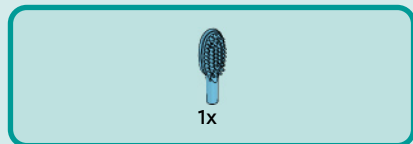
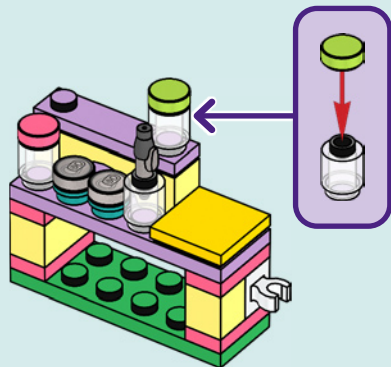

11



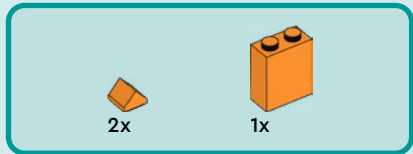

12

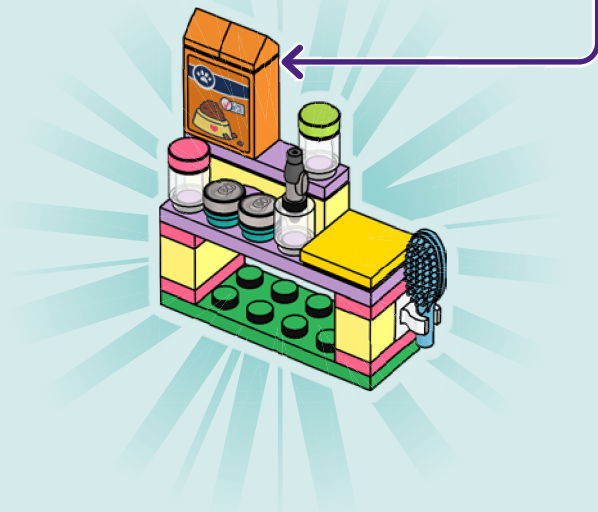
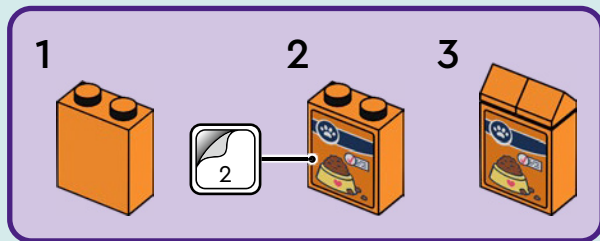



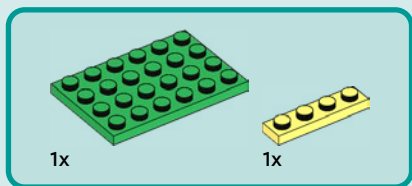

1

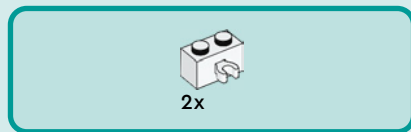
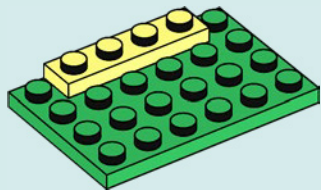

2

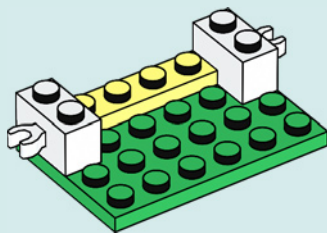



2x

3

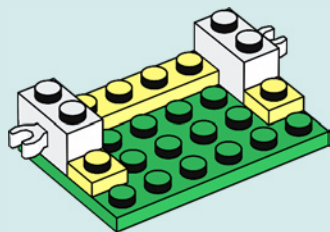



6x

4

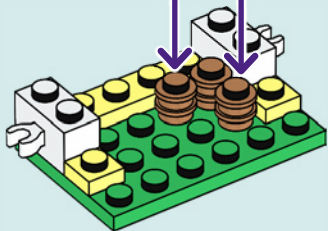
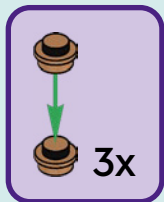

1x

5

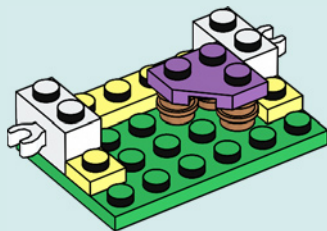

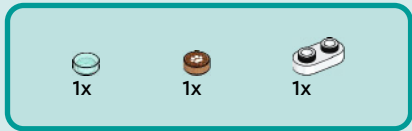

6

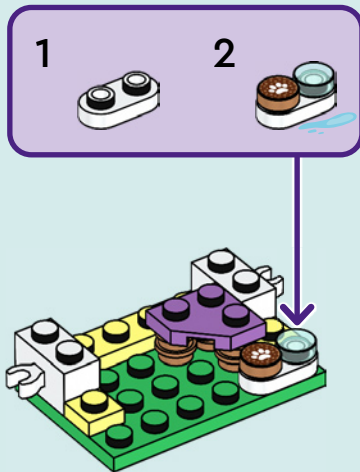



7

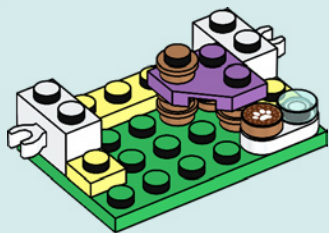

8

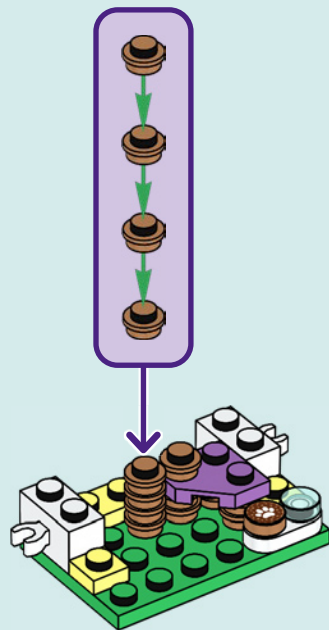



1x



1x

9

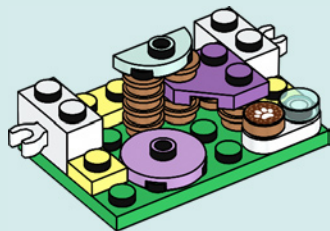



2x



2x

10

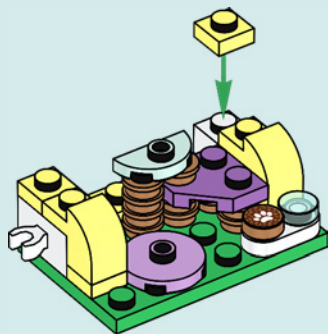

1x

11

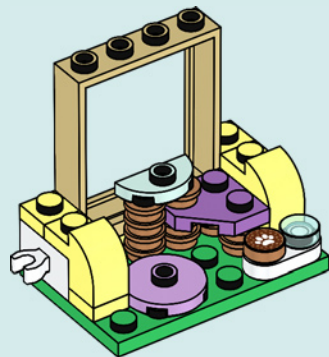



4x



2x

# 12

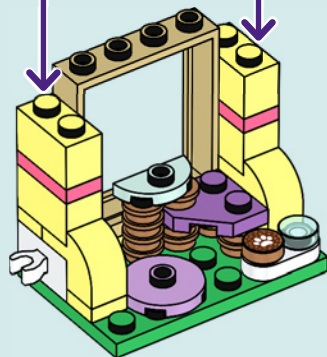
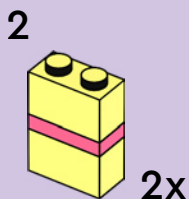
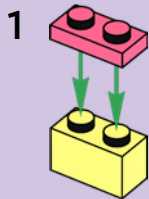





1x

13

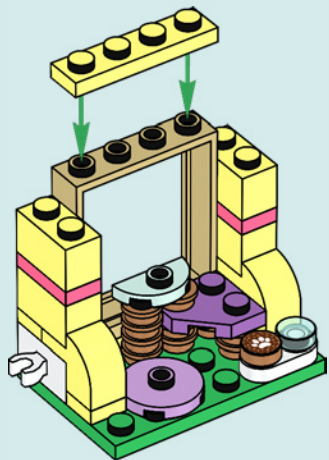

1x



1x

14

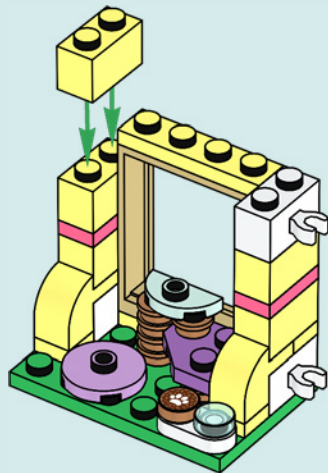

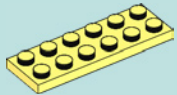

1x

15

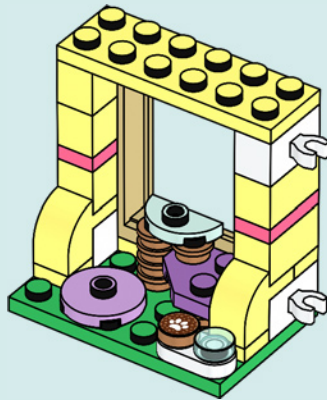

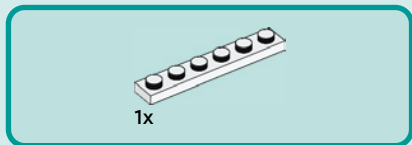

16

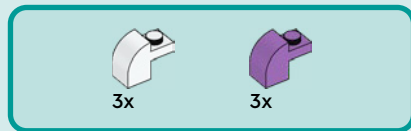
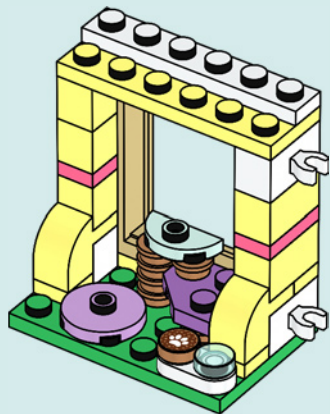

17

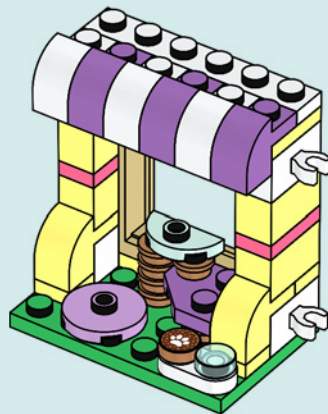



3x

18

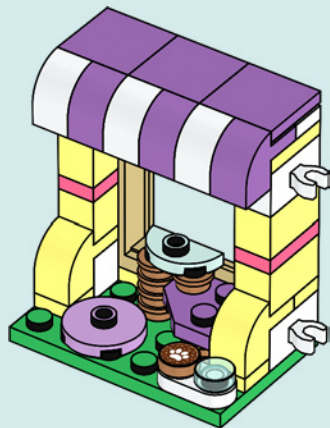



1x

19

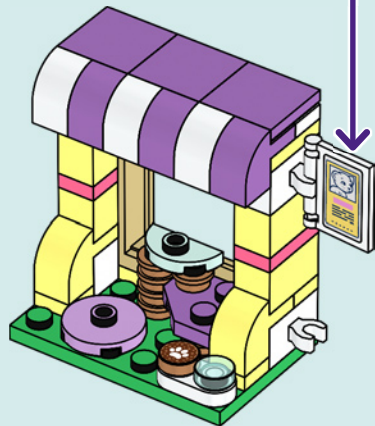
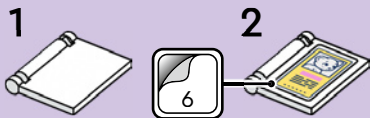

1x

20

**BELLA**



21

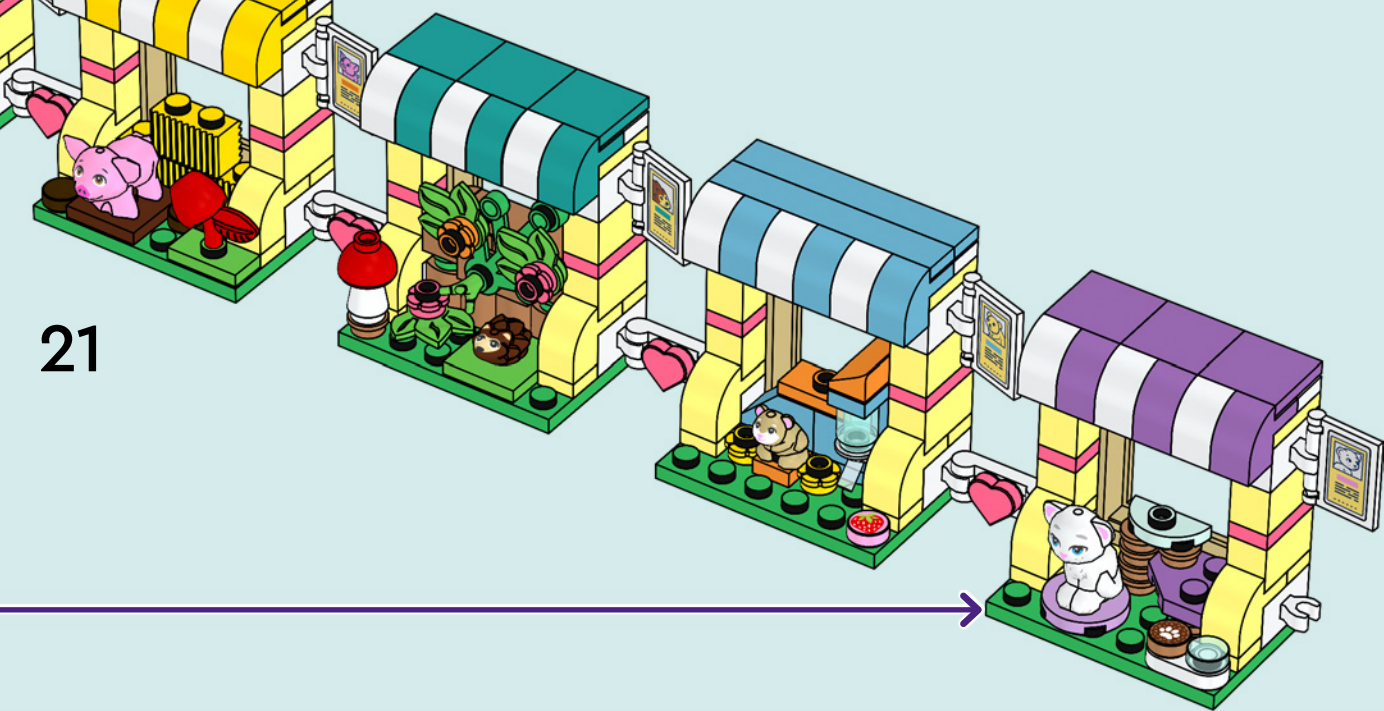



**LEGO** Friends





**LEGO** Friends

WATCH  
SERIES  
ONLINE

REGARDEZ  
LA SÉRIE  
EN LIGNE

MIRA  
LA SÉRIE  
EN INTERNET



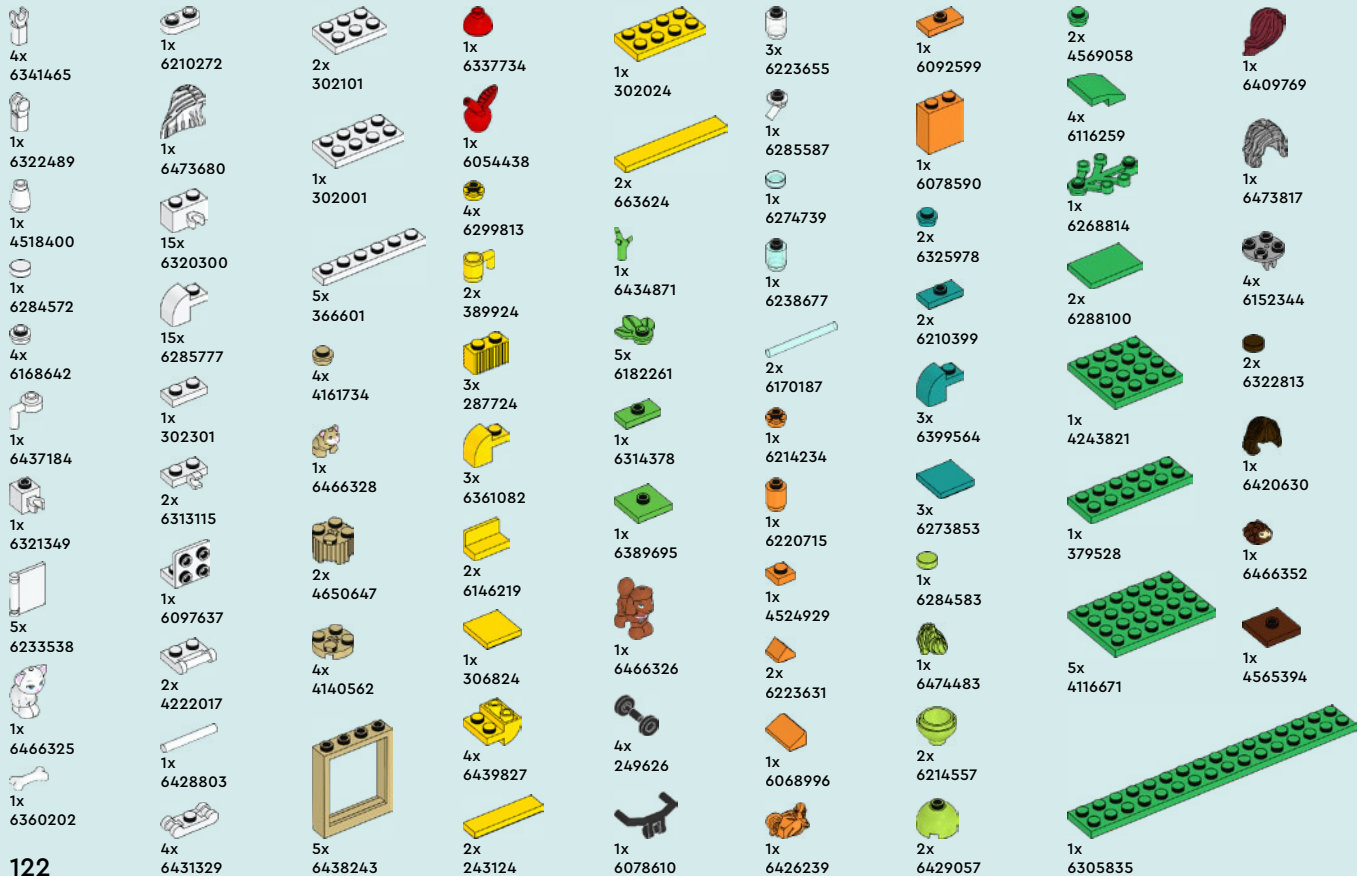

12x 6167641  
1x 6287856  
1x 6466329  
1x 6466316  
1x 6473714  
1x 6466330  
5x 6021997  
1x 6401015  
2x 6360296  
1x 4651232

1x 6416675  
1x 6416490  
1x 6466321  
1x 6474998  
1x 6469304  
1x 6466322  
1x 6466327  
1x 6287844  
1x 6466319  
1x 6473904

1x 6473920  
1x 6058368  
1x 4619652  
2x 6132411  
2x 6429058  
2x 6092674  
1x 6097419  
1x 4619655  
3x 6335566

2x 6146228  
1x 6248486  
1x 6070757  
2x 6185309  
1x 6102828  
1x 6474067  
1x 6440456  
1x 6416452

1x 6262138  
1x 6092594  
2x 6258883  
2x 6322904  
1x 6446980  
20x 6058014  
1x 6022084  
28x 6022083  
10x 6411364  
10x 6248756

1x 6250076  
1x 6296524  
5x 6175294  
1x 6471726  
4x 6289285  
1x 6424858  
3x 6411359  
3x 6173813

1x 6445946  
1x 6223598  
1x 6469473  
4x 6170322  
2x 6112964  
1x 6405554  
1x 6334047

4x 6295242  
1x 6311436  
4x 6488474  
5x 6471115  
3x 6261293  
22x 6258094

1x 6287638  
3x 6258095  
2x 6425367

 [LEGO.com/service](https://www.LEGO.com/service)



YOU COULD  
**WIN**



Scan this QR code or go to  
**LEGO.COM/PRODUCTFEEDBACK** and give  
us your short feedback about this LEGO® set  
for a chance to win a cool LEGO prize.

Terms and Conditions apply\*

**EN: YOU COULD WIN.** Terms and Conditions apply\* **DE: Du könntest GEWINNEN.** Es gelten die Teilnahmebedingungen\* **FR: Tu pourrais GAGNER.** Des conditions s'appliquent\* **IT: Potresti VINCERE tu.** Termini e condizioni sono applicabili\* **ES: Puedes GANAR.** Aplican términos y condiciones\* **PT: Poderá GANHAR.** Aplicam-se termos e condições\* **ZH: 轻松获奖. 条款和条件适用\*** **PL: Szansa na WYGRANĄ.** Obowiązują warunki korzystania\* **CS: Máte šanci VYHRÁT.** Platí všeobecné smluvní podmínky\* **SK: Máte šancu VYHRAŤ.** Platia všeobecné zmluvné podmienky\* **HU: TE IS NYERHETSZ.** Felhasználási feltételek érvényesek\* **RO: Ai putea CÂȘTIGA.** Se aplică termenii și condiții\* **BG: Можете да СПЕЧЕЛИТЕ.** Има определени правила и условия\* **LV: Tu vari LAIMĒT.** Ir spēkā noteikumi un nosacījumi.\* **ET: Sul on võimalus VÕITA.** Kehtivad tingimused\* **LT: Jūs galite LAIMĖTI.** Taikomos sąlygos\*

\*[LEGO.com/productfeedback-terms](https://www.lego.com/productfeedback-terms)