



Friends

42623



Q LEGO® Builder



LEGO.com/sustainable-packaging



FR
DONNEZ
OU
RECYCLEZ

 OU  OU 

ASSOCIATION MAGASIN DÉCHÈTERIE

Adresses sur quefairedemesdechets.fr



Q LEGO® Builder

BUILDER



Apple and the Apple logo are trademarks of Apple Inc., registered in the U.S. and other countries and regions. App Store is a service mark of Apple Inc. Google Play and the Google Play logo are trademarks of Google LLC. Tencent and the Tencent logo are trademarks of Tencent Inc.

Q [LEGO.com/devicecheck](https://www.lego.com/devicecheck)

EN Ask parents' permission before going online | **DE** Eltern um Erlaubnis bitten, bevor du online gehst | **FR** Demande l'autorisation d'un parent avant d'aller en ligne | **IT** Chiedi il permesso ai tuoi genitori prima di andare online | **ES** Pídeles permiso a tus papás antes de conectarte a Internet | **PT** pede autorização aos pais antes de acederes online | **ZH** 上网前应先征得父母的同意 | **PL** Poproś rodziców o zgodę, zanim wejdiesz do Internetu | **CS** Než půjdeš na internet, požádej rodiče o svolení | **SK** Skôr než pôjdeš na internet, vypýtaj si povolenie od rodičov | **HU** Kérj szülői engedélyt, mielőtt online csatlakoznál! | **RO** Cere permisiunea părinților înainte de a te conecta online | **BG** Поискайте разрешение от родител, преди да влезете онлайн | **LV** Pirms došanās tiešsaistē palūdz atļauju vecākiem | **ET** Enne Interneti kasutamist küsi vanematelt luba | **LT** Prieš prisijungdami prie interneto, atsiklauskite tėvų





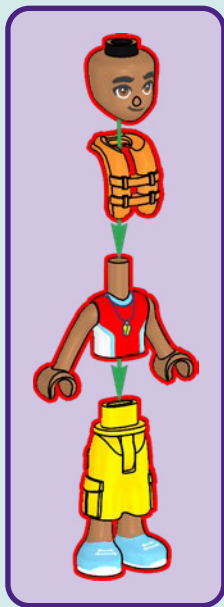

LEO



CANDI

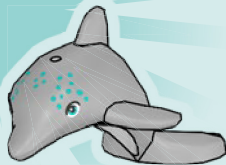

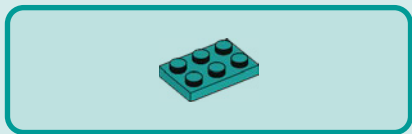

1

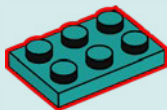

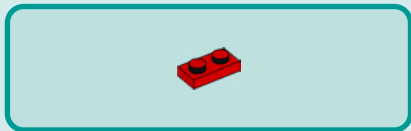

2

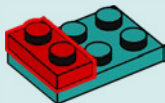

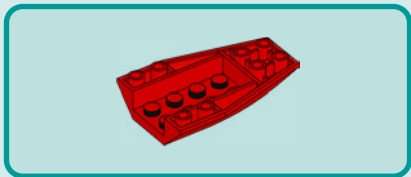

3

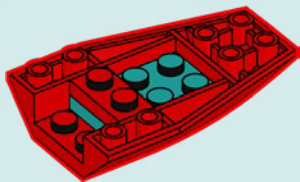

10



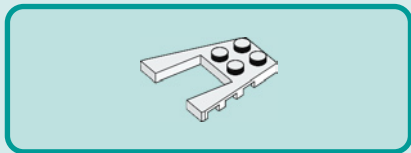

4

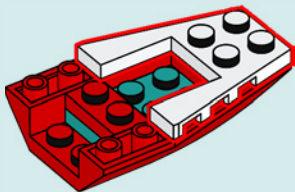

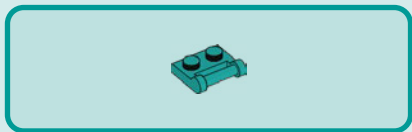

5

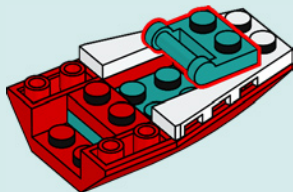



6

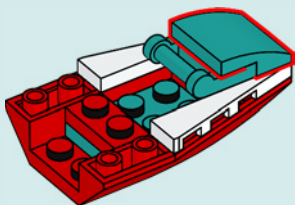

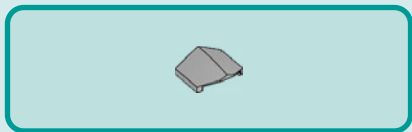

7

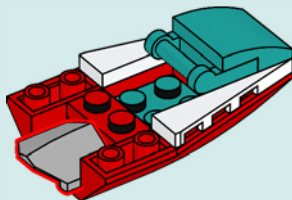

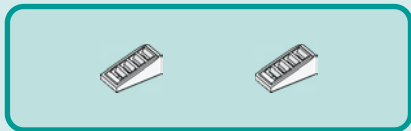

8

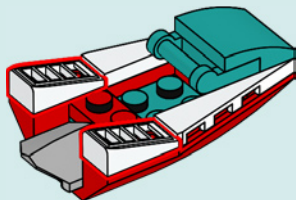



9

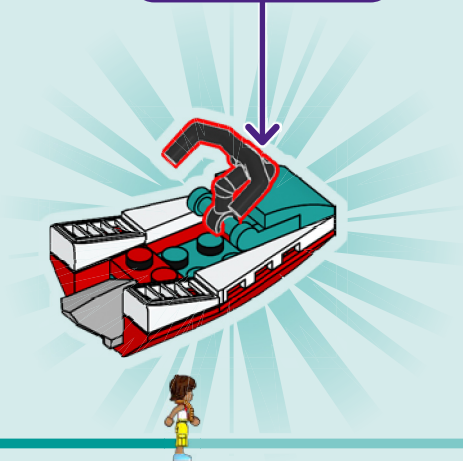
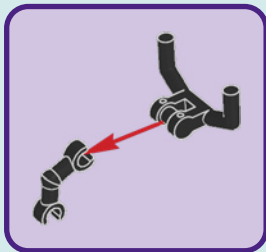



1



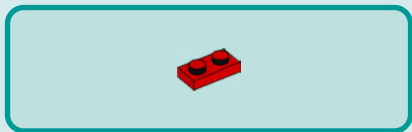

2

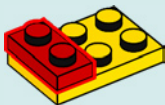

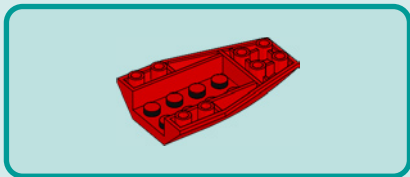

3

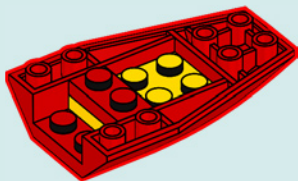

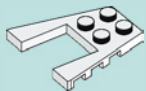

4

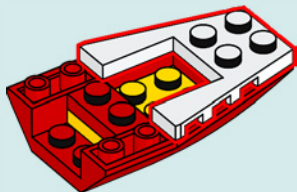



5

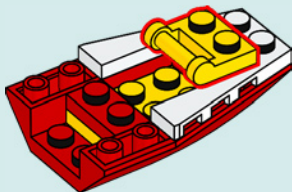



6

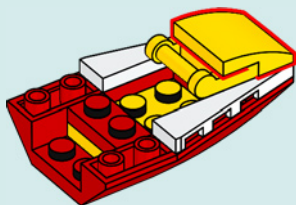



7

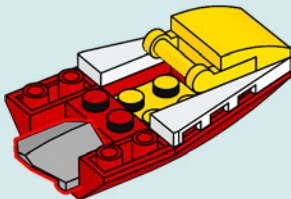



8

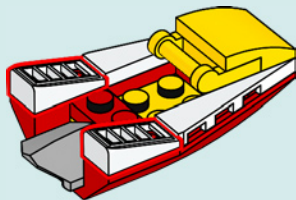



9

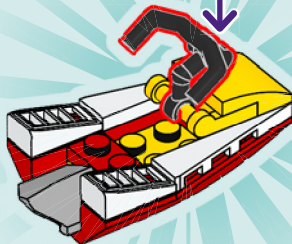
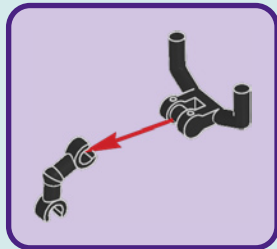



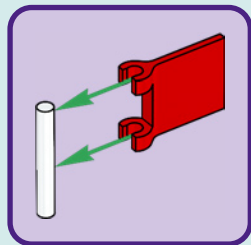
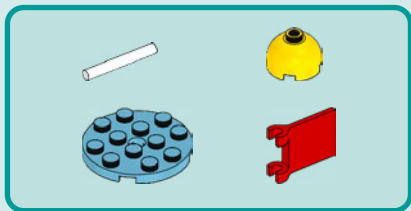

1



2



3



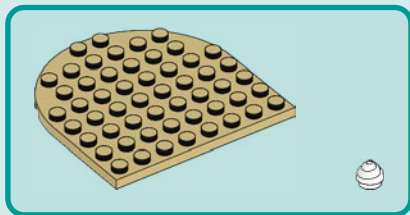
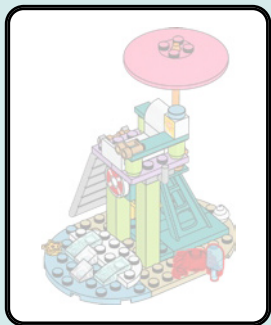

1

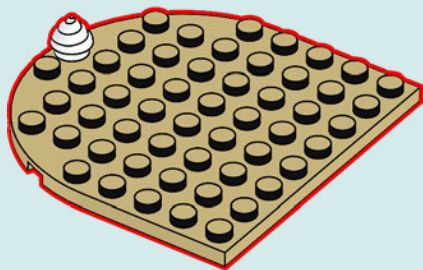

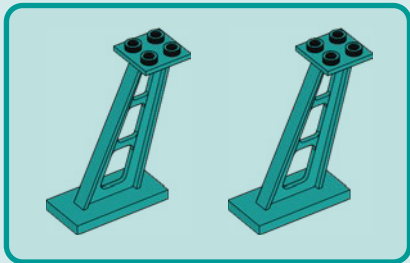

2

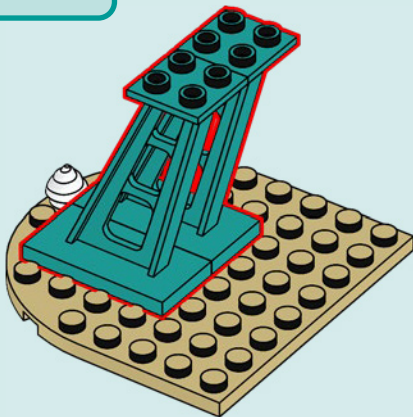



3

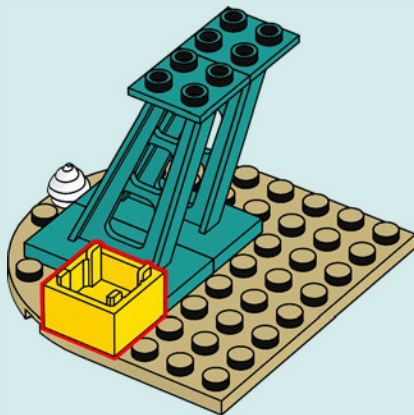

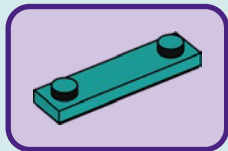
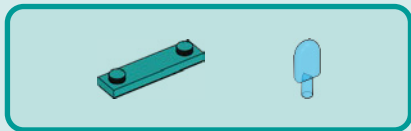

4

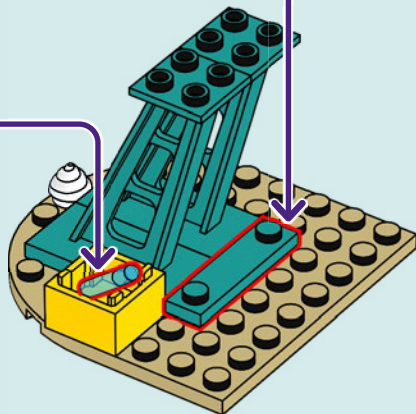
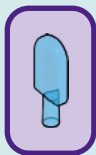



5

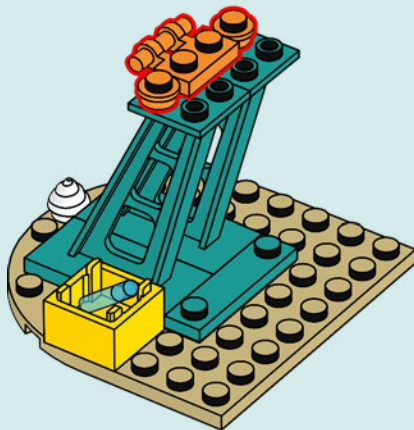



6

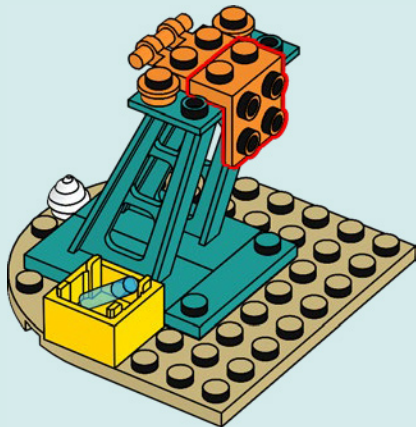

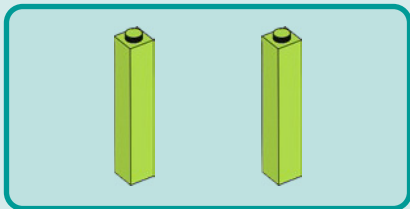

7

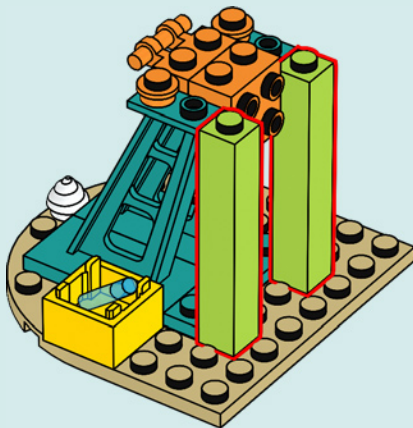



8

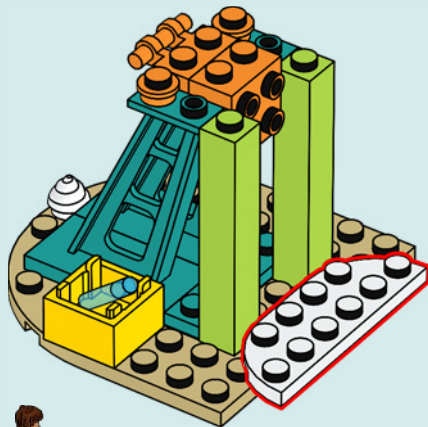

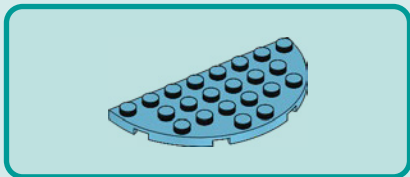

9

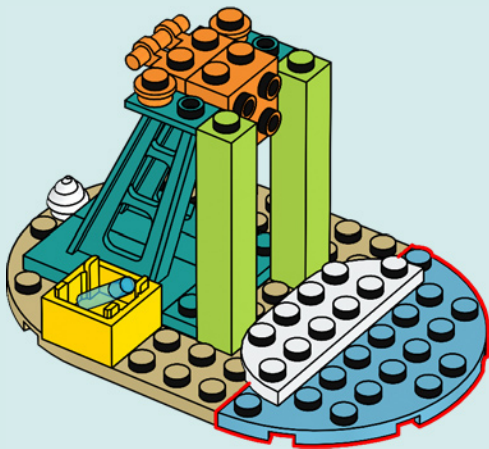



10





11

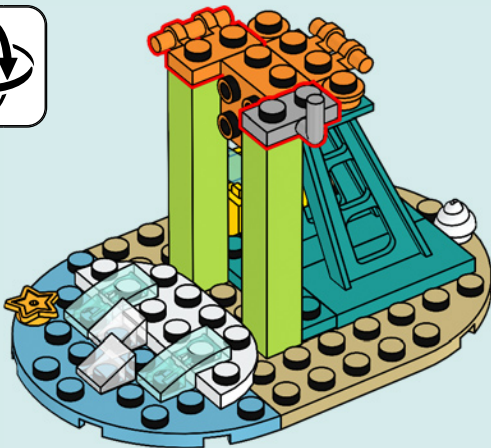
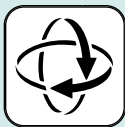

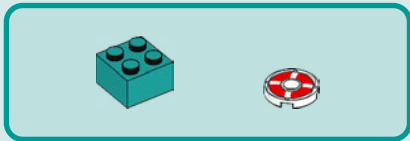

12

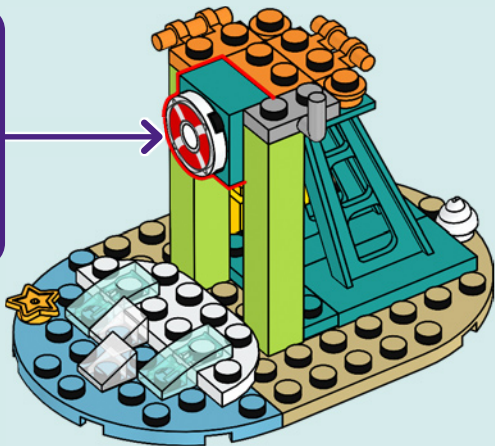
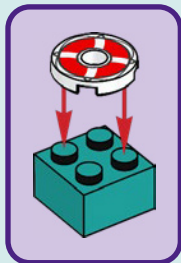

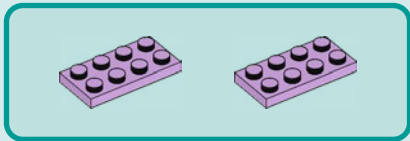

13

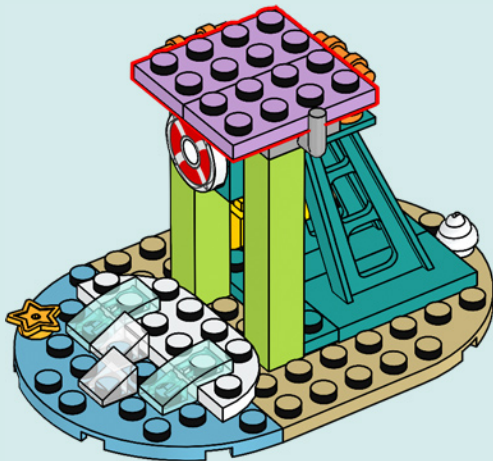



14

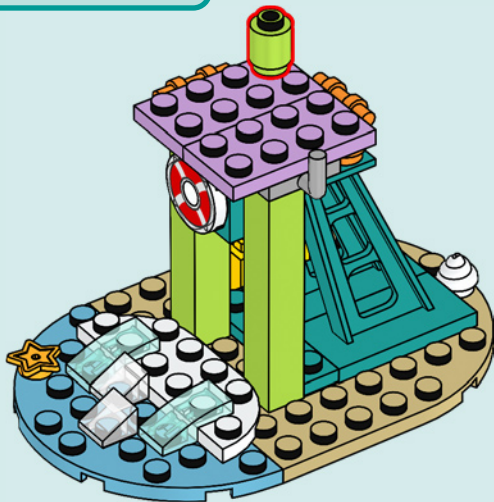

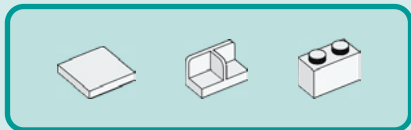

15

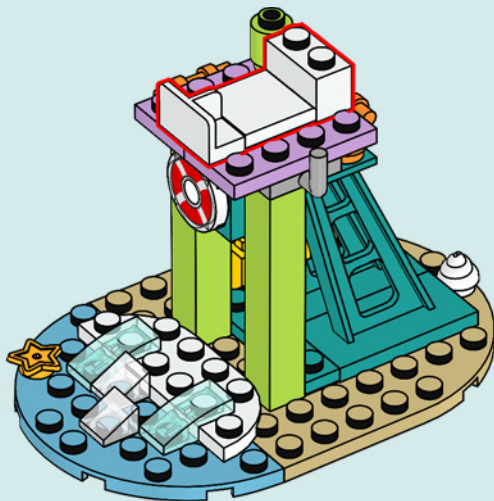



16

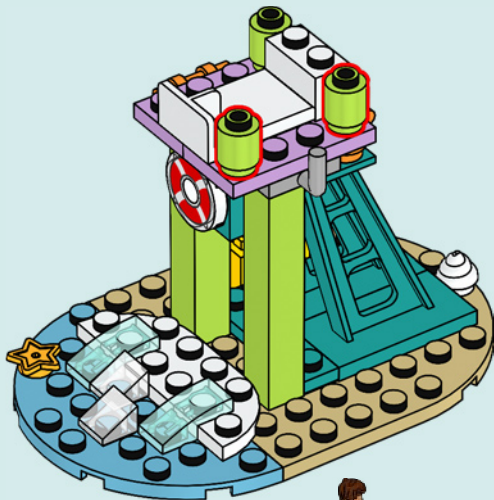

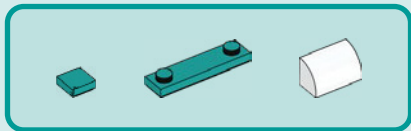

17

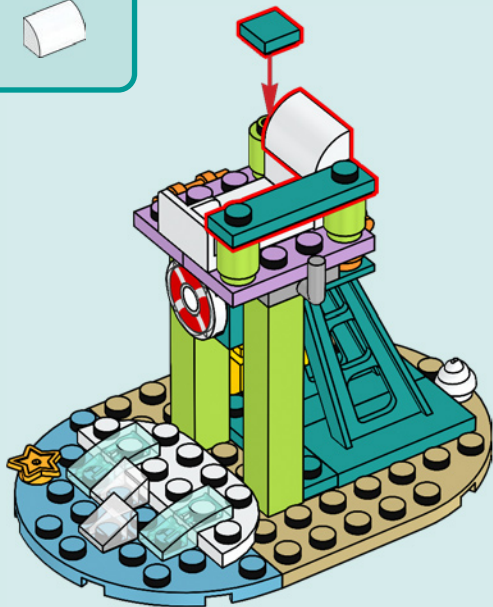



18

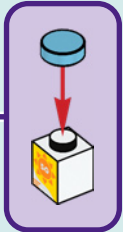
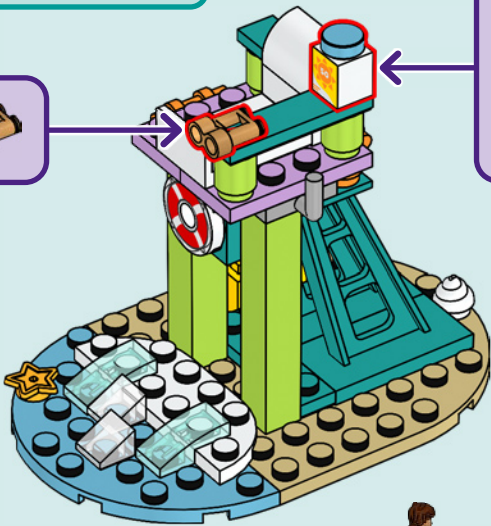

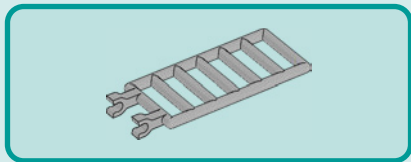

19

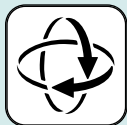

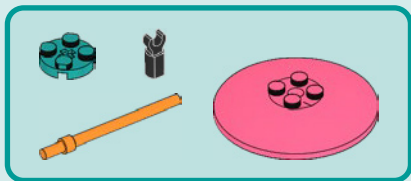
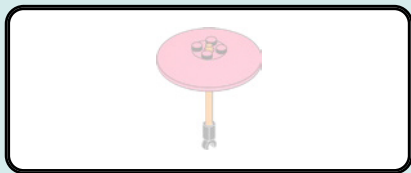

20

1

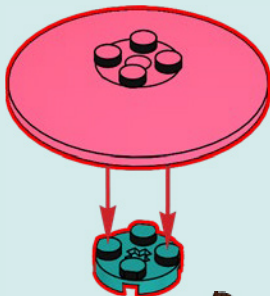

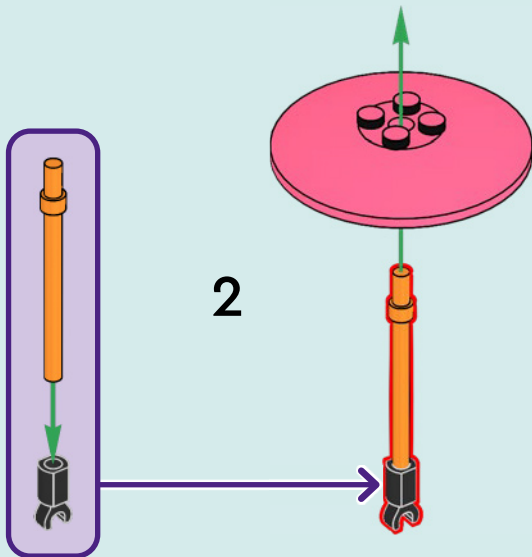

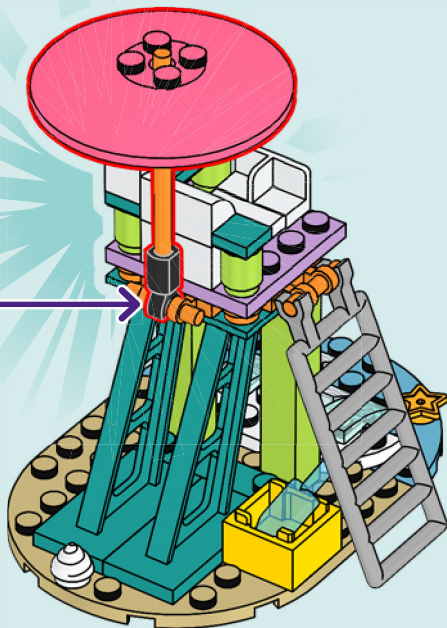



21

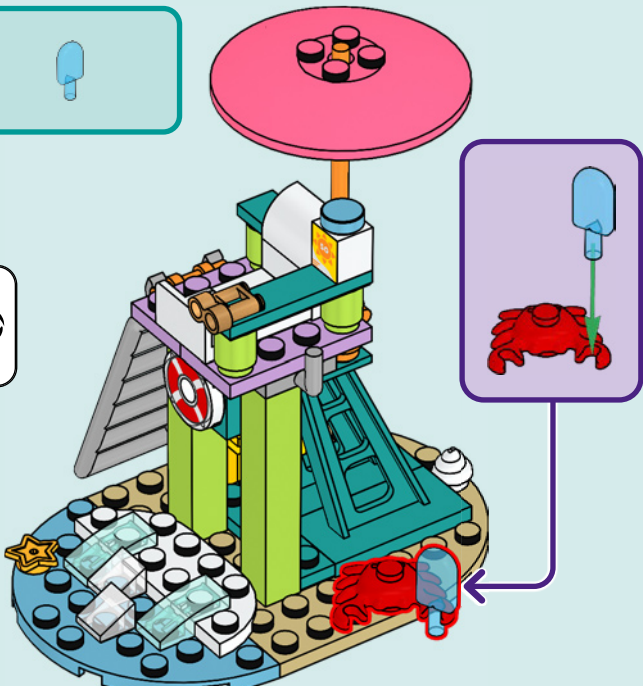





Friends

WATCH SERIES ONLINE

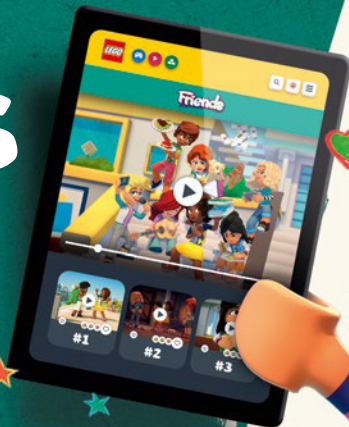

WATCH SERIES ONLINE / SCHAU DIR DIE SERIE ONLINE AN /
REGARDE LA SÉRIE EN LIGNE / GUARDA LA SERIE ONLINE / MIRA
LA SERIE EN INTERNET / ASSISTIR À SÉRIE ONLINE / 在线观看 /
OGLĄDAJ SERIAL W INTERNECIE / SLEDUJ SERIÁL ONLINE / POZRI
SI SERIÁL ONLINE / NÉZD A SOROZATOT ONLINE / VIZIONEAZĂ
SERIALUL ONLINE / ГЛЕДАЙТЕ СЕРИАЛА ОНЛАЙН / SKATIES SERIĀLU
TIEŠŠAISTĒ / VAATA SARJA VEEBIST / ŽIŪRĒK SERIALĀ INTERNETU



LEGO Friends



42624



42630



42618



42622



42631



1x
6186681



1x
6438901



1x
6435173



1x
6476635



1x
300401



1x
6248827



1x
6093479



4x
6023804



1x
6428803



1x
306801

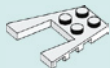

2x
6275403



1x
6147792

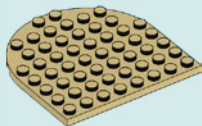

1x
6249092



2x
302321



1x
6365459



1x
6253363



2x
6096487



1x
6430246



1x
6429054



1x
4501232



1x
6383172



1x
6079007



1x
302124



1x
6315887



2x
6326681



2x
6078610



1x
6510728



2x
6245250



1x
6238677



2x
6508249



2x
6267057



2x
4157103



2x
6136310



1x
6117969



2x
4190164



1x
6472965



1x
6213782



1x
6210400



1x
6210775



1x
6314091



1x
6223665



1x
6249417



2x
6478819



2x
6250120



3x
4212454



2x
6377003



1x
6432033



1x
6424457



1x
6261353



2x
6507810



1x
6476634

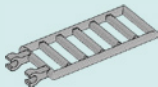

1x
6509831



1x
6468511



1x
6034543



1x
6416551



1x
6483445



2x
6099355



1x
6322819



1x
6102828



1x
6138571



1x
6465576



1x
6483442



1x
6428824



 [LEGO.com/service](https://www.LEGO.com/service)

YOU COULD

WIN



Scan this QR code or go to
LEGO.COM/PRODUCTFEEDBACK and give us
your short feedback about this LEGO® set
for a chance to win a cool LEGO prize.

Terms and Conditions apply*

EN: YOU COULD WIN. Terms and Conditions apply* **DE: Du könntest GEWINNEN.** Es gelten die Teilnahmebedingungen* **FR: Tu pourrais GAGNER.** Des conditions s'appliquent* **IT: Potresti VINCERE tu.** Termini e condizioni sono applicabili* **ES: Puedes GANAR.** Aplican términos y condiciones* **PT: Poderá GANHAR.** Aplicam-se termos e condições* **ZH: 轻松获奖.** 条款和条件适用* **PL: Szansa na WYGRANĄ.** Obowiązują warunki korzystania* **CS: Máte šanci VYHRÁT.** Platí všeobecné smluvní podmínky* **SK: Máte šancu VYHRÁT.** Platia všeobecné zmluvné podmienky* **HU: TE IS NYERHETSZ.** Felhasználási feltételek érvényesek* **RO: Ai putea CÂȘTIGA.** Se aplică termenii și condiții* **BG: Можете да СПЕЧЕЛИТЕ.** Има определени правила и условия* **LV: Tu vari LAIMĒT.** Ir spēkā noteikumi un nosacījumi.* **ET: Sul on võimalus VÕITA.** Kehtivad tingimused* **LT: Jūs galite LAIMĖTI.** Taikomos sąlygos*

*[LEGO.com/productfeedback-terms](https://www.lego.com/productfeedback-terms)

LEGO, the LEGO logo and the Friends LOGO are trademarks of the LEGO Group.
©2024 The LEGO Group.

6521566