



# Disney

43231





FR  
**DONNEZ**  
OU  
**RECYCLEZ**



OU



OU



ASSOCIATION

MAGASIN

DÉCHÈTERIE

Adresses sur [quefairedemesdechets.fr](http://quefairedemesdechets.fr)



[LEGO.com/sustainable-packaging](http://LEGO.com/sustainable-packaging)



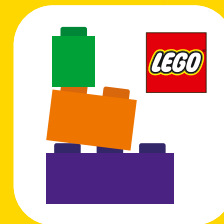

# BUILDER



Apple and the Apple logo are trademarks of Apple Inc., registered in the U.S. and other countries and regions. App Store is a service mark of Apple Inc. Google Play and the Google Play logo are trademarks of Google LLC. Tencent and the Tencent logo are trademarks of Tencent Inc.

[LEGO.com/devicecheck](https://www.lego.com/devicecheck)

**EN** Ask parents' permission before going online | **DE** Eltern um Erlaubnis bitten, bevor du online gehst | **FR** Demande l'autorisation d'un parent avant d'aller en ligne | **IT** Chiedi il permesso ai tuoi genitori prima di andare online | **ES** Pídeles permiso a tus papás antes de conectarte a Internet | **PT** Peça autorização aos pais antes de acederes online | **ZH** 上网前应先征得父母的同意 | **PL** Poproś rodziców o zgodę, zanim wejdiesz do Internetu | **CS** Než půjdeš na internet, požádej rodiče o svolení | **SK** Skôr než pôjdeš na internet, vypýtaj si povolenie od rodičov | **HU** Kérj szülői engedélyt, mielőtt online csatlakoznál! | **RO** Cere permisiunea părinților înainte de a te conecta online | **BG** Поискайте разрешение от родител, преди да влезете онлайн | **LV** Pirms došanās tiešsaistē palūdz atļauju vecākiem | **ET** Enne Interneti kasutamist küsi vanematelt luba | **LT** Prieš prisijungdami prie interneto, atskirkite tėvų

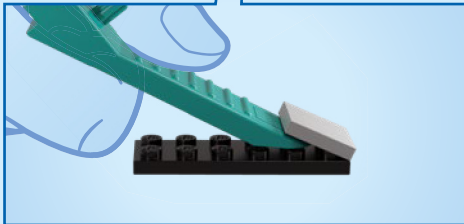
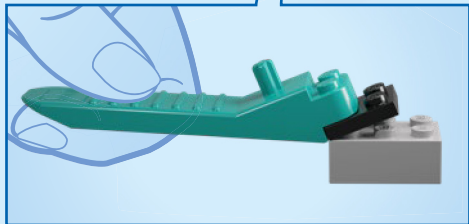
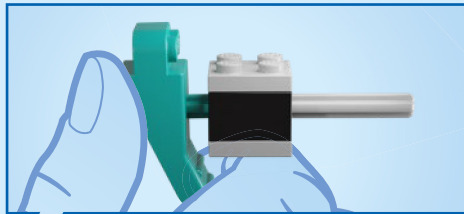
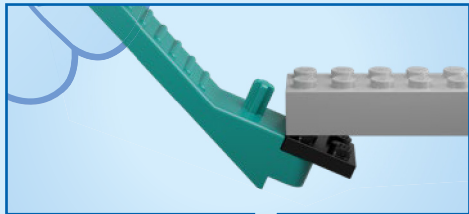

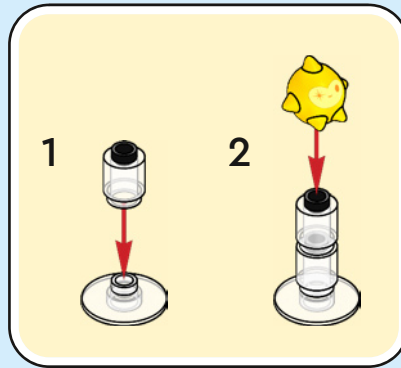
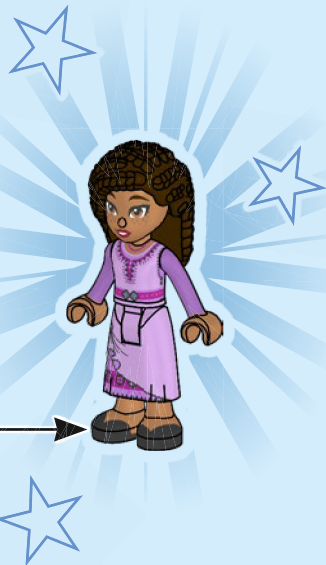
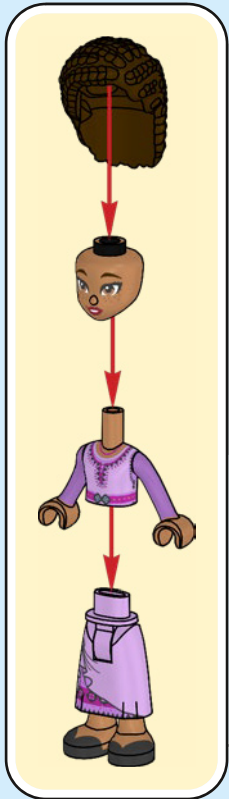



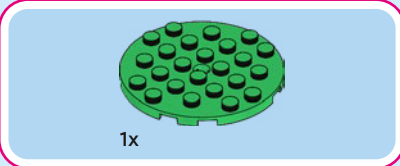

1

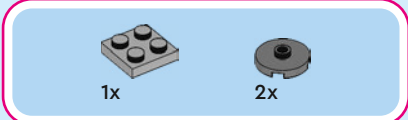
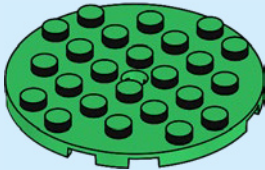

2

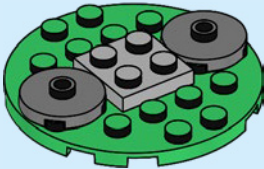

3

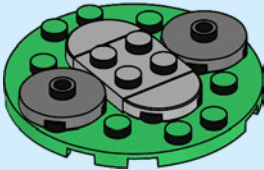

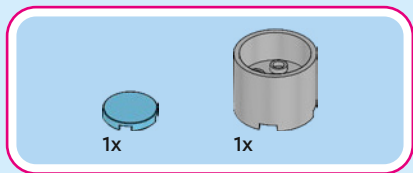

4

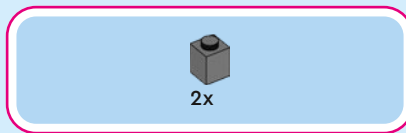
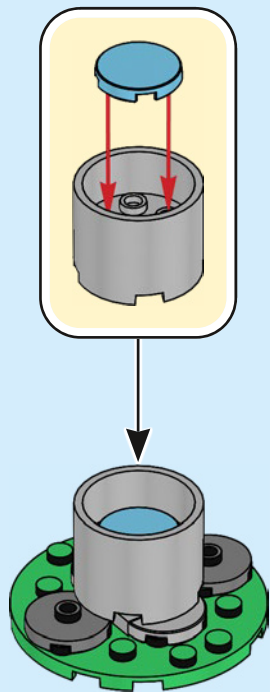

5

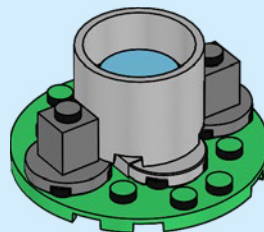

6

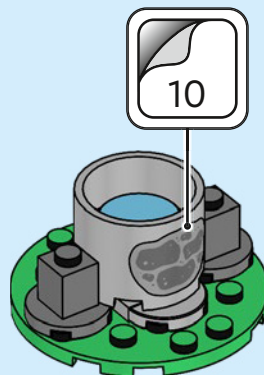

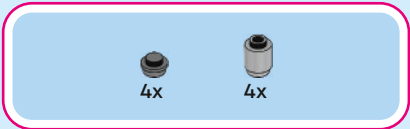

7

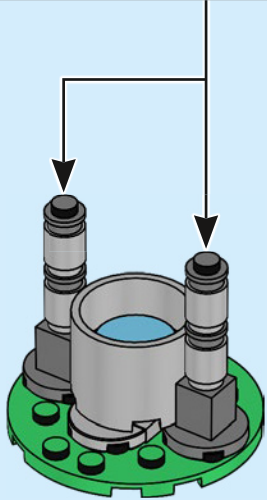
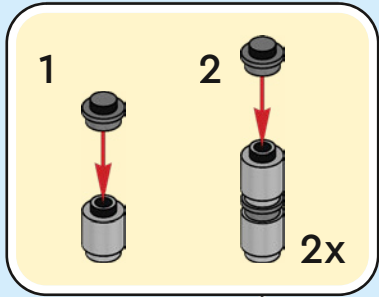

8

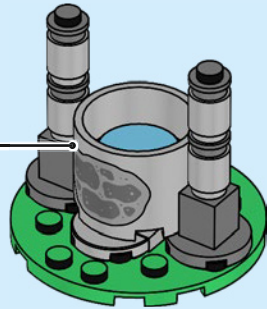



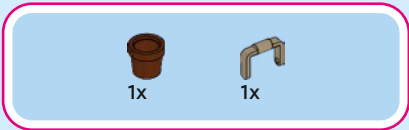

9

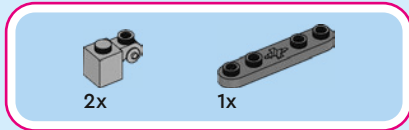
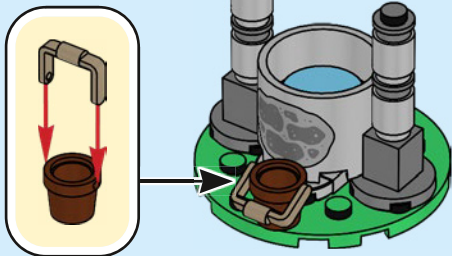

10

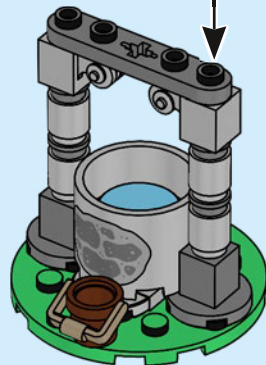
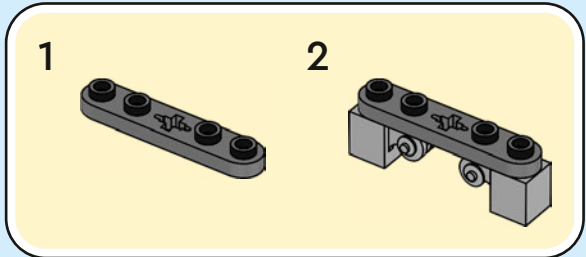

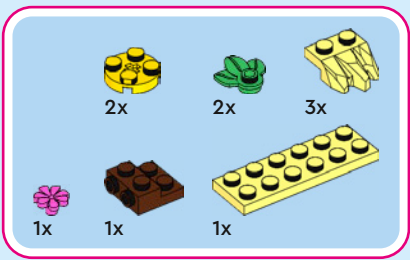

11

1

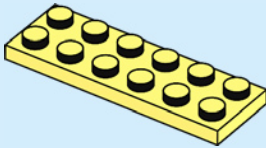

2

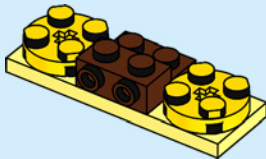

3

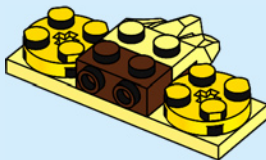

4

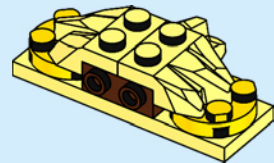

5

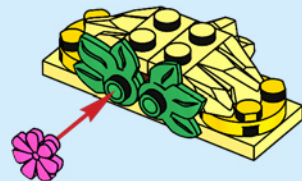

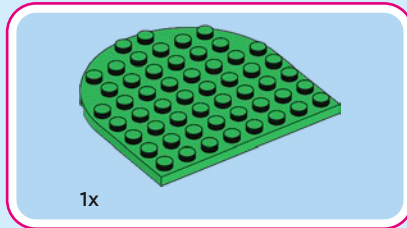
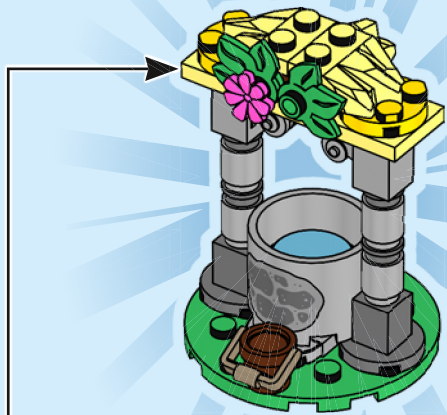

1

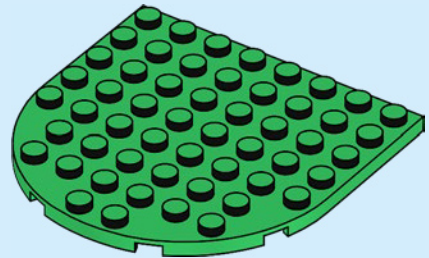





2x

2

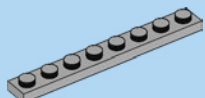
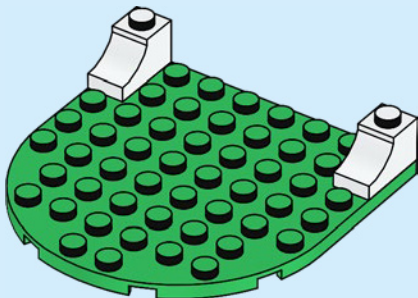

1x



2x

3

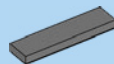
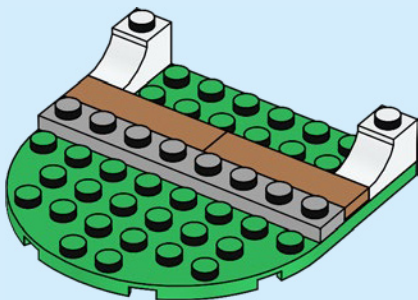

2x

4

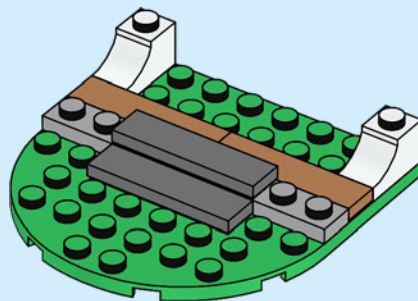

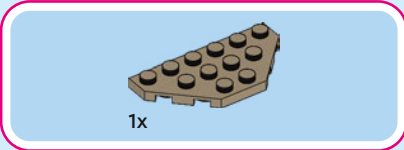
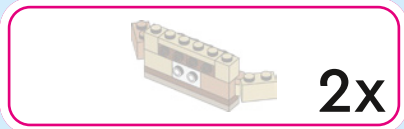

5

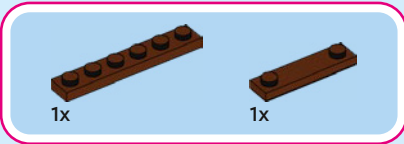
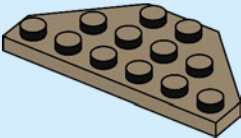

6

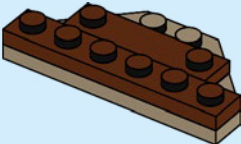

7

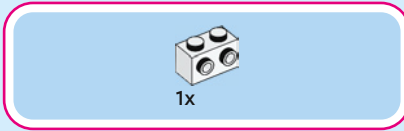
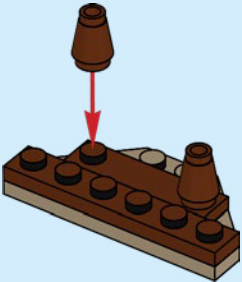

8

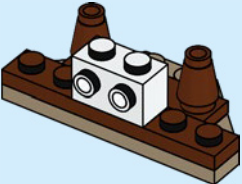

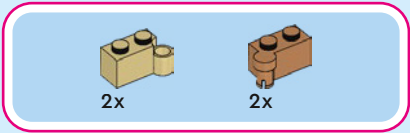

9

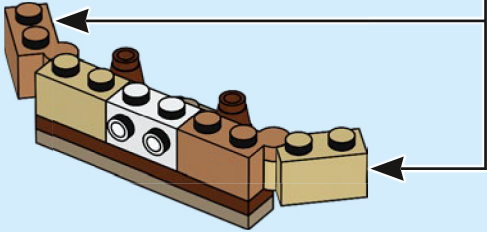
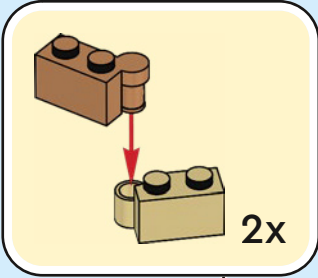

10

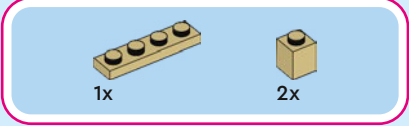
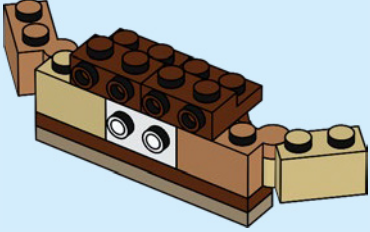

11

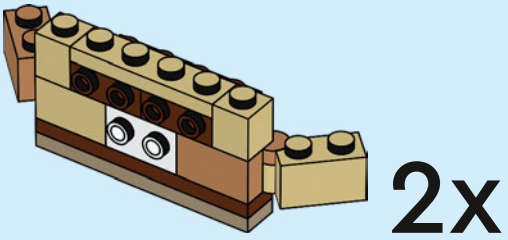

12

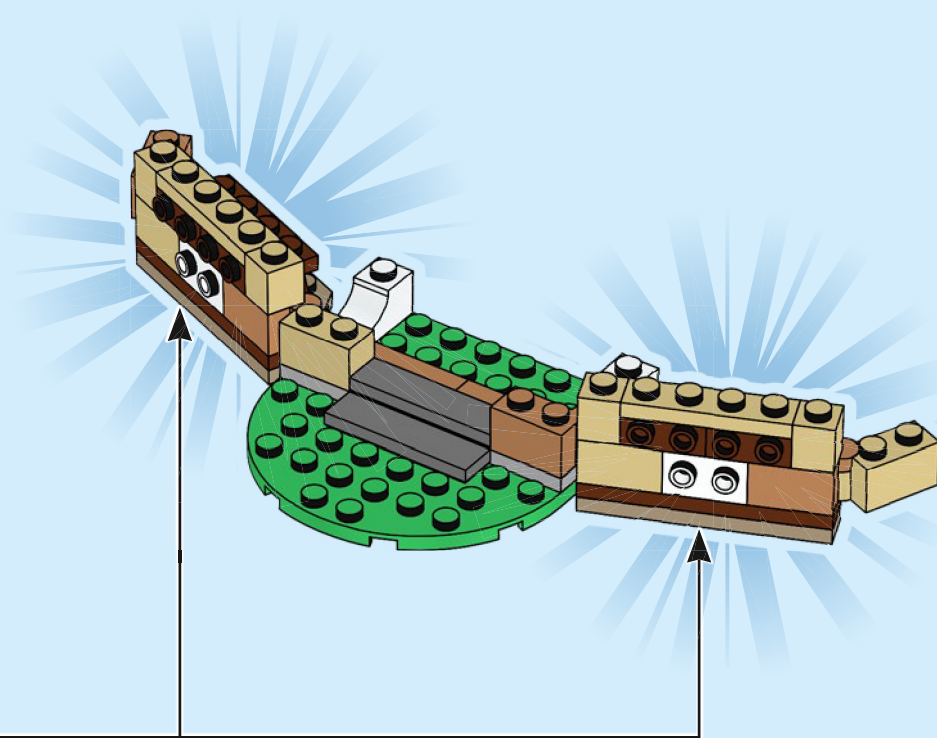



2x



2x



2x

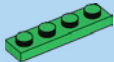

4x



4x



2x

13

1

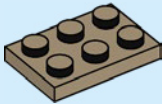

2

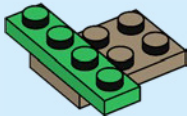

3

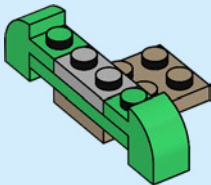

4

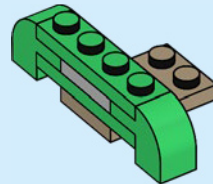

5

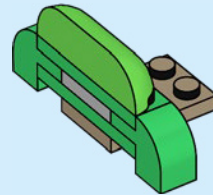

2x



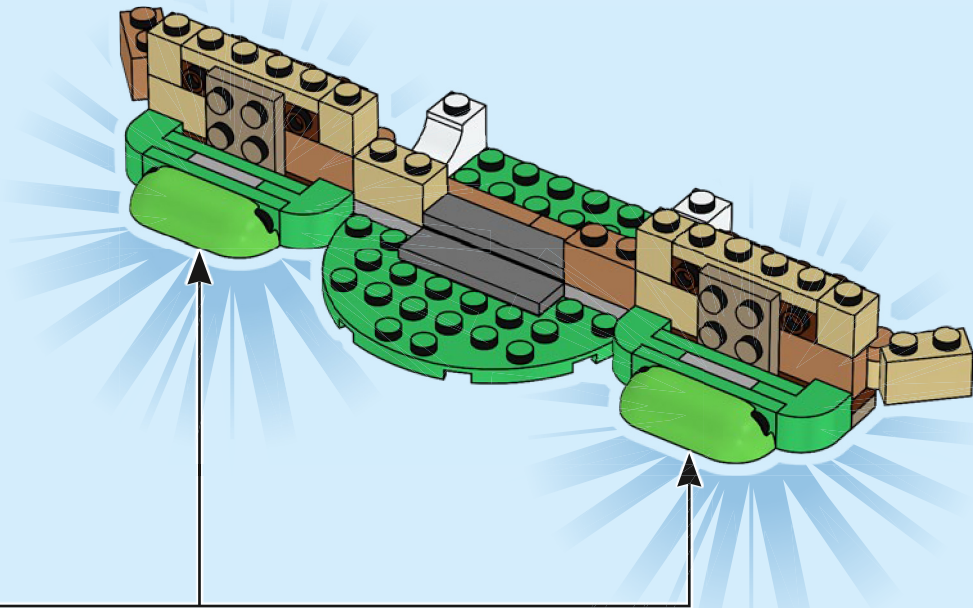



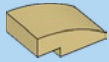

4x

14

1

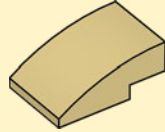

2



4x

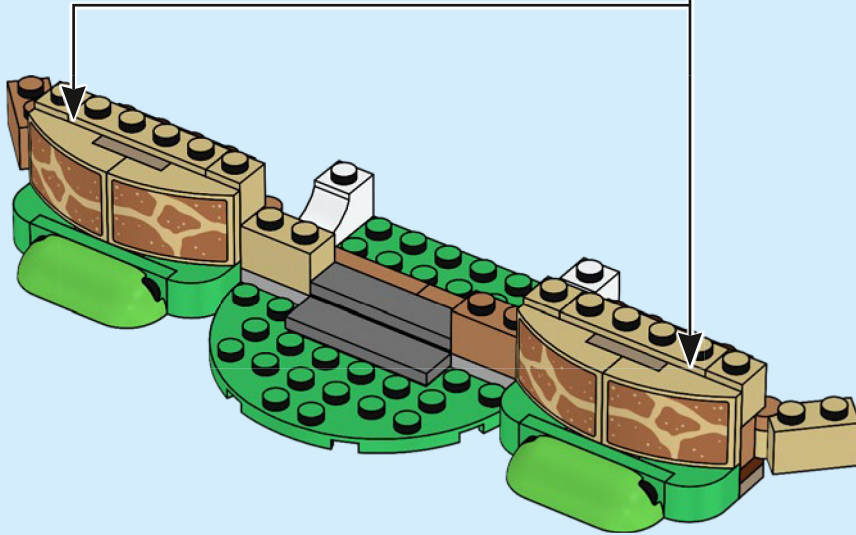

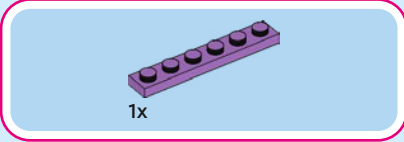
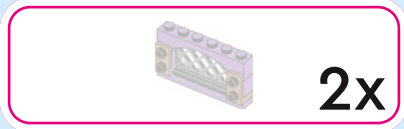

15

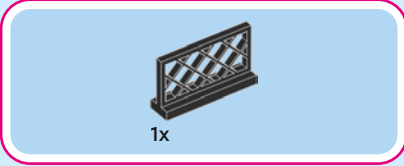
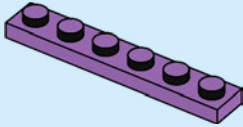

16

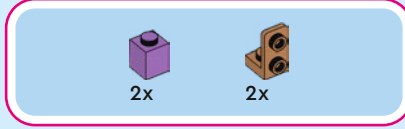
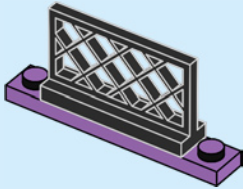

17

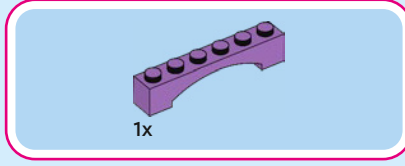
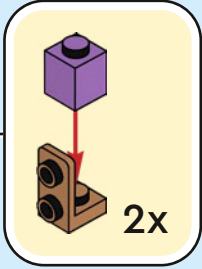
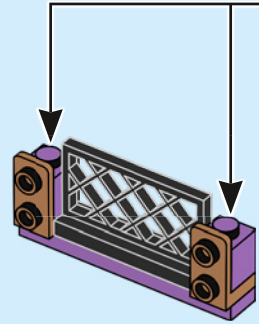

18

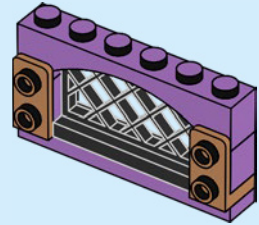

2x

19

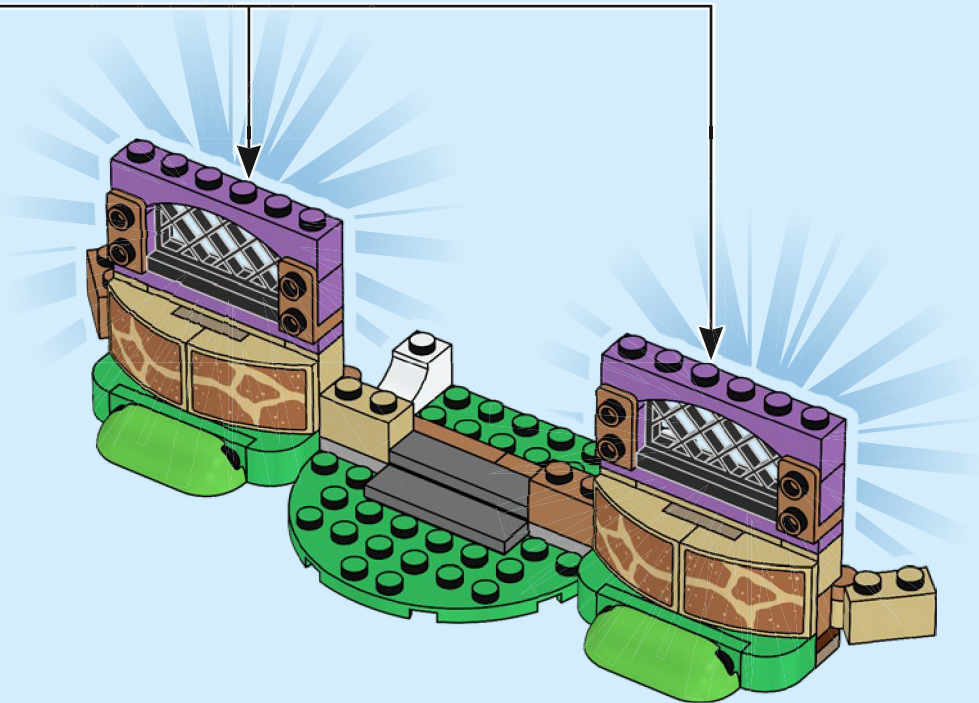



20

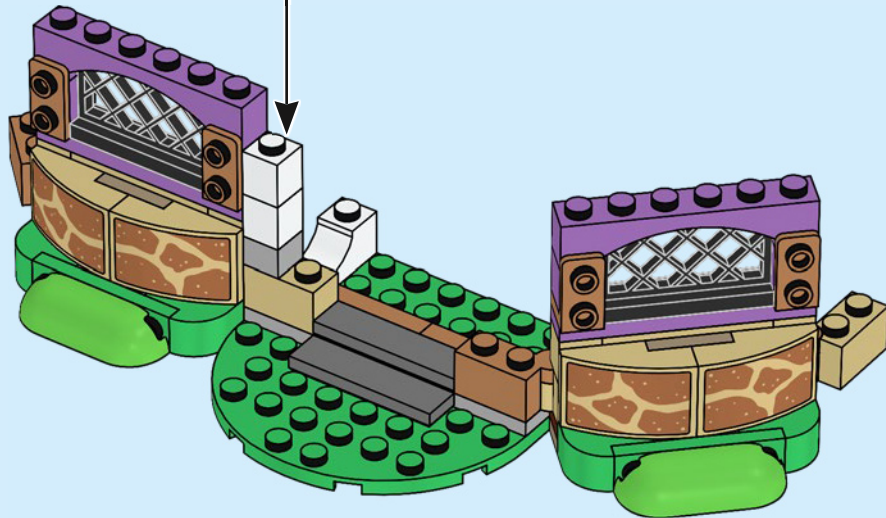
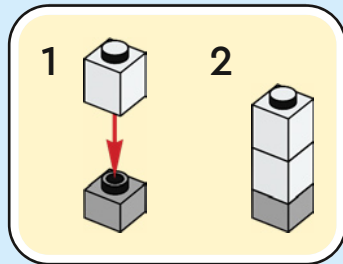

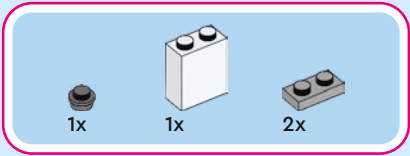

21

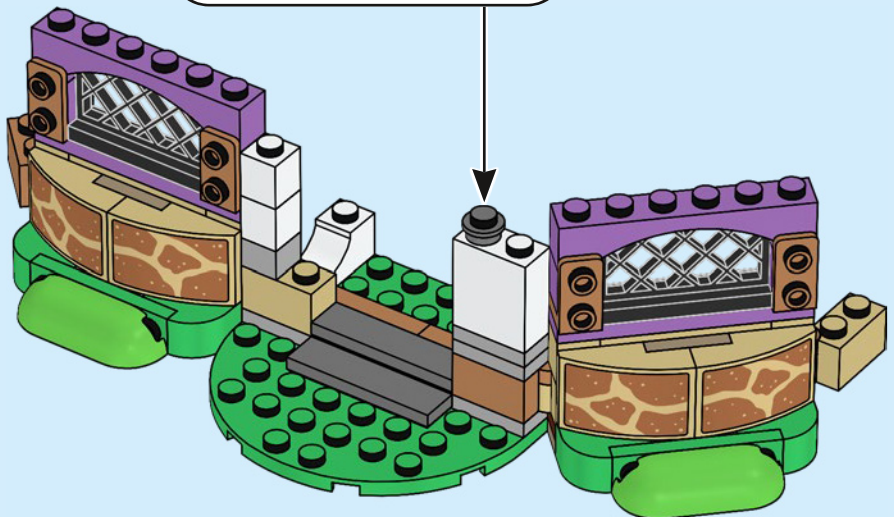
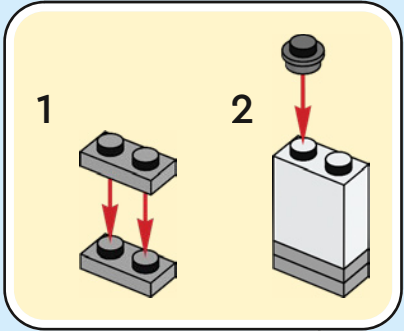



2x



2x

22

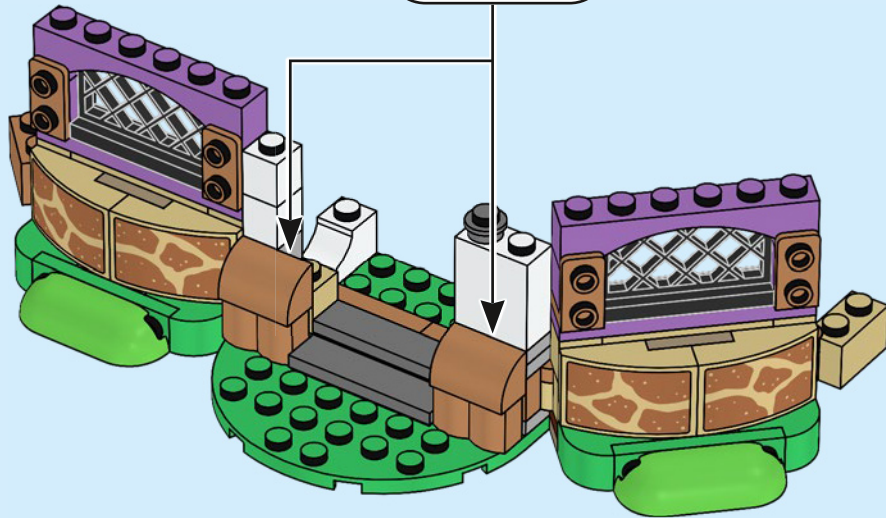
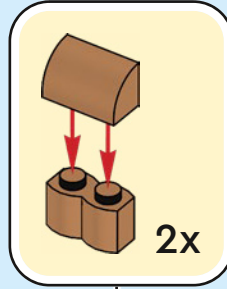



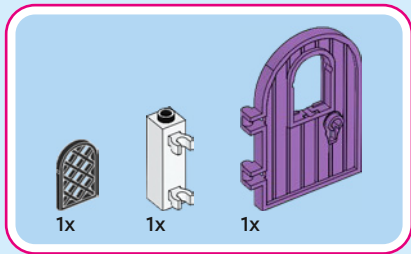

23

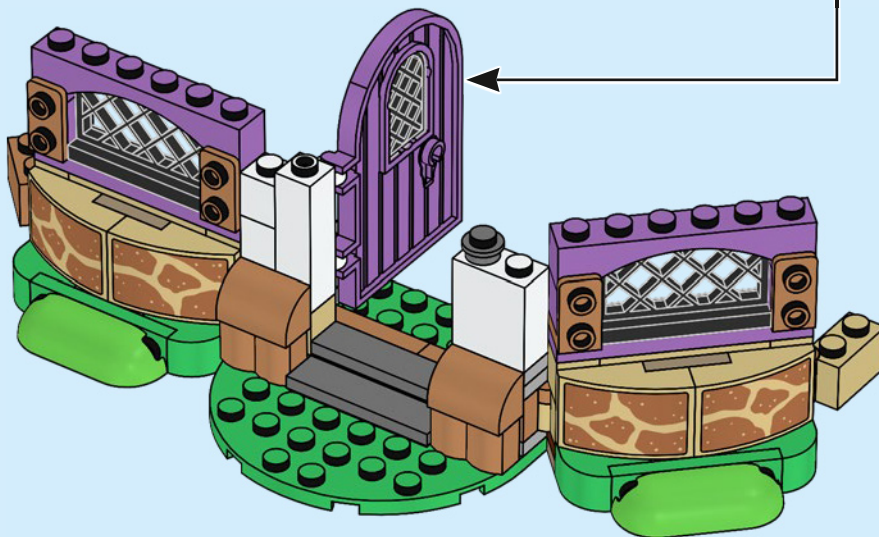
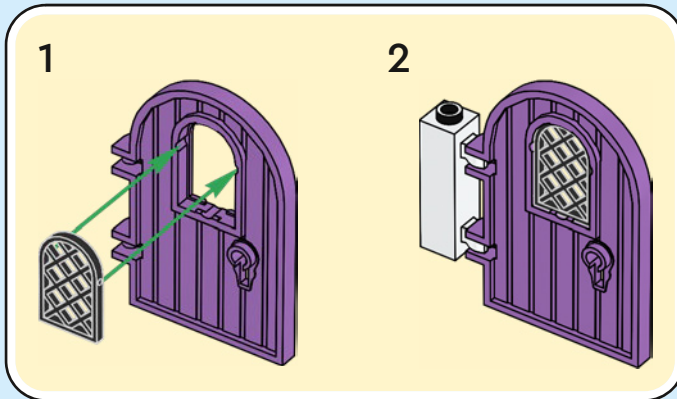

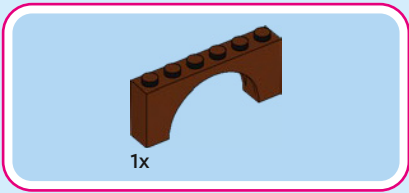

24

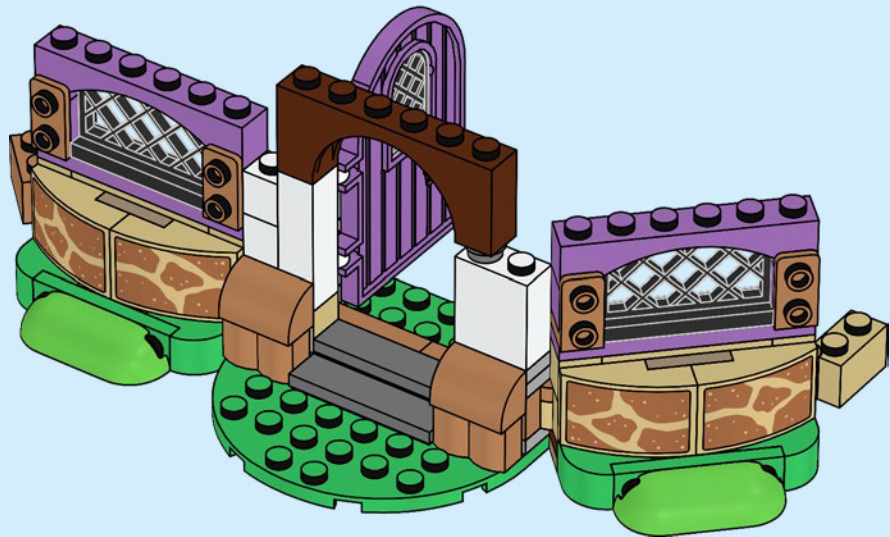



2x

25

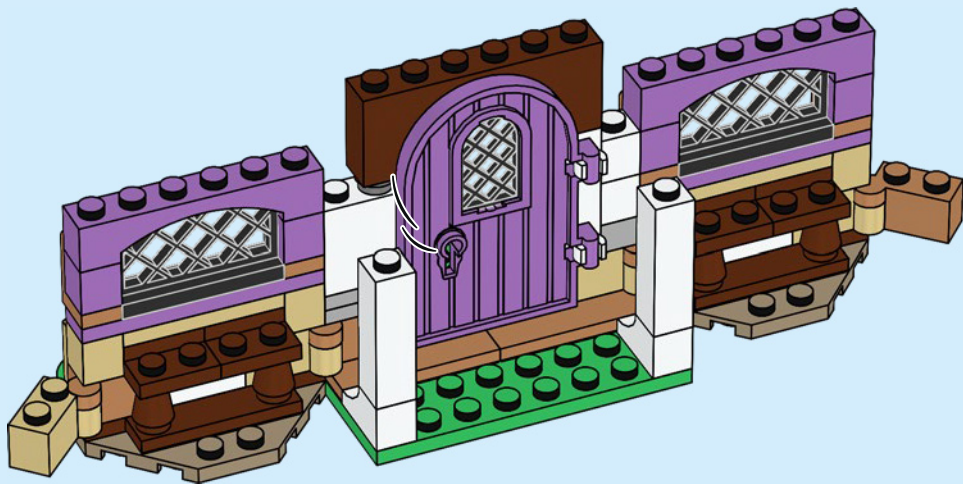



2x

26

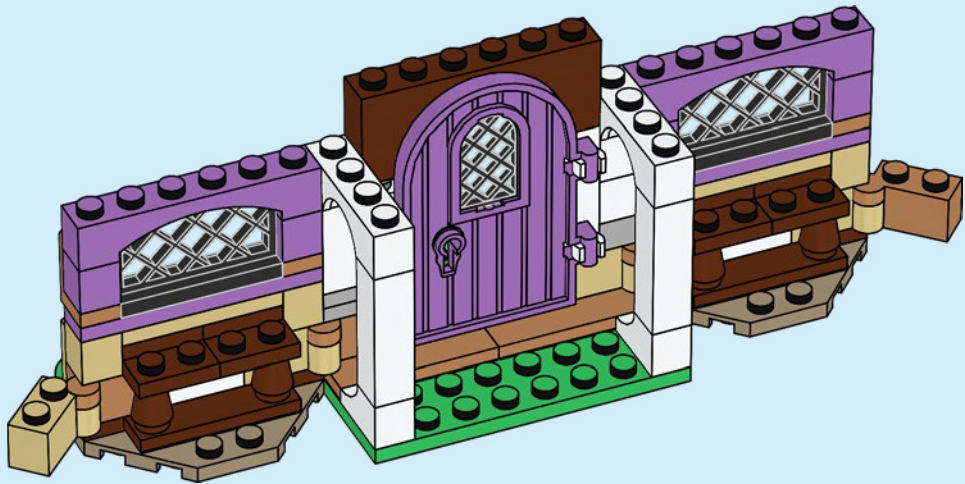

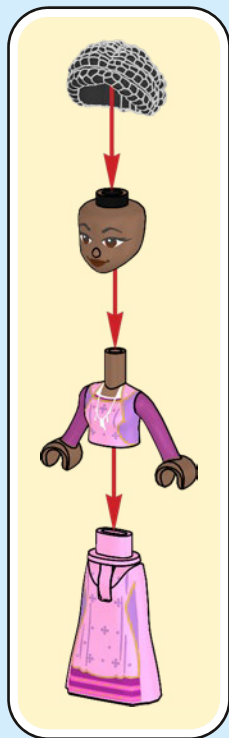



2x

27

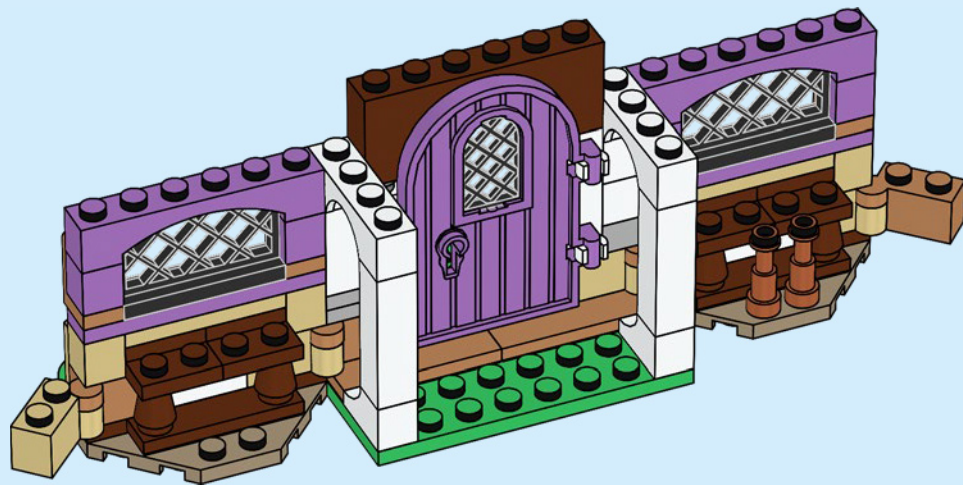





1x

28

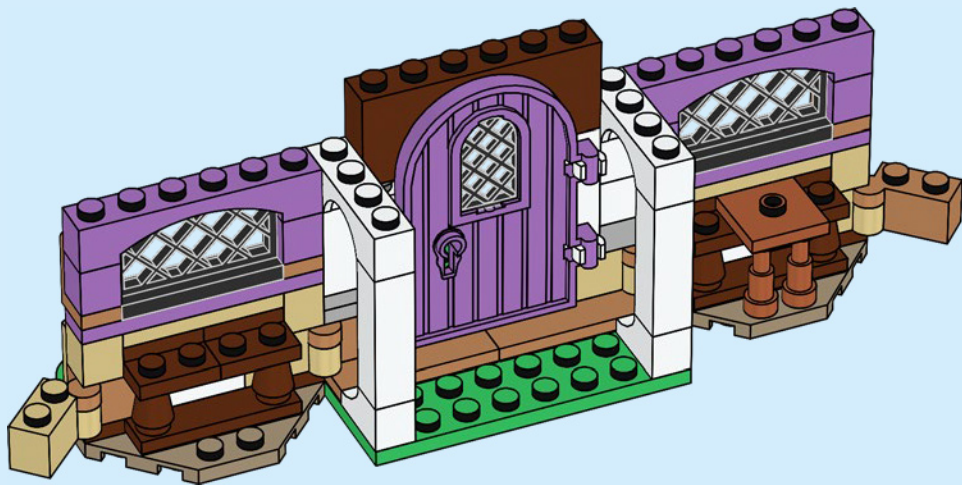



2x



1x



1x

# 29

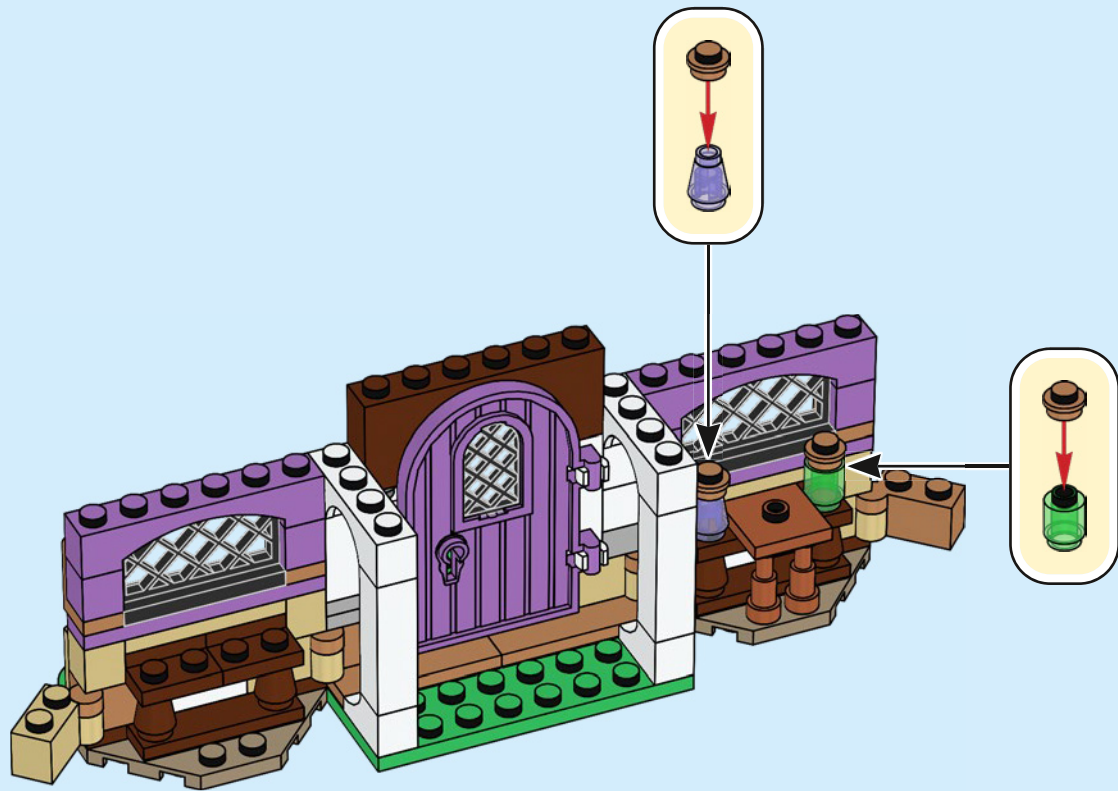



1x



1x

30

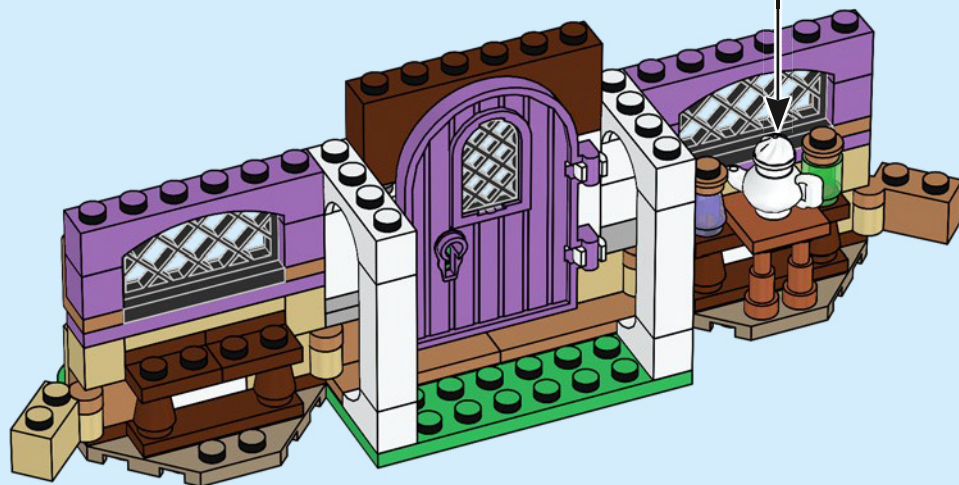
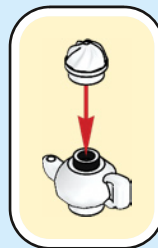



2x



1x

31

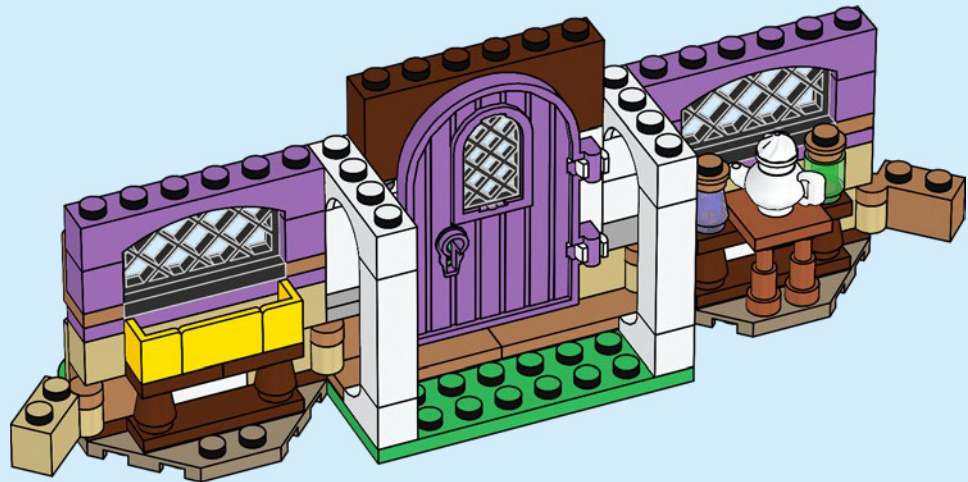



32

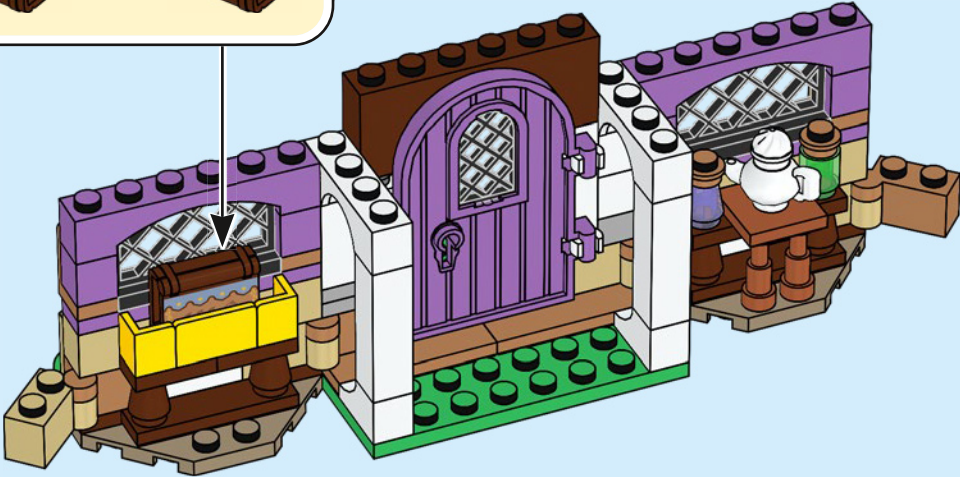
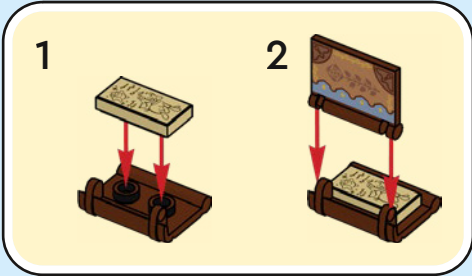

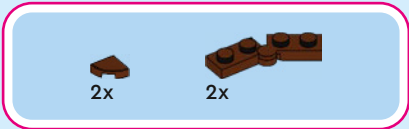

33

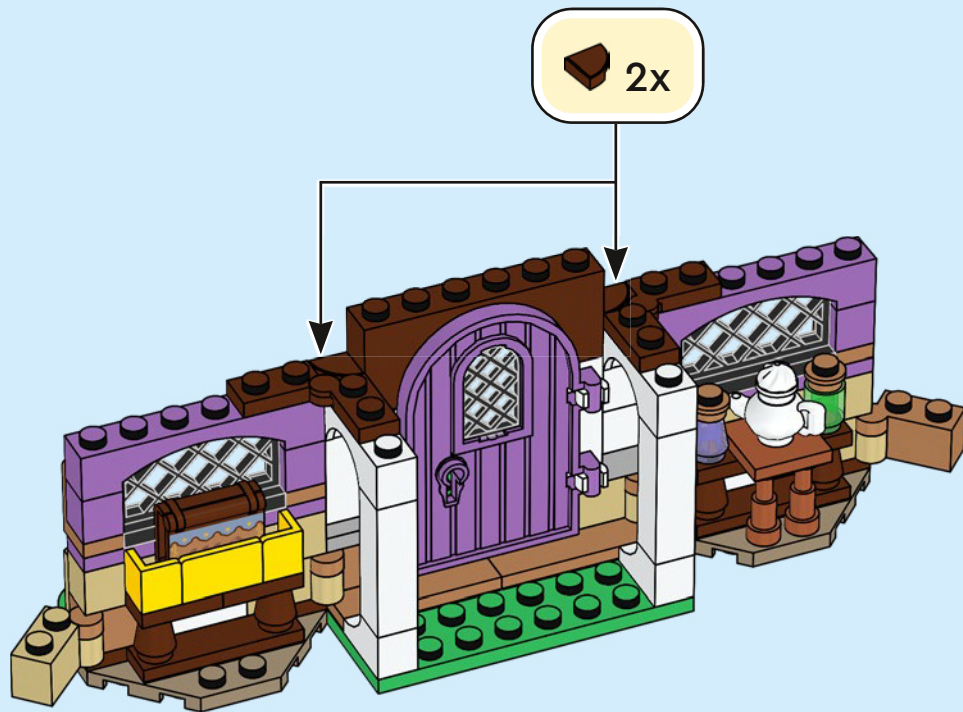

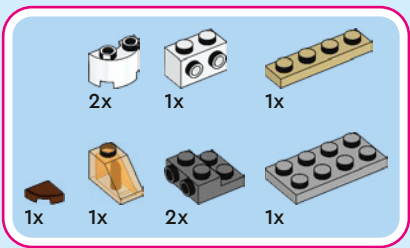

# 34

1

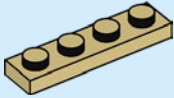

2

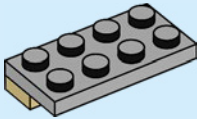

3

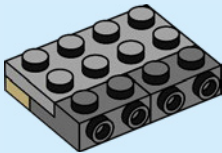

4

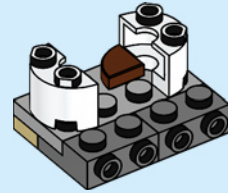

5

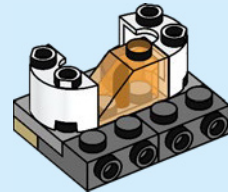

6

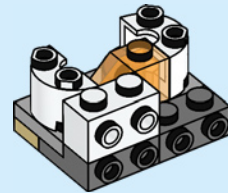



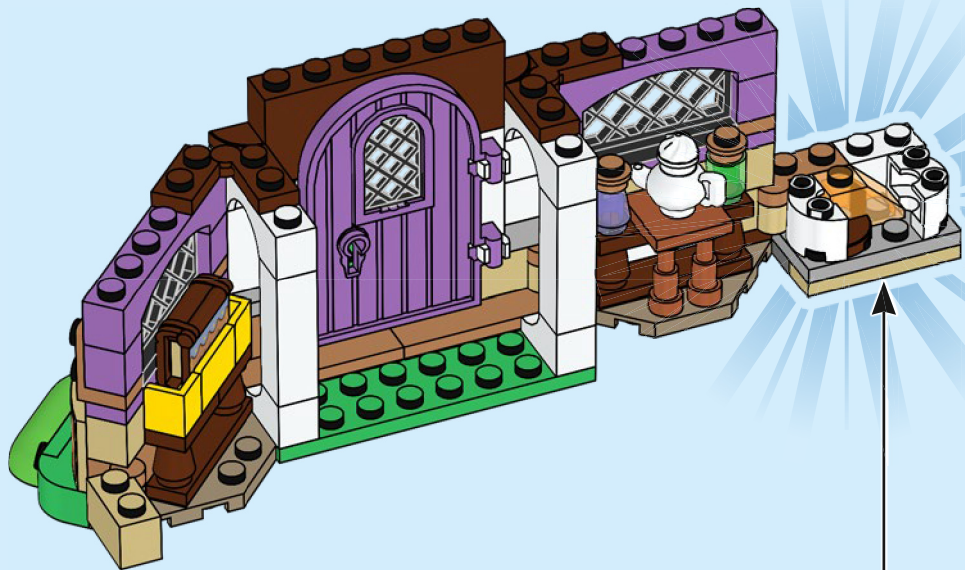

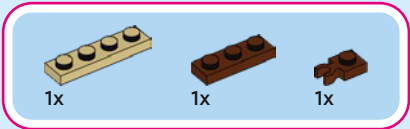

35

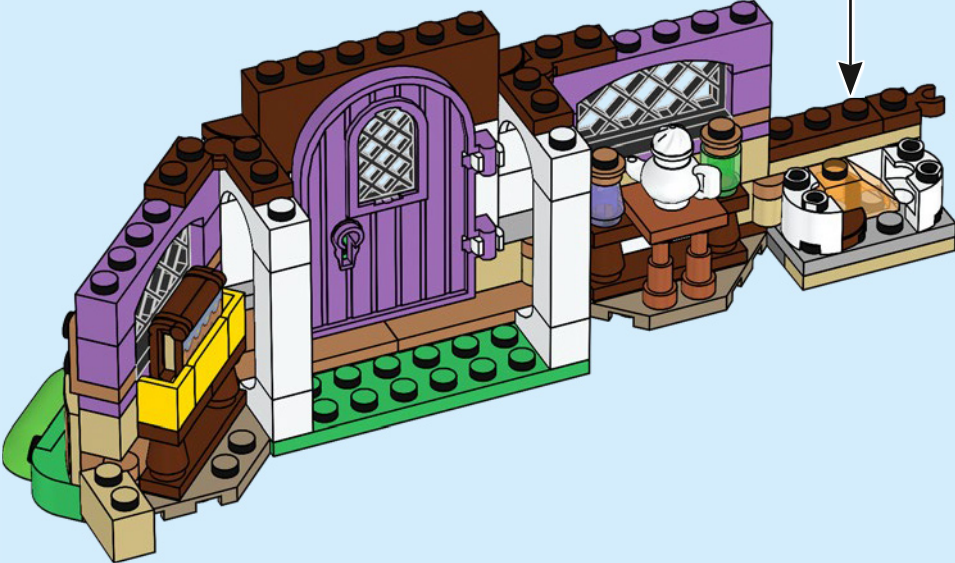
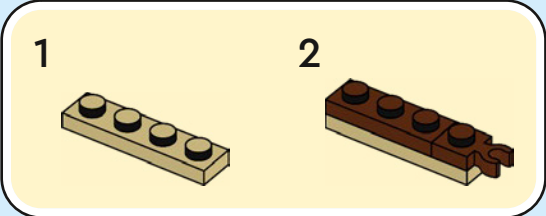

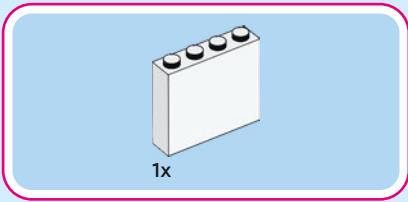

36

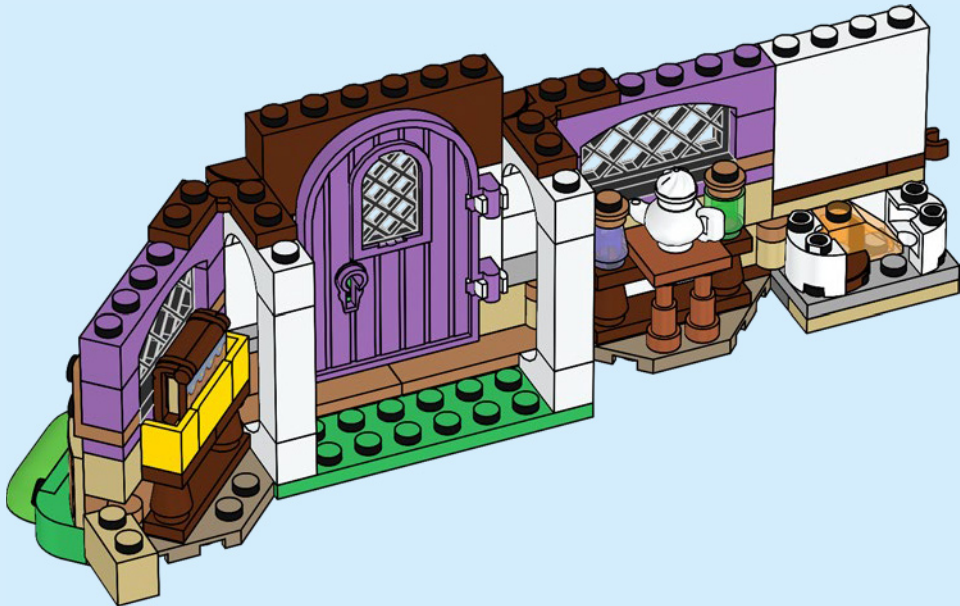



1x

37

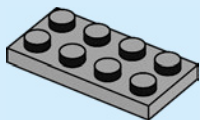

4x

38

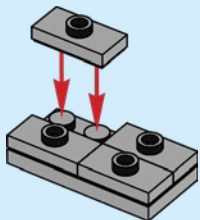

1x

39

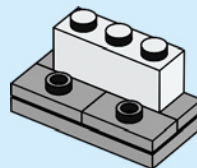

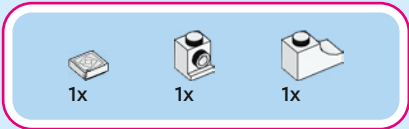

40

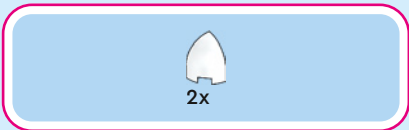
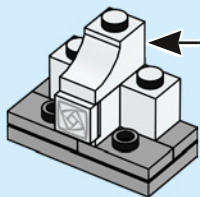
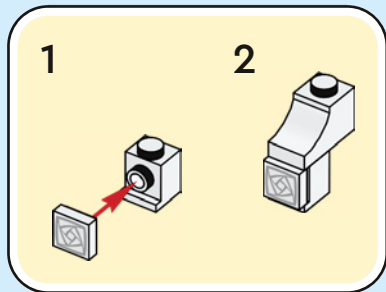

41

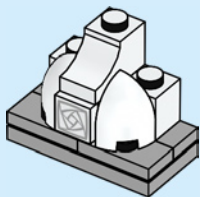

42

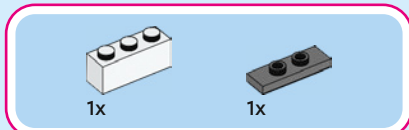
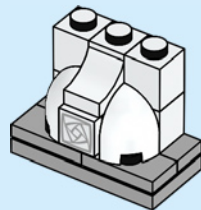

43

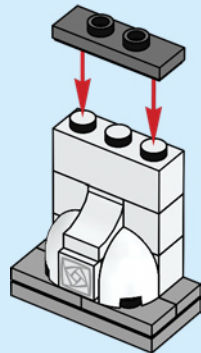

44

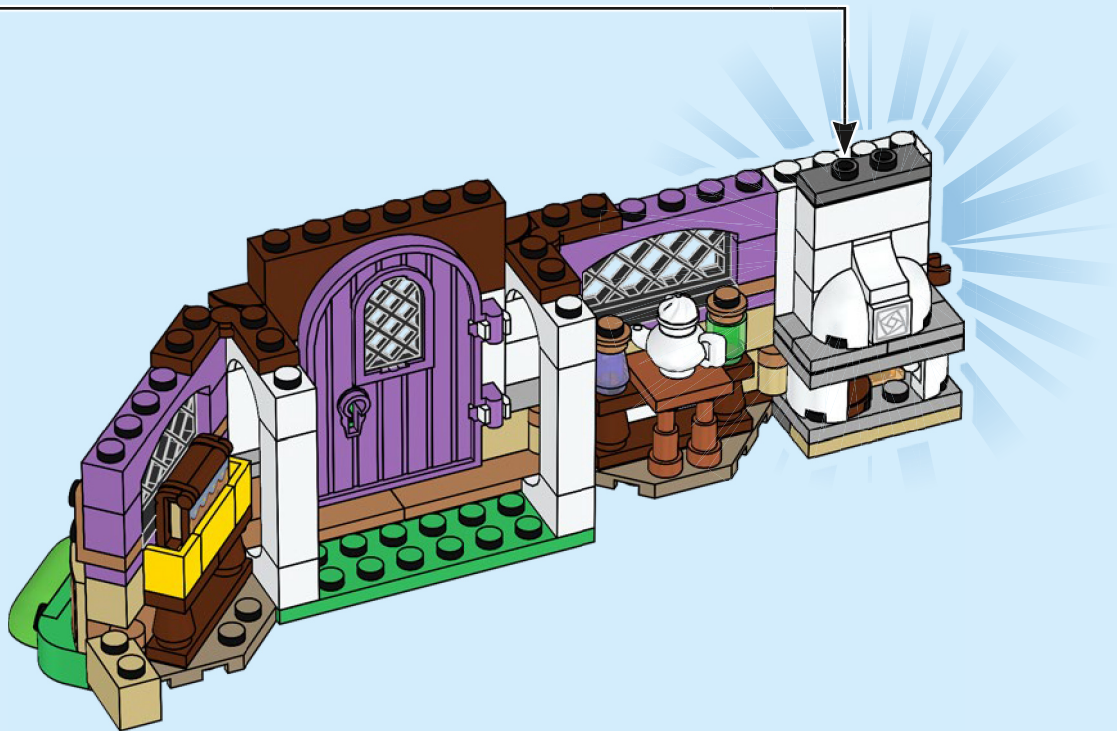



1x

45

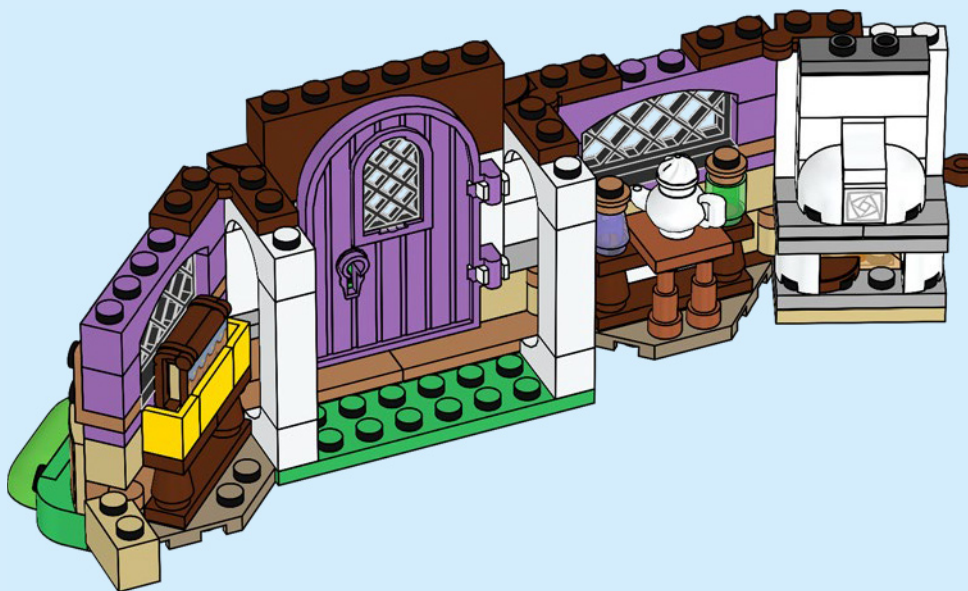



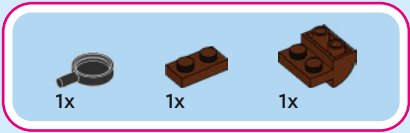

46





1x

47

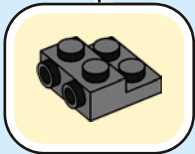
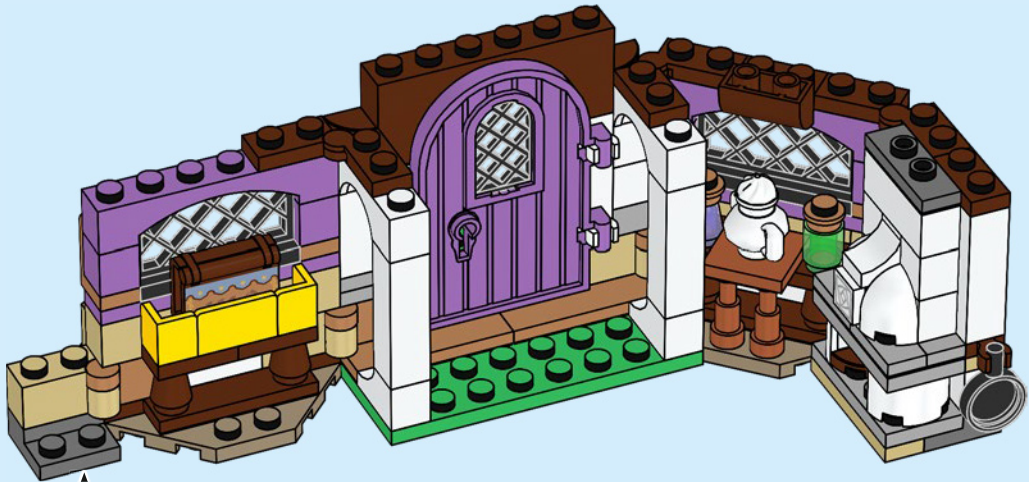

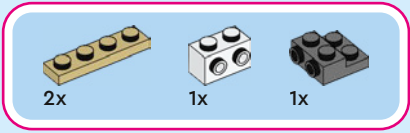

48

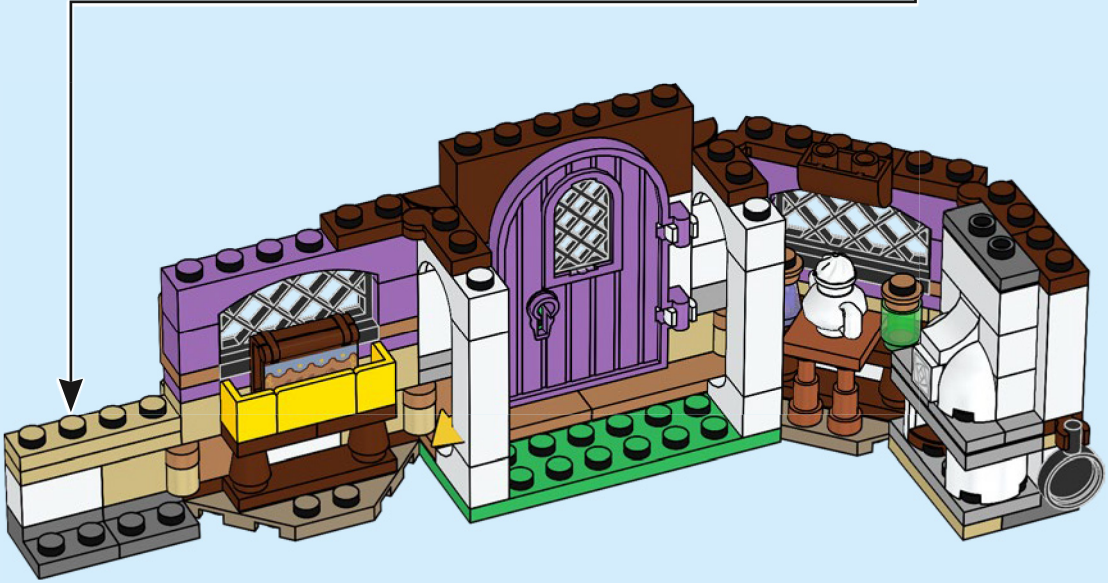
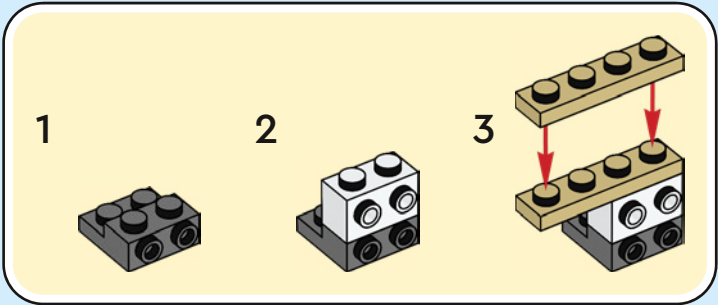

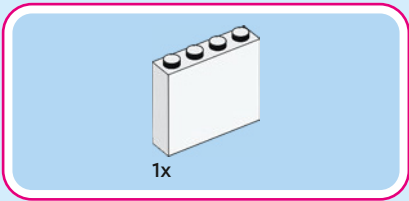

49

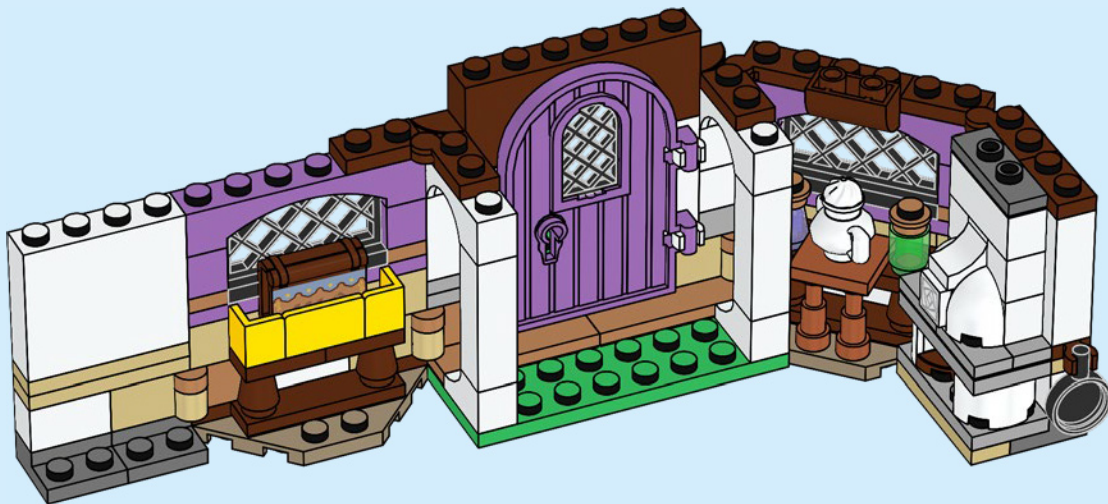

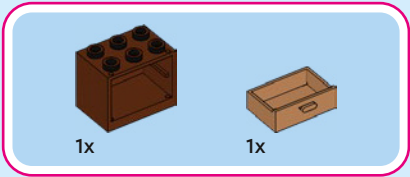

50

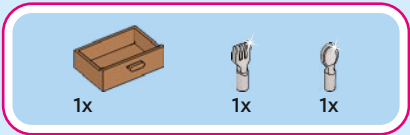
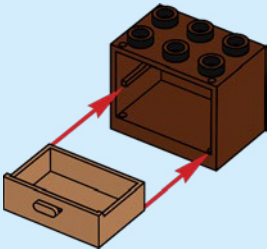

51

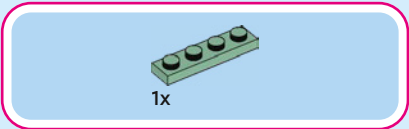
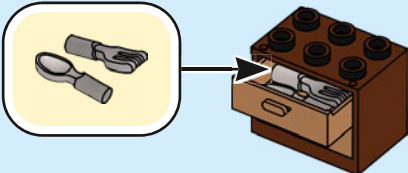

52

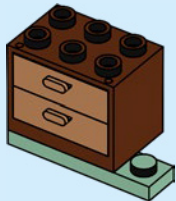

53

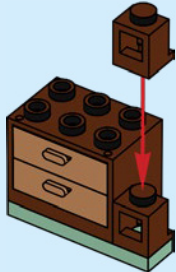

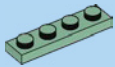

1x

54

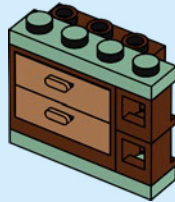

55

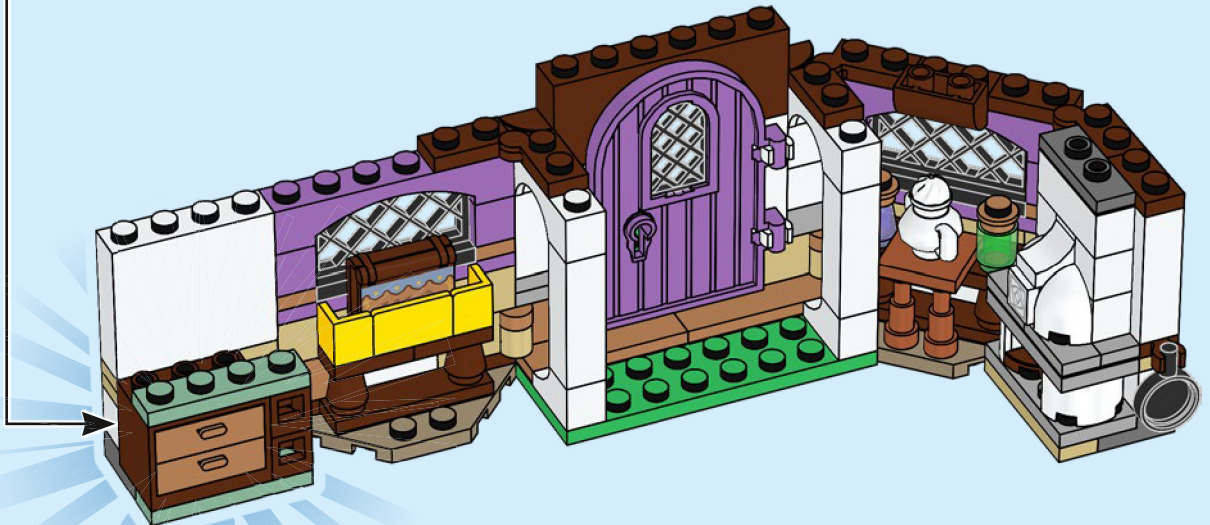

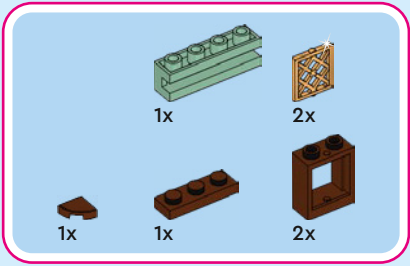

# 56

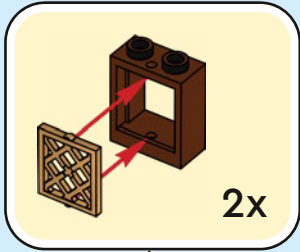

1

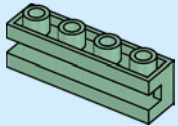

2

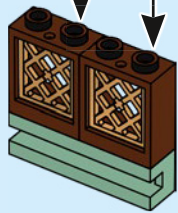

3

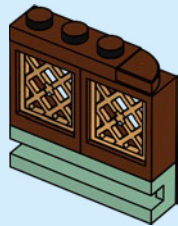







1x

57

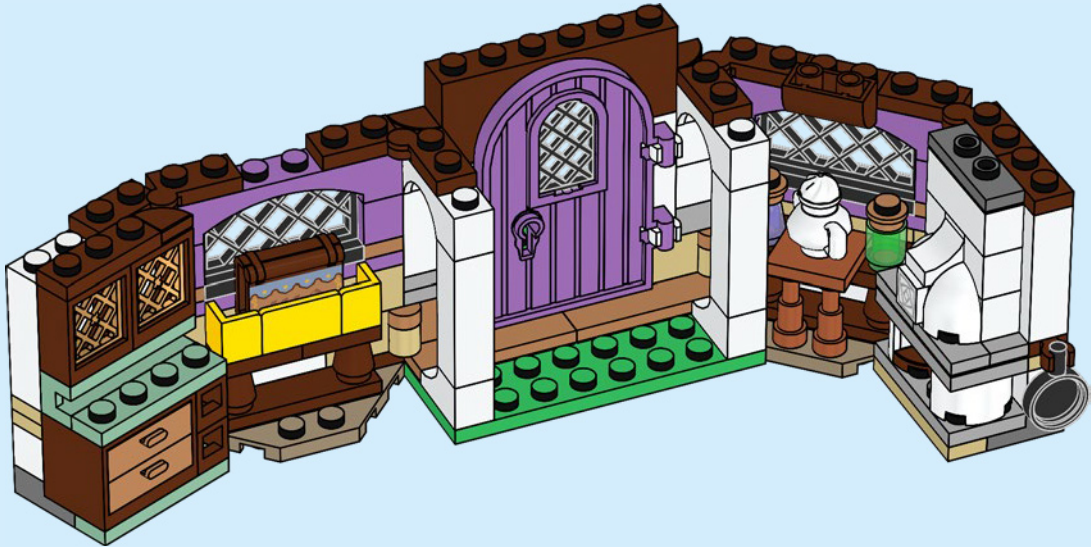







1x

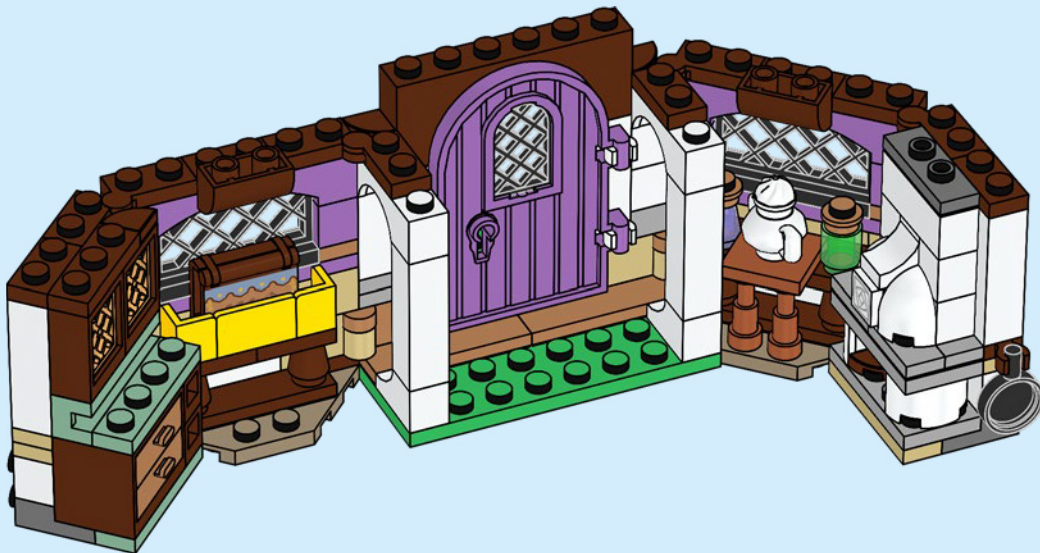

1x

58



-  2x
-  2x
-  6x
-  2x

59

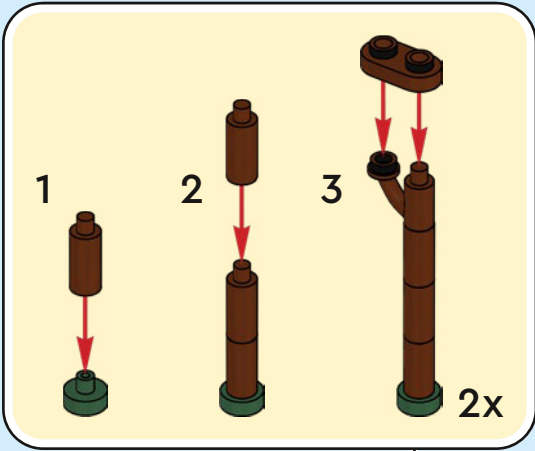



1x

60

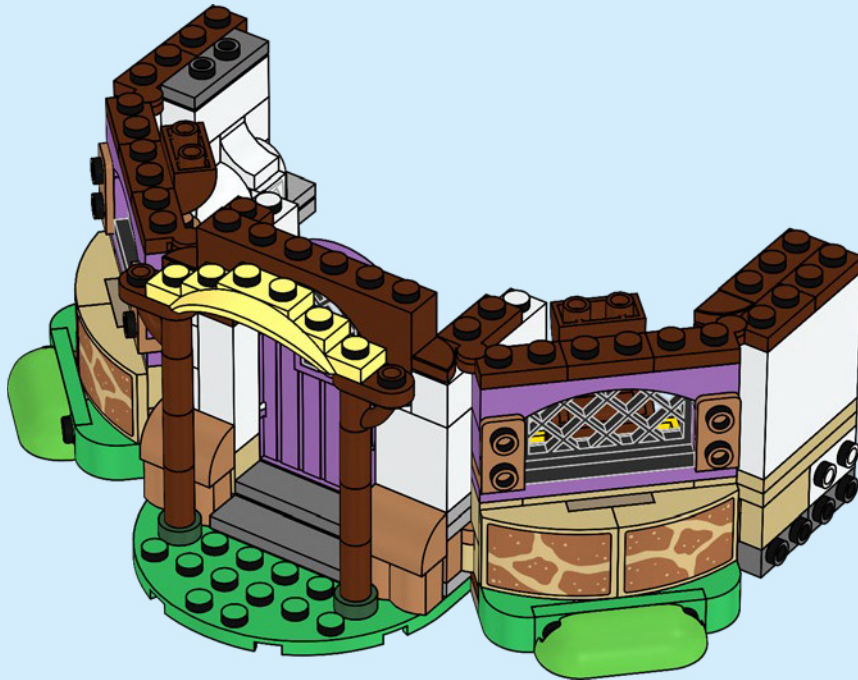

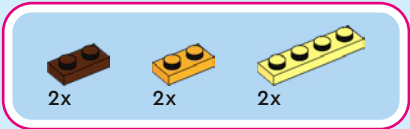

61

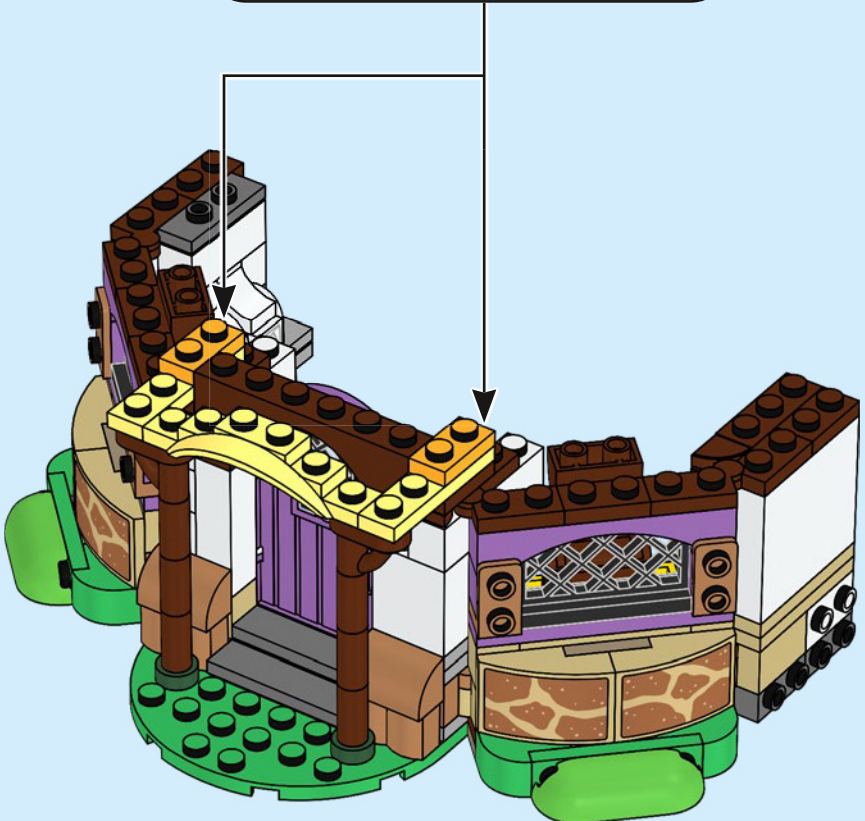
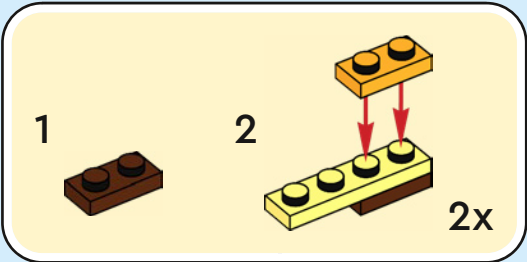



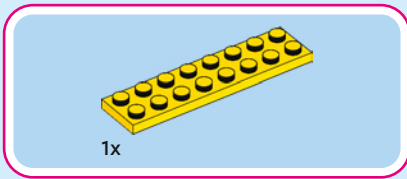

62





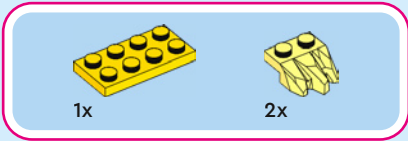

63





2x

64



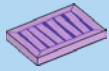

4x

65



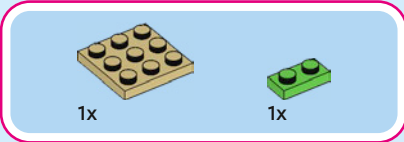

66

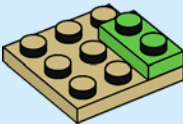

67

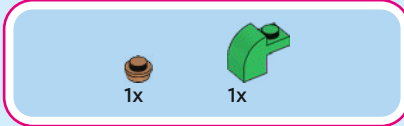
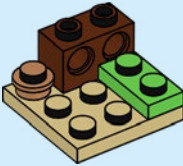

68

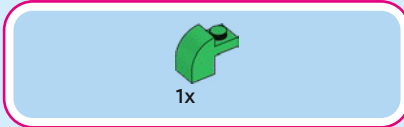
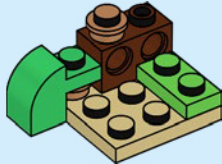

69

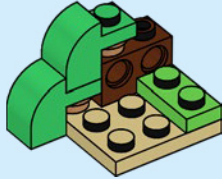



1x

70

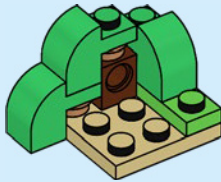

1x

71

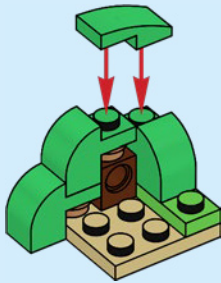

1x

72

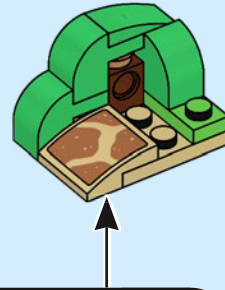

1

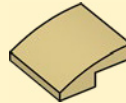

2



73



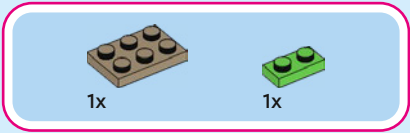

74

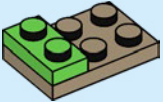

75

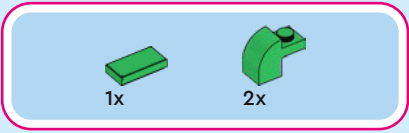
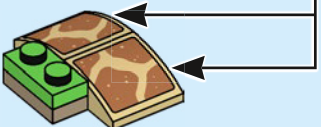
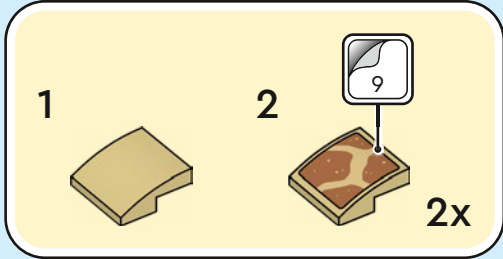

76

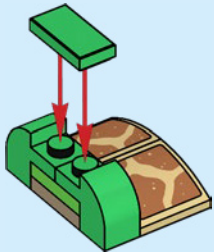



77



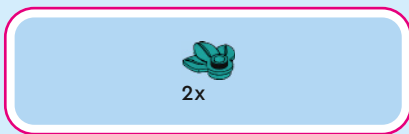

78

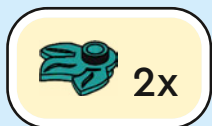
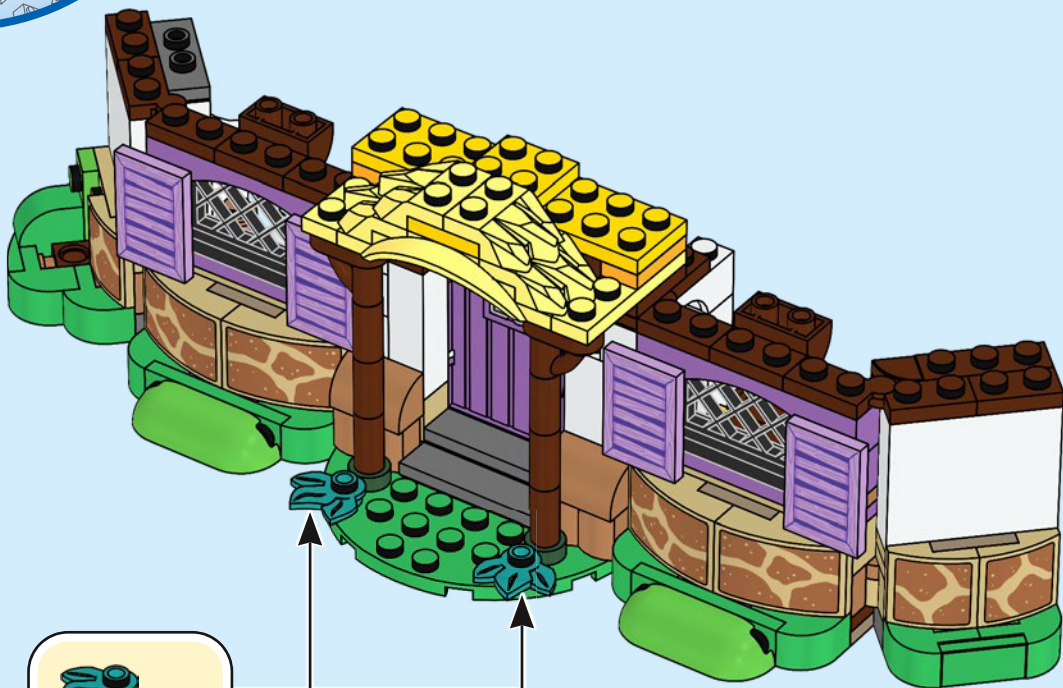



3x



1x

79



1



2



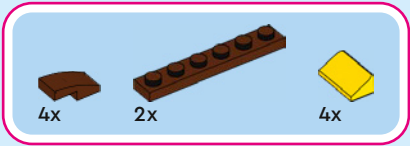

80

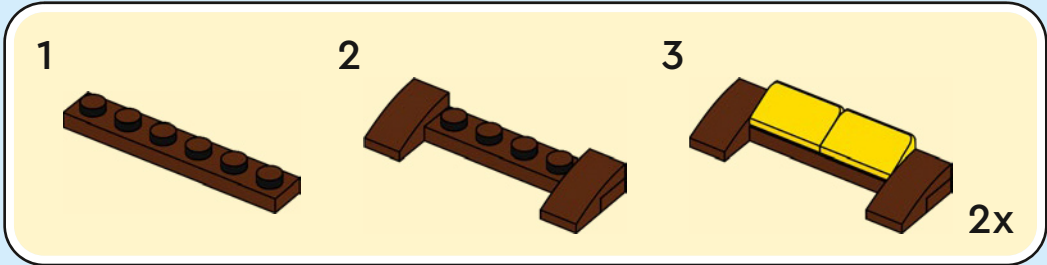





2x

81





2x

82





2x



1x

83



3x

84

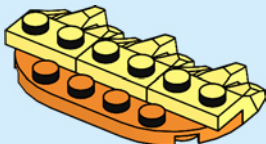

2x

85

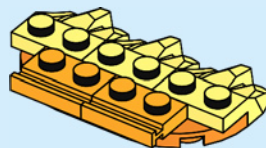

1x

86

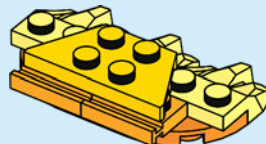





2x

87

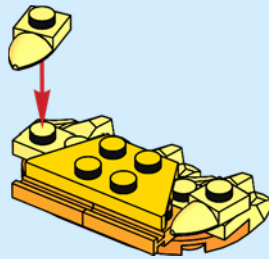

2x

88

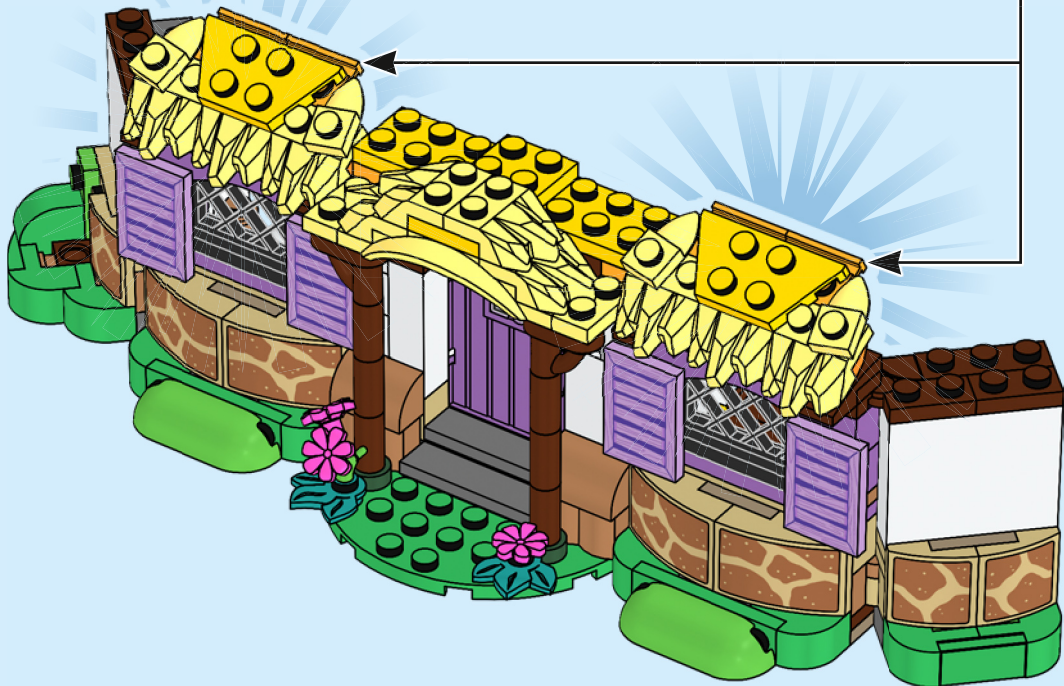



2x



1x



1x

89

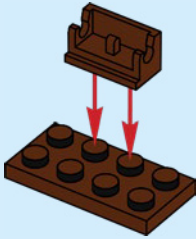

2x

90

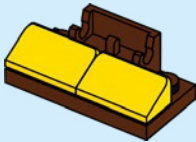

1x

91

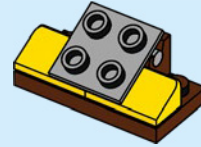

1x

92

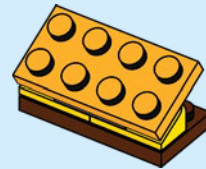



2x

93

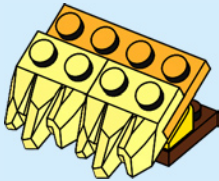

1x

94

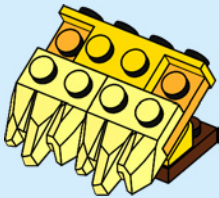

1x

95

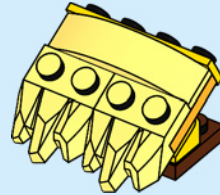

2x

96

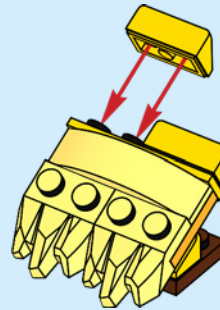

2x

97



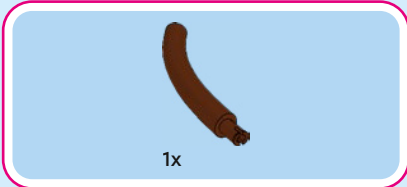
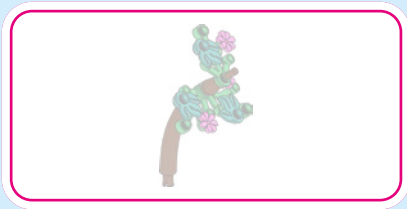

98

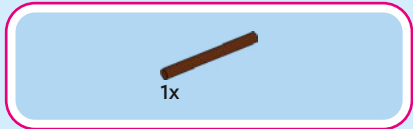

99

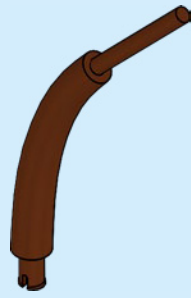

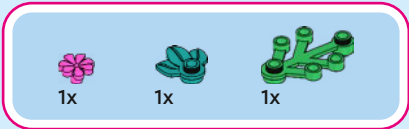

100

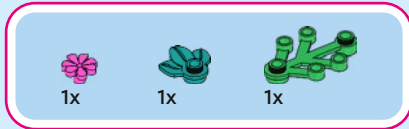
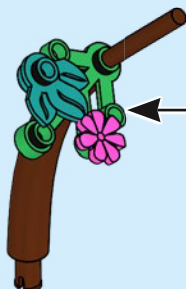
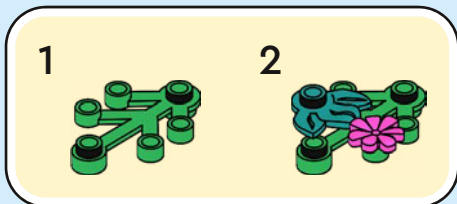

101

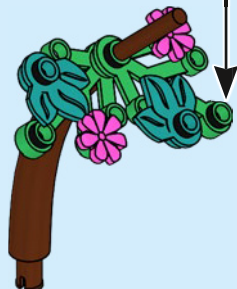
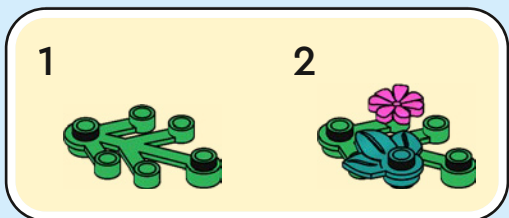



1x

102

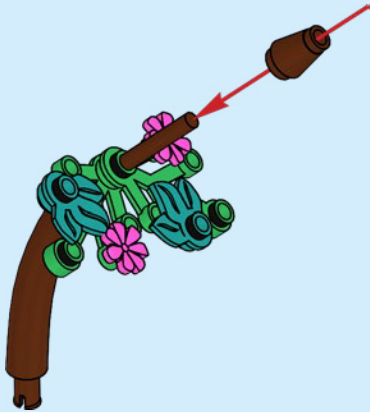

1x



1x



1x

103

1



2

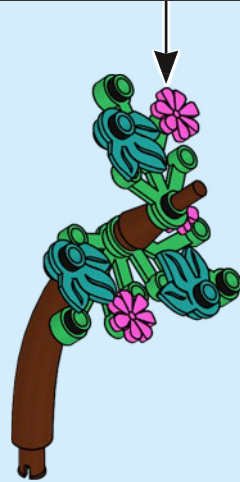



104



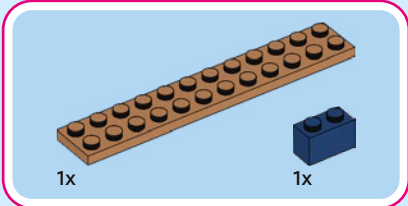

105

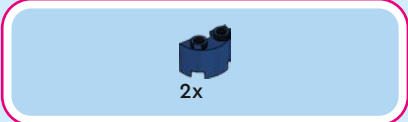
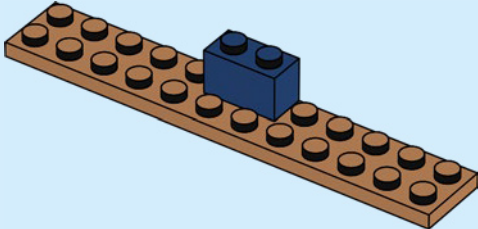

106

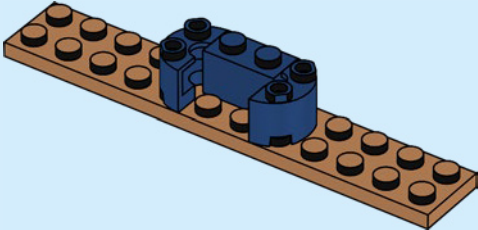

107

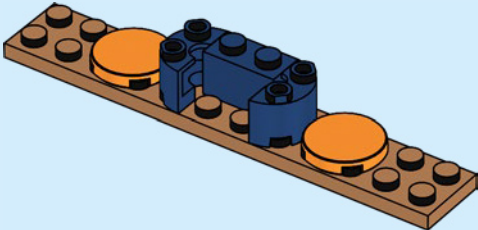

108

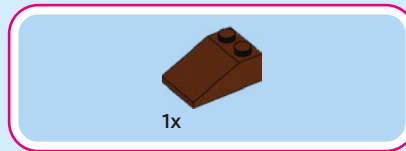
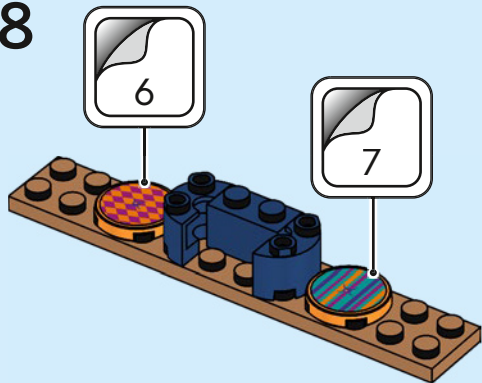

110

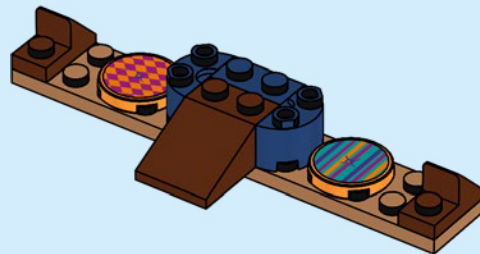

109

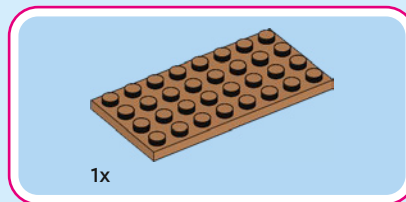
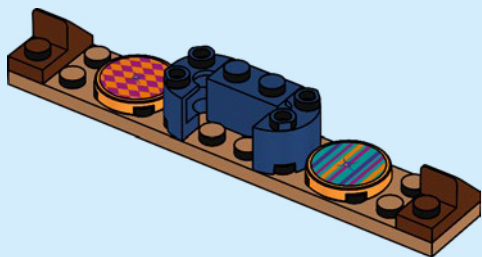

111

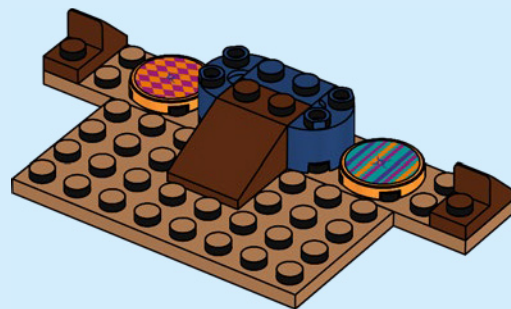



114

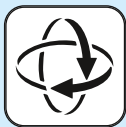





3x

115





1x

116





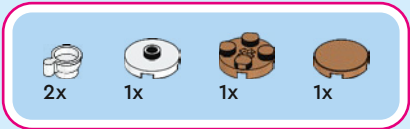

117

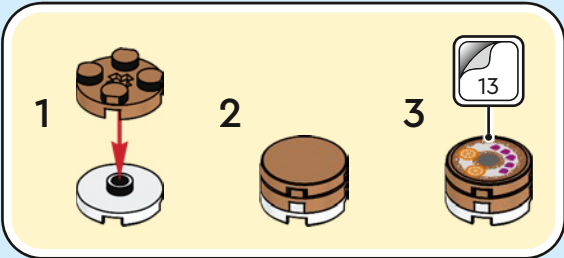



2x

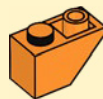

2x

118



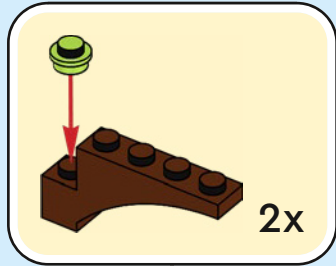
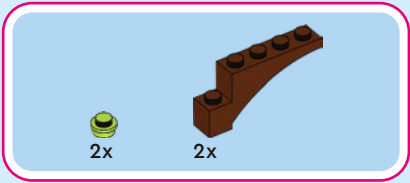

119





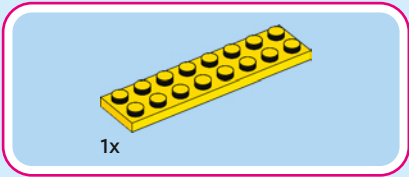

120



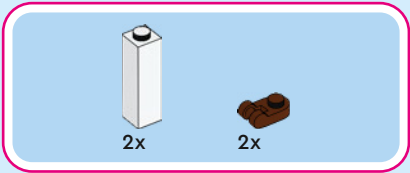

121

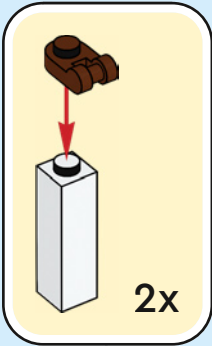

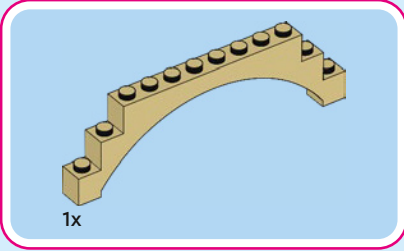
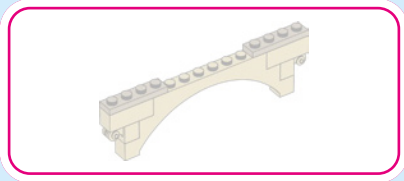

122

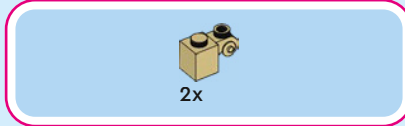
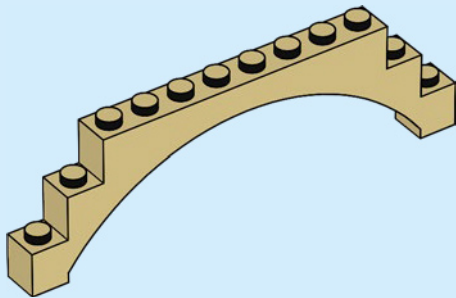

123

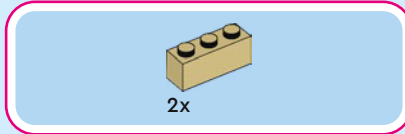
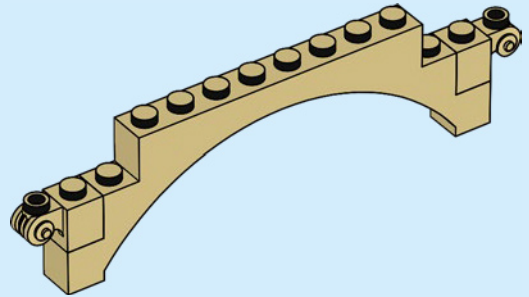

124

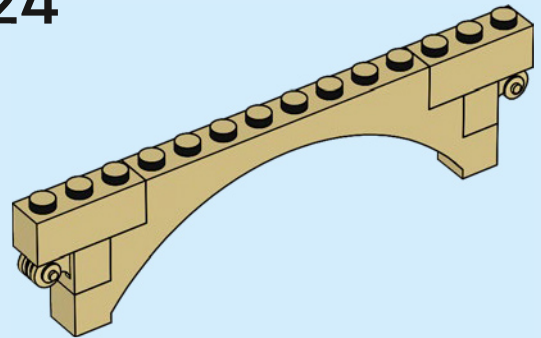

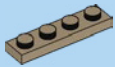

2x

125

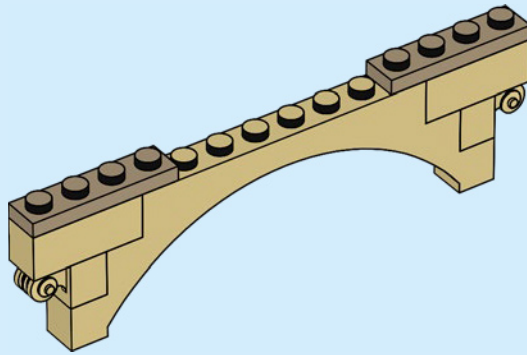

126





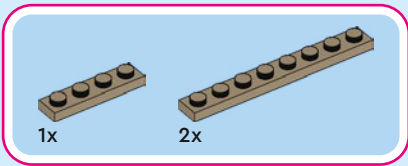

127





2x



2x

128





2x

129



2x







2x

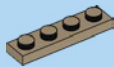

1x

130



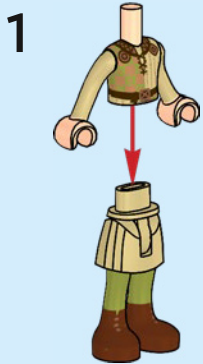



131

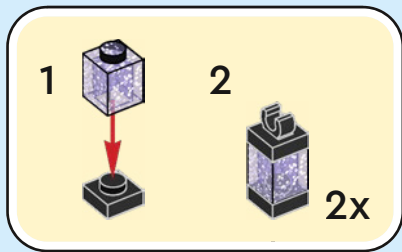



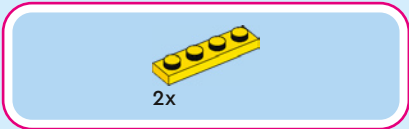

132

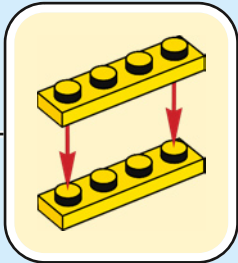

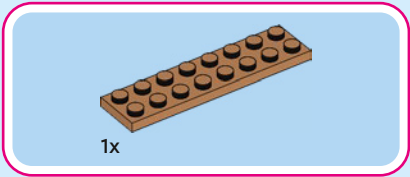

133





1x



2x

# 134





1x



1x

135







1x



2x

# 136



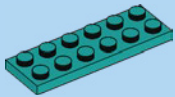

1x

137

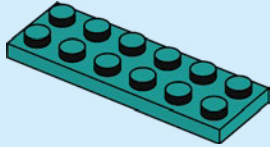

2x

138

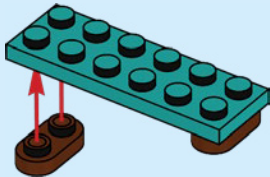

1x



1x

139

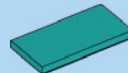
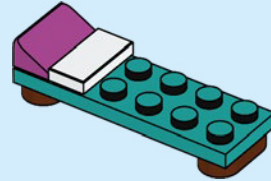

1x

140

1

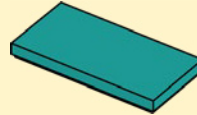

2









1x

142

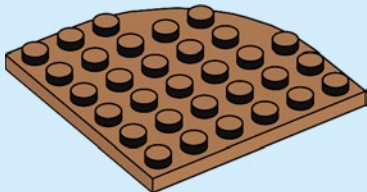

1x

143

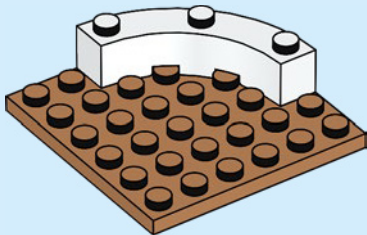

1x



1x

144

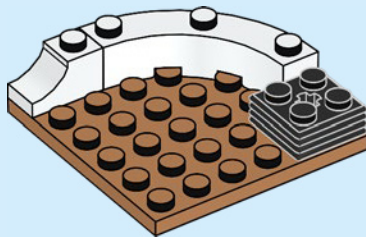

1x

145

1

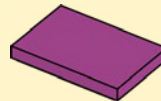

2

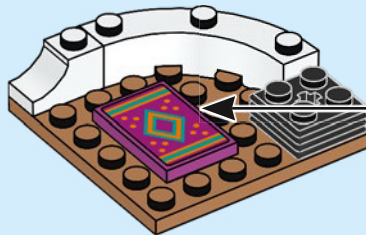
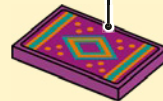



1x



1x

# 146

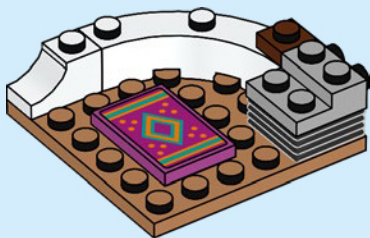

1x

# 148

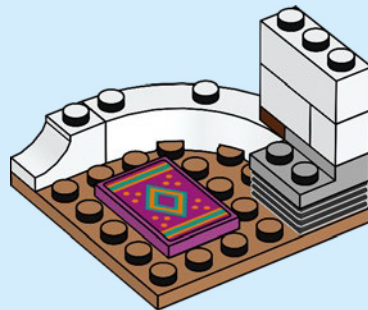

1x



1x

# 147

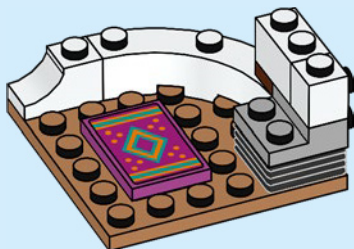

1x



1x

# 149

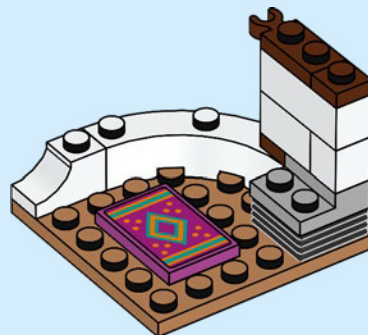

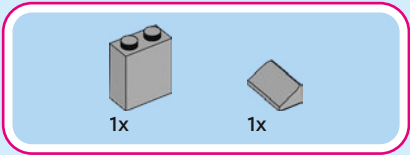

150

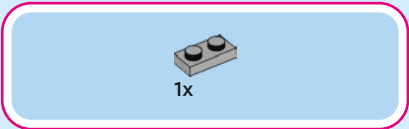
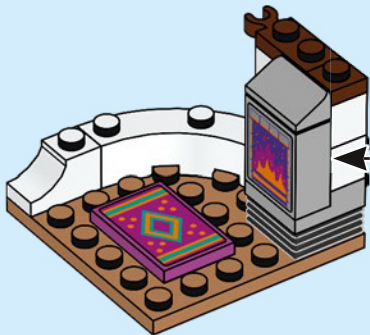
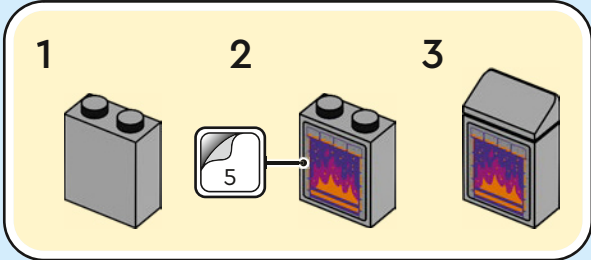

151

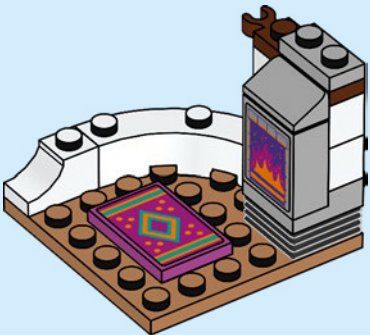



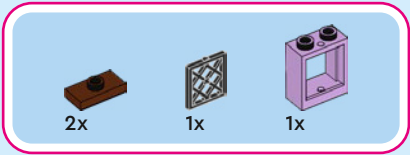

154

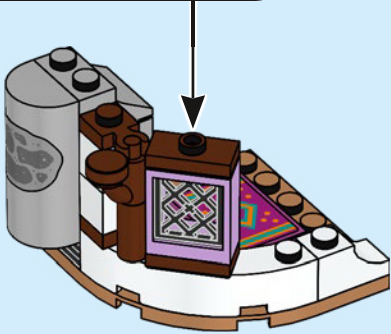
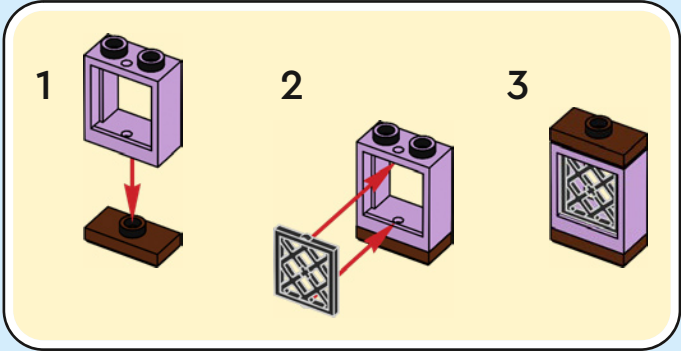



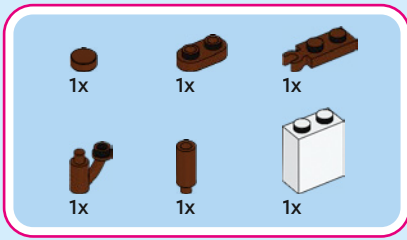

155

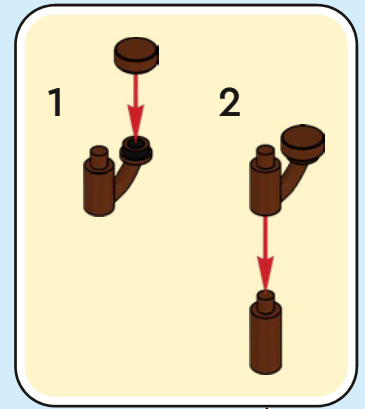

1

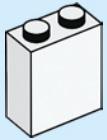

2

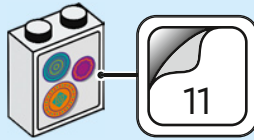

3

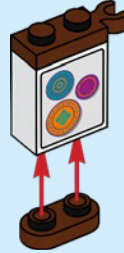

4



156

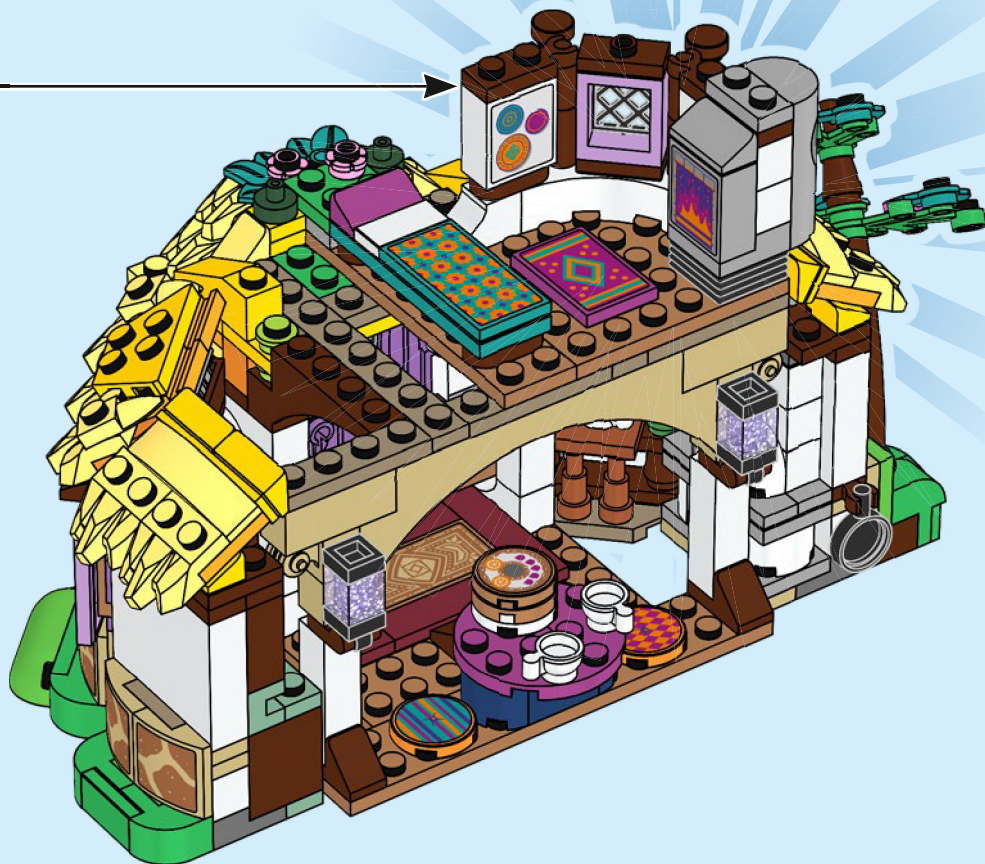

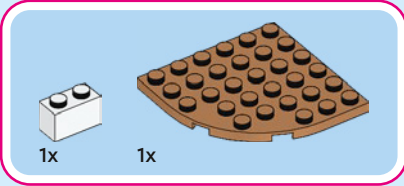

157

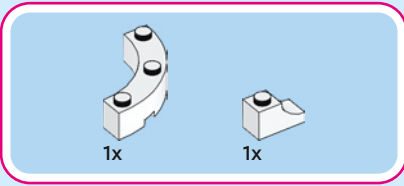
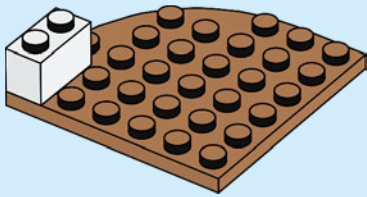

158

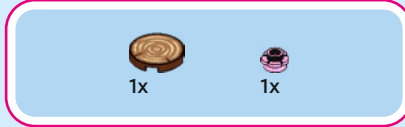
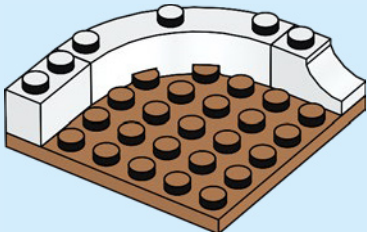

159

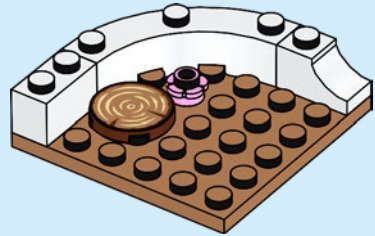

160

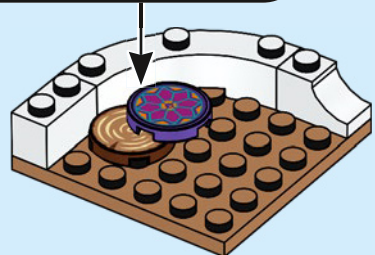
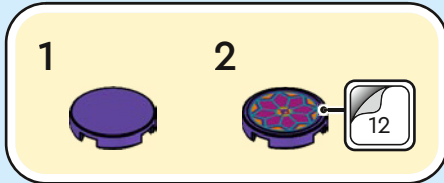



1x



1x

# 161

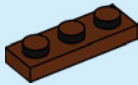

1x



1x

# 162

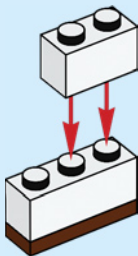

1x



1x

# 163

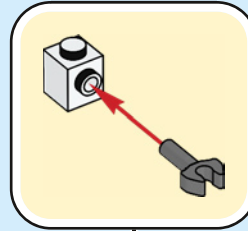

1x



1x

# 164

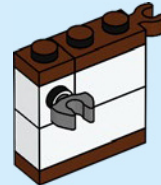

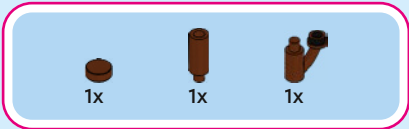

165

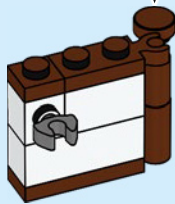
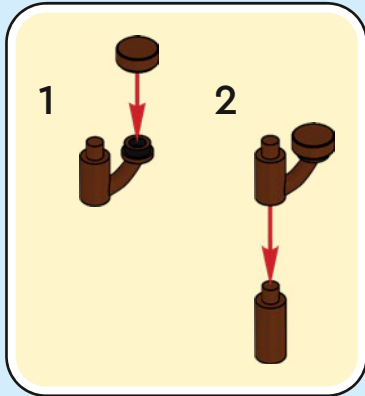

166

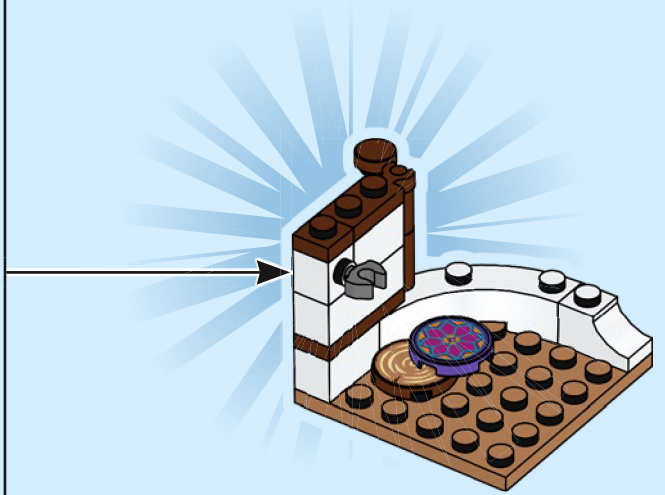

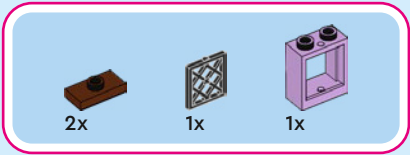

167

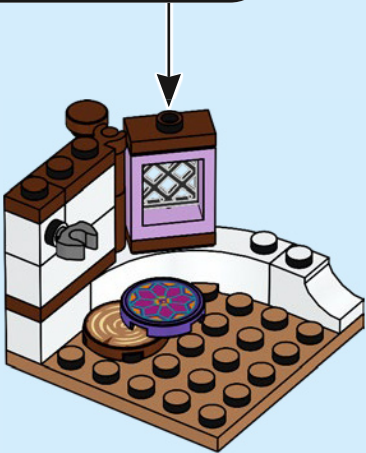
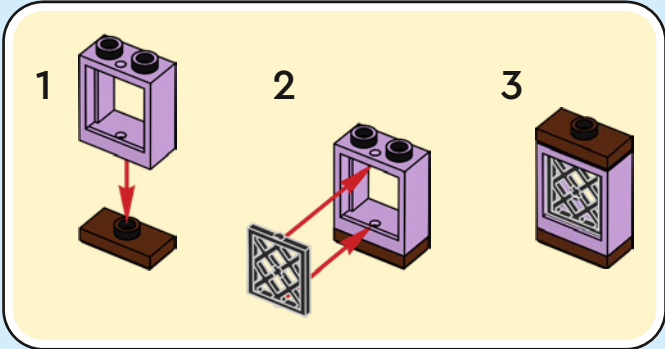



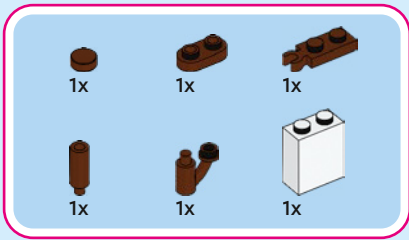

168

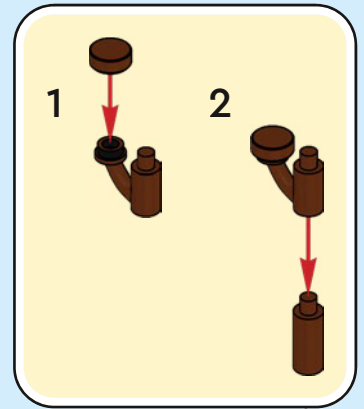

1

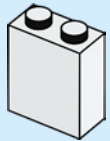

2

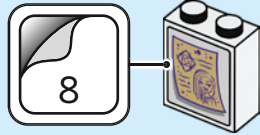

3



4



169



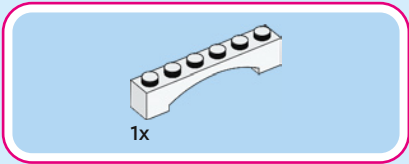

170





2x

171





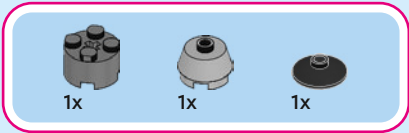

172

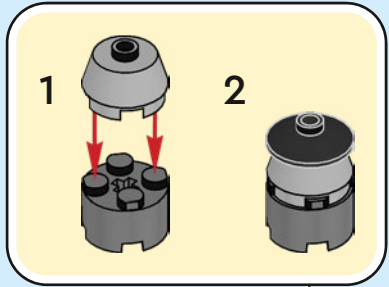

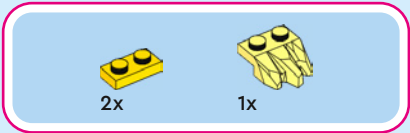

# 173

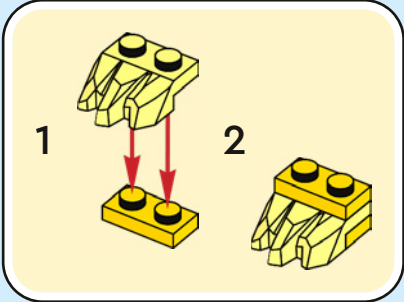



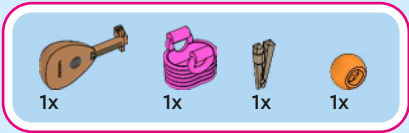

174

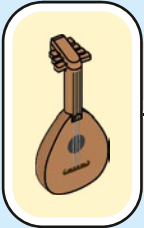
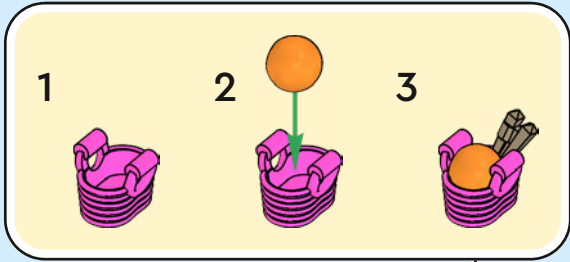

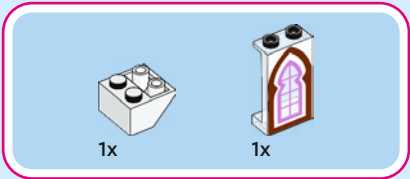

175

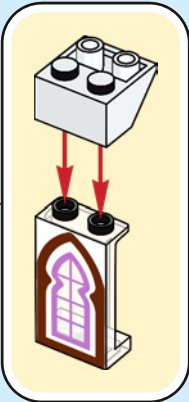

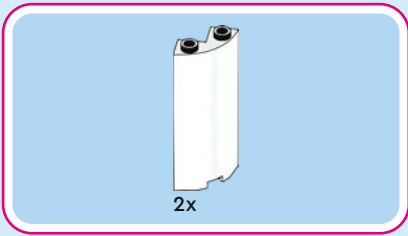

176







177

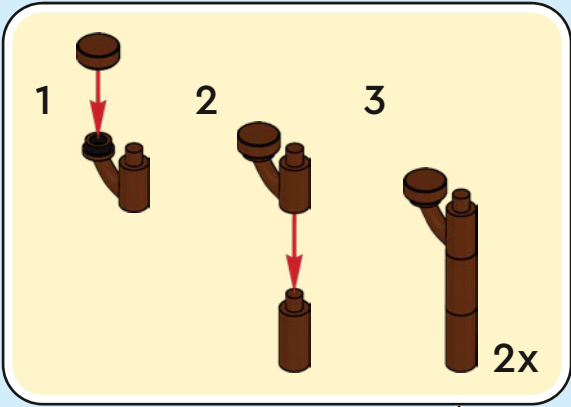

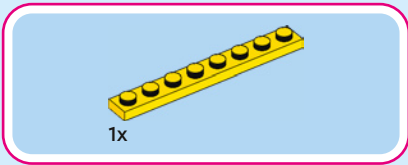

178



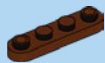

1x

179





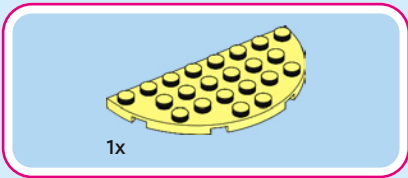

180





2x

181





2x



2x

182





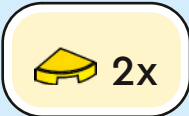
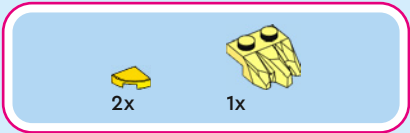

183



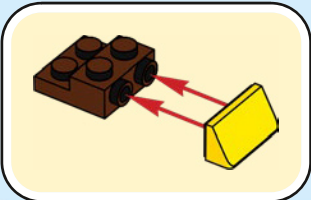
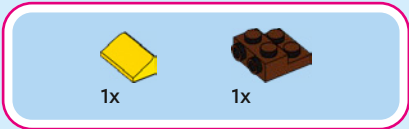

184





1x

185







2x

186





1x  
6424009

2x  
4558952

4x  
6055541

4x  
300501

2x  
6442360

1x  
407001

1x  
6455001

2x  
6235083

1x  
6132824

1x  
6262496

1x  
6320355

2x  
6382983

1x  
6093053

5x  
6346616

3x  
300401

1x  
306901

3x  
4113261

4x  
6058177

2x  
6337627

2x  
6343076

1x  
6366391

4x  
362201

2x  
365901

2x  
6256922

1x  
4620761

4x  
4113915

1x  
6462715

2x  
6114992

1x  
6462664

4x  
6334219

3x  
6046924

2x  
4162465

4x  
6232147

6x  
4113233

1x  
6115031

1x  
6466845

1x  
6463616

2x  
6195183

2x  
4201587

1x  
6455021

13x  
4550348

3x  
403224

2x  
302324

2x  
6029947

1x  
6146219

2x  
428624

2x  
6168616

2x  
4260192

2x  
371024

1x  
302024

1x  
346024

2x  
303424

2x  
6335388

2x  
302426

2x  
6477141

1x  
6173105

1x  
6432153

1x  
474026

1x  
452826

1x  
6325254

2x  
4188953

2x  
6229130

9x  
6374489

1x  
306928

1x  
6047426

2x  
4157120

1x  
302228

3x  
6268814

4x  
371028

1x  
6097413

1x  
6345559

1x  
6434871

2x  
6343326

2x  
6458988

2x  
6070517

1x  
6315197



2x  
6223655



1x  
6245306



1x  
6460897



1x  
6238046



1x  
6307452



2x  
6092770



2x  
4616279



2x  
6301806



7x  
6270179



1x  
6223065

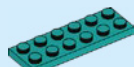

1x  
6259794

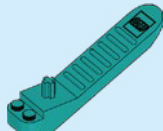

1x  
6254100



4x  
4183133



1x  
6215168



1x  
6468041



1x  
6096210



1x  
6337603



2x  
6253761



1x  
6361361



1x  
6245275



3x  
6035540



4x  
4626904



2x  
6035326



2x  
6156492



2x  
6384911



1x  
4249891



4x  
6392975



1x  
6407809



2x  
6100234



4x  
4539060



1x  
6219825



2x  
6028736



4x  
6408683



2x  
6097503



2x  
6097511



14x  
6422088



5x  
4529242



6x  
6284586



1x  
4626196



3x  
4221744



4x  
6149677



2x  
4225469



8x  
6433717



1x  
6167879



1x  
6462663



6x  
6248944



2x  
6153863



1x  
6337003



1x  
6462435



4x  
4211150



2x  
6075287



4x  
6186045



4x  
6092590



4x  
6069984



2x  
6382102



1x  
6151461



4x  
6459597



2x  
6409552



6x  
6146301



3x  
4211152



1x  
6326087



1x  
6463591



1x  
6116613



1x  
4216625



1x  
6132732



2x  
6257604



4x  
6416695



2x  
4211186



2x  
6458992



1x  
6177998



4x  
4221590



4x  
4211412



1x  
6401023



2x  
6408629



1x  
4568637



2x  
6211917



1x  
4211564



6x  
4211398



4x  
6066097



1x  
6028324



1x  
4211397



4x  
4211881



1x  
4654577



1x  
6326483

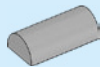

1x  
4518653



2x  
4211395



1x  
4211425



5x  
4210633



1x  
6439040



2x  
4211098



2x  
6115080



1x  
4249139



4x  
6352694



1x  
6343852



2x  
4211053



1x  
6306725



7x  
6206151



1x  
6096094



3x  
6212501



1x  
6455026



4x  
6463587



2x  
6296495



23x  
6458991



2x  
6462407



2x  
6248756



2x  
6344840



1x  
6476004



1x  
6175294



1x  
6249404



1x  
6097501



1x  
6455027



1x  
6462709



2x  
6477142



1x  
6455310



4x  
6167641



1x  
6454983



4x  
6380634



1x  
6368592



1x  
6167643



2x  
4651231



2x  
6334102



4x  
6344798



1x  
6460972



1x  
6371952



2x  
6126118



2x  
6102998



1x  
6218359



1x  
6226644



2x  
6346466



1x  
6218145



1x  
6351301



1x  
6361354



1x  
6363148



1x  
6145255



4x  
4651903



1x  
6458987



2x  
6458985

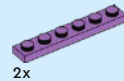

2x  
4649745



1x  
6461097



2x  
6422081



4x  
6460896



1x  
6455022



1x  
6462655

 [LEGO.com/service](https://www.LEGO.com/service)





YOU COULD **WIN**



Scan this QR code or go to **LEGO.COM/PRODUCTFEEDBACK** and give us your short feedback about this LEGO® set for a chance to win a cool LEGO prize.

Terms and Conditions apply\*

**EN: YOU COULD WIN.** Terms and Conditions apply\* **DE: Du könntest GEWINNEN.** Es gelten die Teilnahmebedingungen\* **FR: Tu pourrais GAGNER.** Des conditions s'appliquent\* **IT: Potresti VINCERE tu.** Termini e condizioni sono applicabili\* **ES: Puedes GANAR.** Aplican términos y condiciones\* **PT: Poderá GANHAR.** Aplicam-se termos e condições\* **ZH: 轻松获奖. 条款和条件适用\*** **PL: Szansa na WYGRANĄ.** Obowiązują warunki korzystania\* **CS: Máte šanci VYHRÁT.** Platí všeobecné smluvní podmínky\* **SK: Máte šancu VYHRAŤ.** Platia všeobecné zmluvné podmienky\* **HU: TE IS NYERHETSZ.** Felhasználási feltételek érvényesek\* **RO: Ai putea CÂȘTIGA.** Se aplică termeni și condiții\* **BG: Можете да СПЕЧЕЛИТЕ.** Има определени правила и условия\* **LV: Tu vari LAIMĒT.** Ir spēkā noteikumi un nosacījumi.\* **ET: Sul on võimalus VÕITA.** Kehtivad tingimused\* **LT: Jūs galite LAIMĖTI.** Taikomos sąlygos\*

\*[LEGO.com/productfeedback-terms](https://www.lego.com/productfeedback-terms)