



43242

# Disney *Snow White* and the Seven Dwarfs



Booklet available in English on  
Livret disponible en français sur  
Folleto disponible en español en

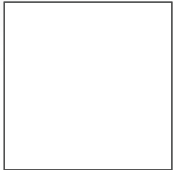



## WE'RE MAKING OUR PACKAGING MORE SUSTAINABLE

We're transitioning from single-use plastic to paper-based packaging. As we progress, you may find a mix of paper and plastic in our boxes.

## NOUS RENDONS NOS EMBALLAGES PLUS DURABLES

Nous passons des emballages en plastique à usage unique aux emballages à base de papier. Durant la transition, vous pourriez trouver un mélange de papier et de plastique dans nos boîtes.

## QUEREMOS HACER MÁS SUSTENTABLES NUESTROS MATERIALES DE EMBALAJE

Estamos cambiando las bolsas de plástico desechables por bolsas con base de papel. Conforme avanzamos en este propósito, puedes encontrar una mezcla de papel y de plástico en nuestras cajas.

[LEGO.com/sustainable-packaging](https://LEGO.com/sustainable-packaging)



# BUILDER



Apple and the Apple logo are trademarks of Apple Inc., registered in the U.S. and other countries and regions. App Store is a service mark of Apple Inc. Google Play and the Google Play logo are trademarks of Google LLC. Tencent and the Tencent logo are trademarks of Tencent Inc.

LEGO.com/devicecheck



LEGO® Builder

## Once upon a time

A princess named Snow White captivated audiences worldwide in the first-ever-full-length animated Disney movie.

## Il était une fois

Une princesse nommée Blanche-Neige, qui a enchanté les spectateurs du monde entier dans le tout premier long métrage d'animation de Disney.

## Había una vez

Una princesa llamada Blanca Nieves que cautivó al público de todo el mundo en el primer largometraje de animación Disney.





Get ready for a LEGO® building experience that takes you on a magical journey through Snow White's world. Make a wish at the wishing well, make yourself at home in the iconic, cozy cottage and break the Evil Queen's spell to give Snow White her happily ever after.

**“It was a magical experience to explore the beautiful details of the movie and capture them in LEGO® form.”**

– Ryan Baird-Van Woerkom, LEGO® Designer

Préparez-vous à vivre une expérience de construction LEGO® qui vous fera voyager dans le monde magique de Blanche-Neige. Faites un vœu au puits, installez-vous dans la chaumière emblématique et douillette et brisez le sortilège de la méchante reine pour que Blanche-Neige vive heureuse pour toujours.

**« Découvrir les magnifiques détails du film et les reproduire sous forme LEGO® a été une expérience magique. »**

– Ryan Baird-Van Woerkom, concepteur LEGO®

Prepárate para adentrarte en una experiencia de construcción LEGO® que te llevará a vivir un mágico viaje a través del mundo de Blanca Nieves. Píde un deseo en el pozo de los deseos, siéntete como en casa en la inconfundible y acogedora cabaña, y rompe el hechizo de la Reina Malvada para que Blanca Nieves sea feliz para siempre.

**“Explorar los hermosos detalles de la película y plasmarlos en formato LEGO® fue una experiencia mágica”.**

– Ryan Baird-Van Woerkom, diseñador de LEGO®

## An icon in the making

Walt Disney believed so strongly in his vision of a full-length animated movie and worked tirelessly to bring Snow White and the Seven Dwarfs to the big screen. To recreate lifelike movements and facial expressions, animators used models, dancers and actors as references.

## Un symbole en devenir

Walt Disney croyait fermement en son projet de long métrage d'animation et a travaillé sans relâche pour porter *Blanche-Neige et les sept nains* sur grand écran. Pour recréer des mouvements et des expressions faciales réalistes, les animateurs ont utilisé des modèles, des danseurs et des acteurs comme références.

## El nacimiento de un ícono

Walt Disney creía firmemente en su visión de un largometraje de animación y trabajó incansablemente para llevar Blanca Nieves y los Siete Enanos a la gran pantalla. Para recrear los movimientos y expresiones faciales de los personajes con el máximo realismo, los animadores usaron modelos, bailarines y actores como referencia.





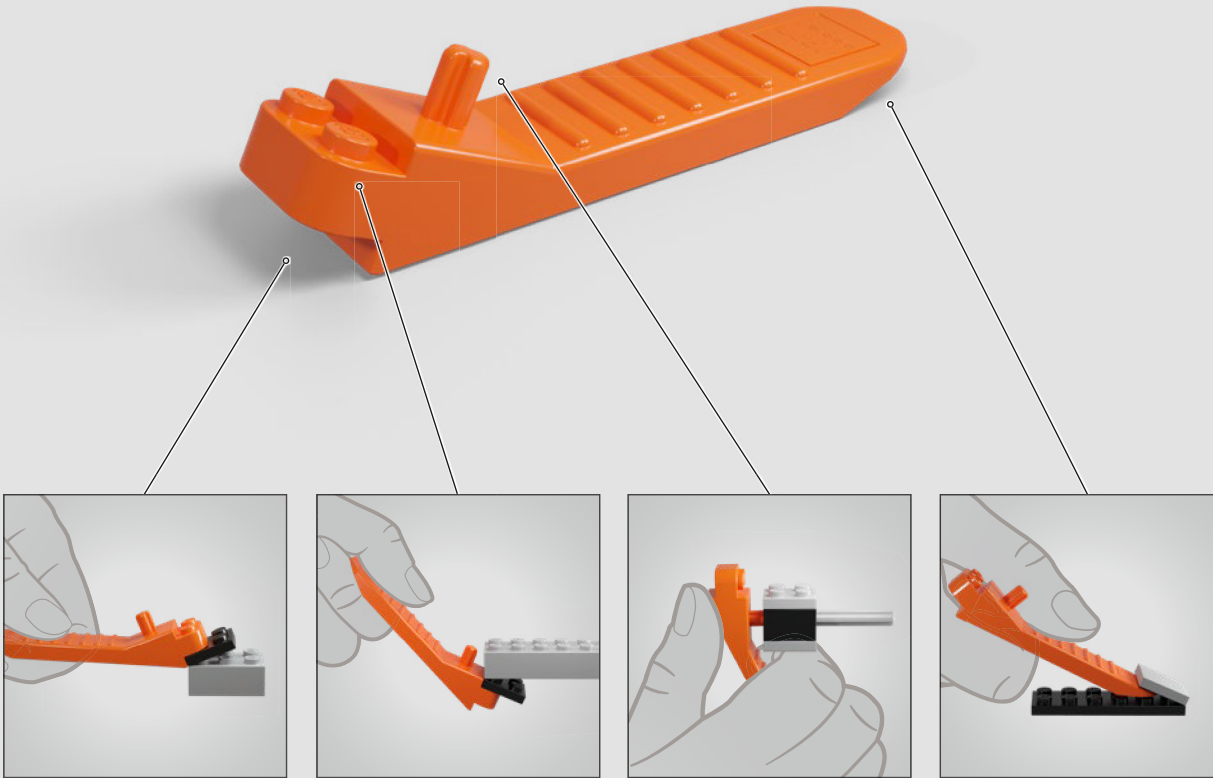





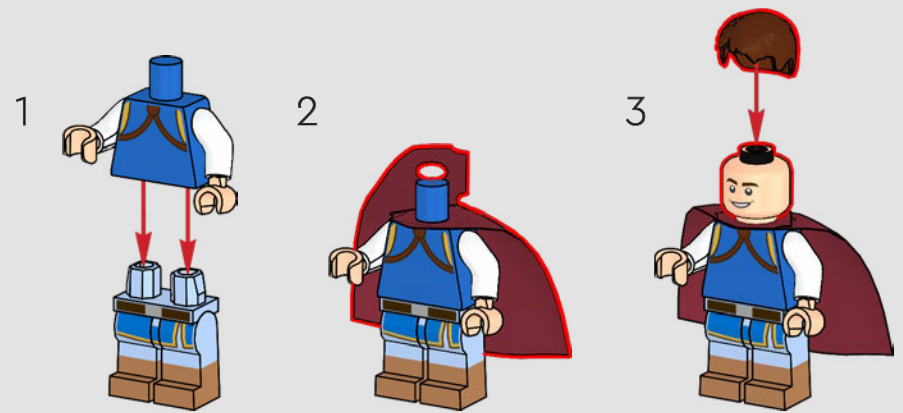
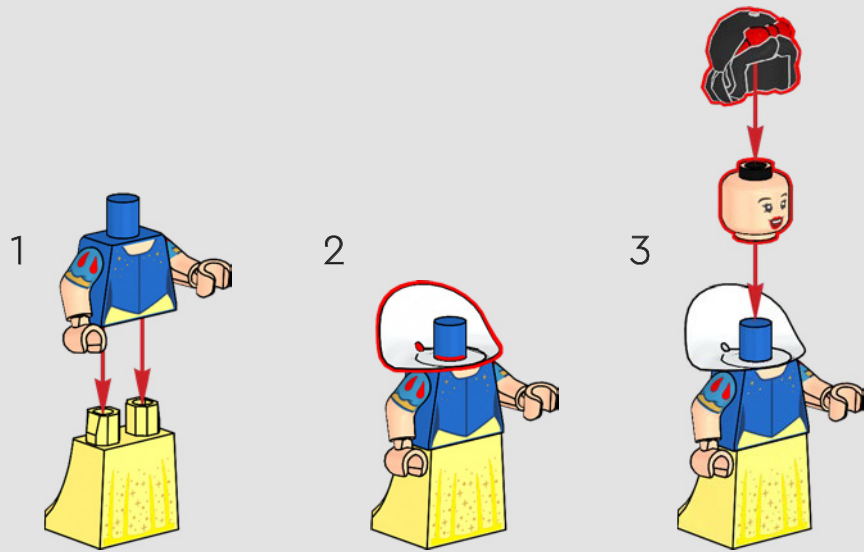

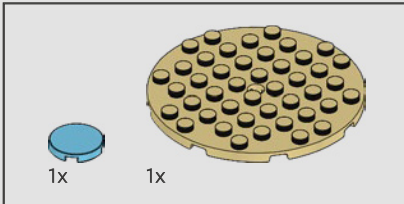

1

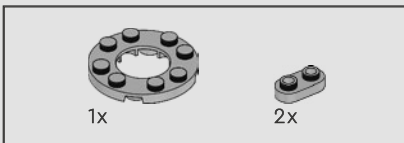
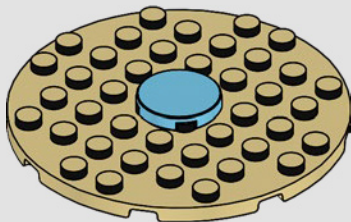

2

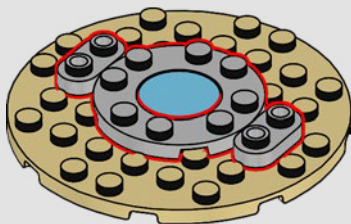

3

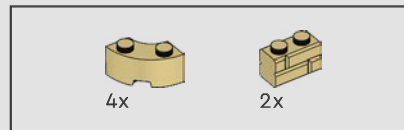
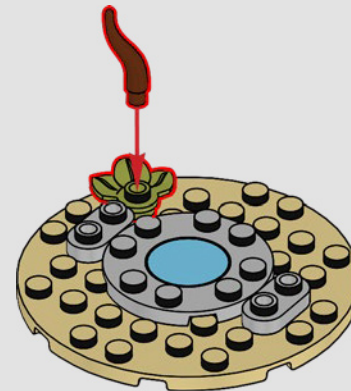

4

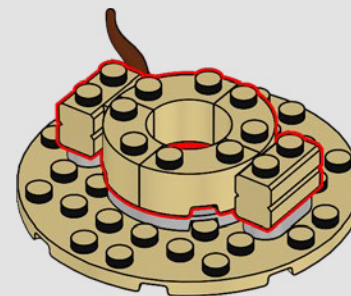



2x

5

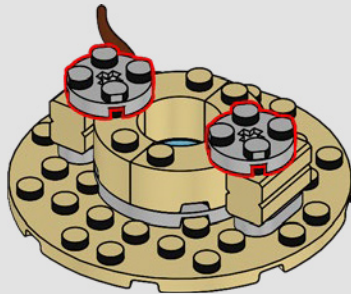

2x

6

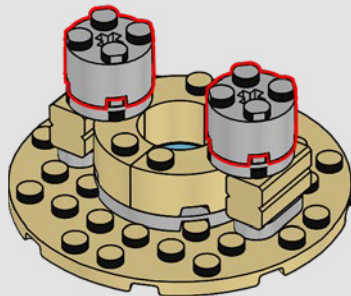

2x

7

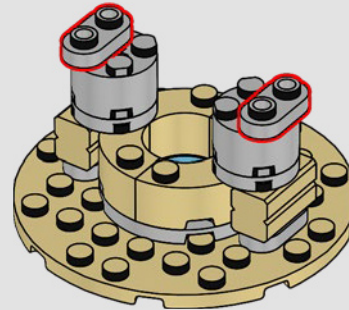

2x

8

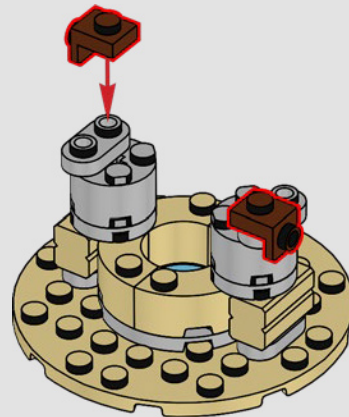



9

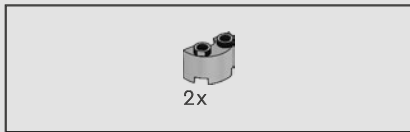
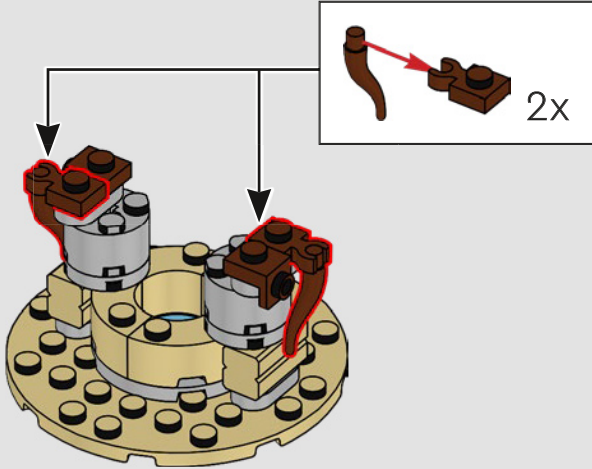

10

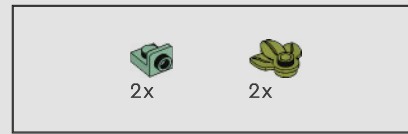
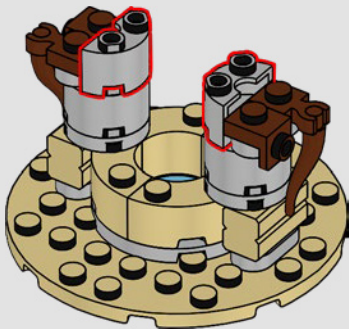

11

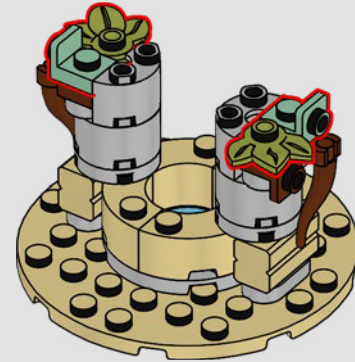

12

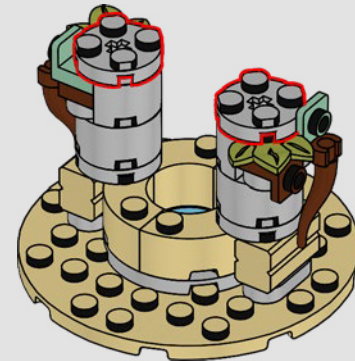



4x

13

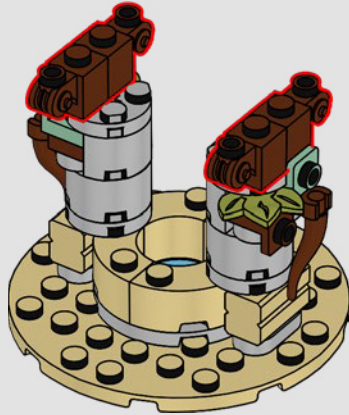

1x



1x

14

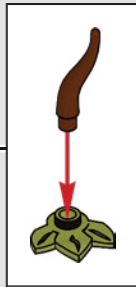
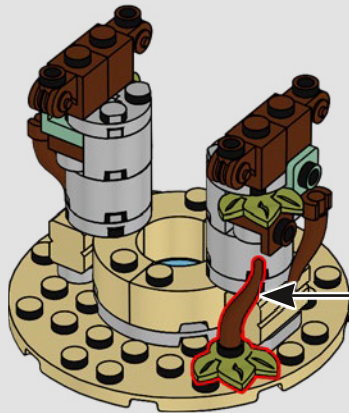

2x



2x

15

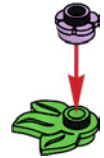
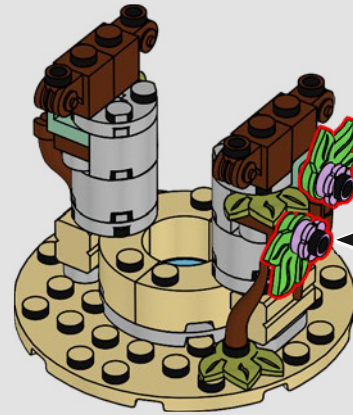

2x





16

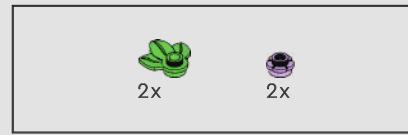
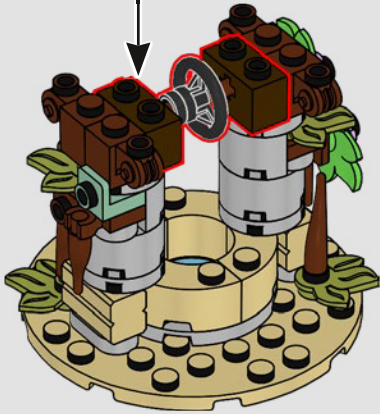
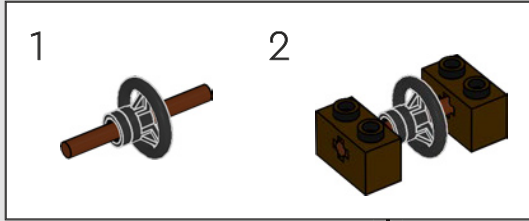

17

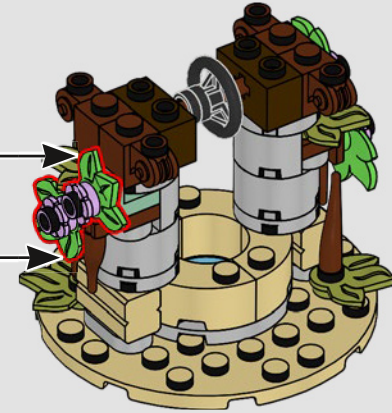
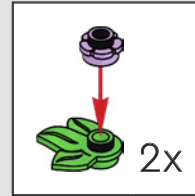

18

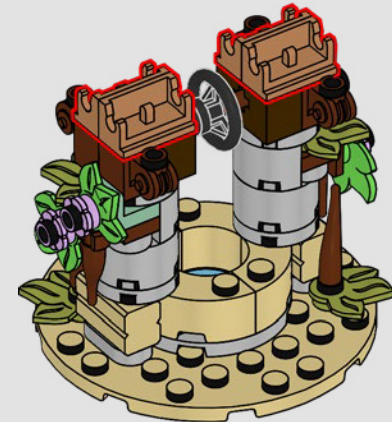



4x

19

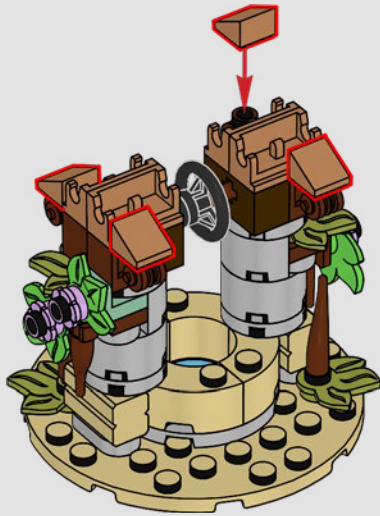

1x



1x



2x

20

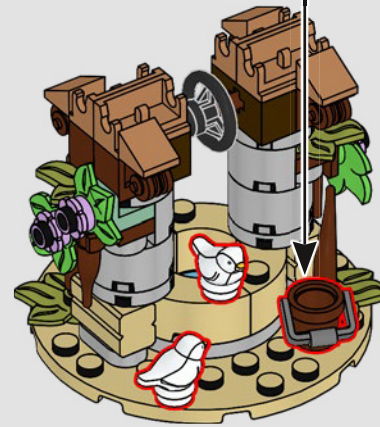
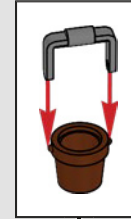



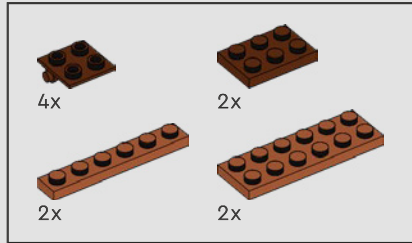
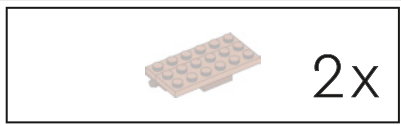

21

1

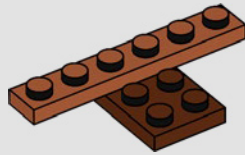

2

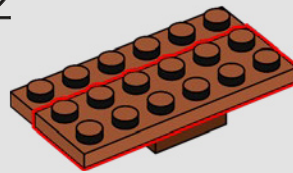

3

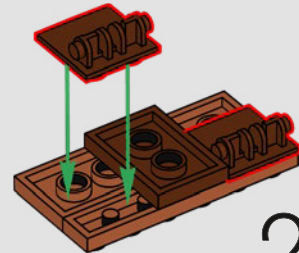

2x





10x



10x

22

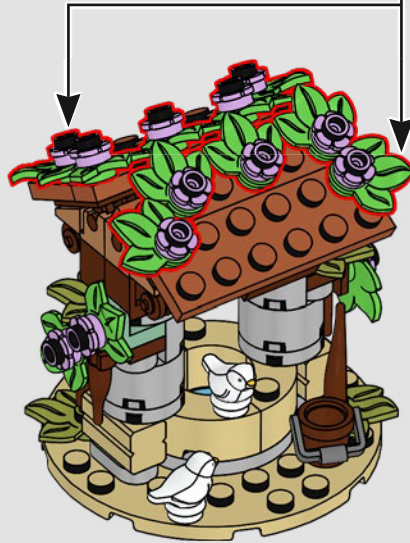
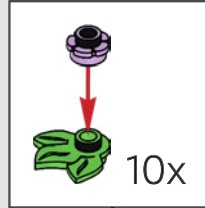

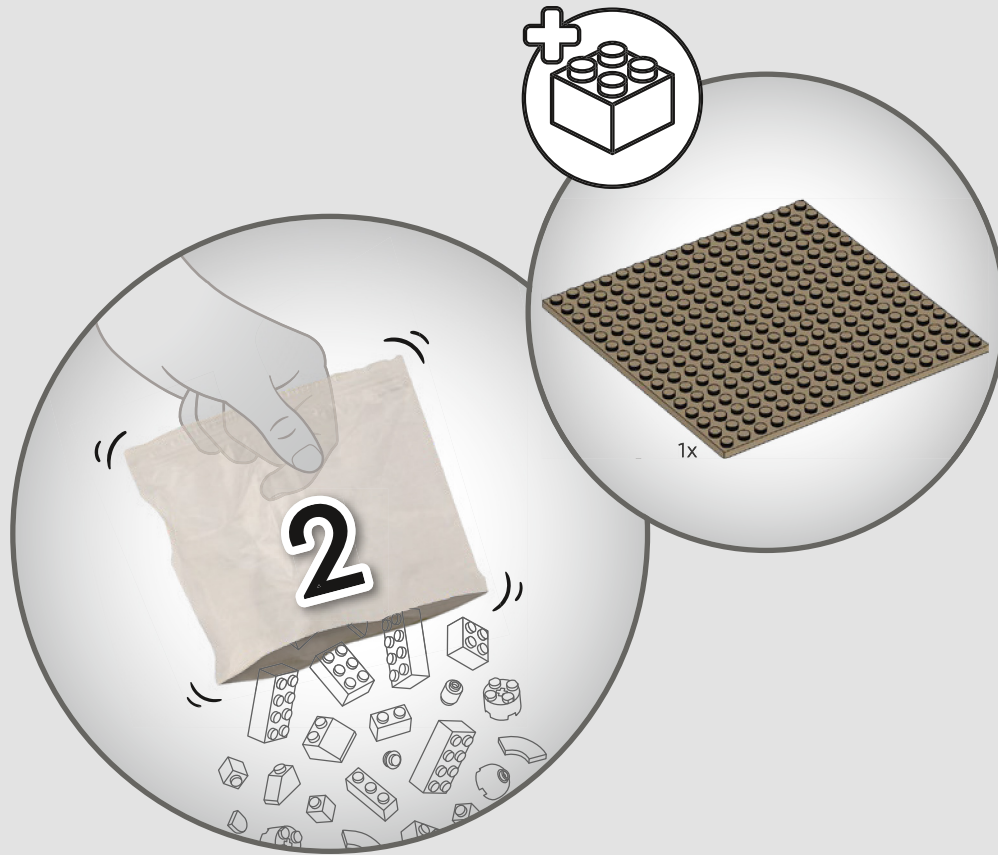

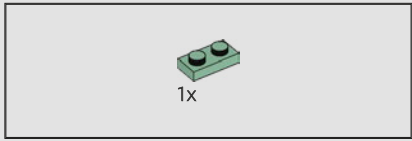
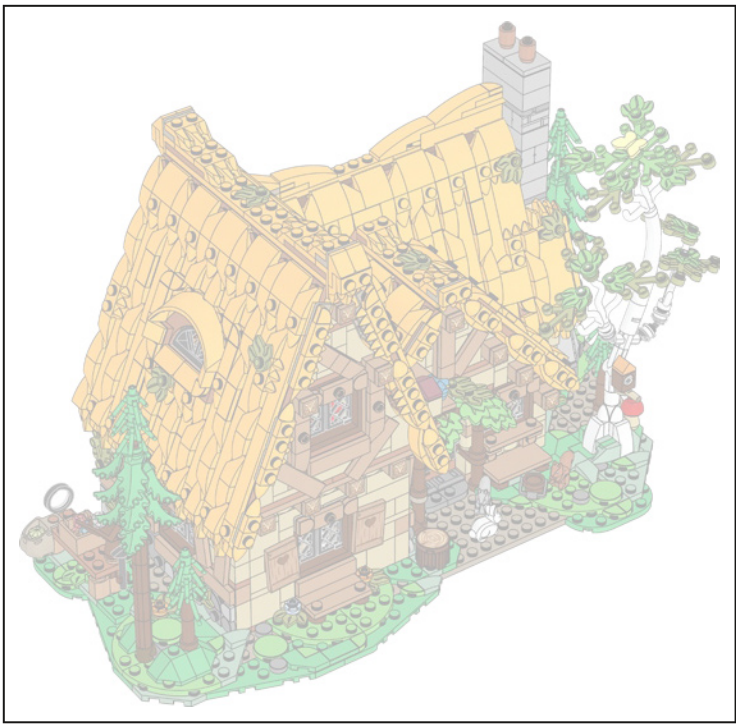

1

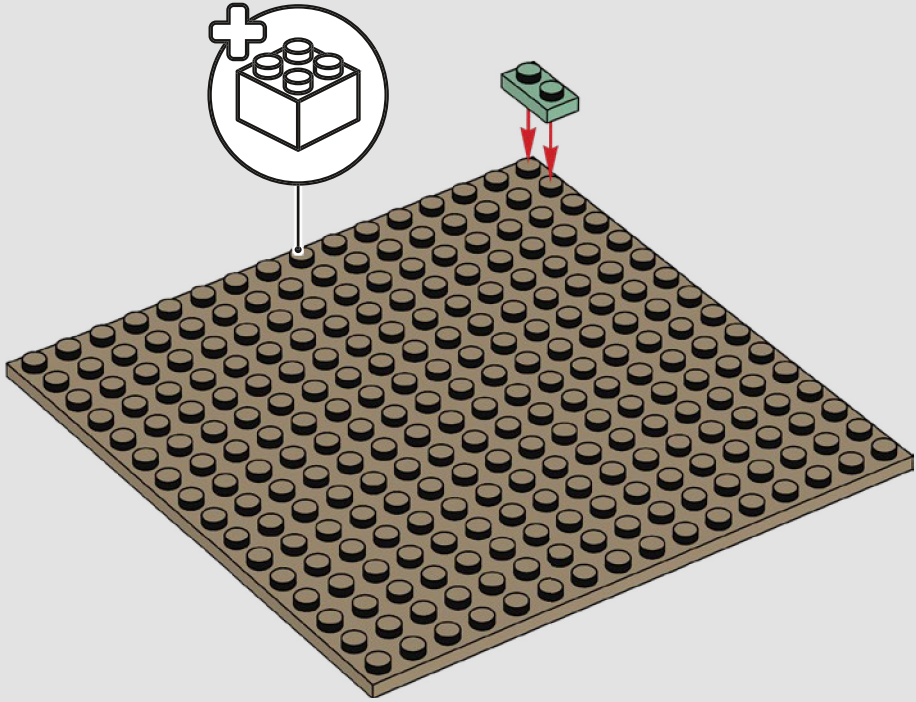

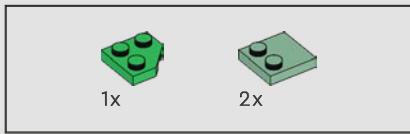

2

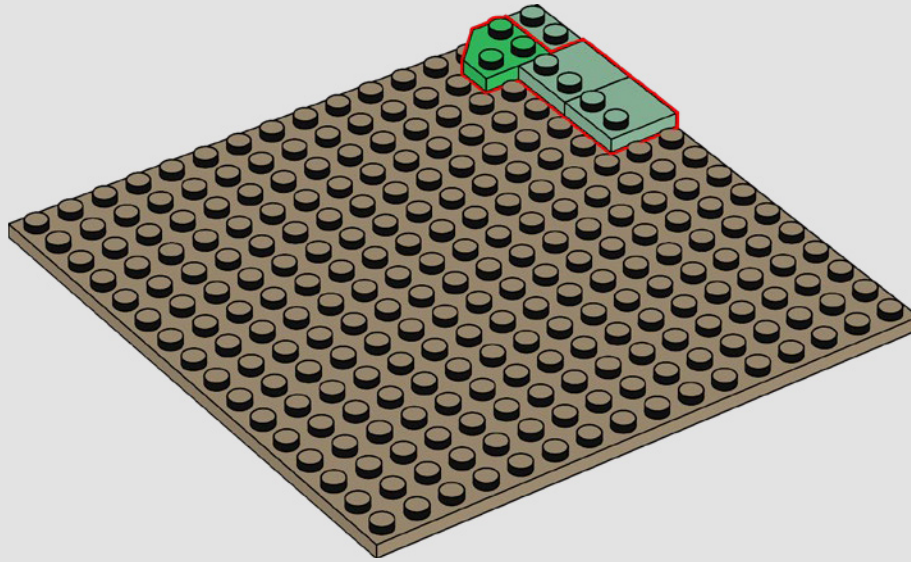

3

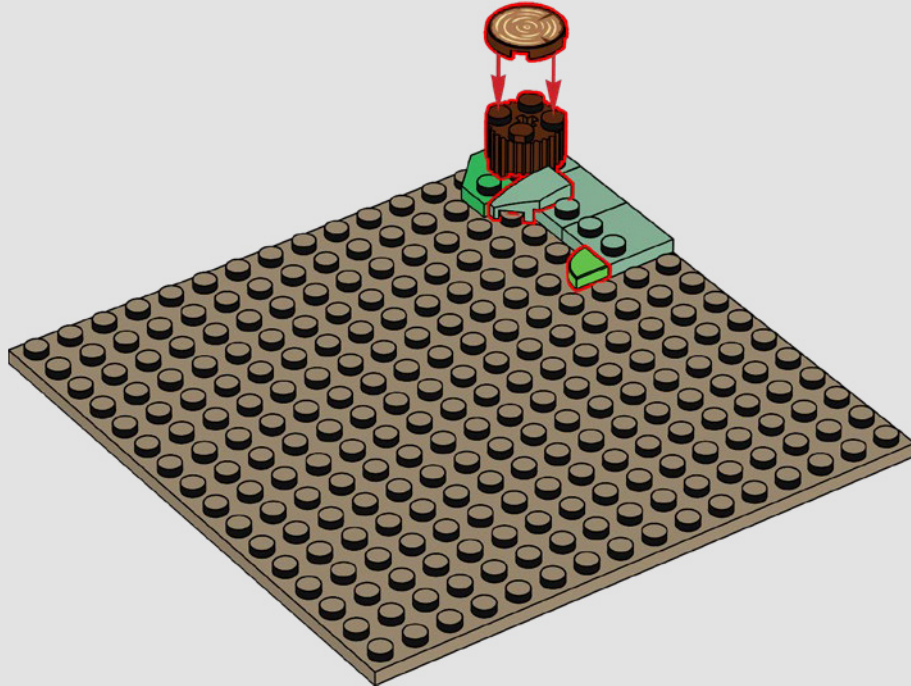



4

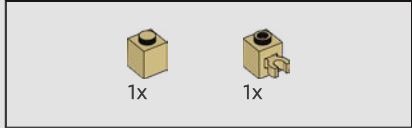
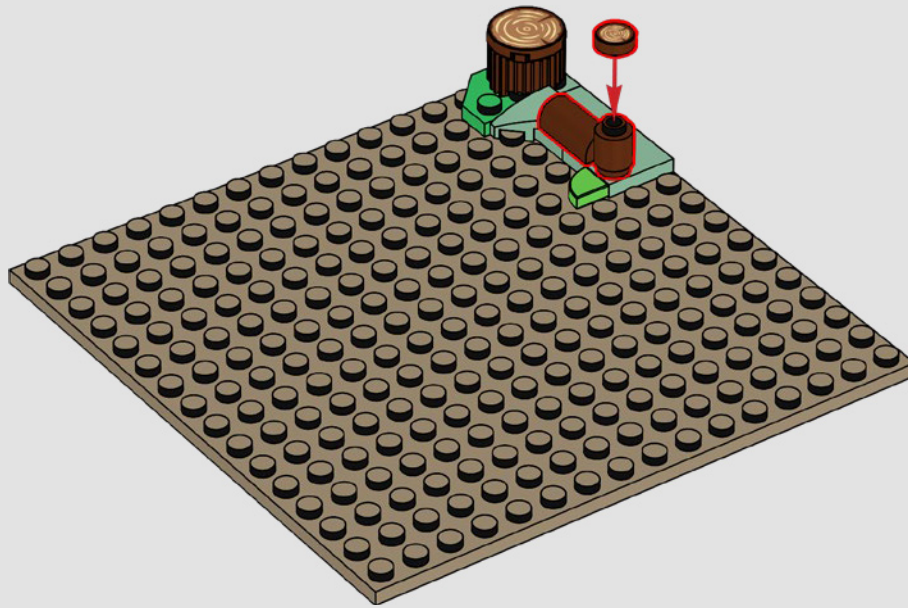

5

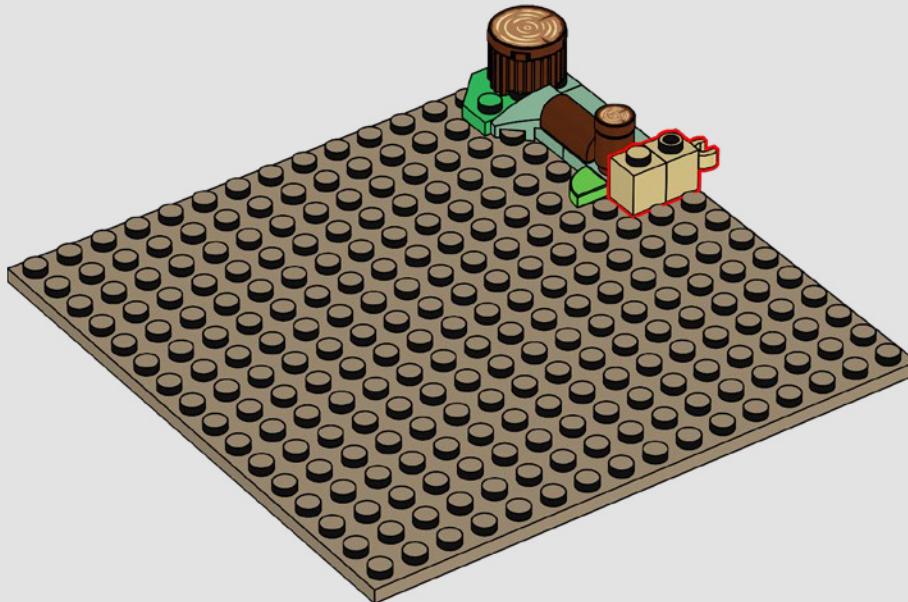

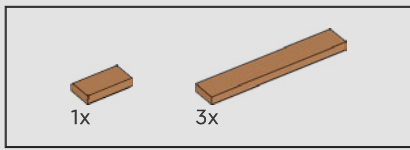

6

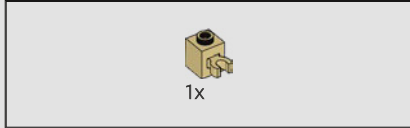
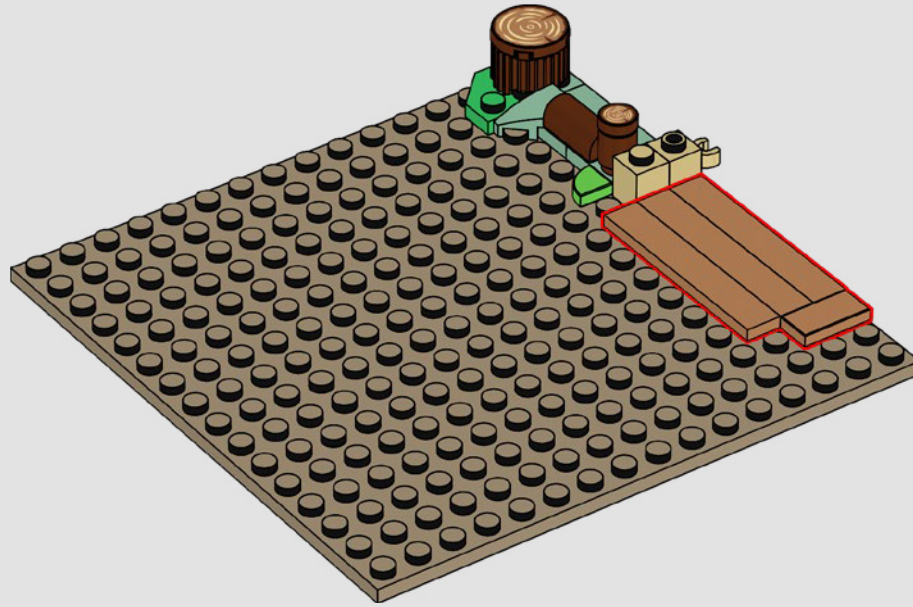

7

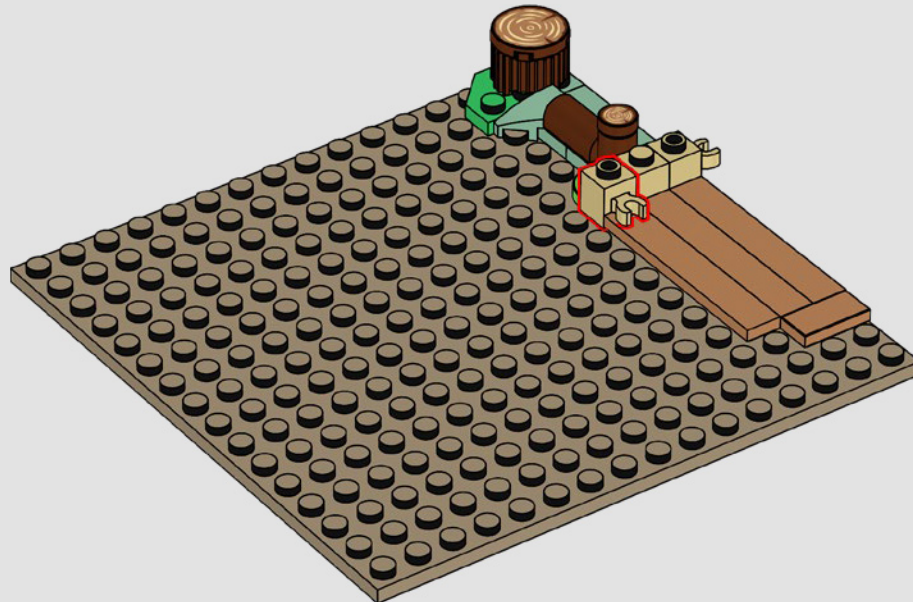

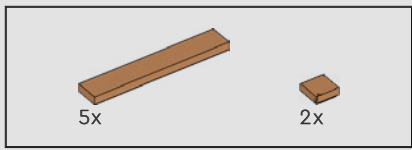

8

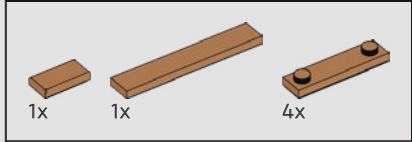
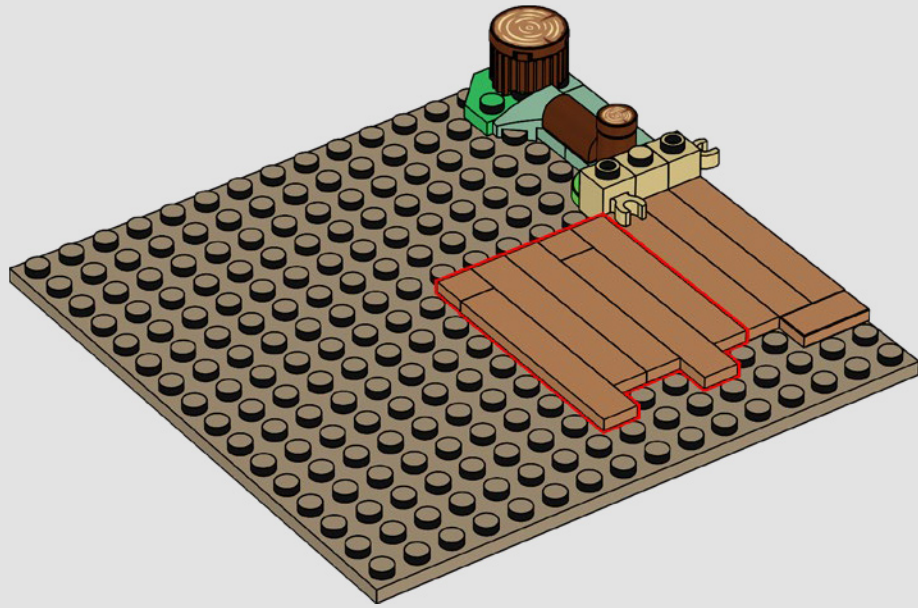

9

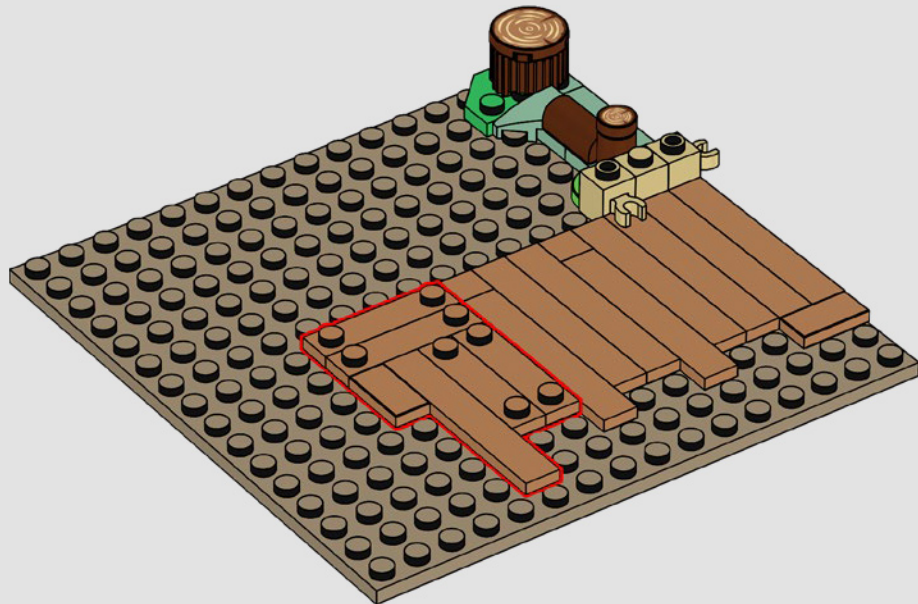



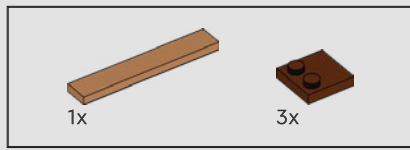

10

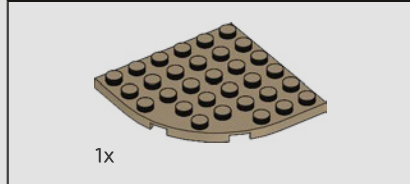
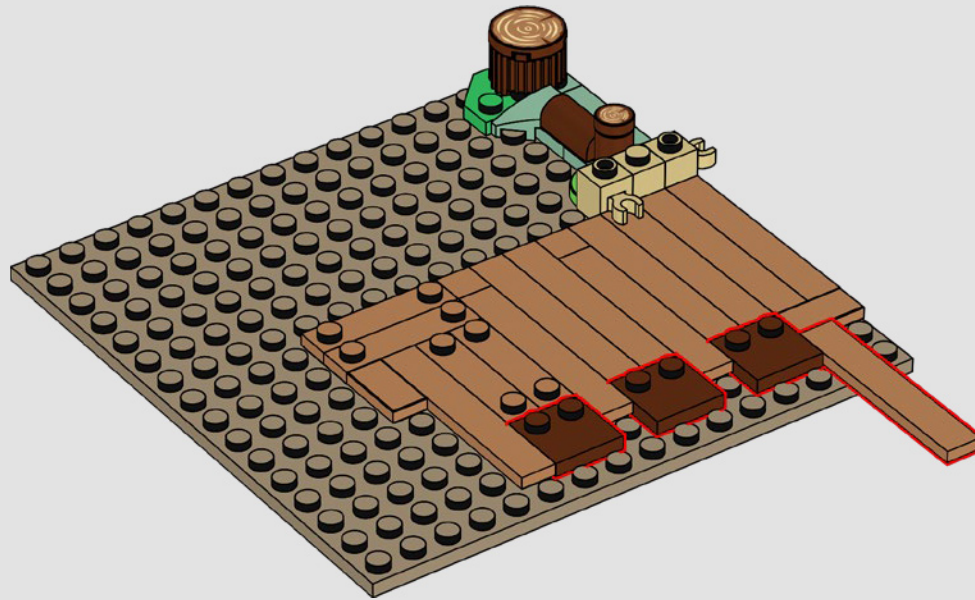

11

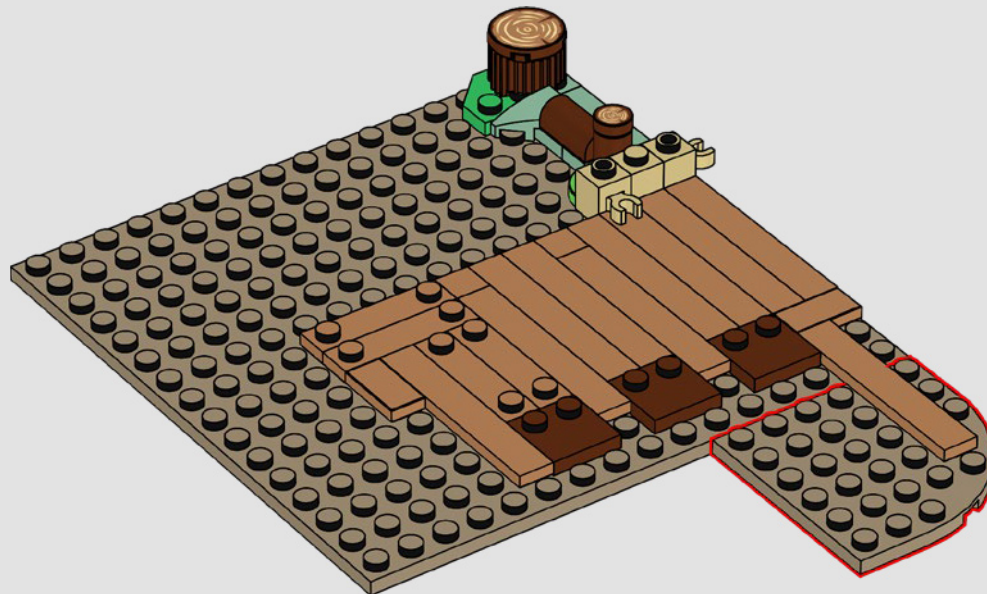

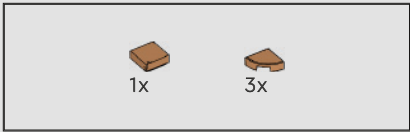

12

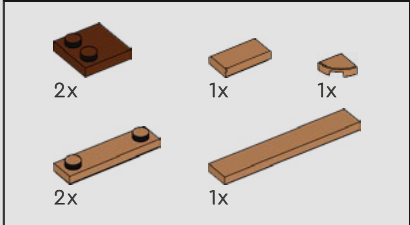
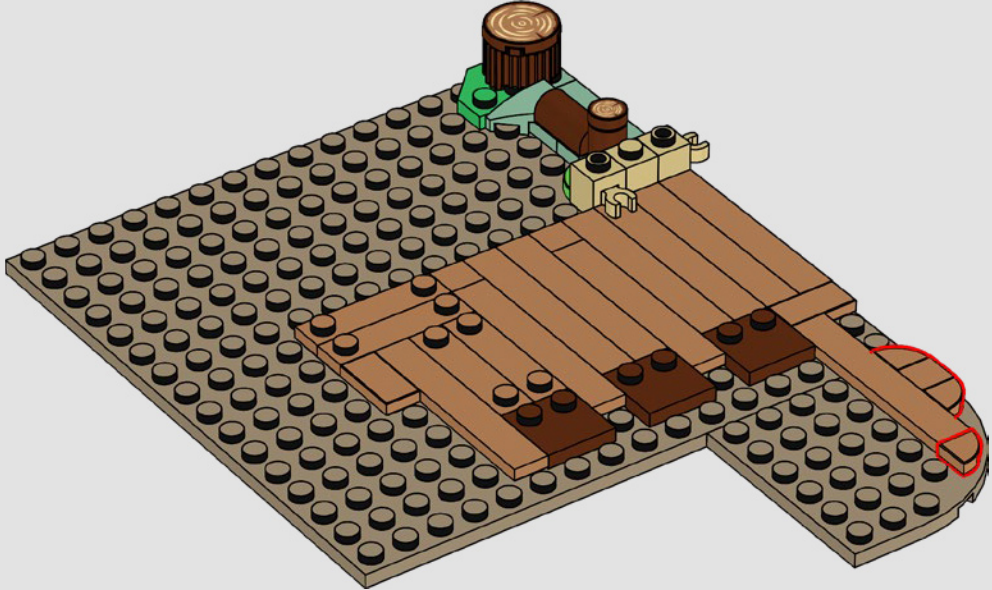

13

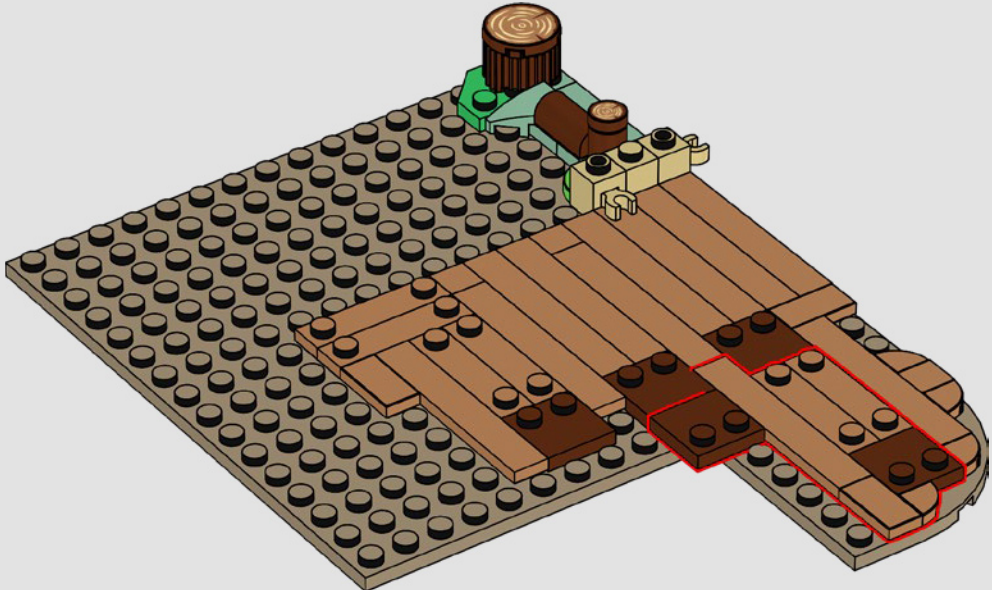

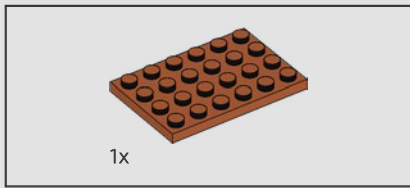

14

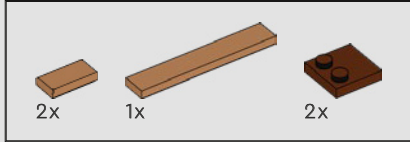
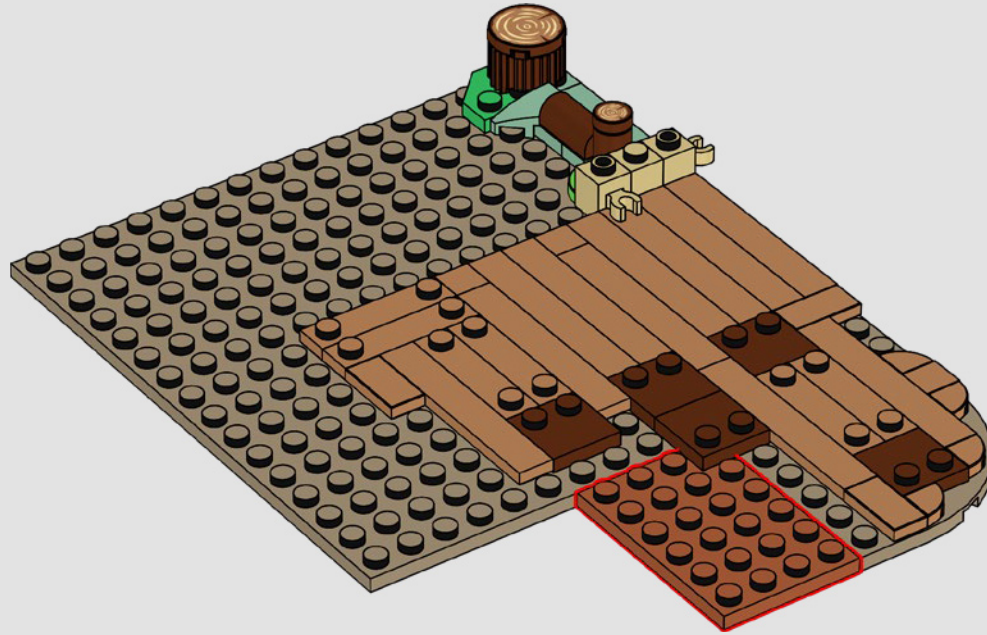

15

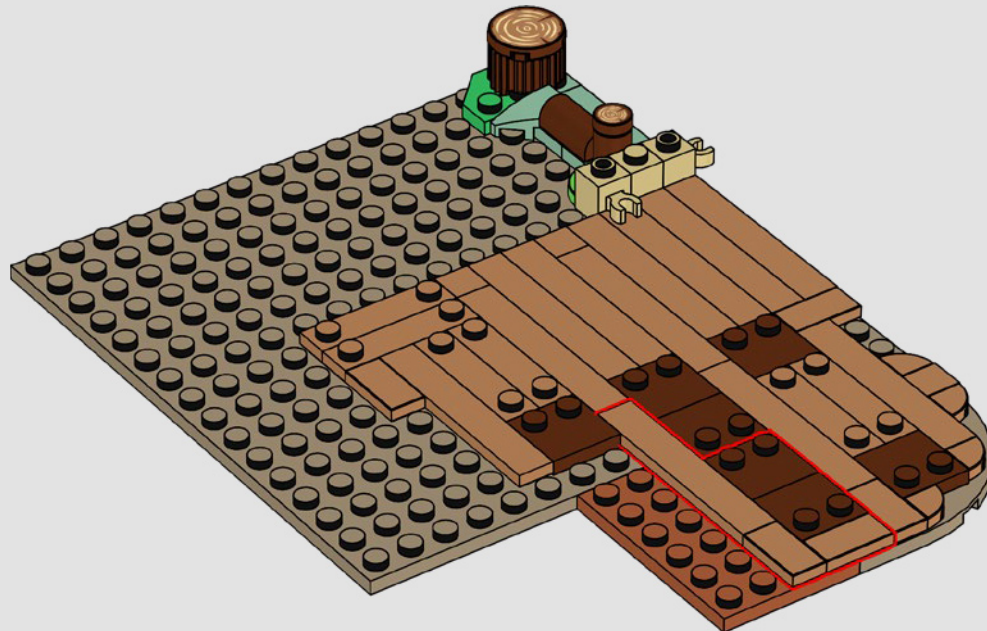

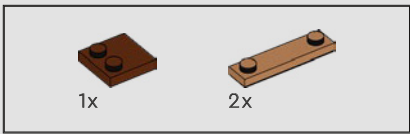

16

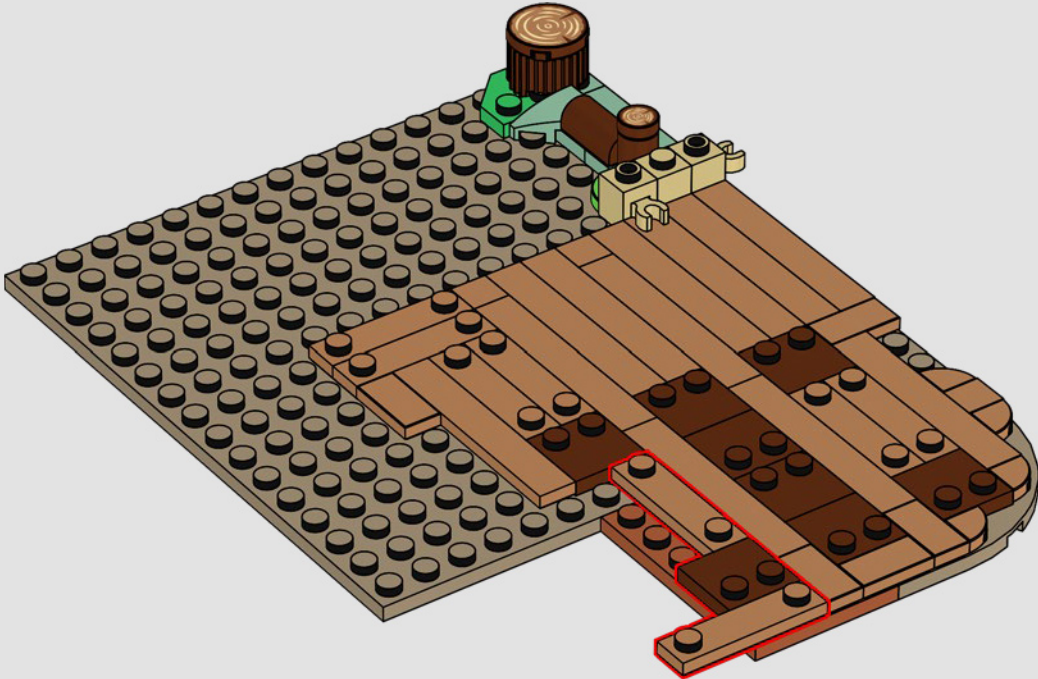

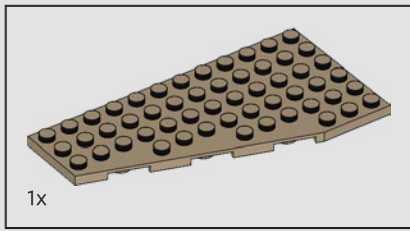

17

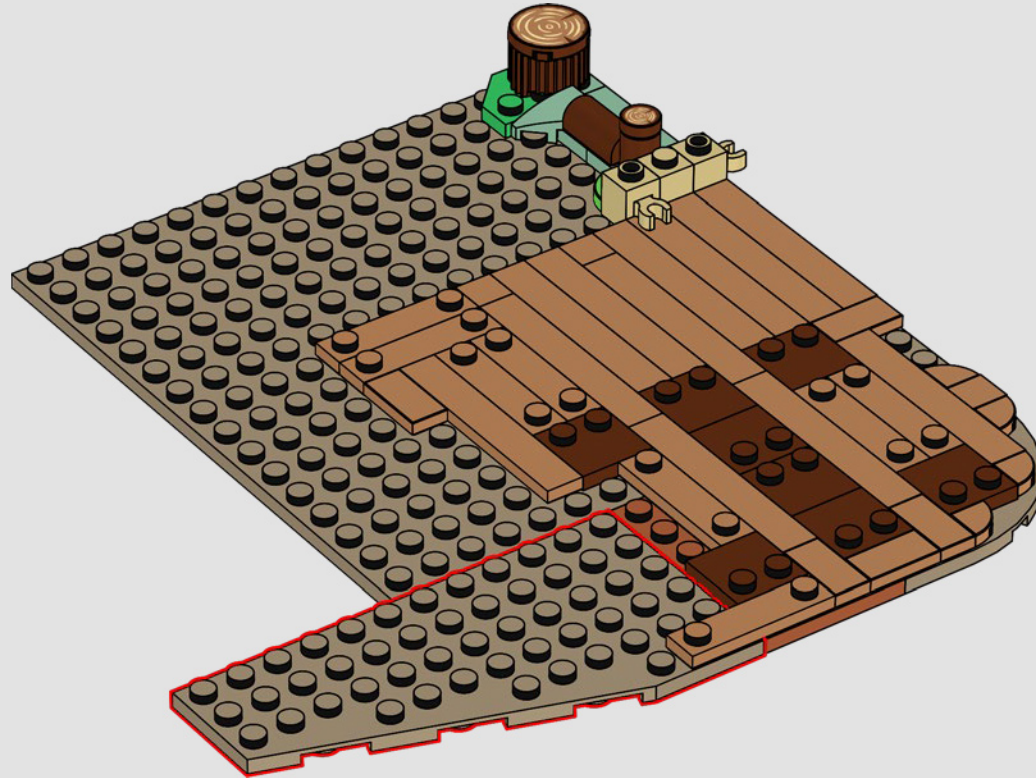

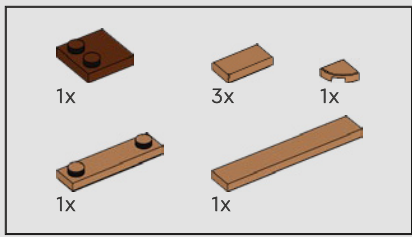

18

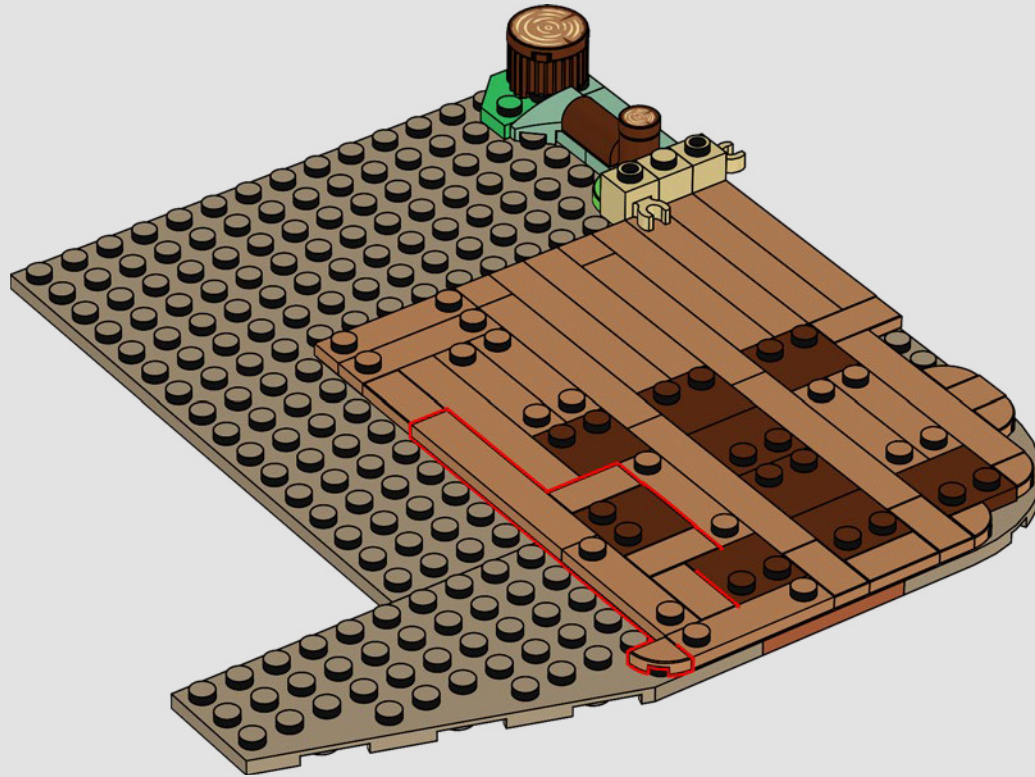

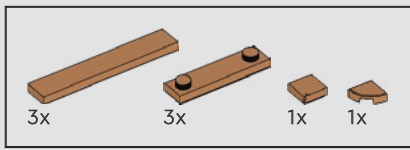

19

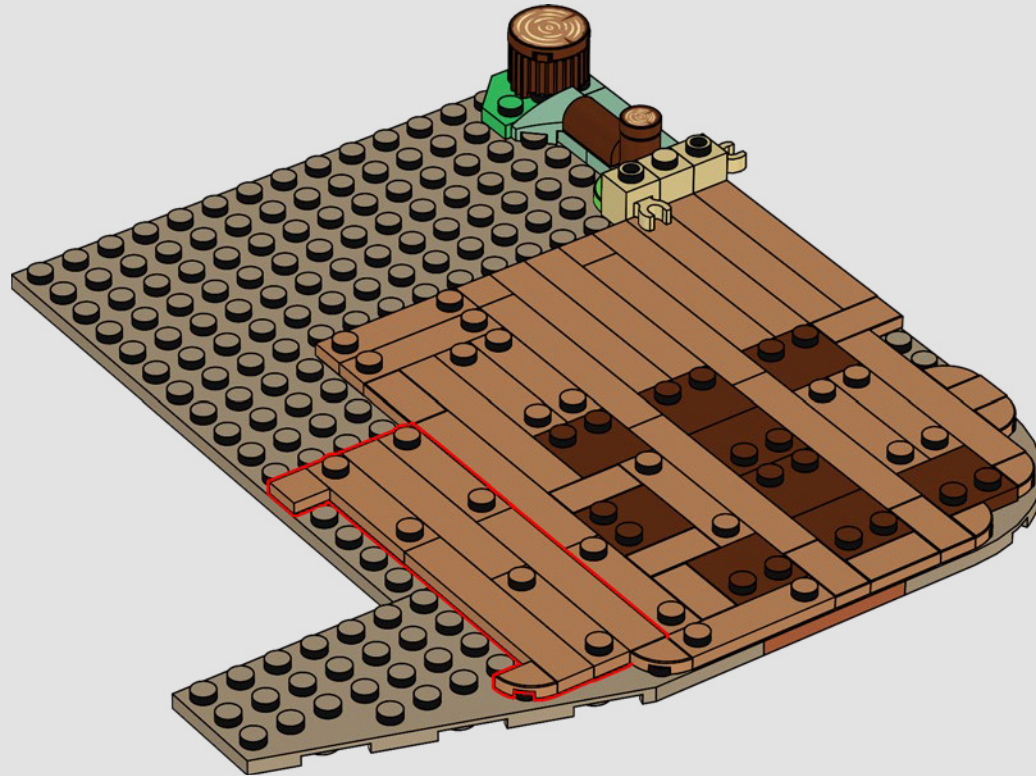

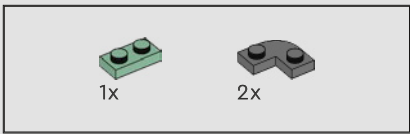

20

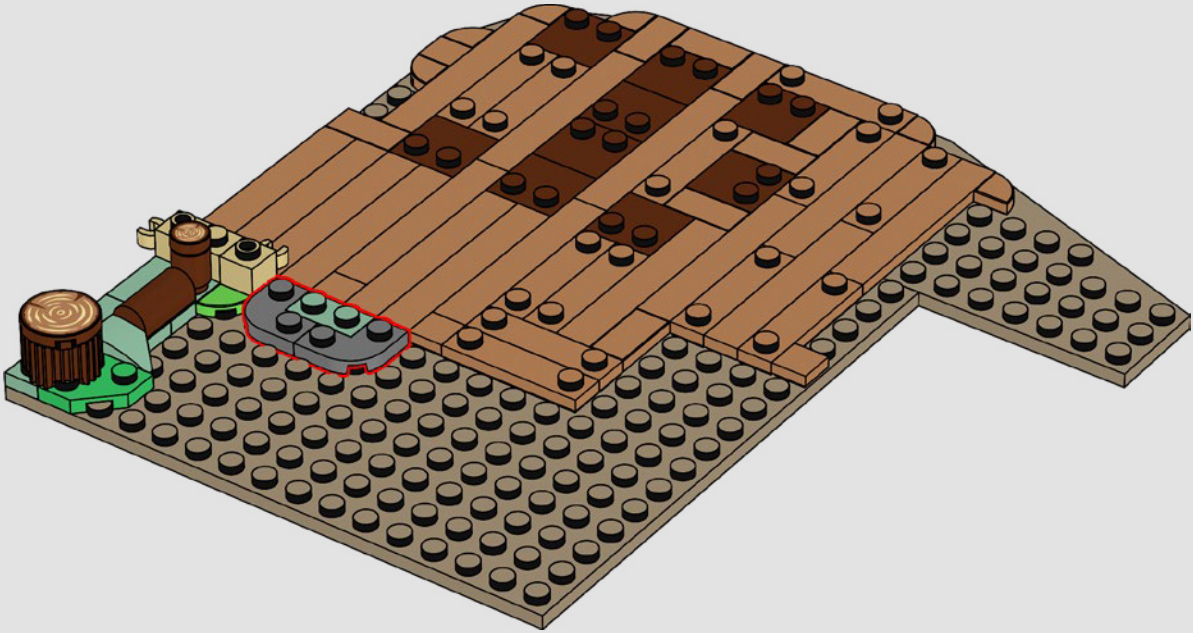

21

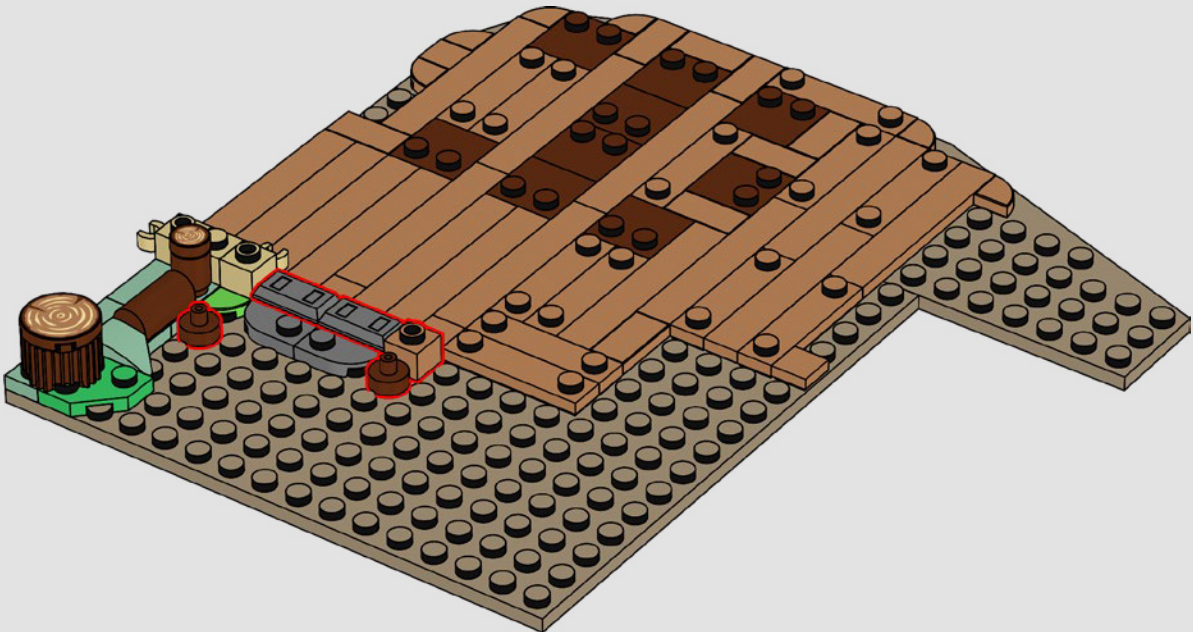



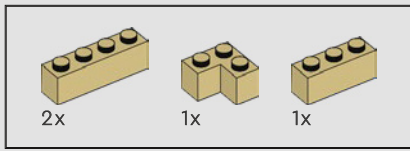

22

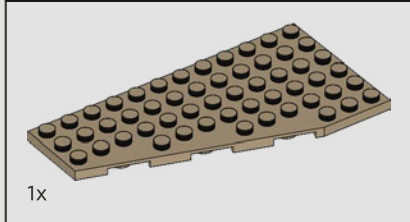
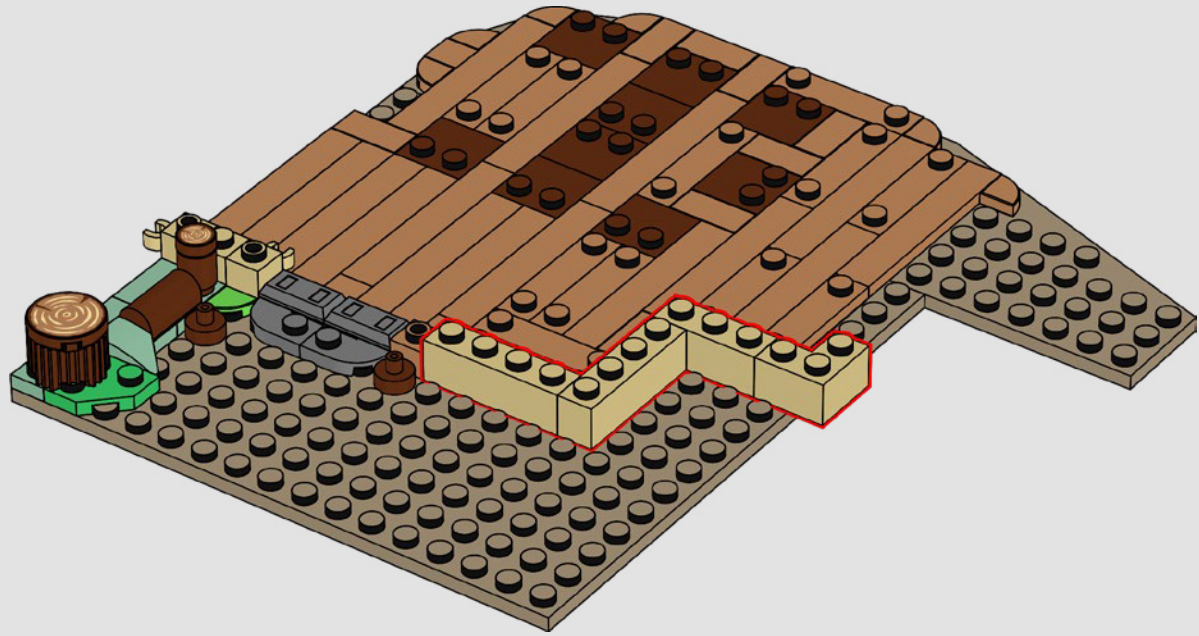

23

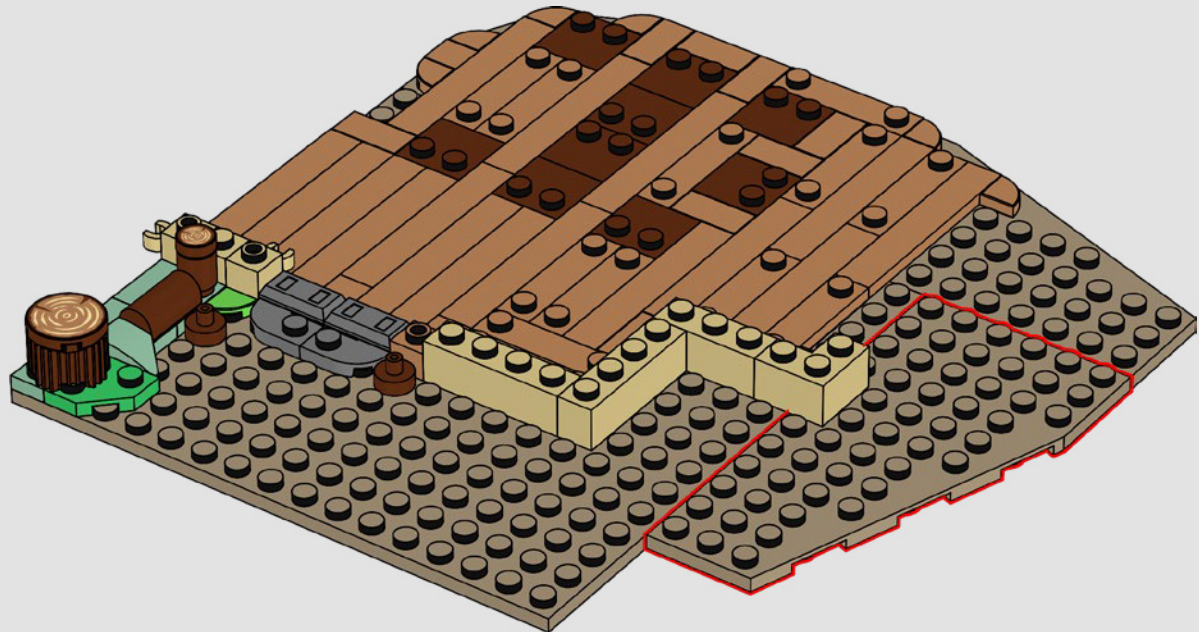

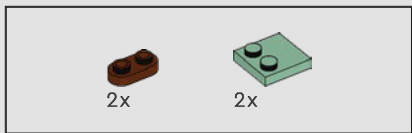

24

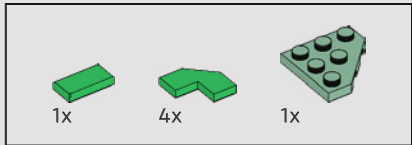
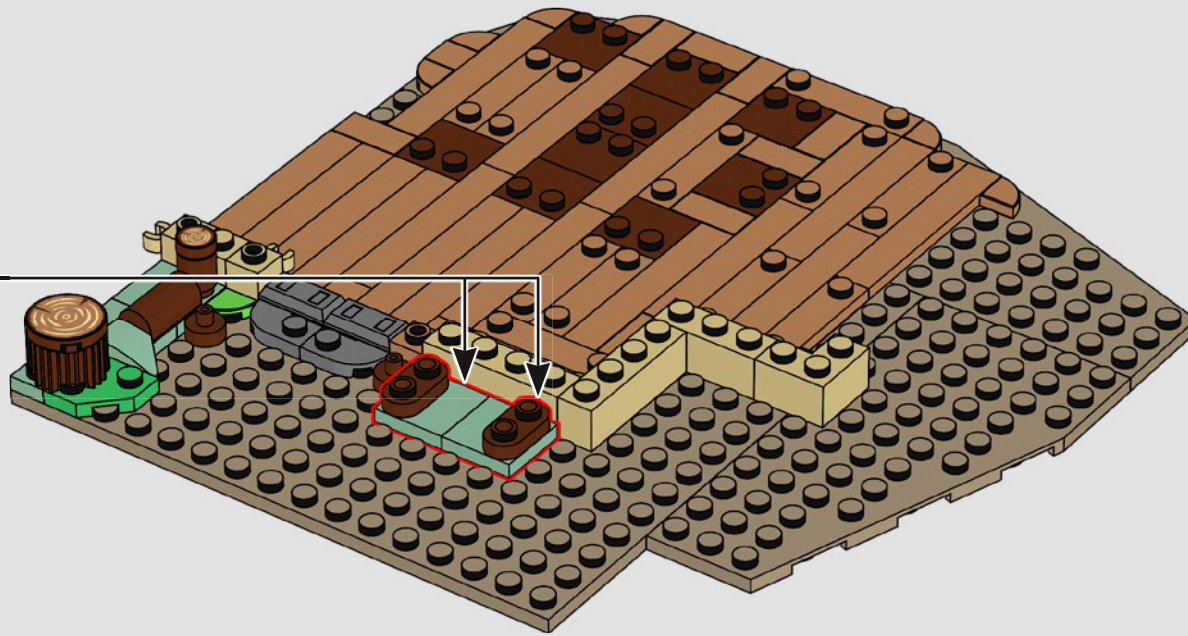
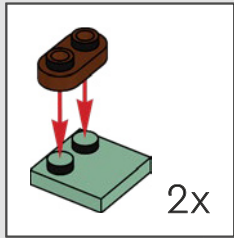

25

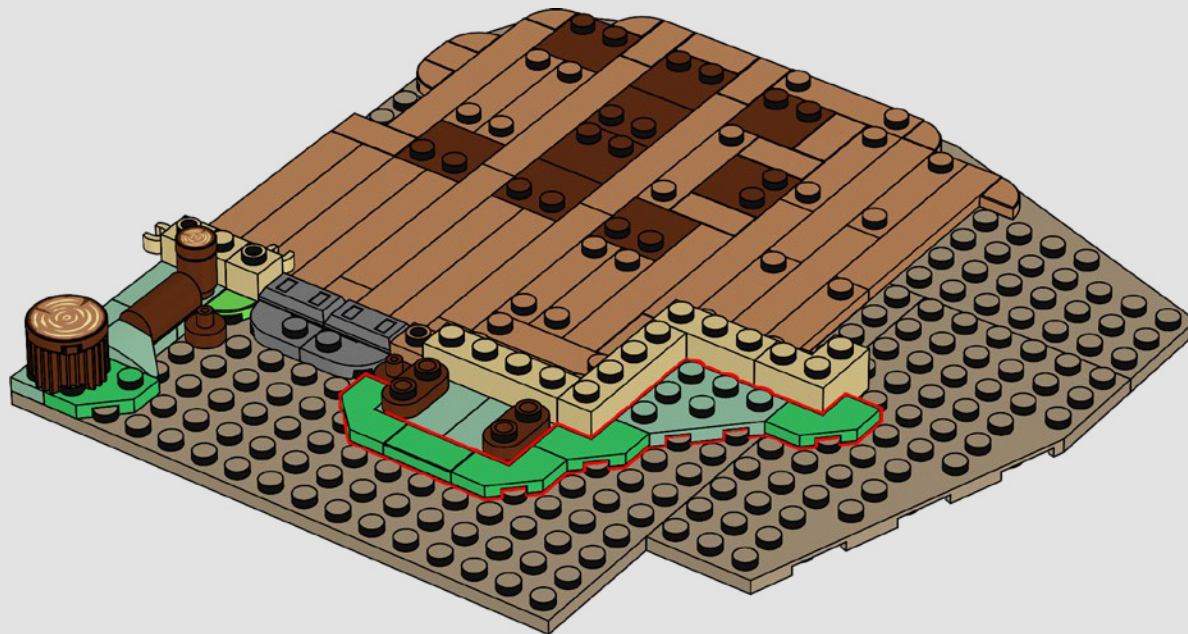

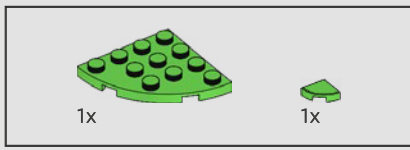

26

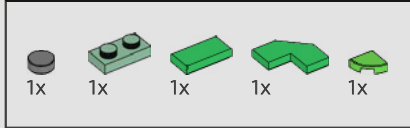
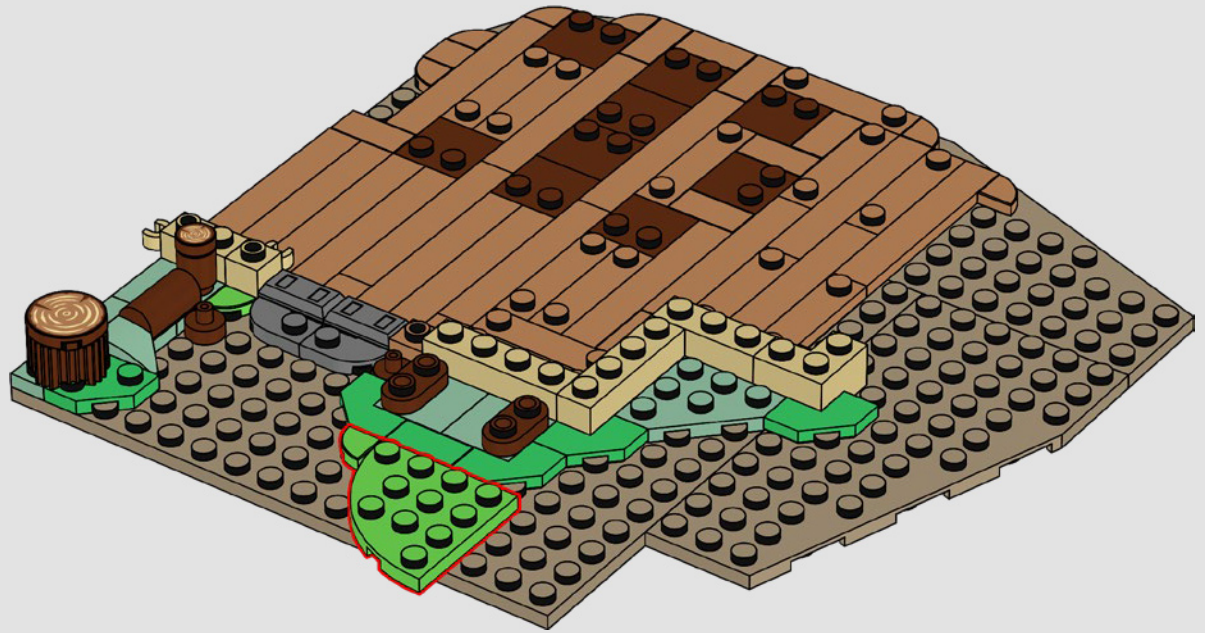

27

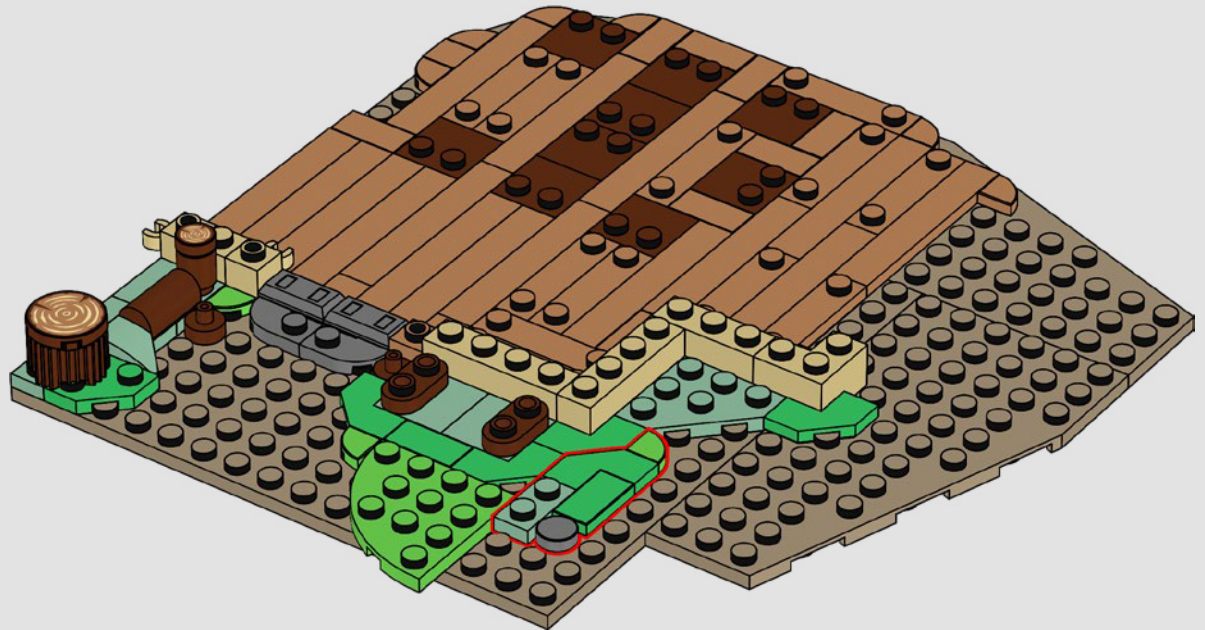

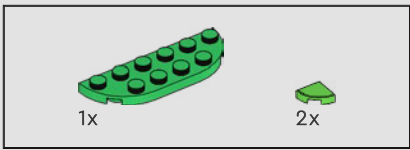

28

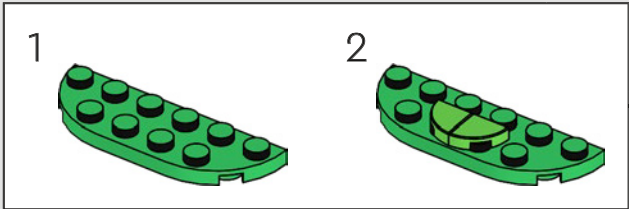
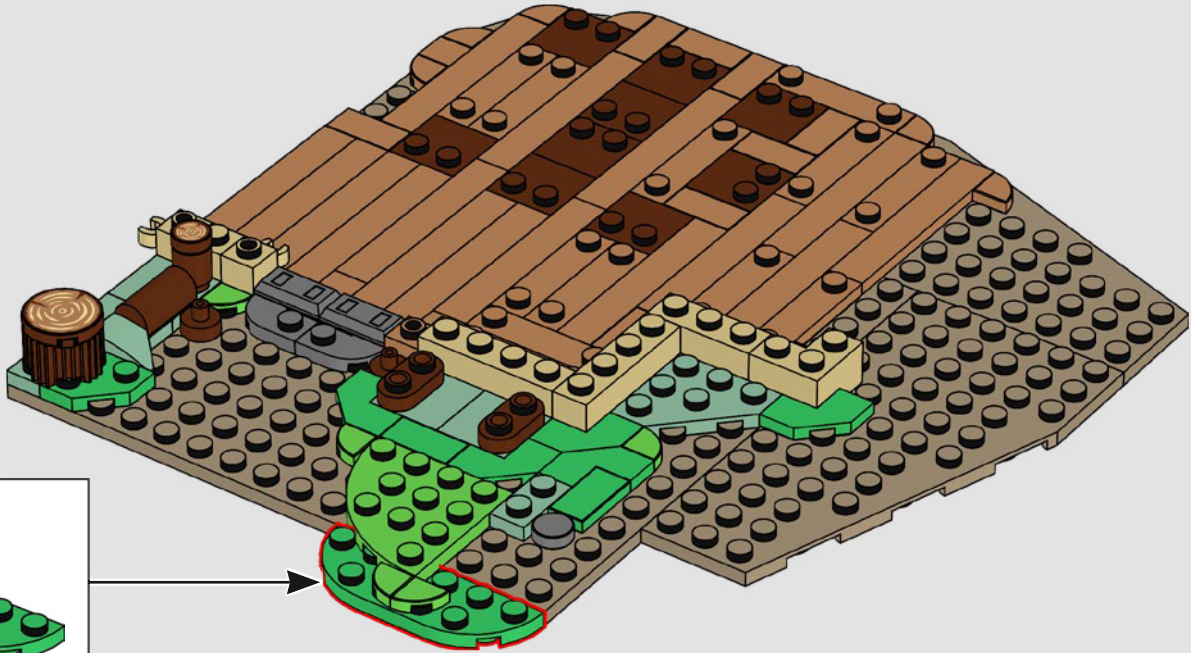

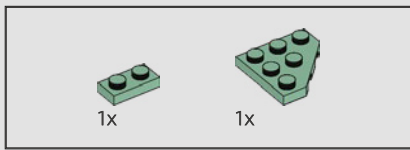

29

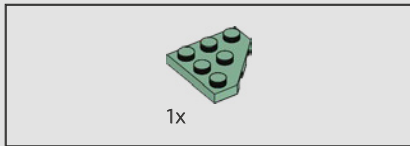
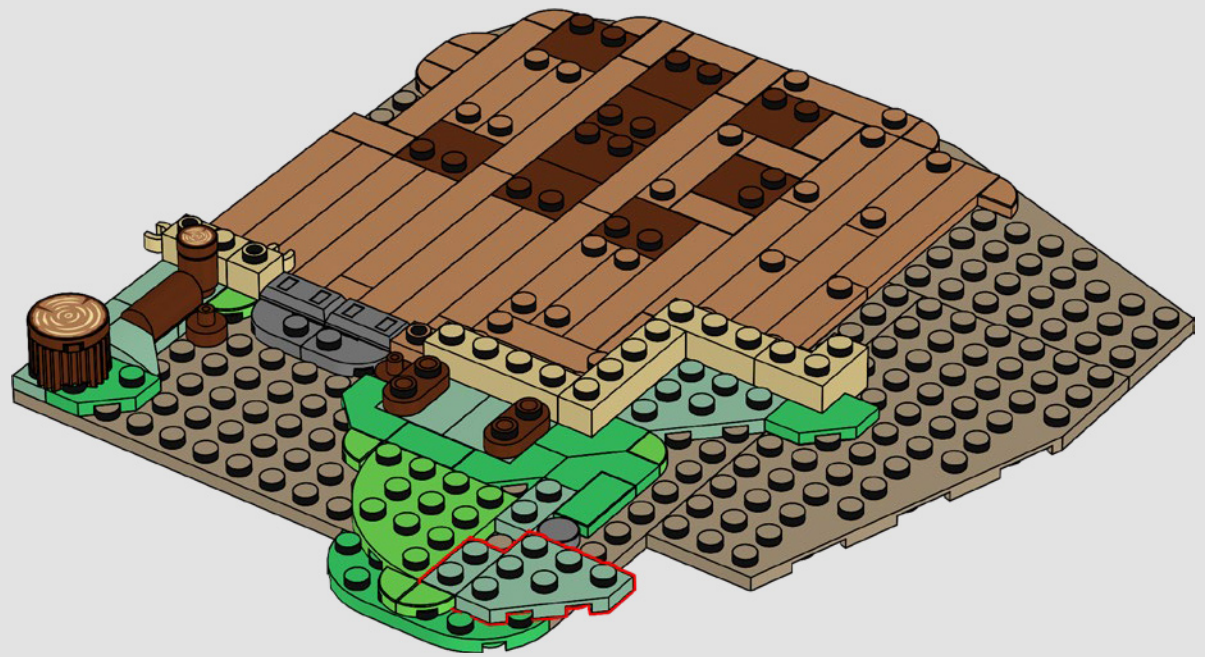

30

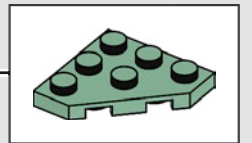
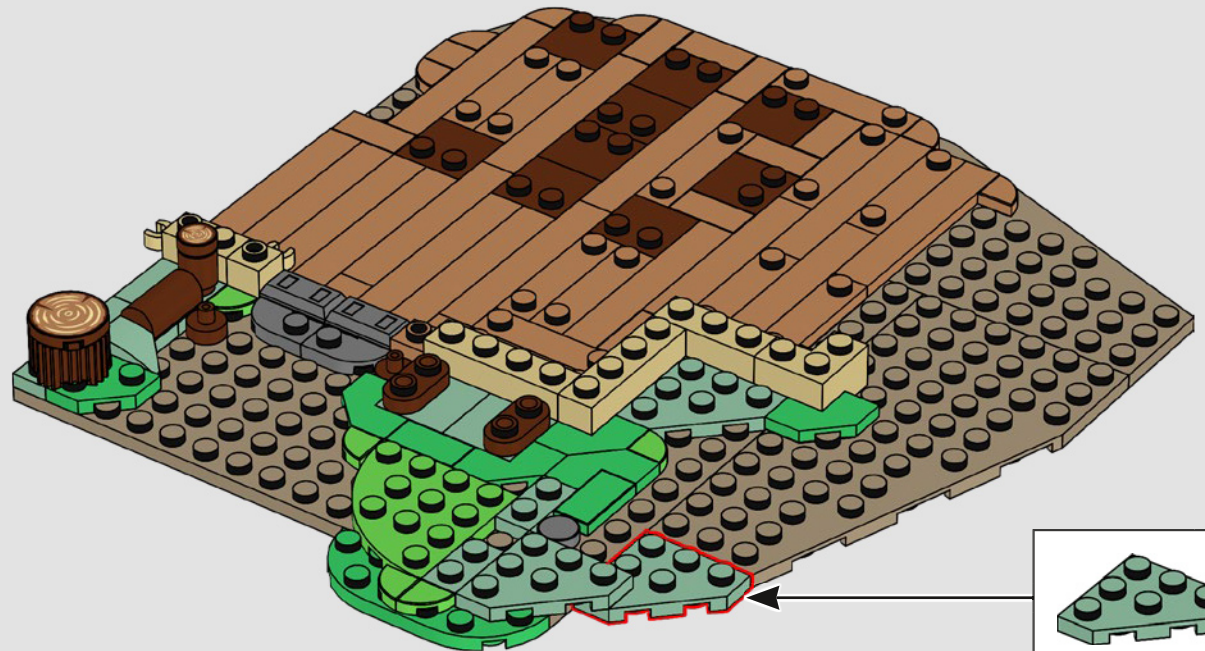

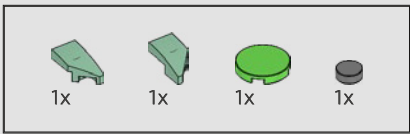

31

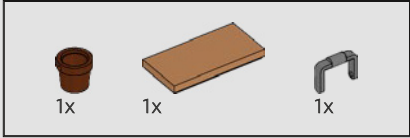
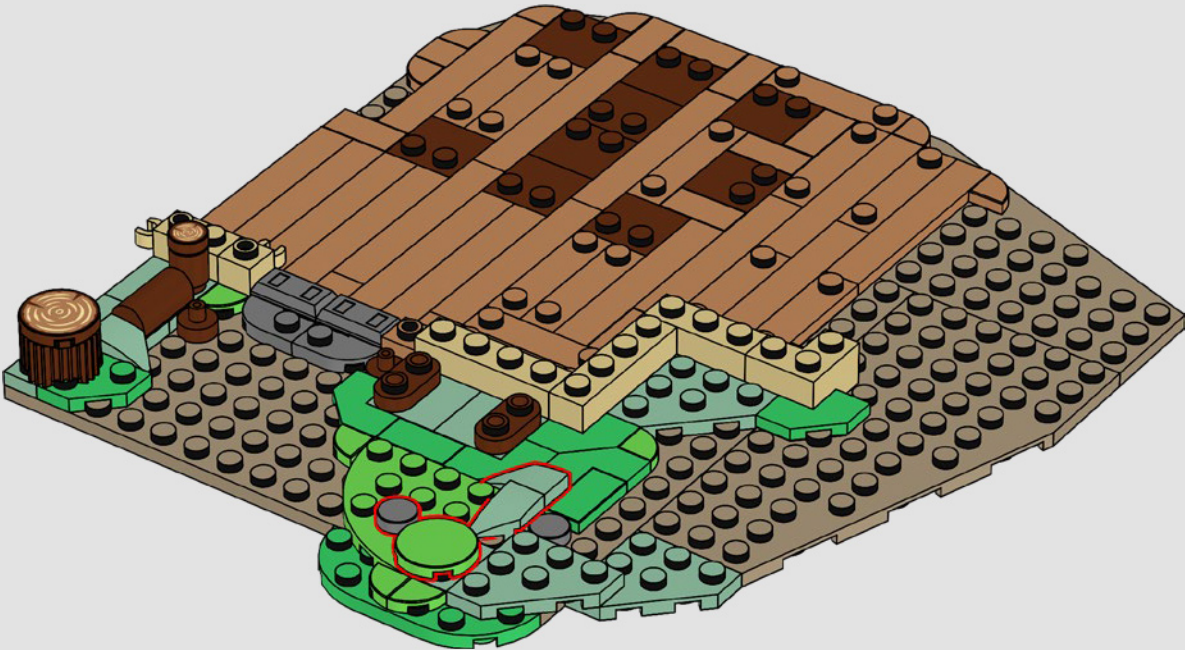

32

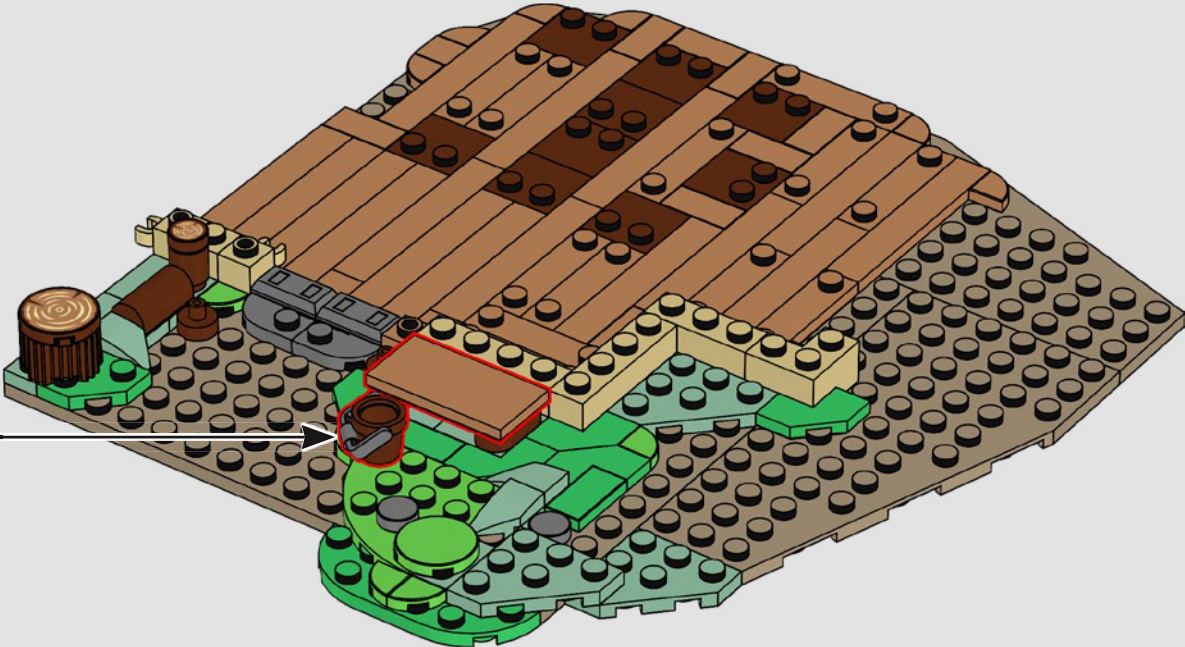
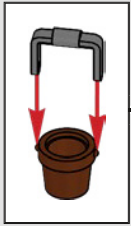

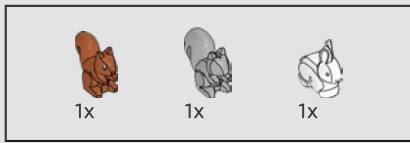

33

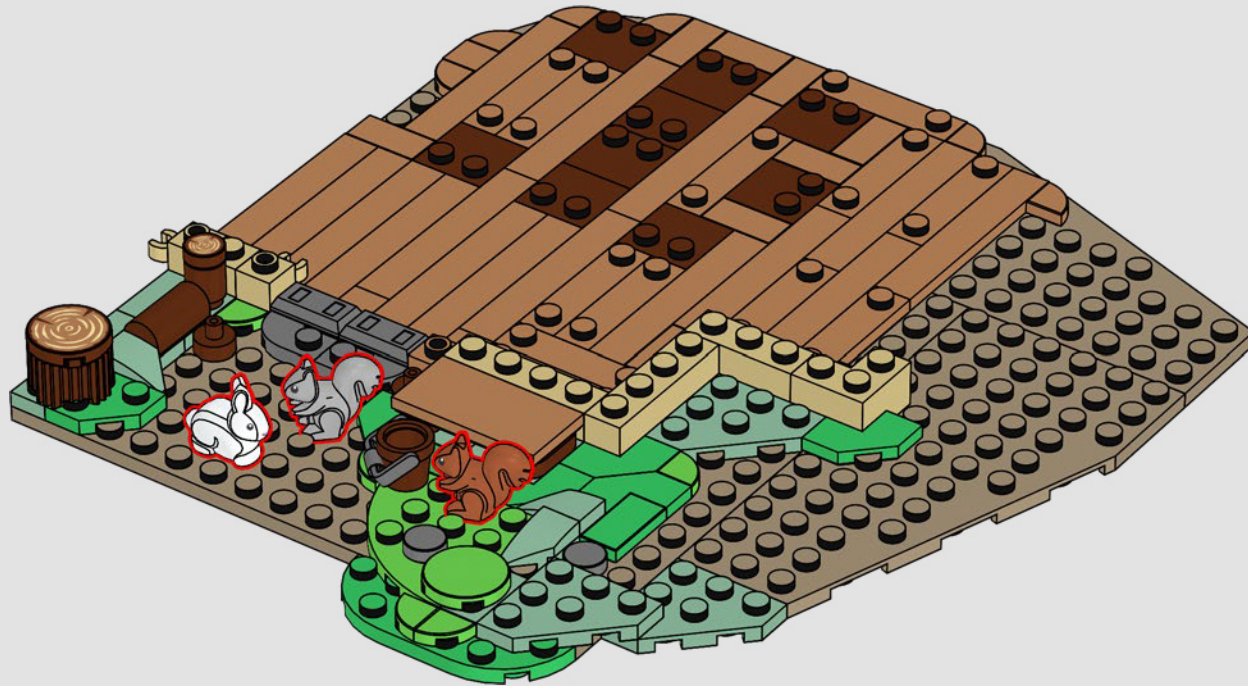

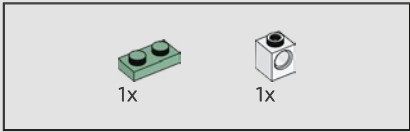
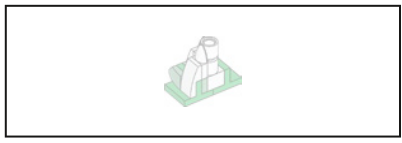

34

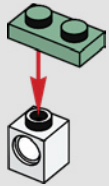

35

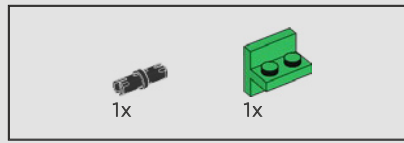
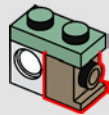

36

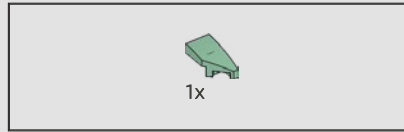
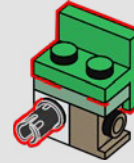

37

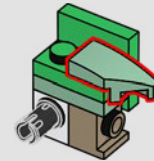



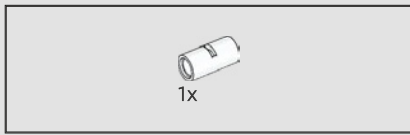

38

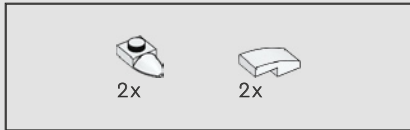
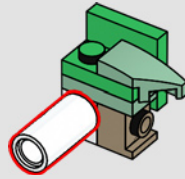

39

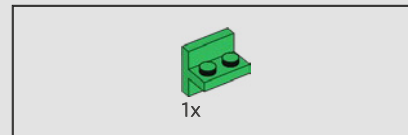
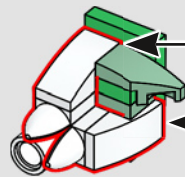
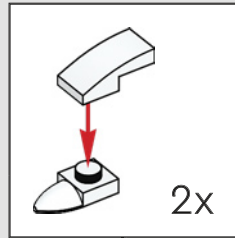

40

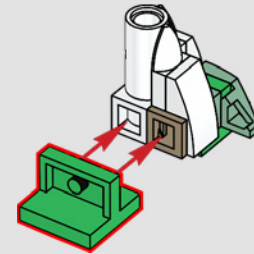
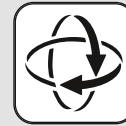

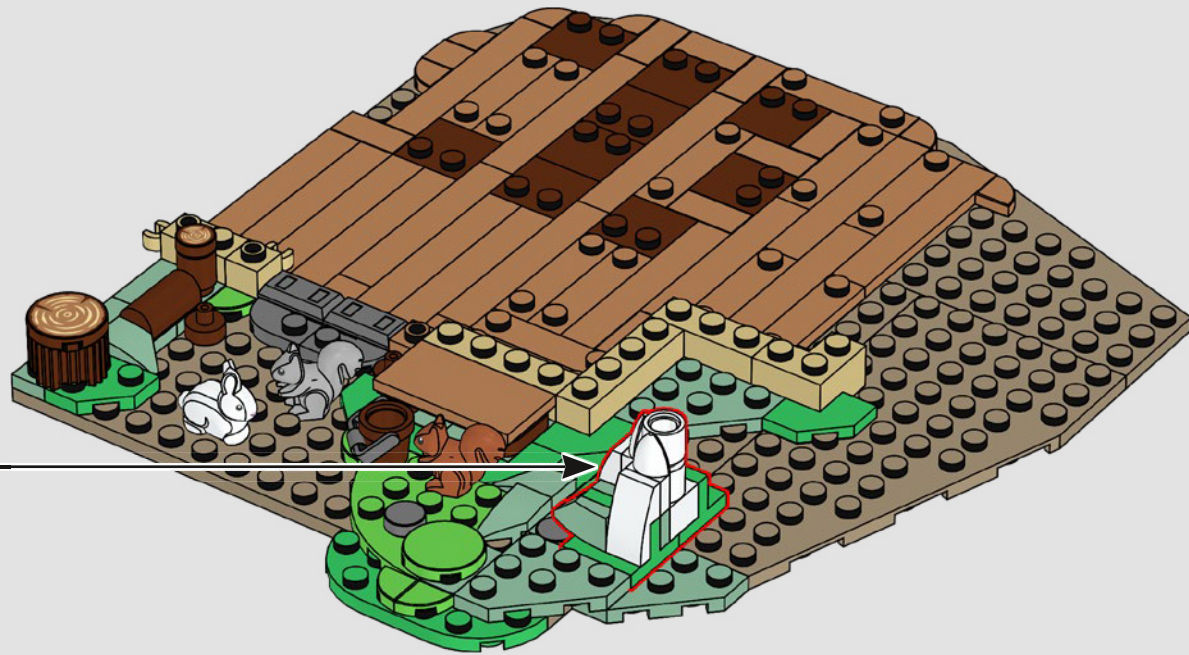

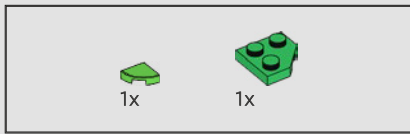

42

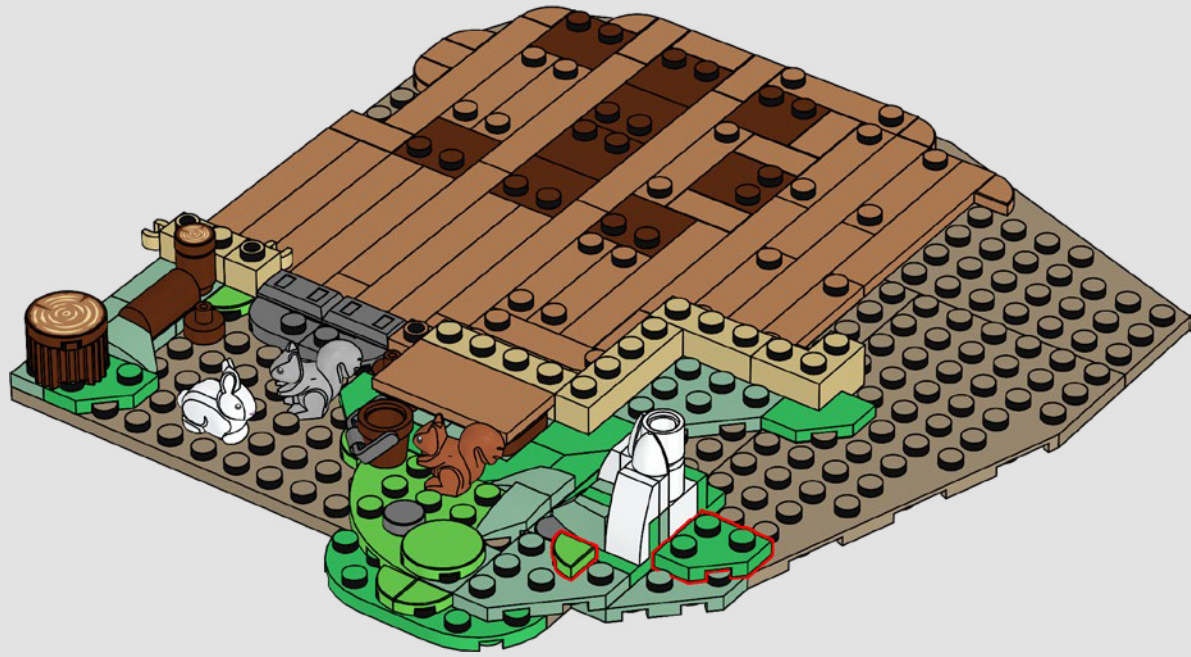

43

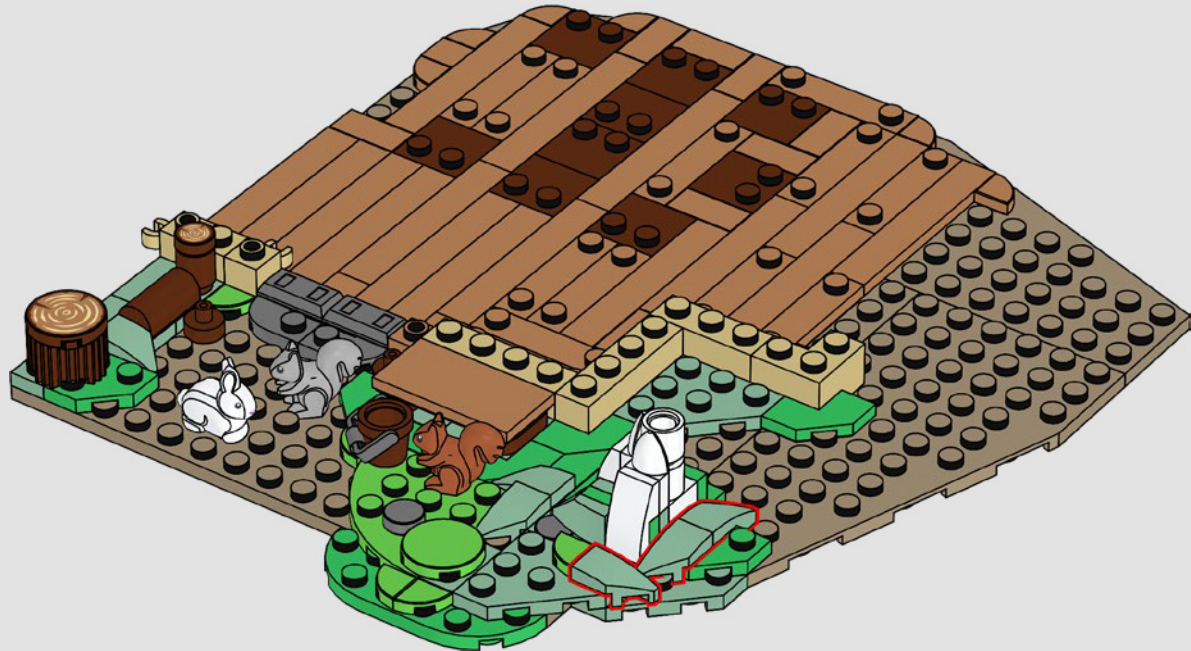

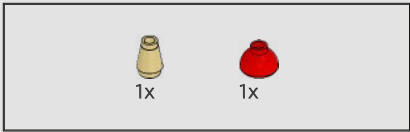

44

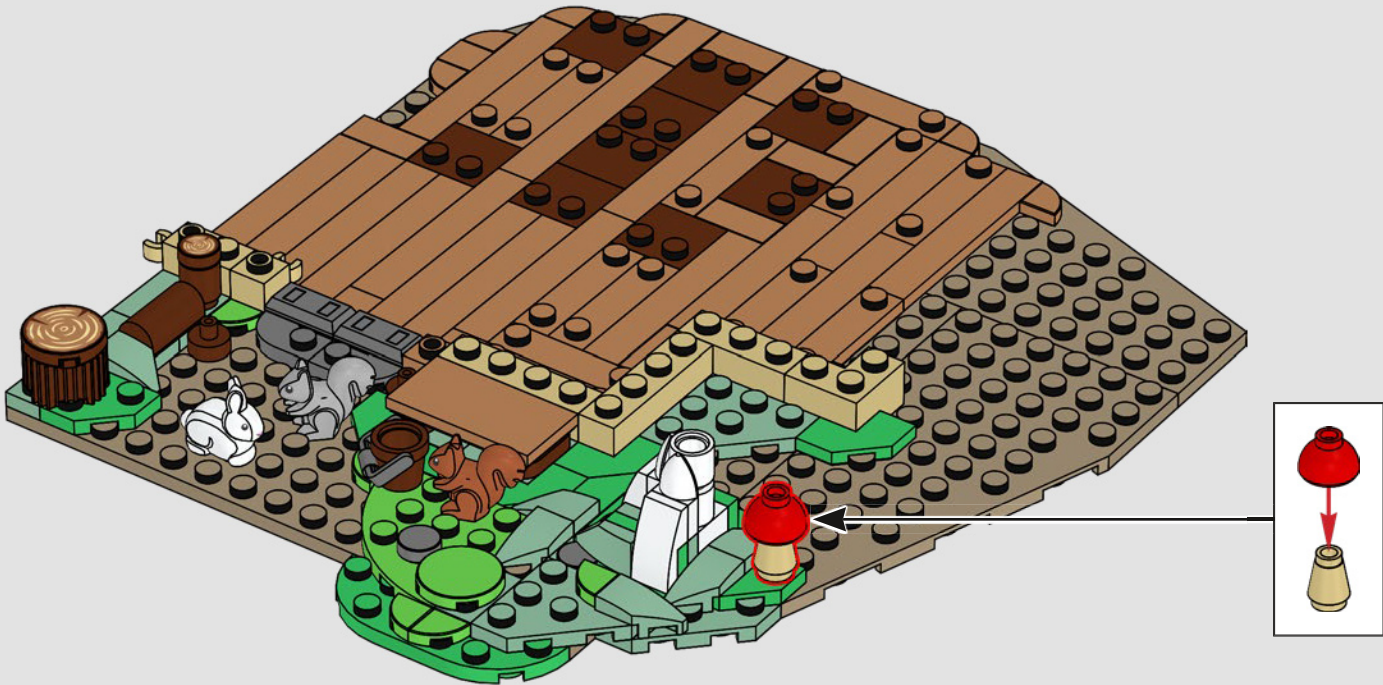

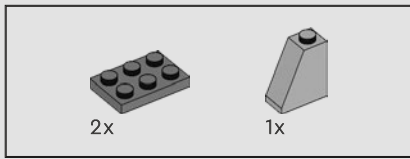

45

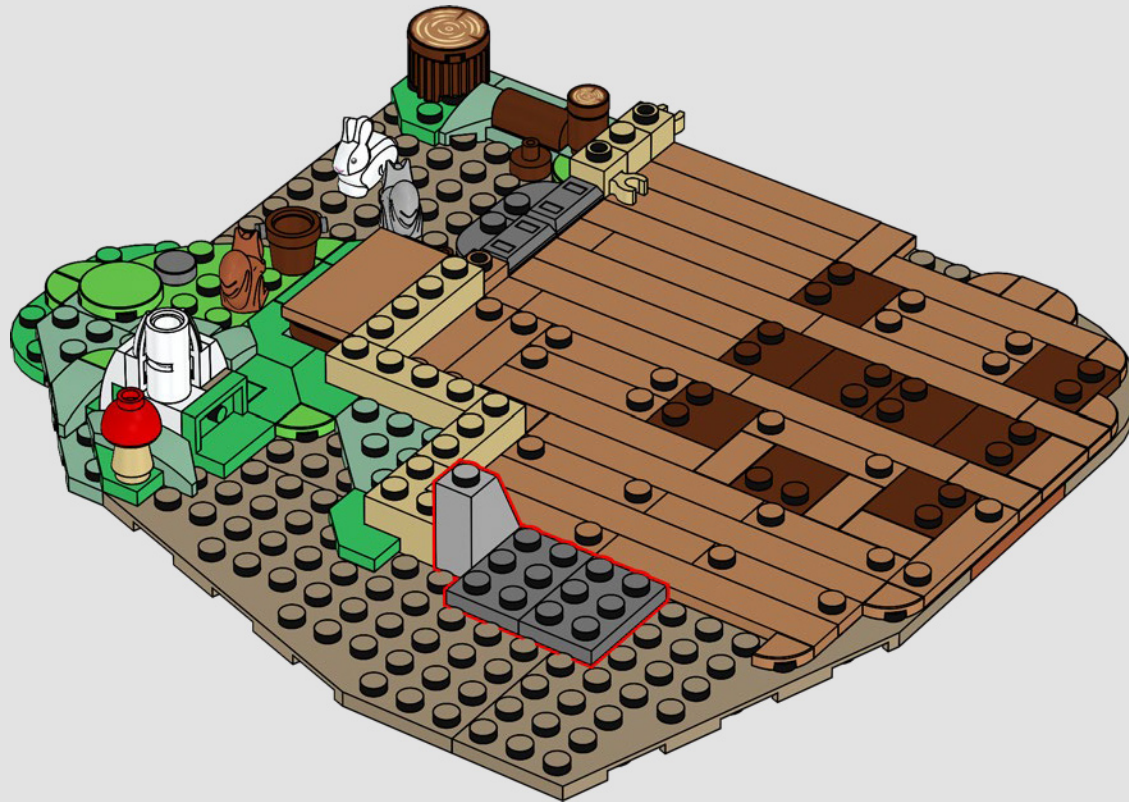

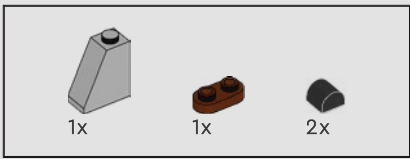

46

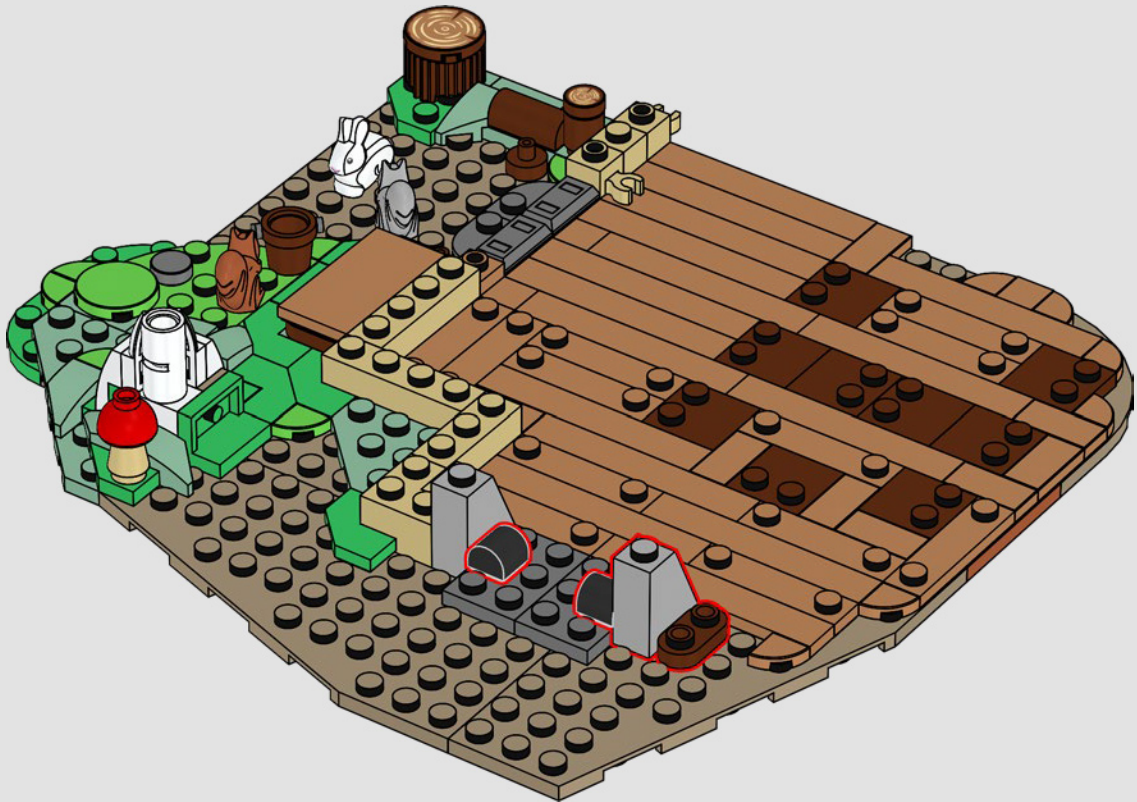

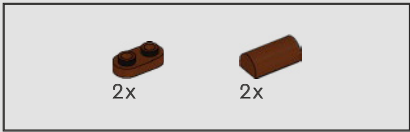

47

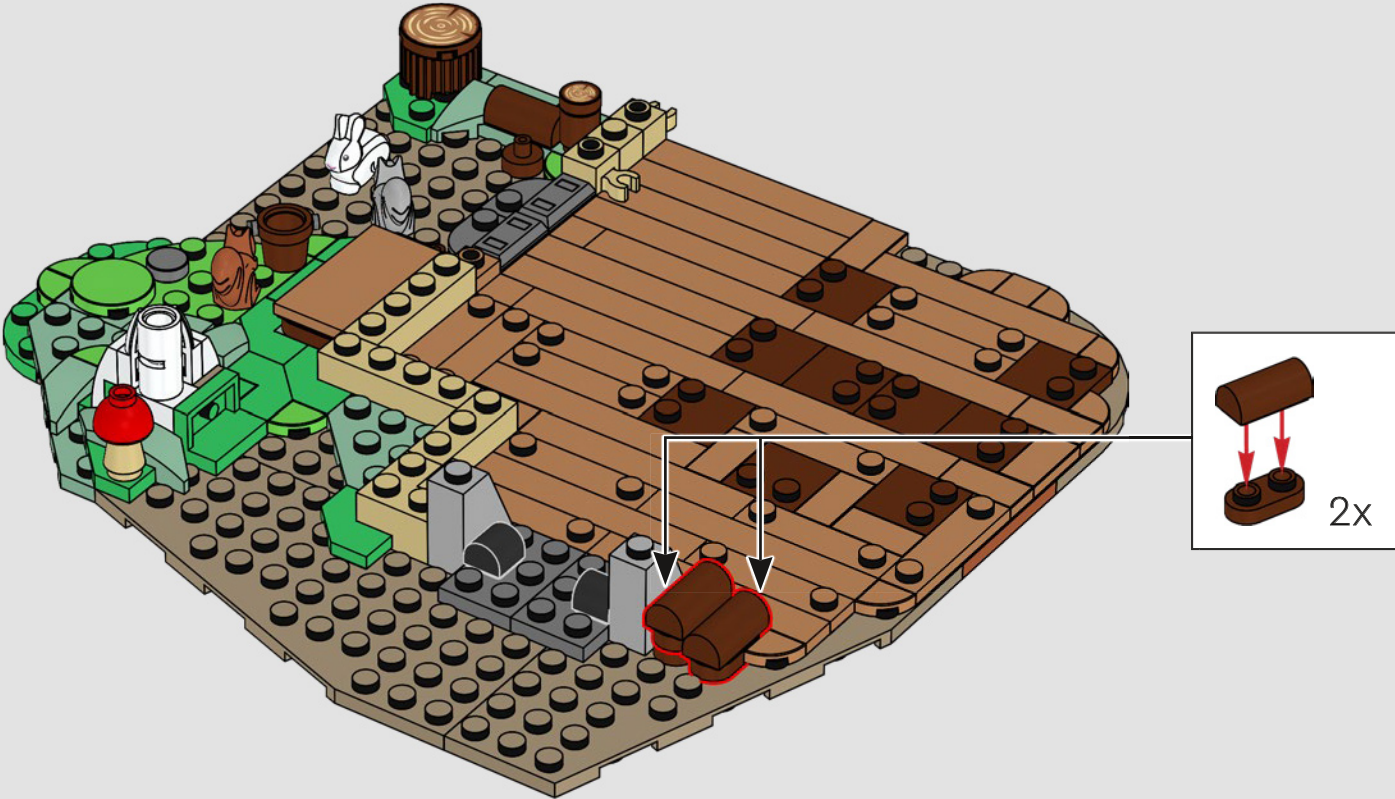



48







49



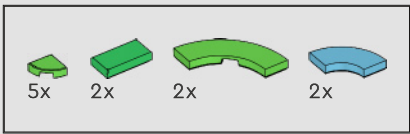

50



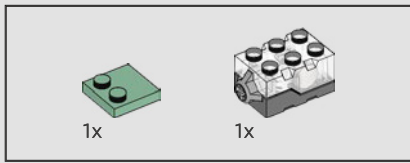

51

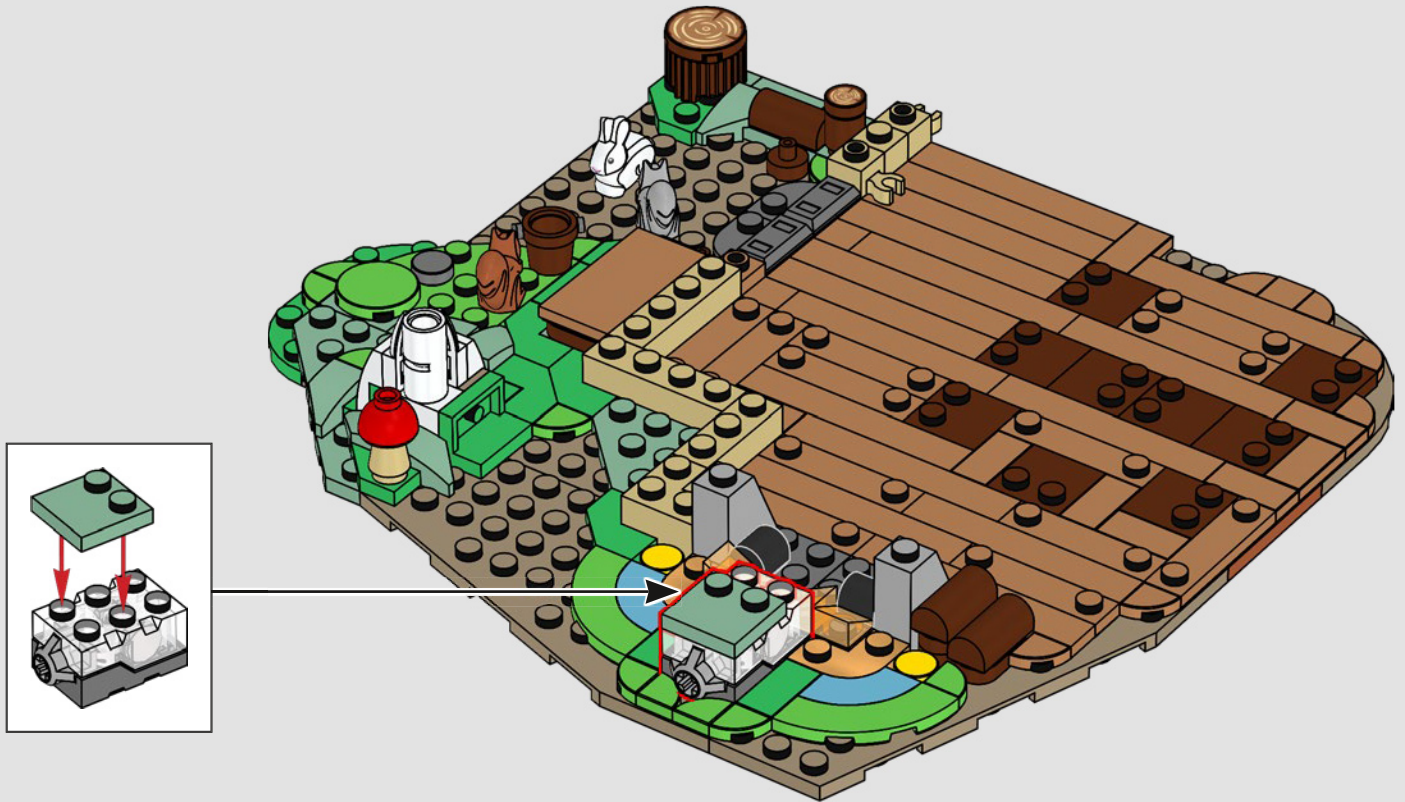
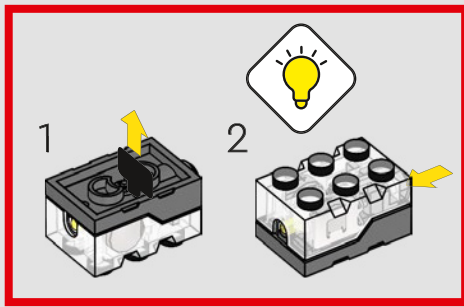

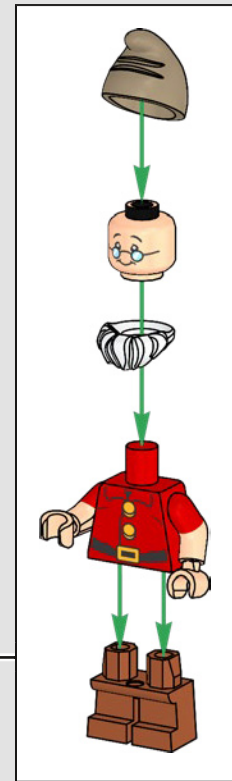

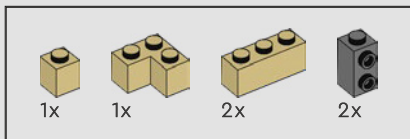

52

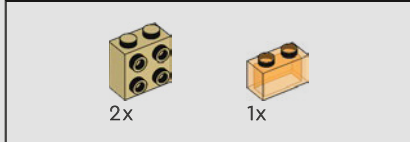
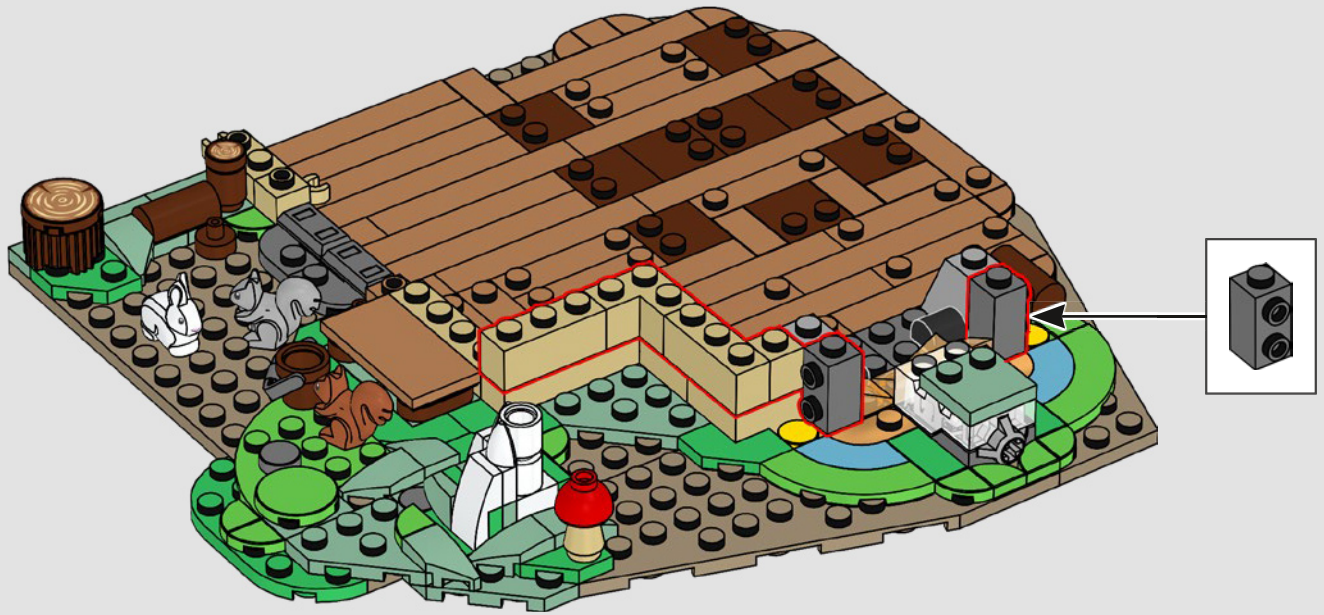

53

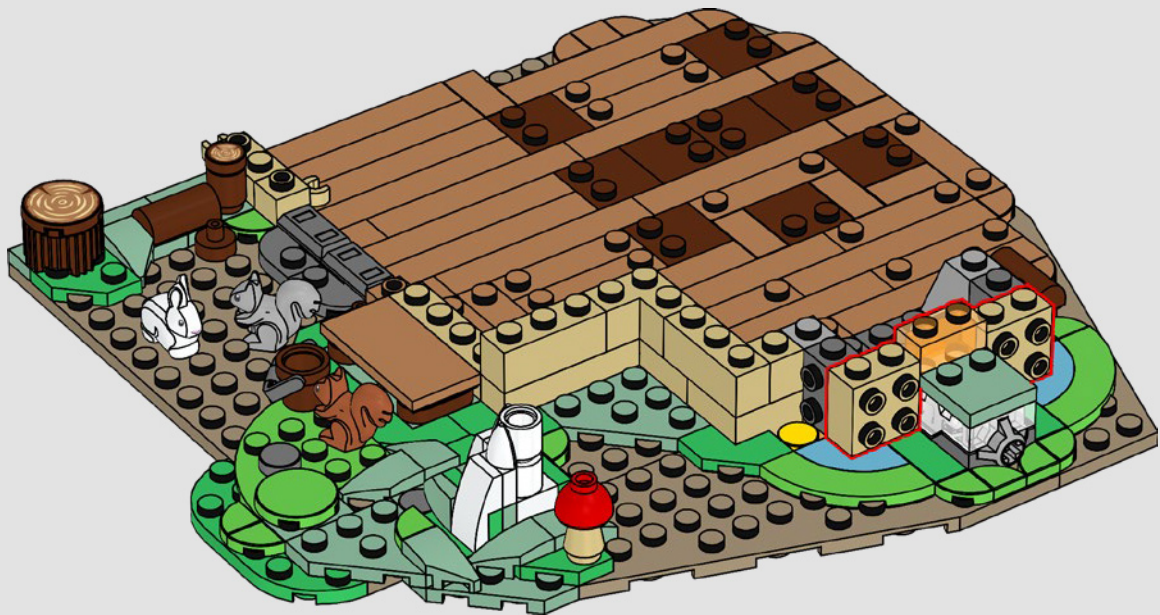

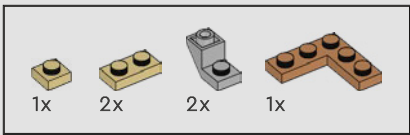

54

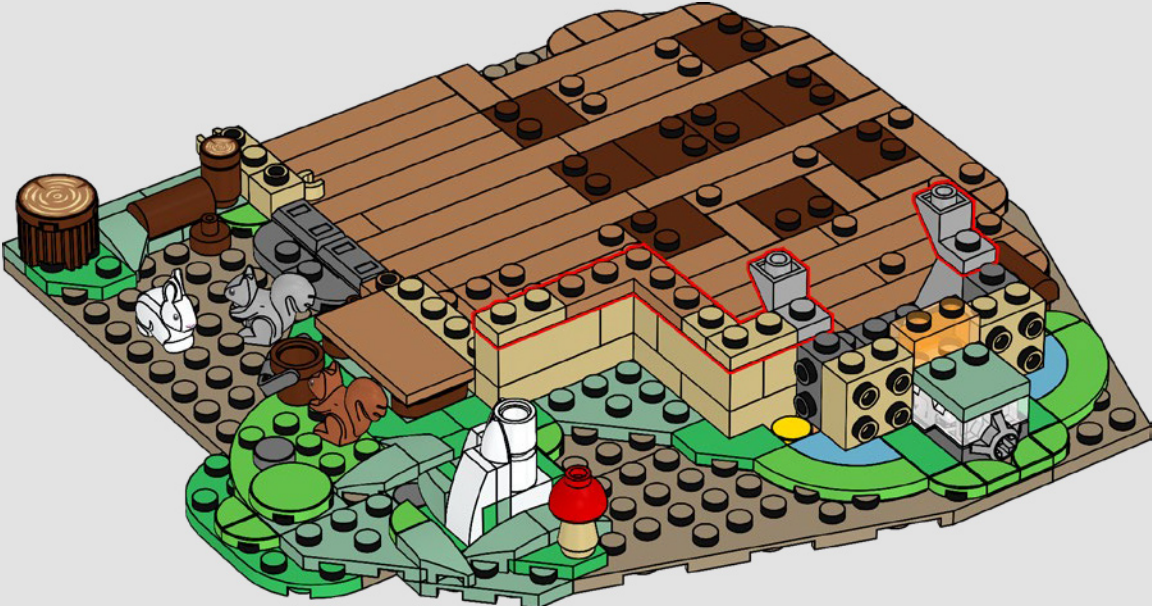

55

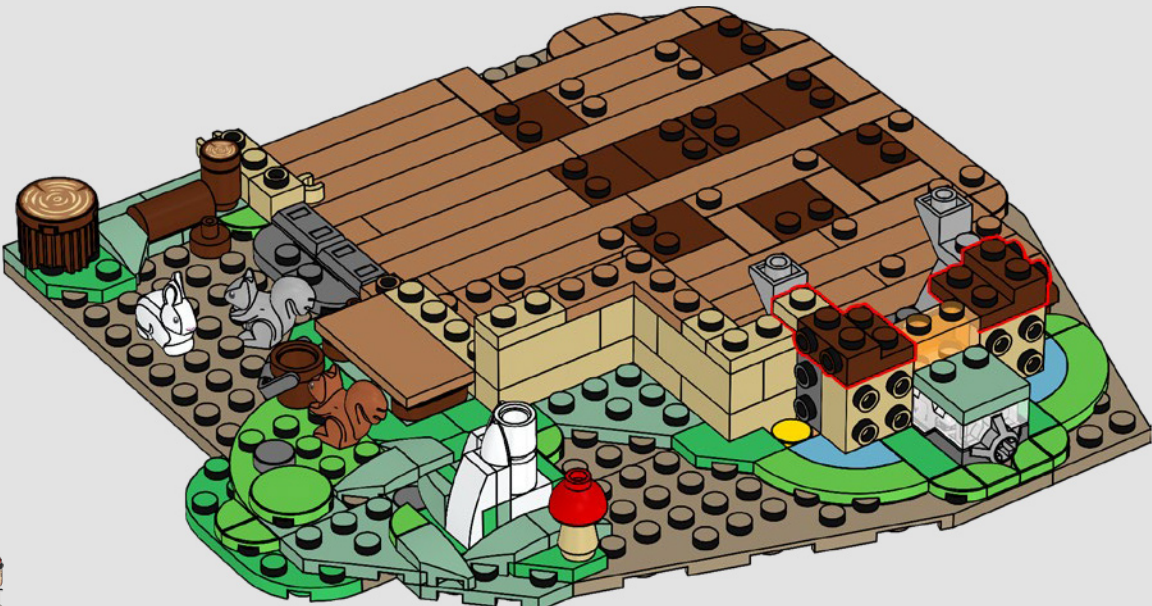



56

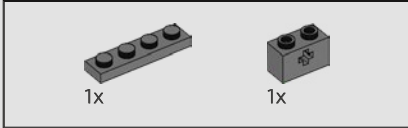
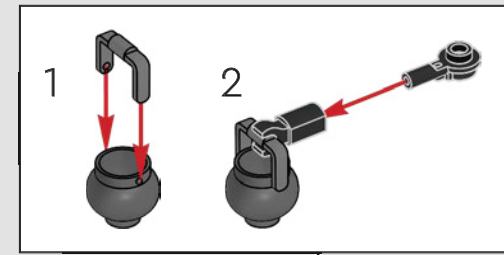
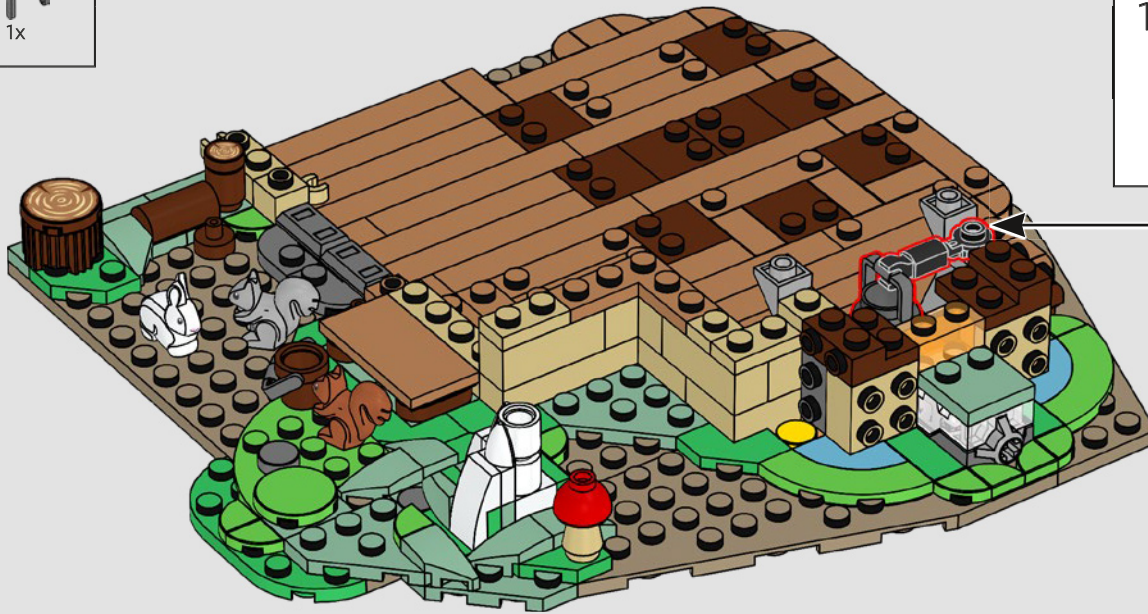

57





58

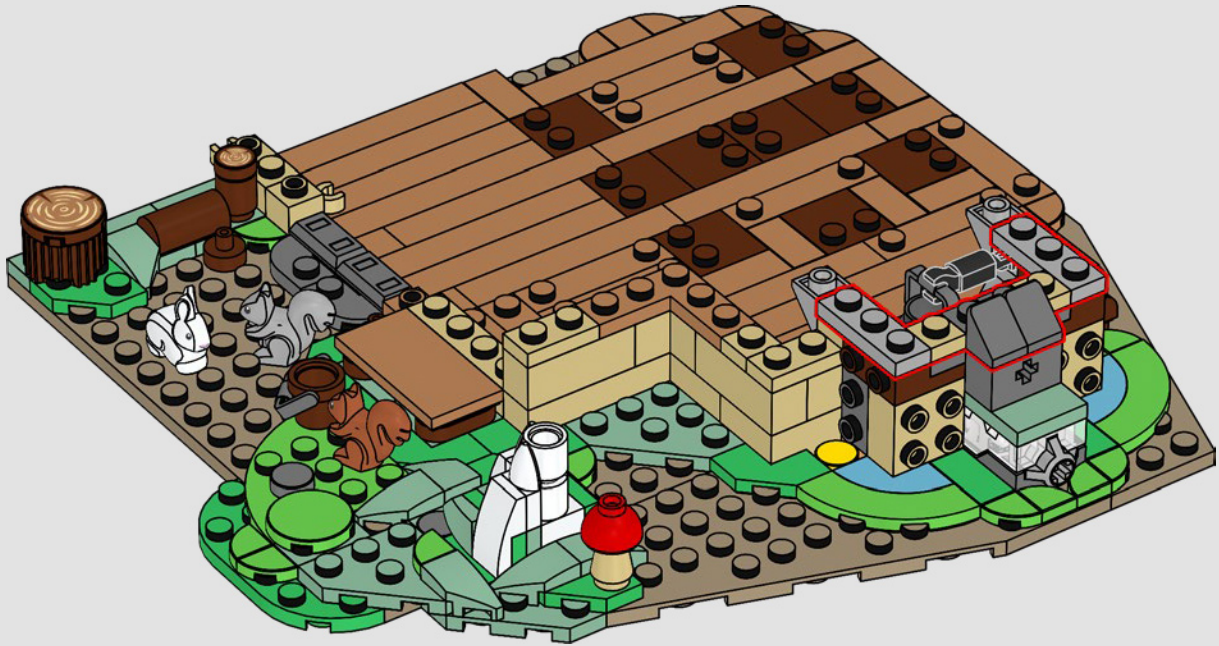



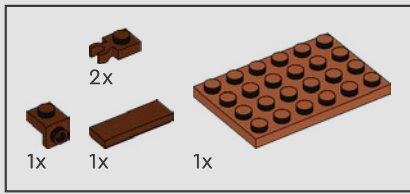

59

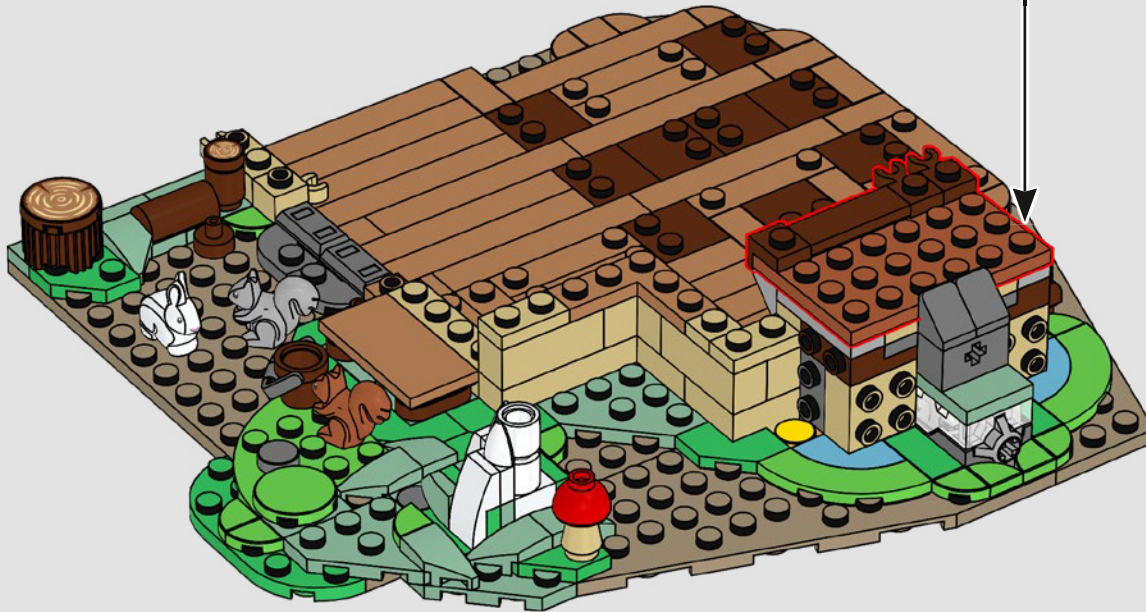
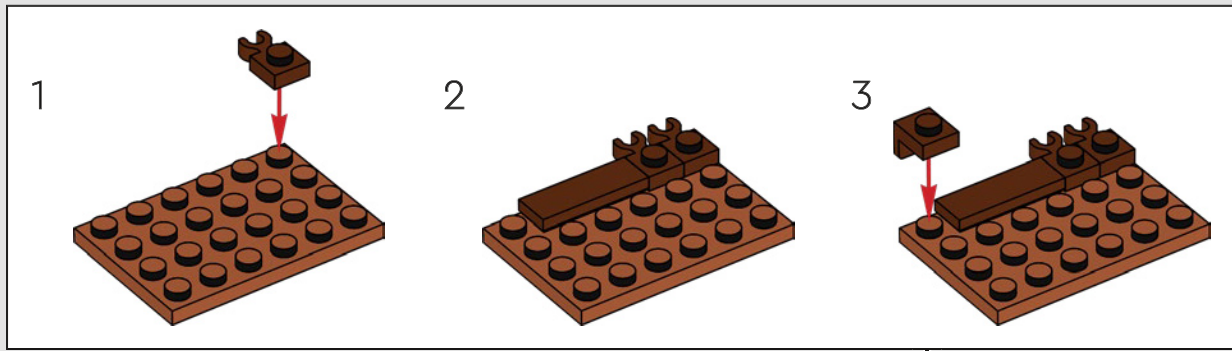

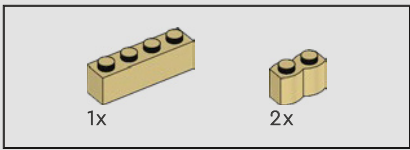

60

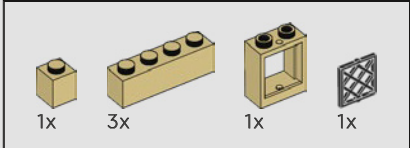
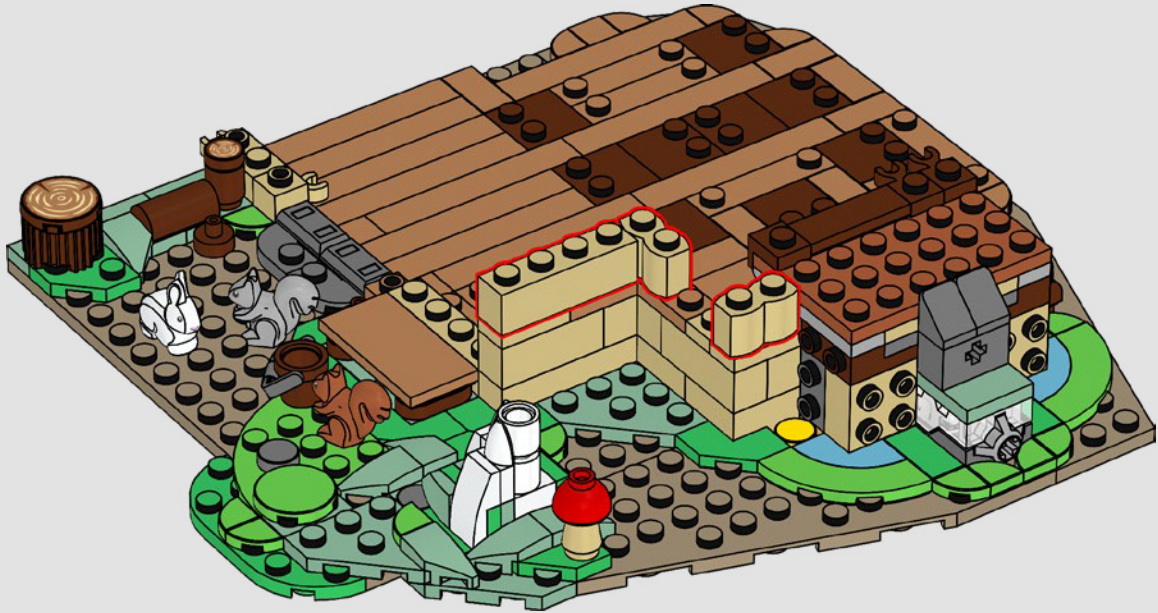

61

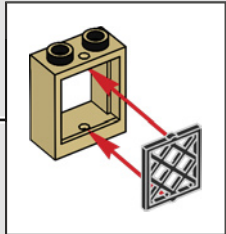
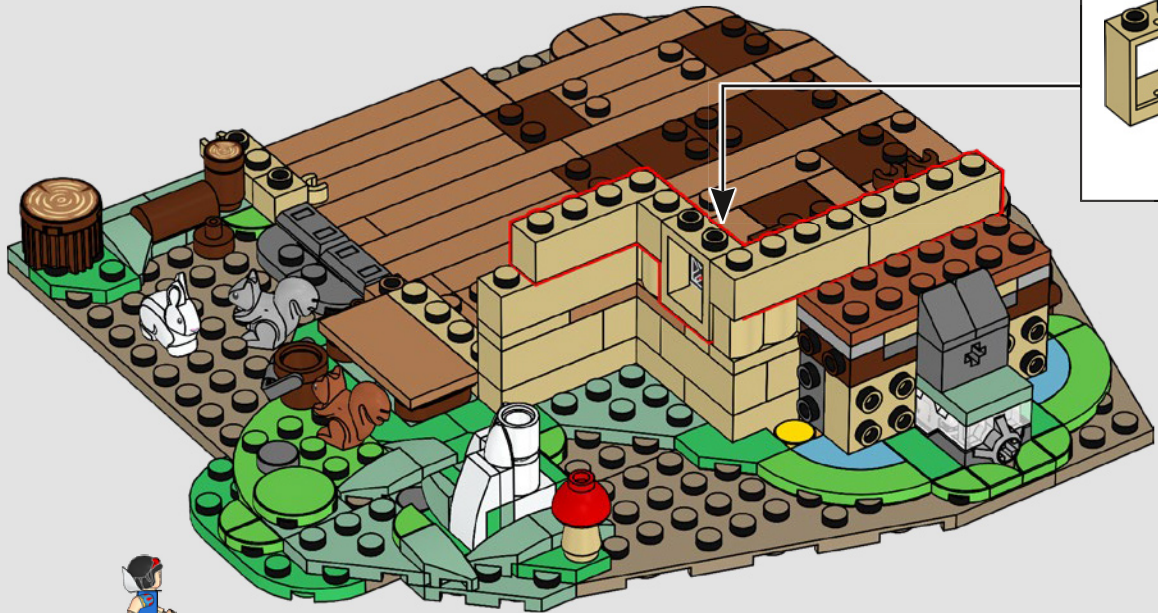

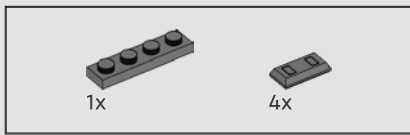

62

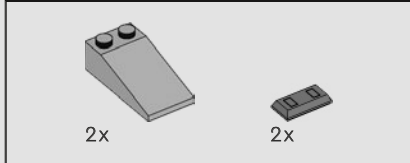

63

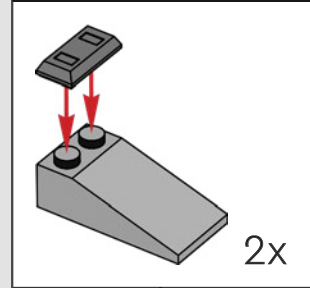
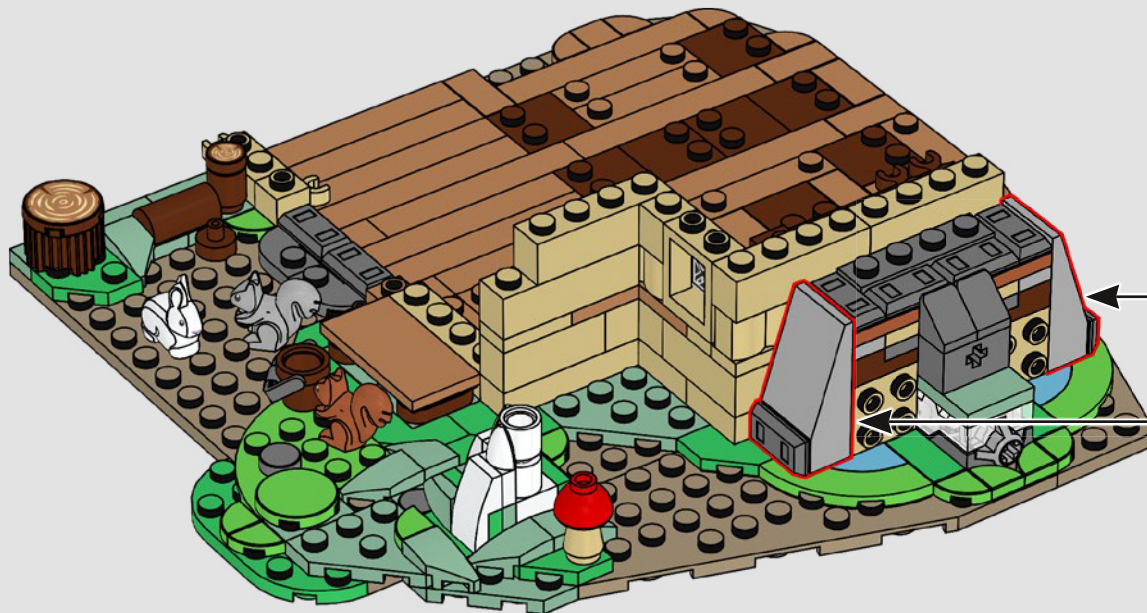

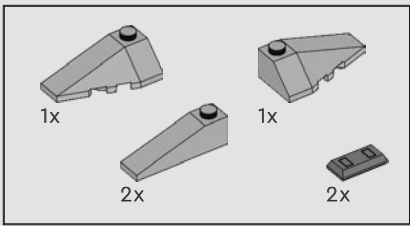

64

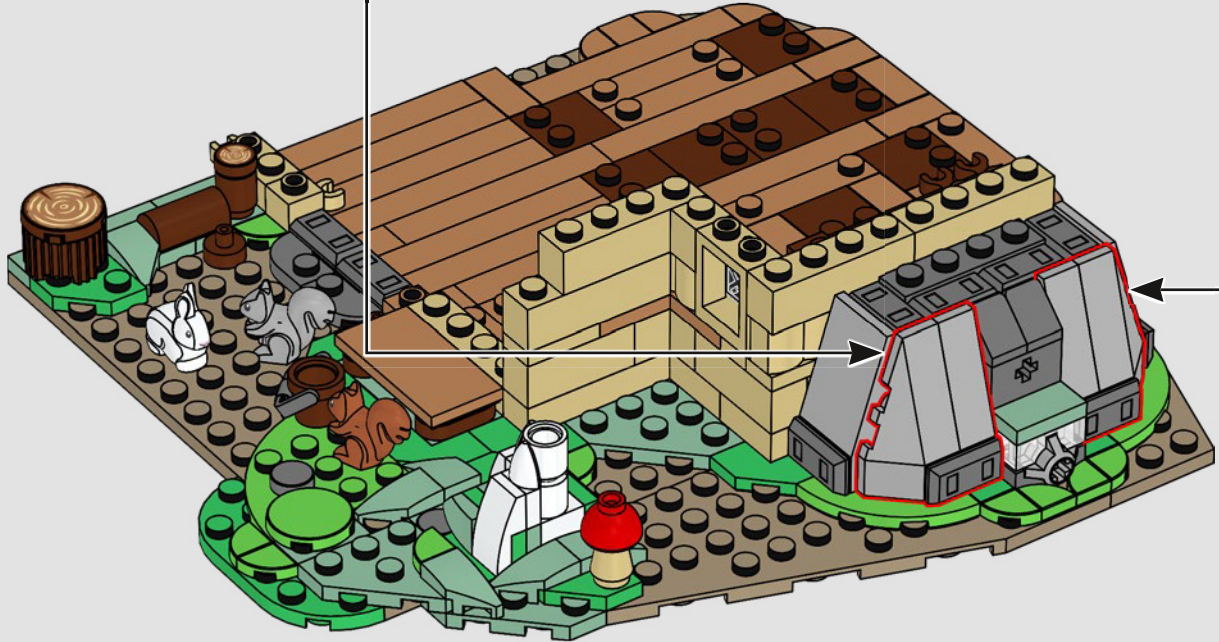
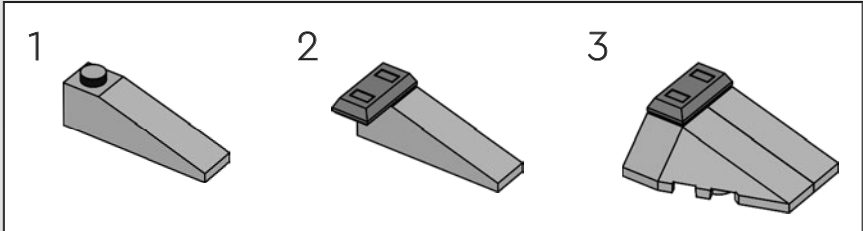
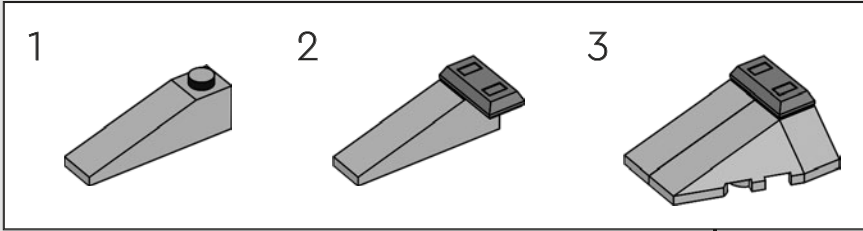

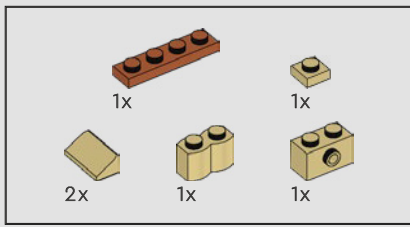

65

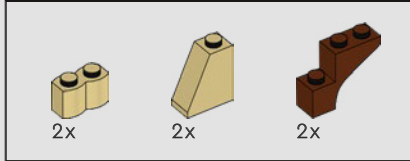
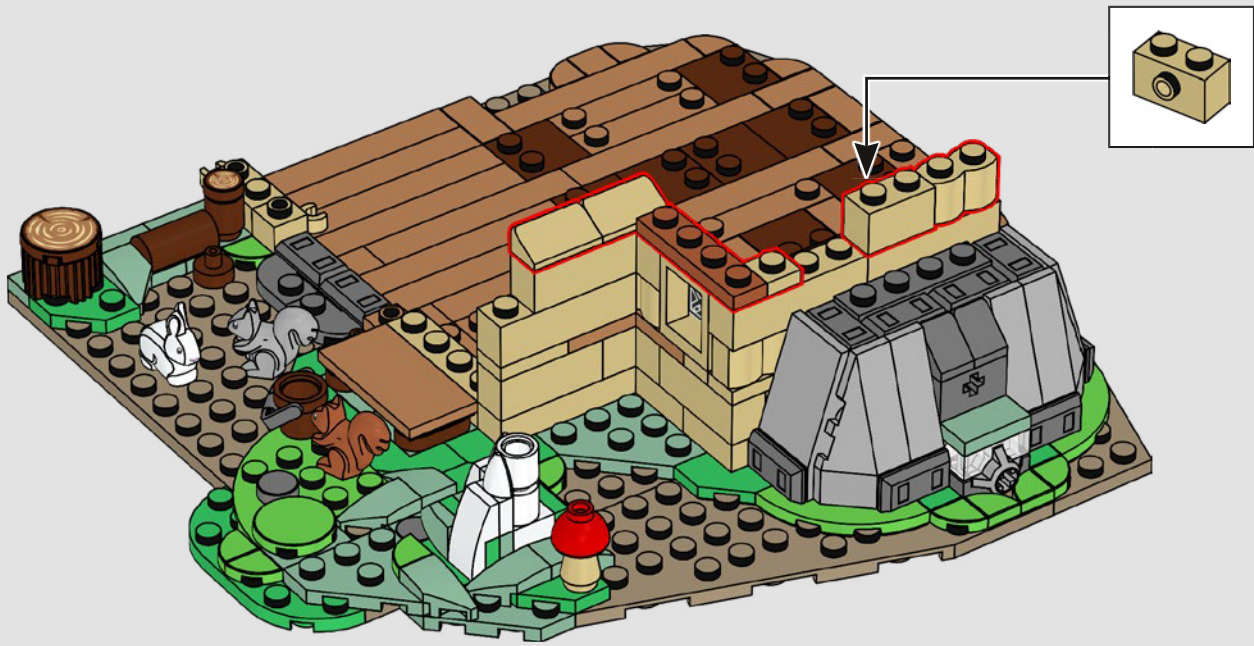

66

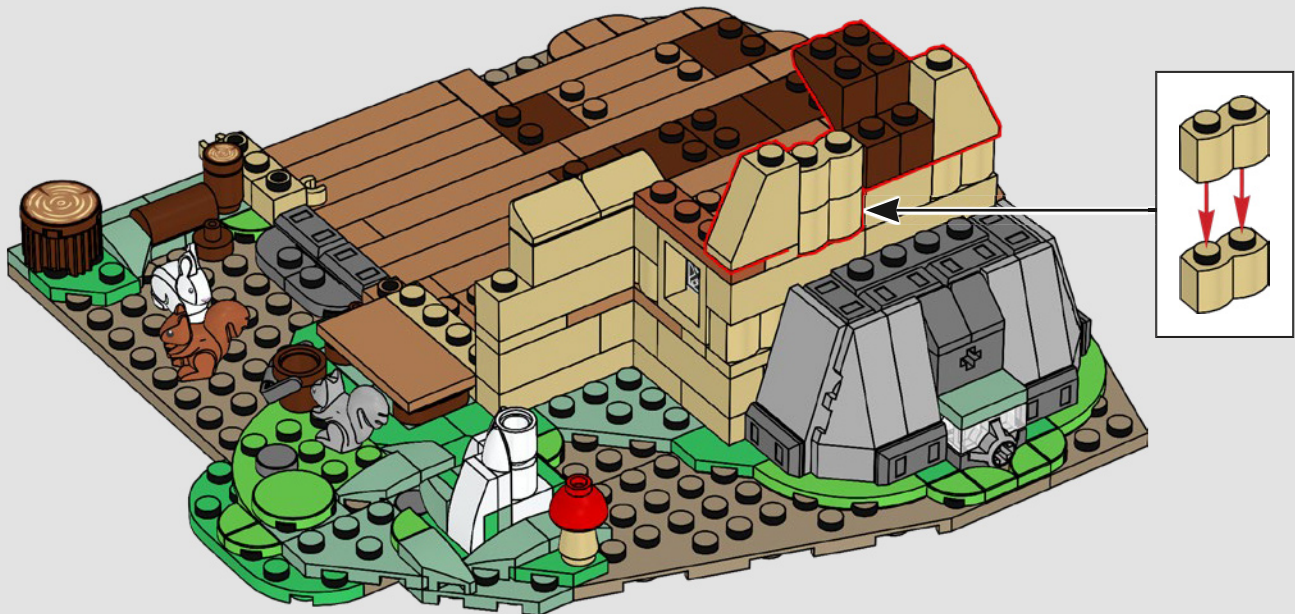



67

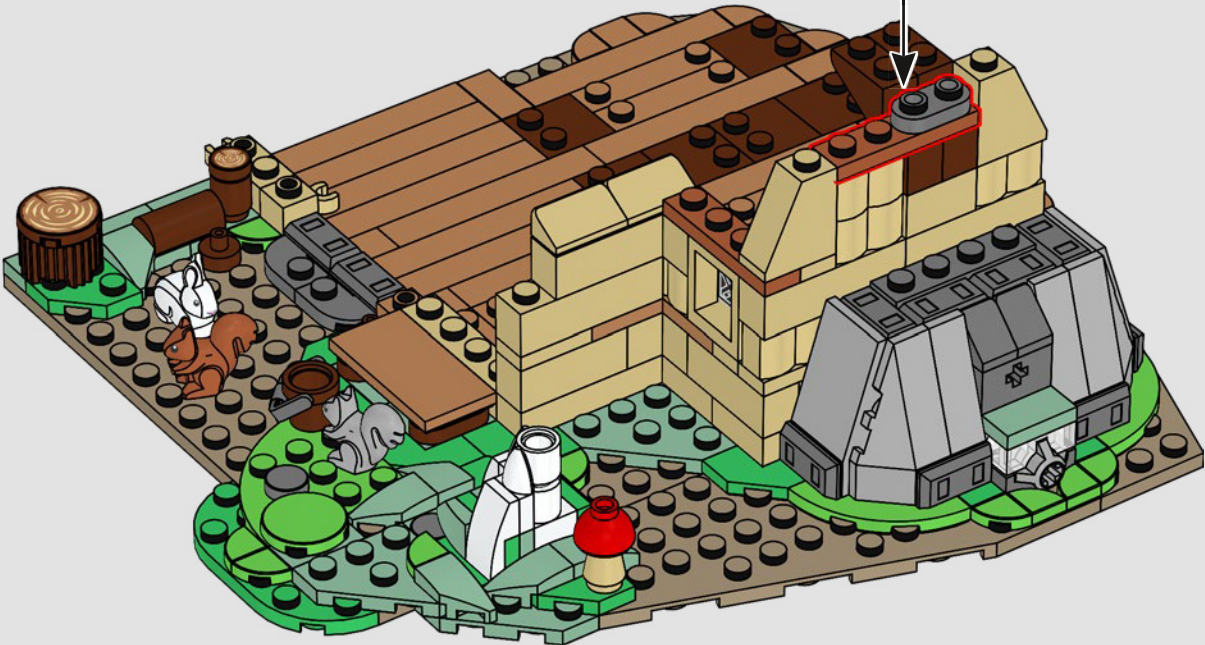
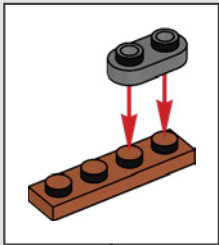

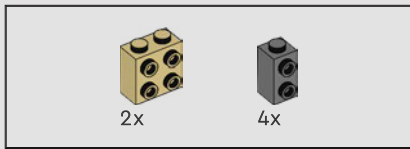

68

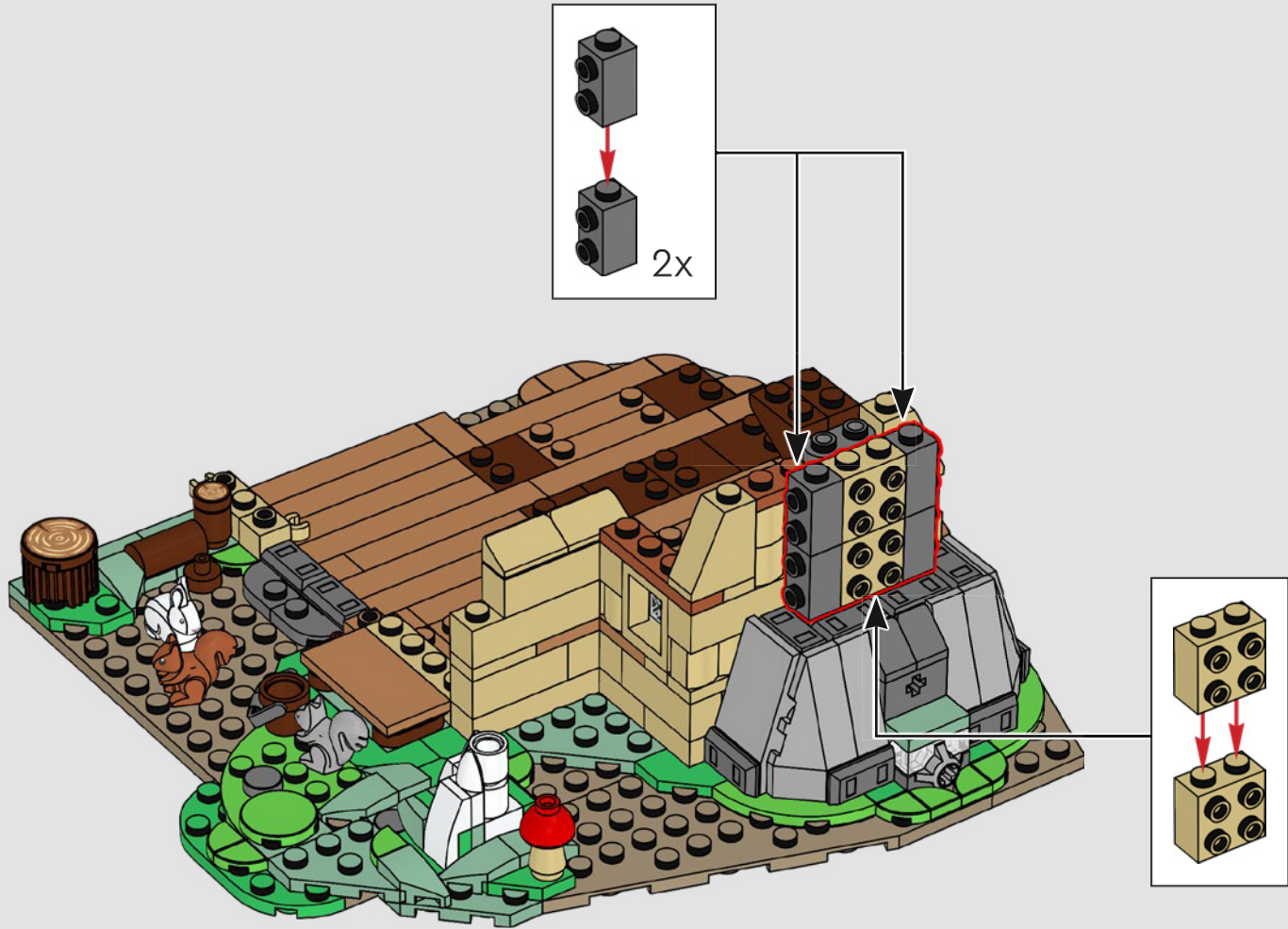

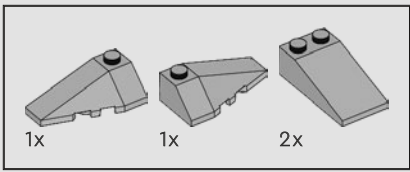

69

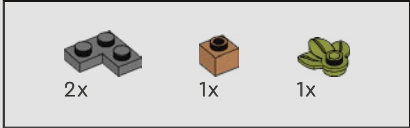
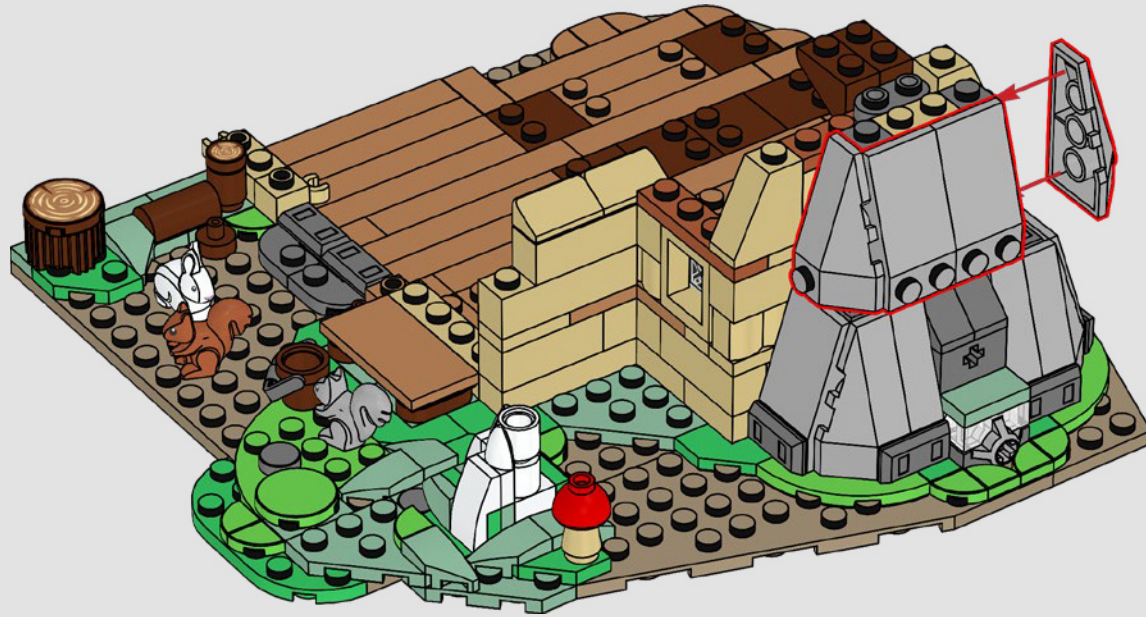

70

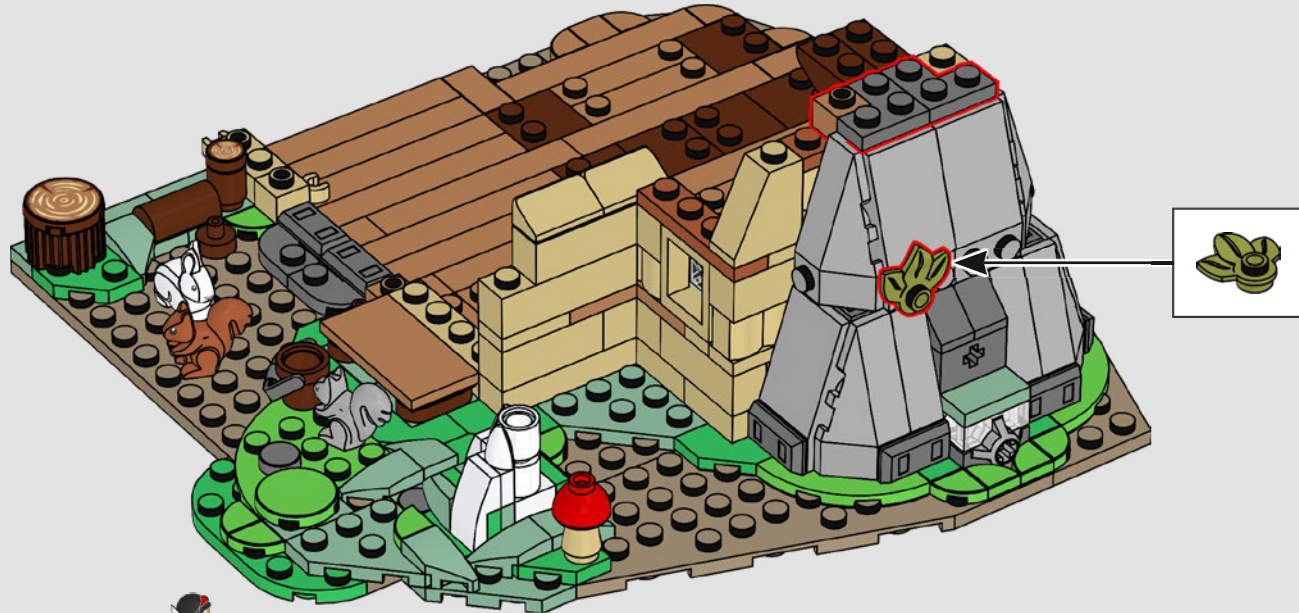



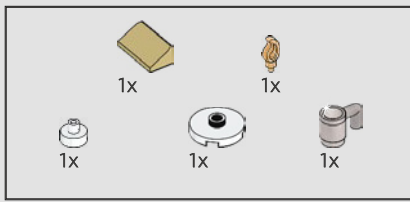

71

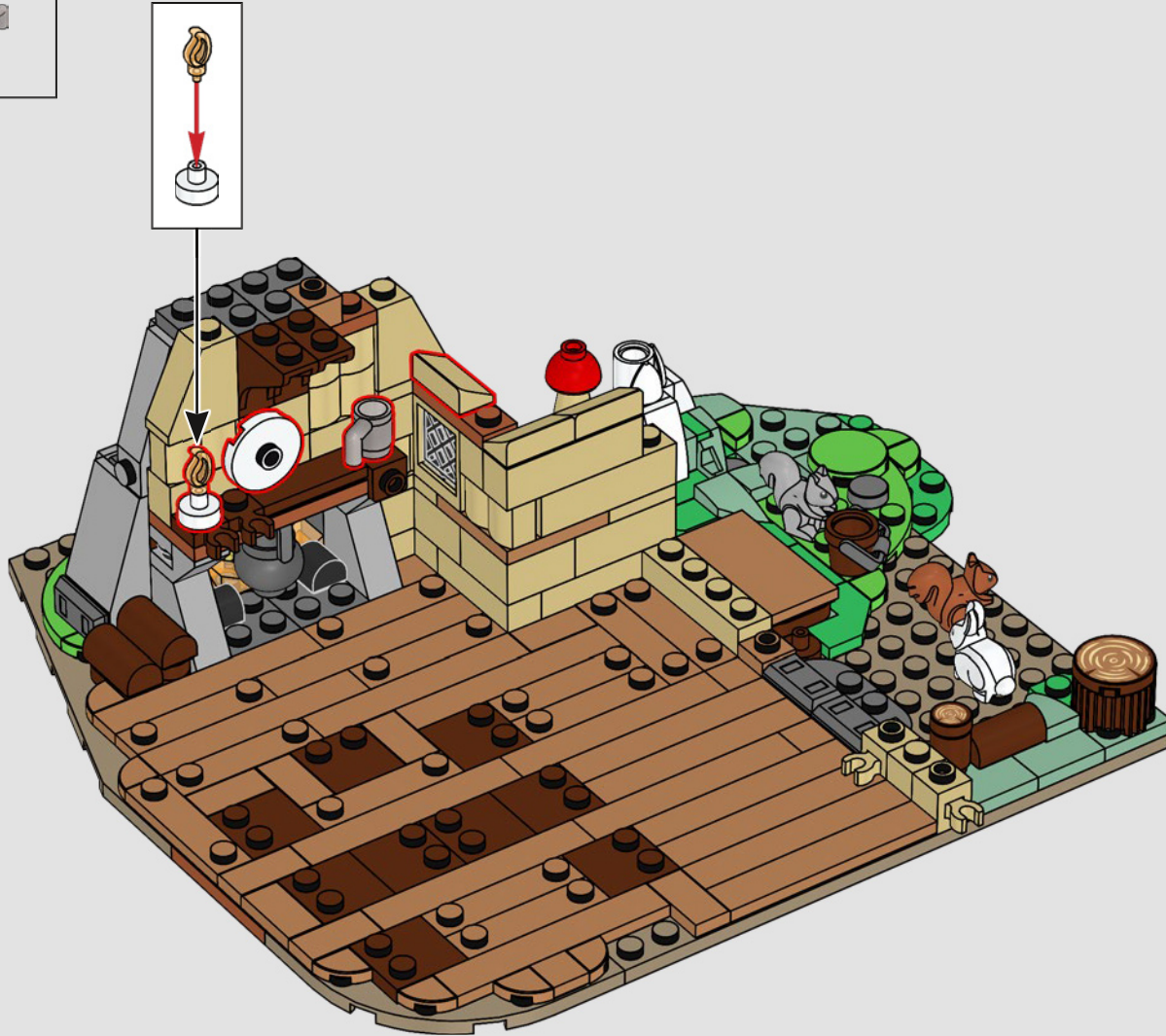

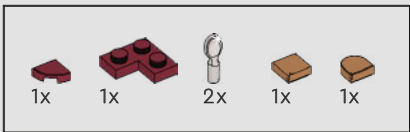

72

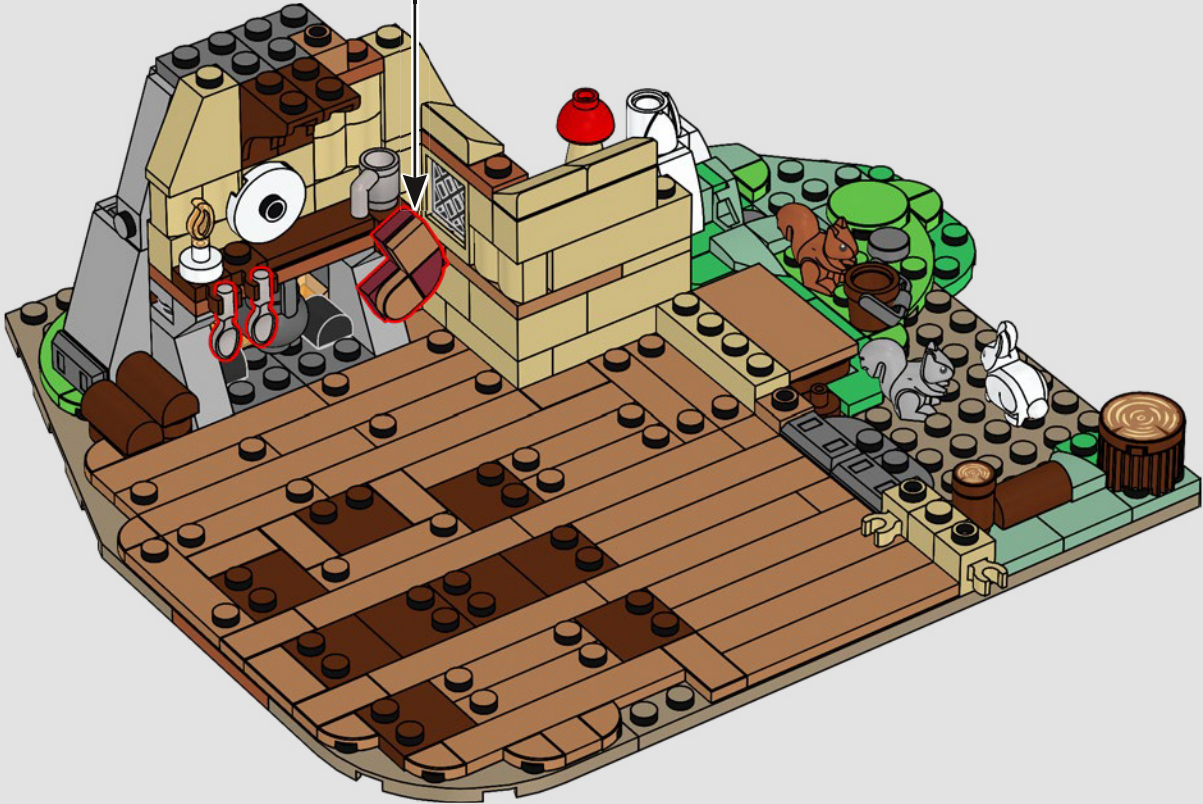
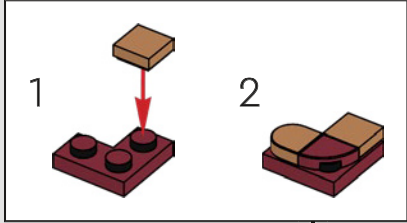

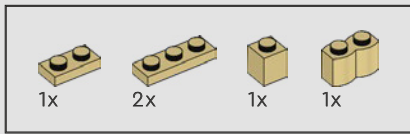

73

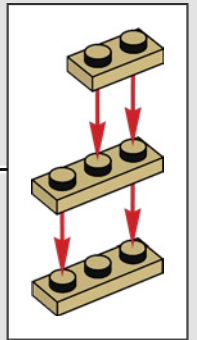
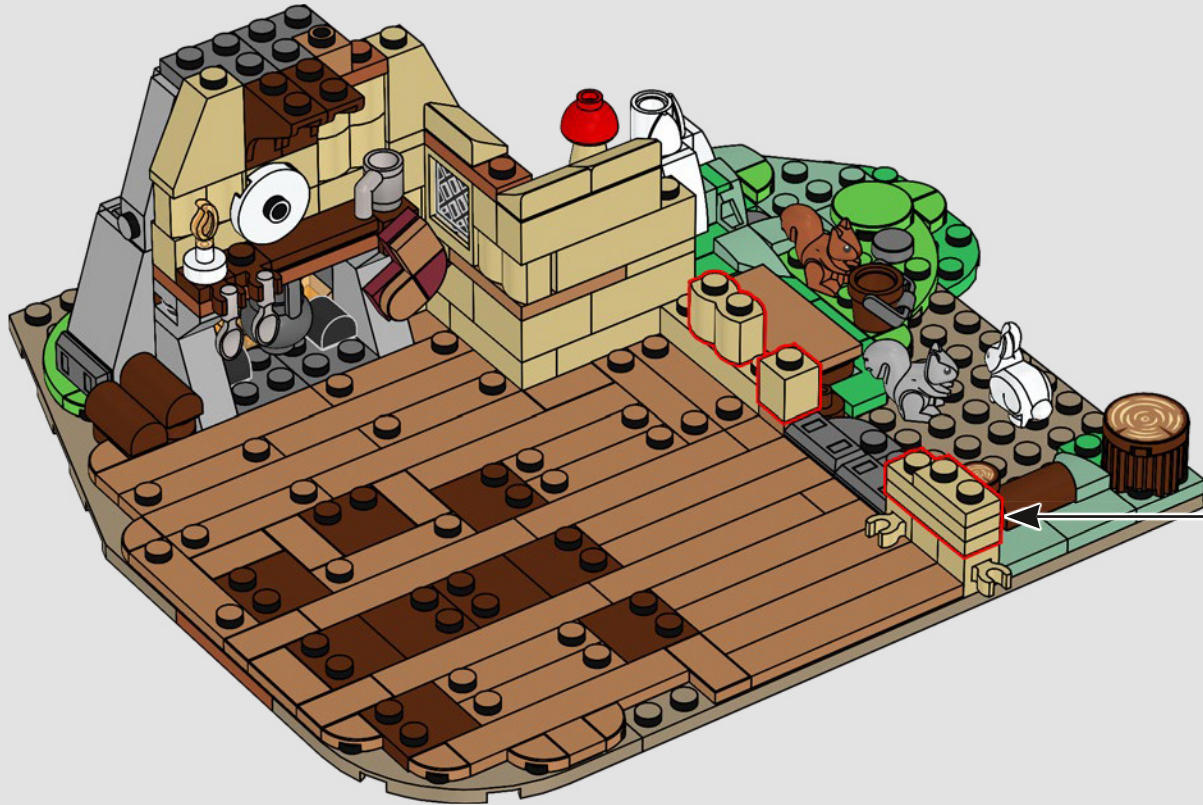



2x

74

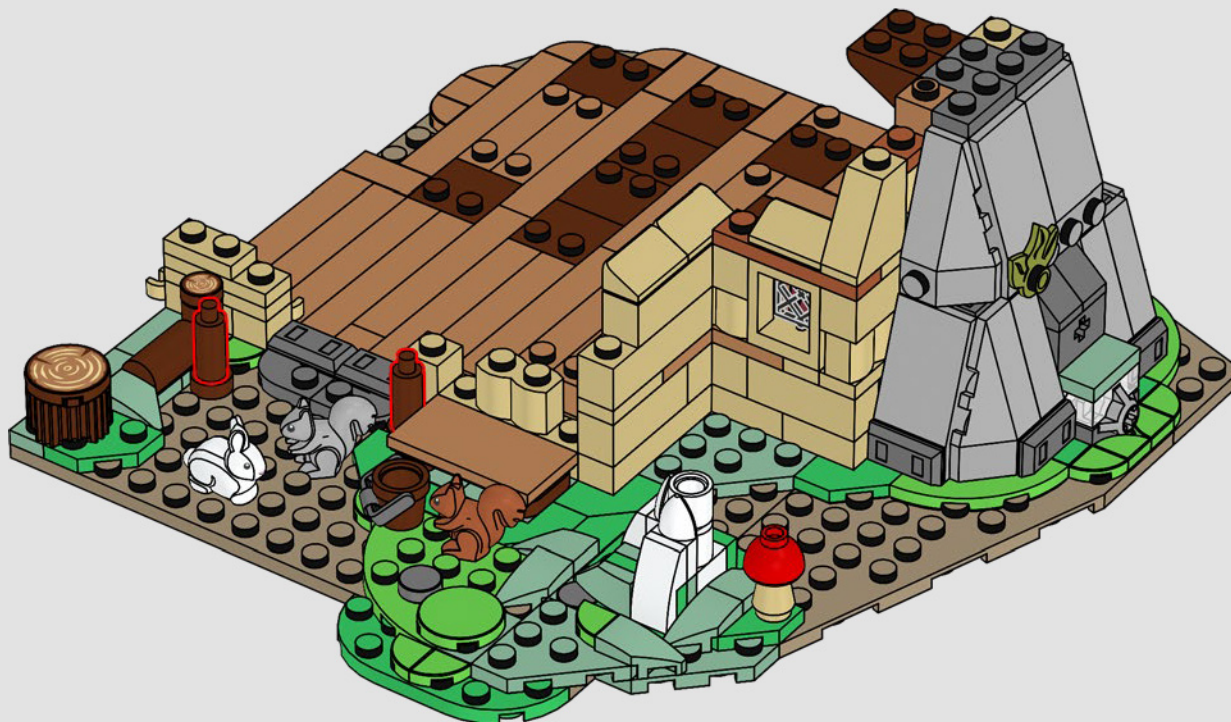

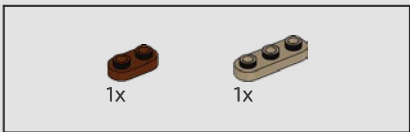

75

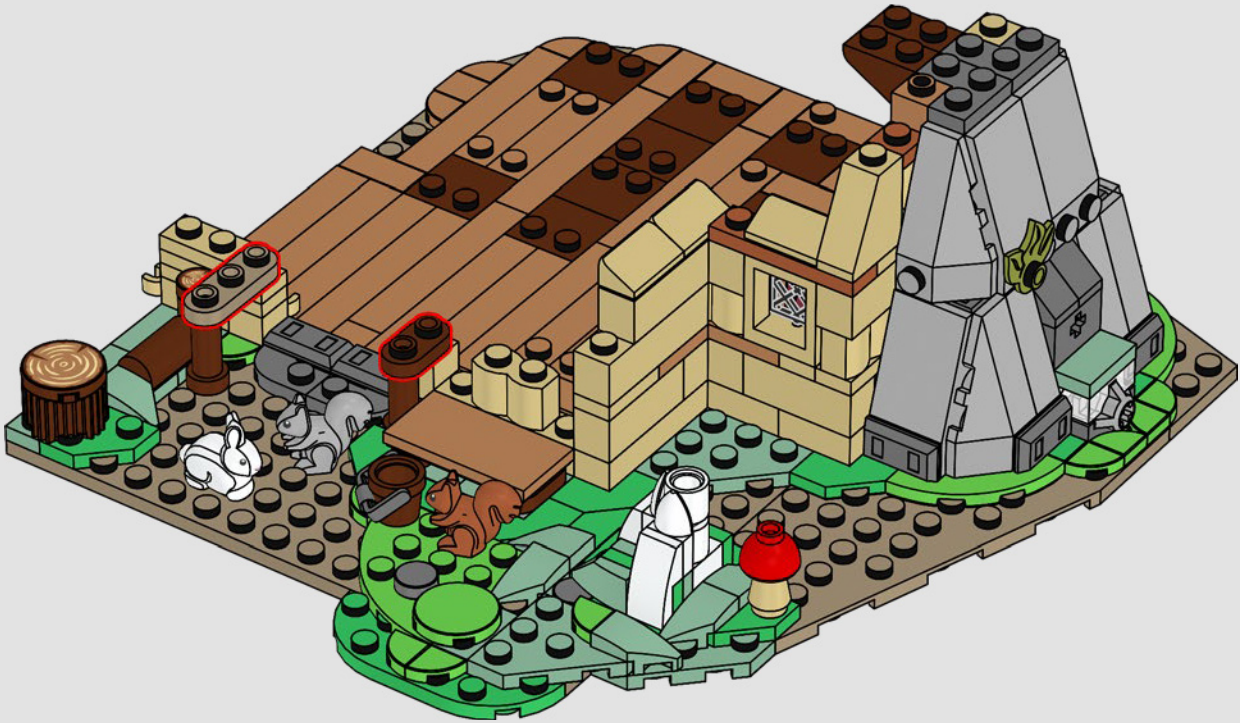

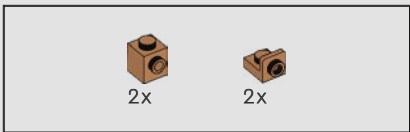

76

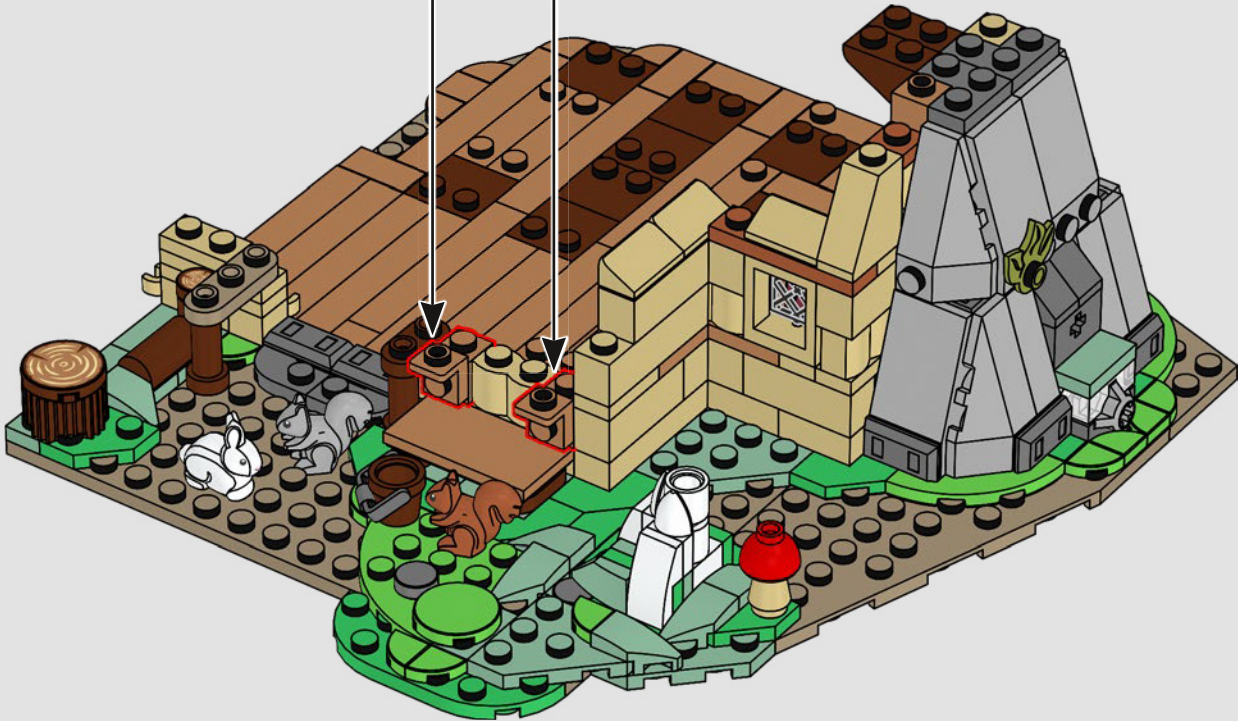
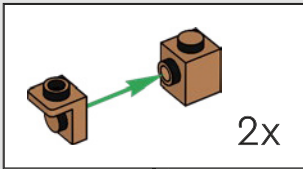

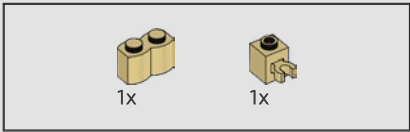

77

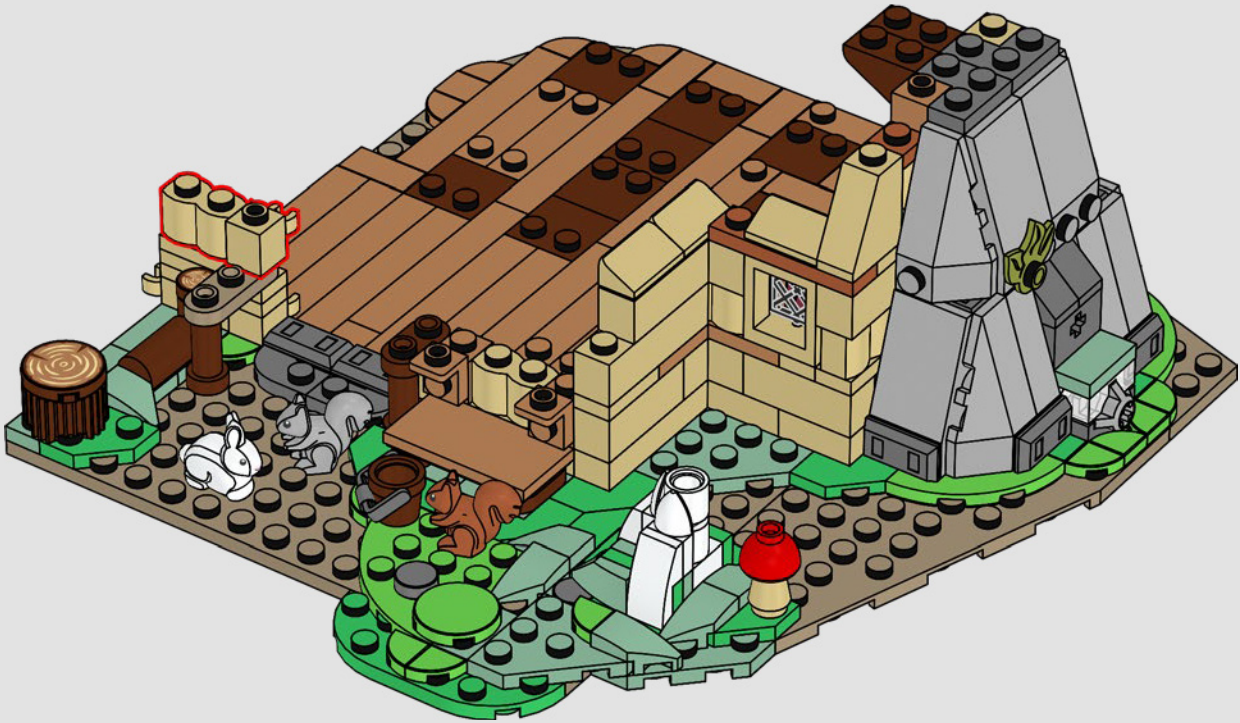

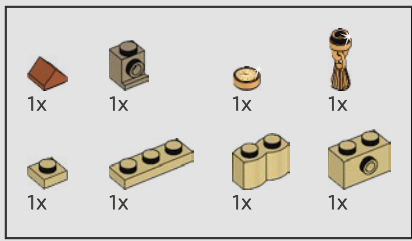

78

1

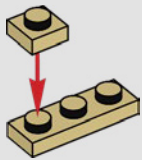

2

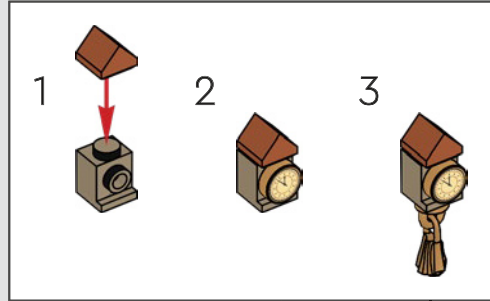
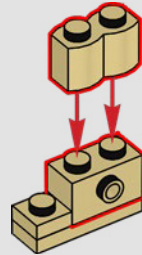

3

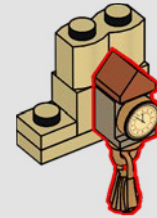



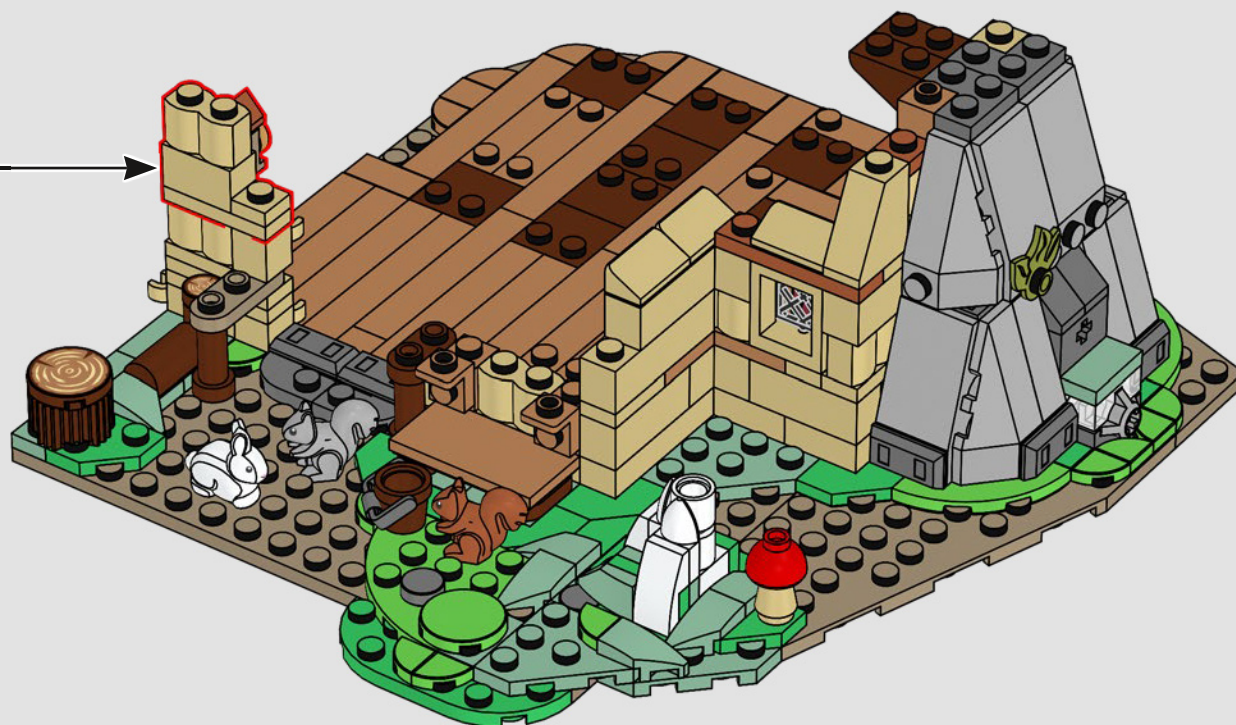

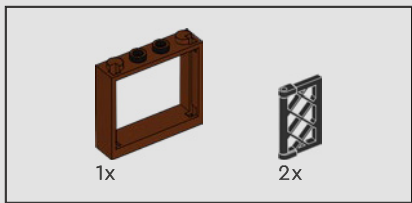

80

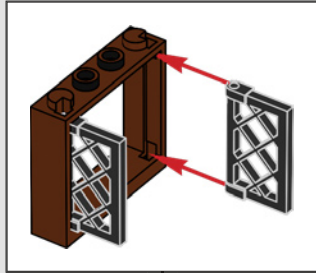

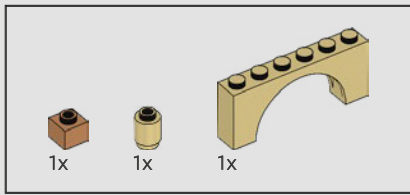

81

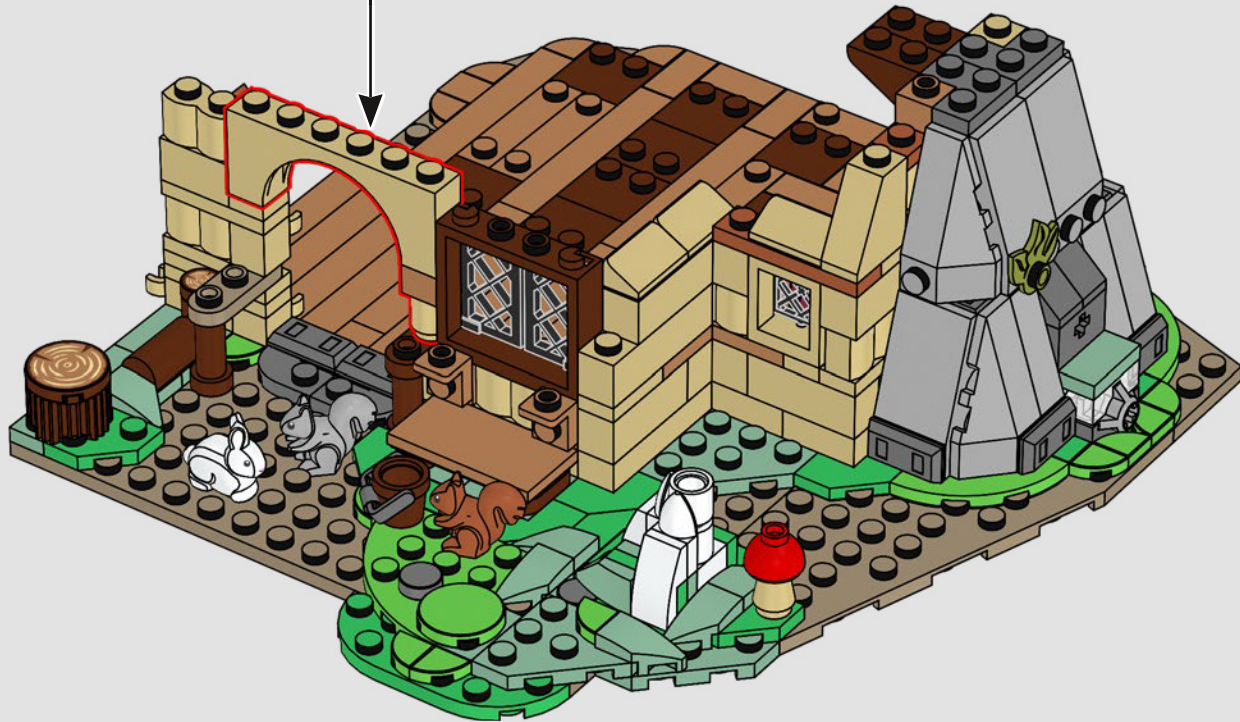
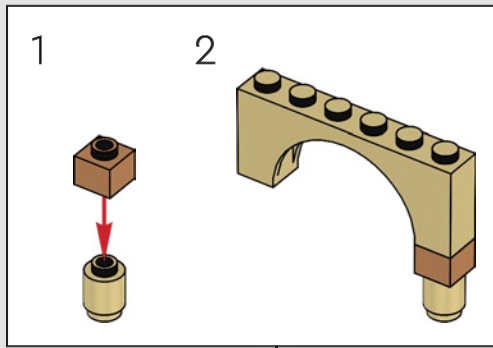

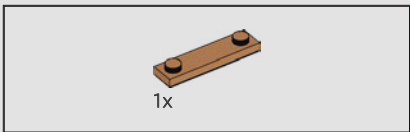

82

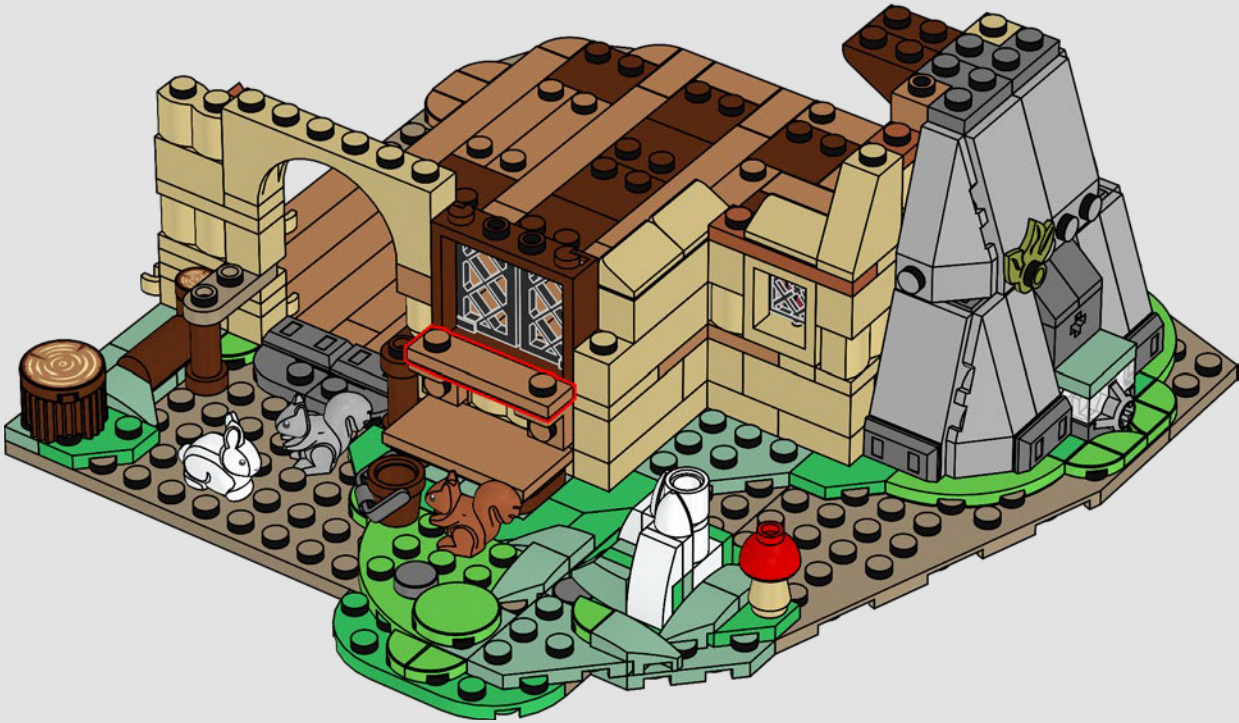

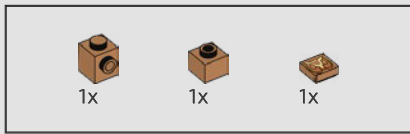

83

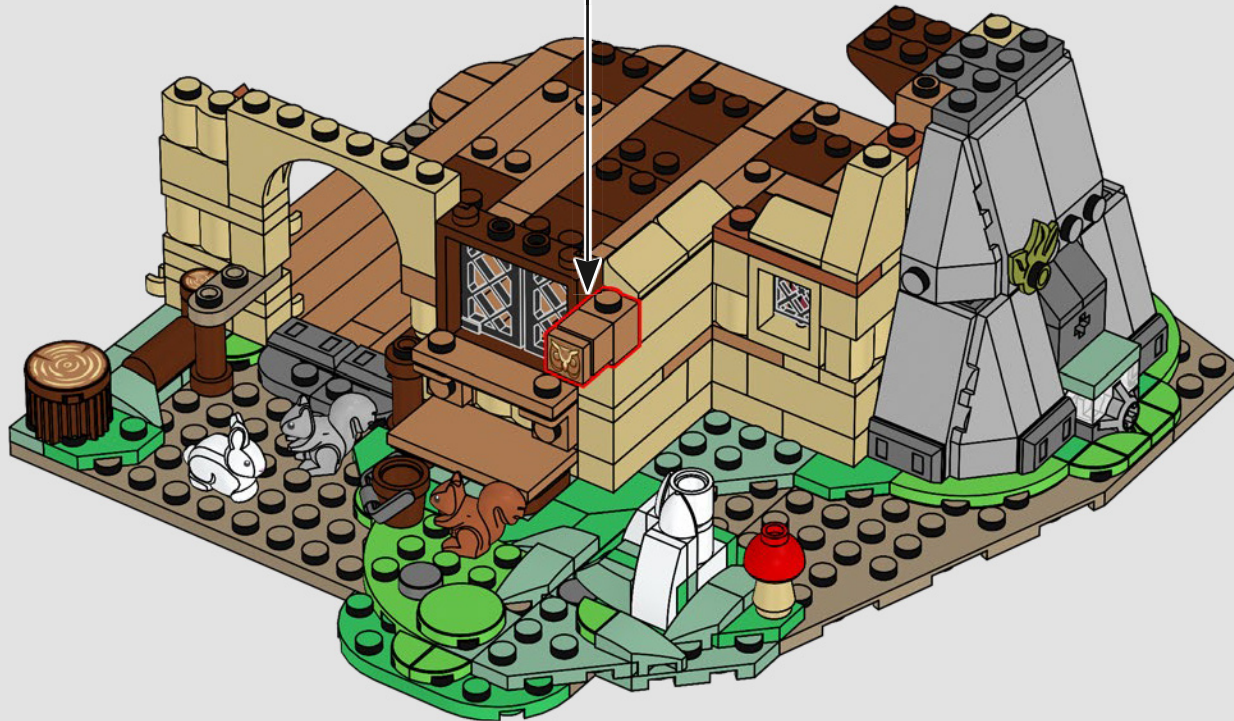
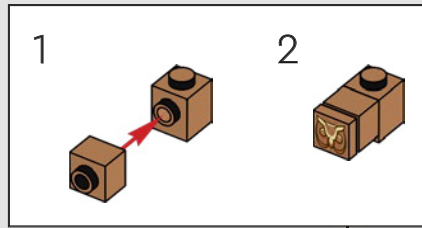

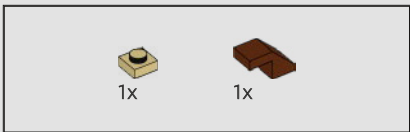

84

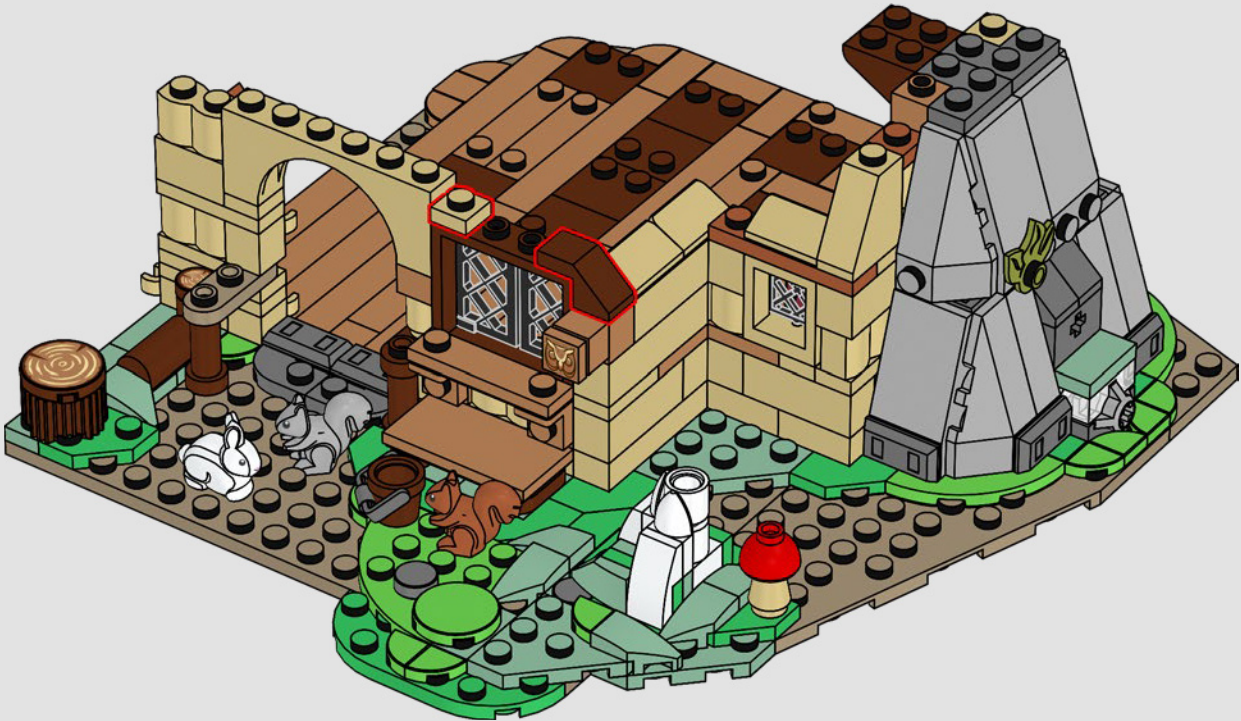

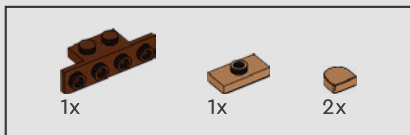

85

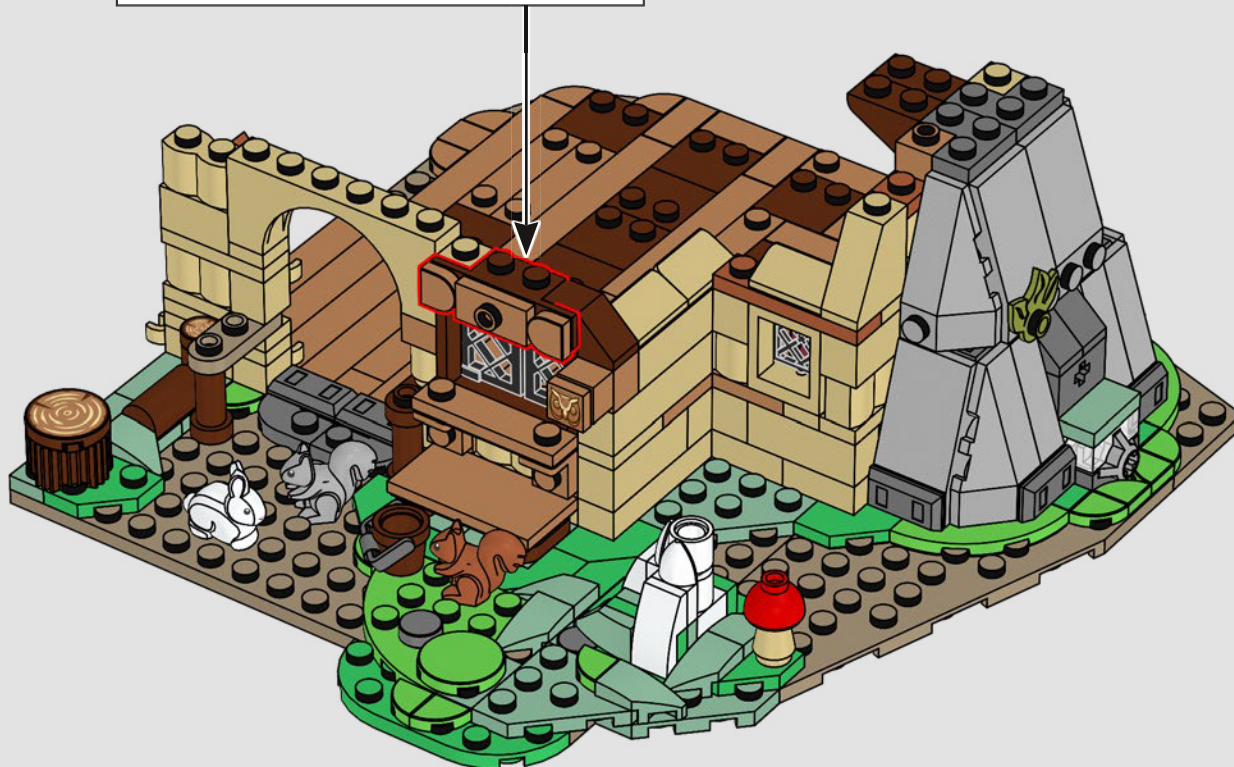
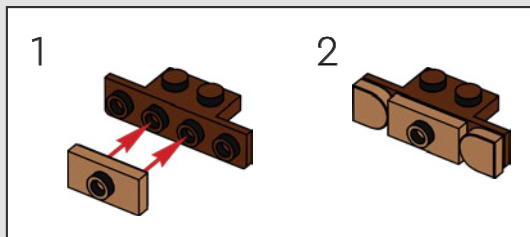



86

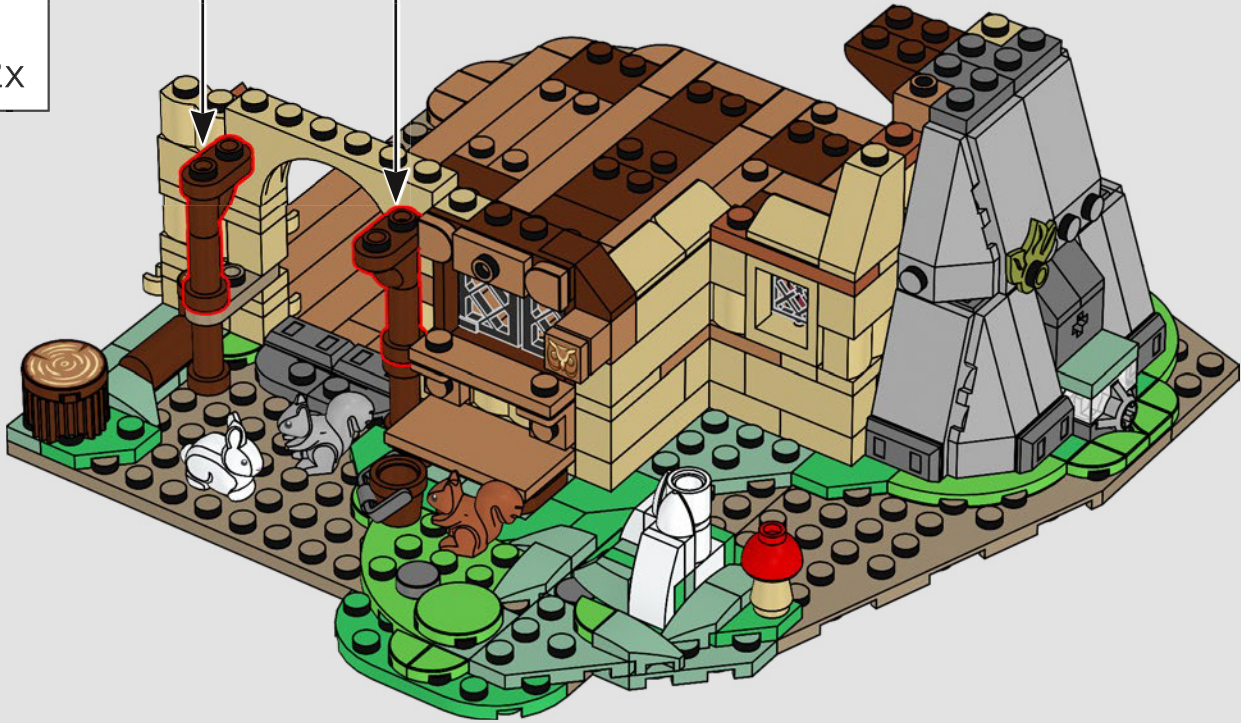
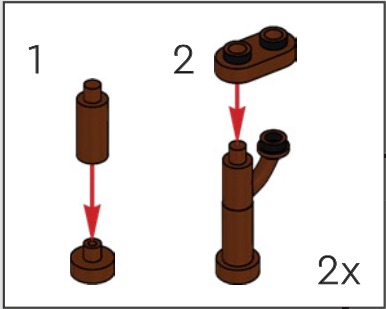



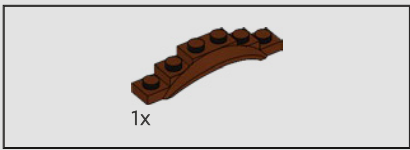

87

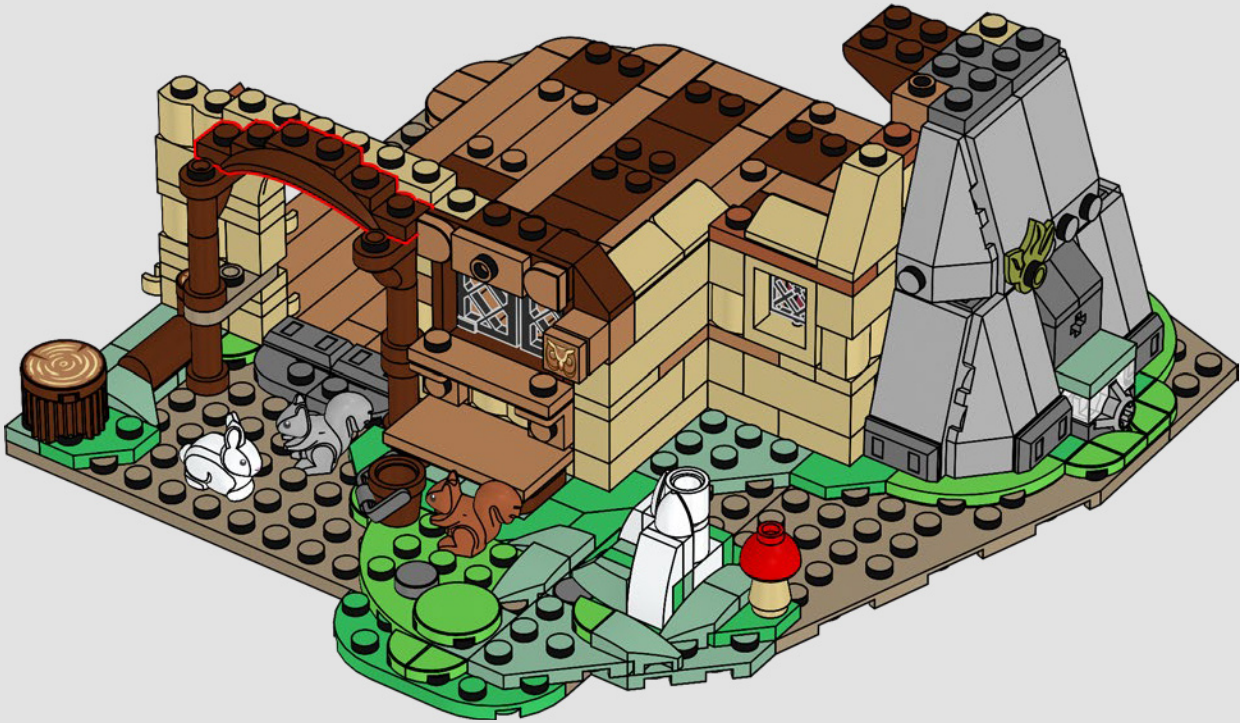

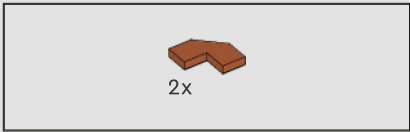

88

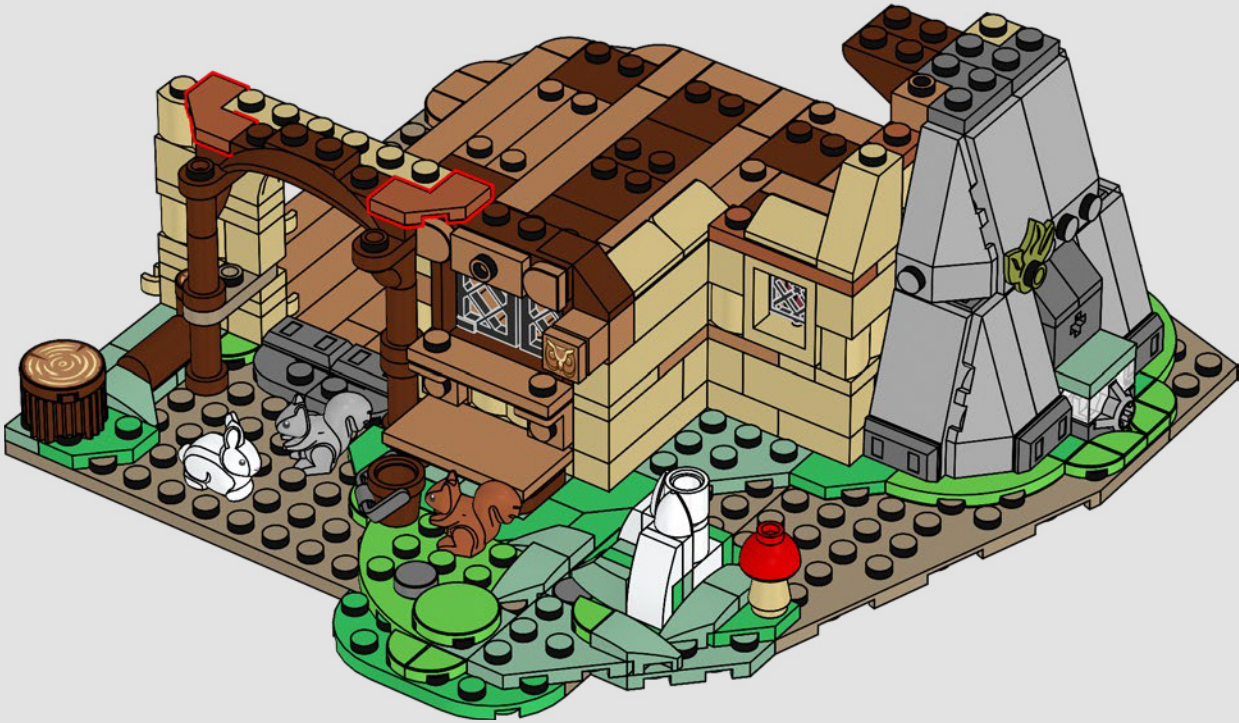

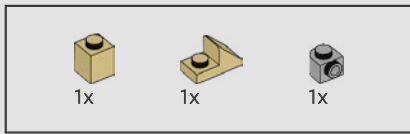

89

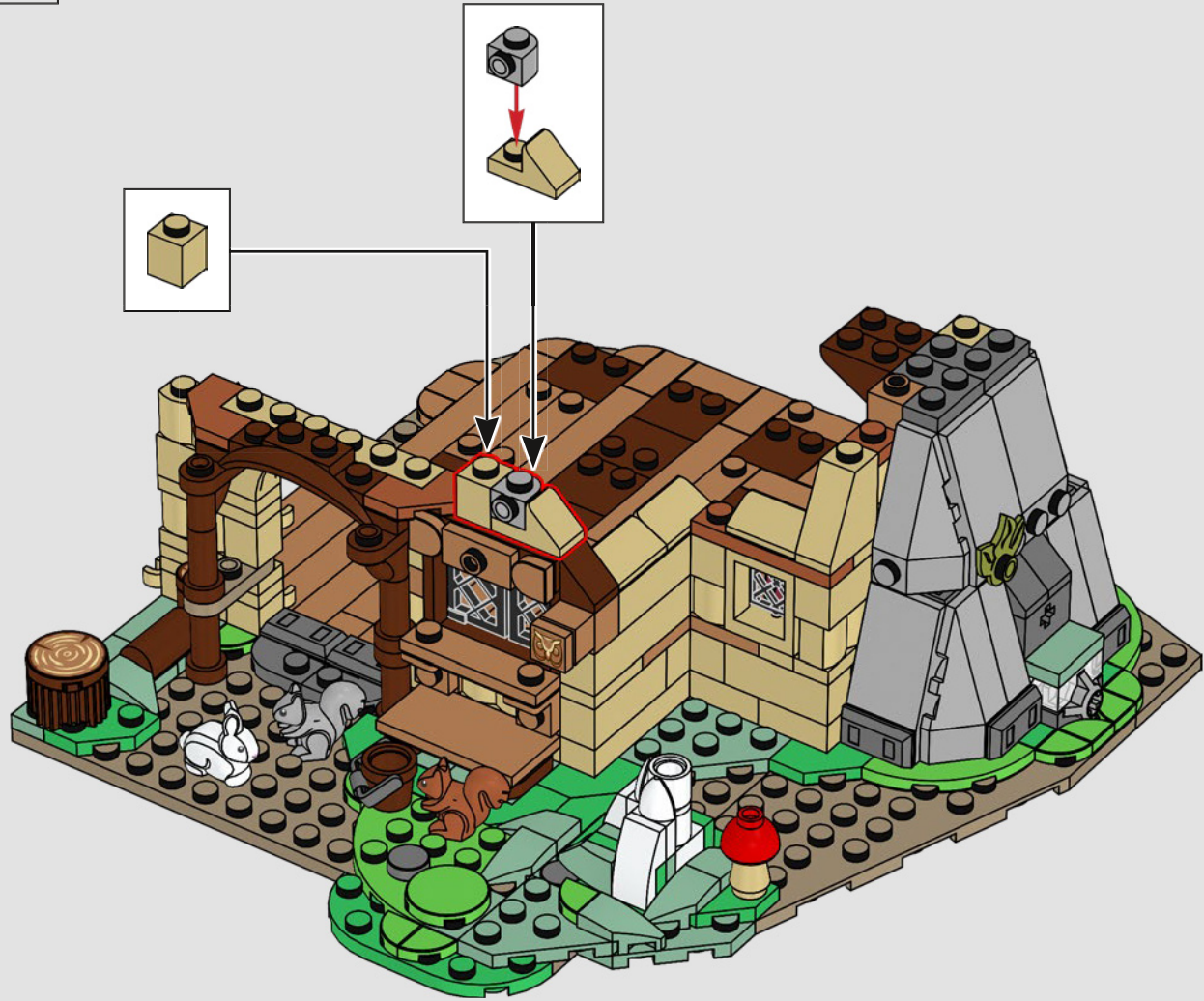

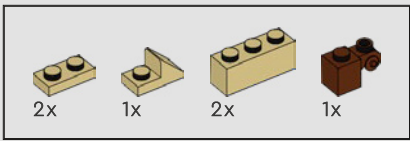

90

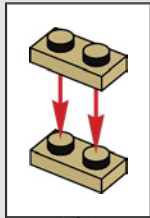



91

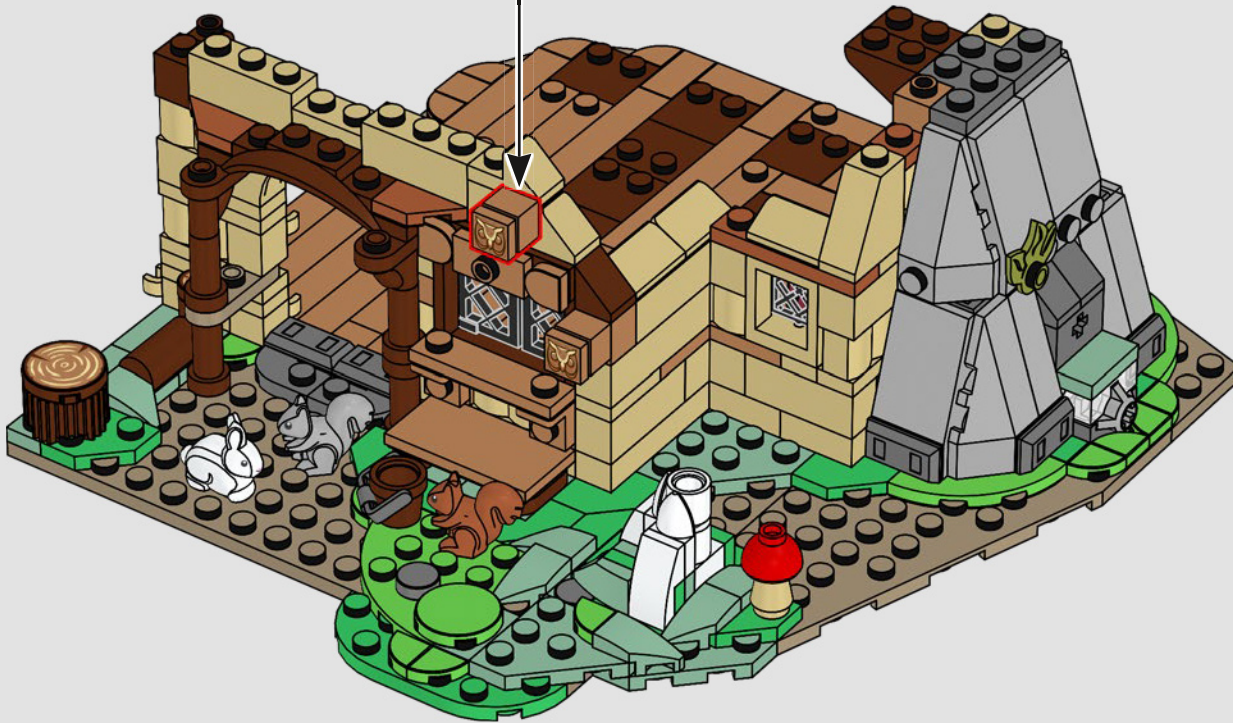
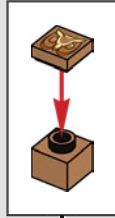

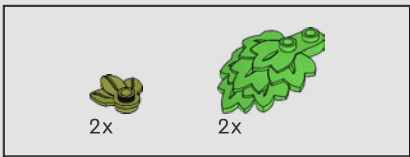

92

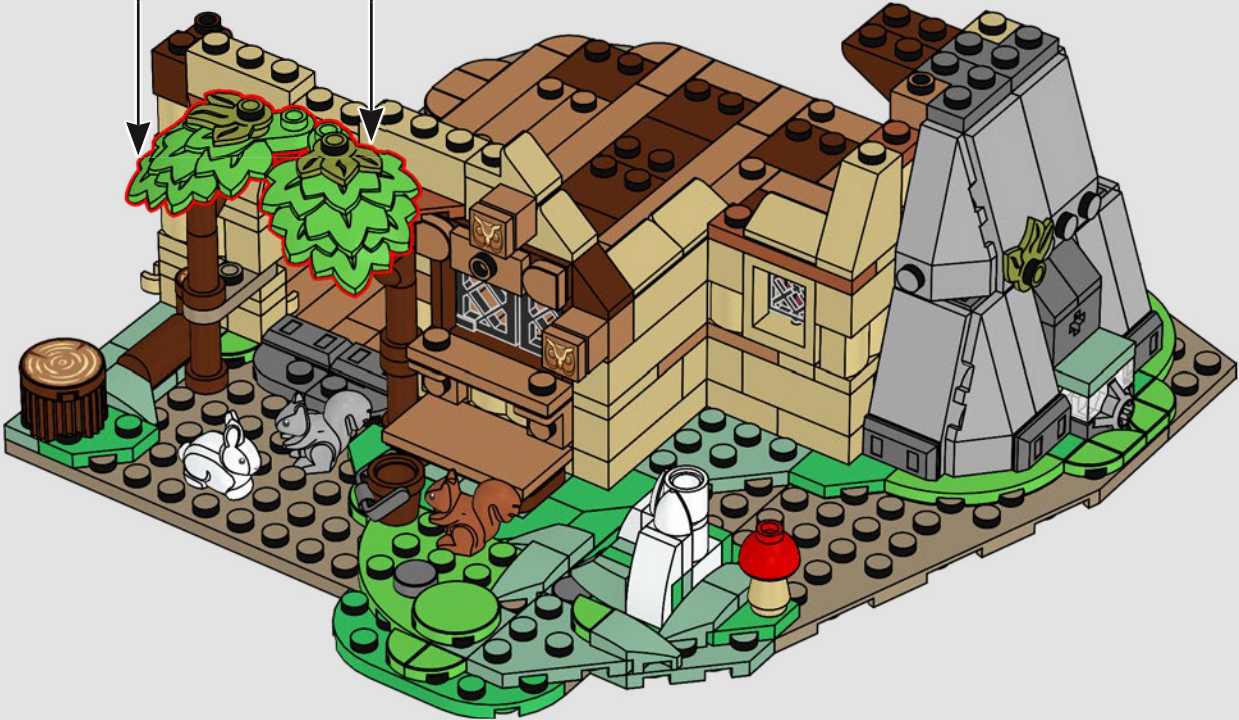
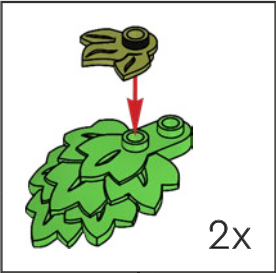



1x

93

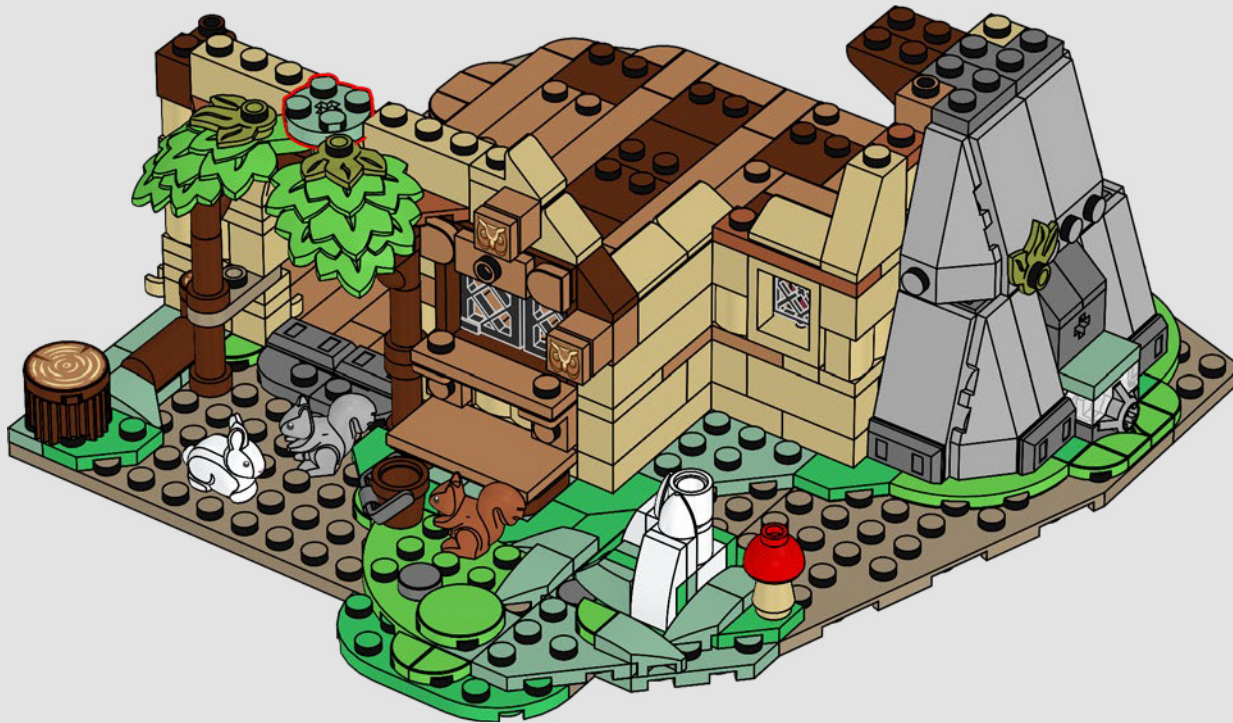

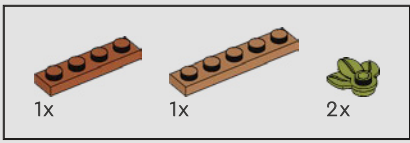

94

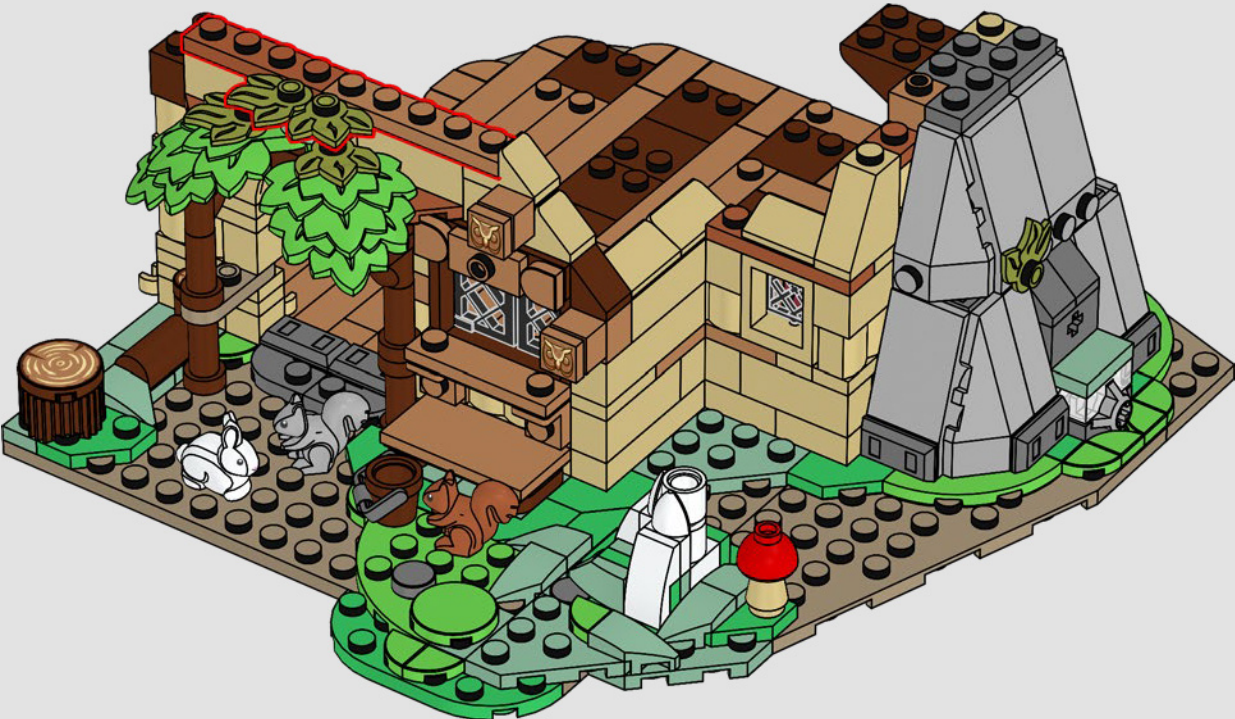



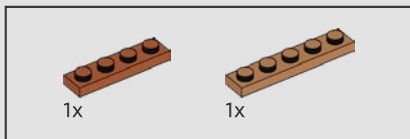

95

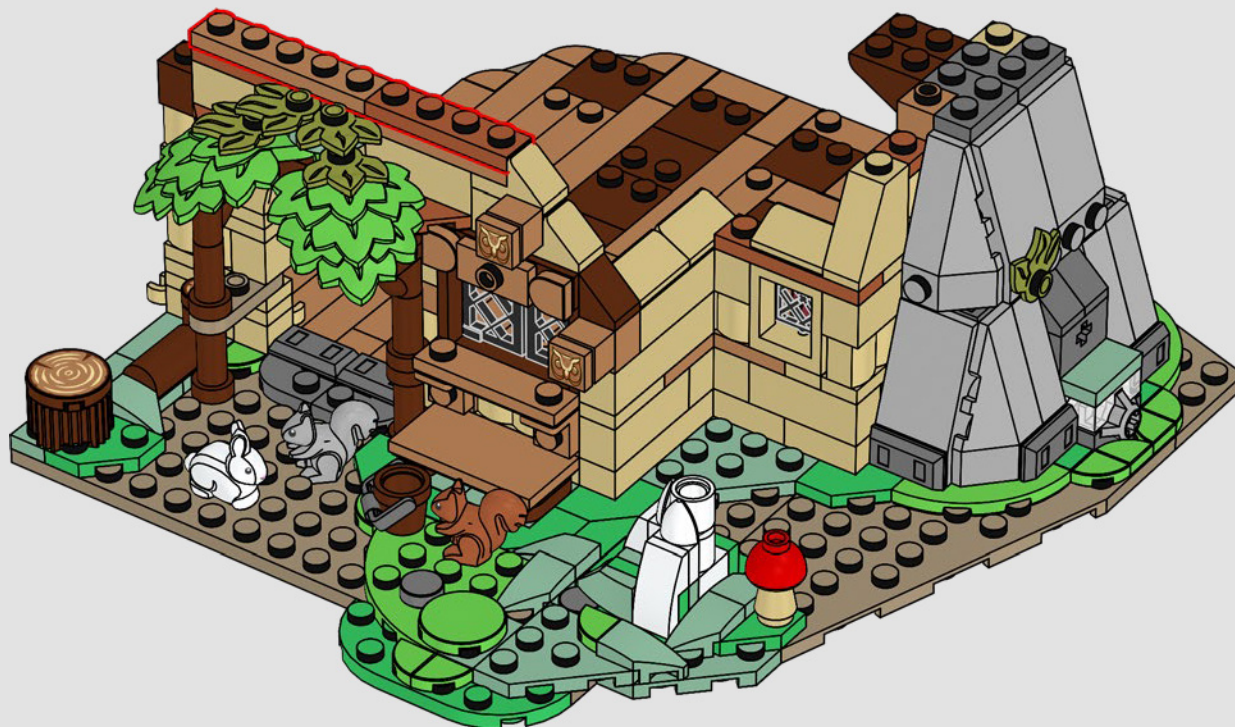



1x

96



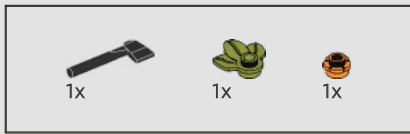

97

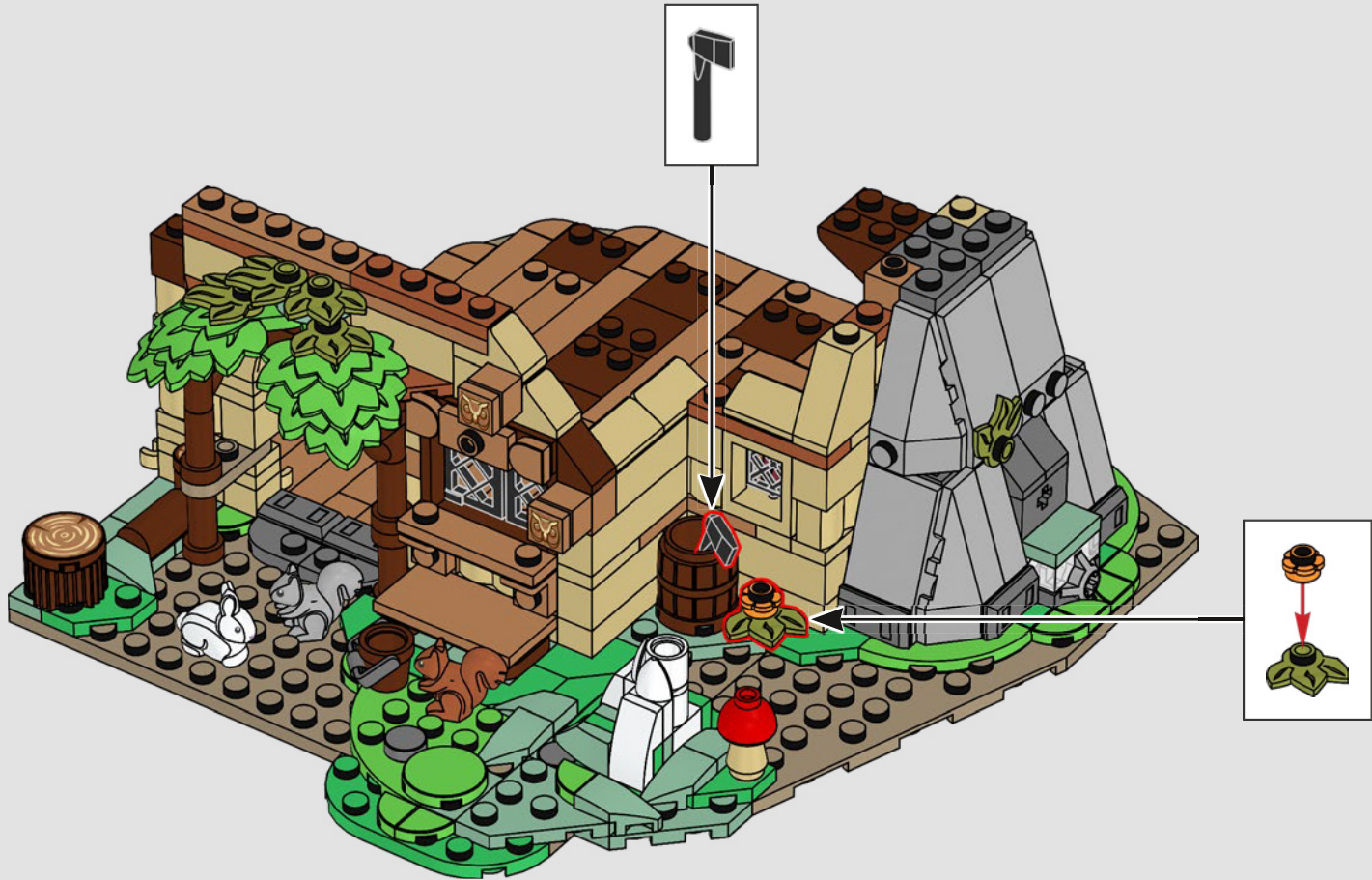

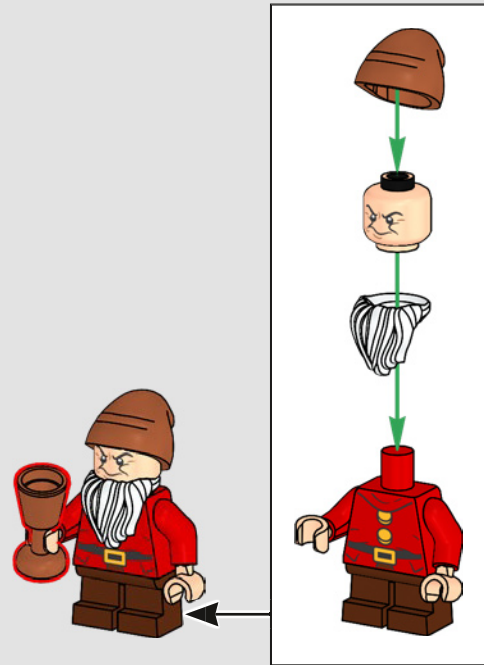

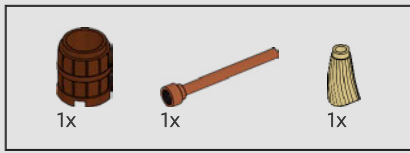

98

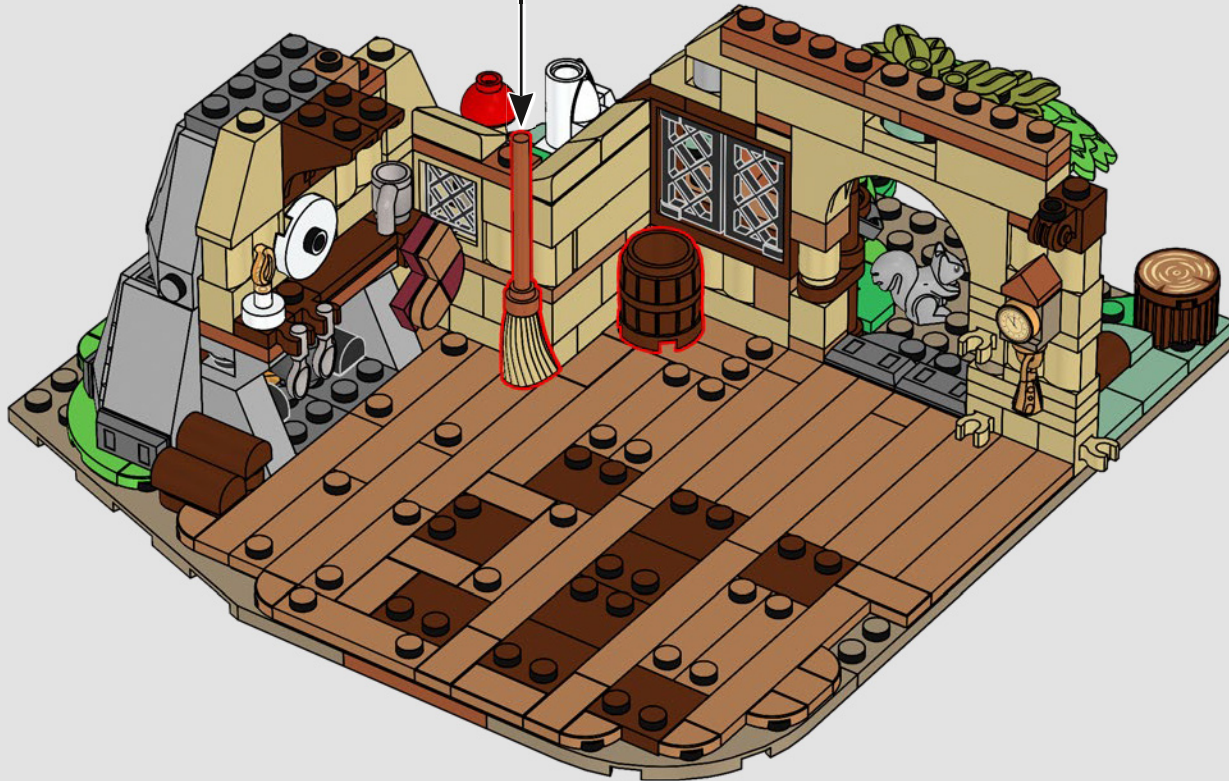
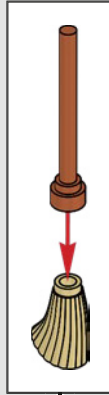

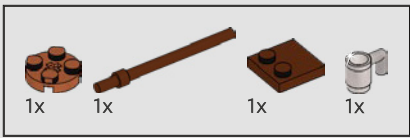

99

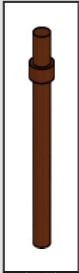
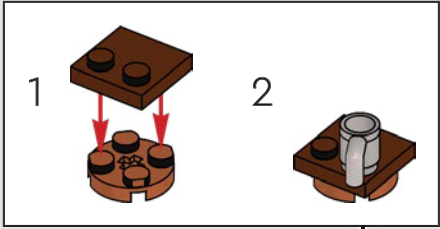

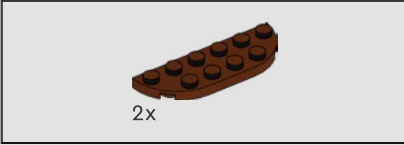
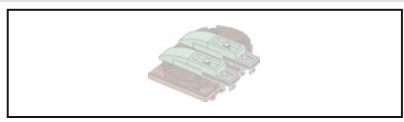

2x

100

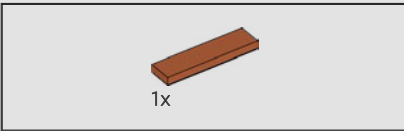
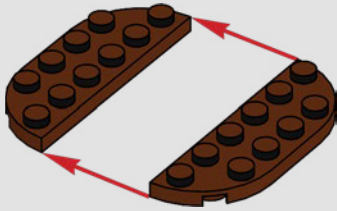

1x

101

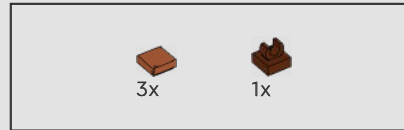
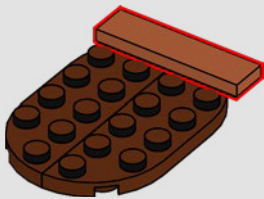

3x

1x

102

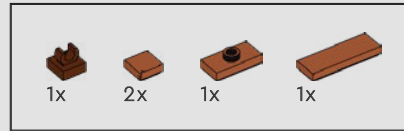
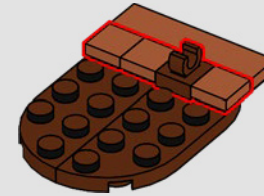

1x

2x

1x

1x

103

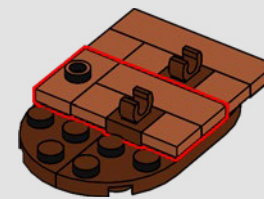

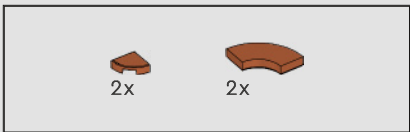

104

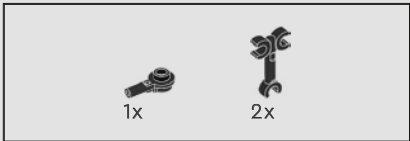
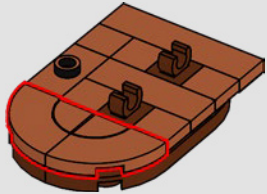

105

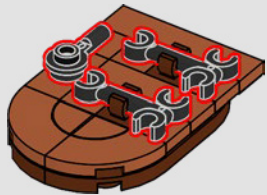

106

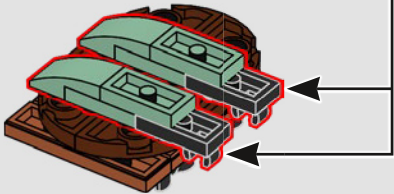
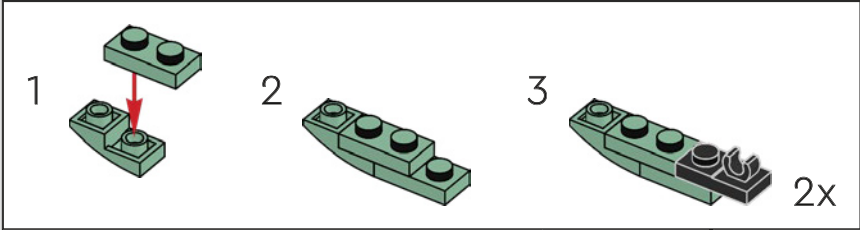





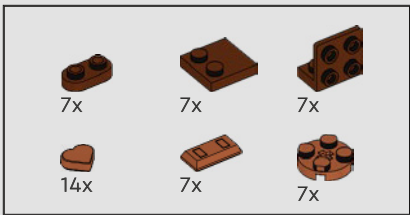

108

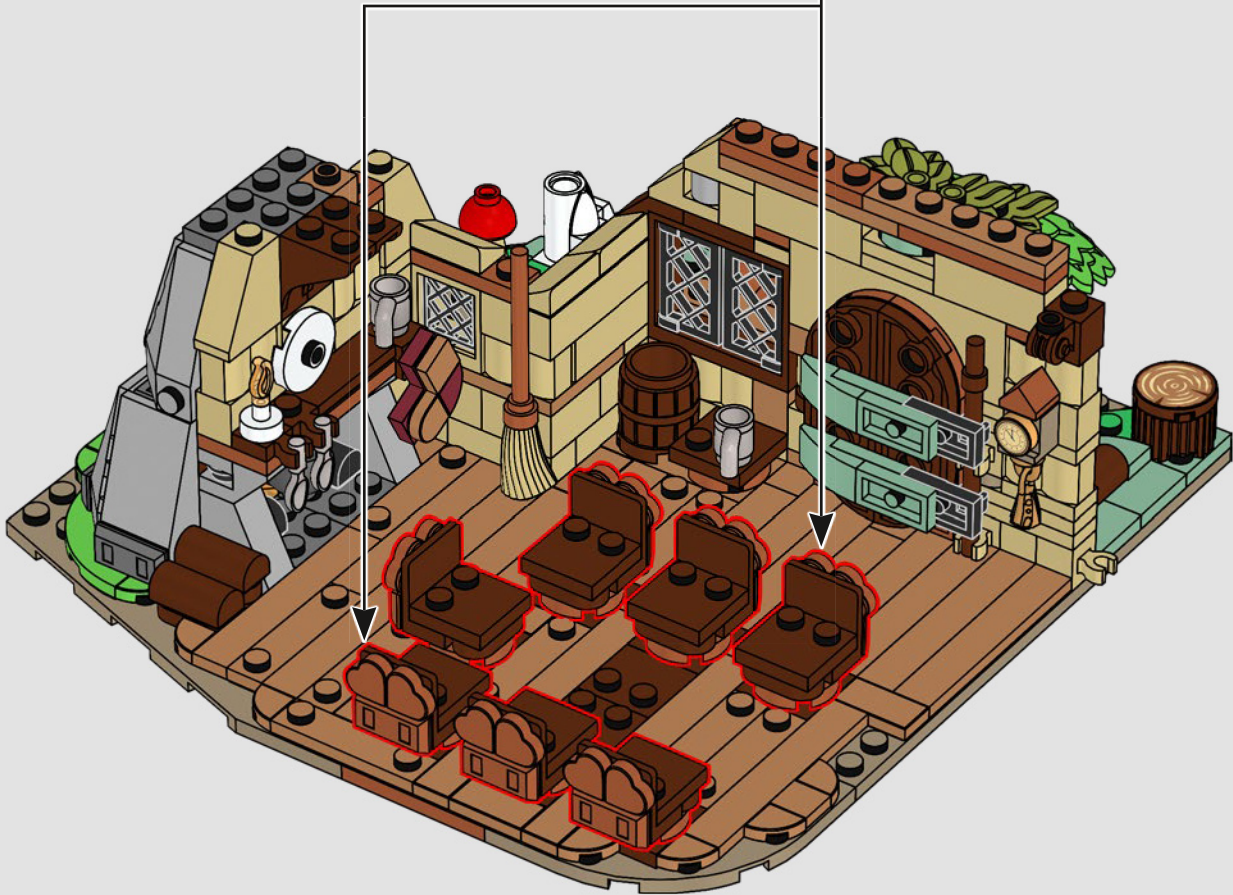
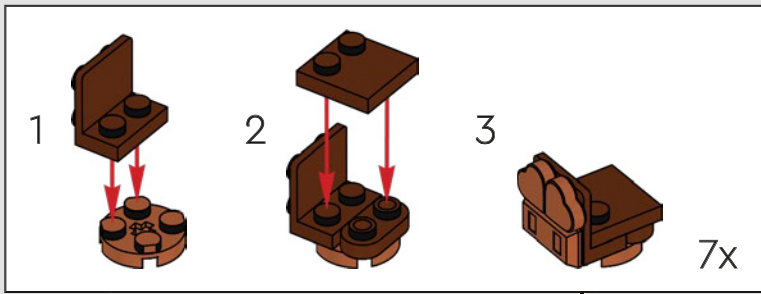

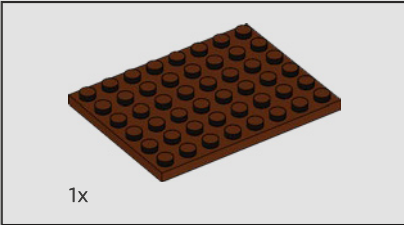
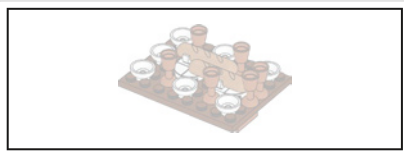

109

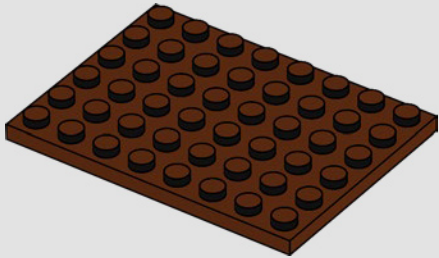

110

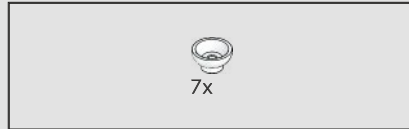
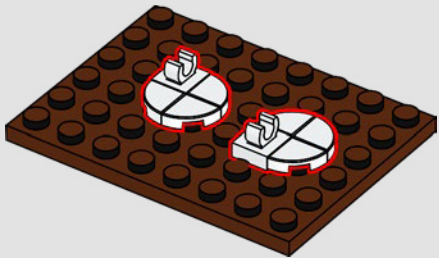

111

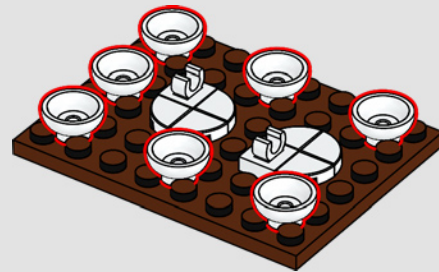

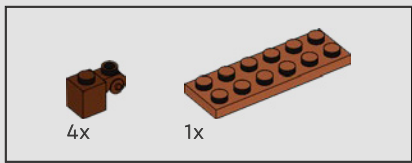

112

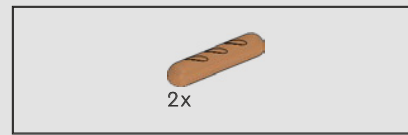
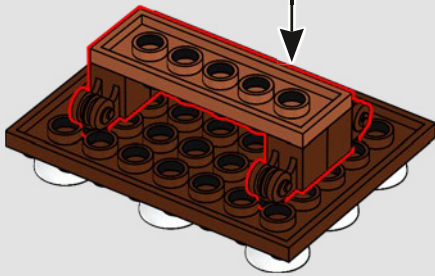
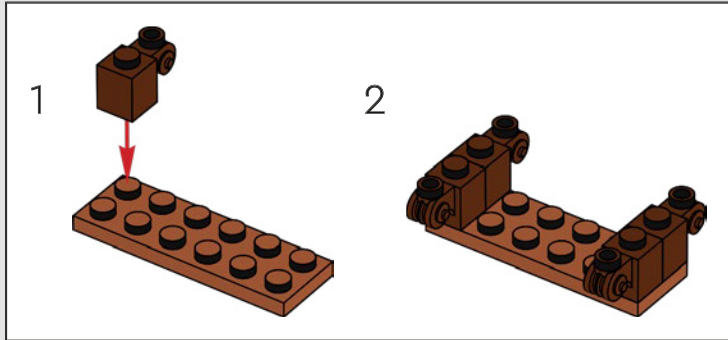

113

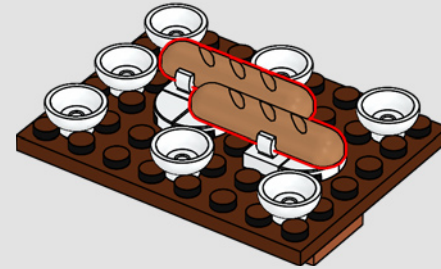

114

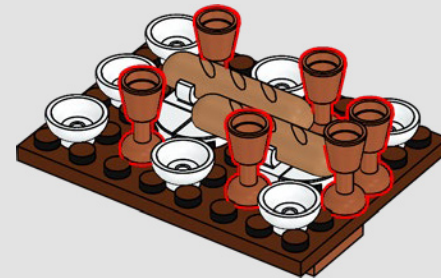



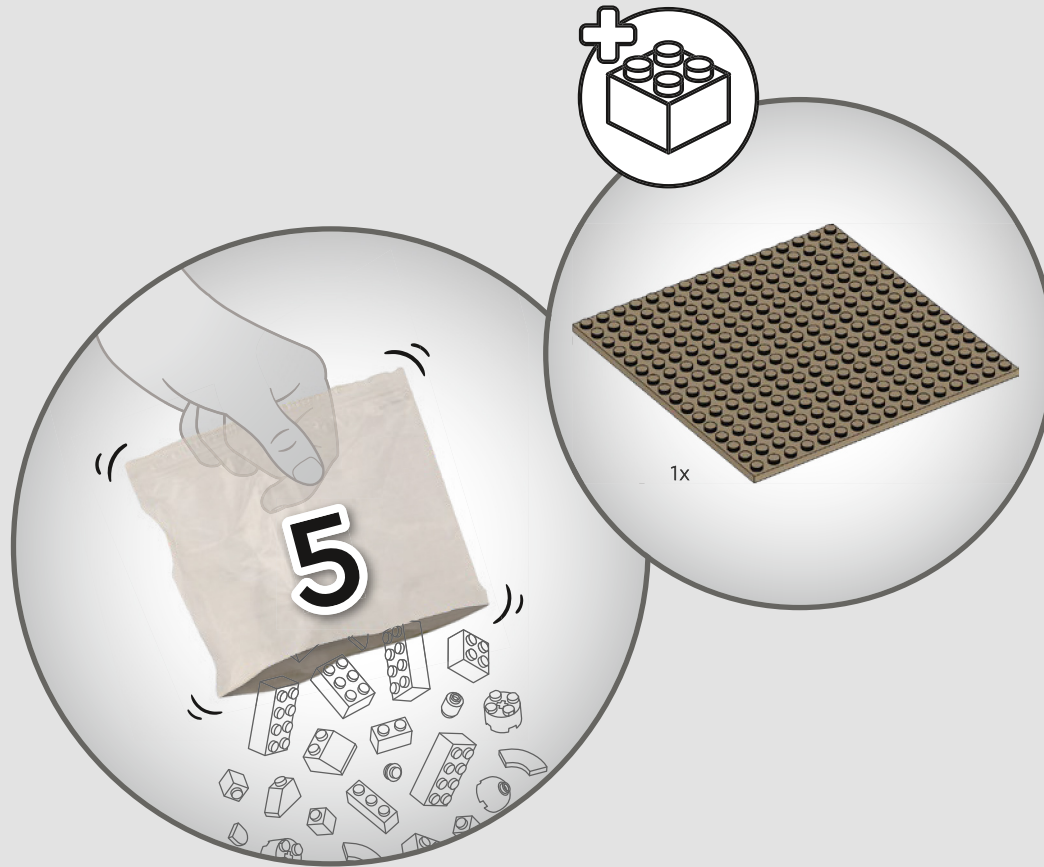

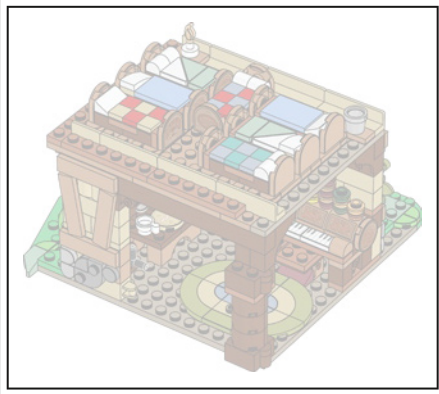

116

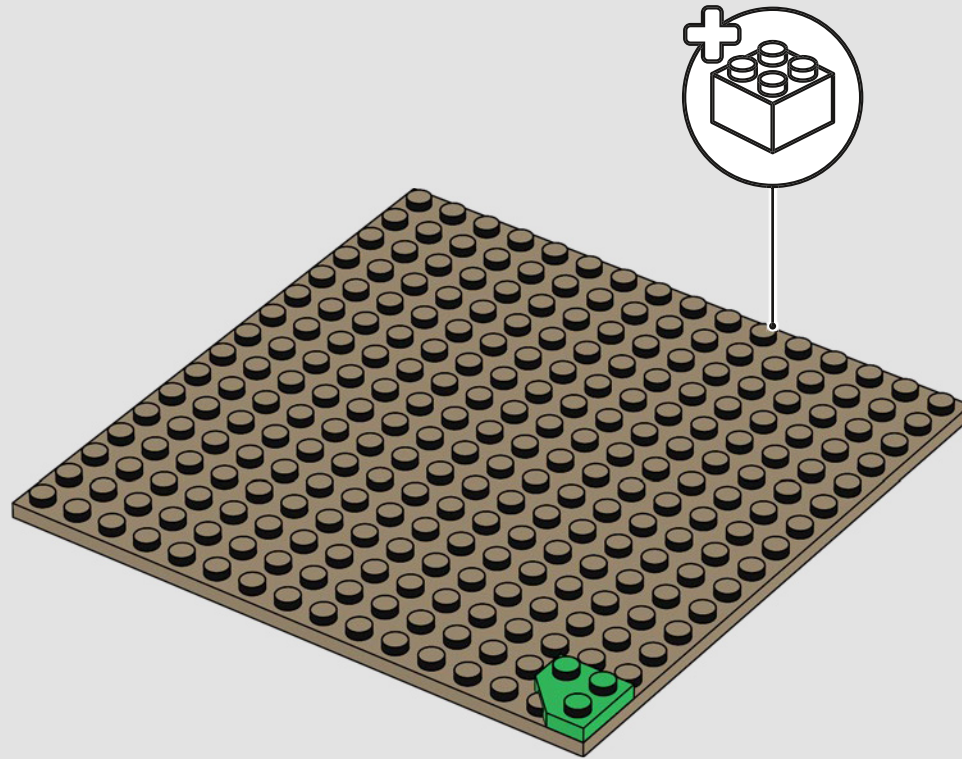

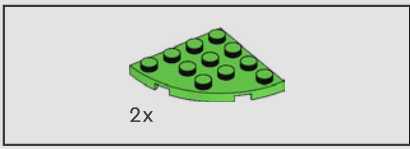

117

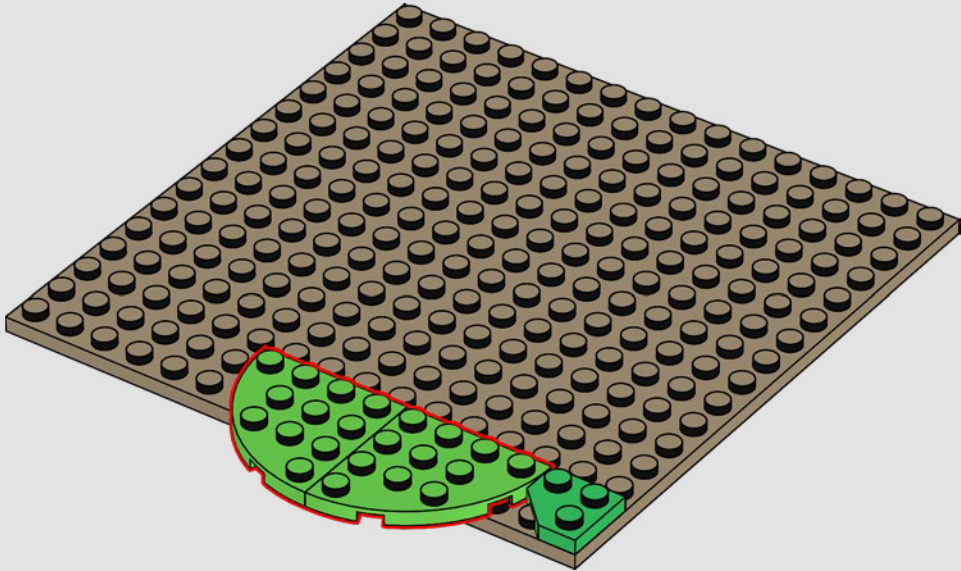

118

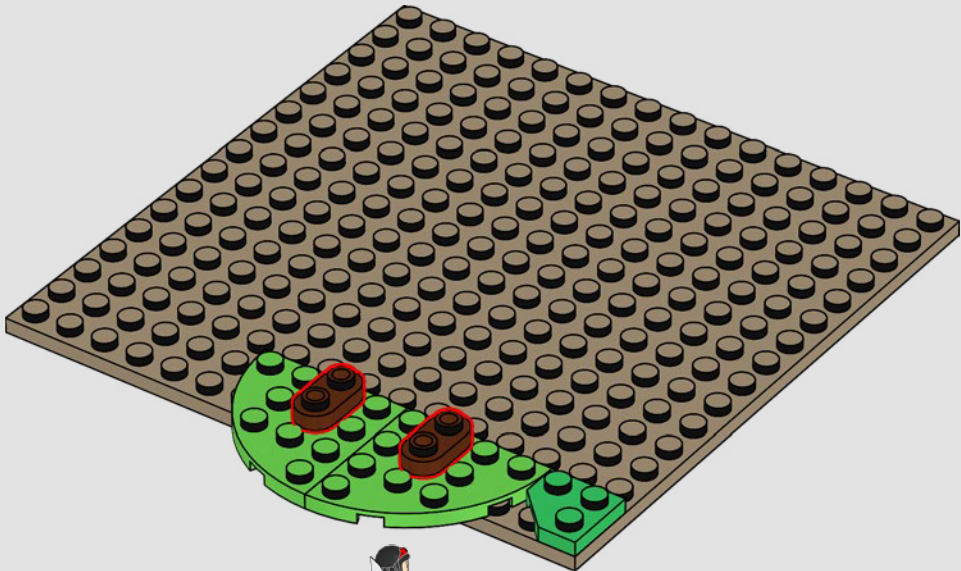



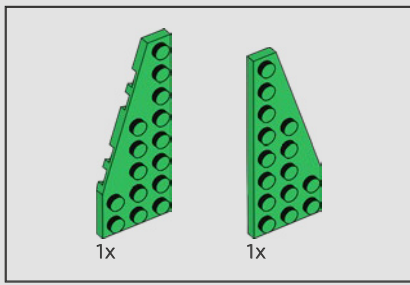

119



120

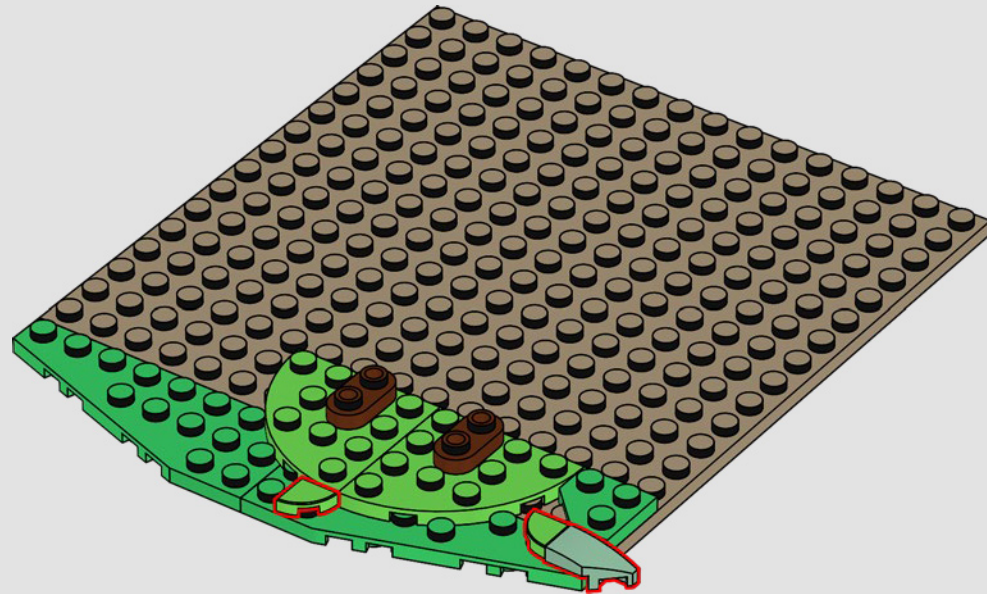

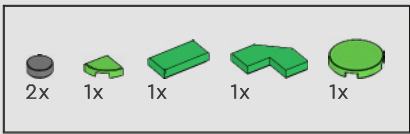

121

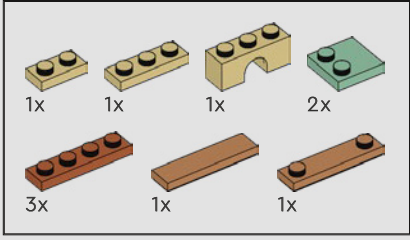

122



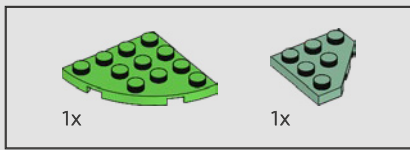

123

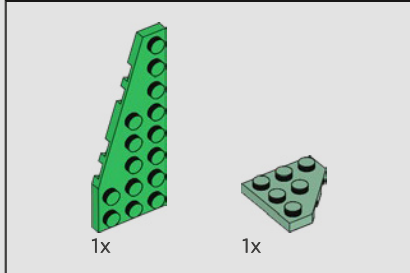
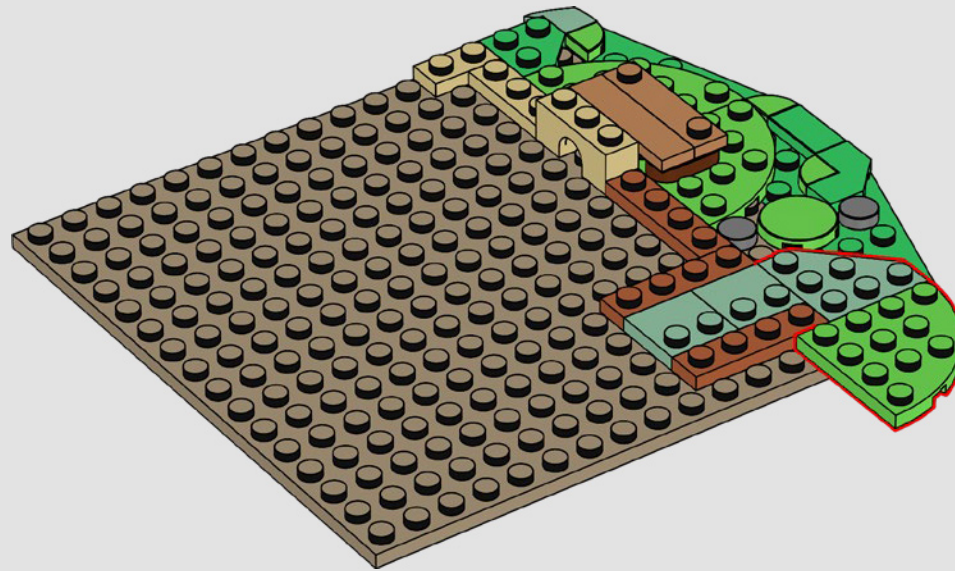

124



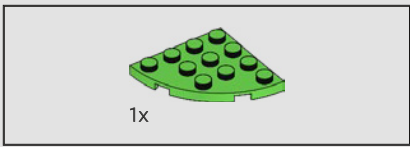

125

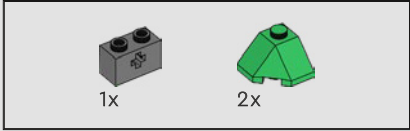

126



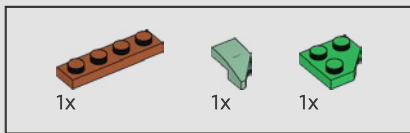

127

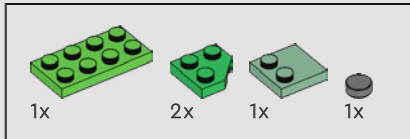
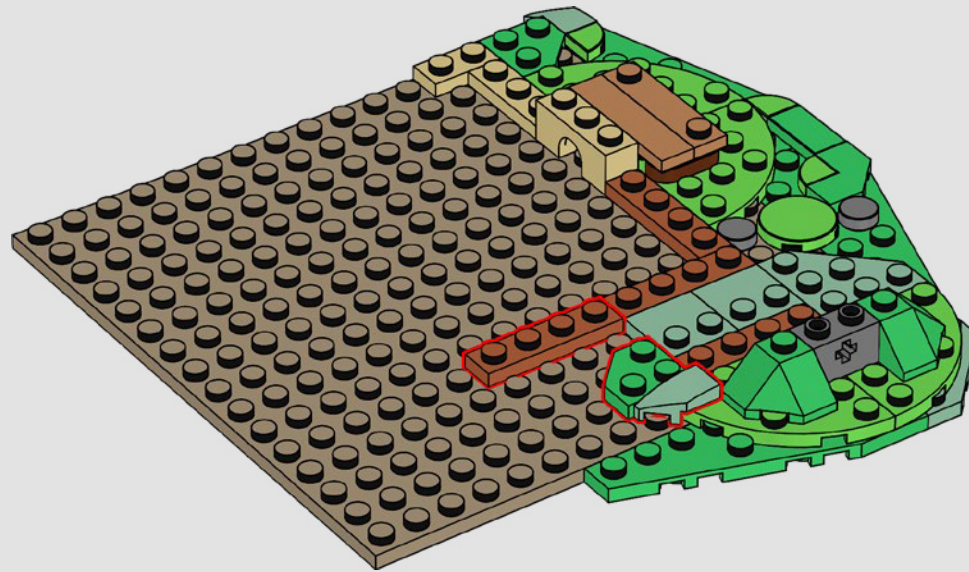

128



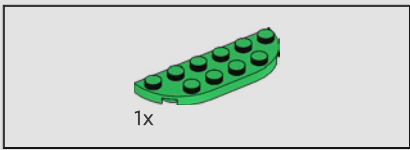

129

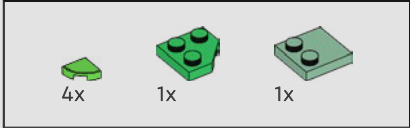
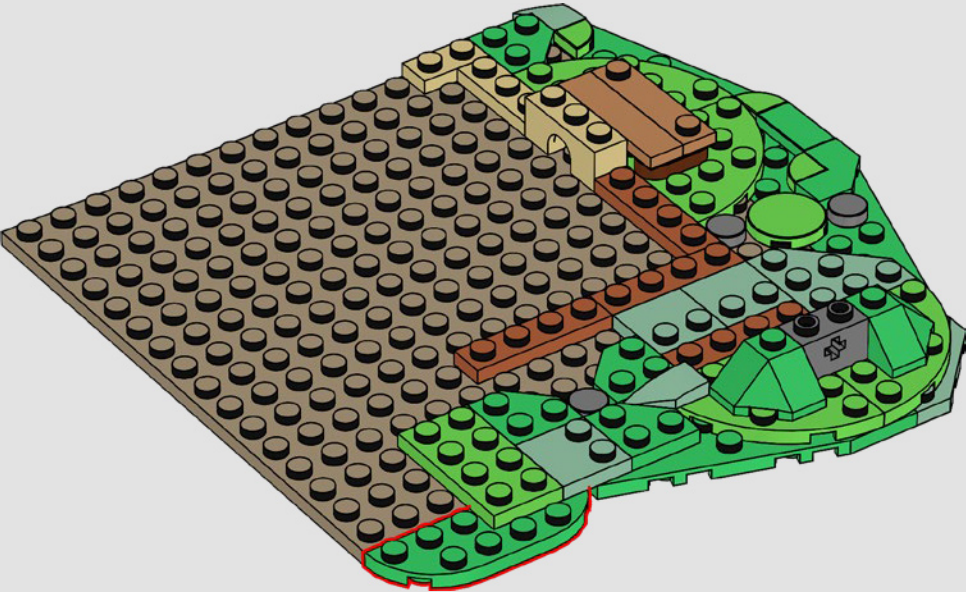

130



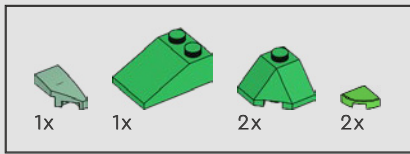

131

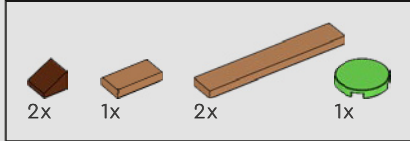
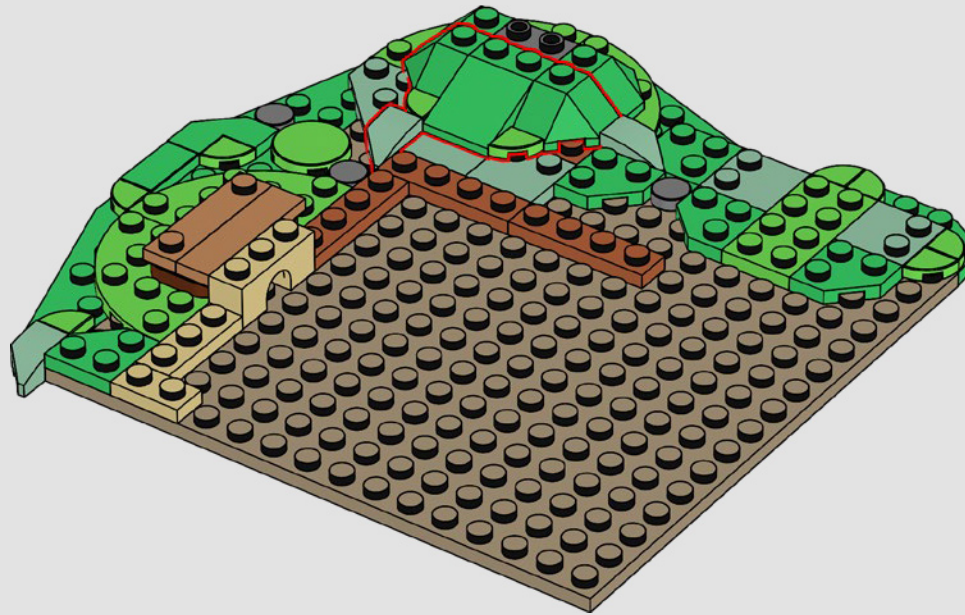

132

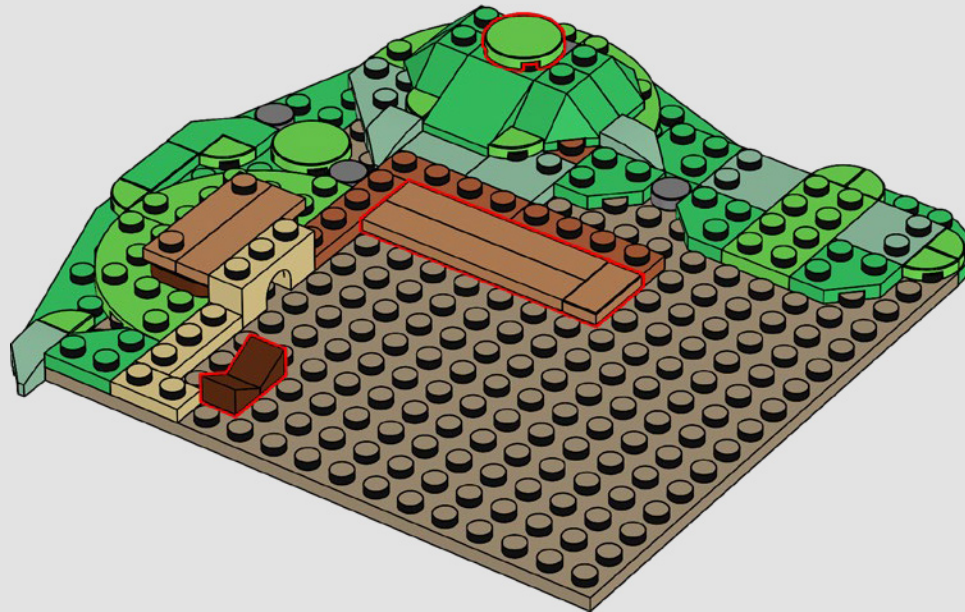

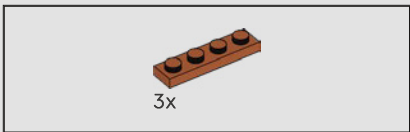

133

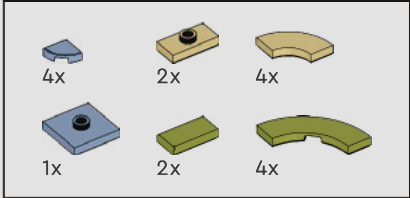

134

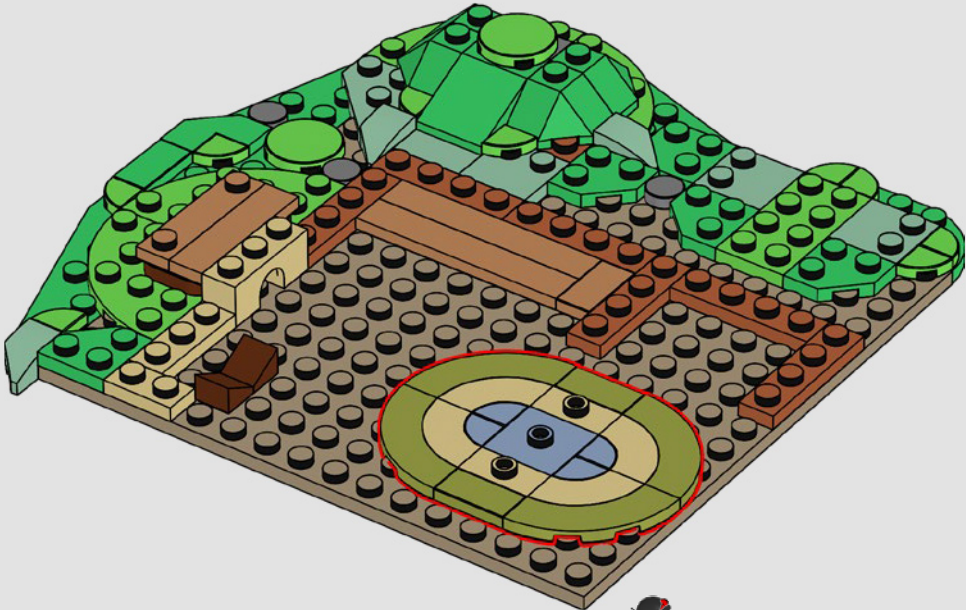



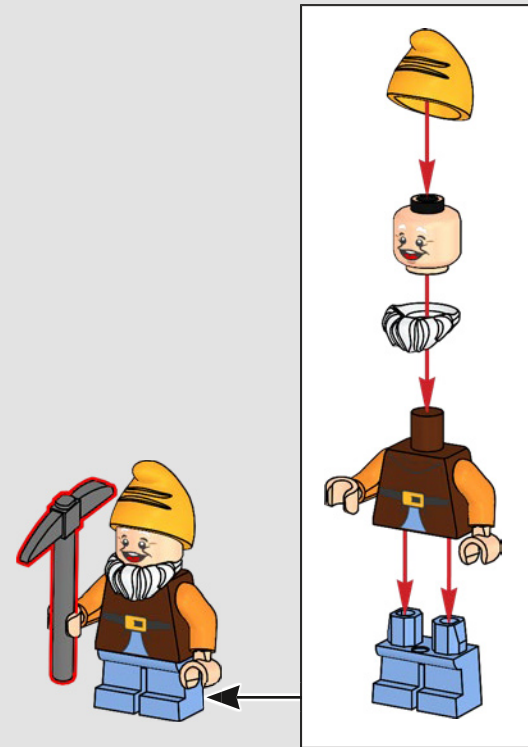

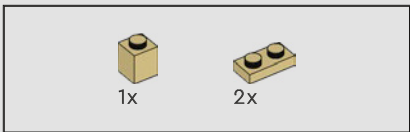

135

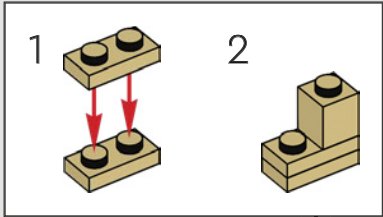

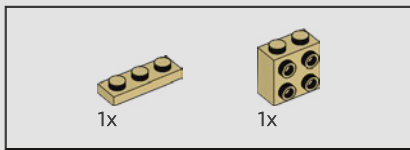

136

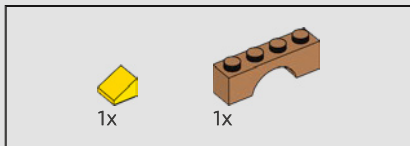

137

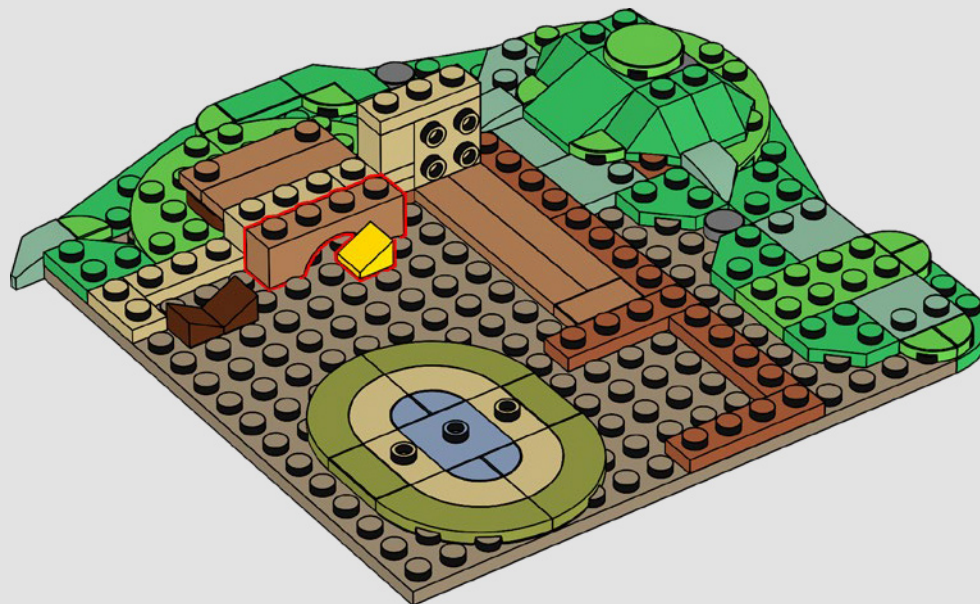

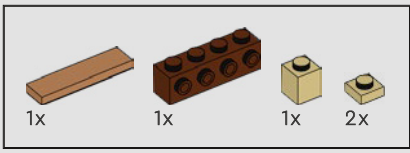

138

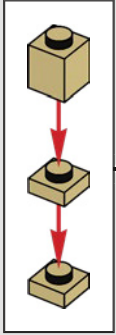
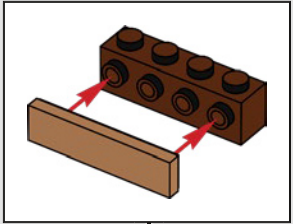



139

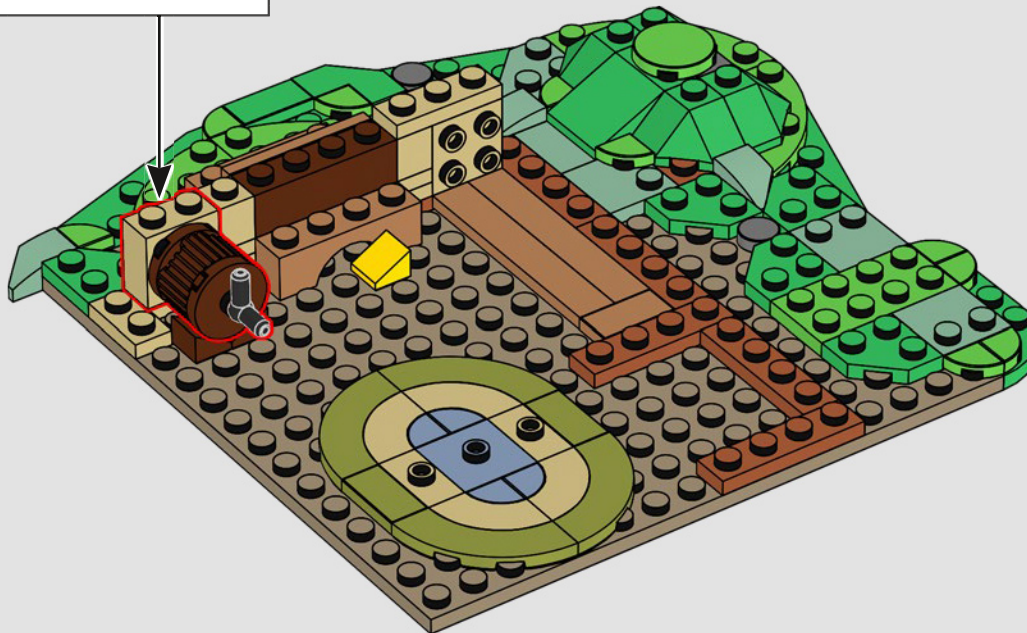
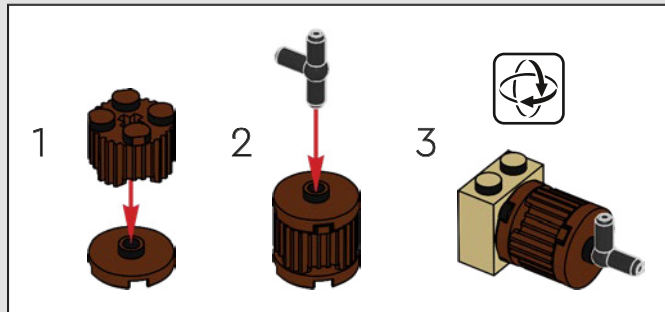

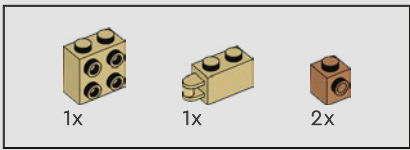

140

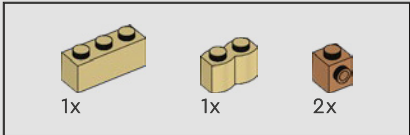
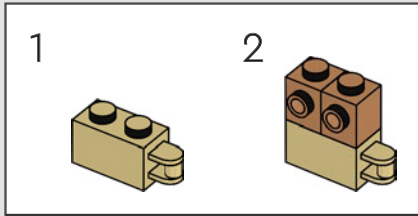
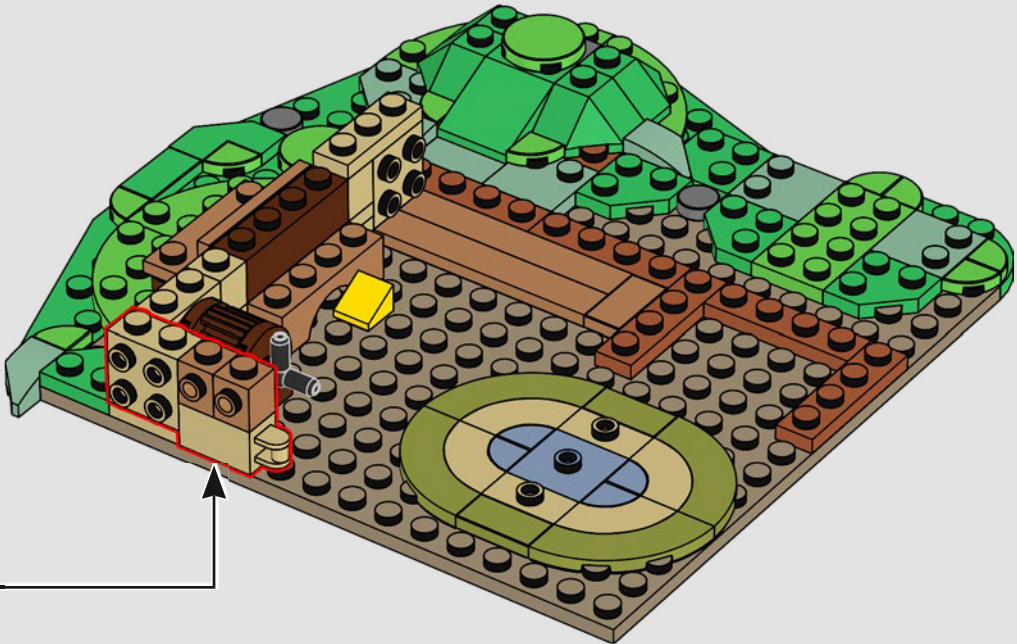

141



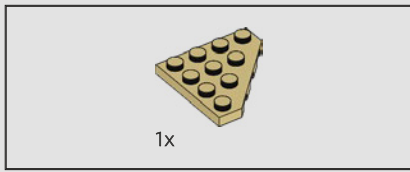

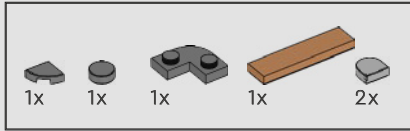

142



143



		
1x	1x	2x

144

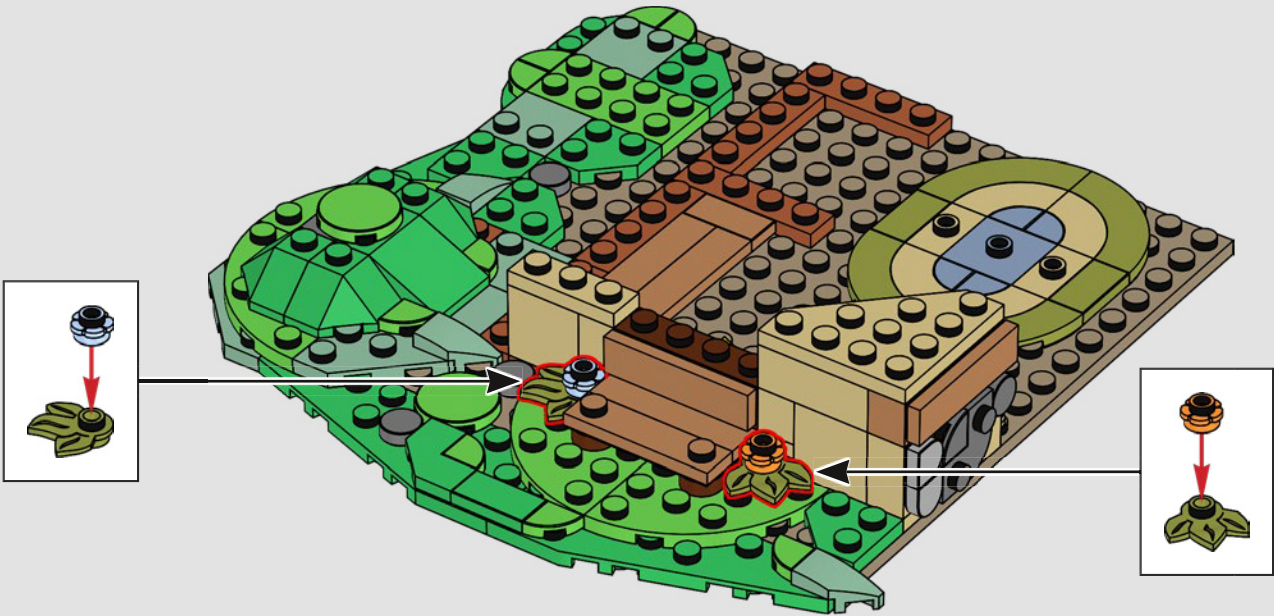



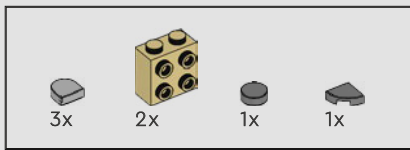

145

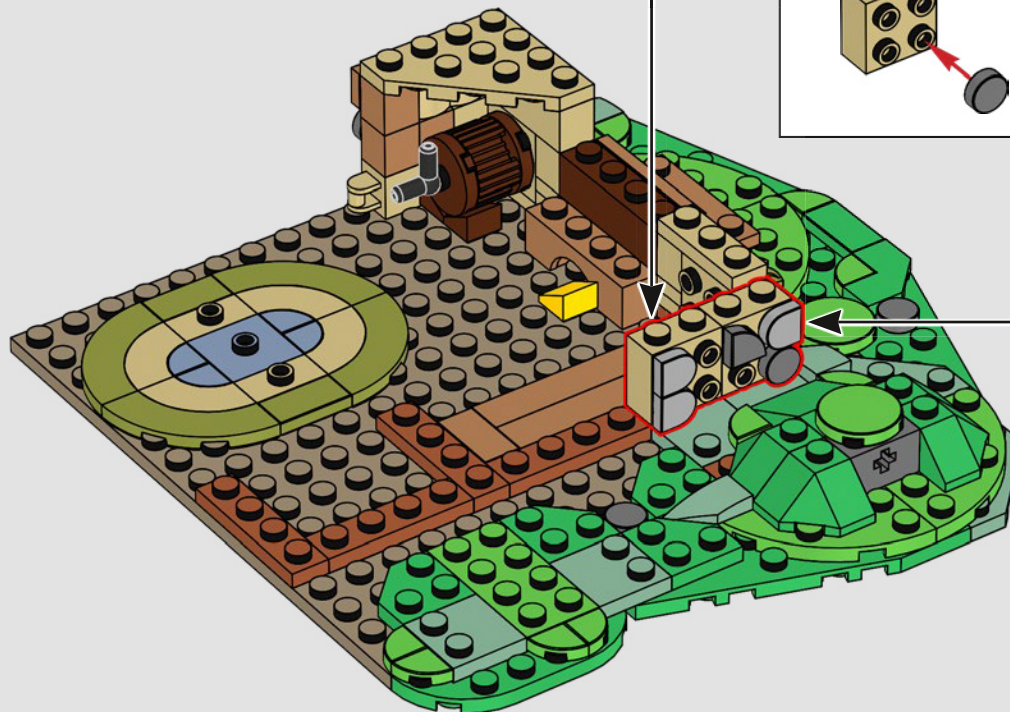
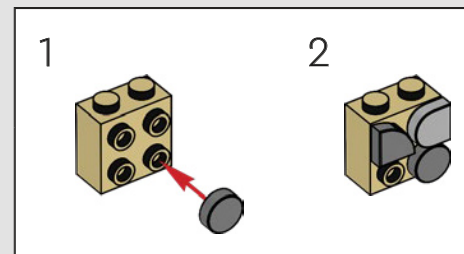
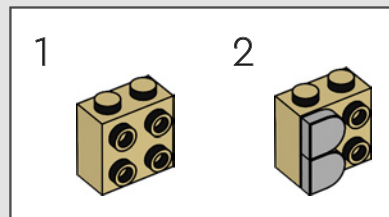

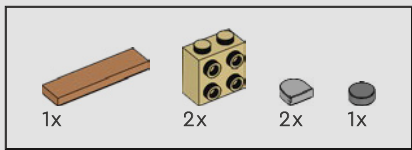

146

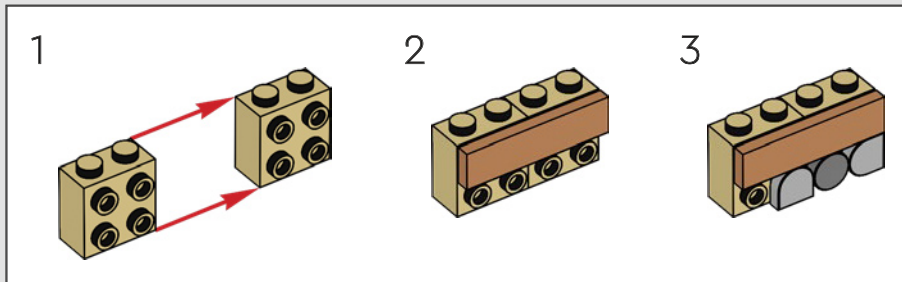

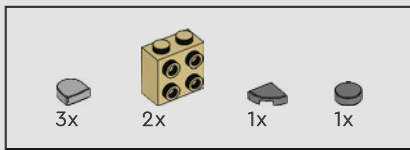

147

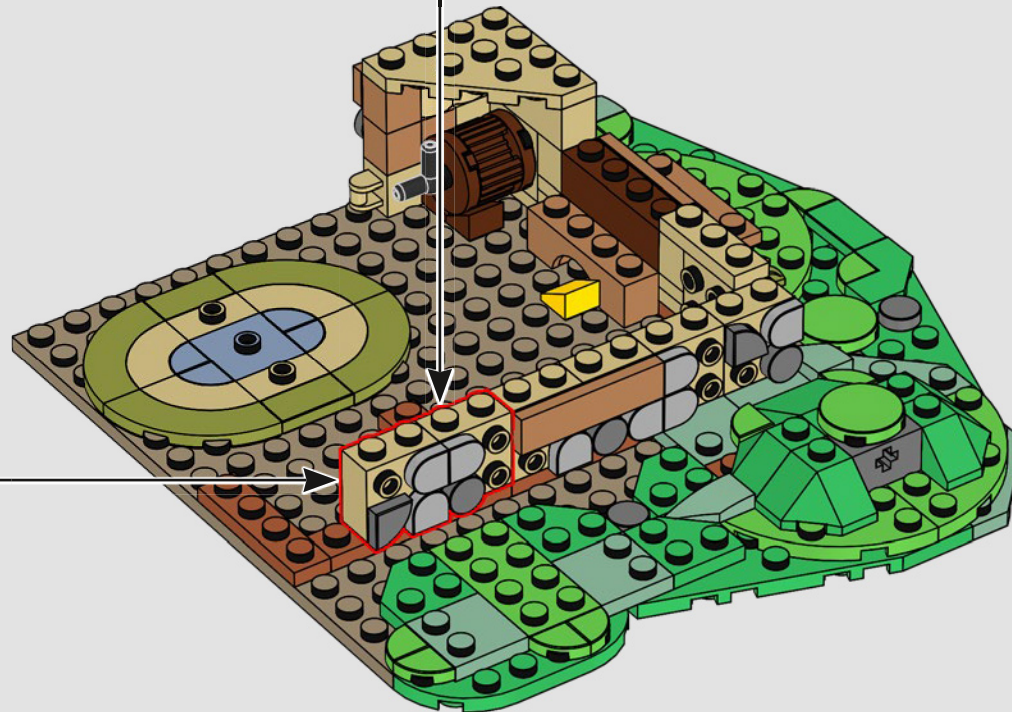
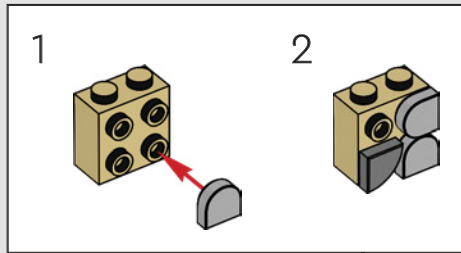
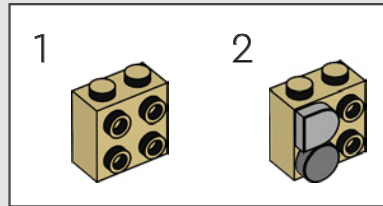

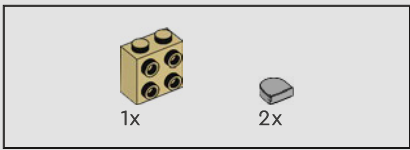

148

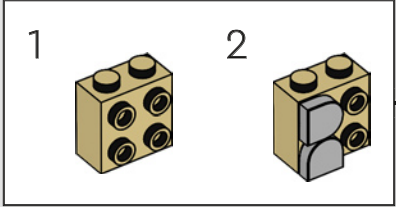
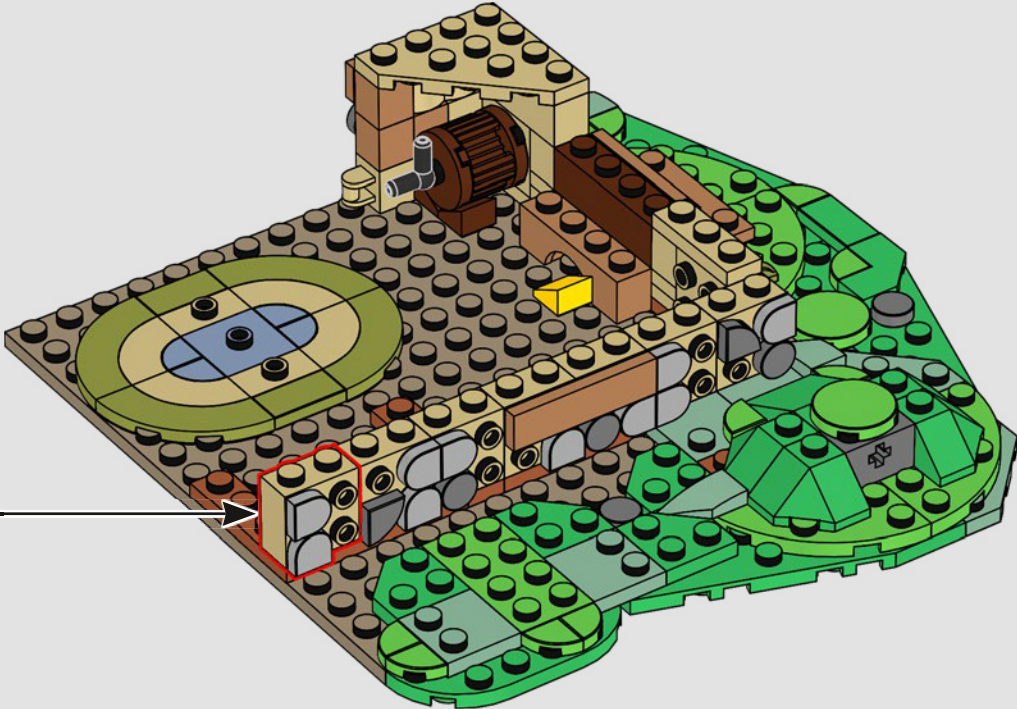

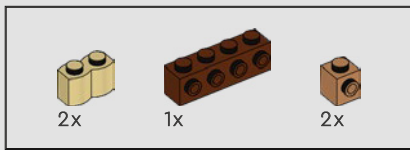

149

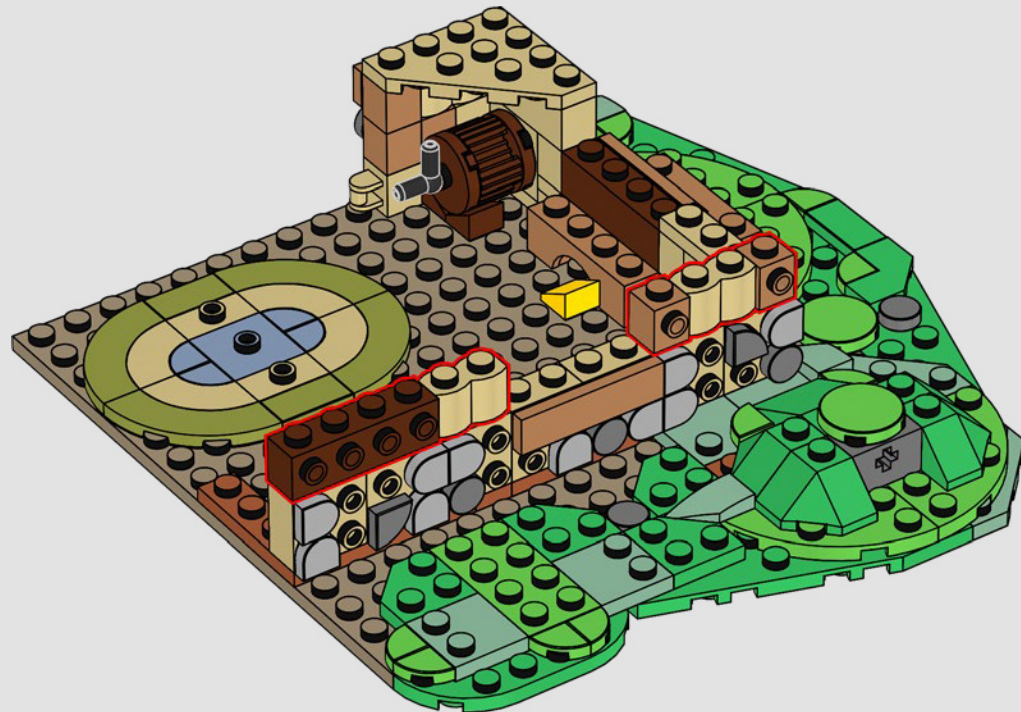

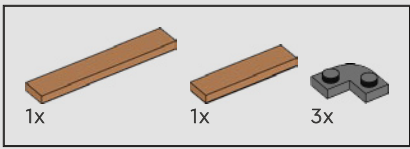

150

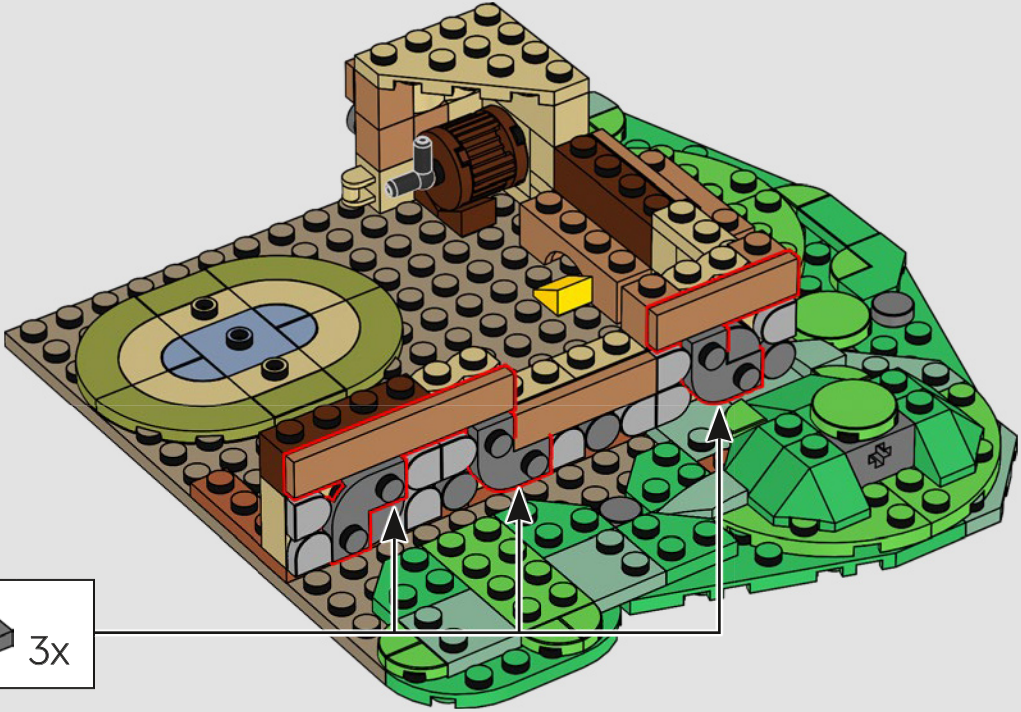

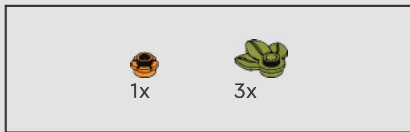

151



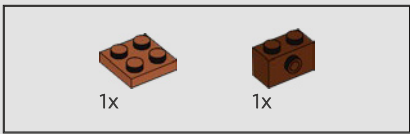

152

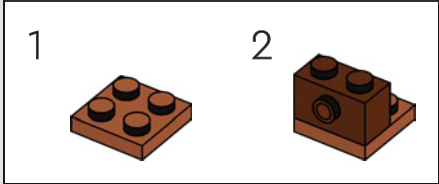



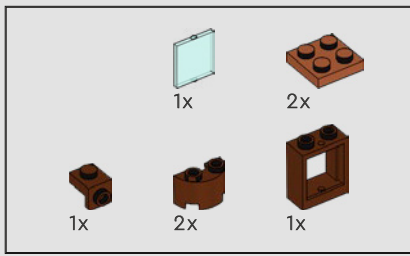

153

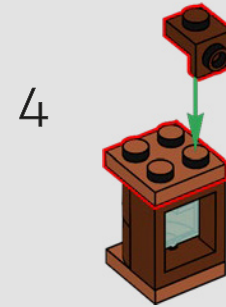
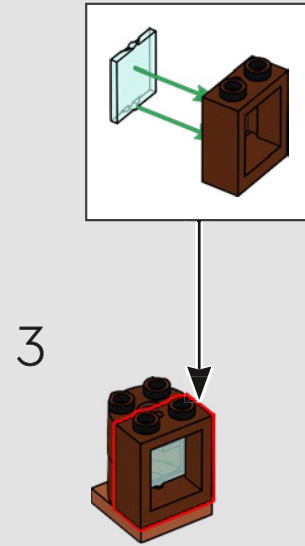
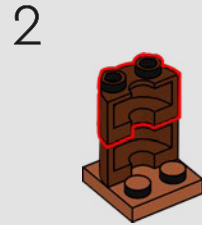
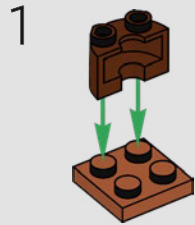



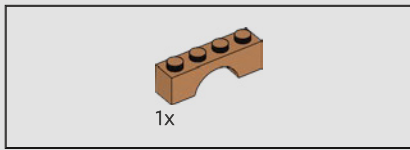

154



155





2x

156



2x



1x



1x



1x

157





158

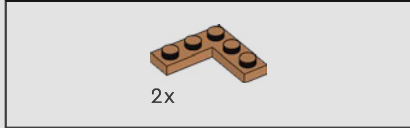

159



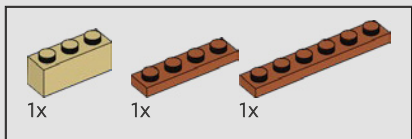

160

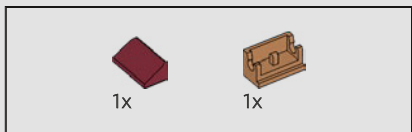

161



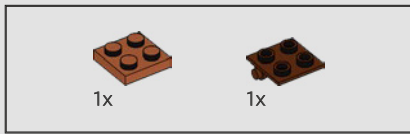

162

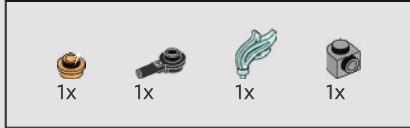

163

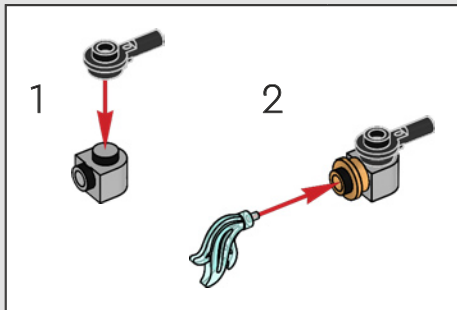

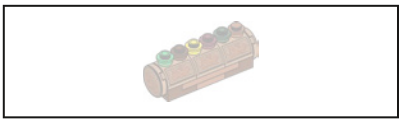

164

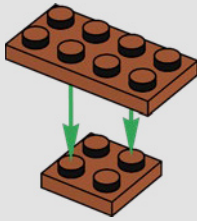

165

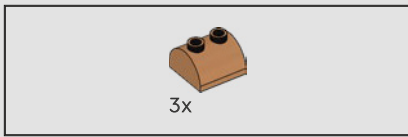
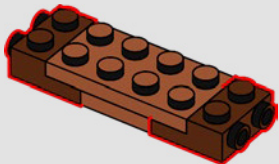

166

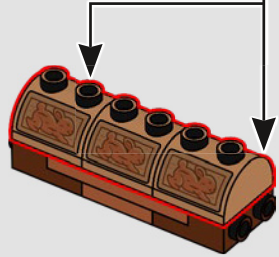
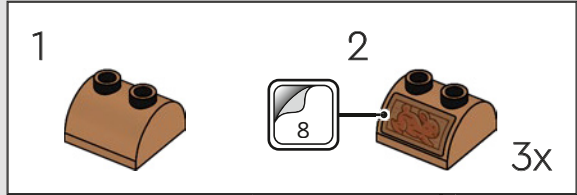

167

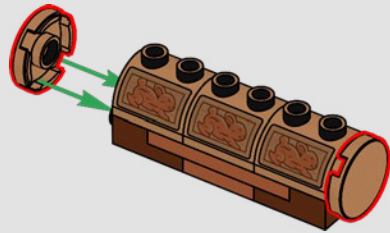





168

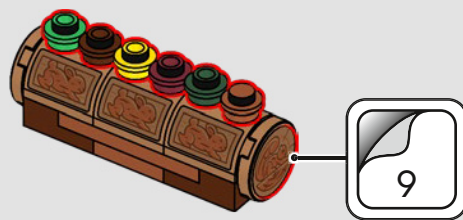

169

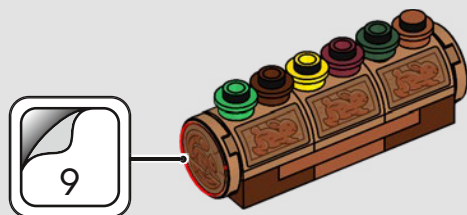

170



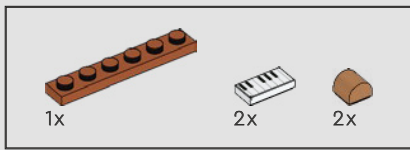

171

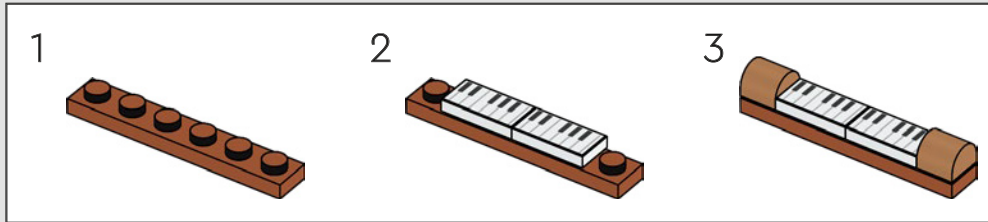



172

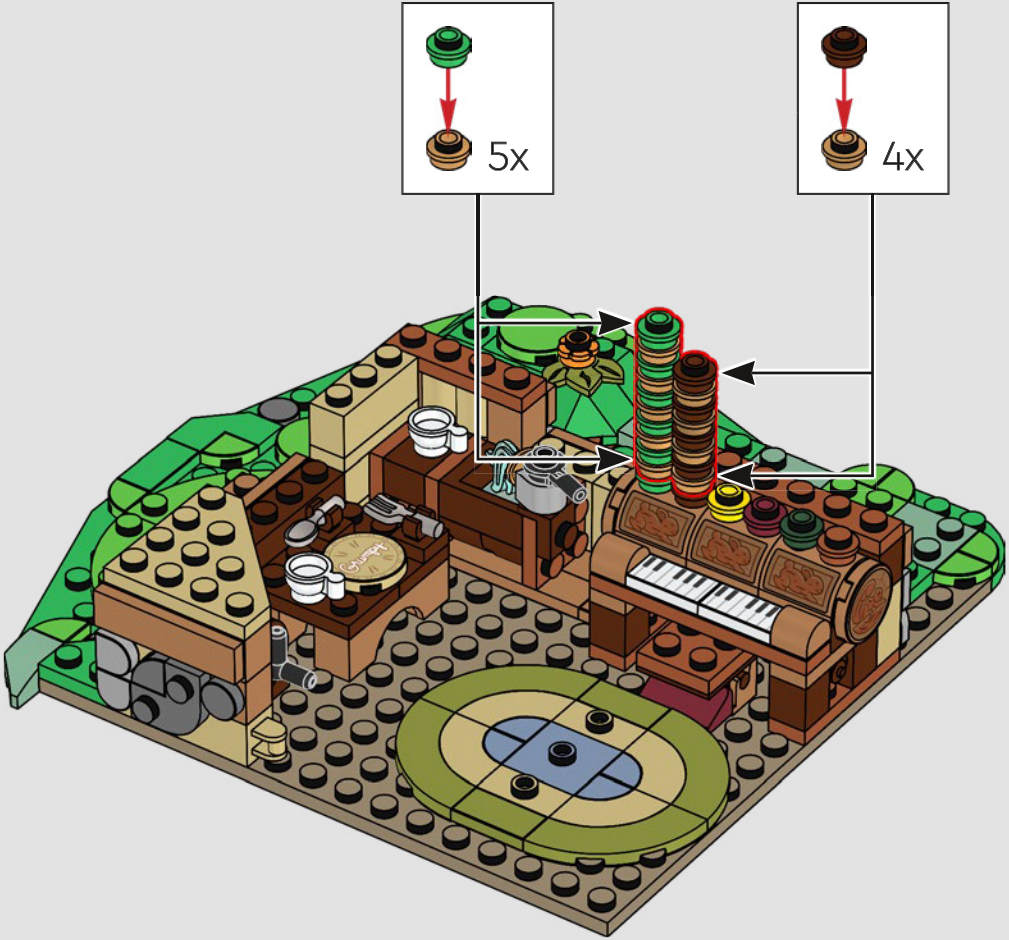

- 3x
- 2x
- 5x

173

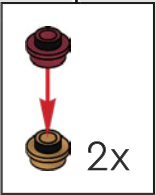
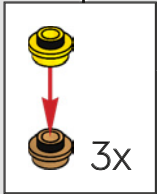

- 2x
- 1x

174

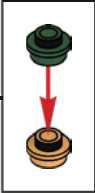

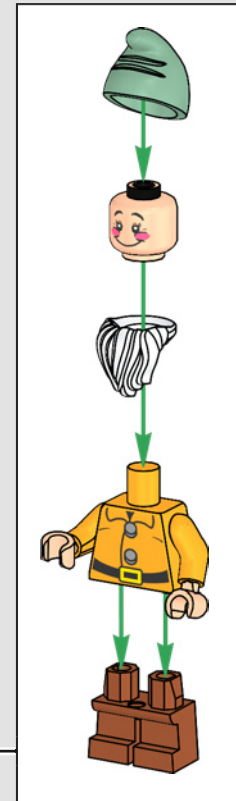

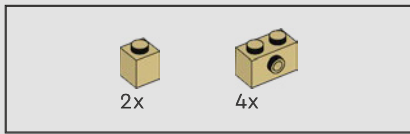

175

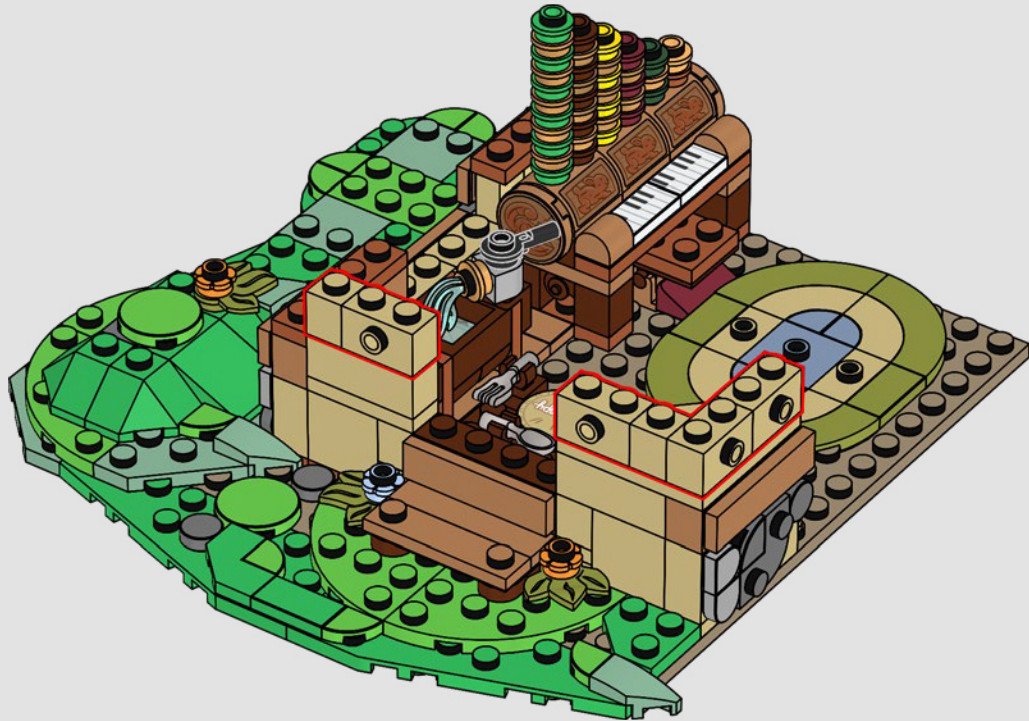

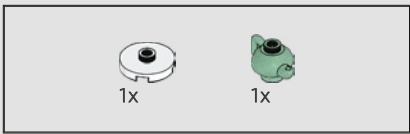

176

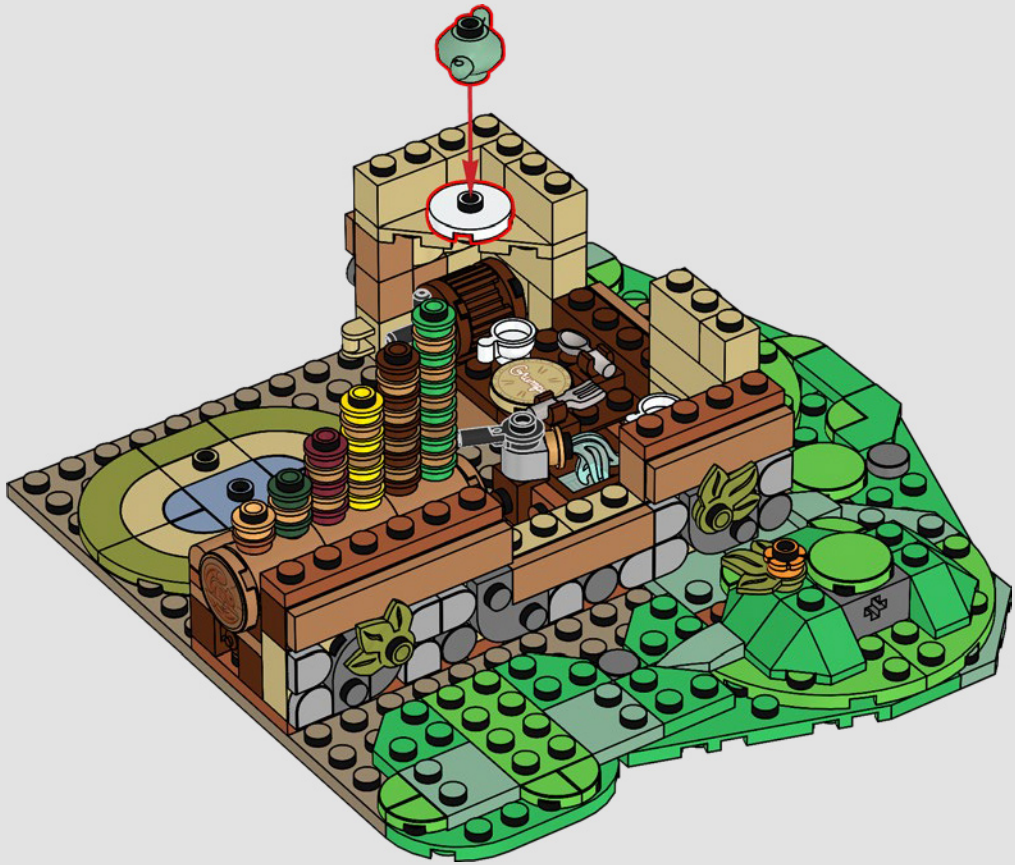





5x

177

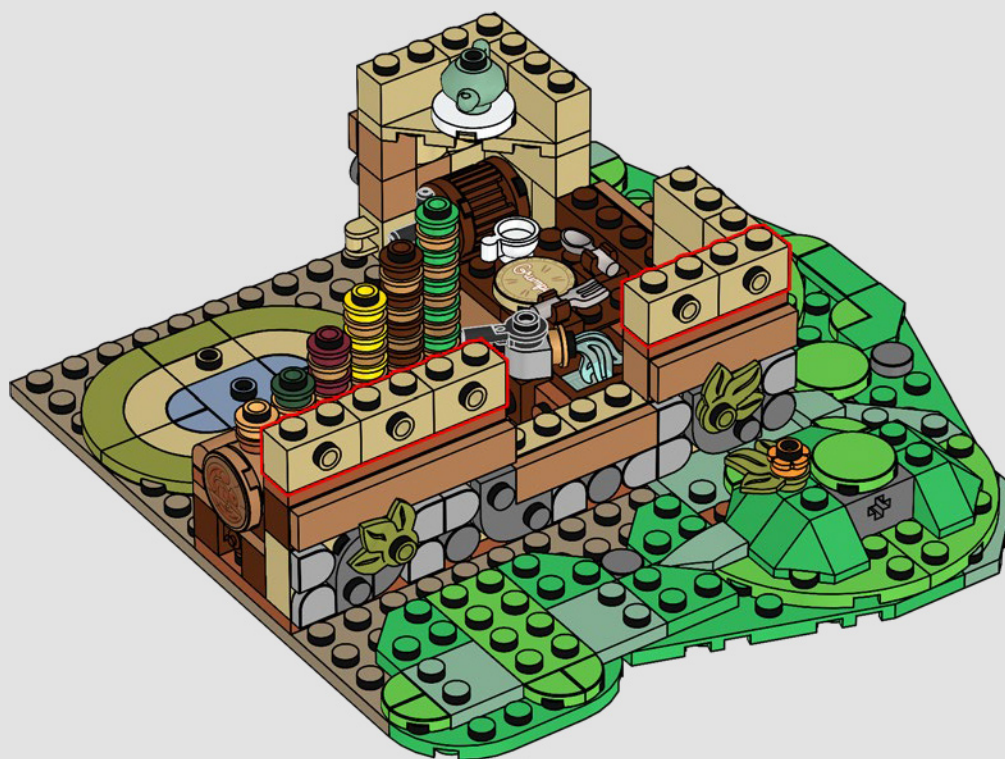

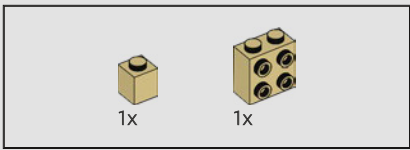

178



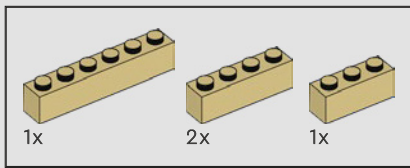

179

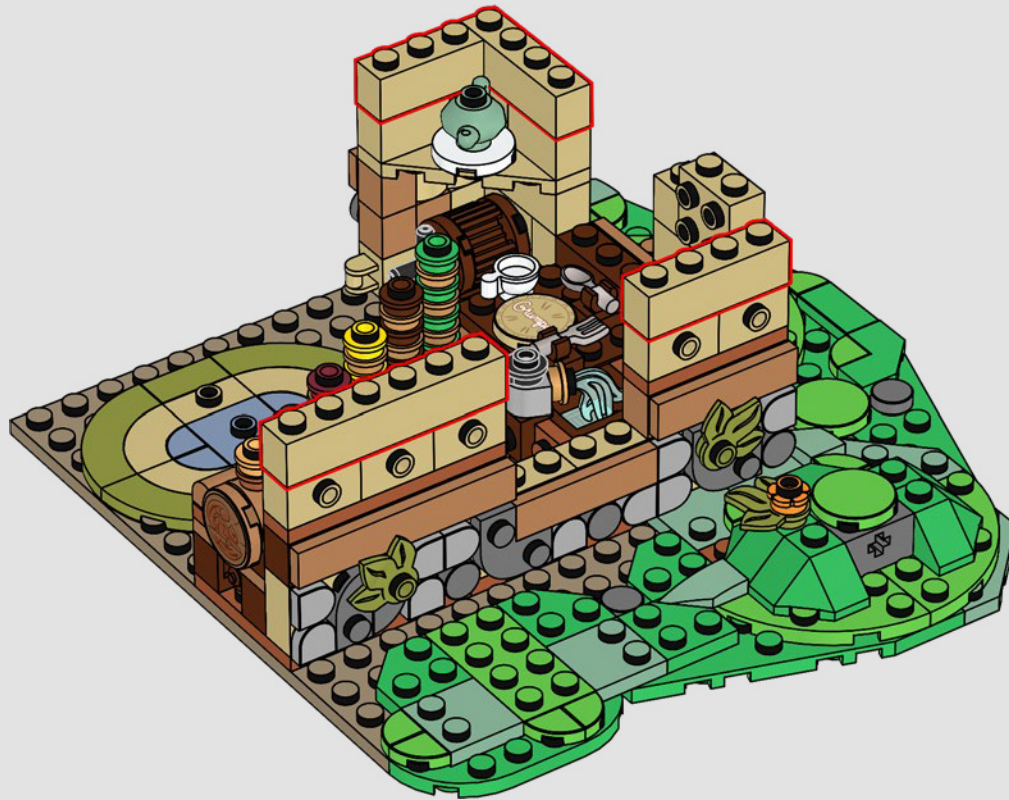

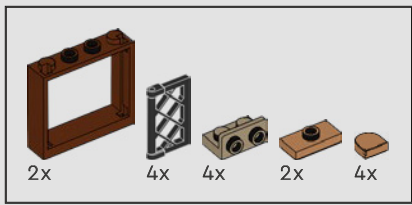

180

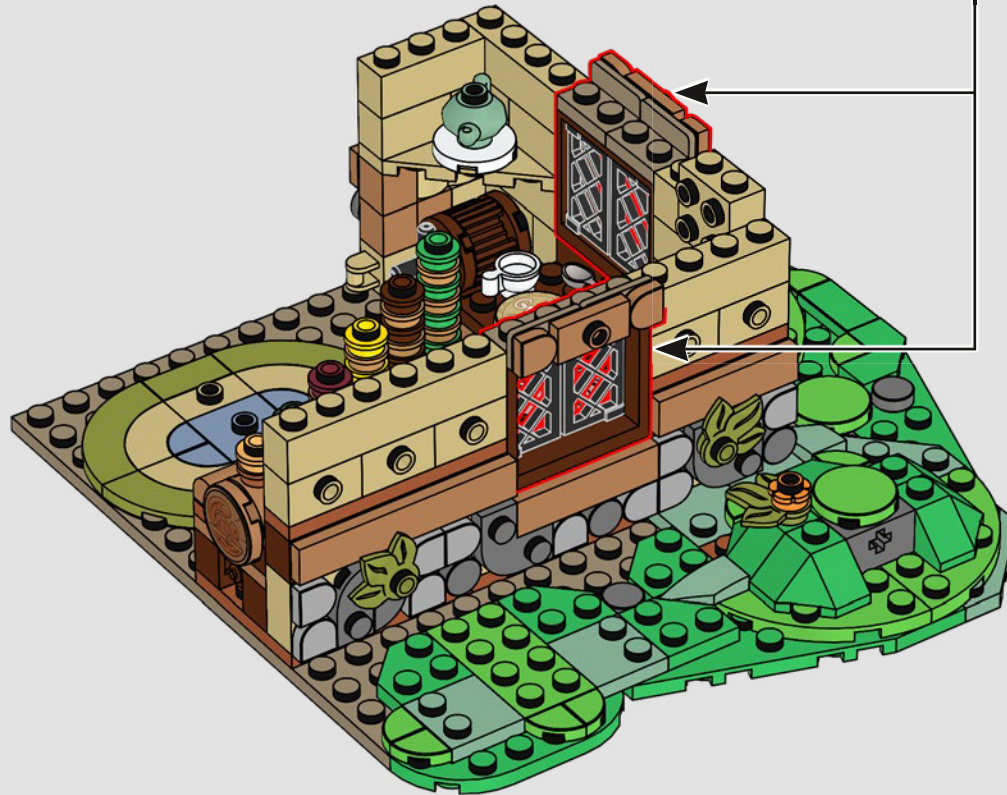
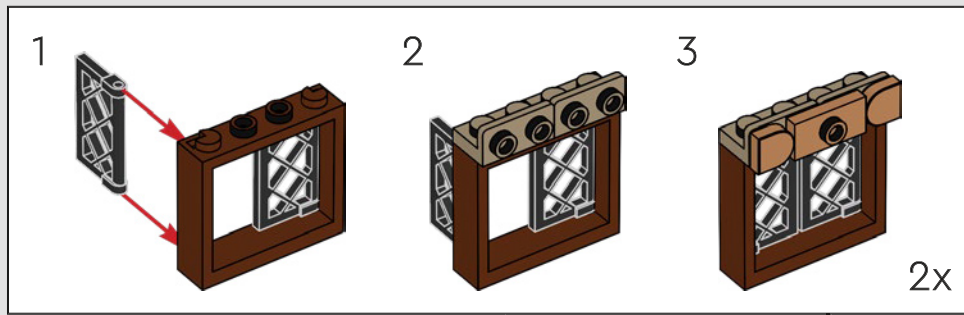



181



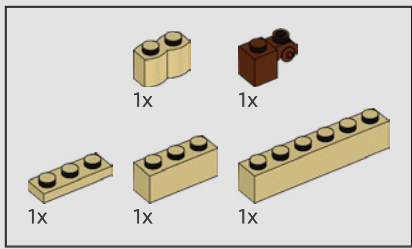

182

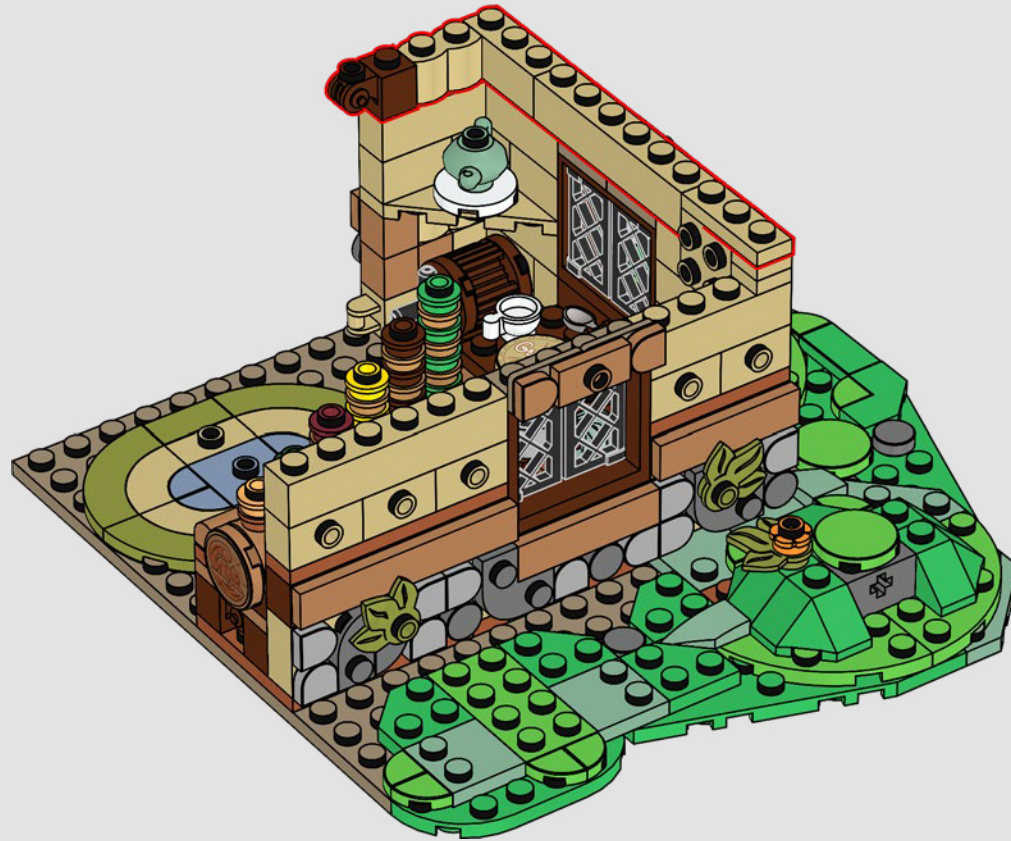

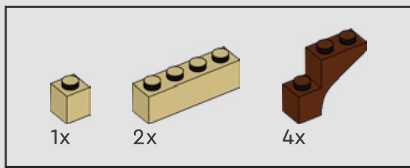

183

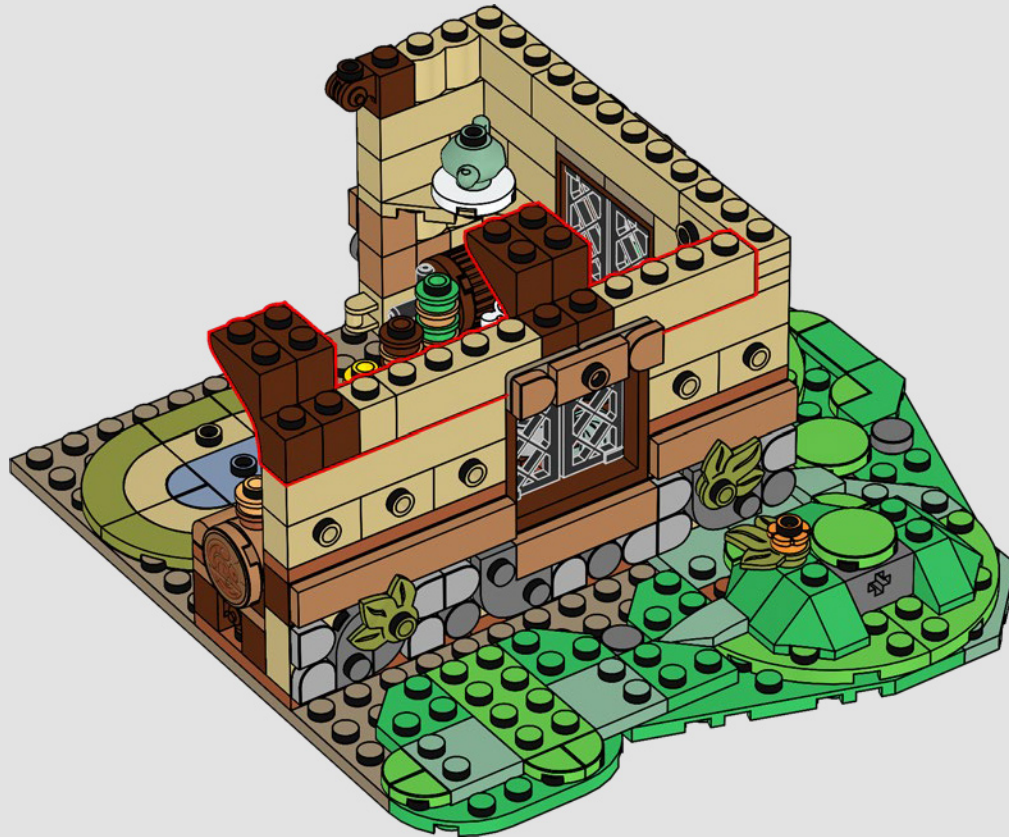



184





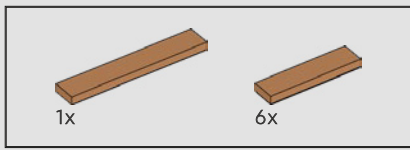

185





186

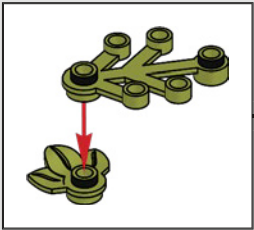

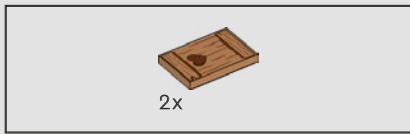

187

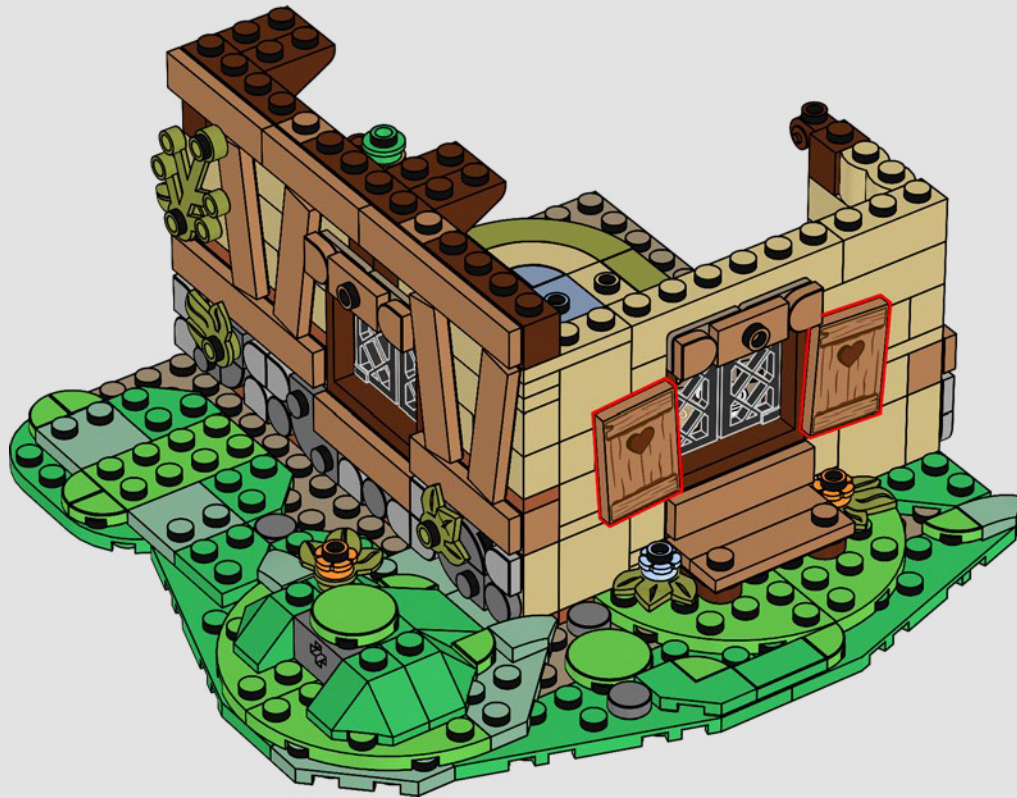

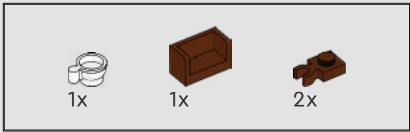

188

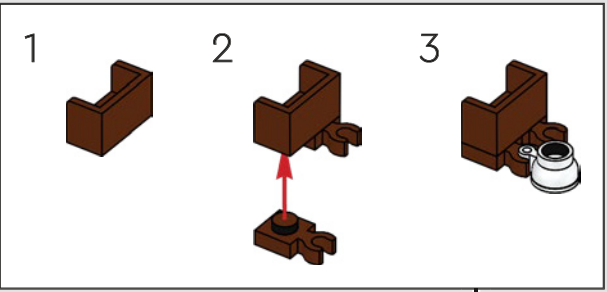

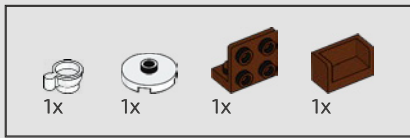

189

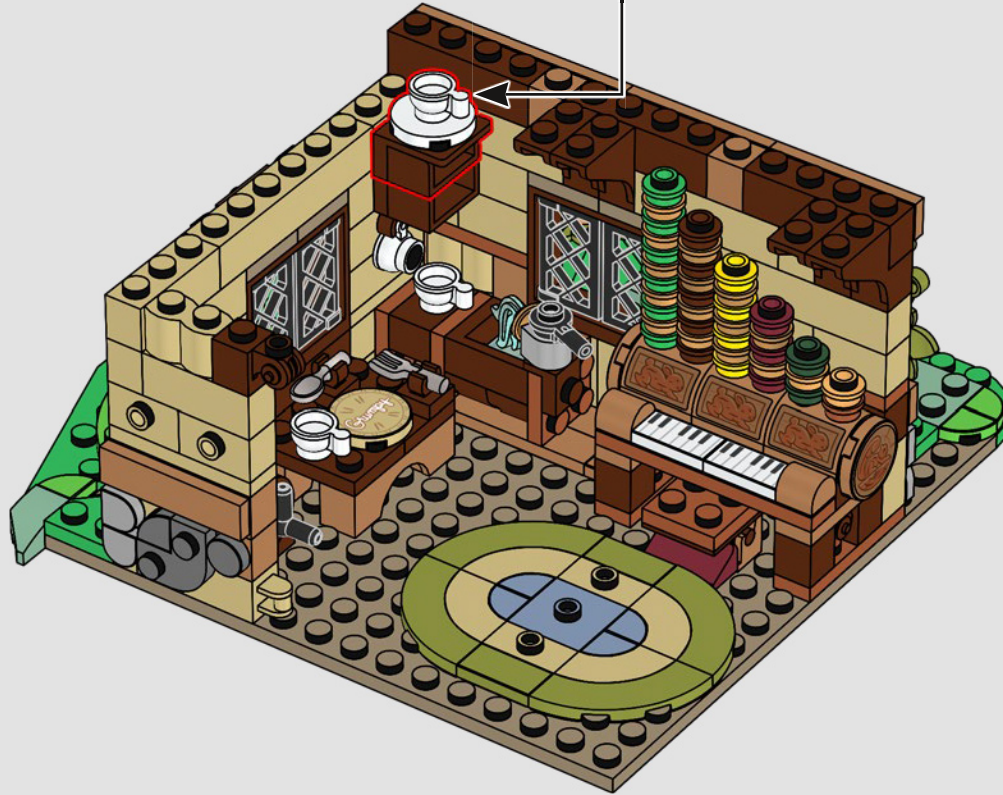
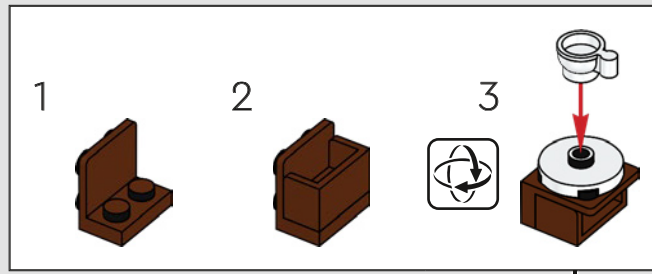

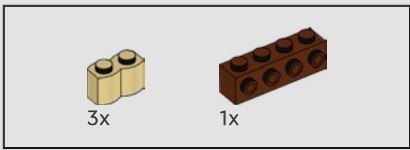

190

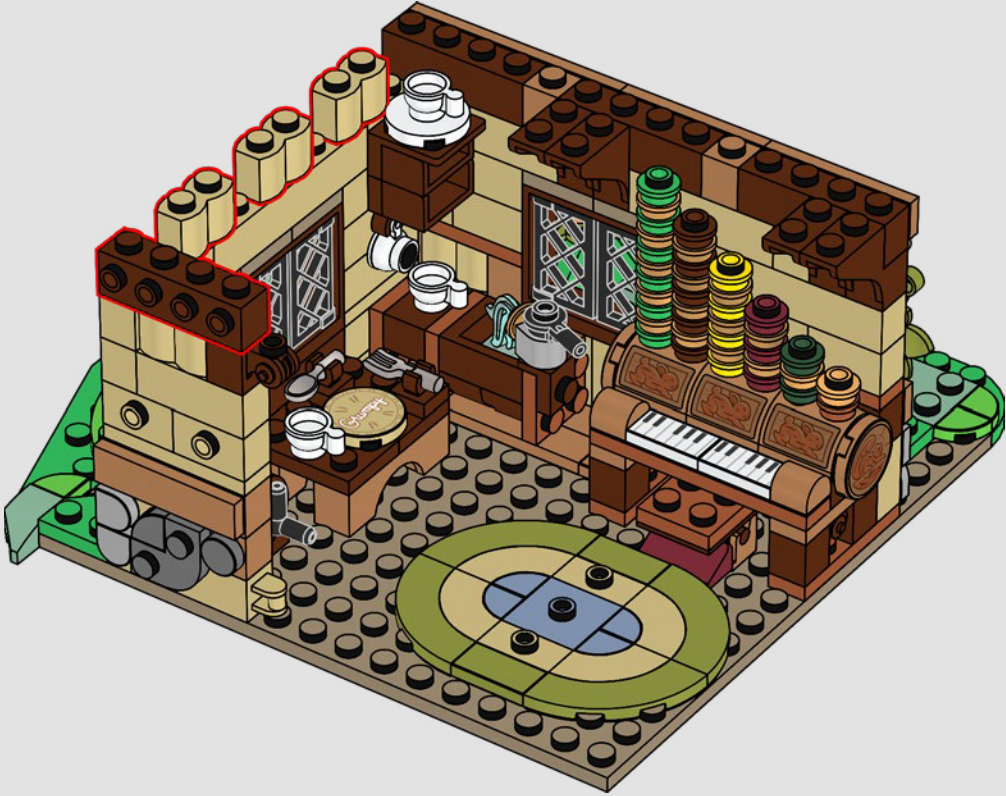

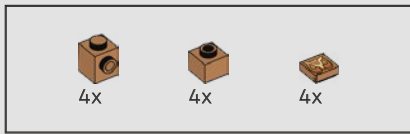

191

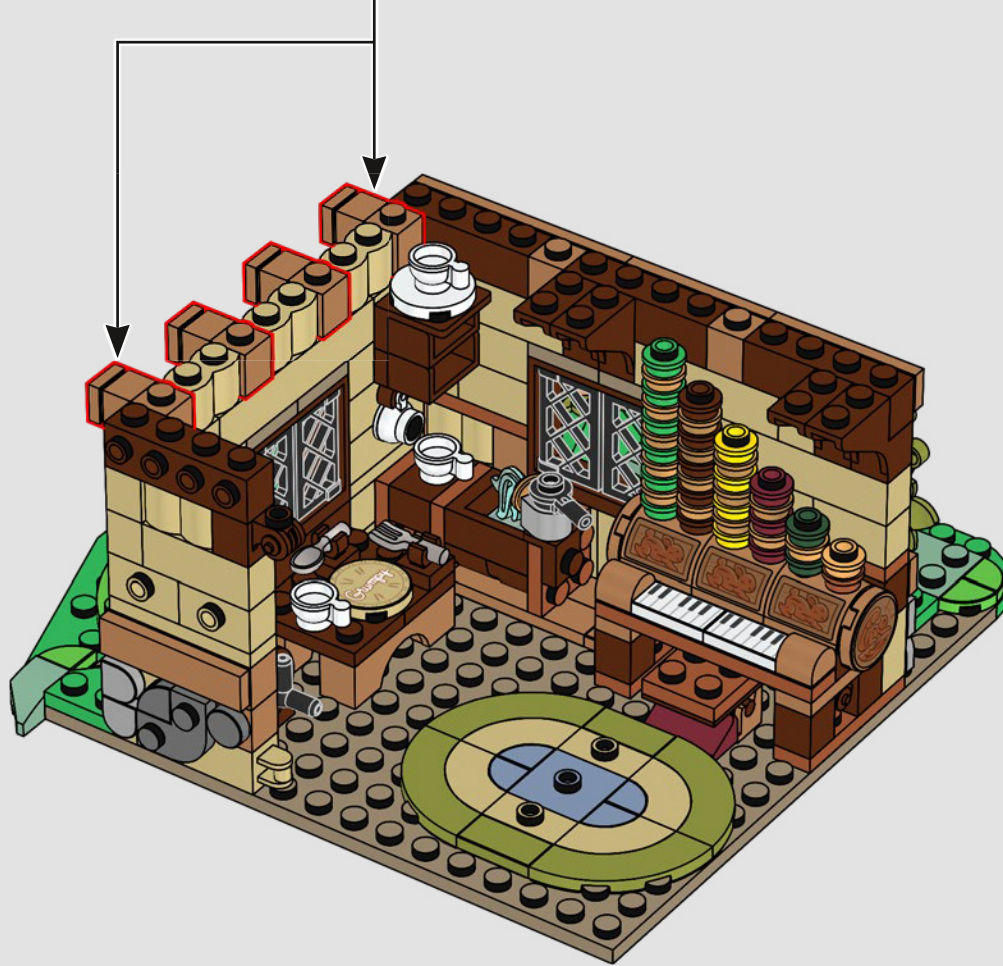
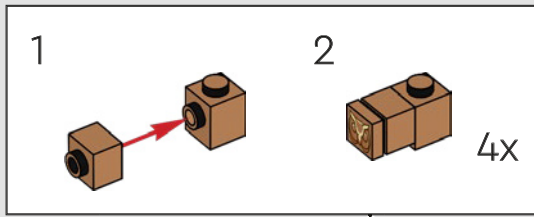

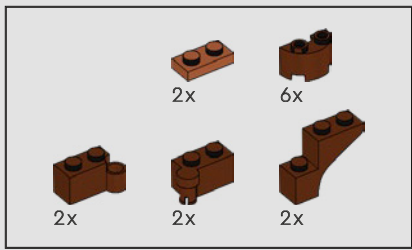

192

1

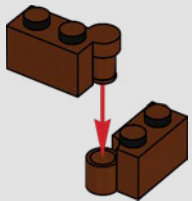

2

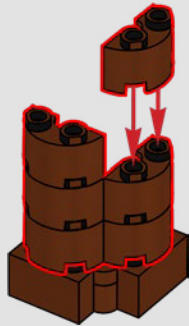

3

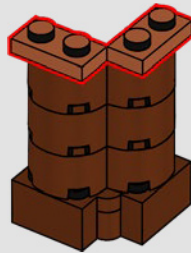

4

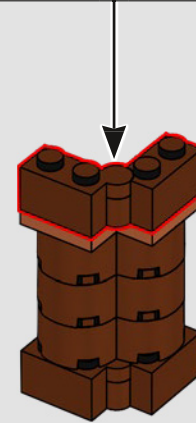
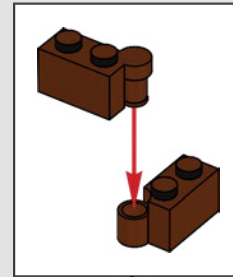

5

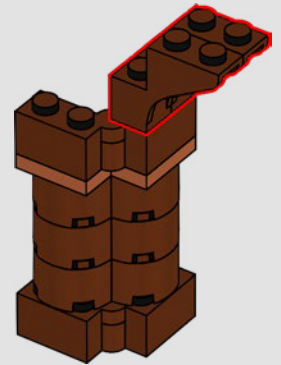





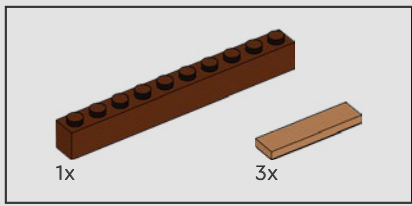

193



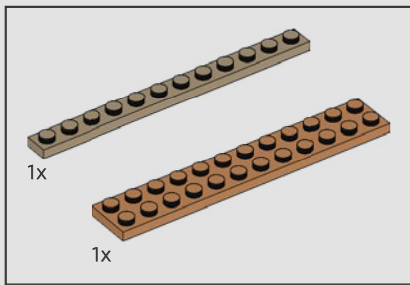

194



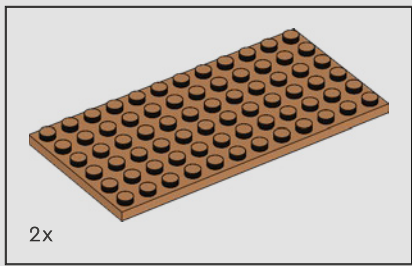

195



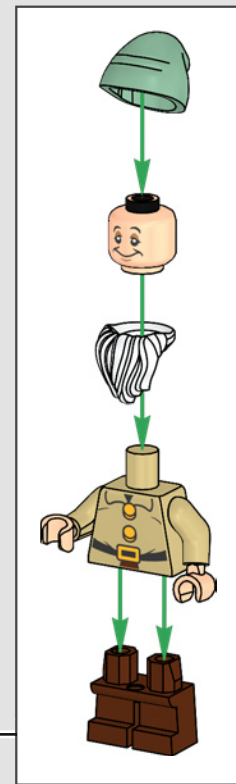

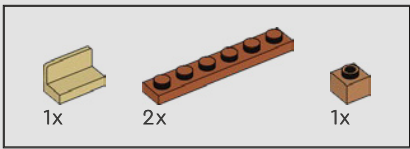

196

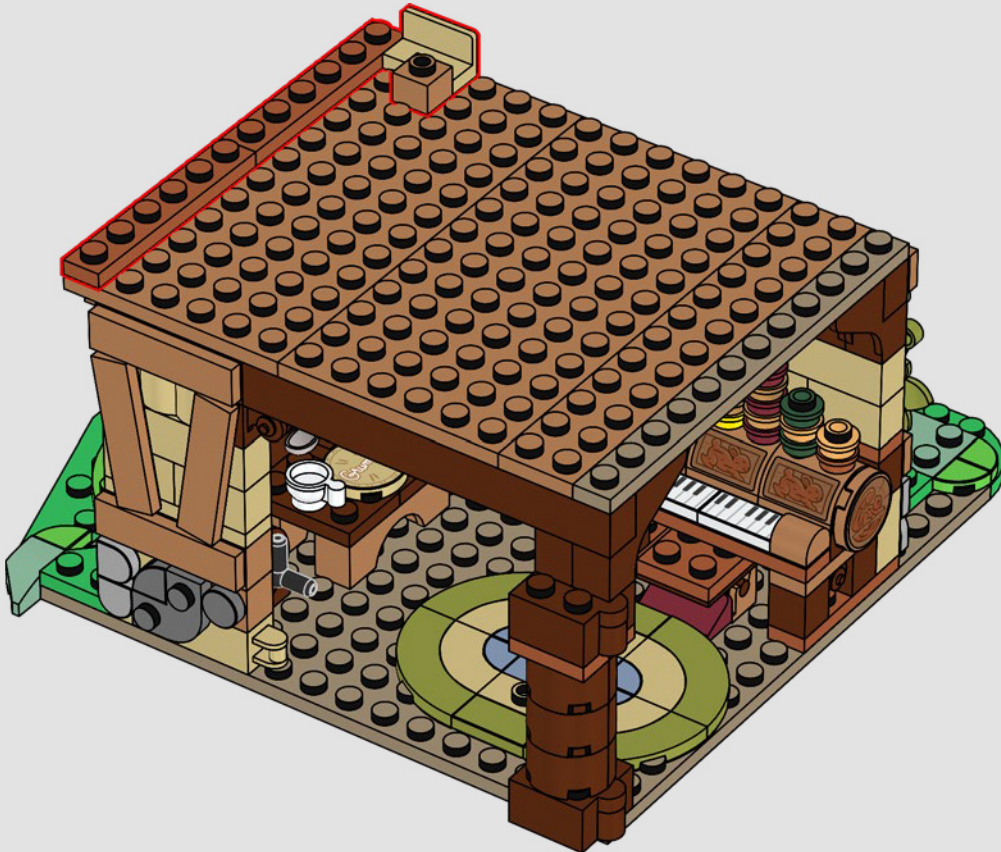

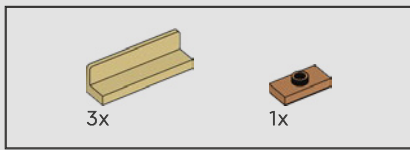

197

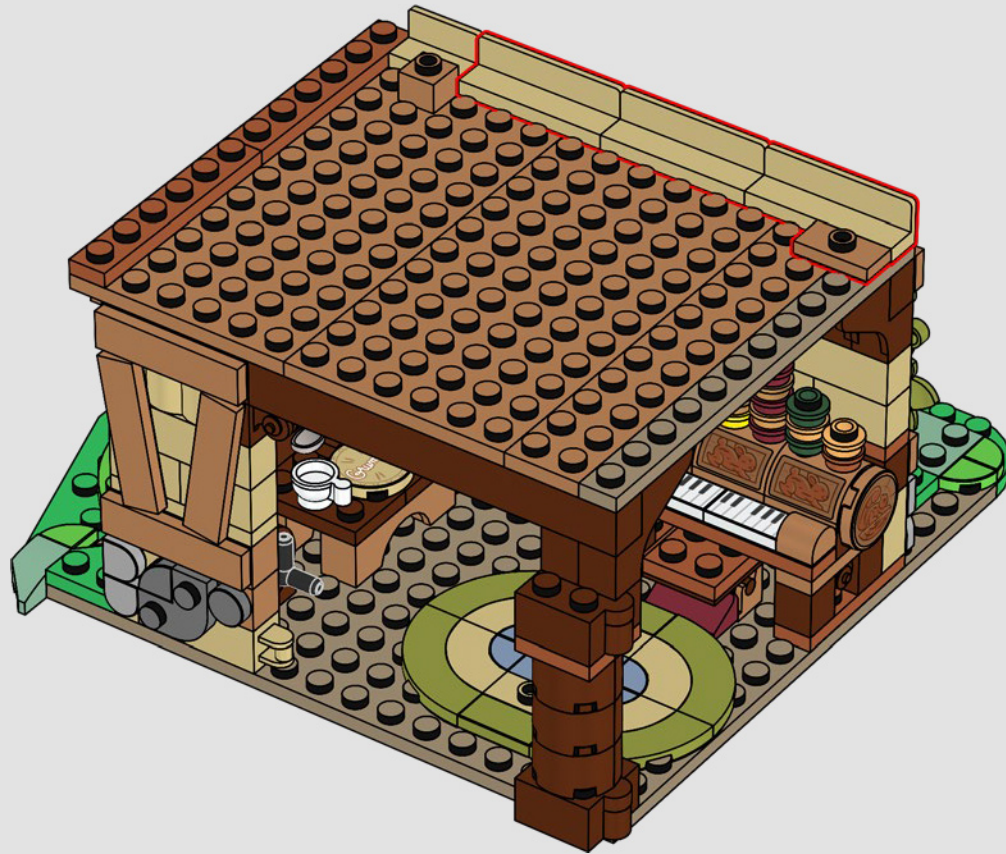

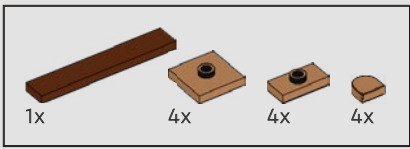

198

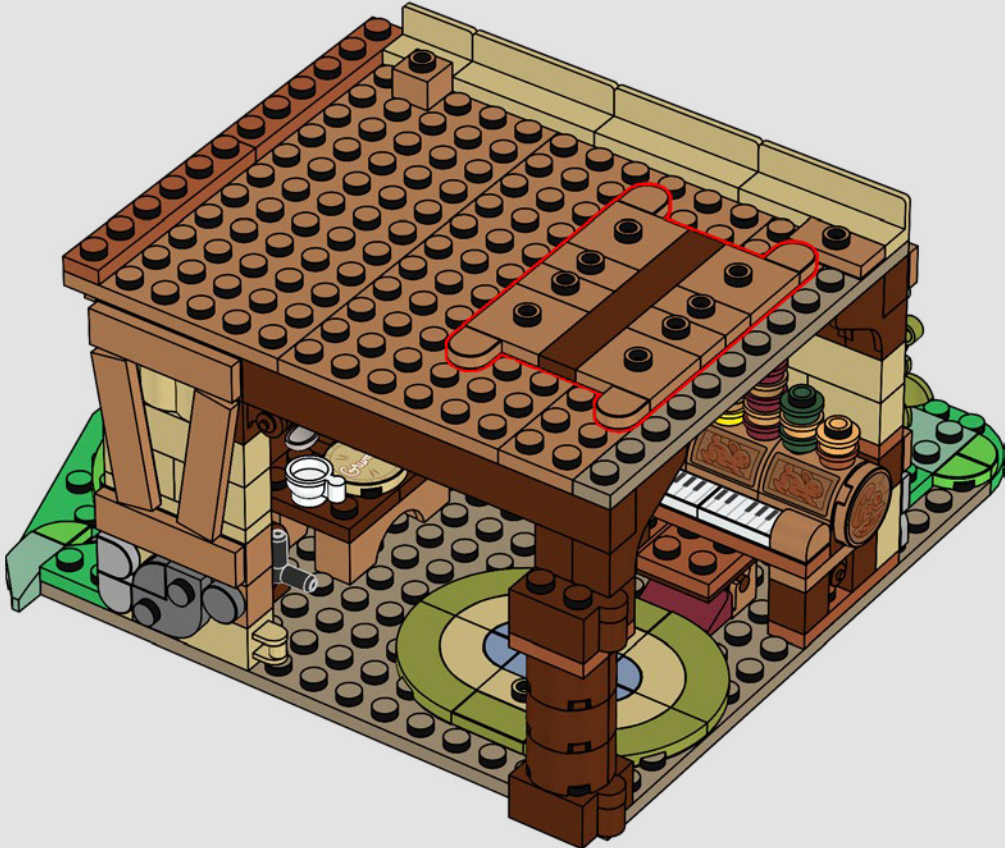



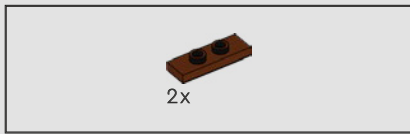

199



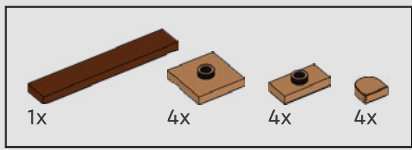

200

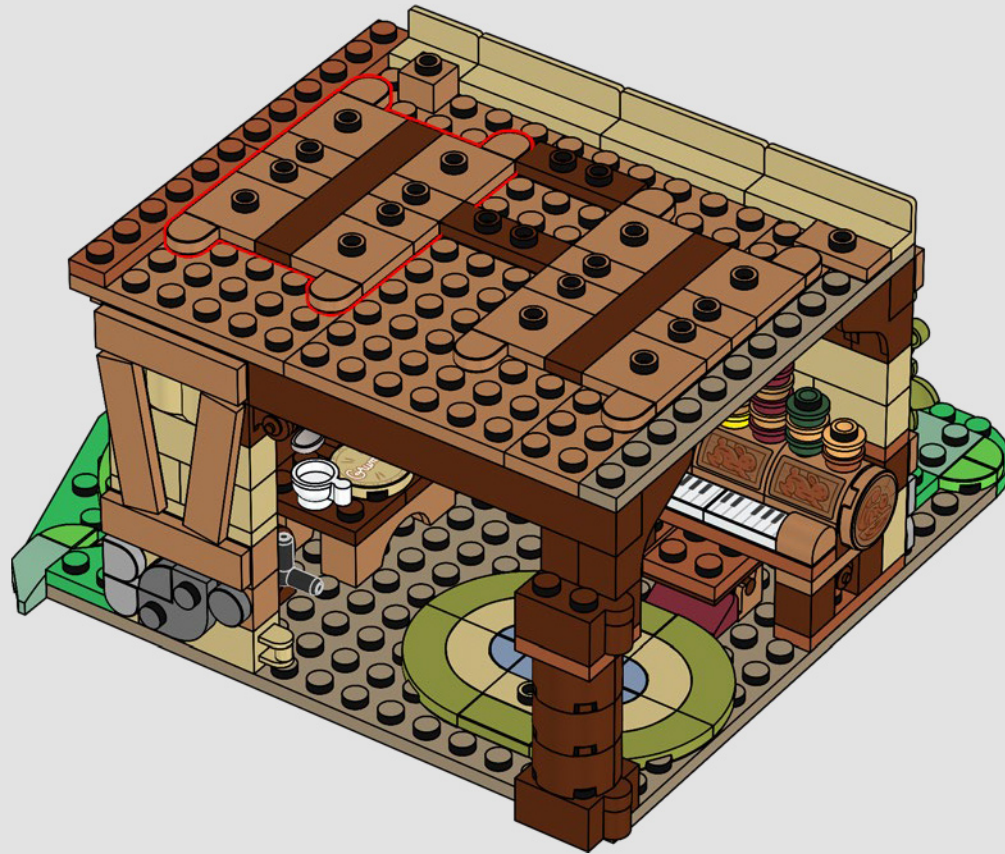

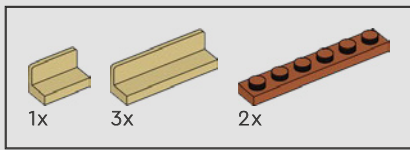

201

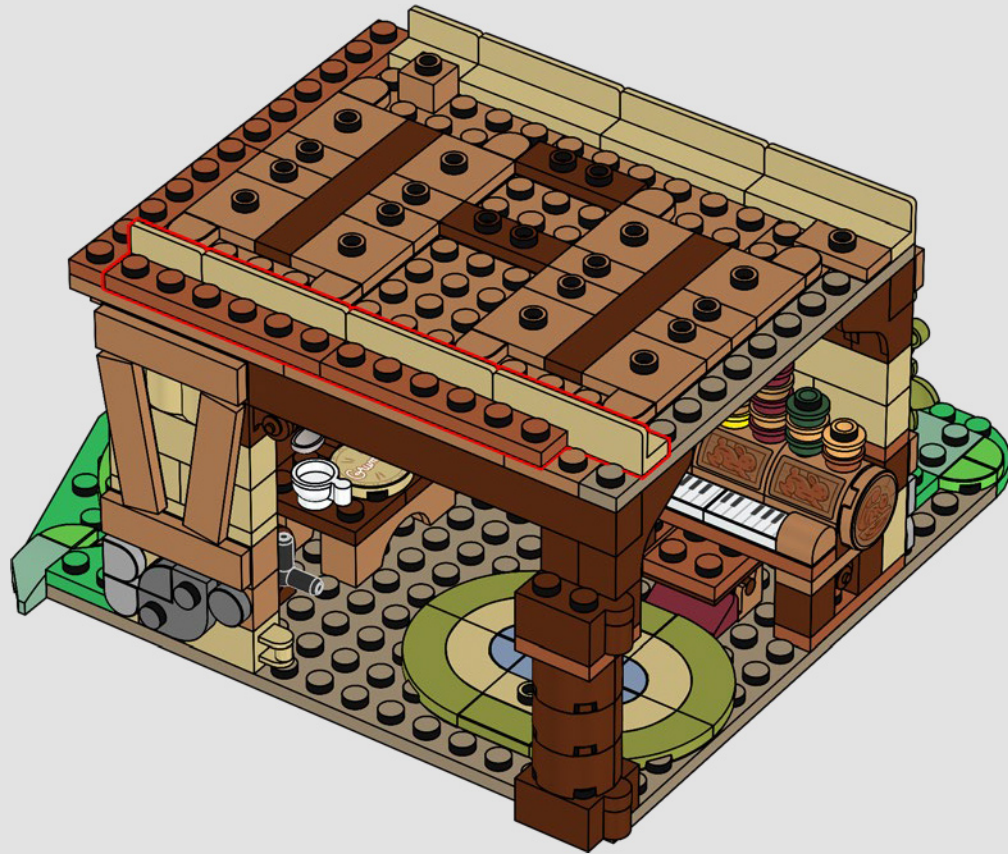

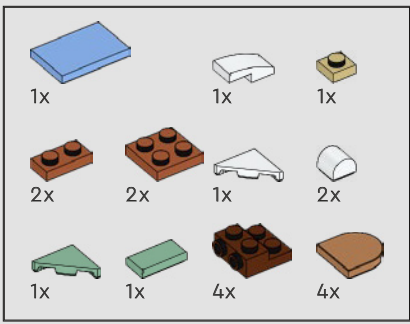

# 202

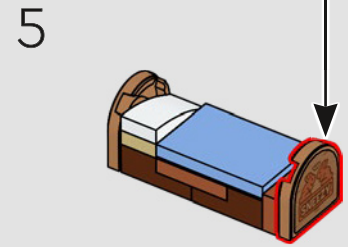
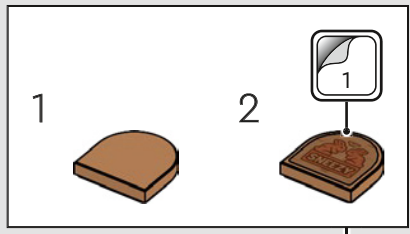
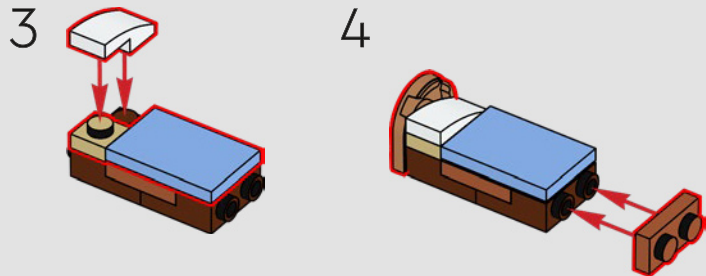
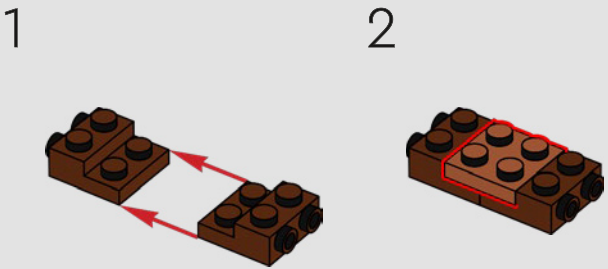
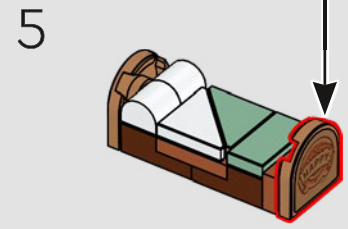
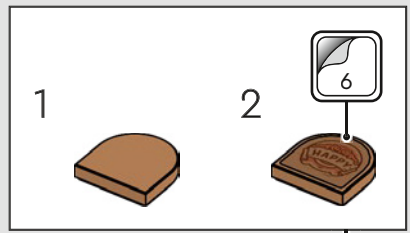
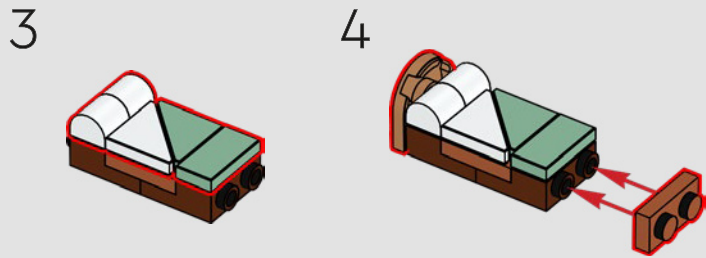
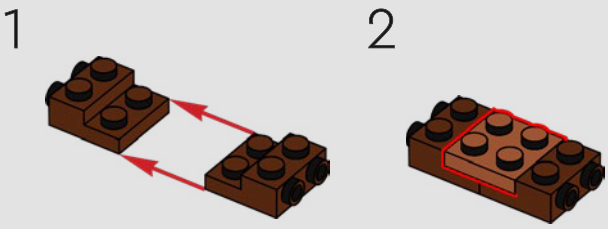

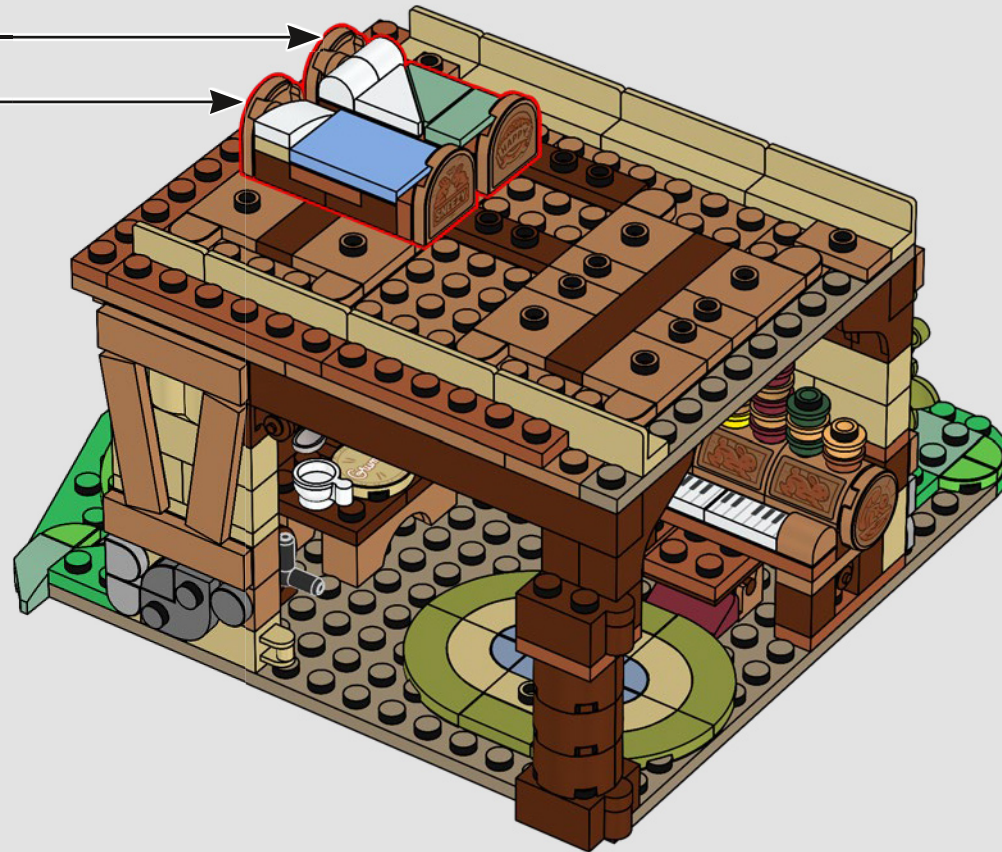

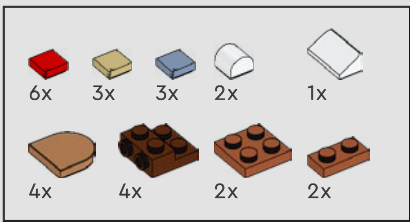

# 203

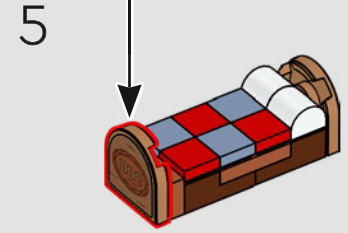
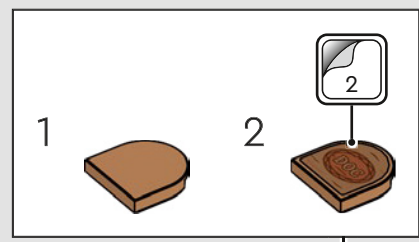
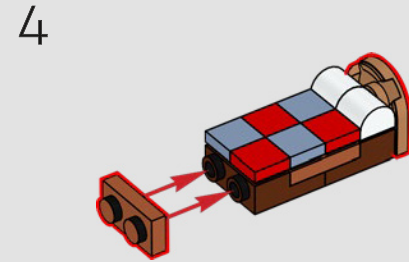
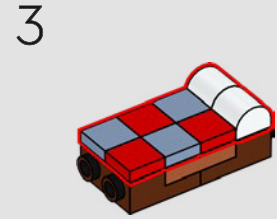
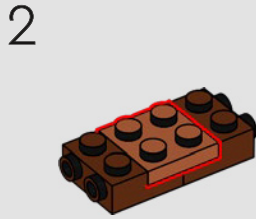
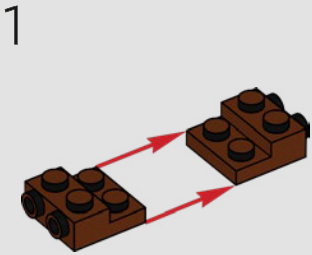
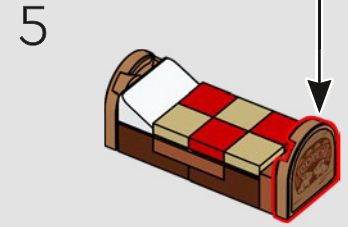
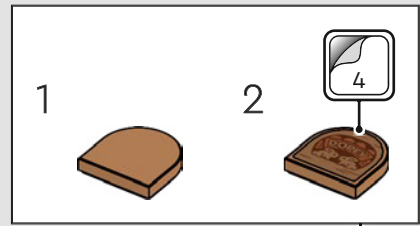
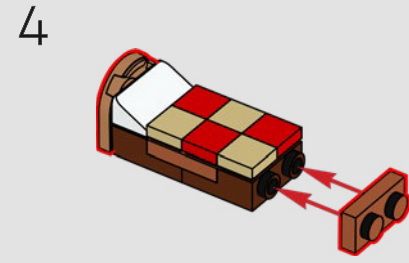
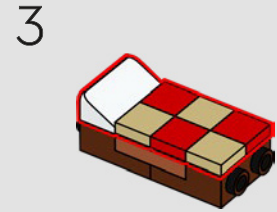
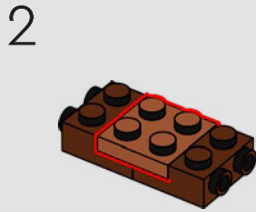
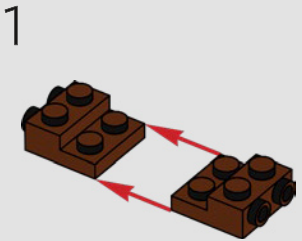

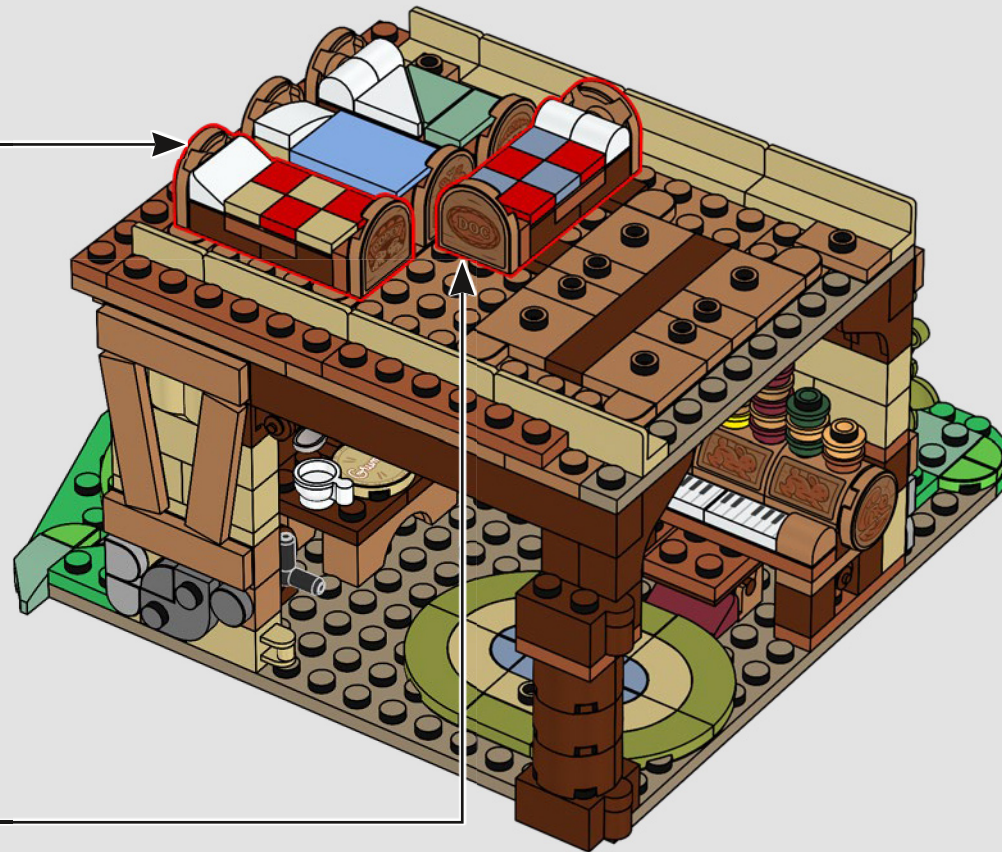

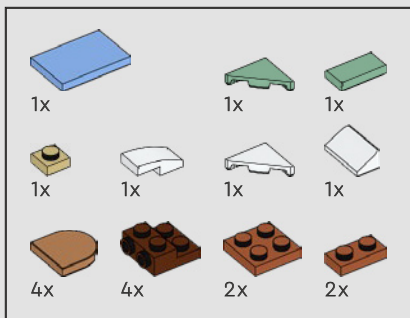

204

1

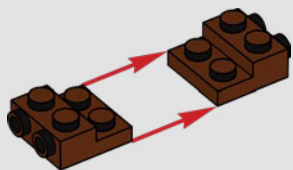

2



3

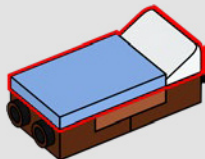

4

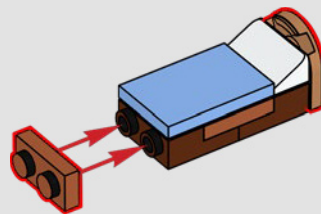

5

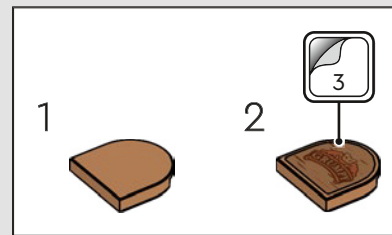
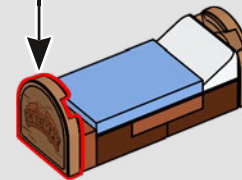

1

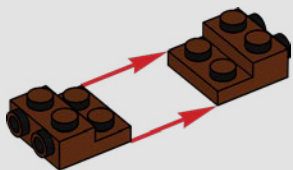

2

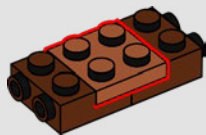

3

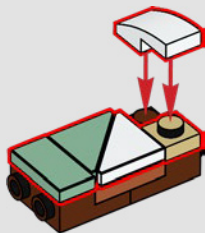

4

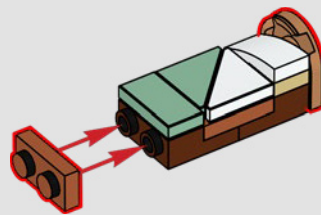

5

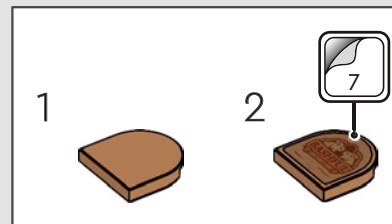
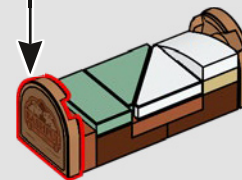



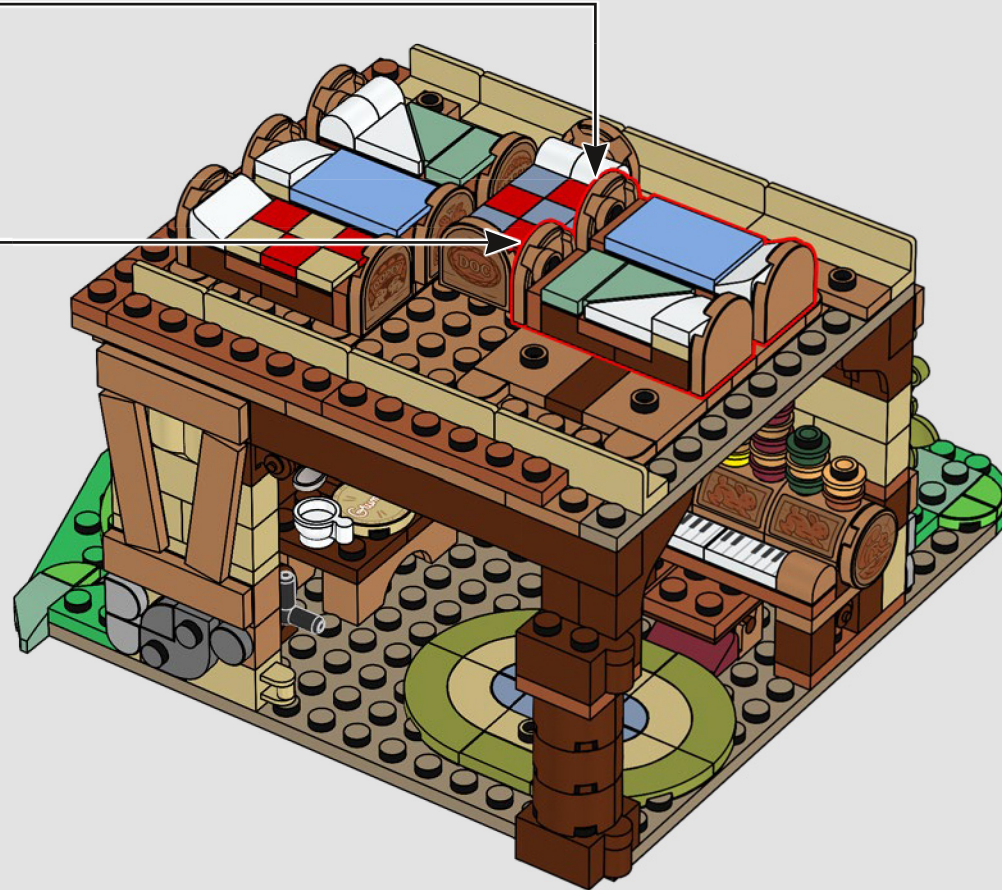

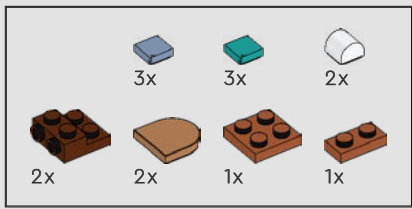

205

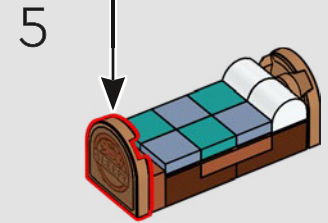
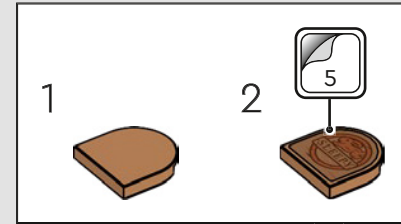
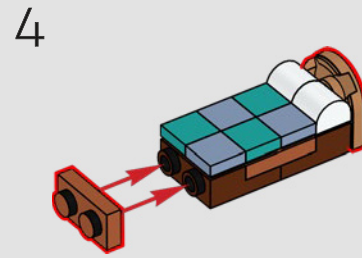
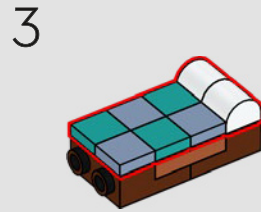
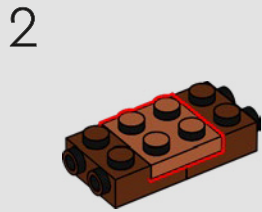
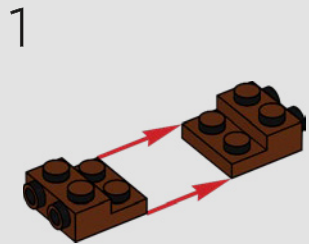

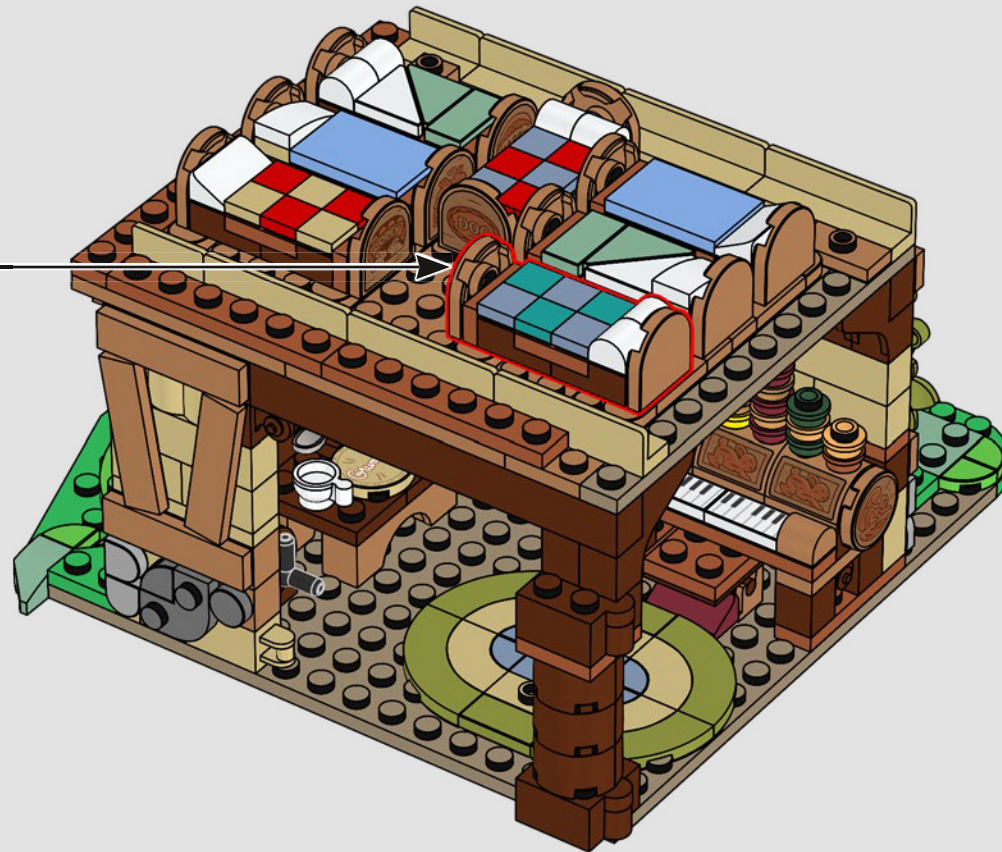



206

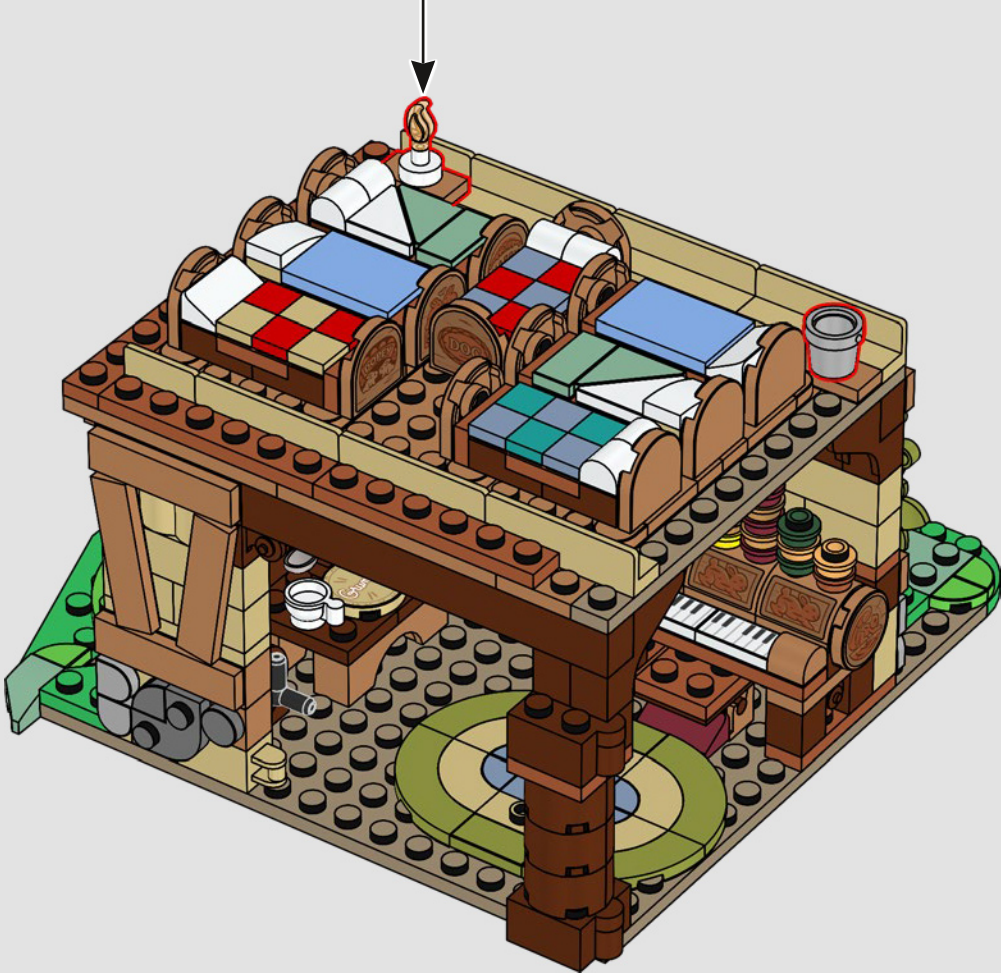
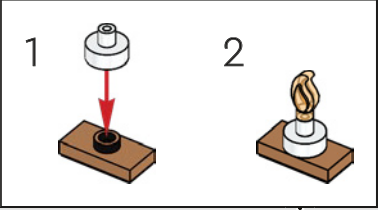

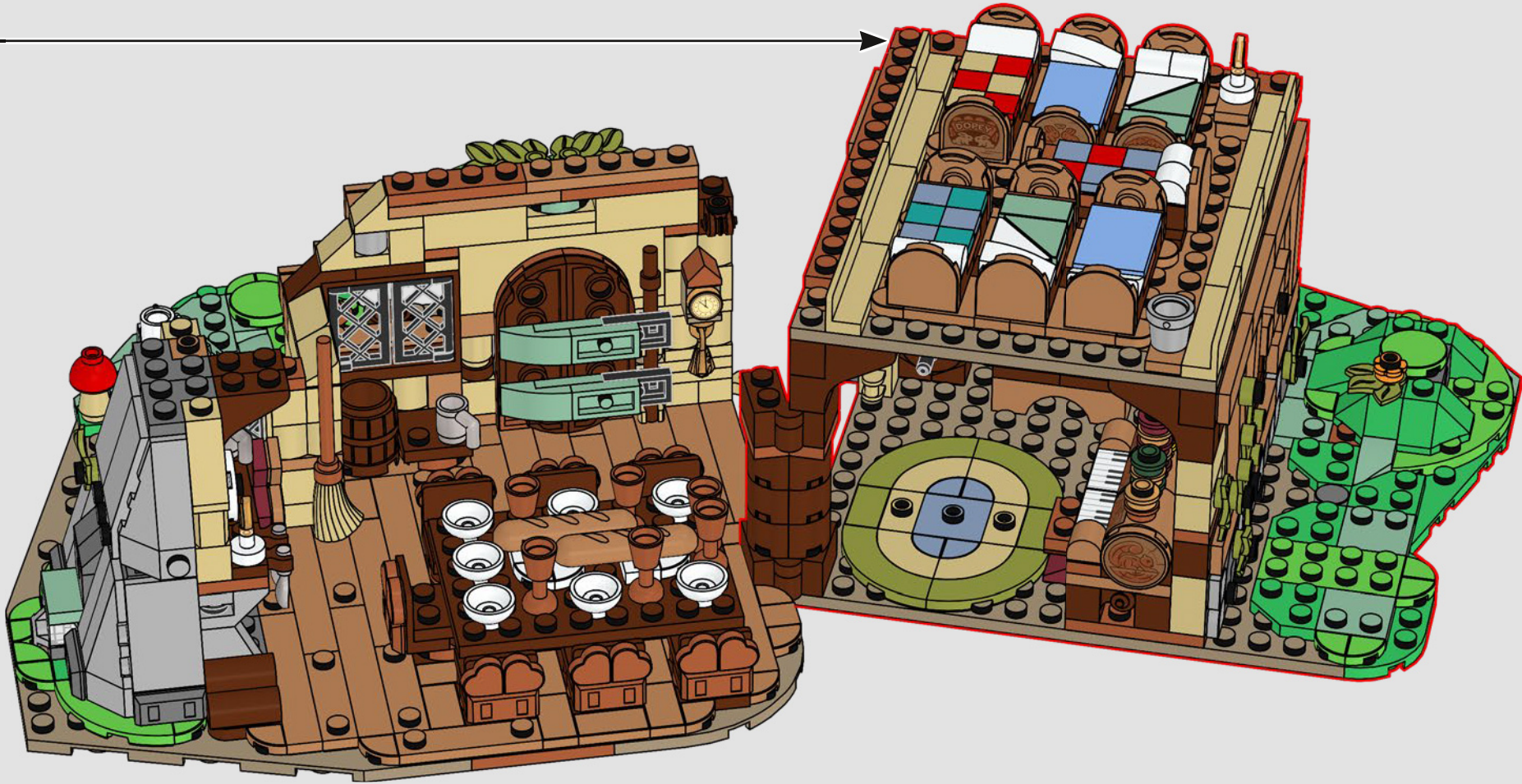

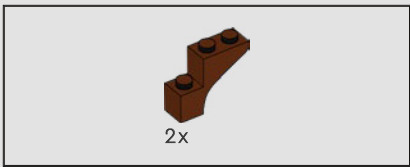

208



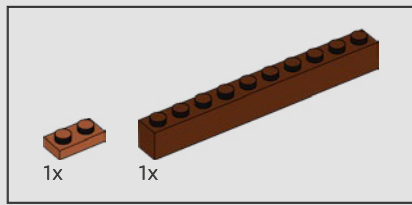

209

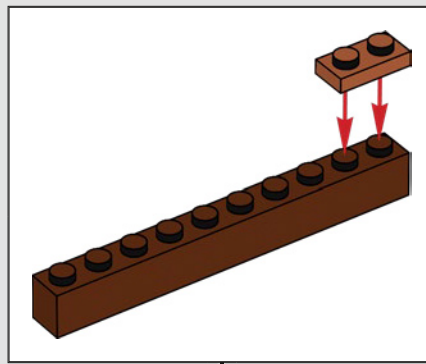

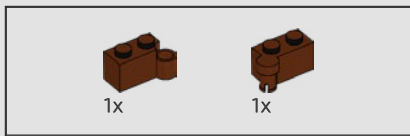

210

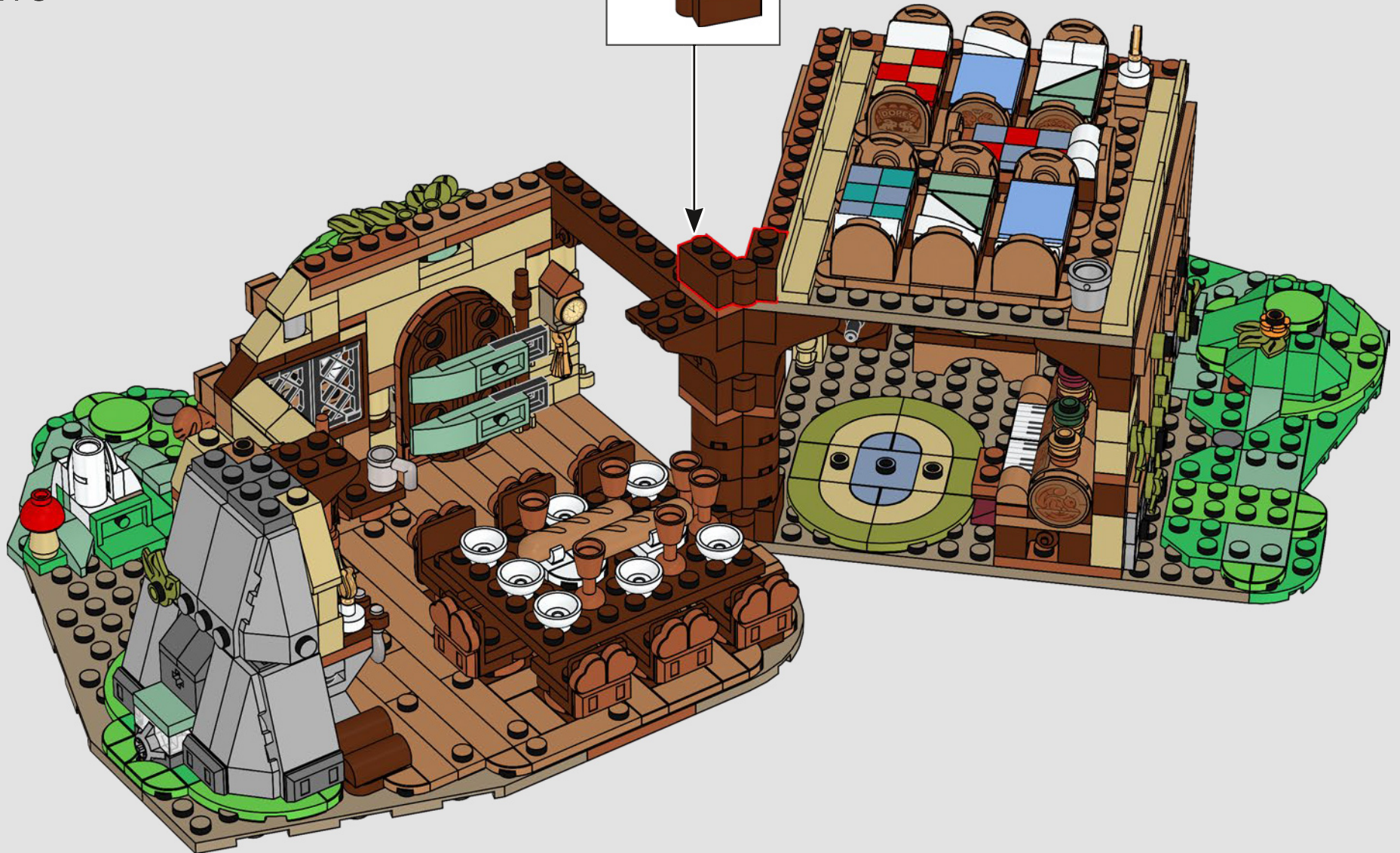
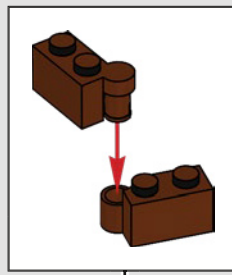



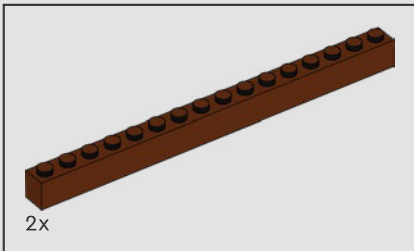
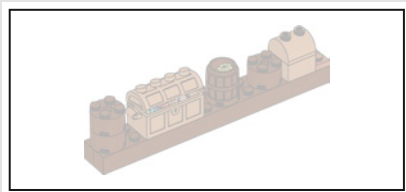

211

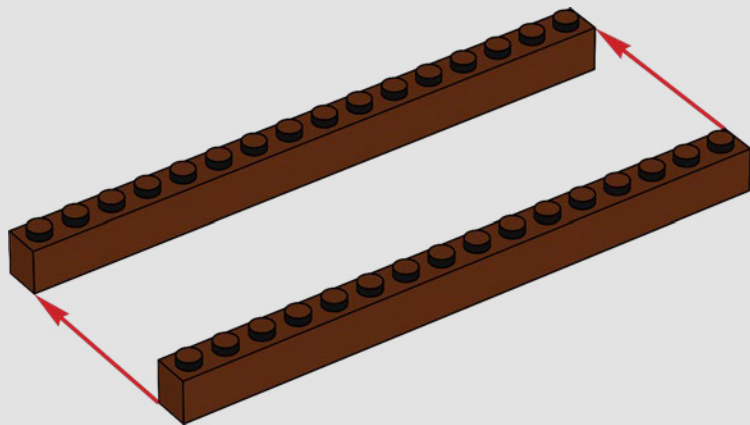

212

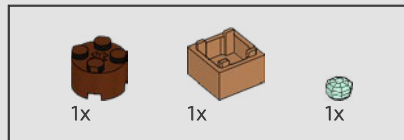
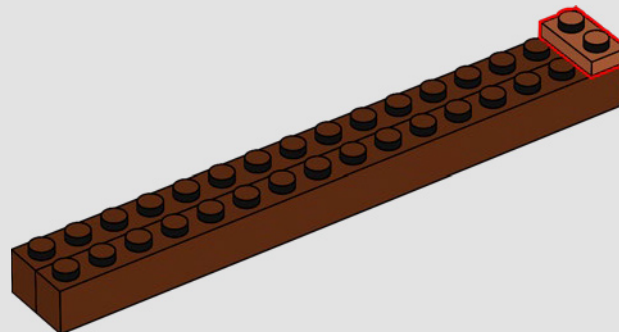

213

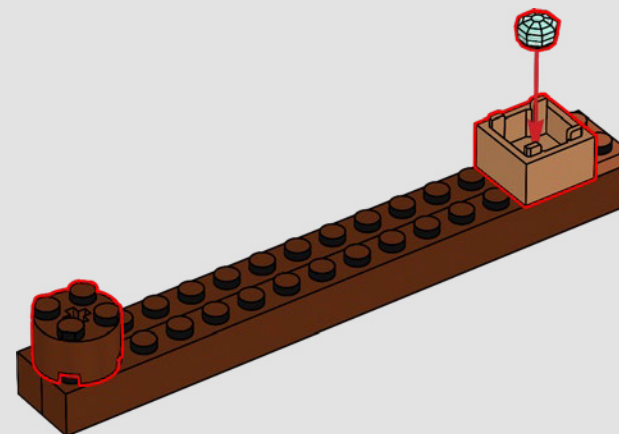

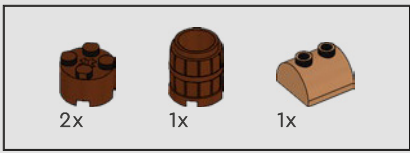

214

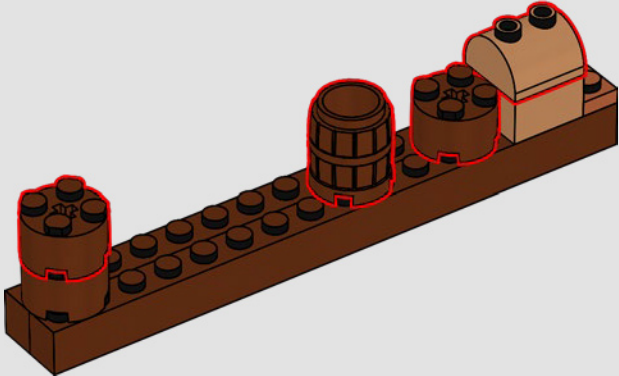

215

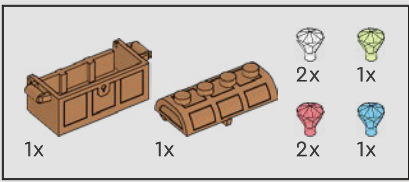
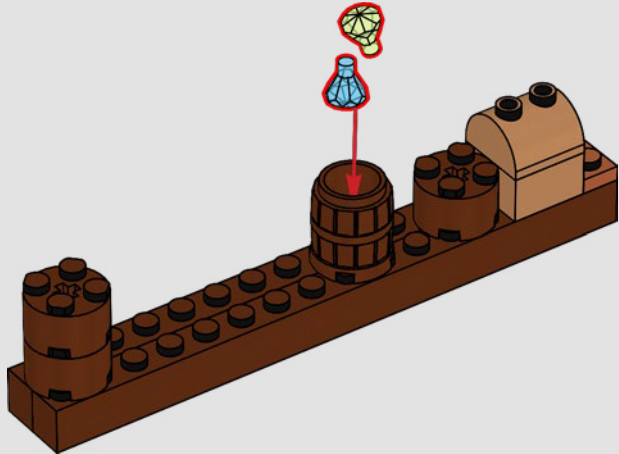

216

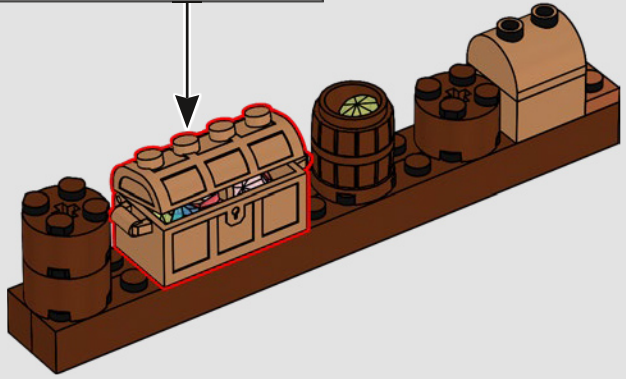
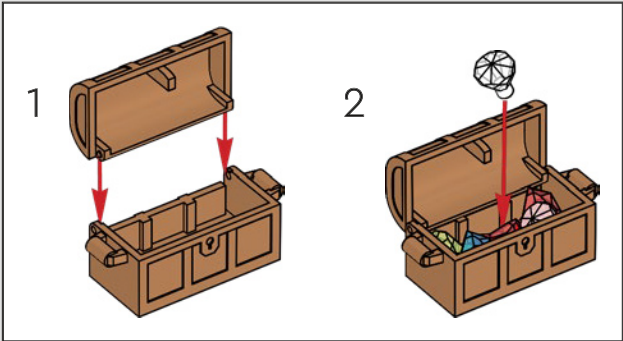

217



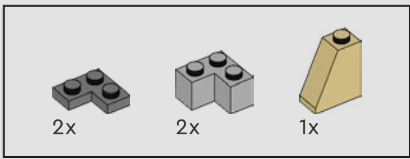

218

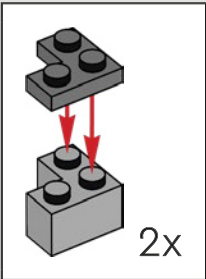

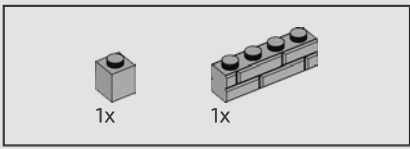

219



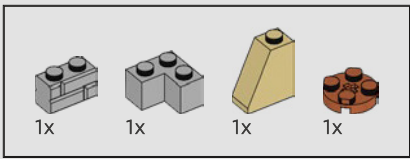

220



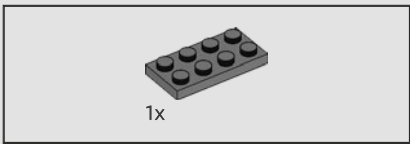

221





2x

222



2x



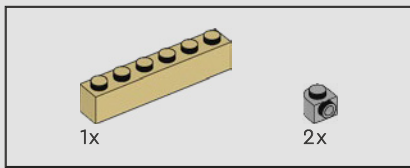

223





2x

224





225





2x

226



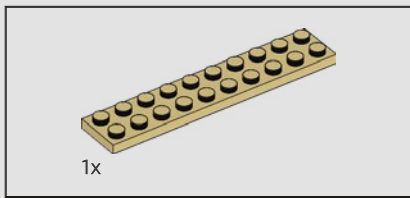

227

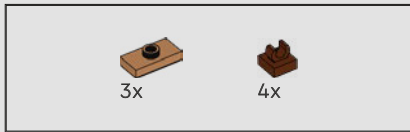
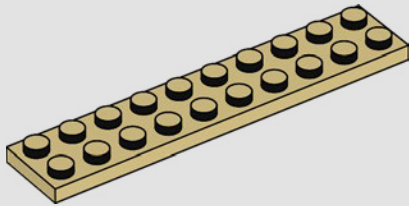

228

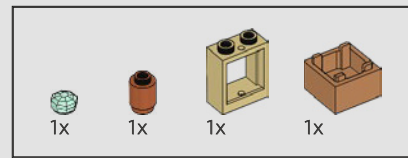
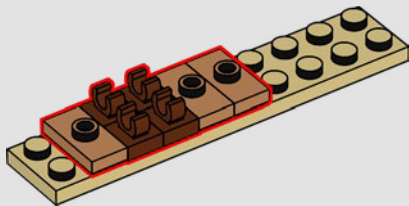

229

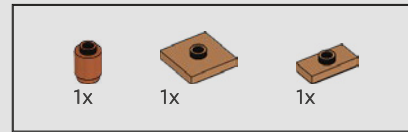
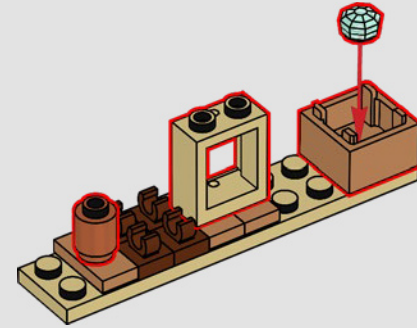

230

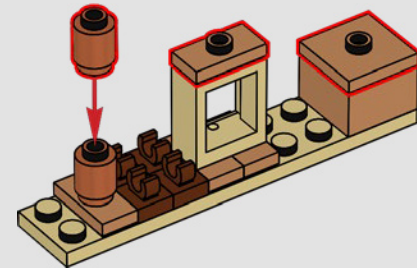



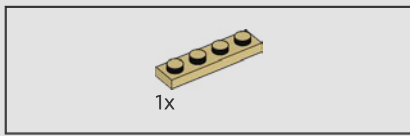

232

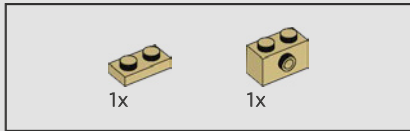
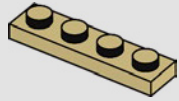

233

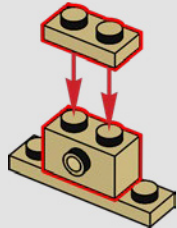

234

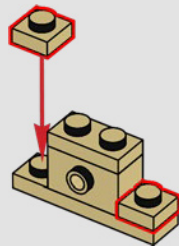

235

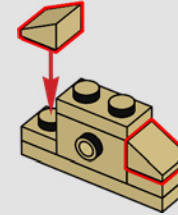

236

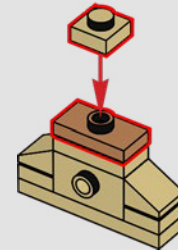





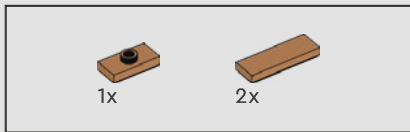

238



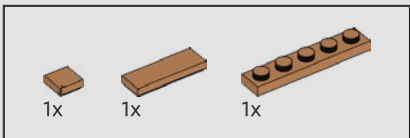

239

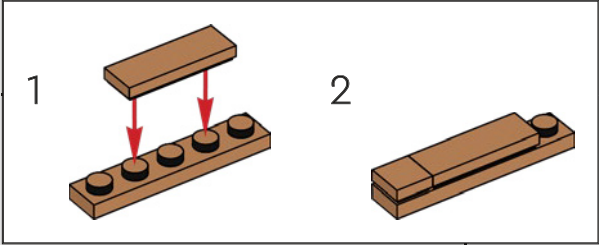

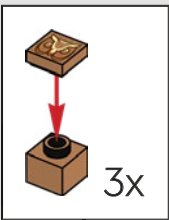

240



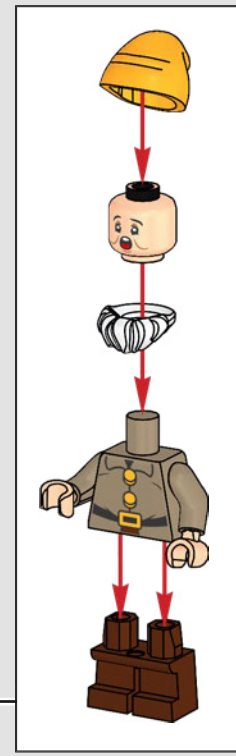

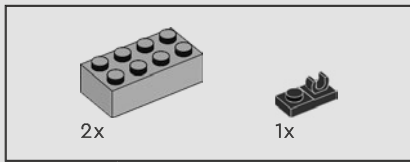

241

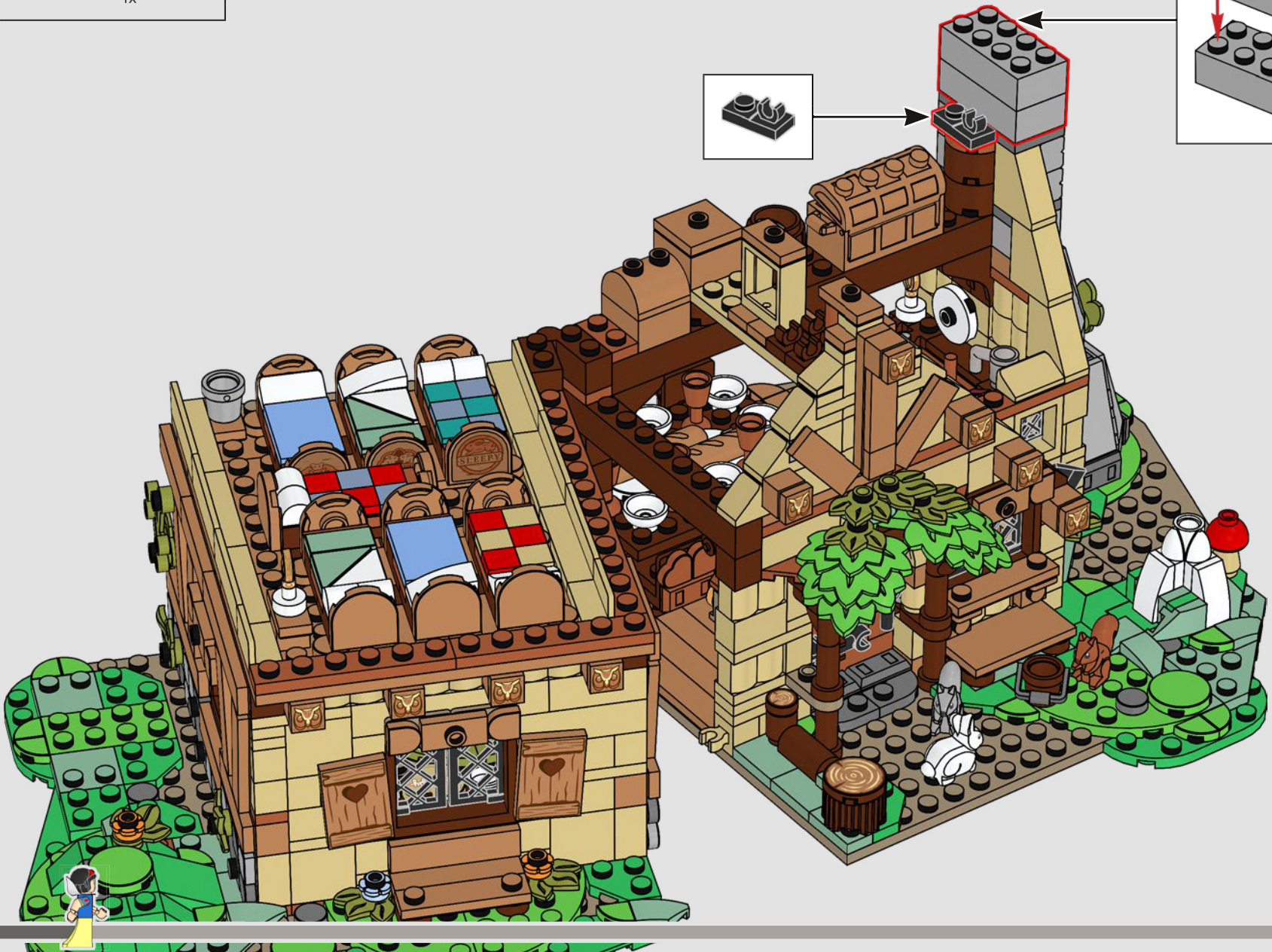
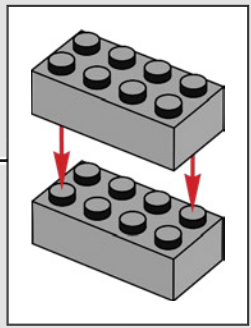

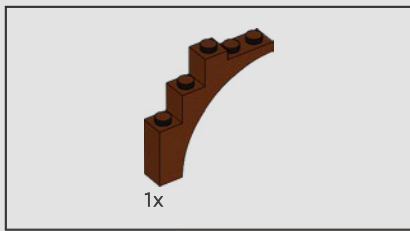

242



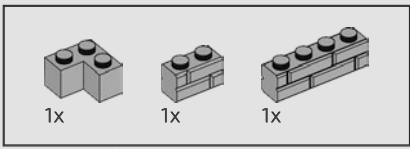

243



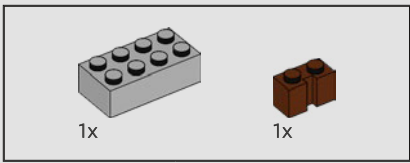

244





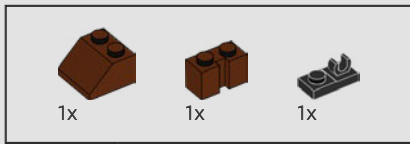

245

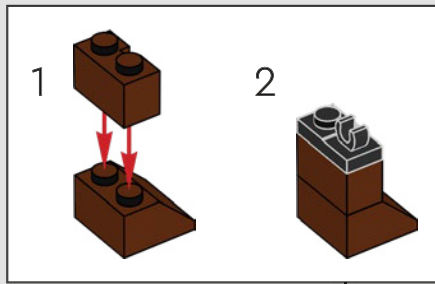

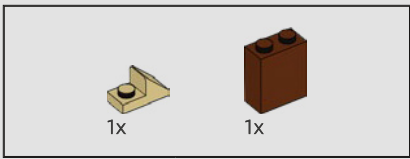

246

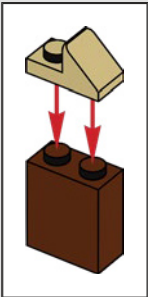

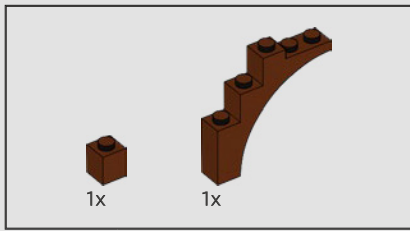

247



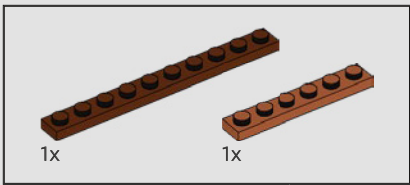

248

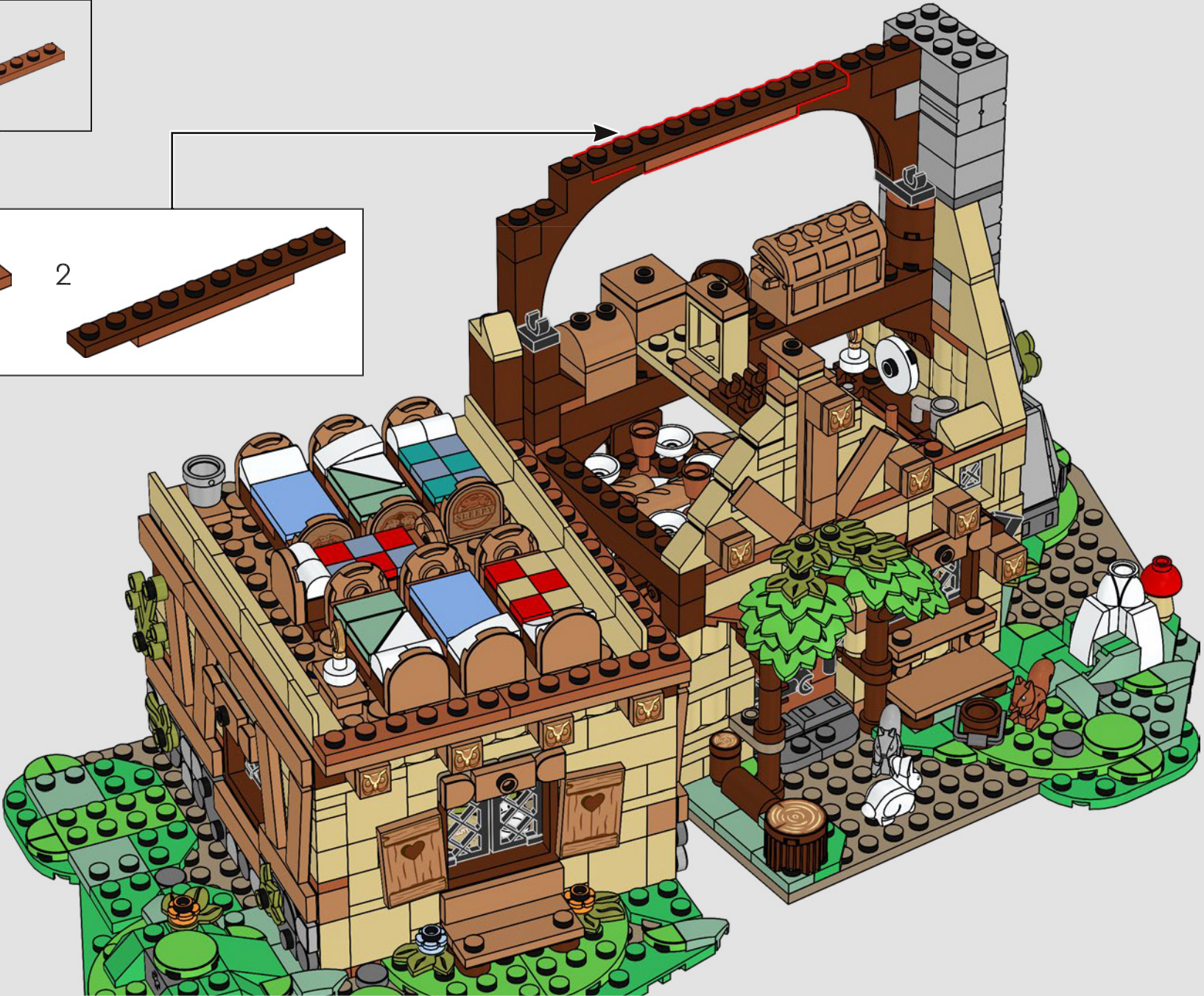
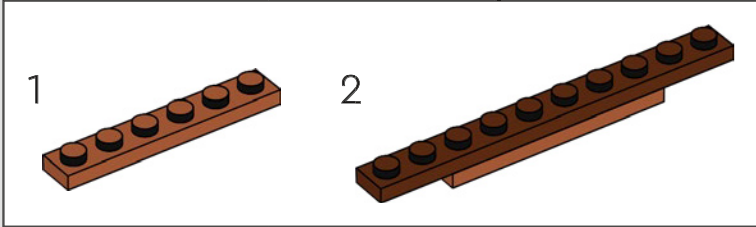

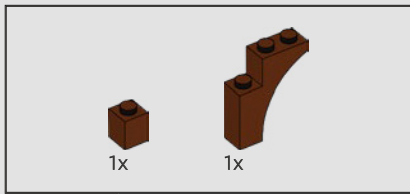

249



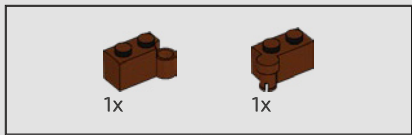

250

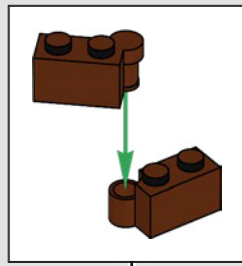

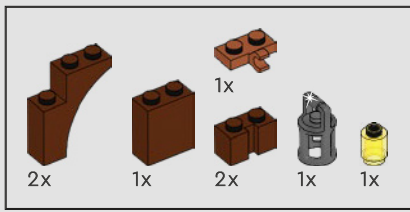

251

1

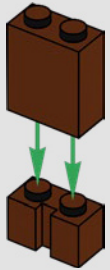

2

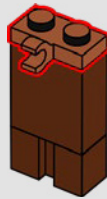

3

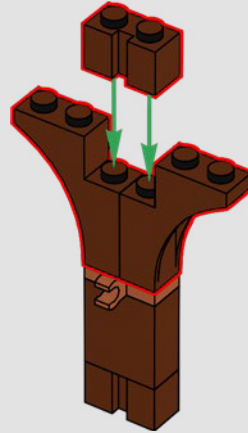

4

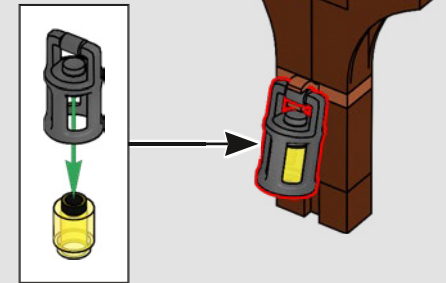





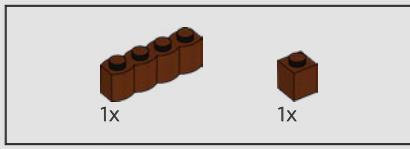

252



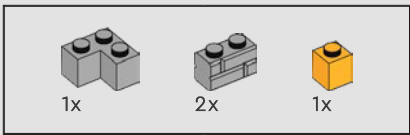

253



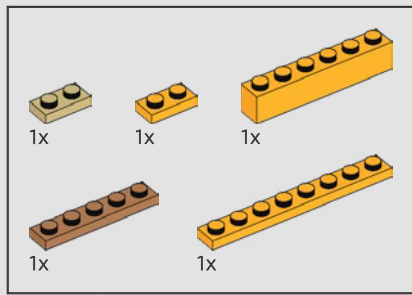

254



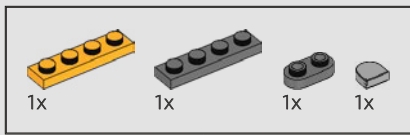

255





256

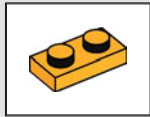
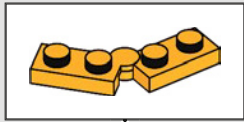



3x



3x

257



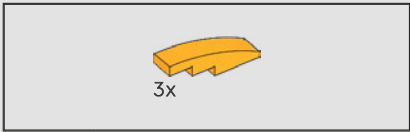

258



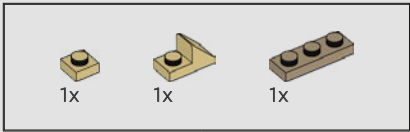

259

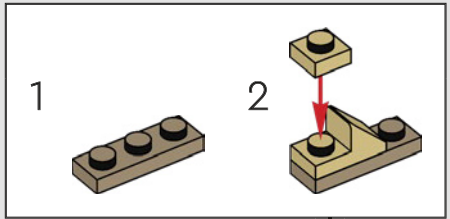



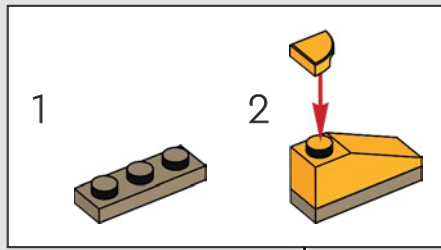
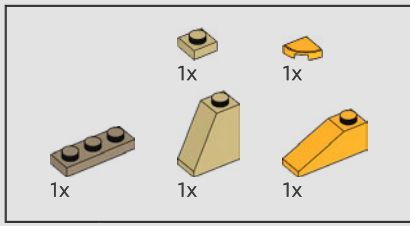

260

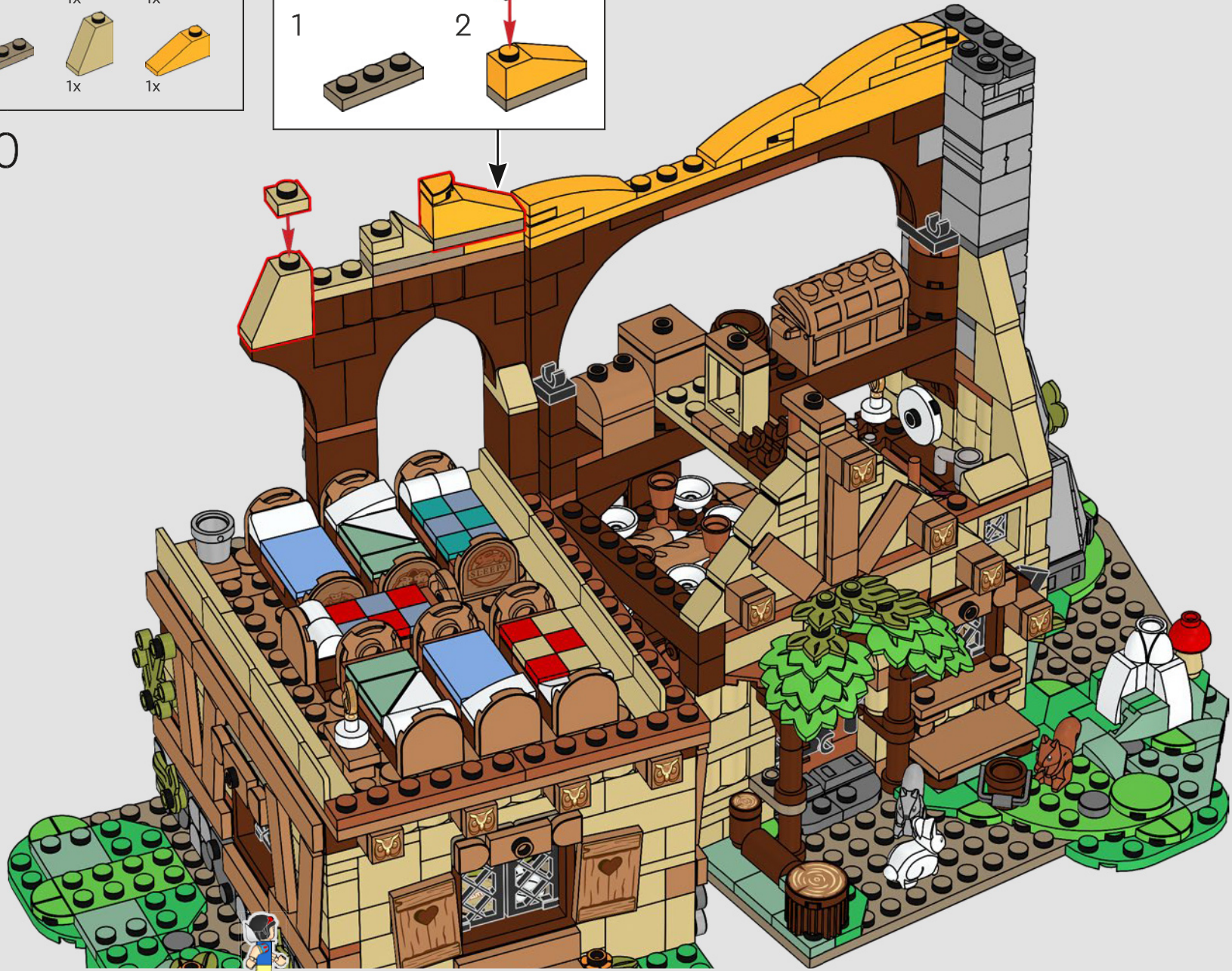

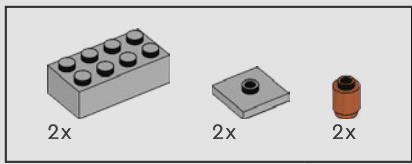

261

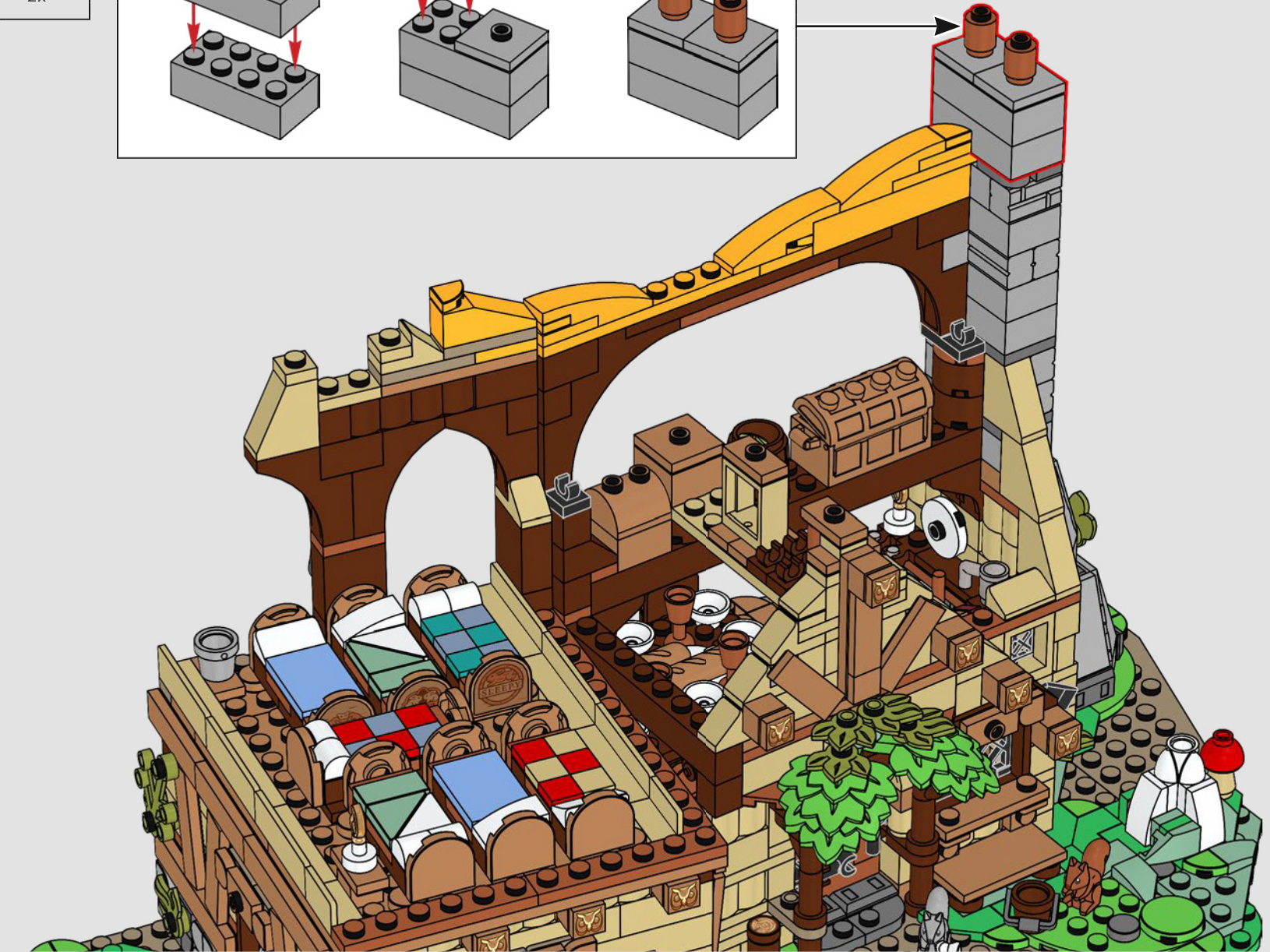
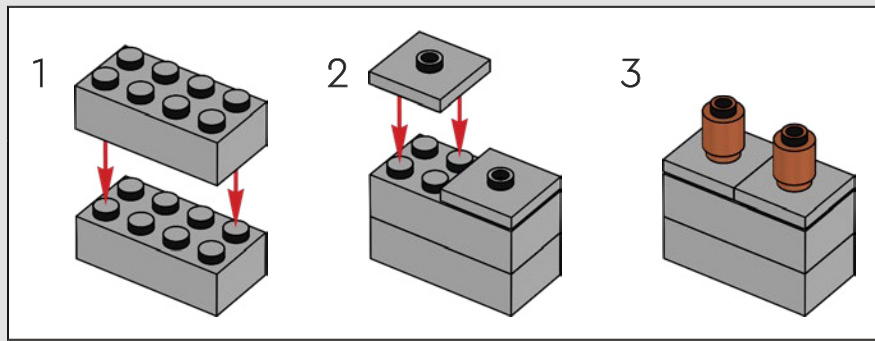

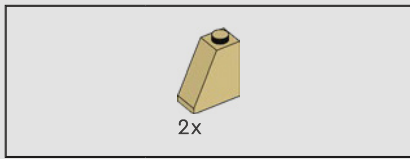

262

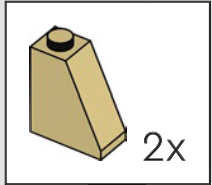

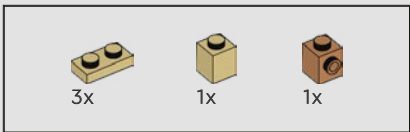

263

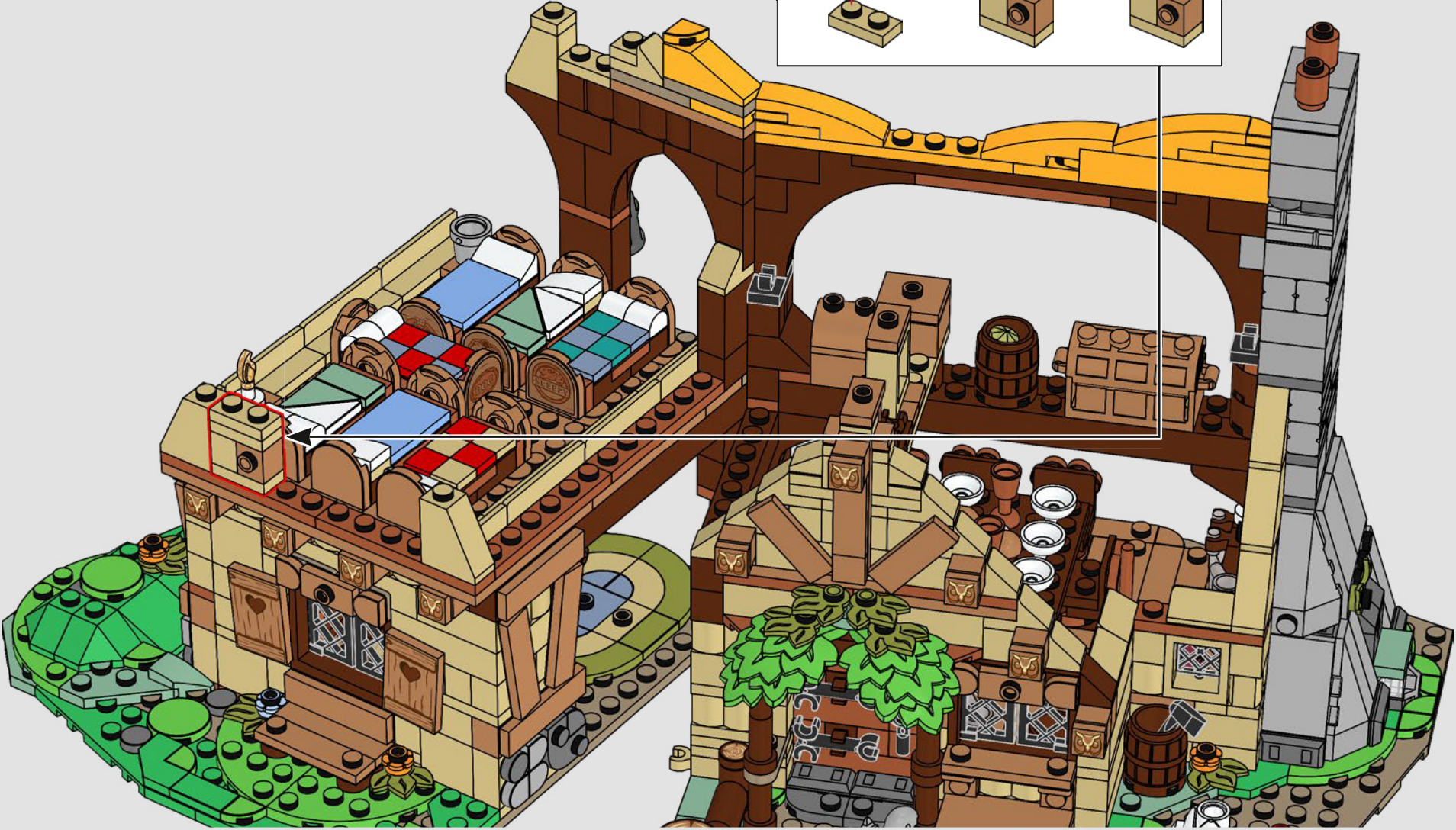
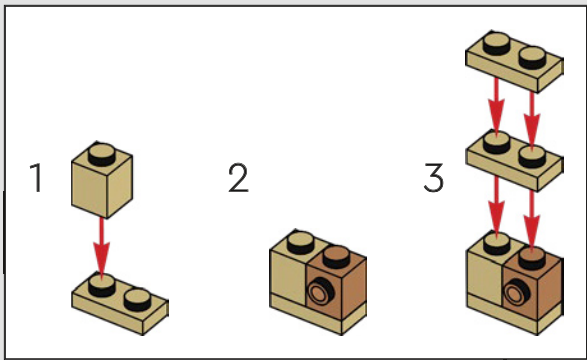

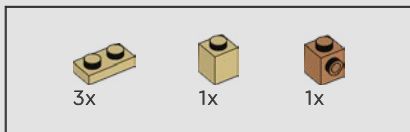

264

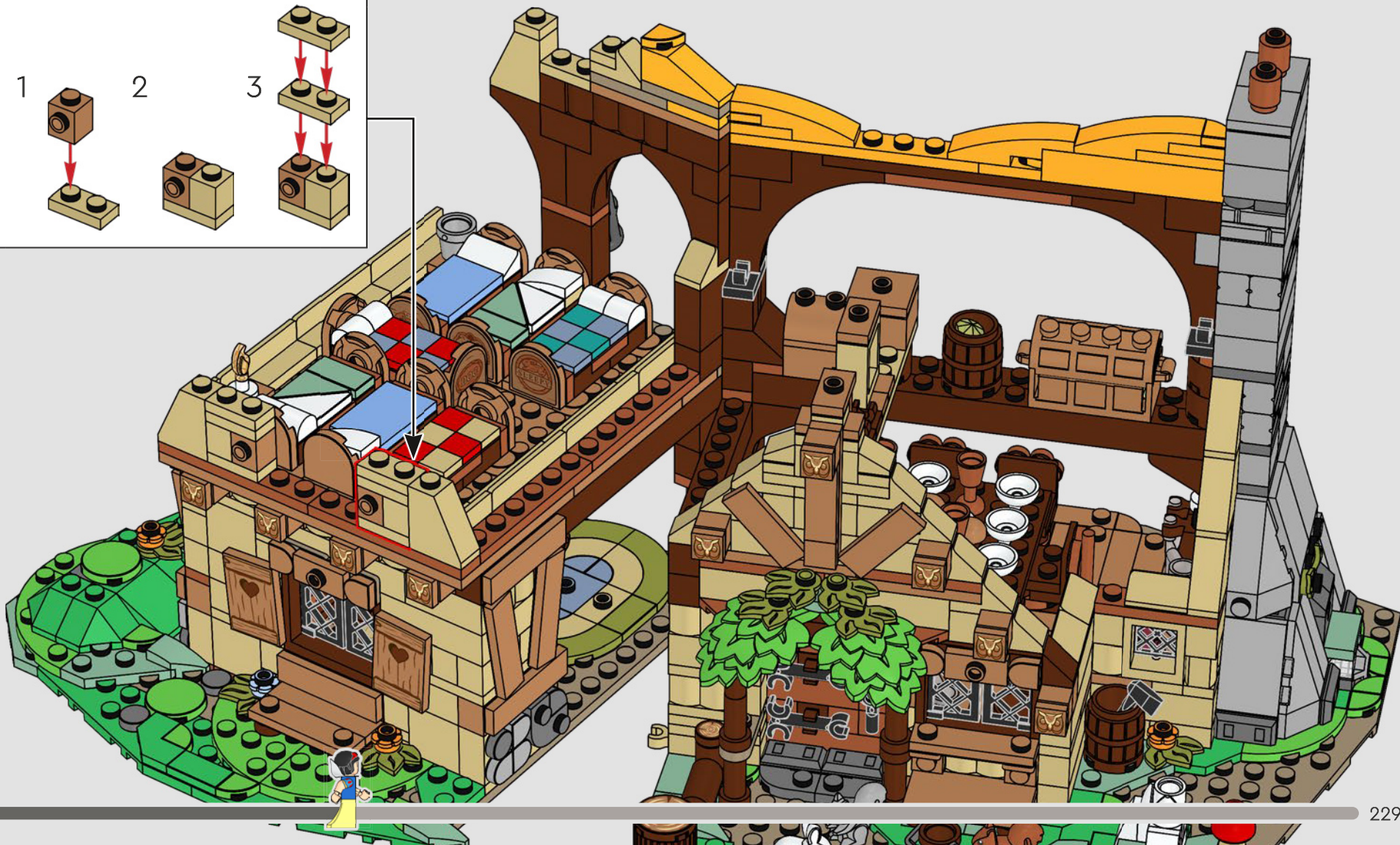
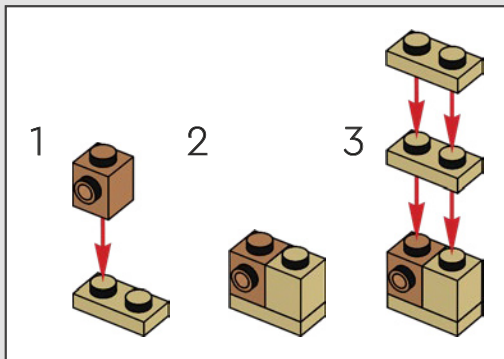

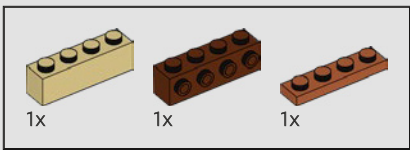

265

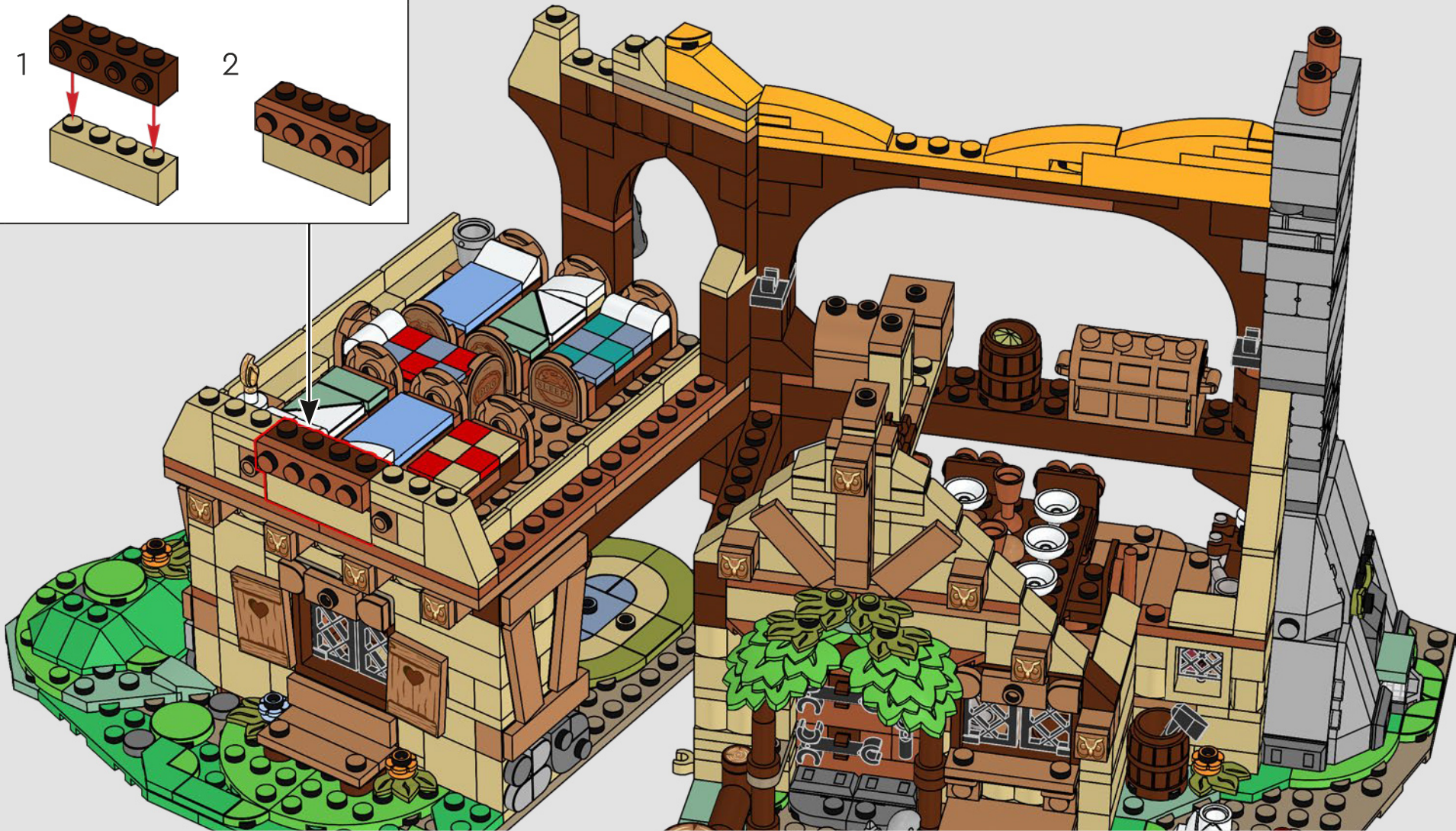
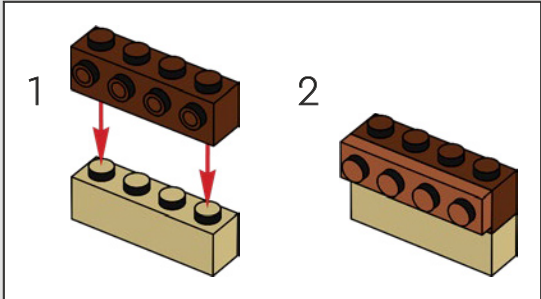

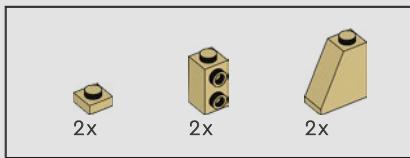

266

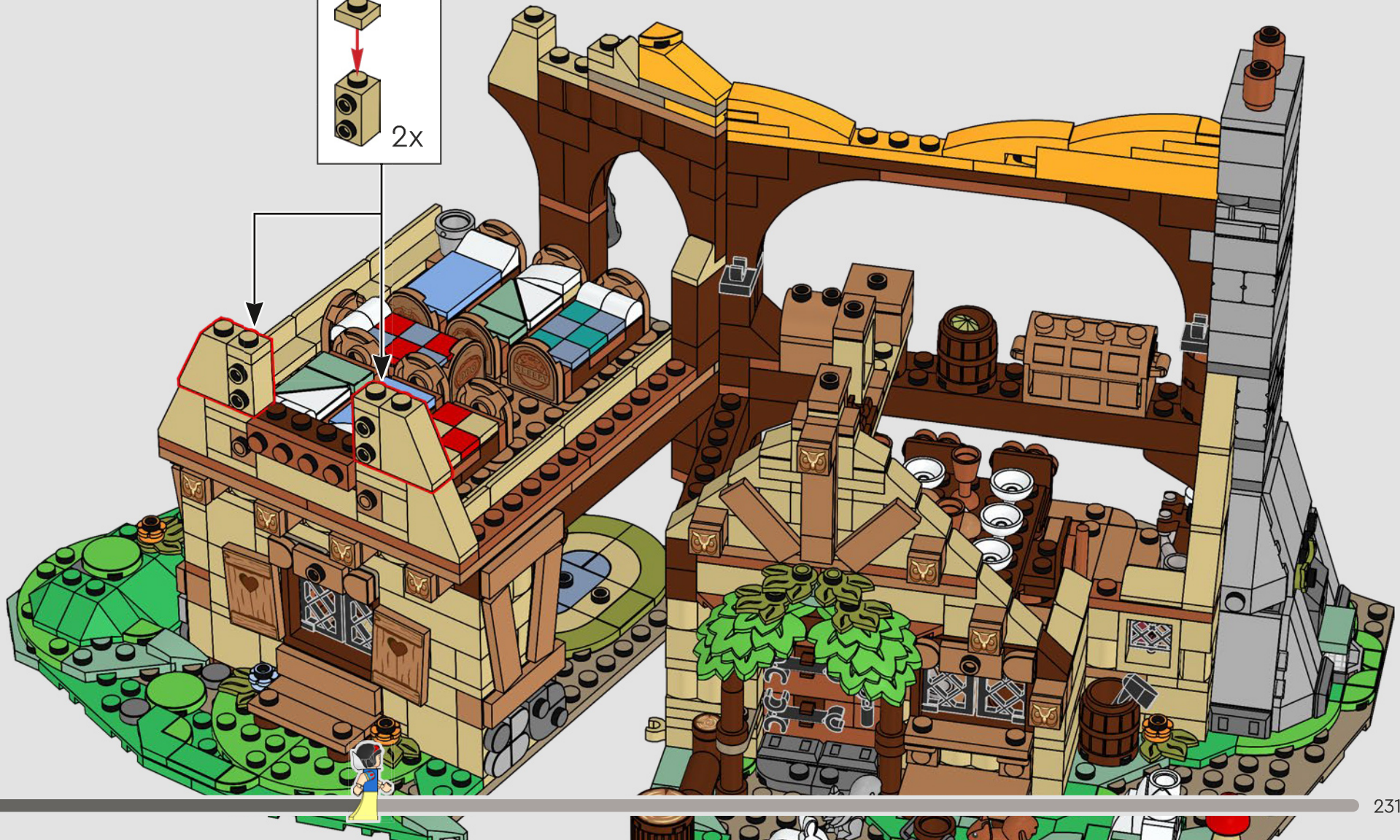
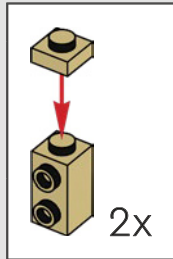



2x

267

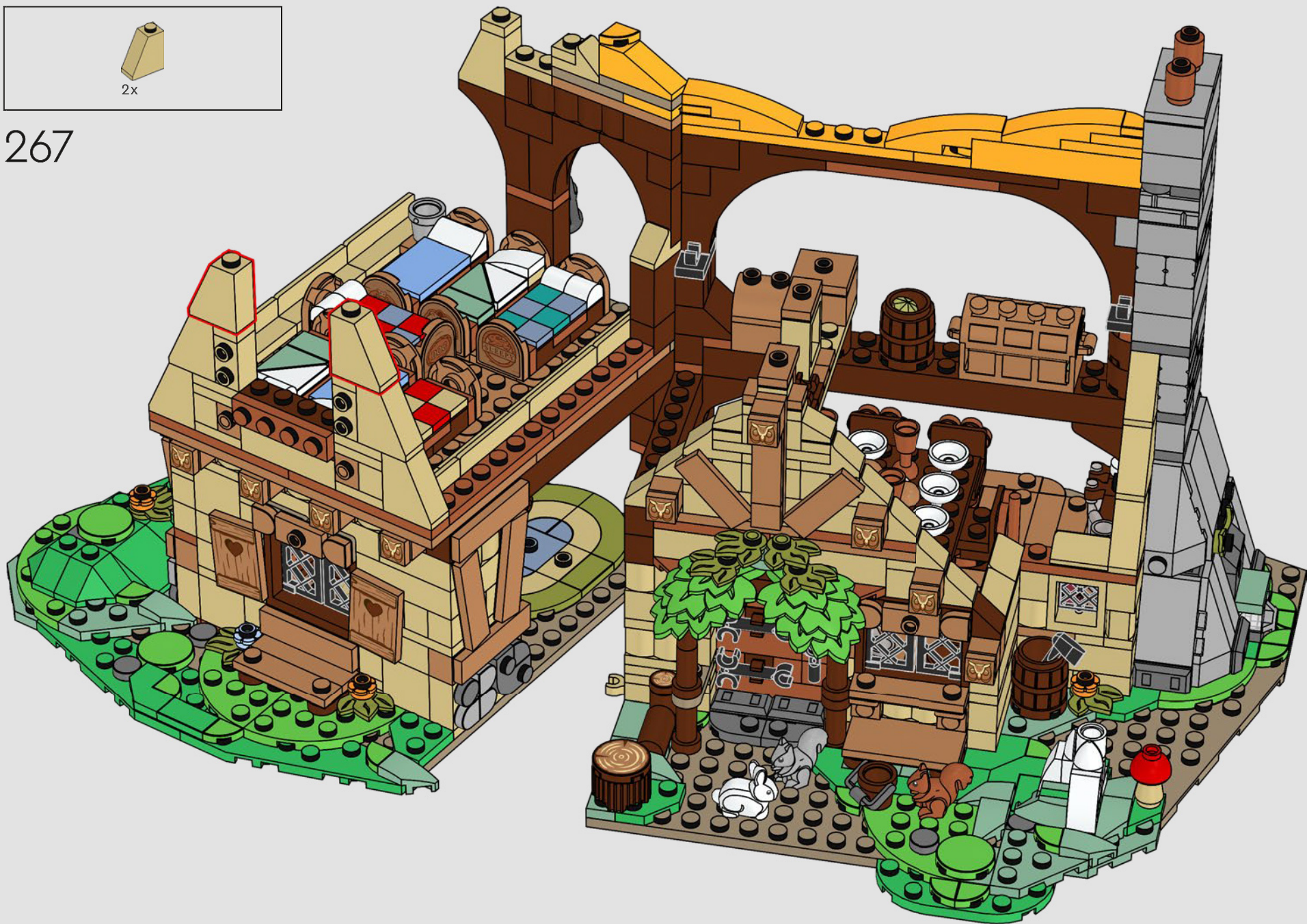



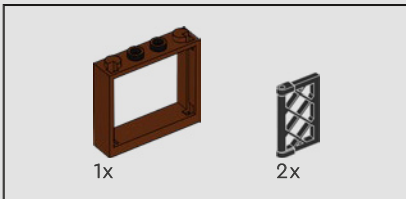
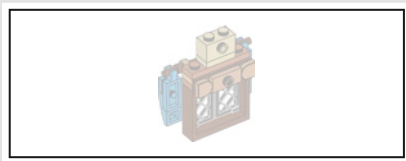

268

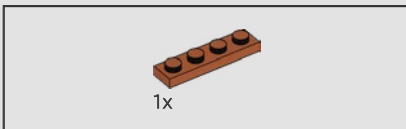
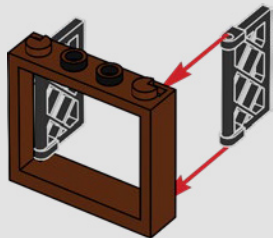

269

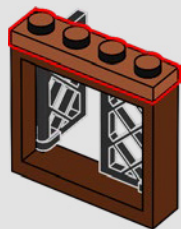

270

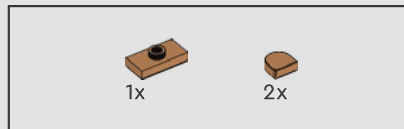
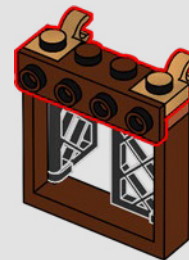

271

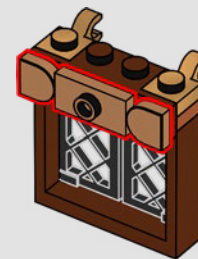

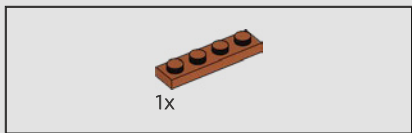

272

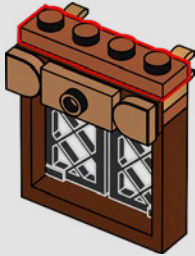

273

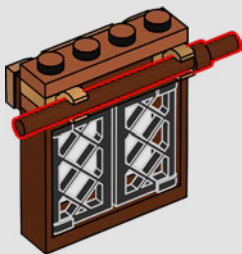

274

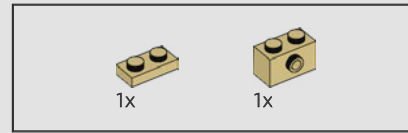
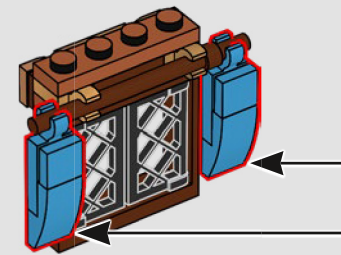
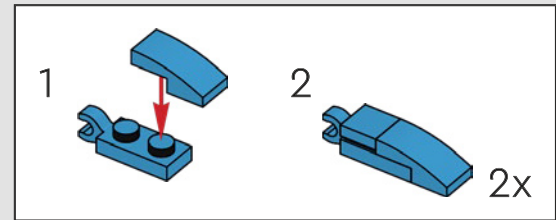

275

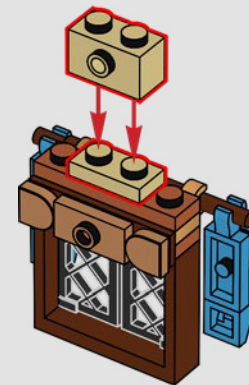

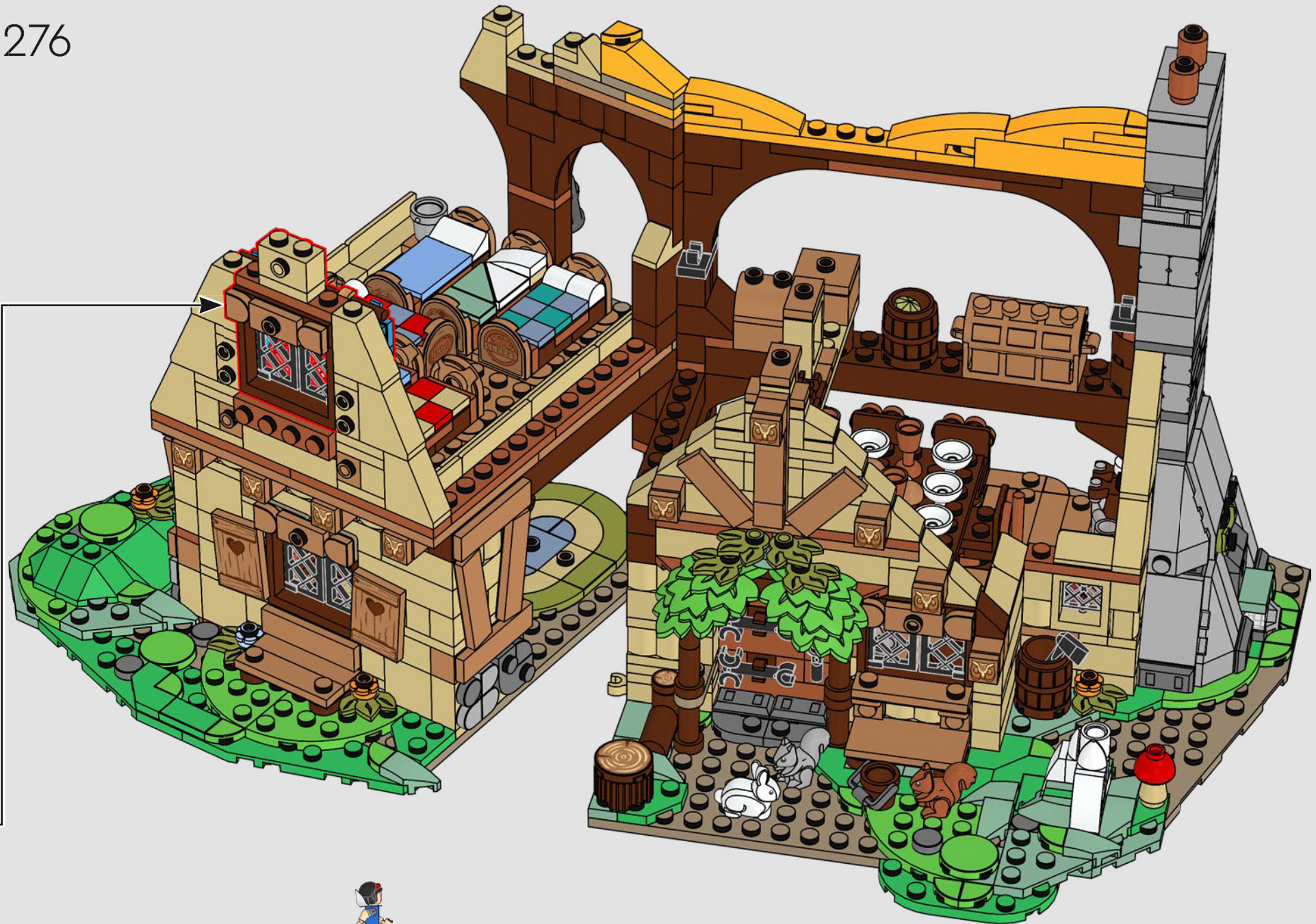

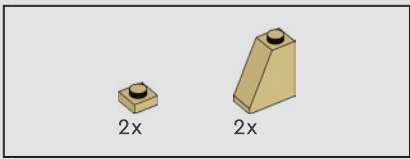

277

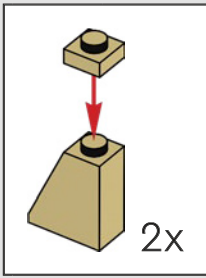
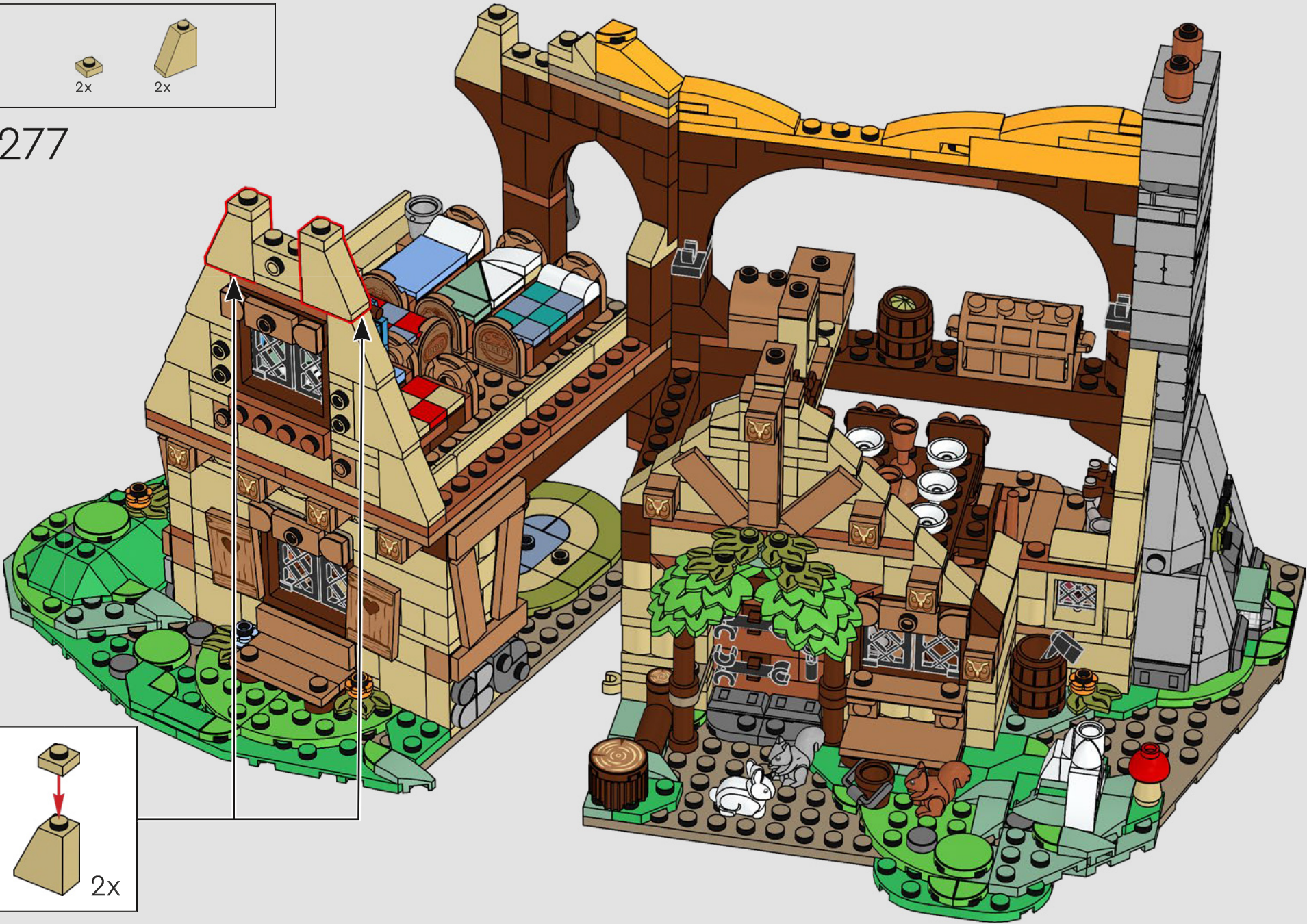

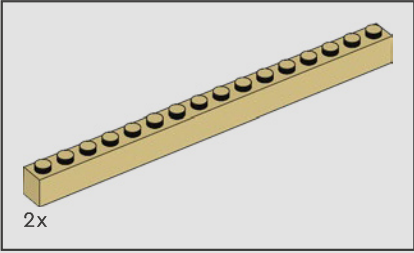
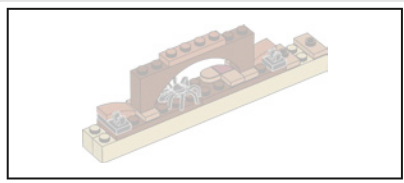

278

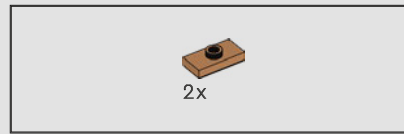
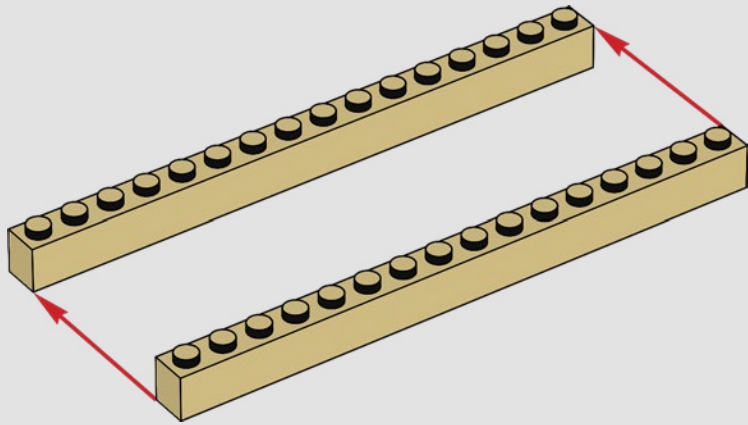

279

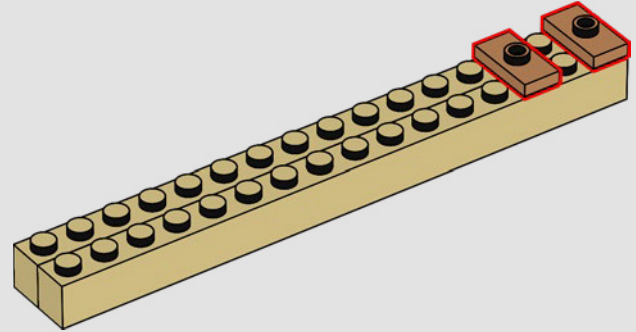

280

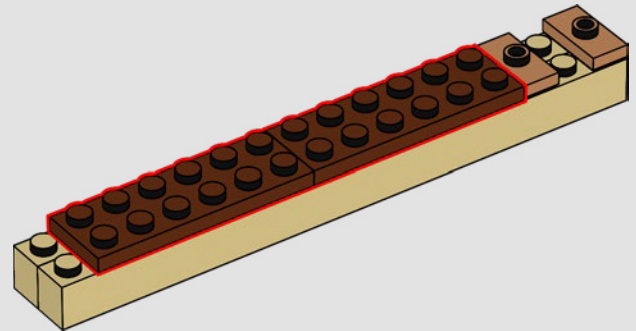



2x

281

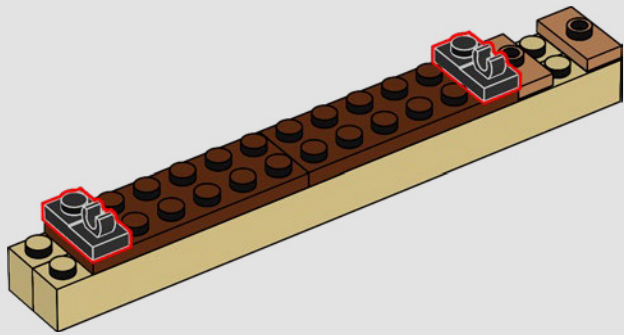

282

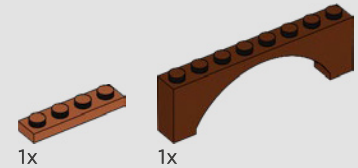
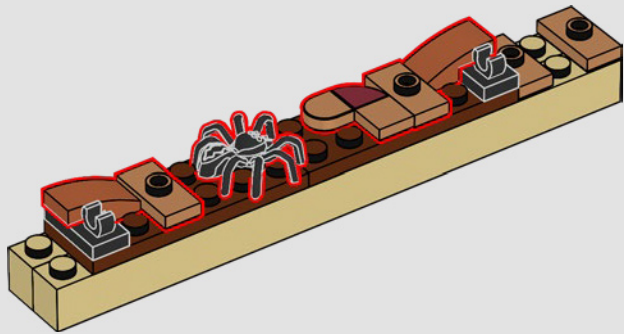

1x

1x

283

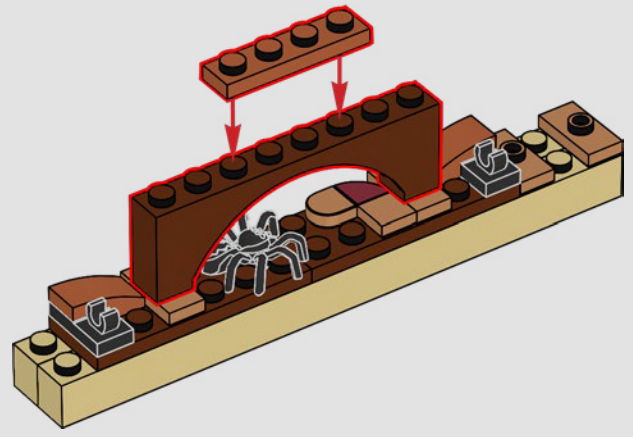

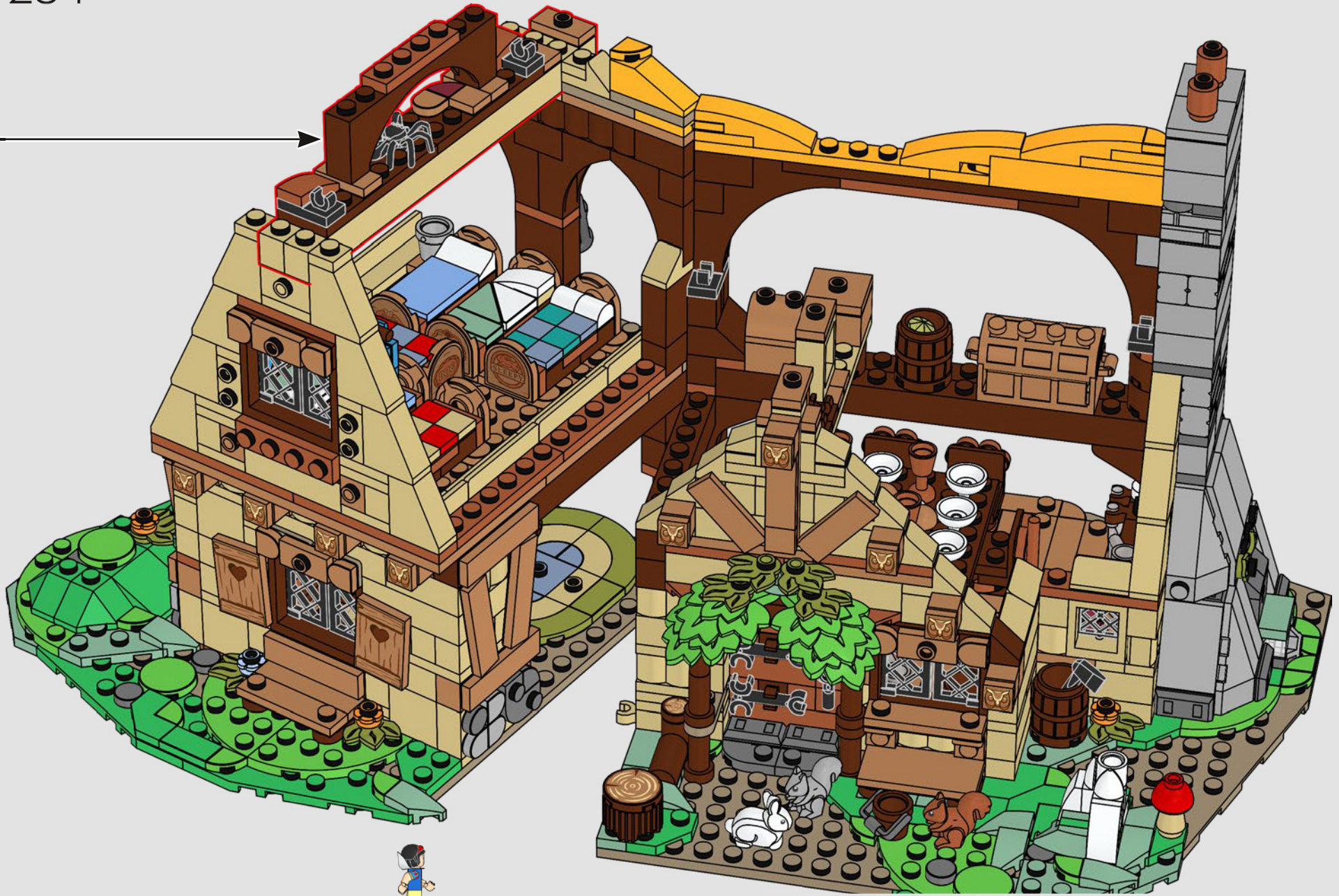

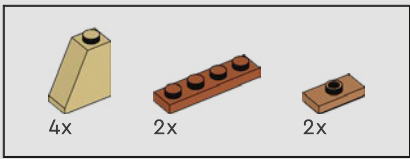

285

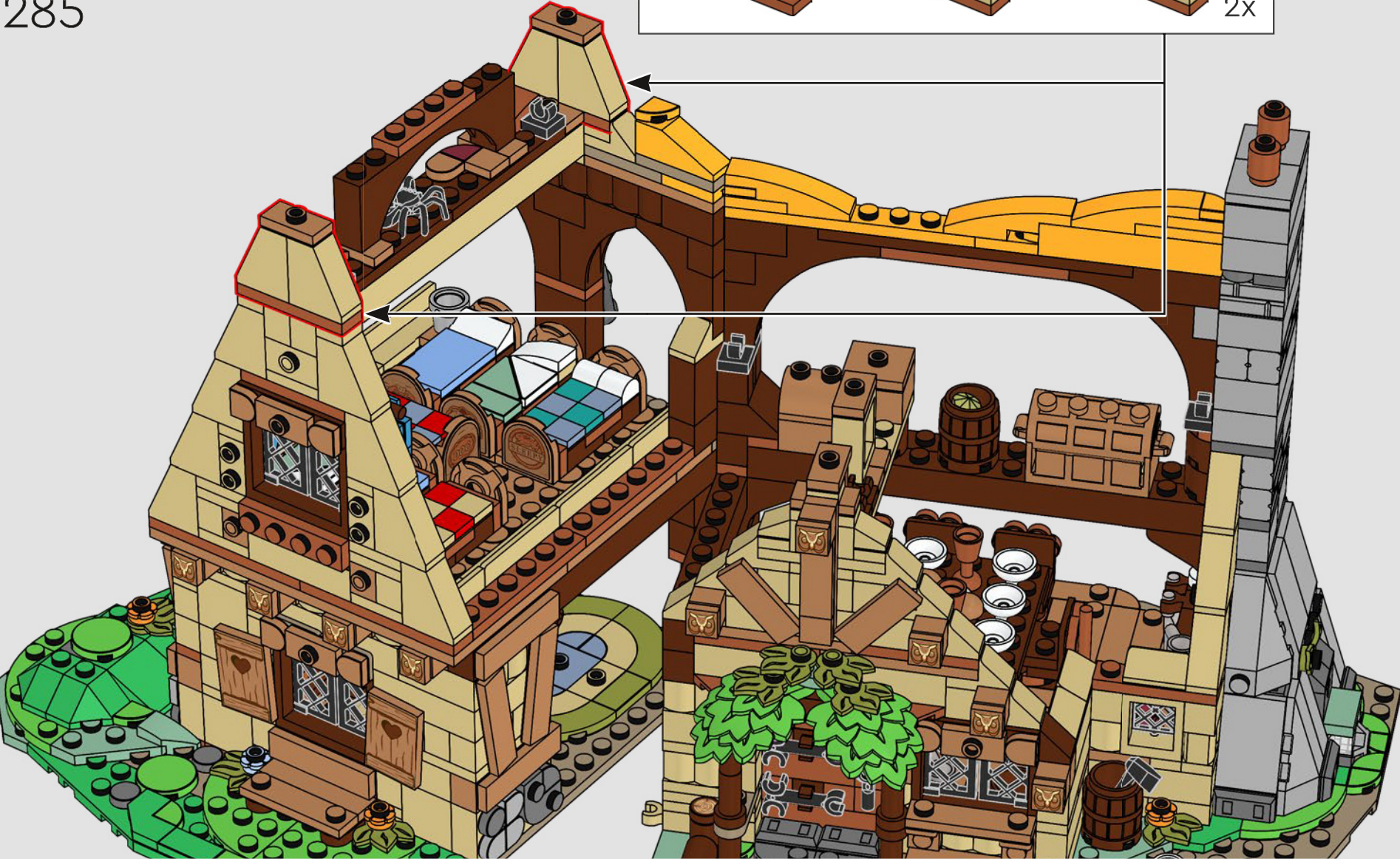
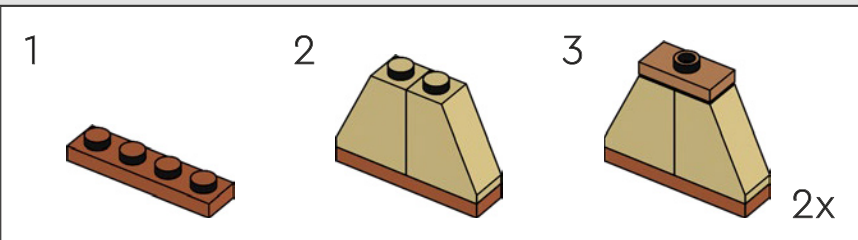



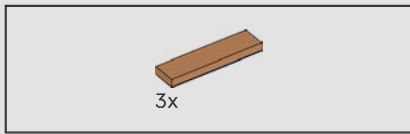

286

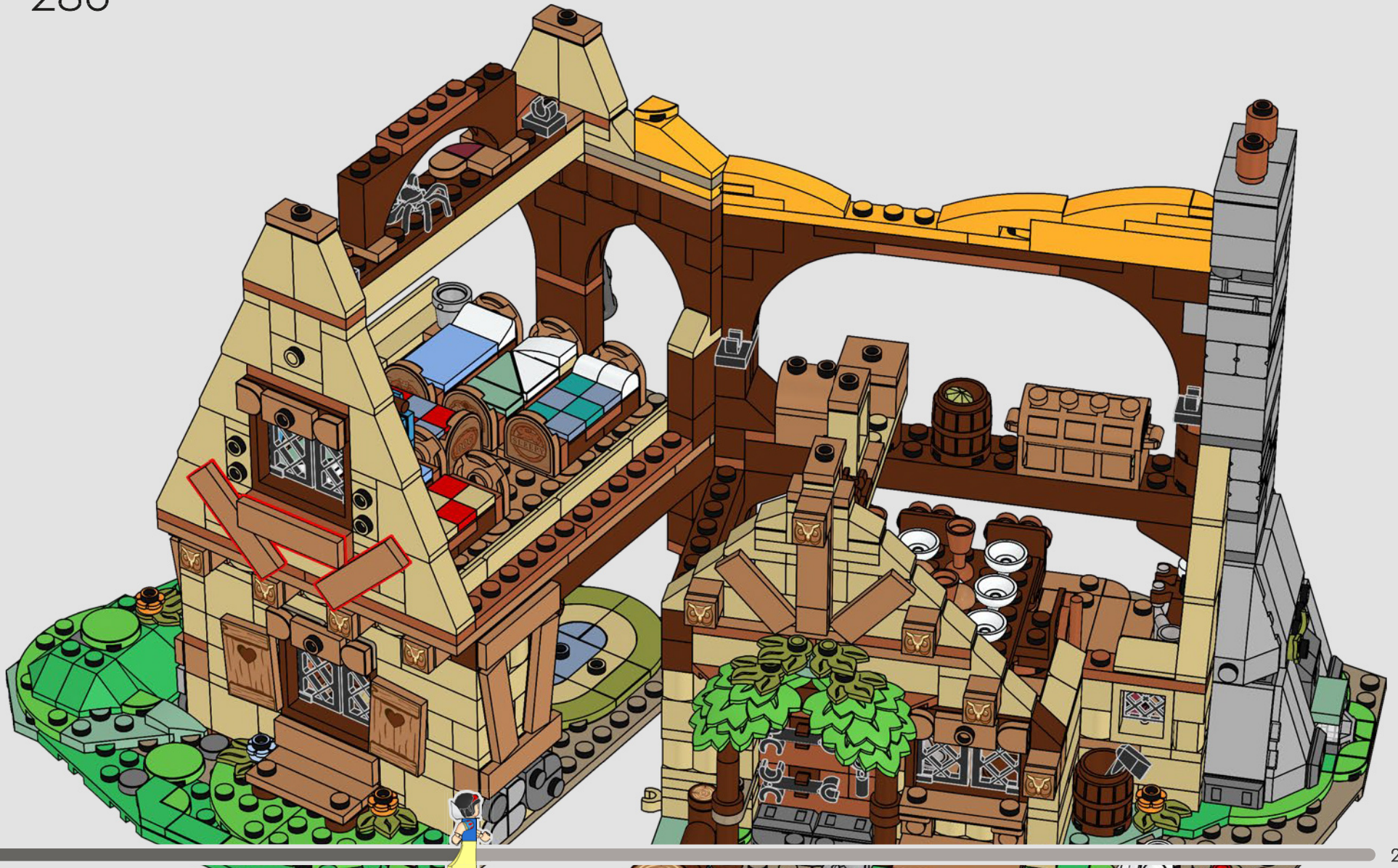

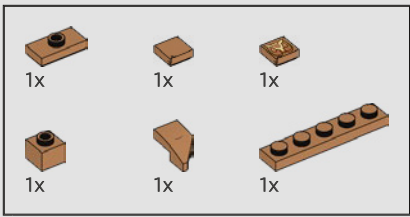

287

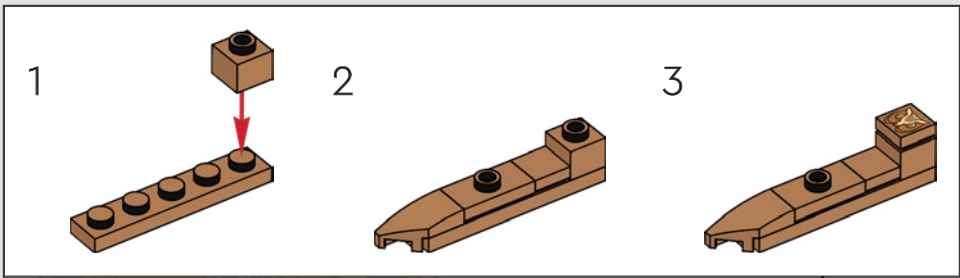

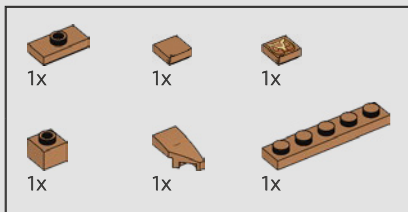

288

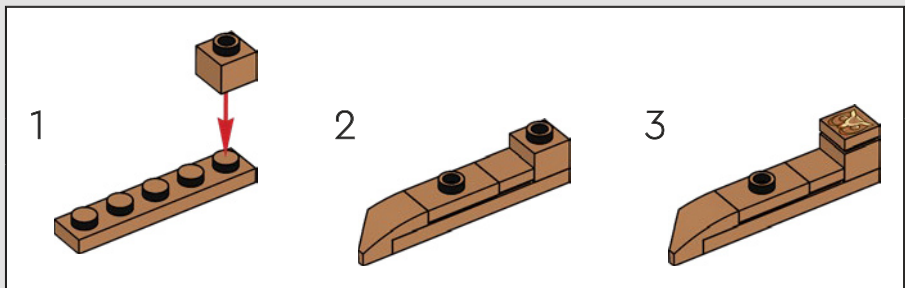

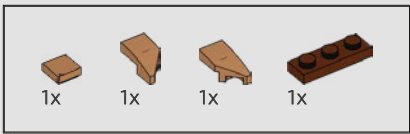

289

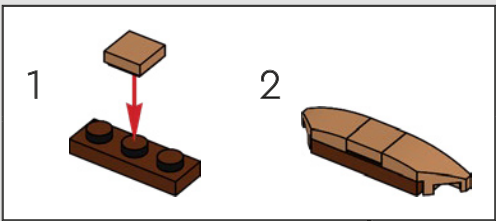

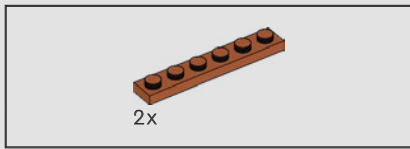

290

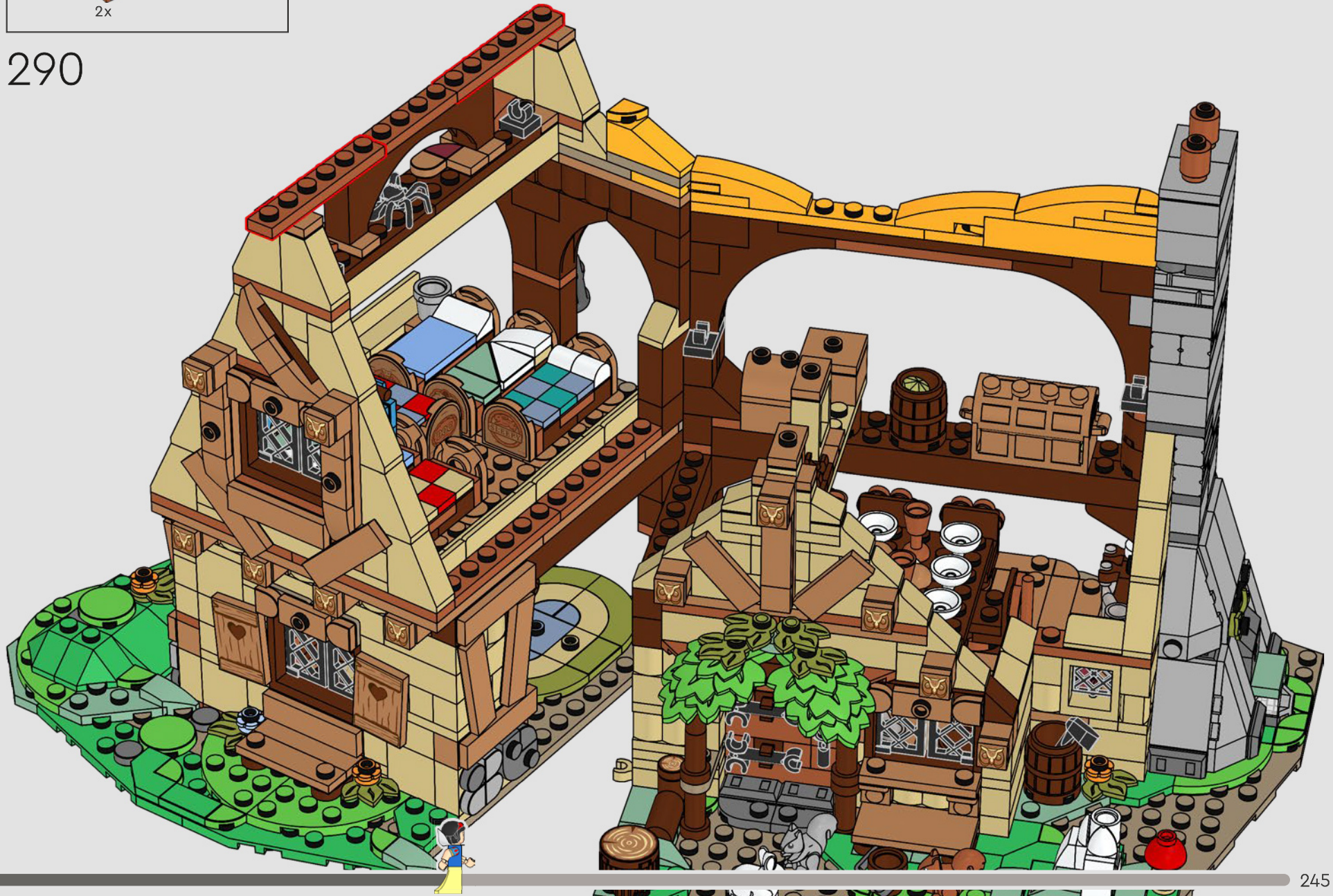

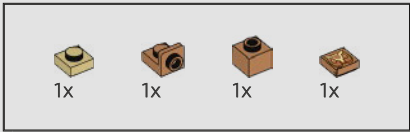

291

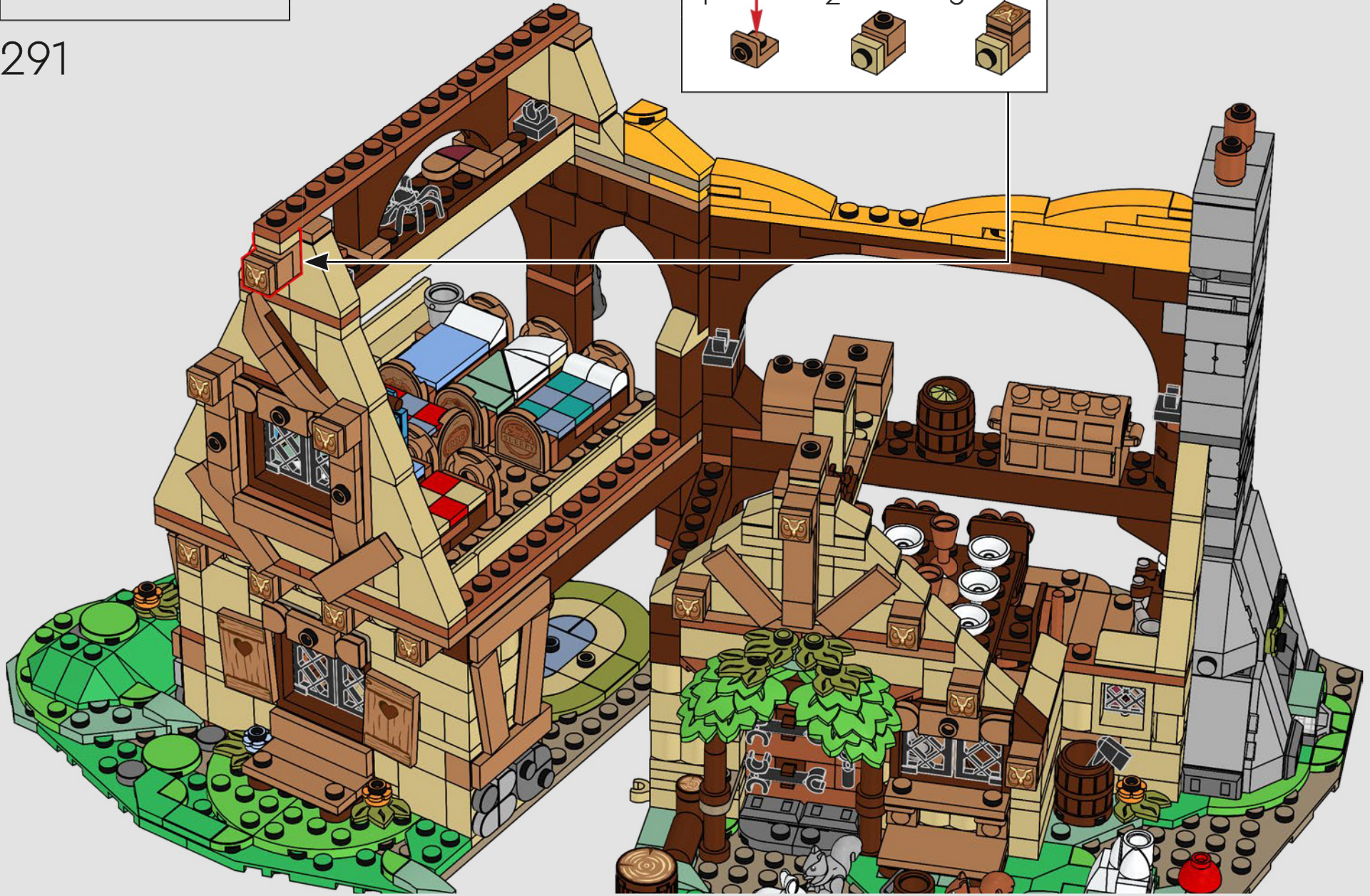
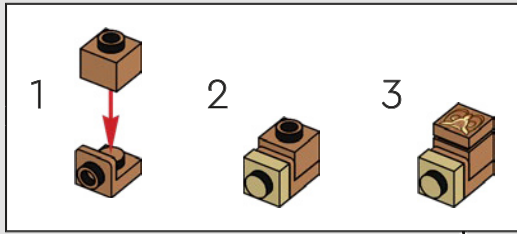

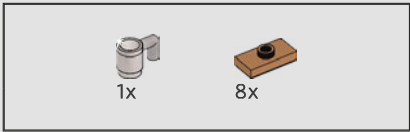

292

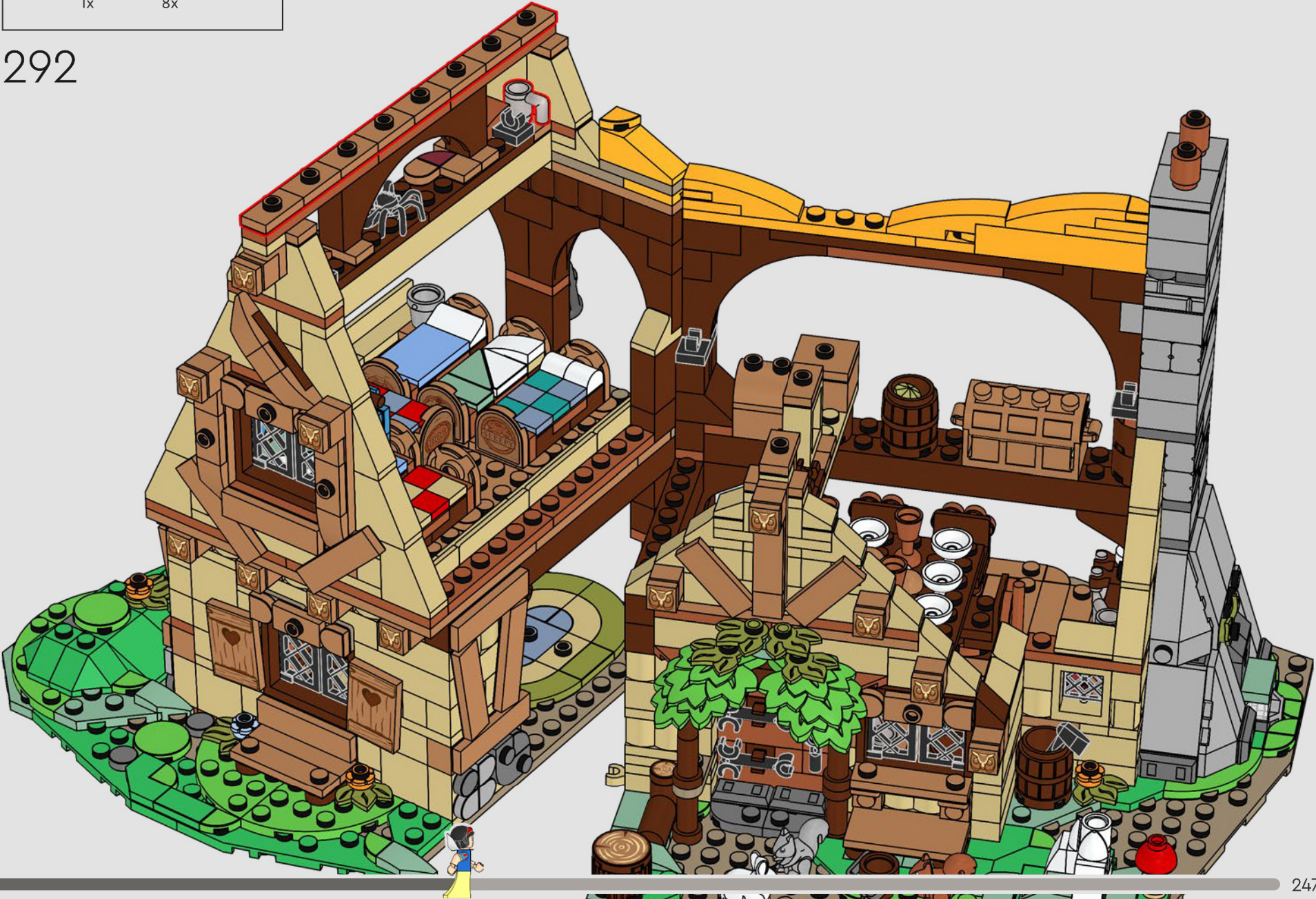





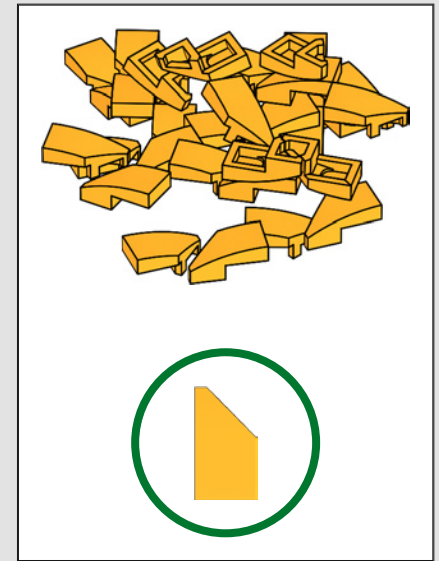
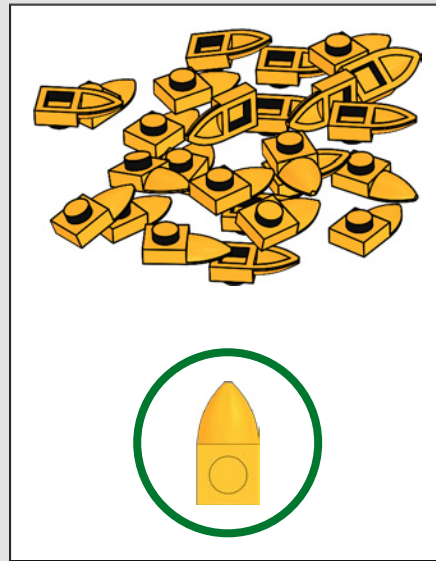
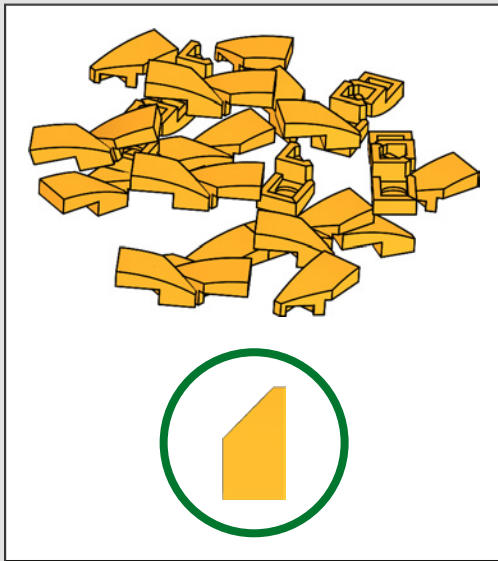

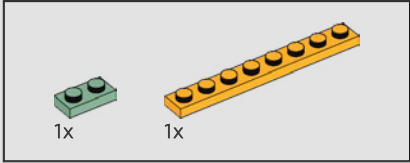
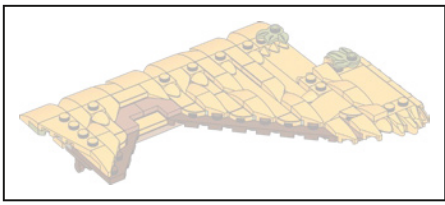

293

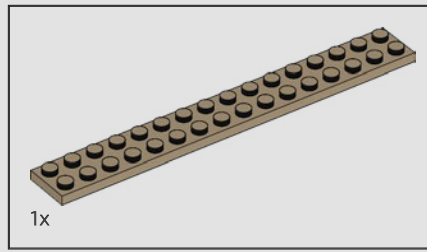
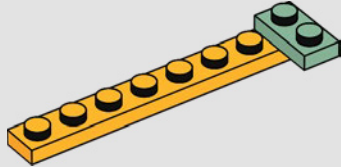

294

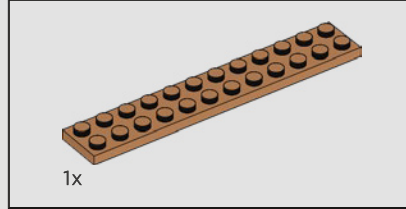
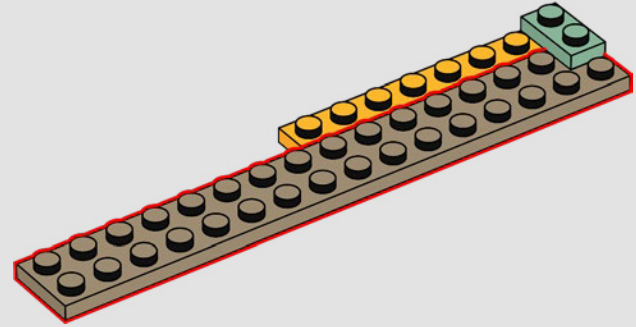

295

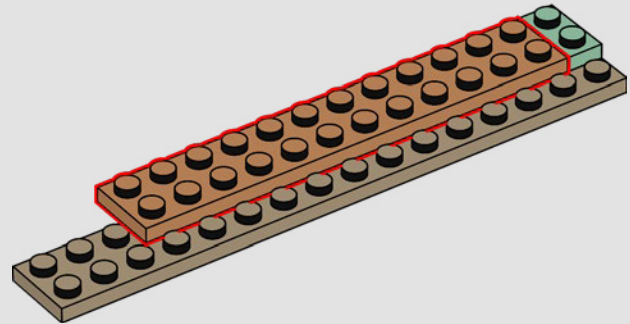

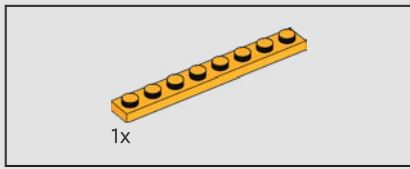

296

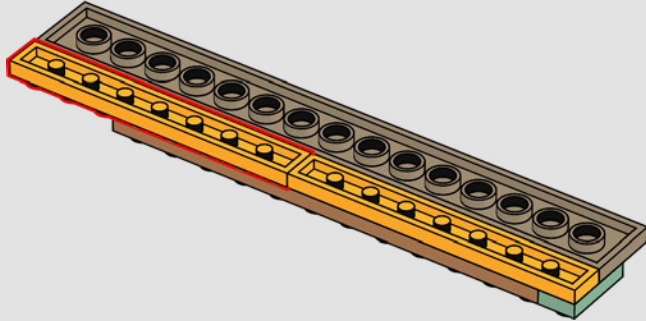

297

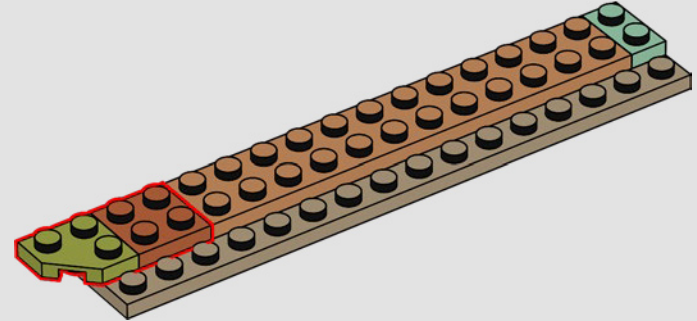
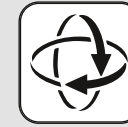

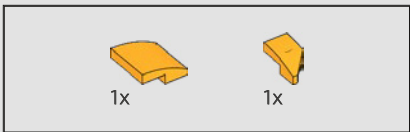

298

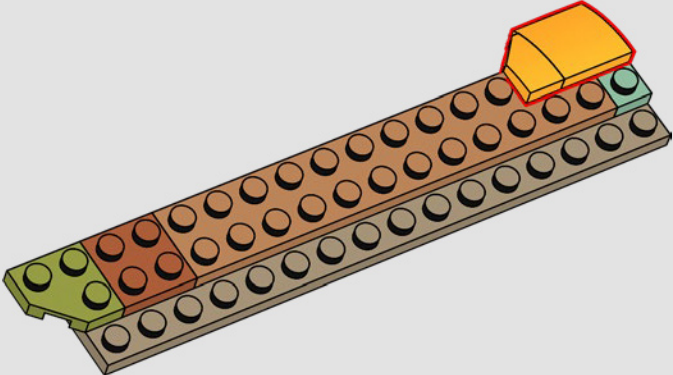

299

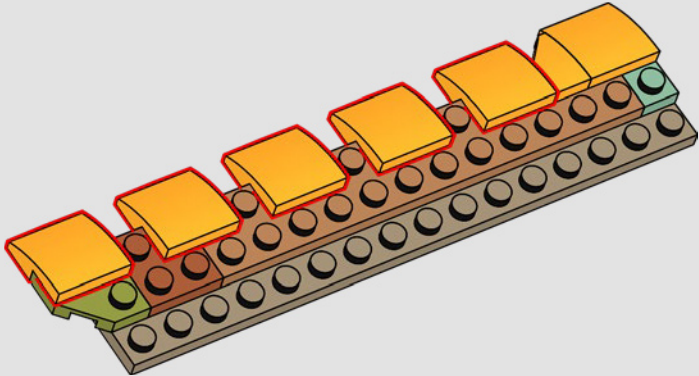

300

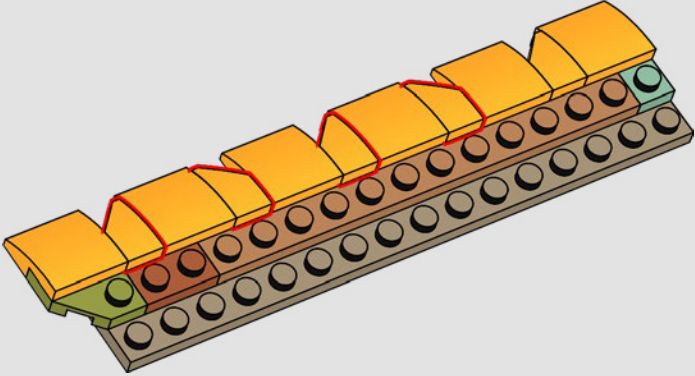

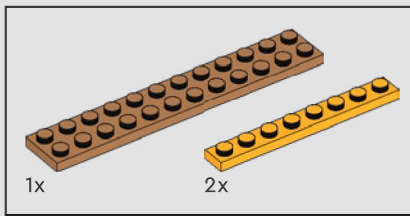

301

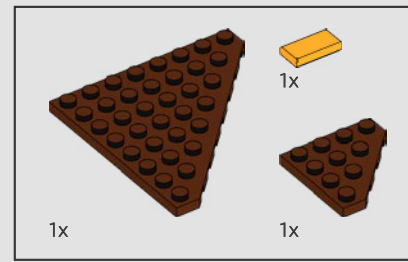
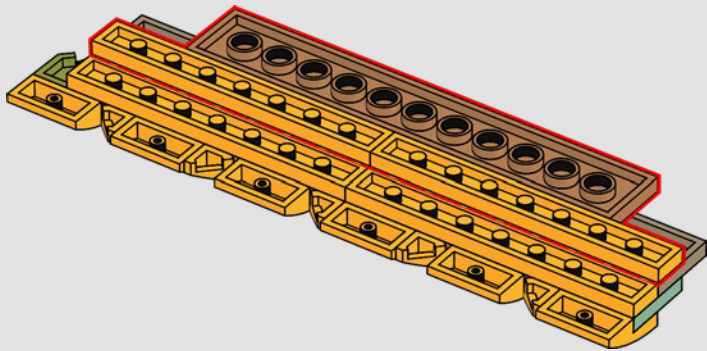

302

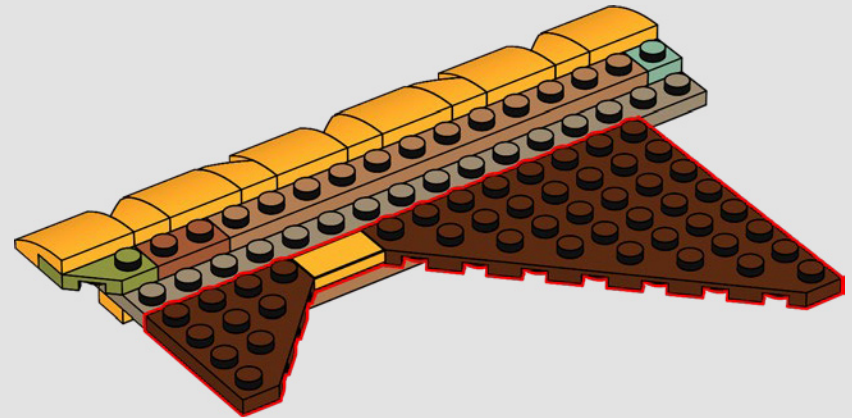



1x

# 303

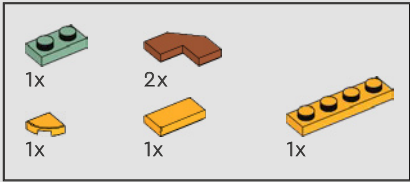
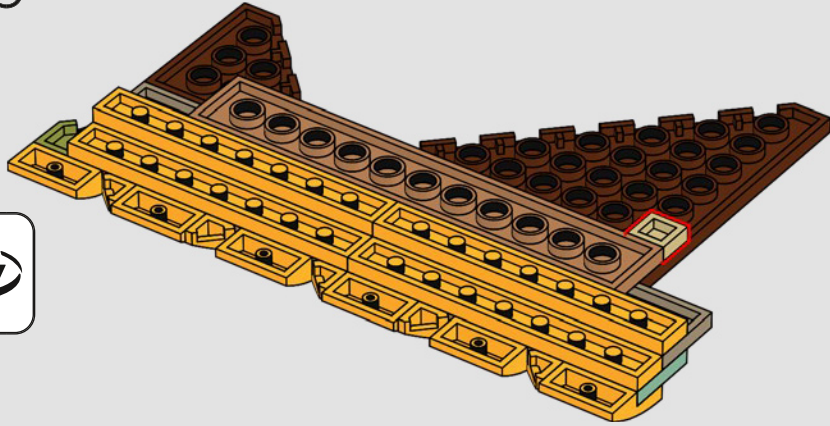

# 304

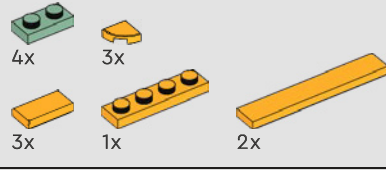
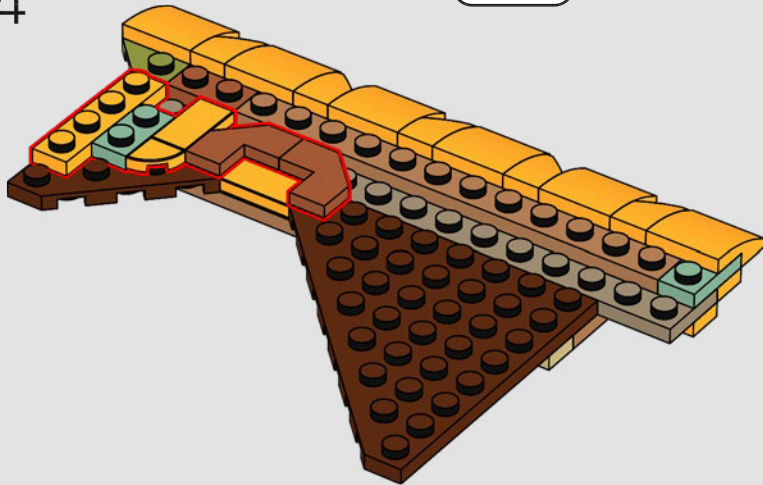

# 305

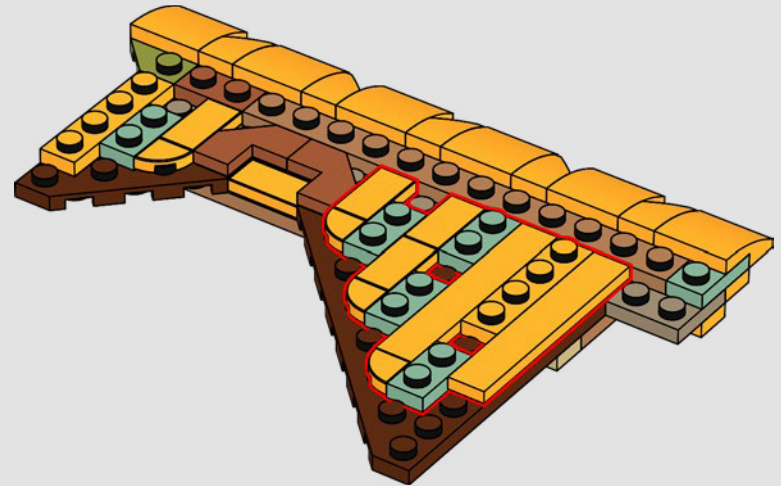

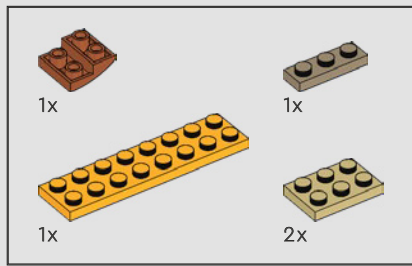

306

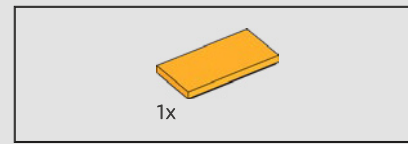
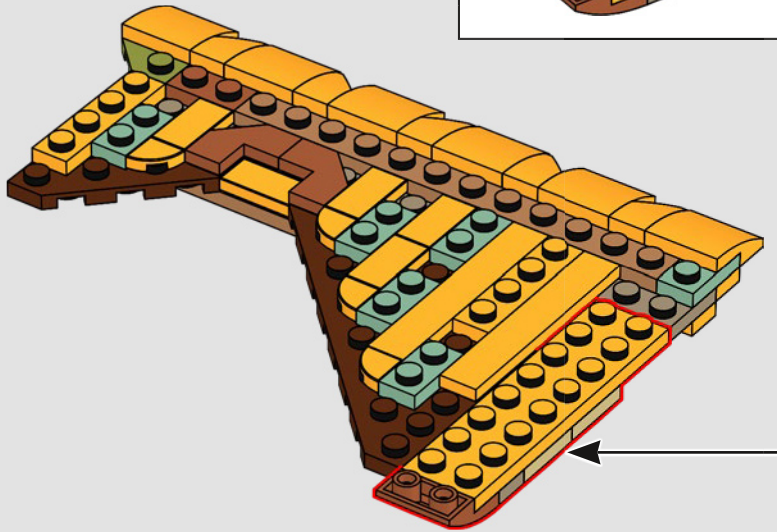
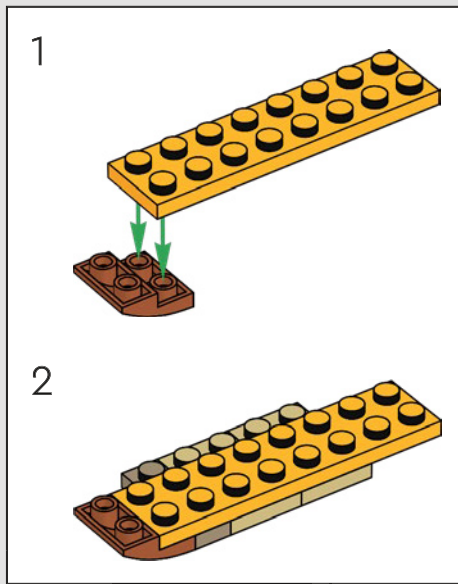

307

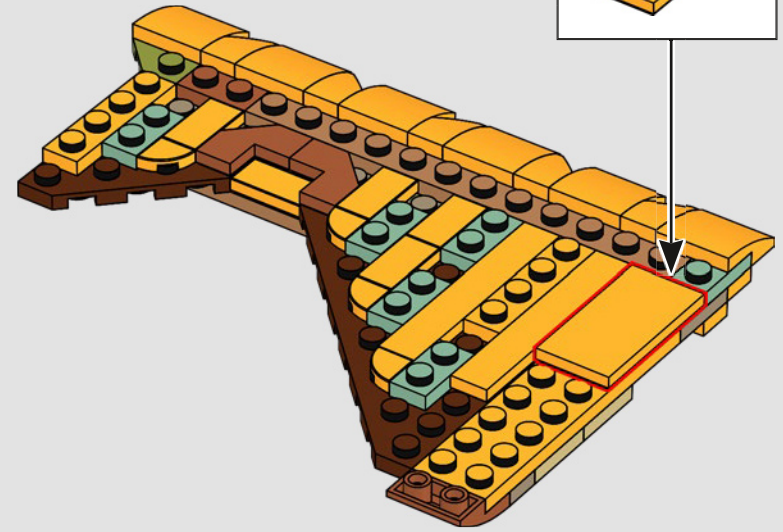
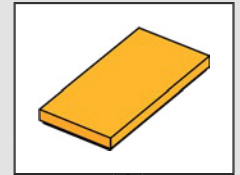

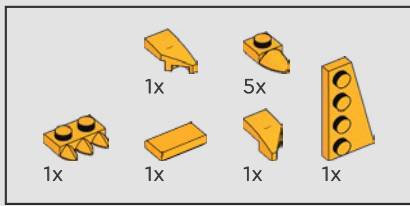

308

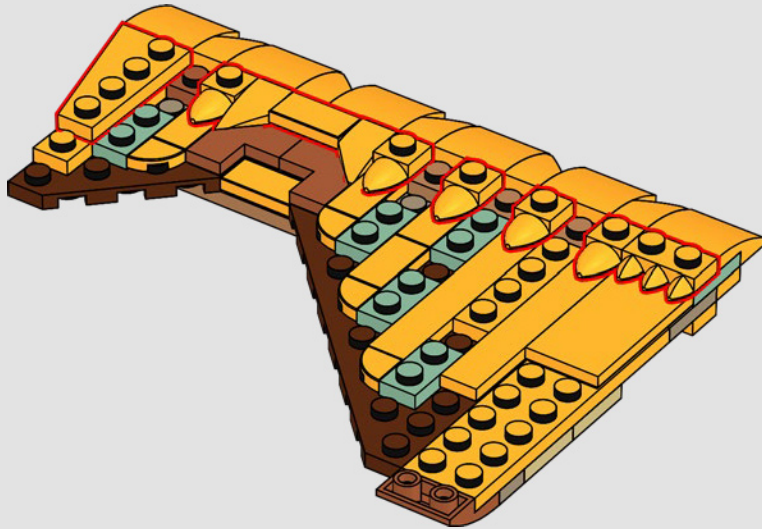

309

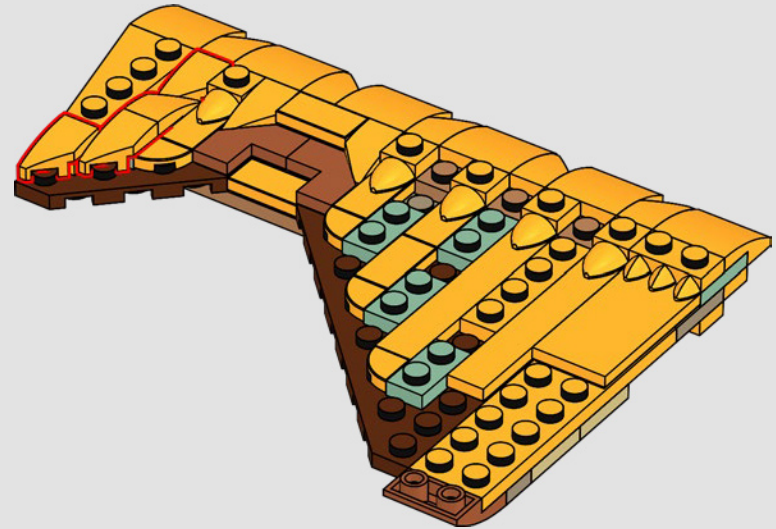





310

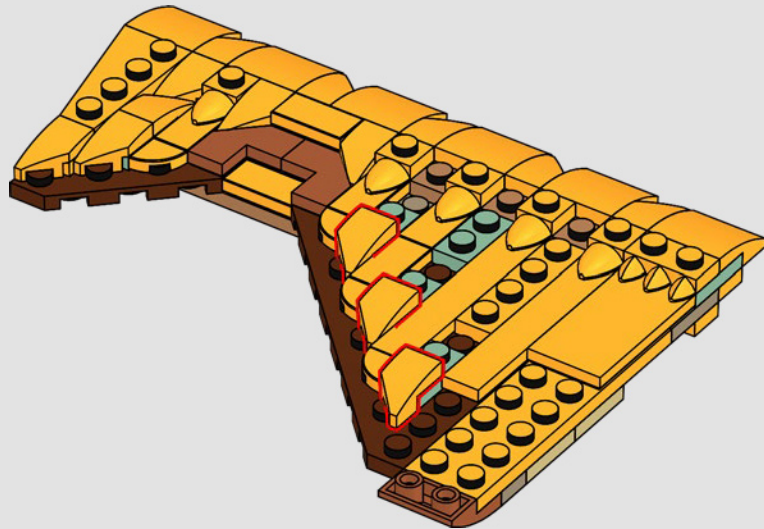

311

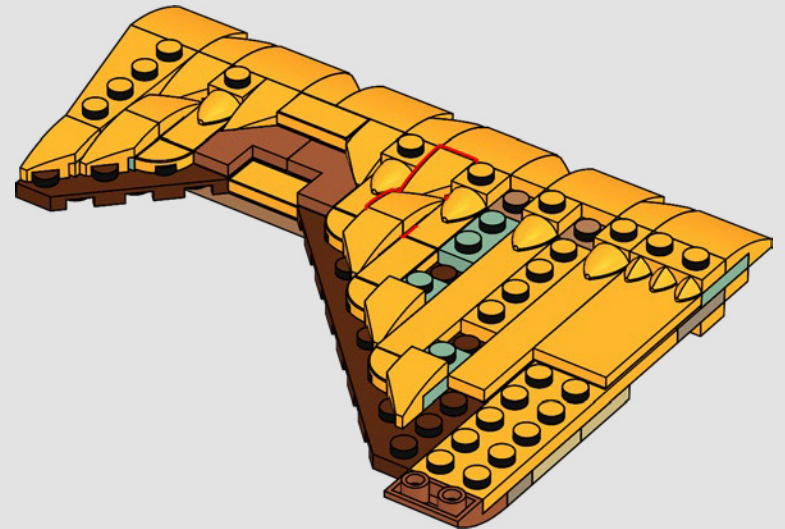

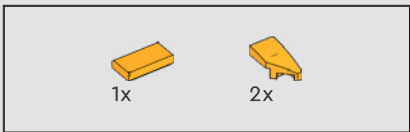

312

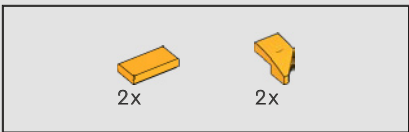
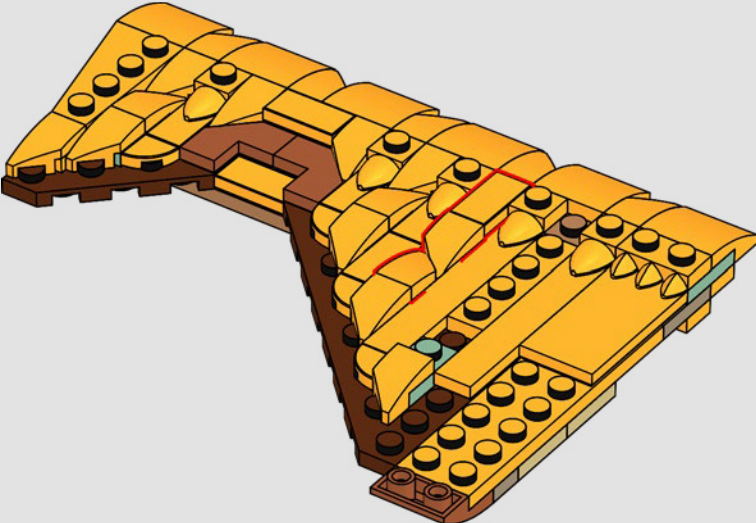

313

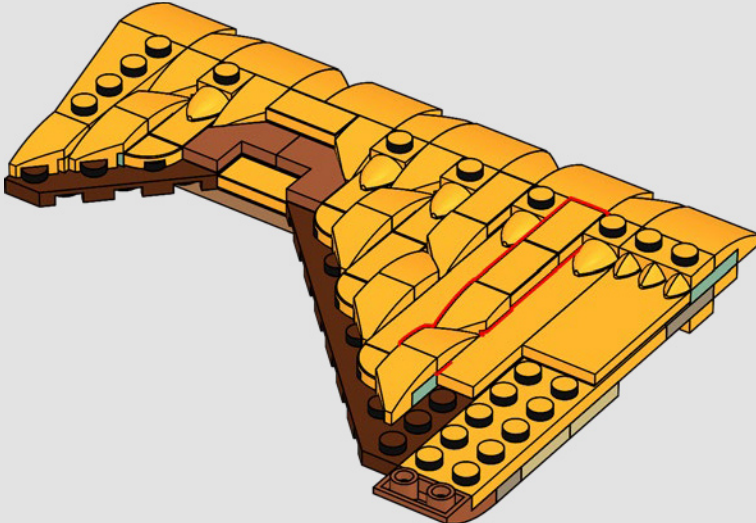

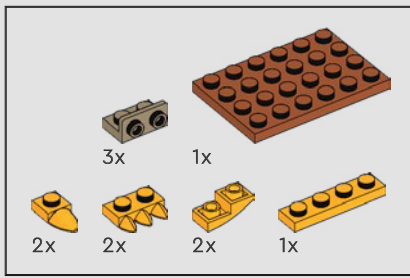

314

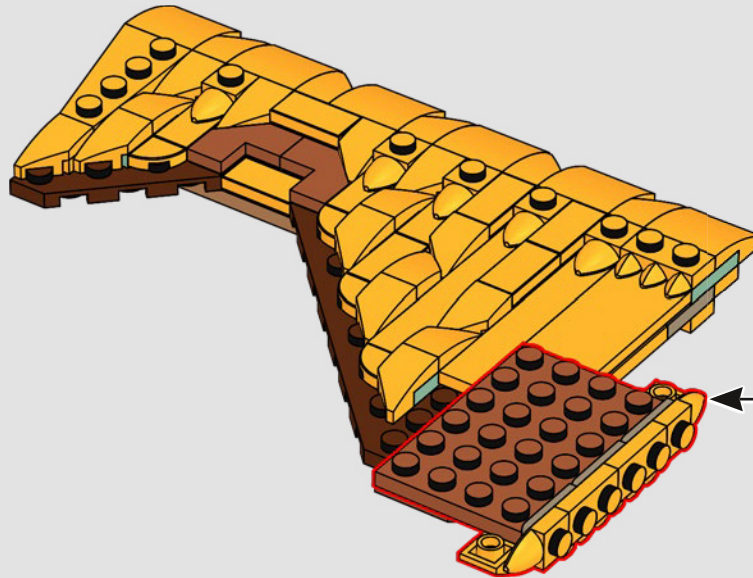
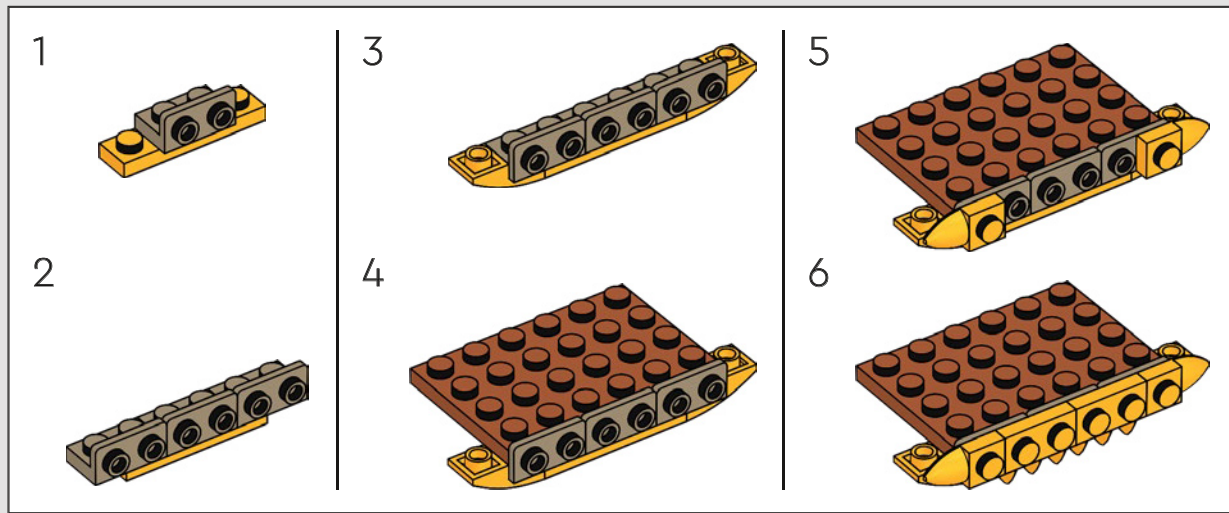

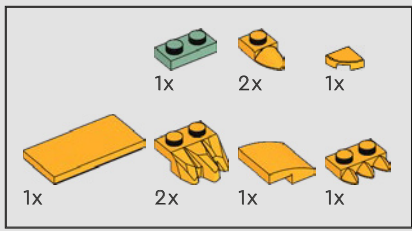

315

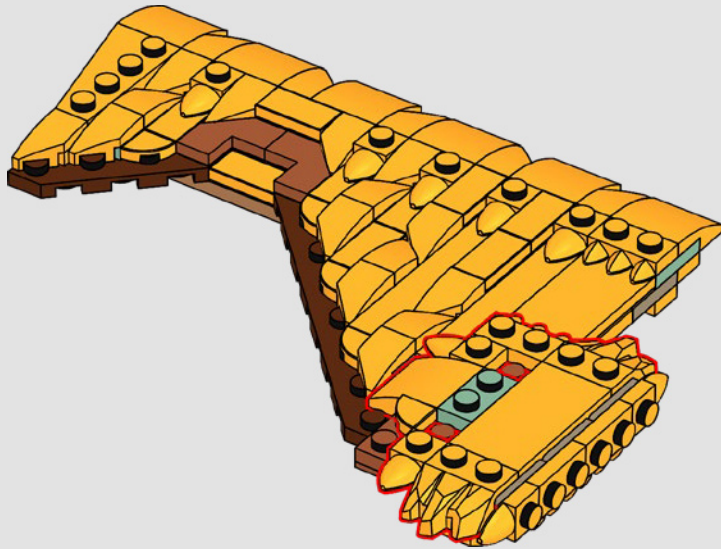

316

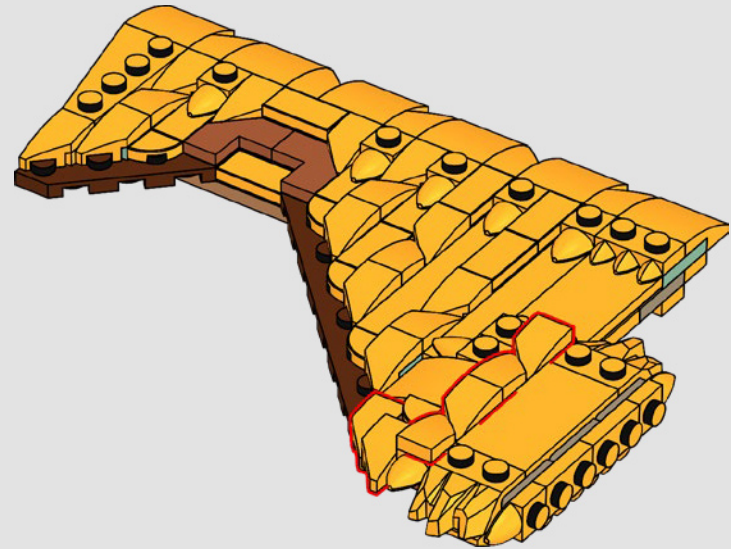

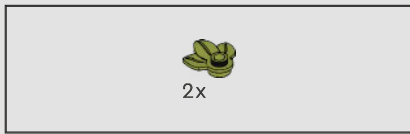

317

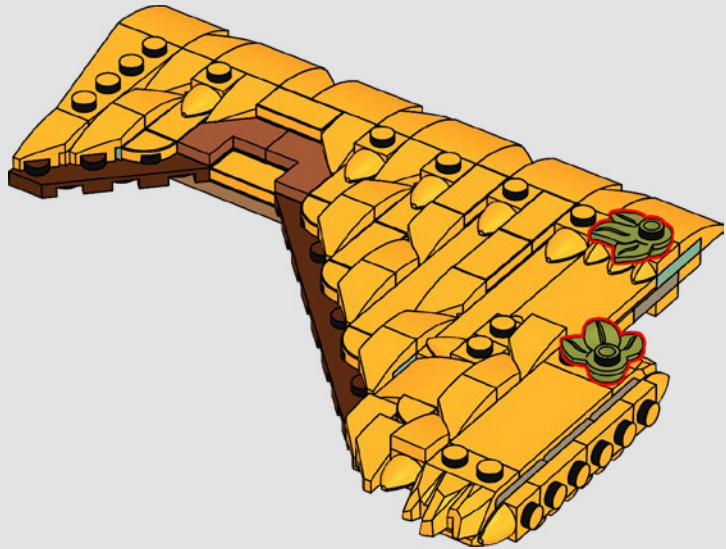

318

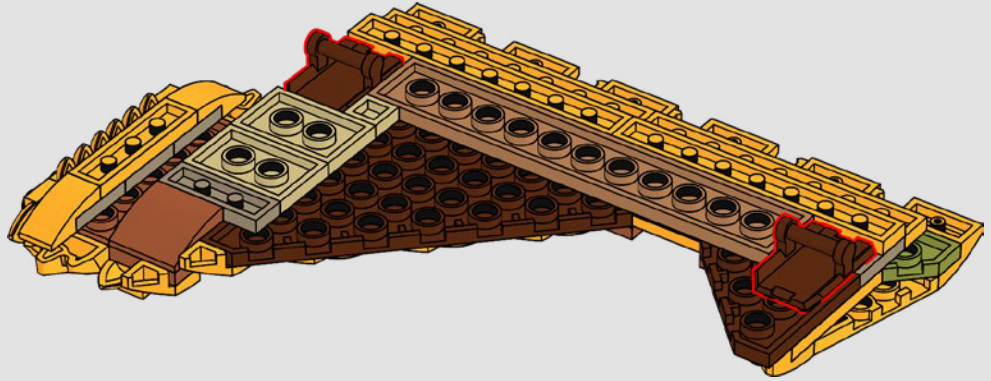



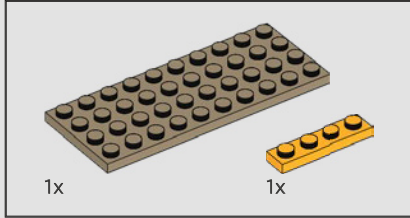
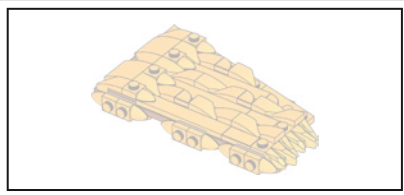

320

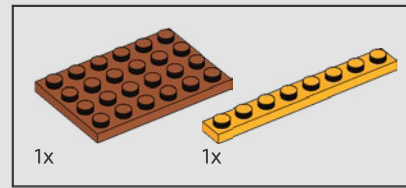
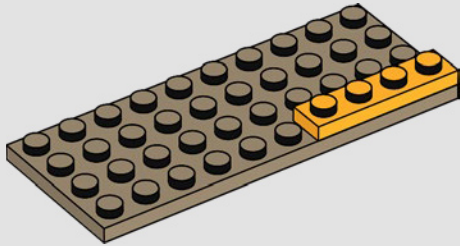

321

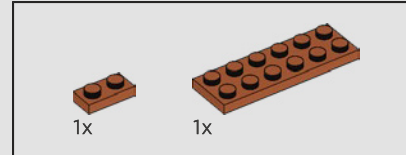
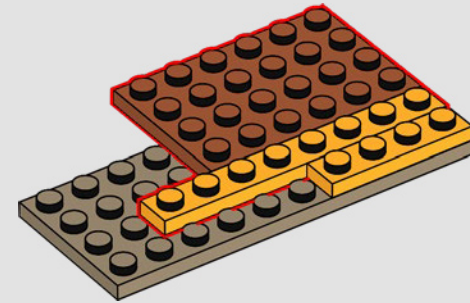

322

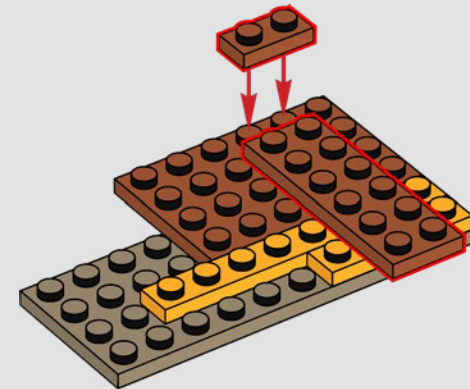

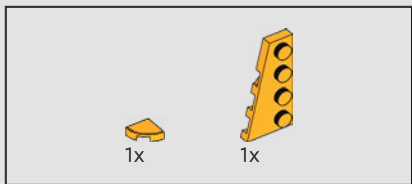

323

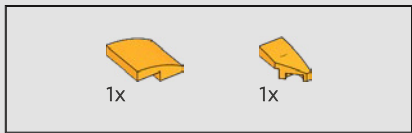
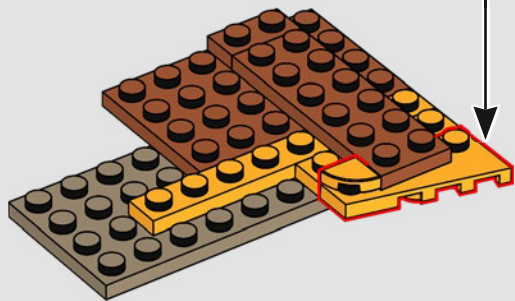
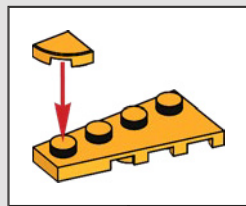

324

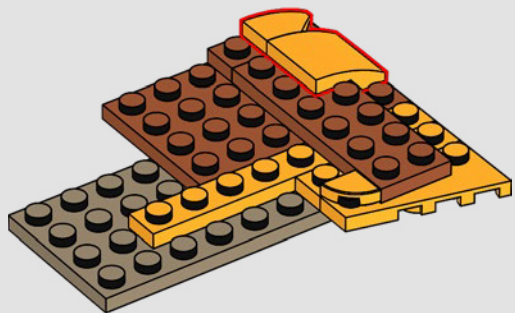

325

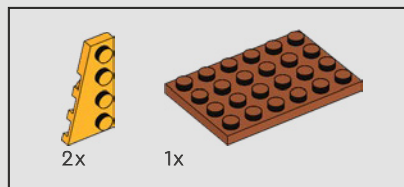
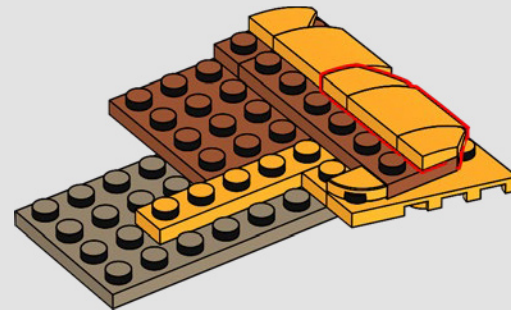

326

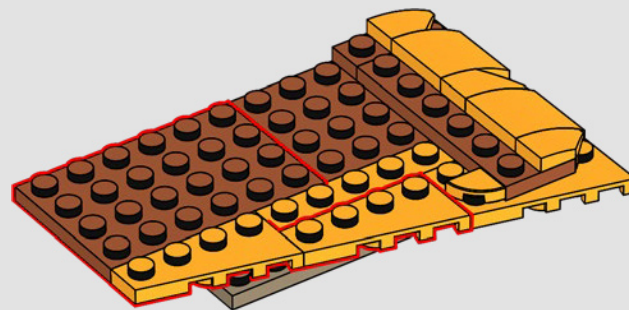





327

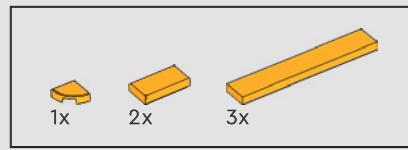
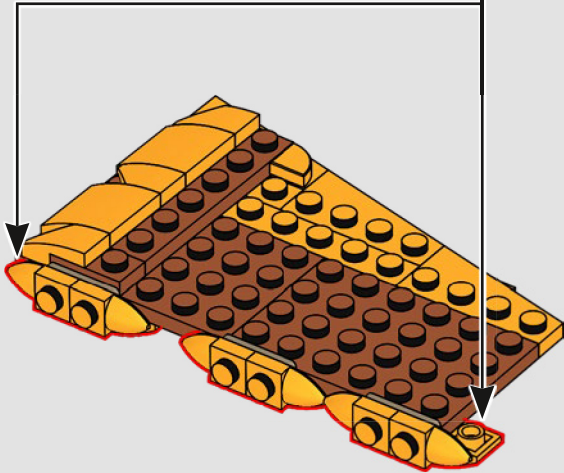
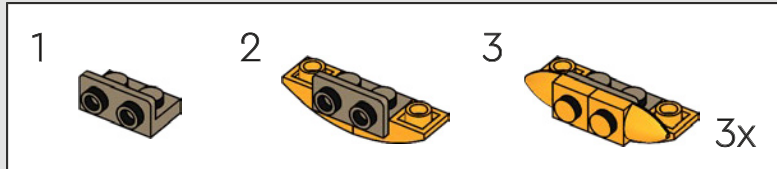

328

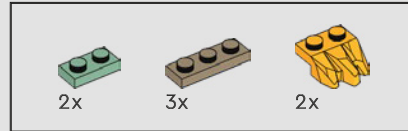
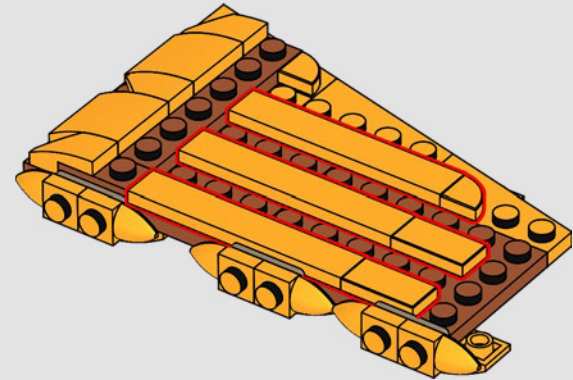

329

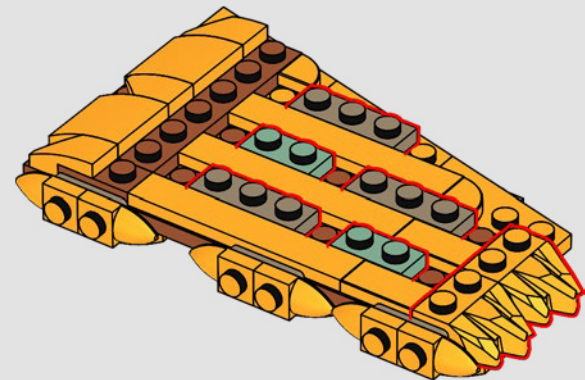



4x

330

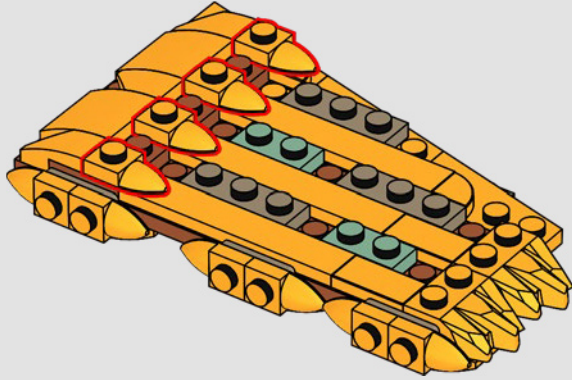

1x



3x

331

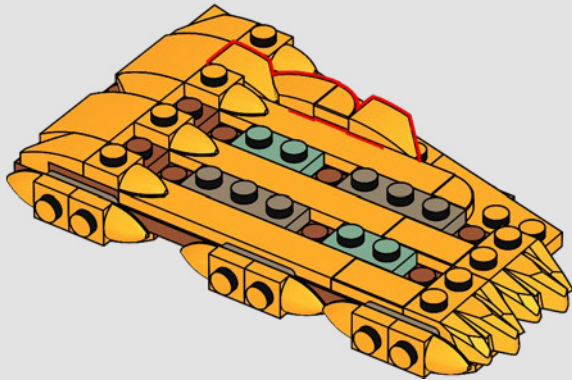

1x



6x

332

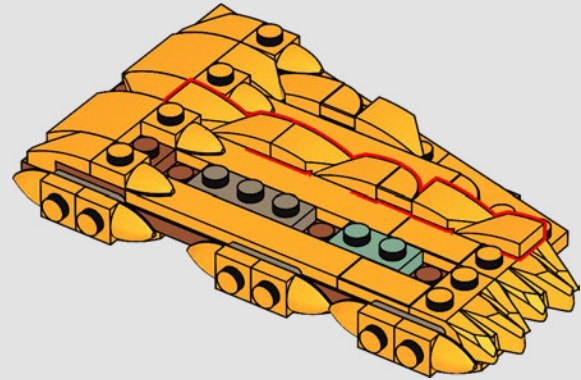

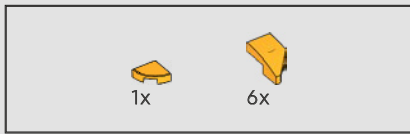

333

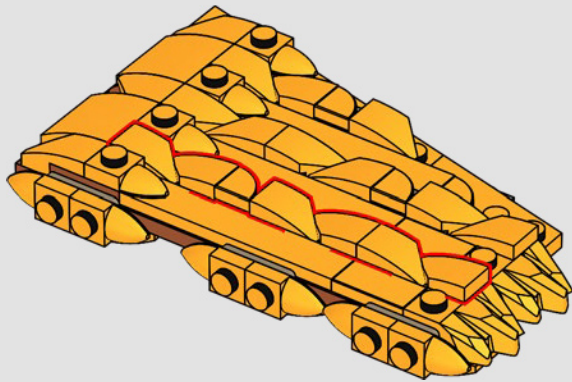

334

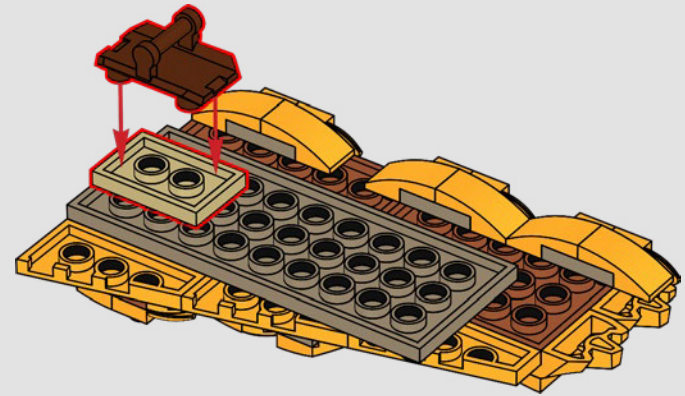

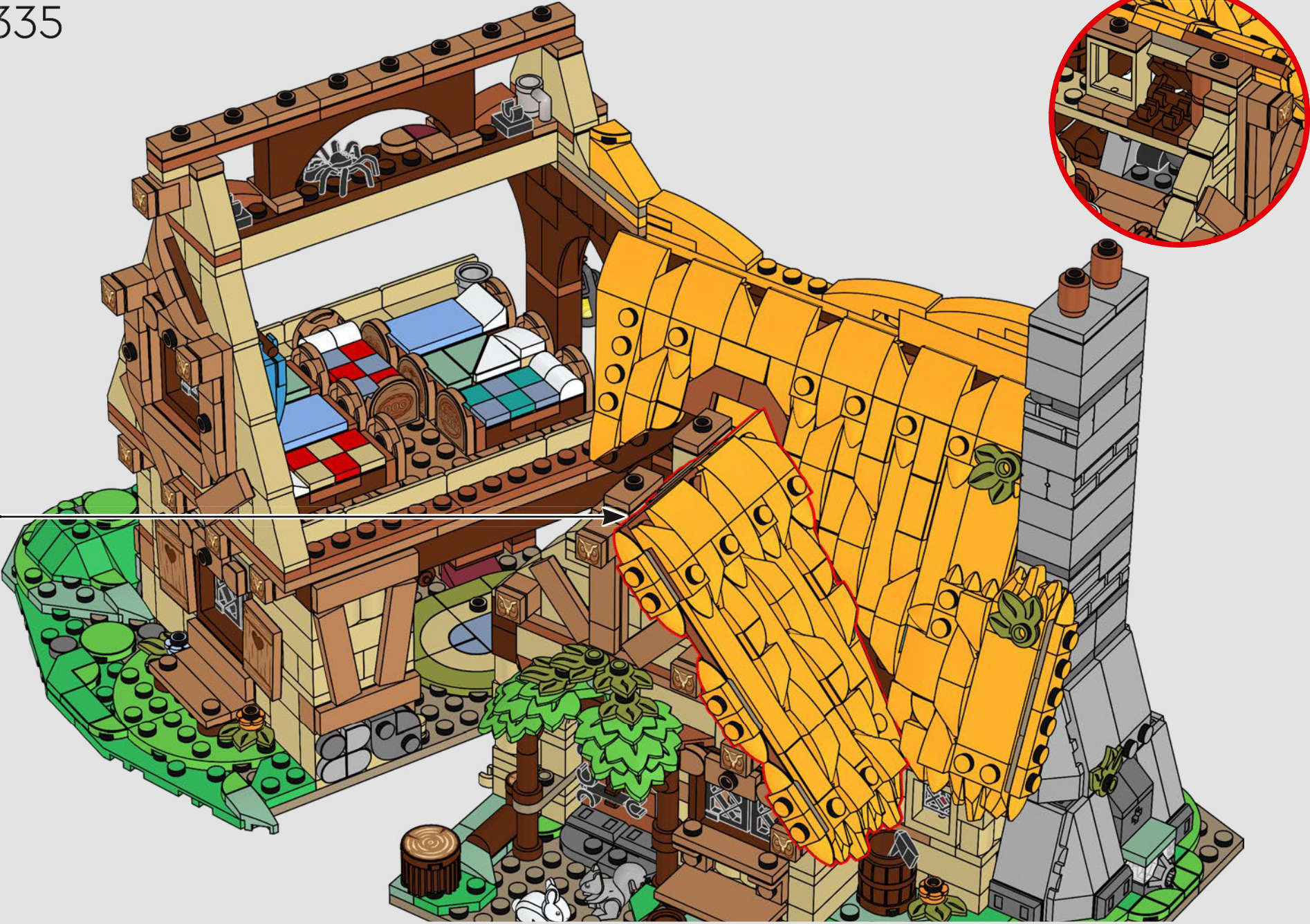

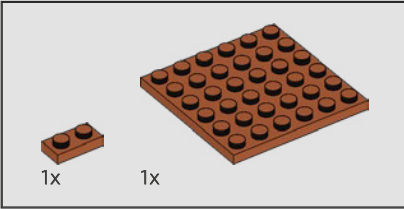
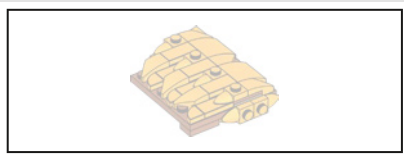

336

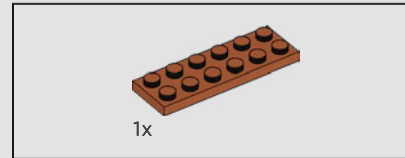
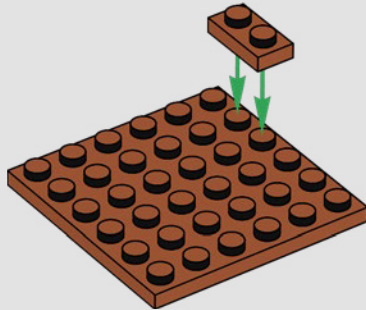

337

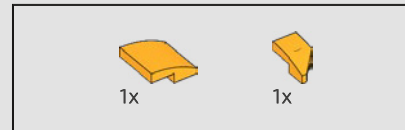
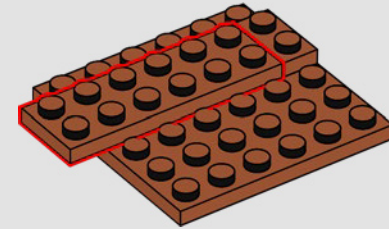

338

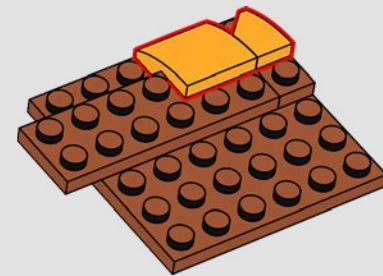



339

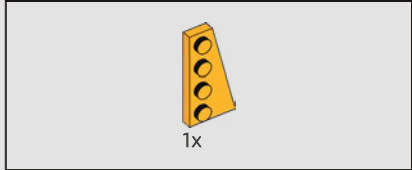
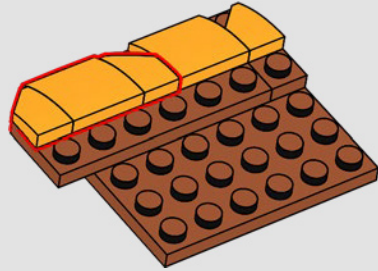

340

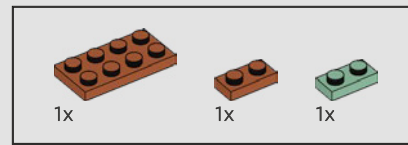
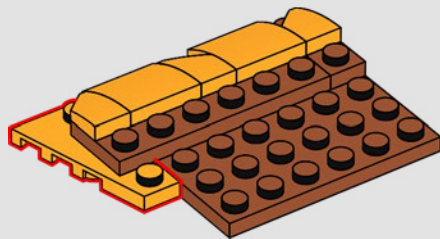

341

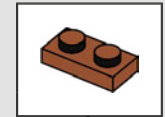
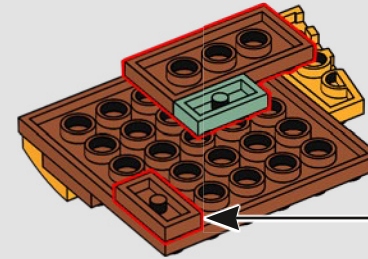

342

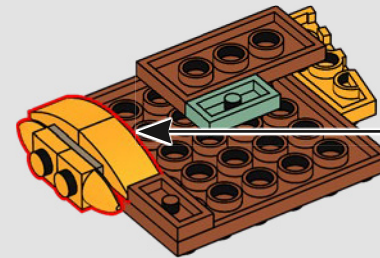
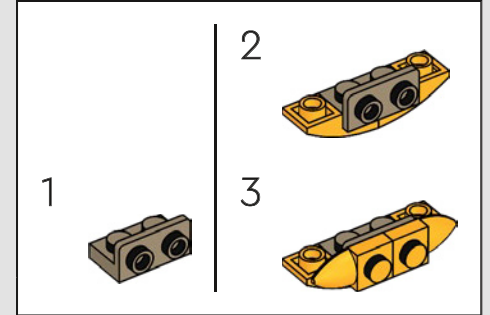

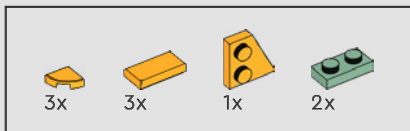

343

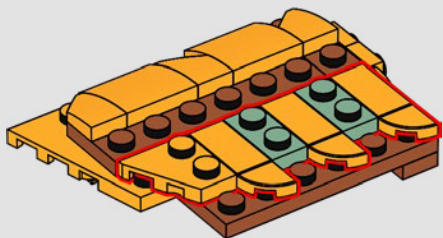

344

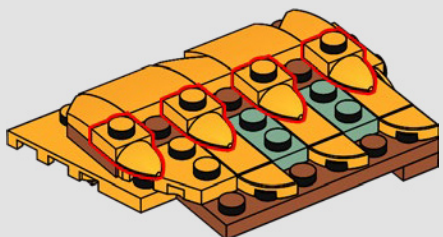

345

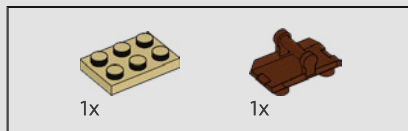
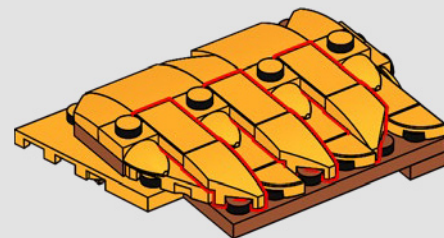

346

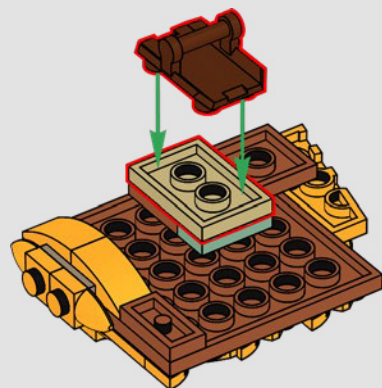





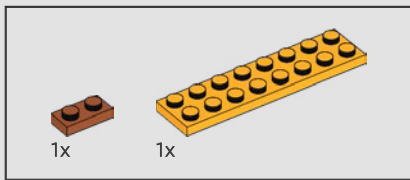

348

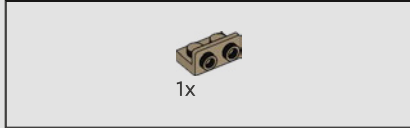
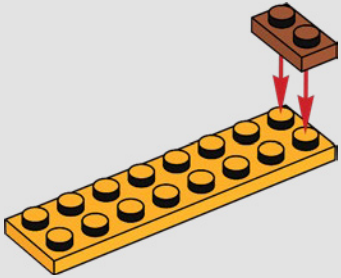

349

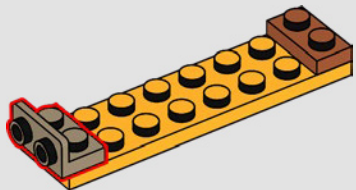

350

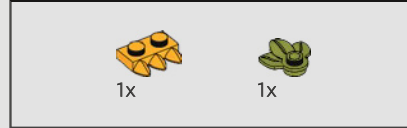
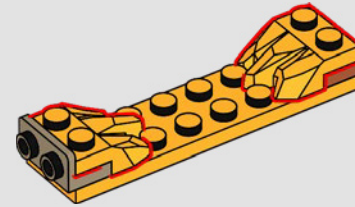

351

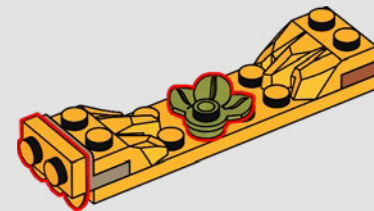



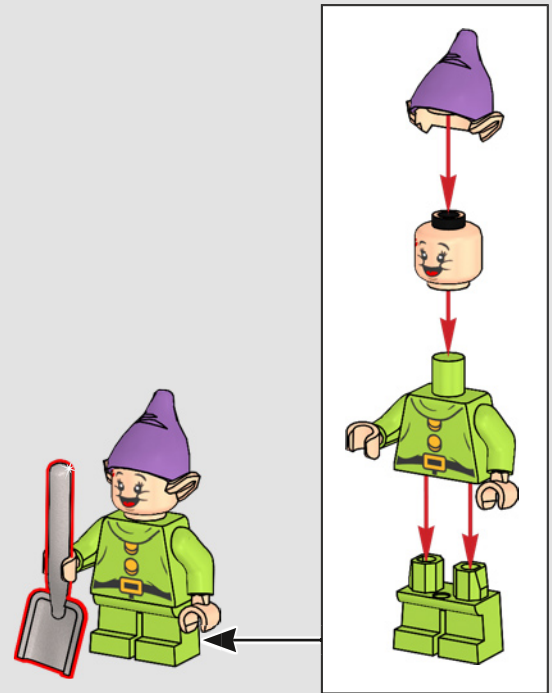

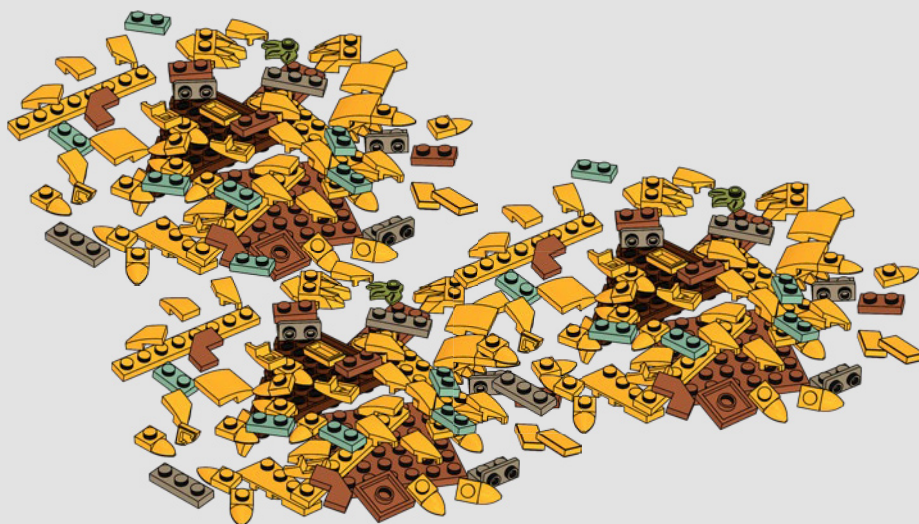

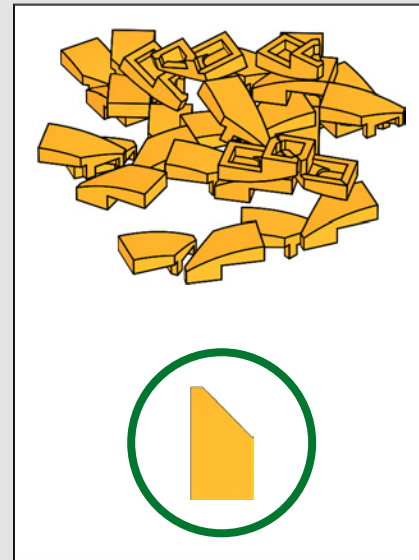
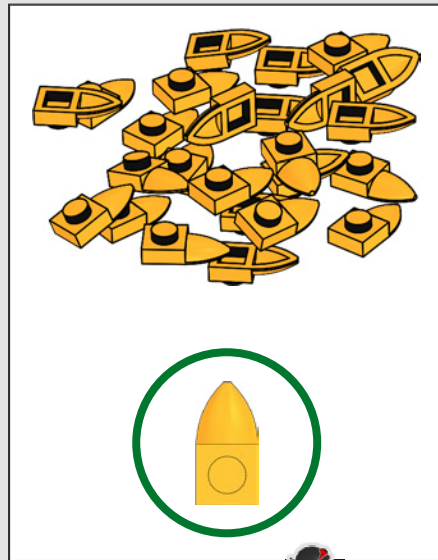
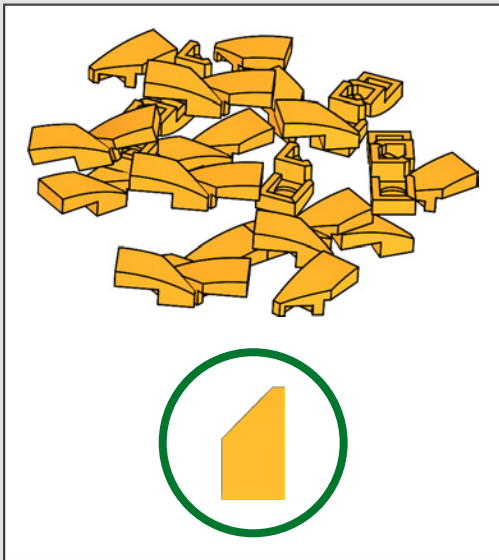

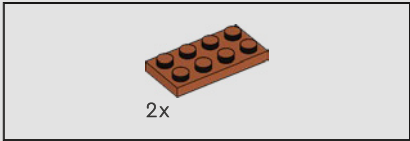
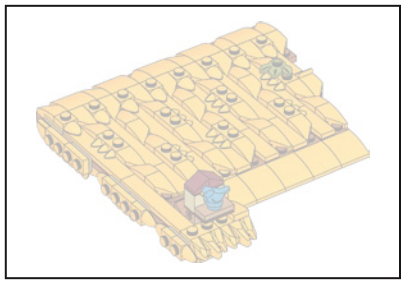

353

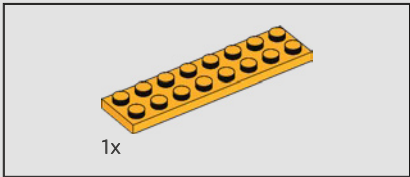
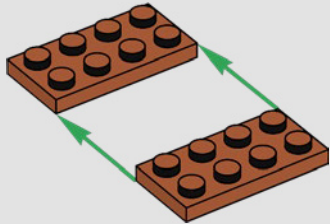

354

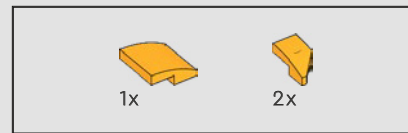
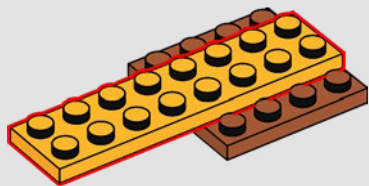

355

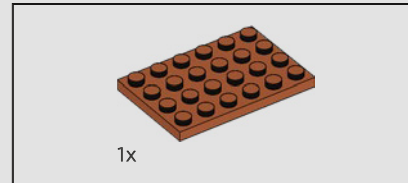
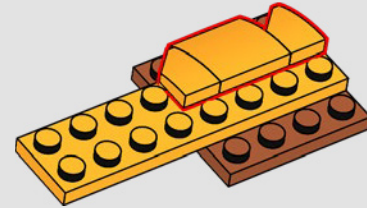

356

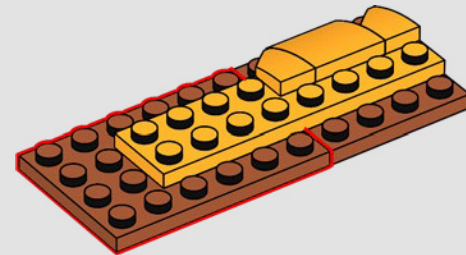

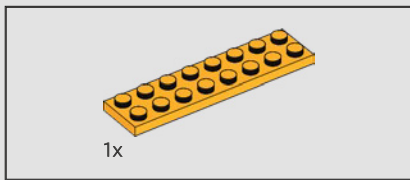

357

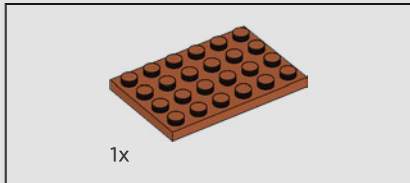
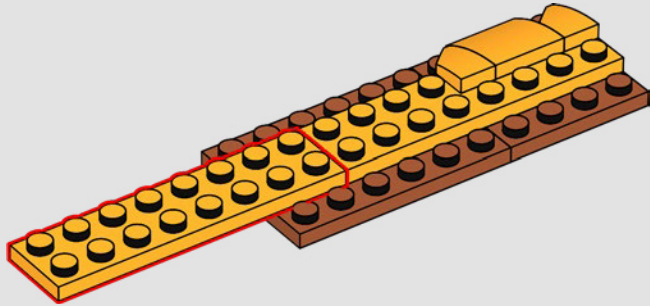

358

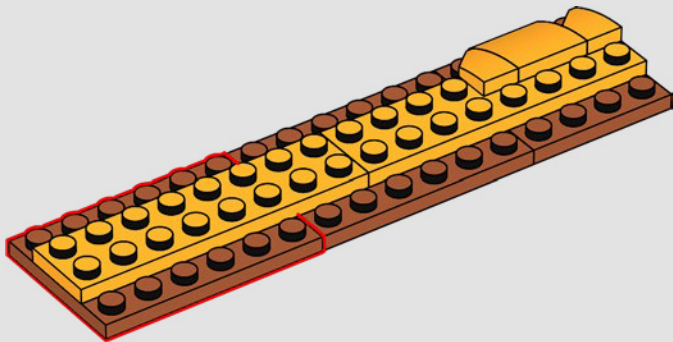

359

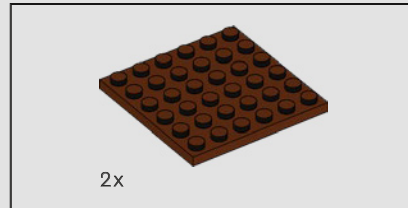
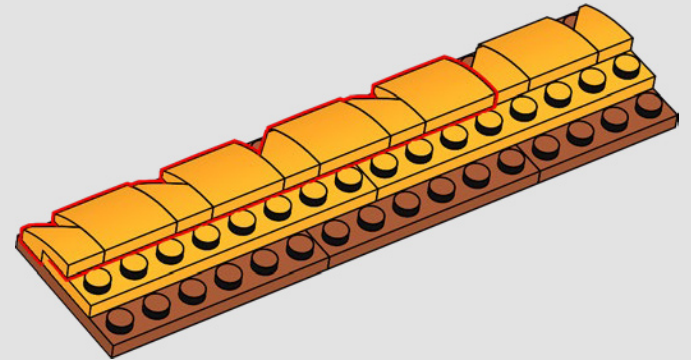

360

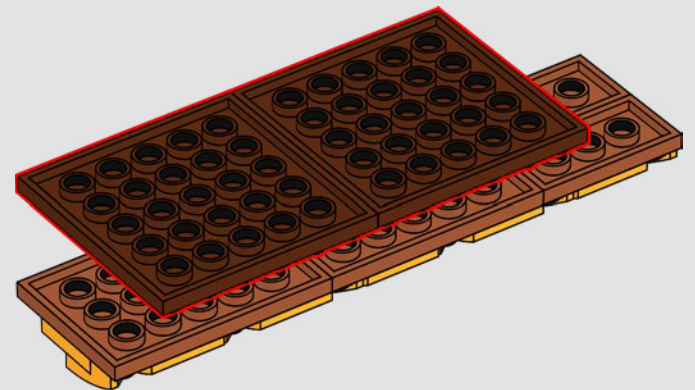

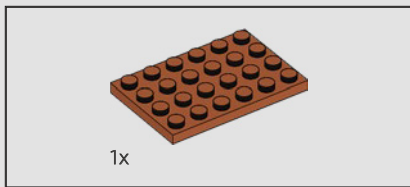

361

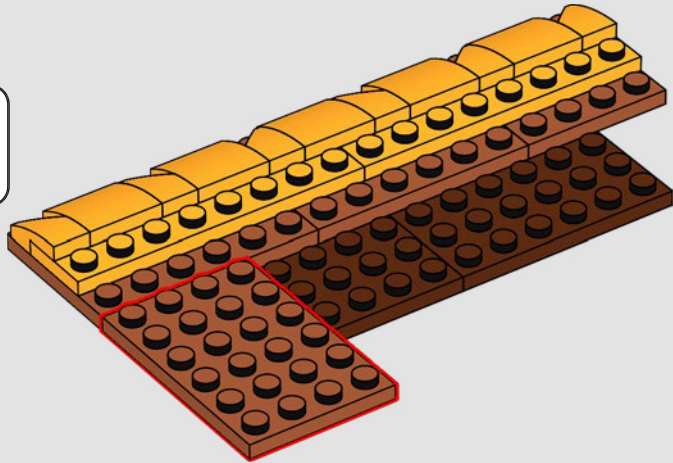

362

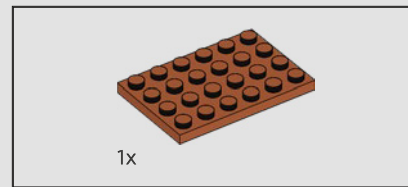
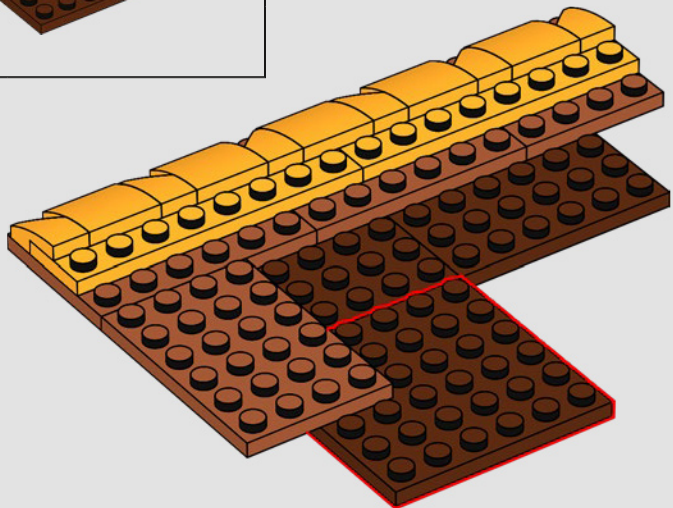

363

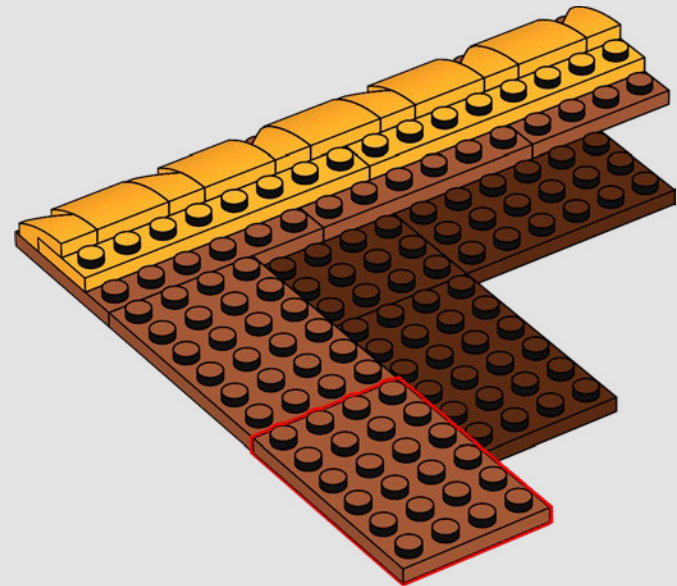



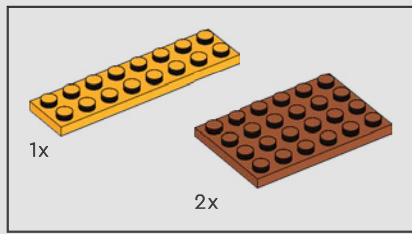

364

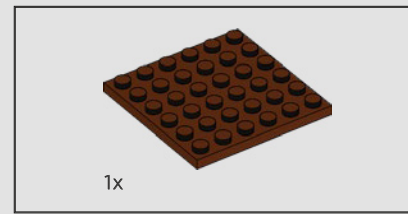
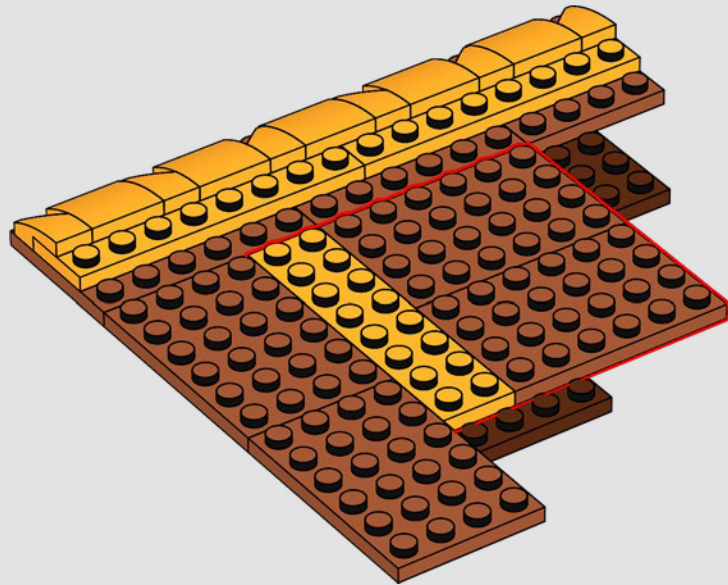

365

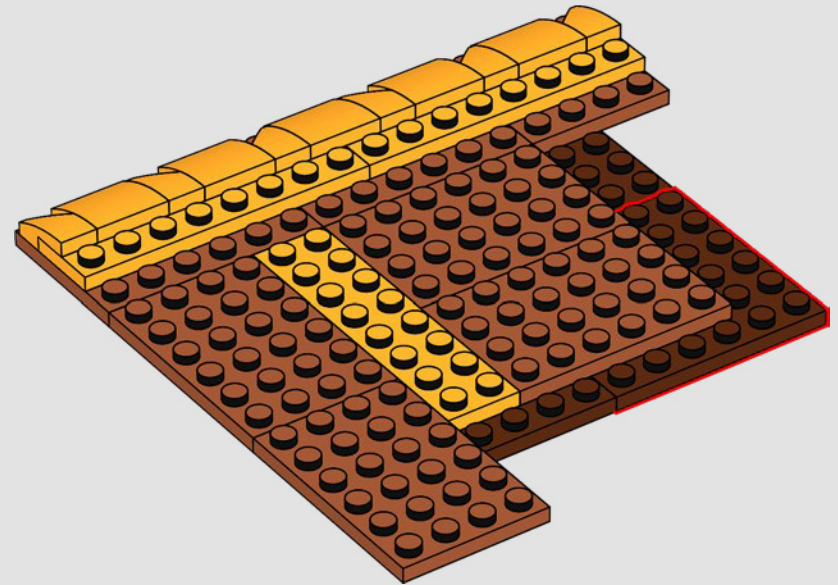

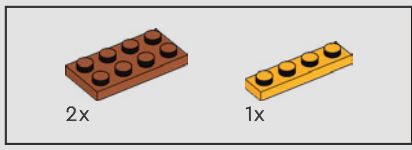

366

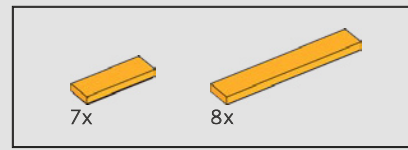
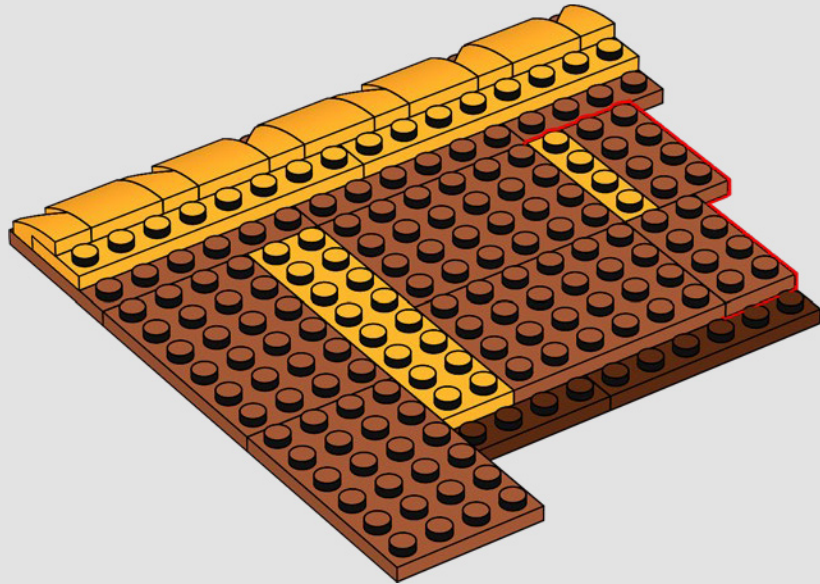

367

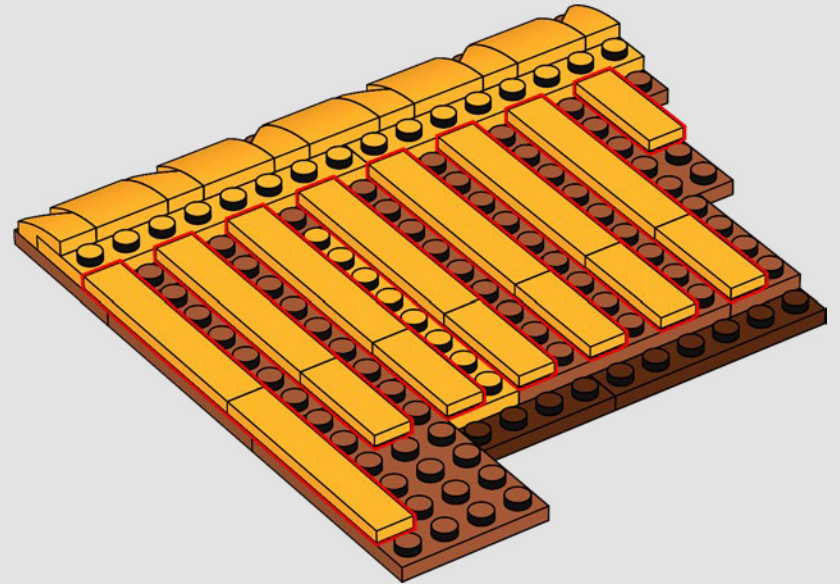

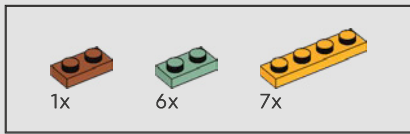

368

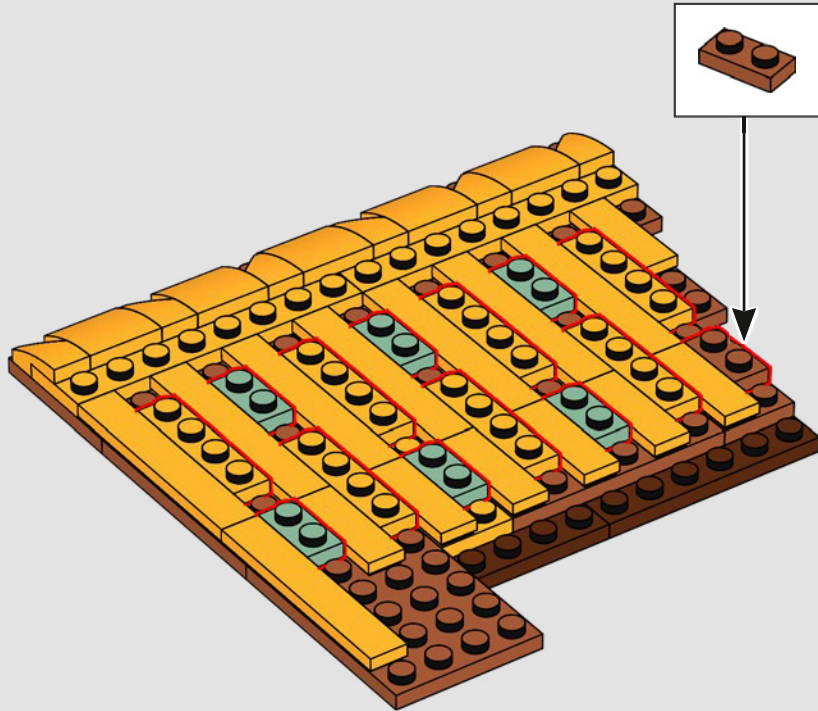

369

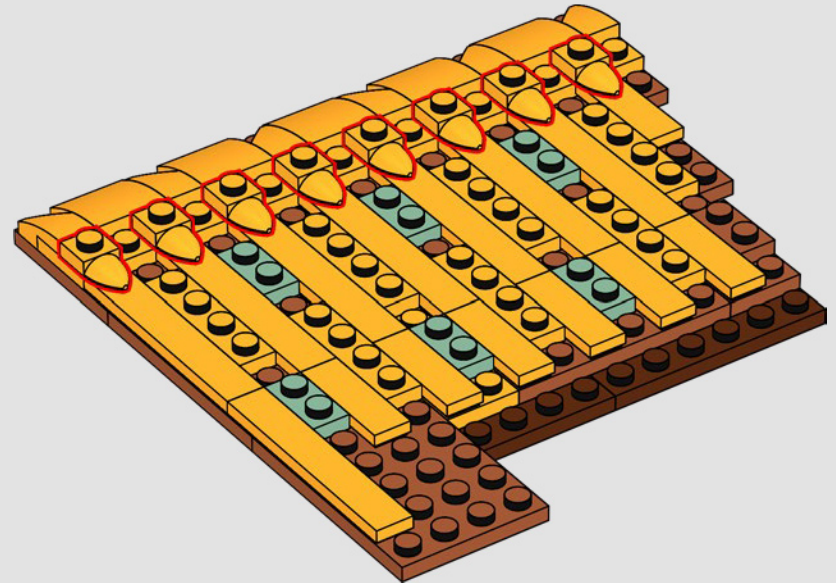



370

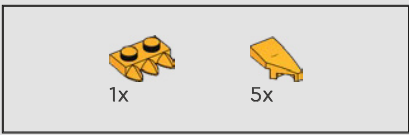
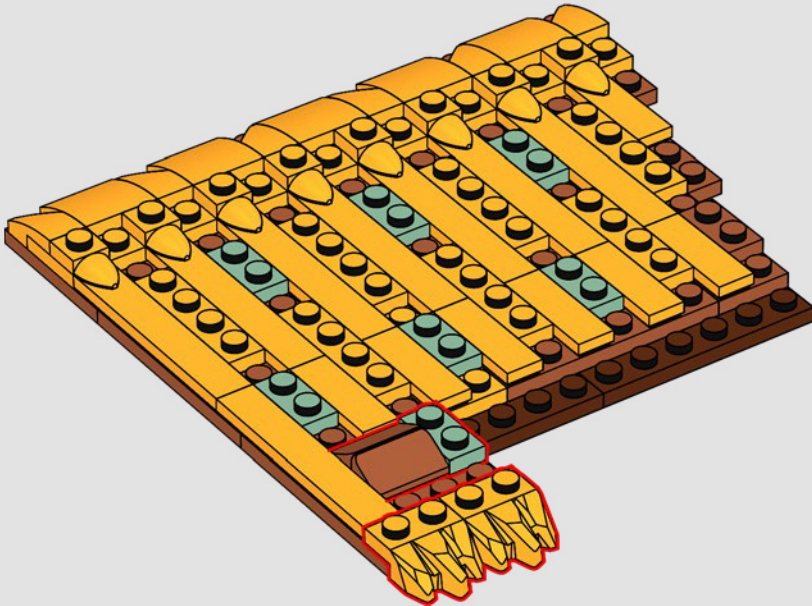

371

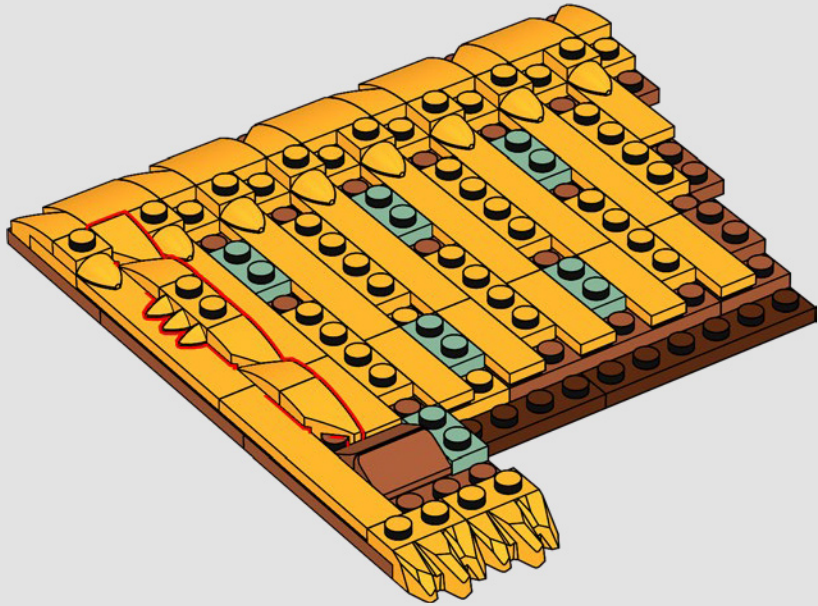



372

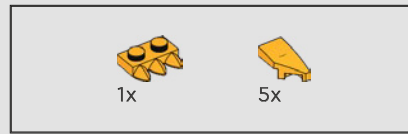
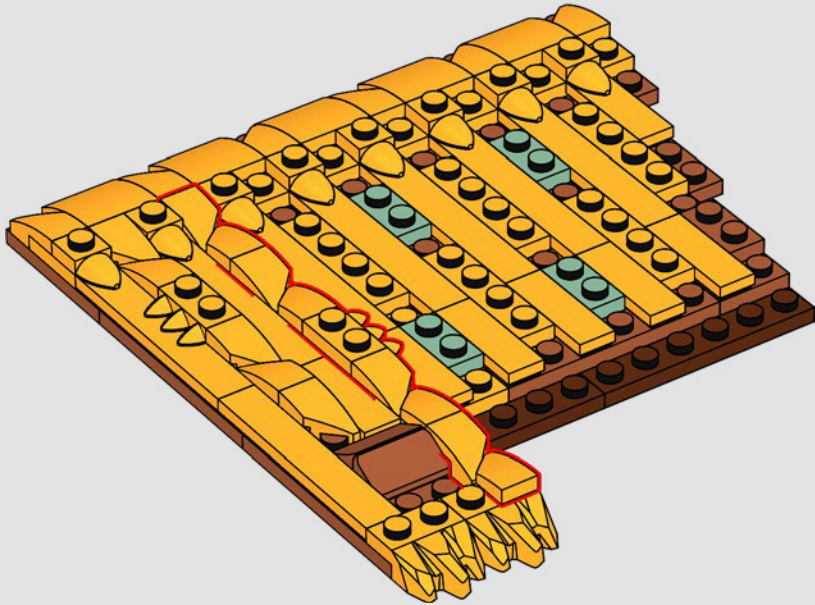

373

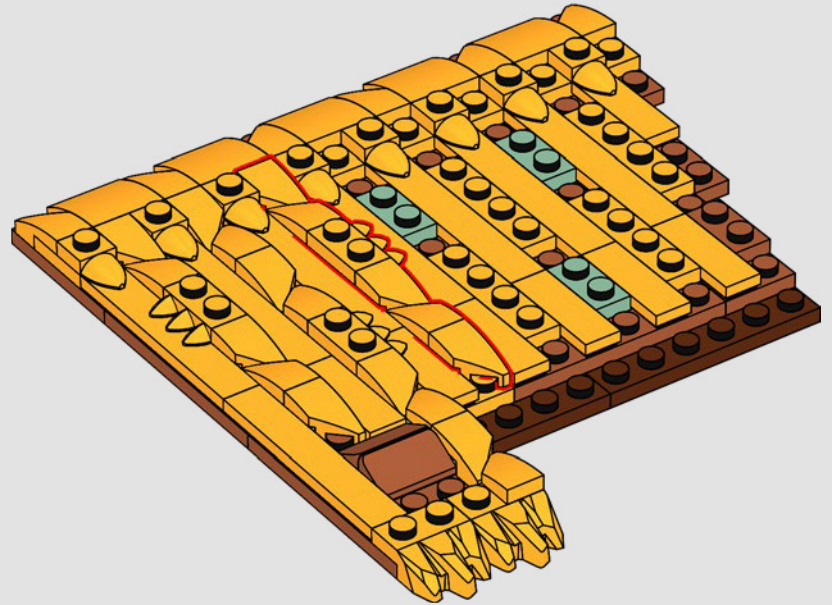



374

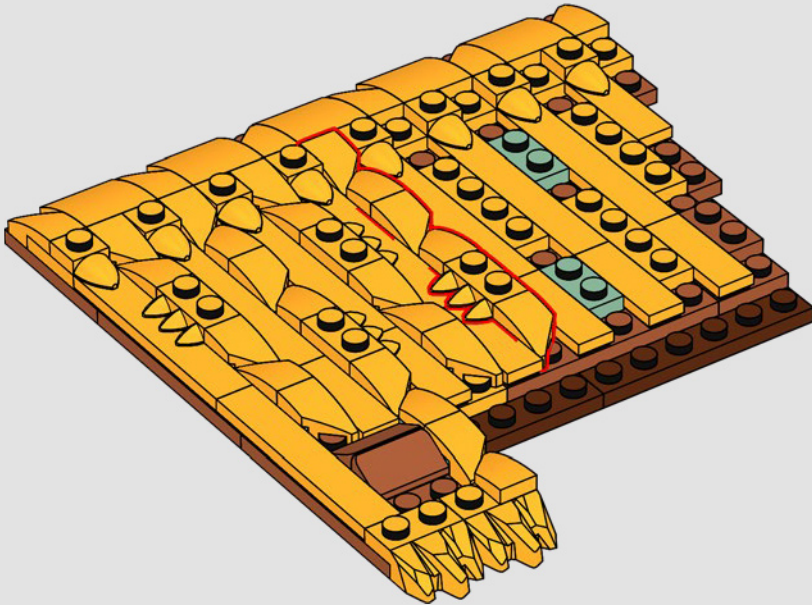

375

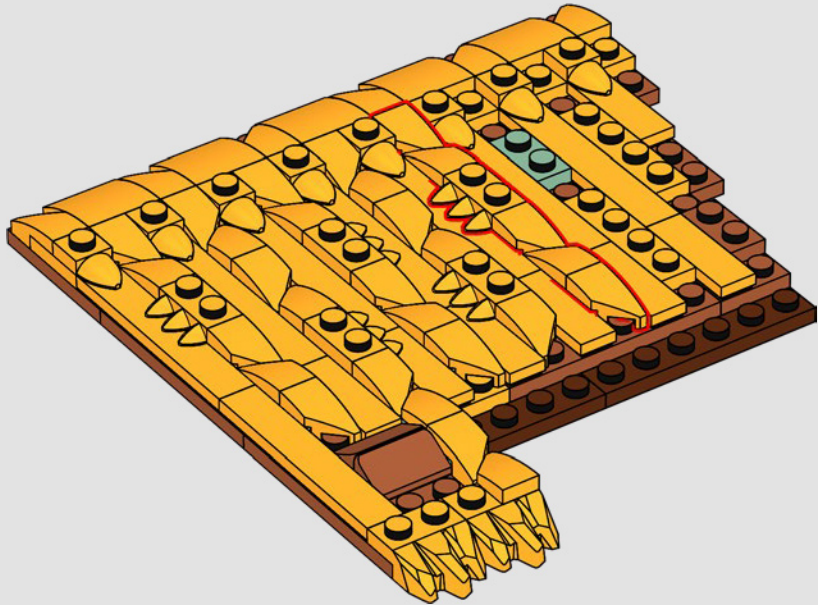



376

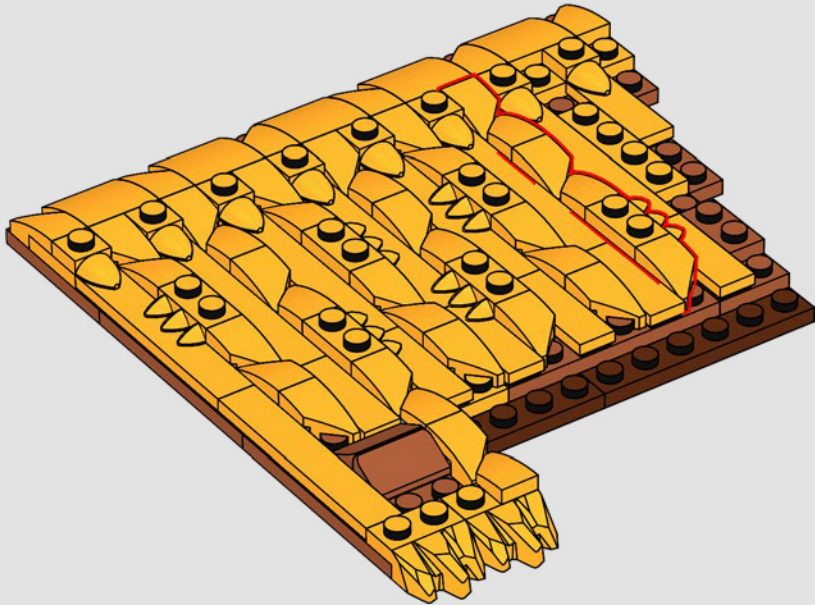

377

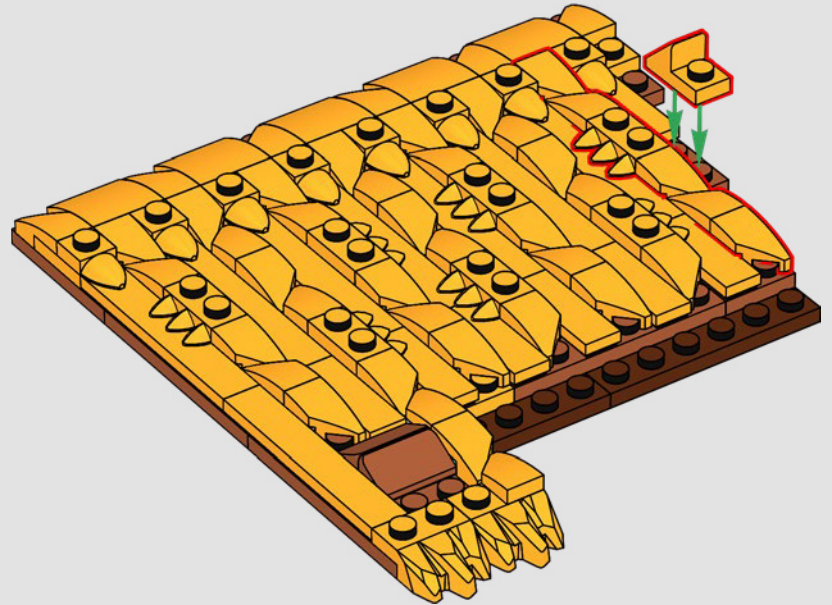



2x

378

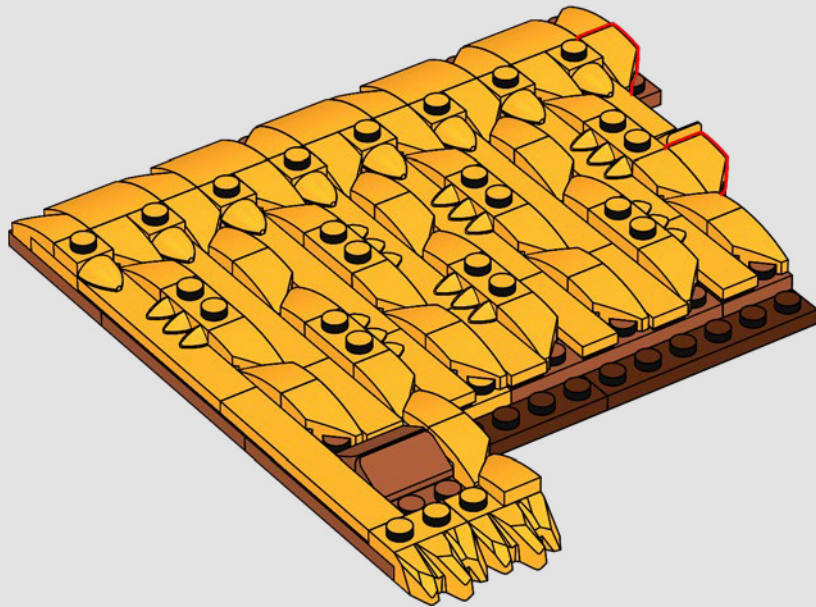

5x

379

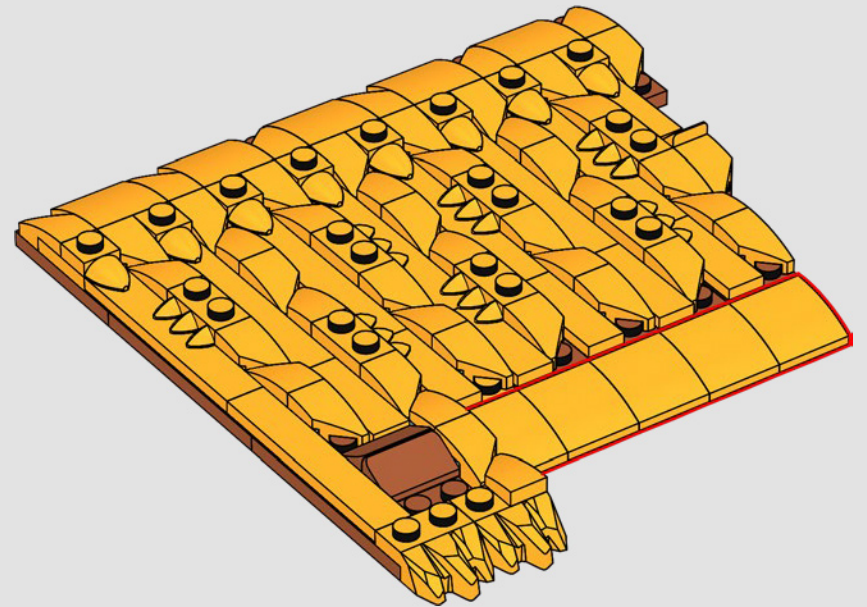



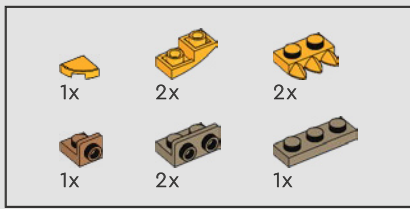

380

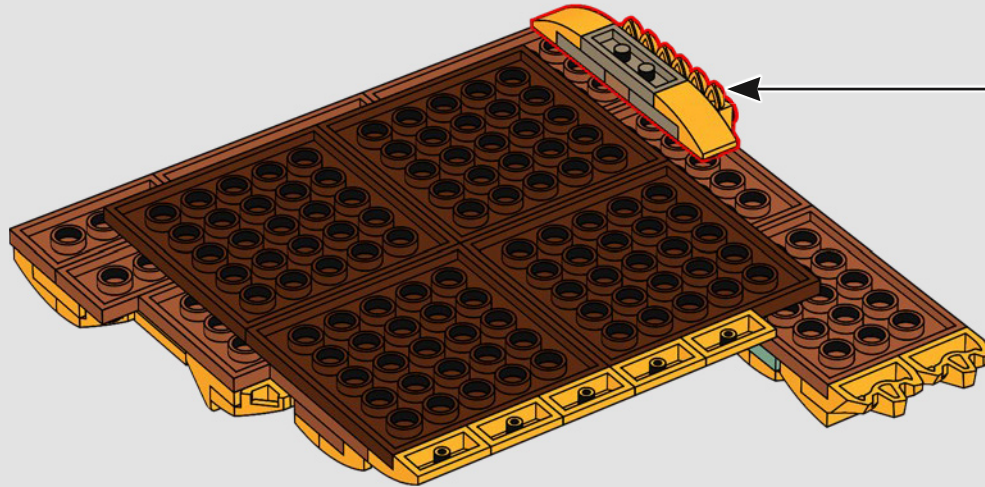
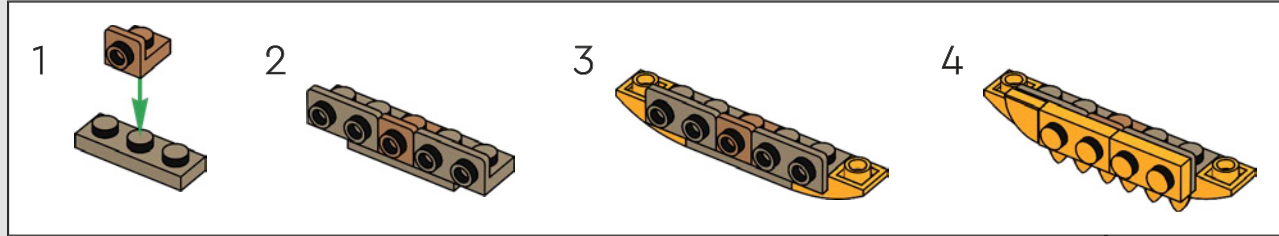



381

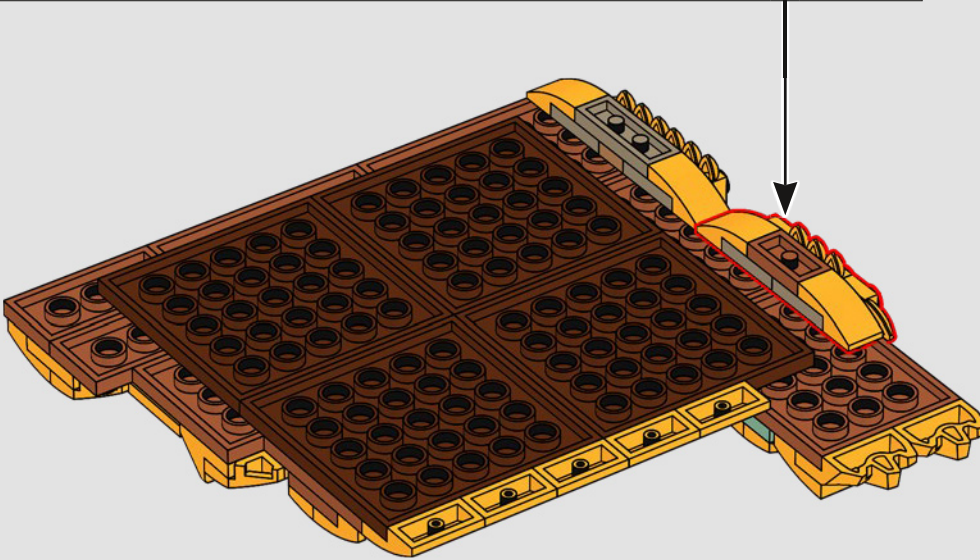
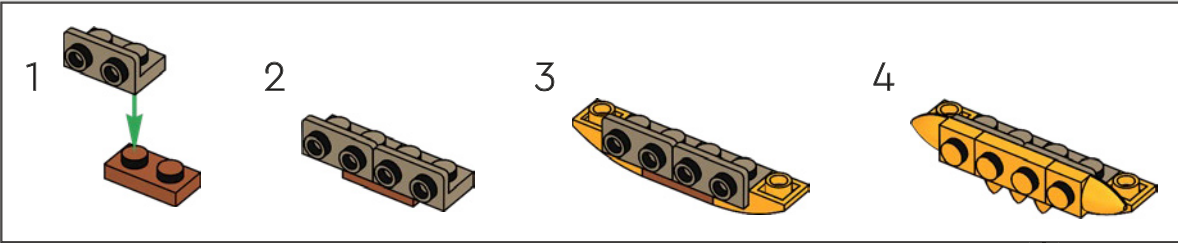



382

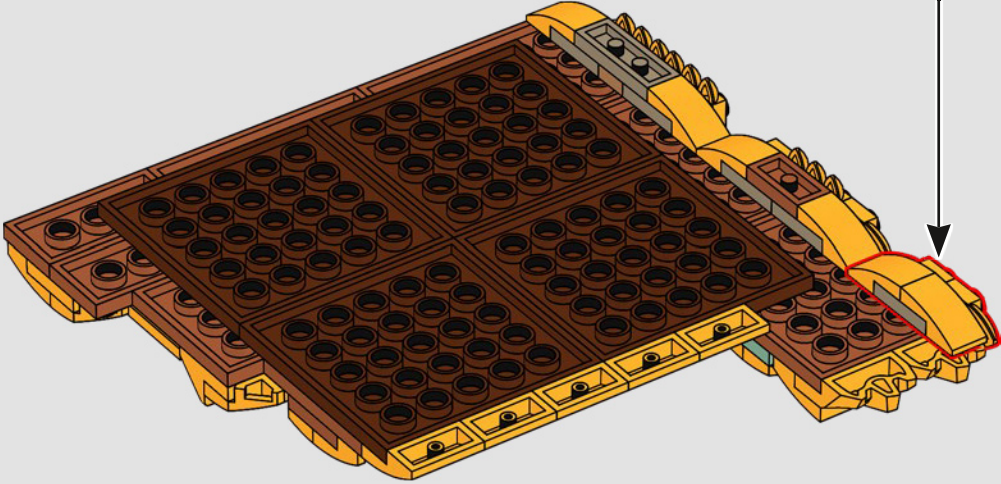
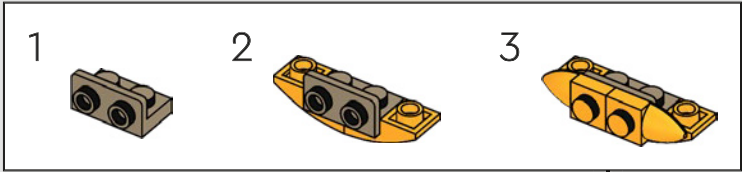



383

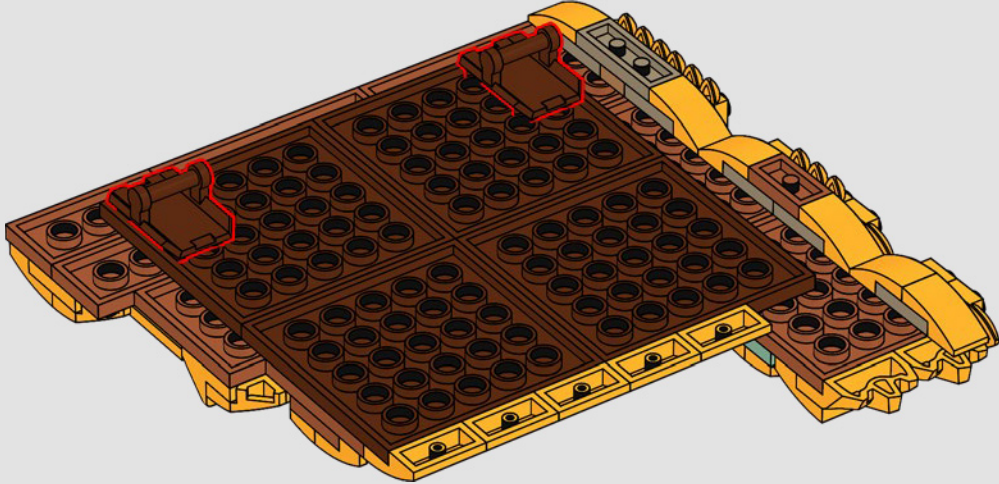



384

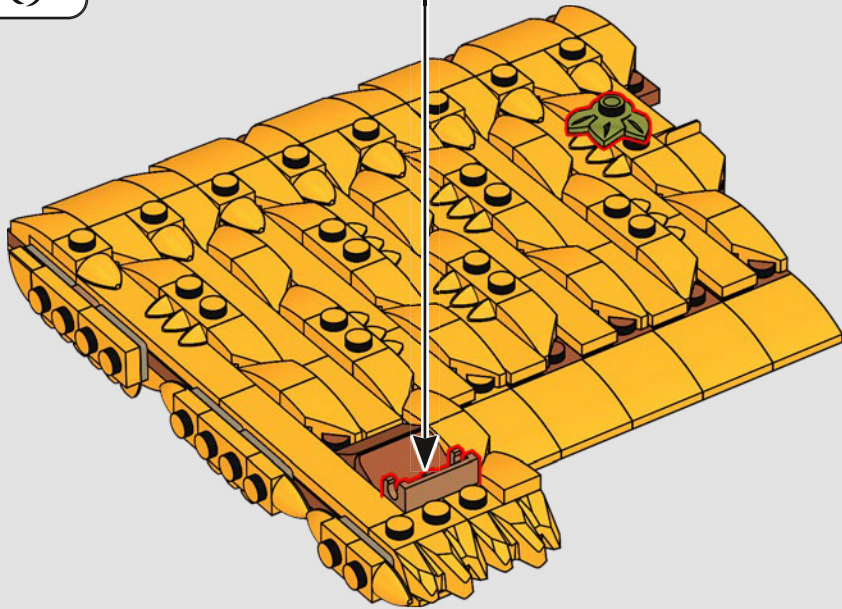
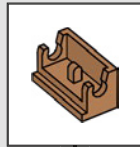

385

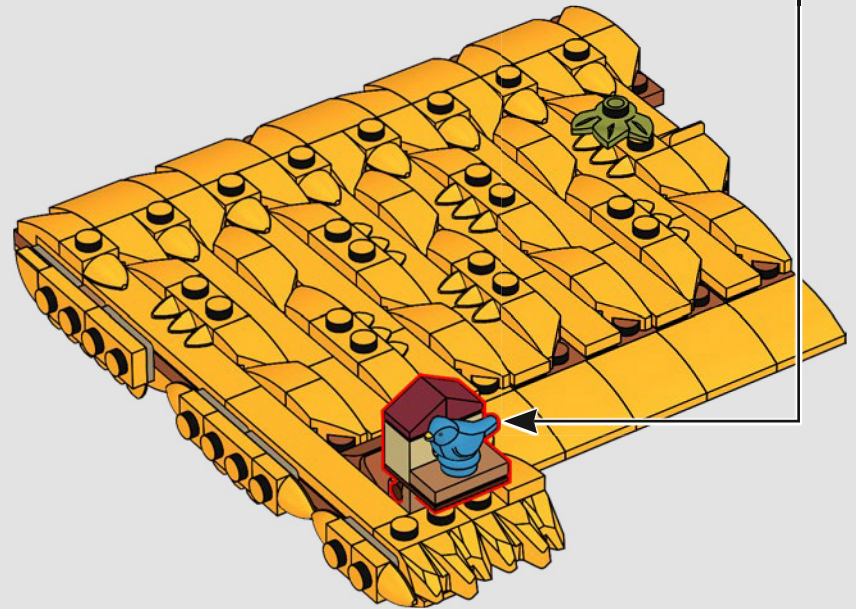
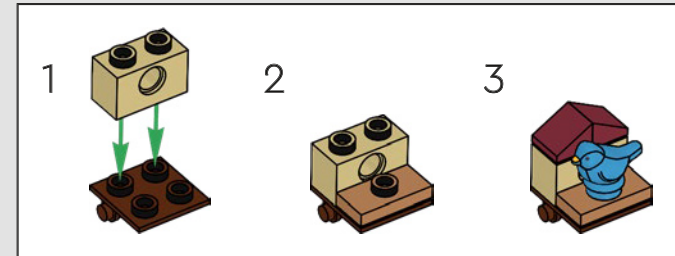

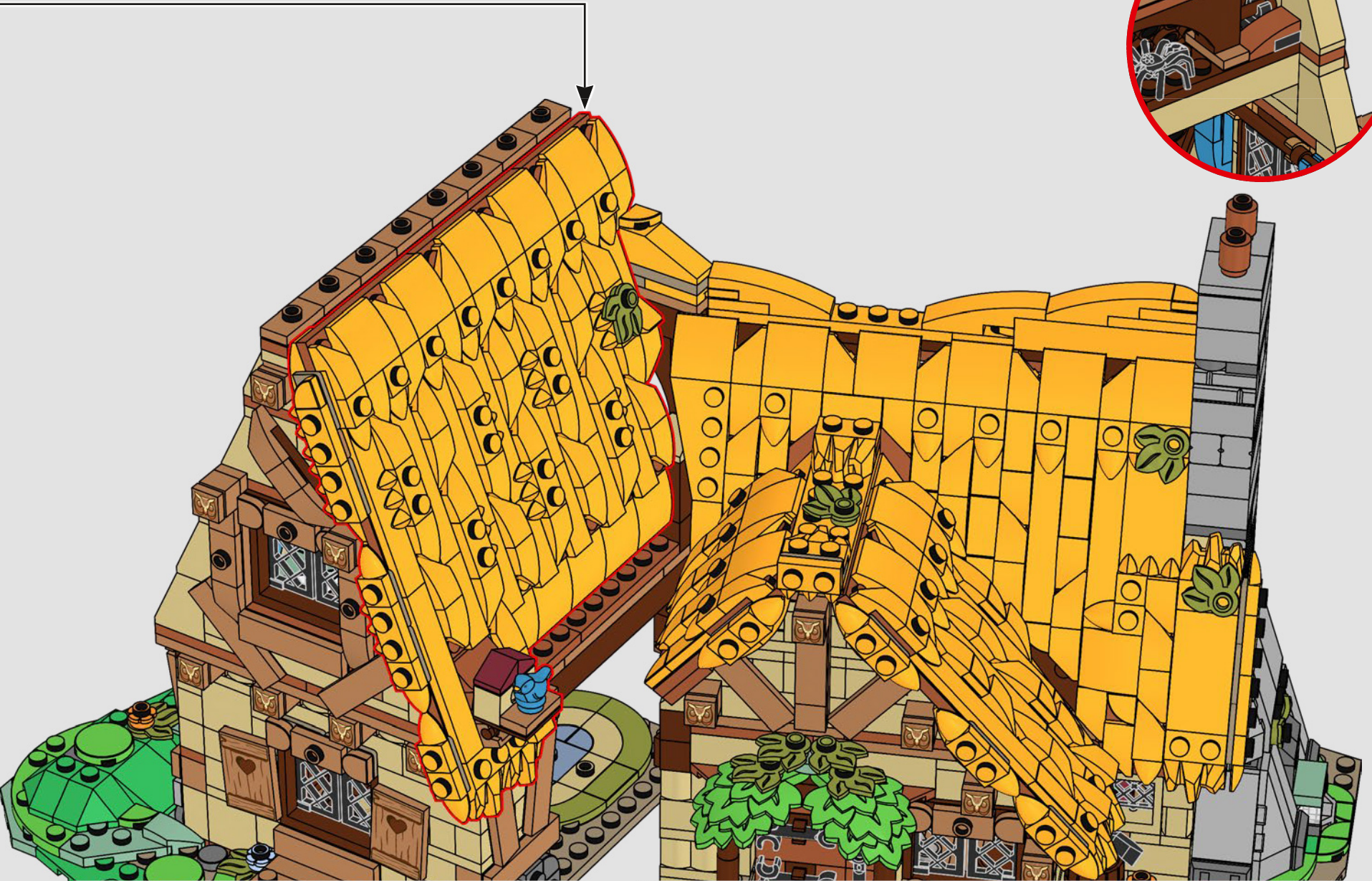
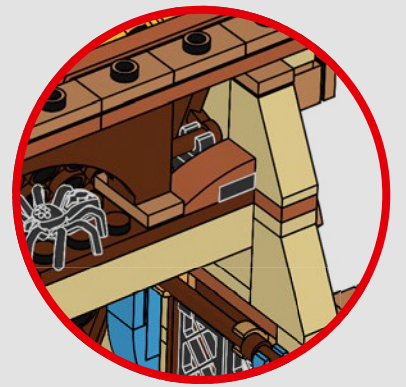

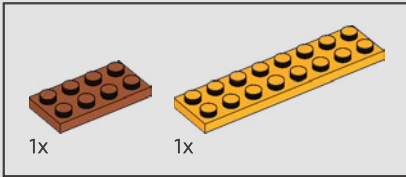
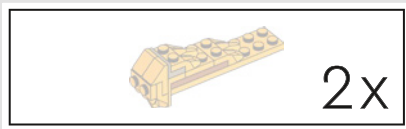

387

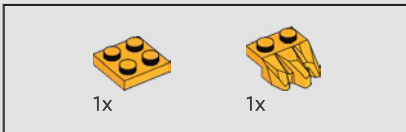
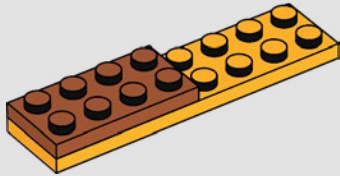

388

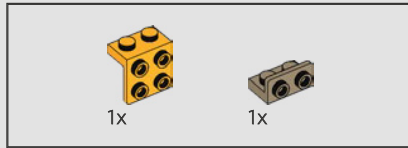
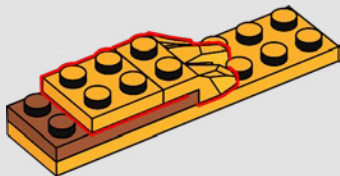

389

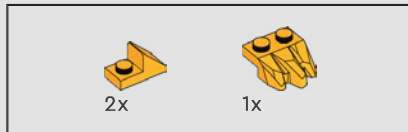
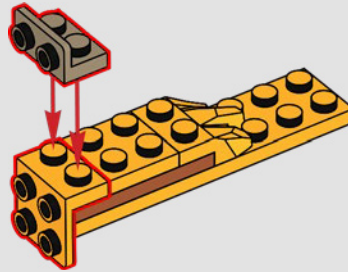

390

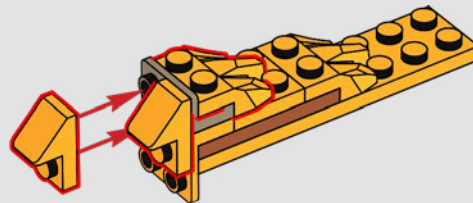

391

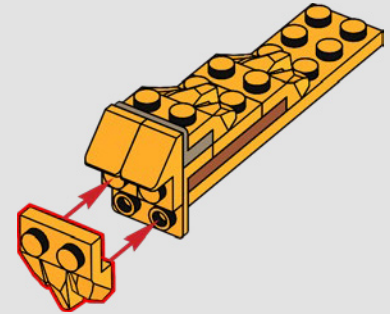

392

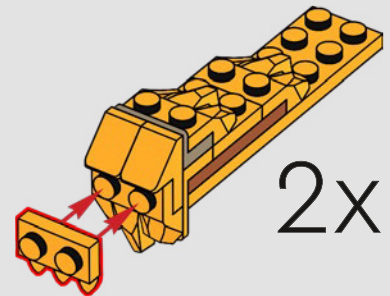

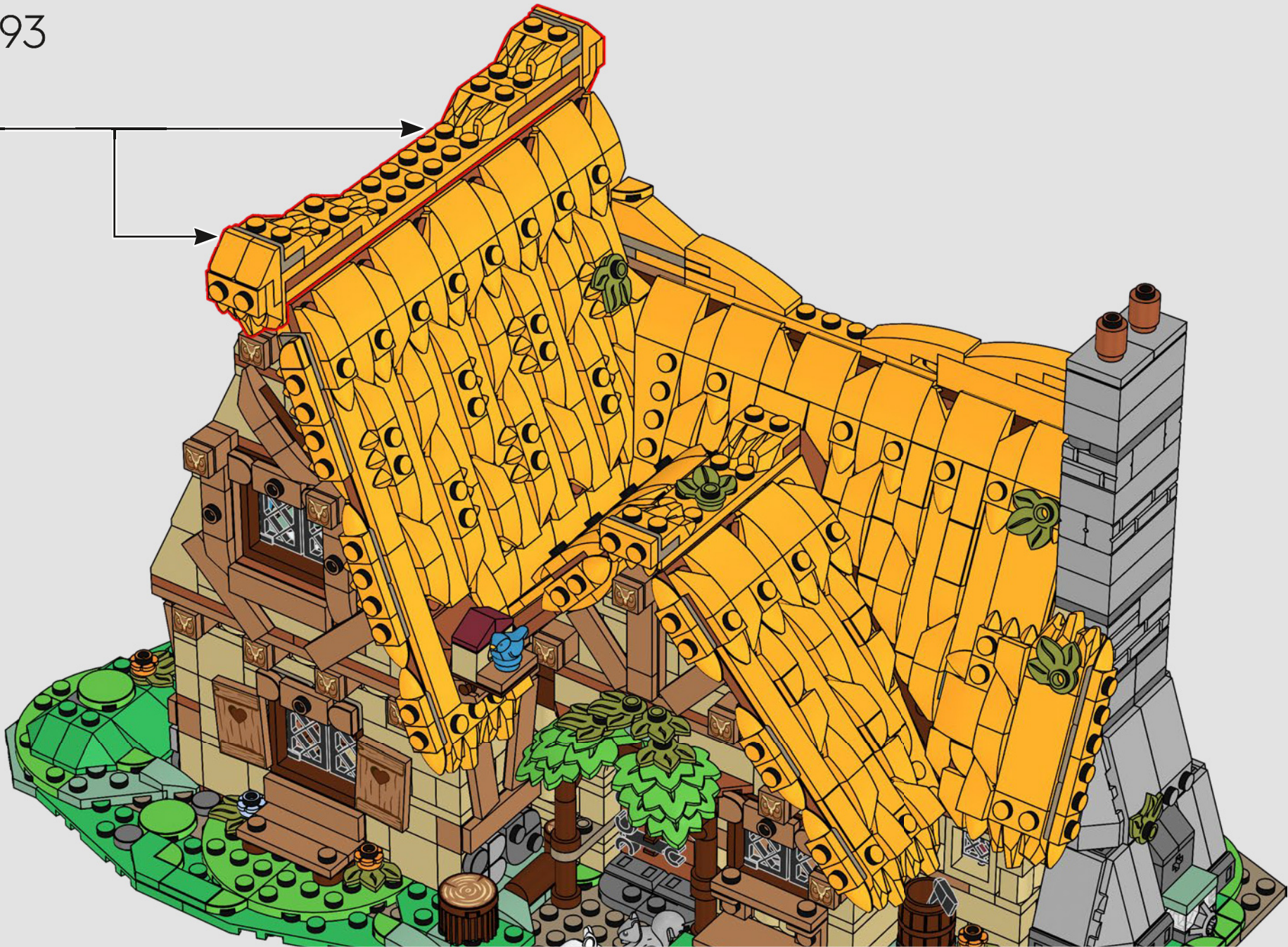





1x

394

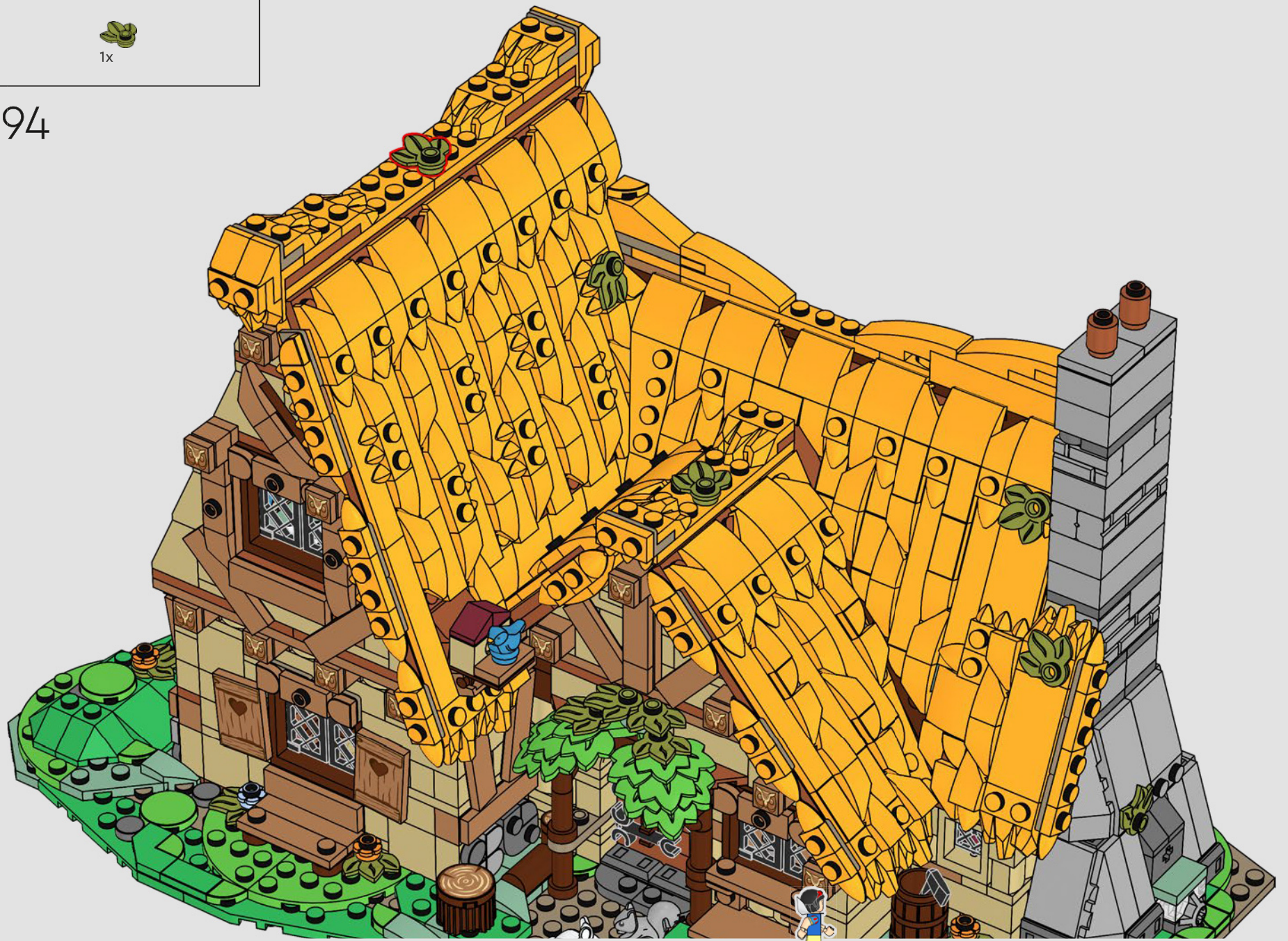



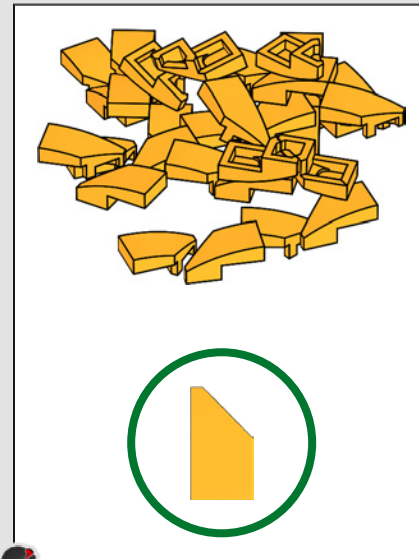
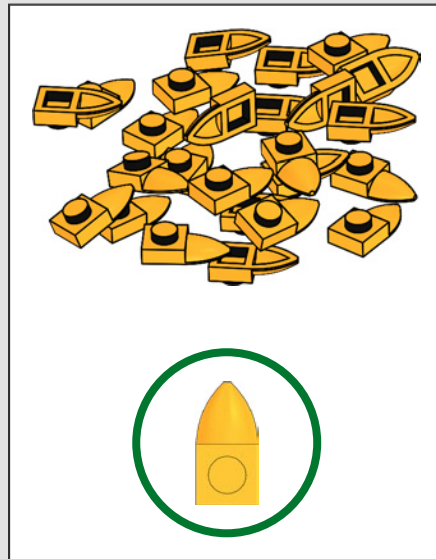
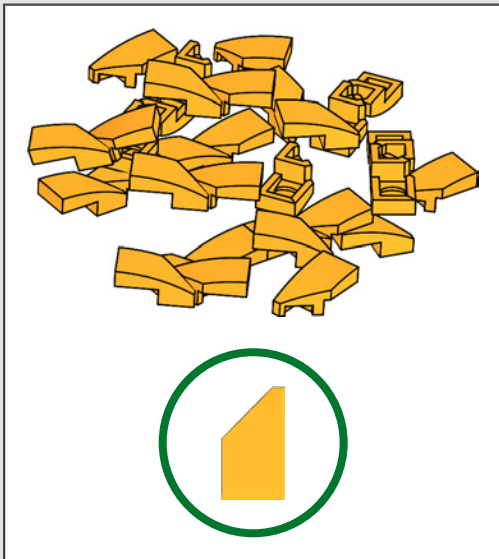

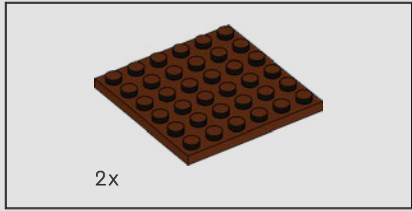
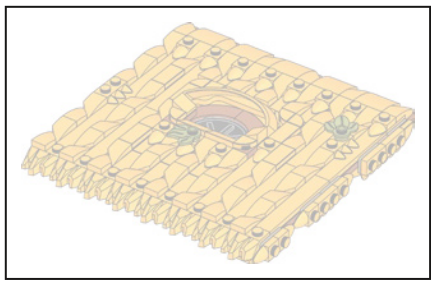

2x

395

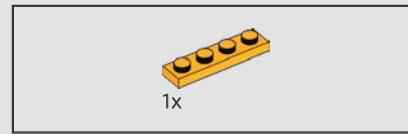
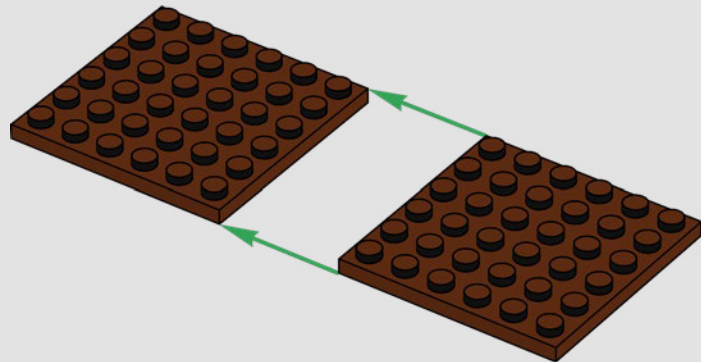

1x

396

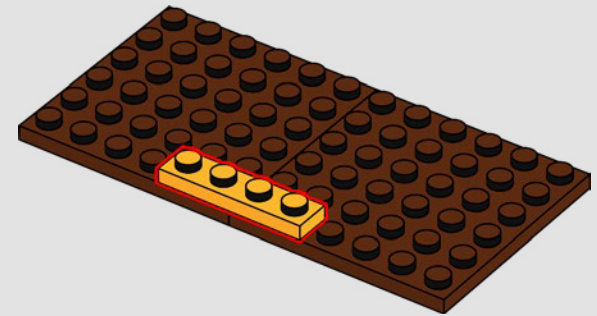

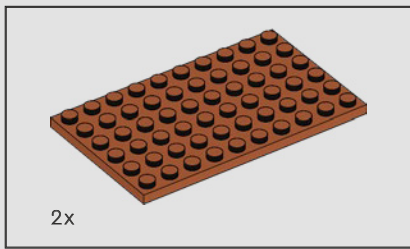

397

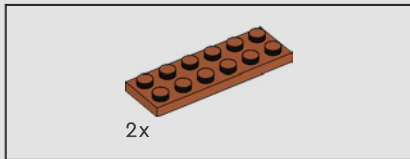
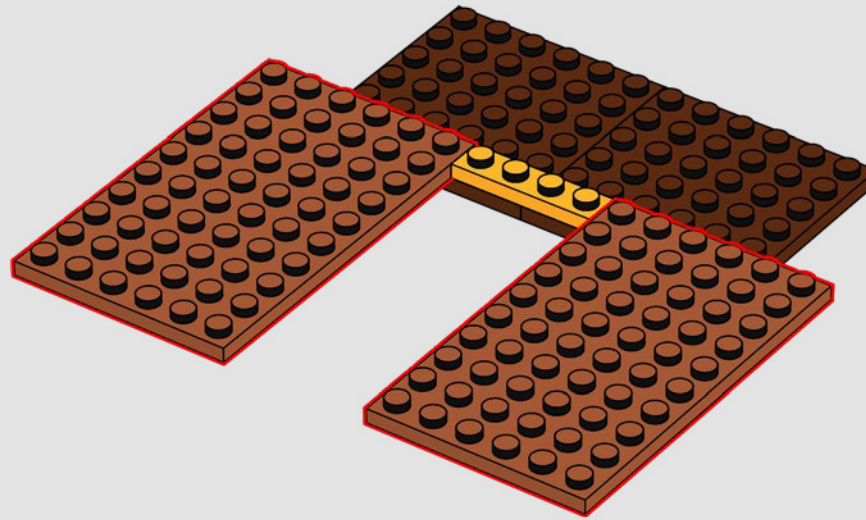

398

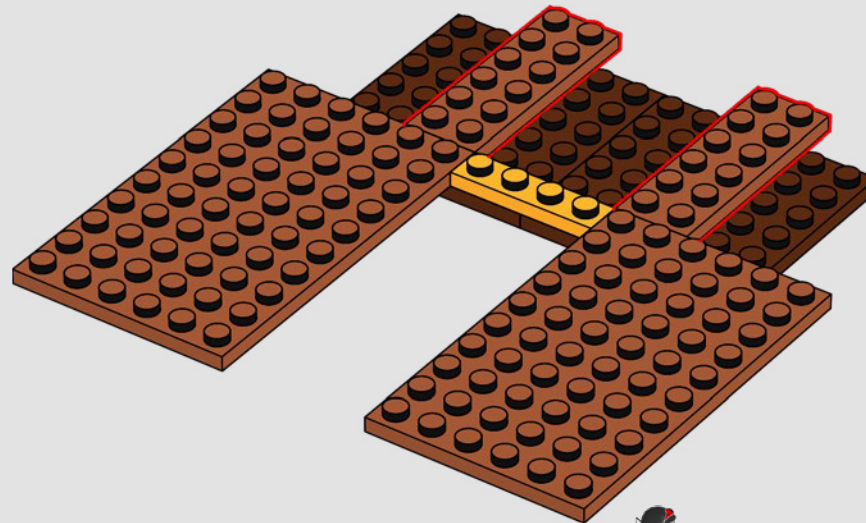

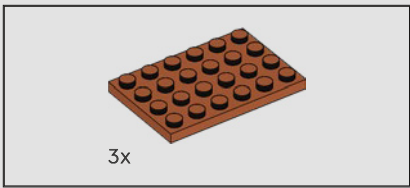

399

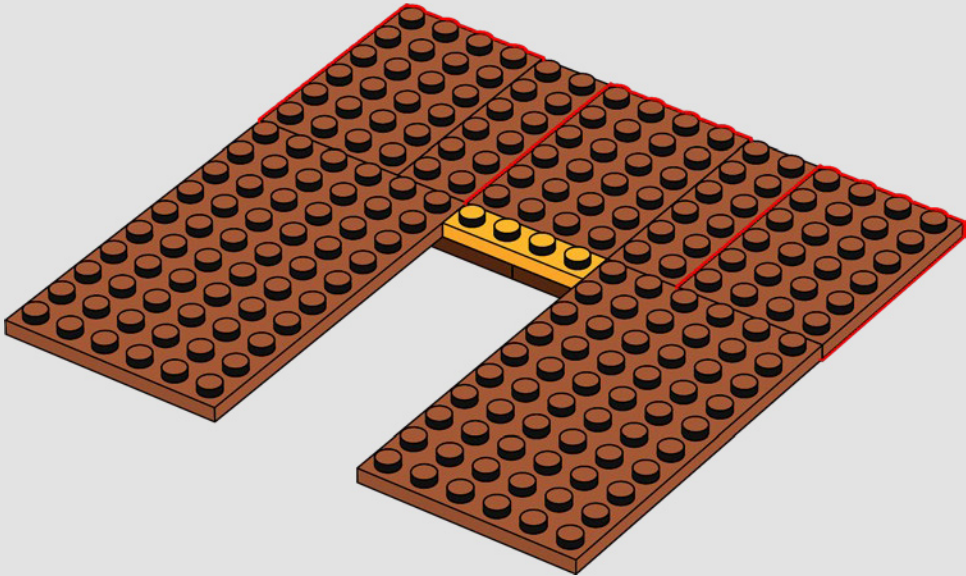

400

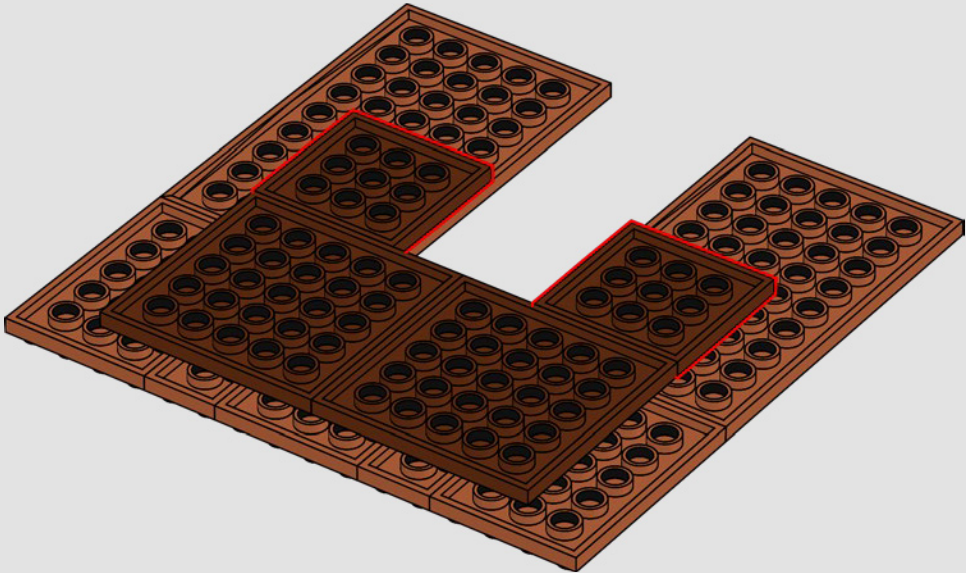

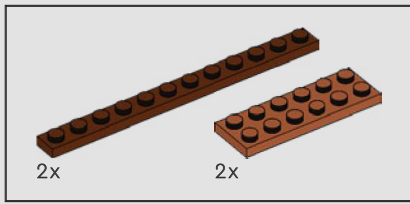

401

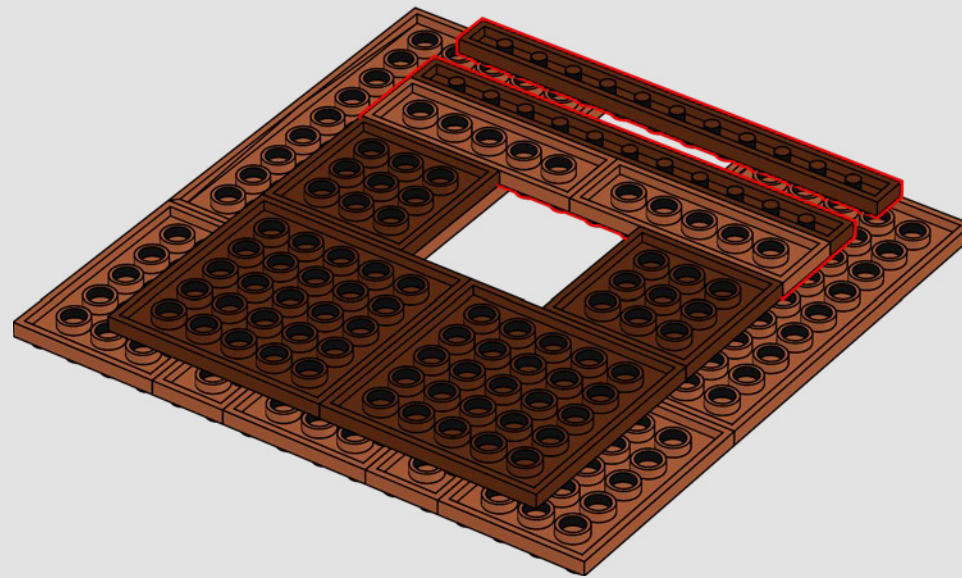

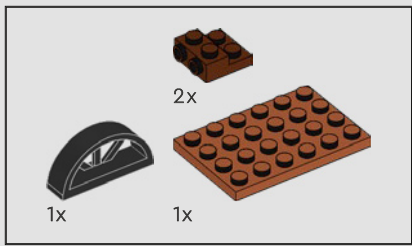

402

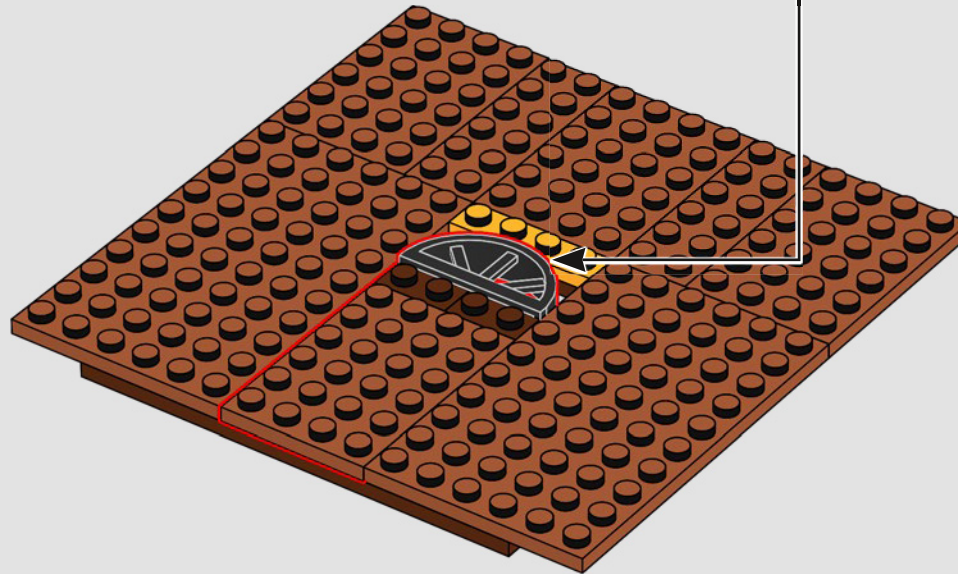
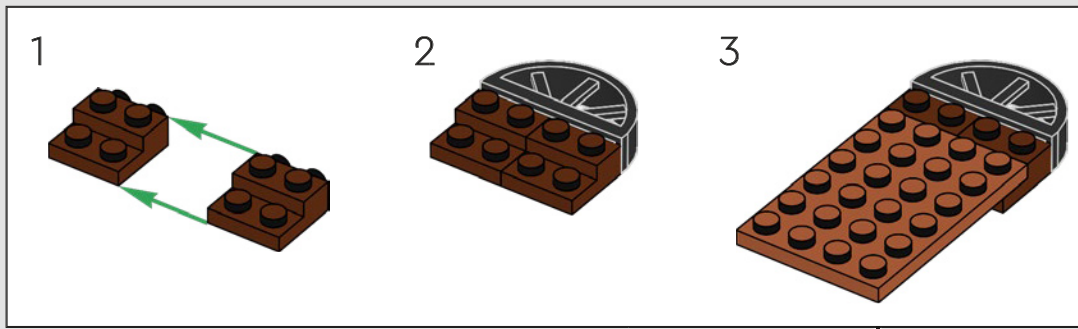



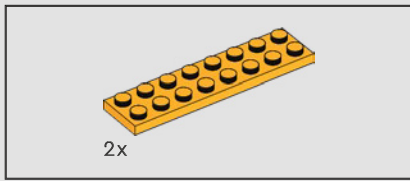

403

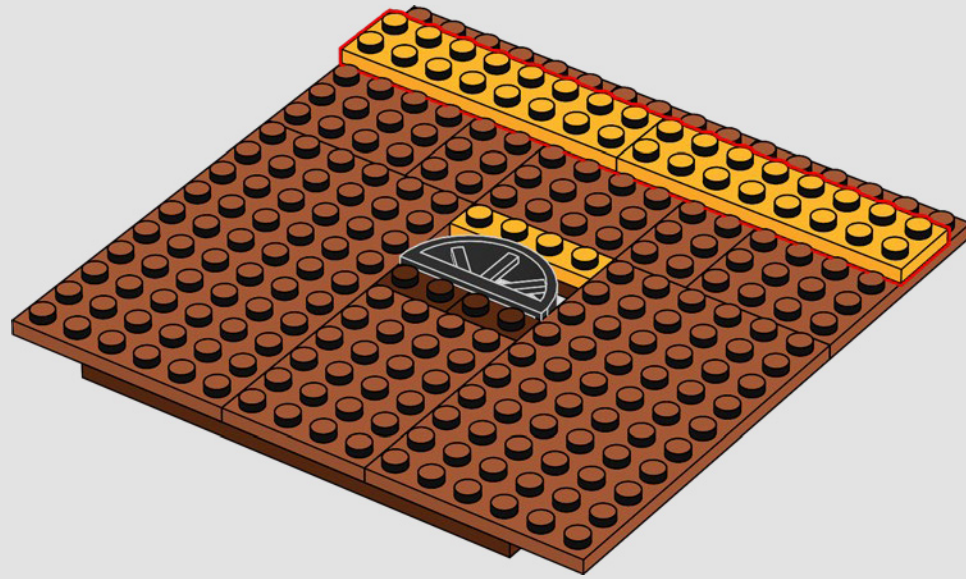

404

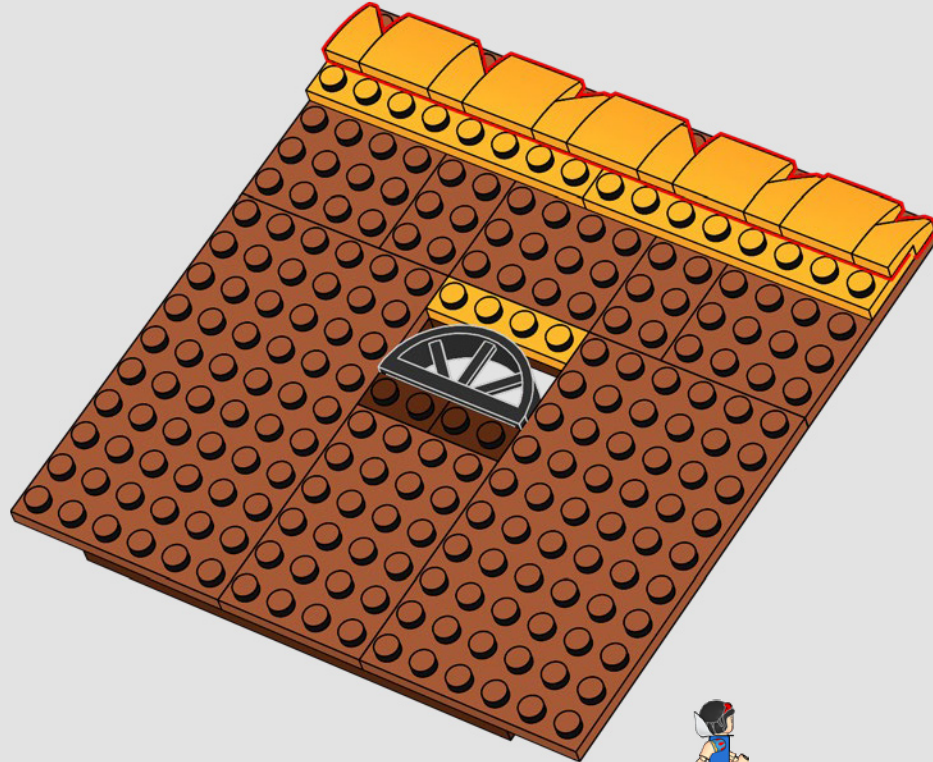

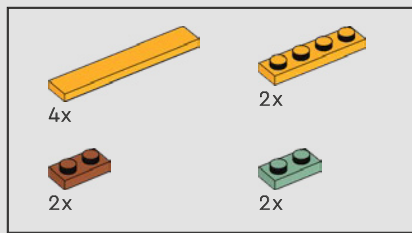

405

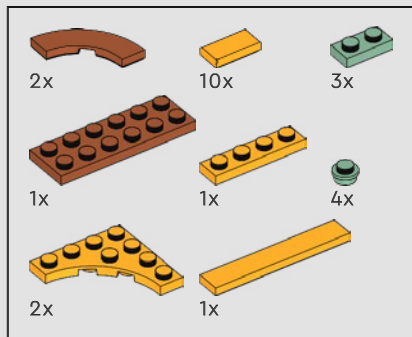
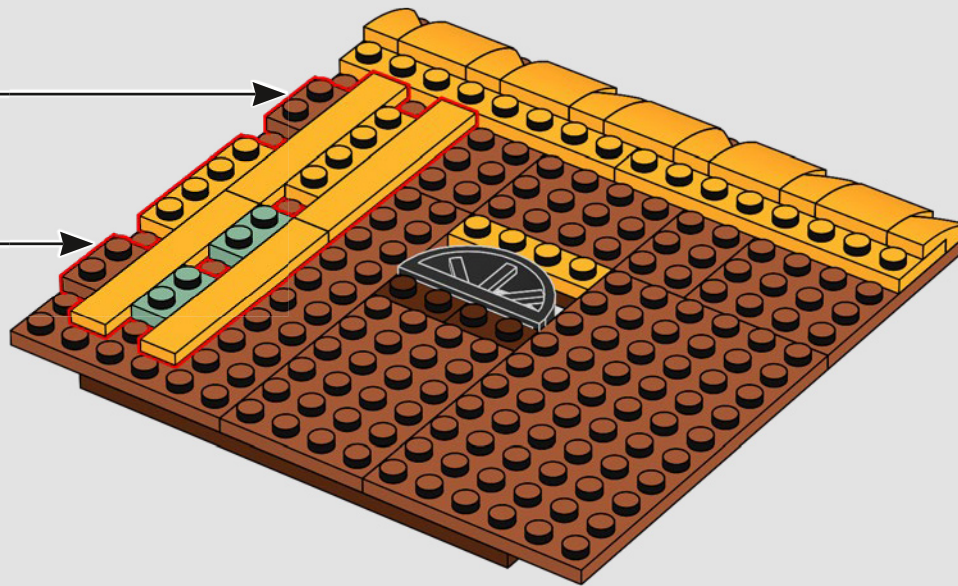
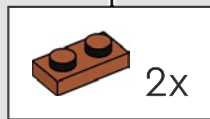

406

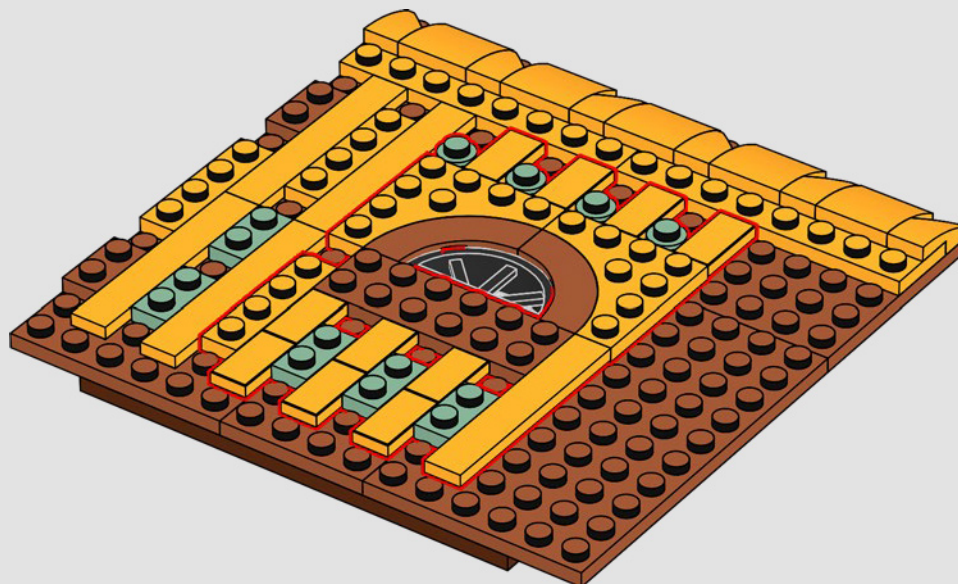

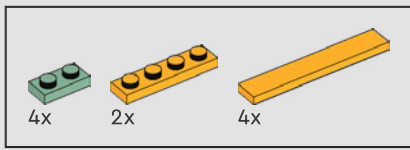

407

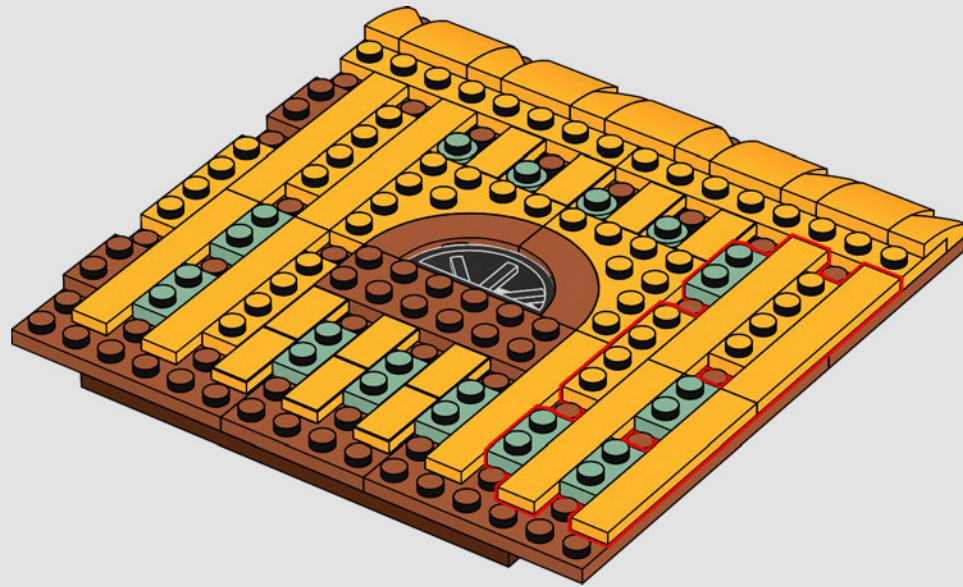

408

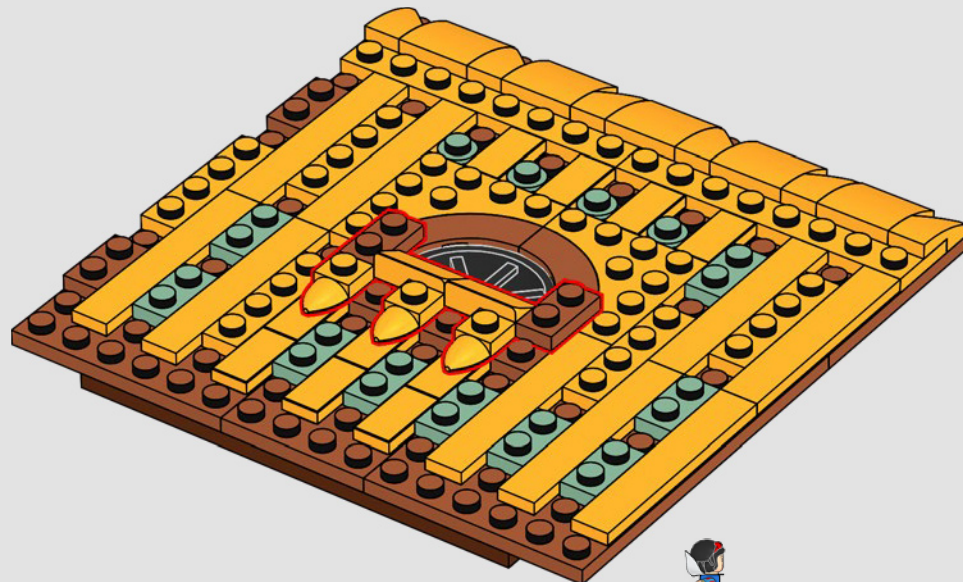



409

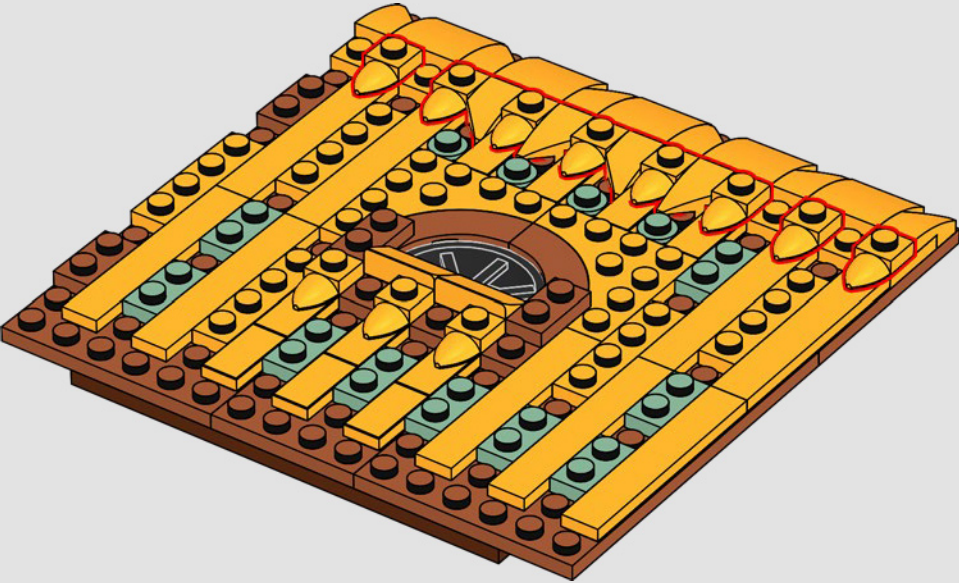

410

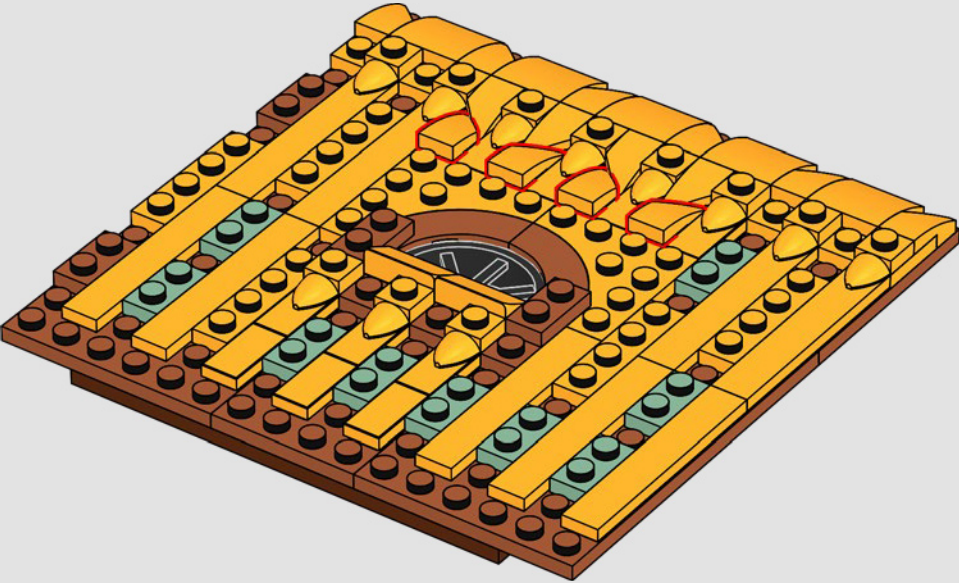

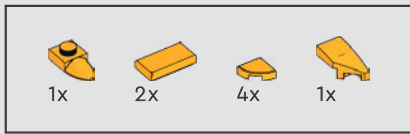

411

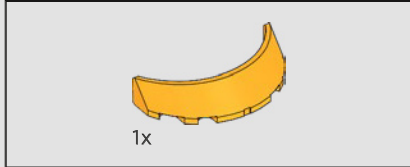
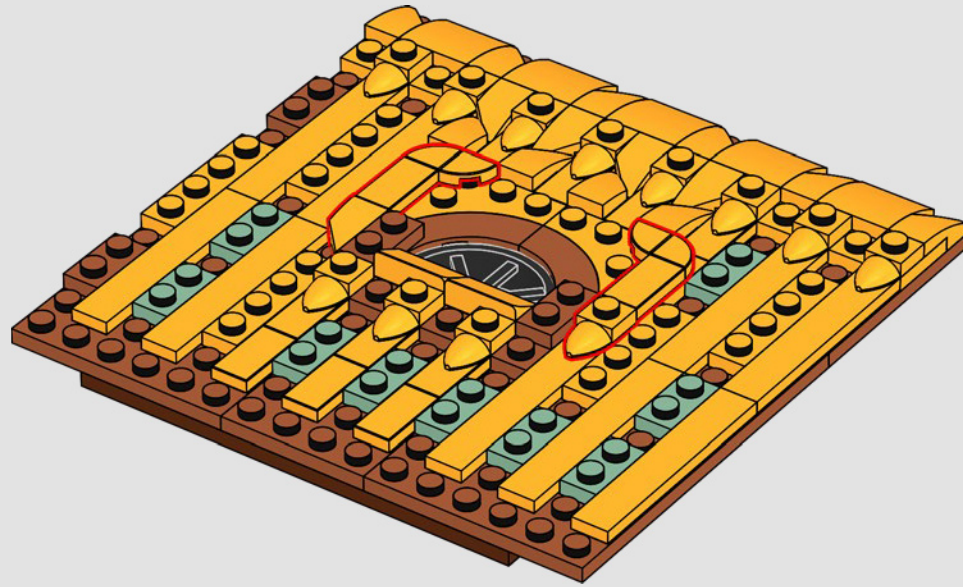

412

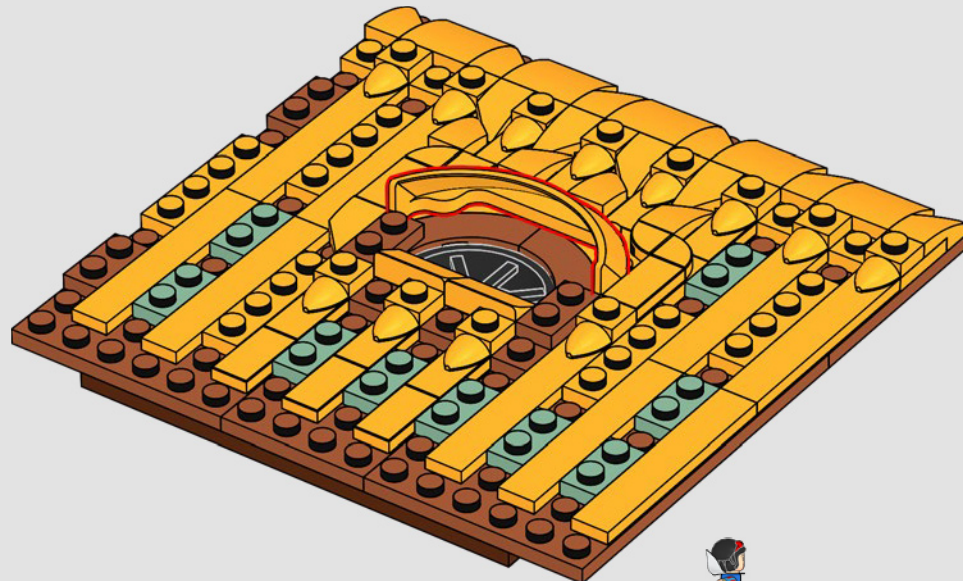



413

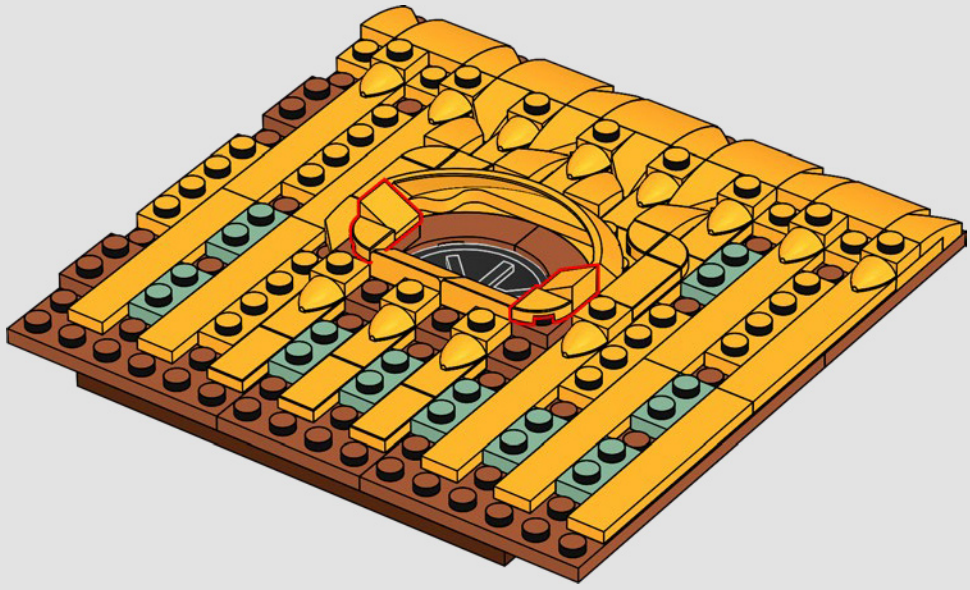

414

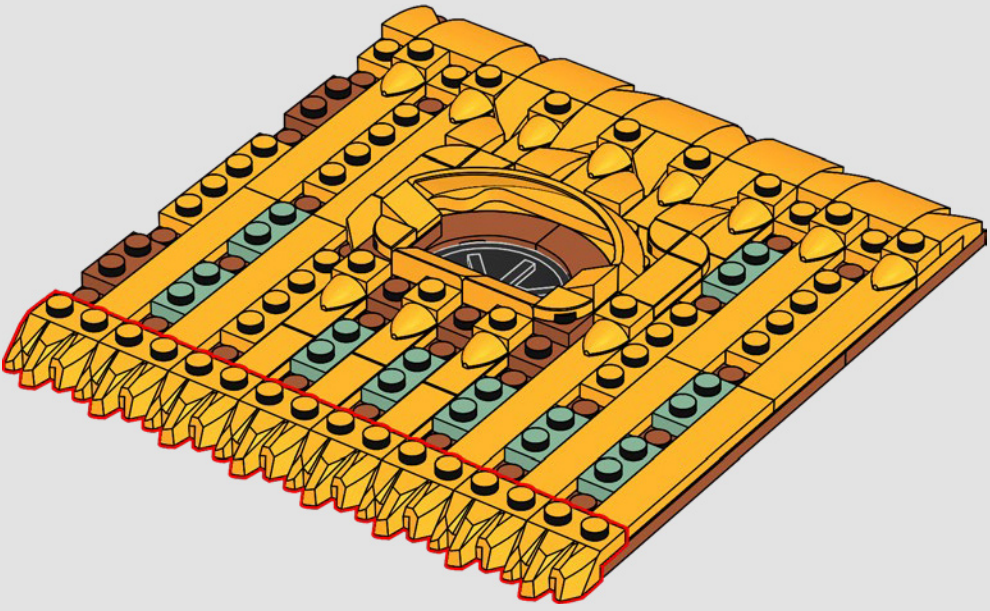



415

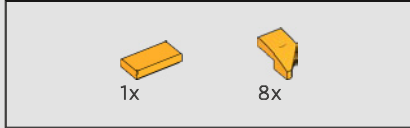
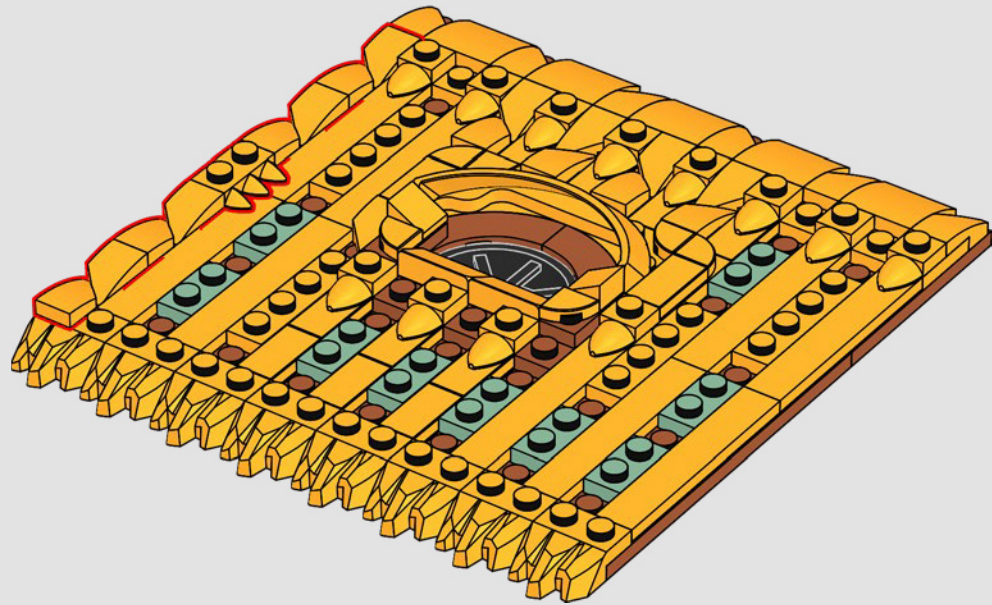

416

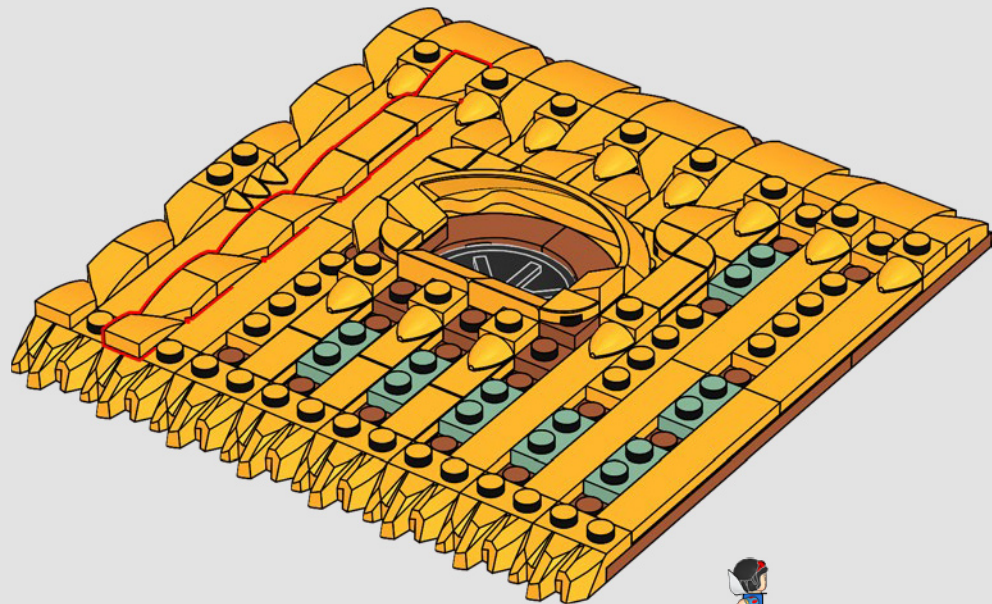

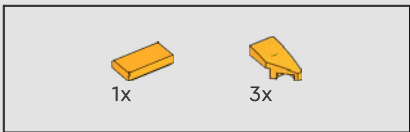

417

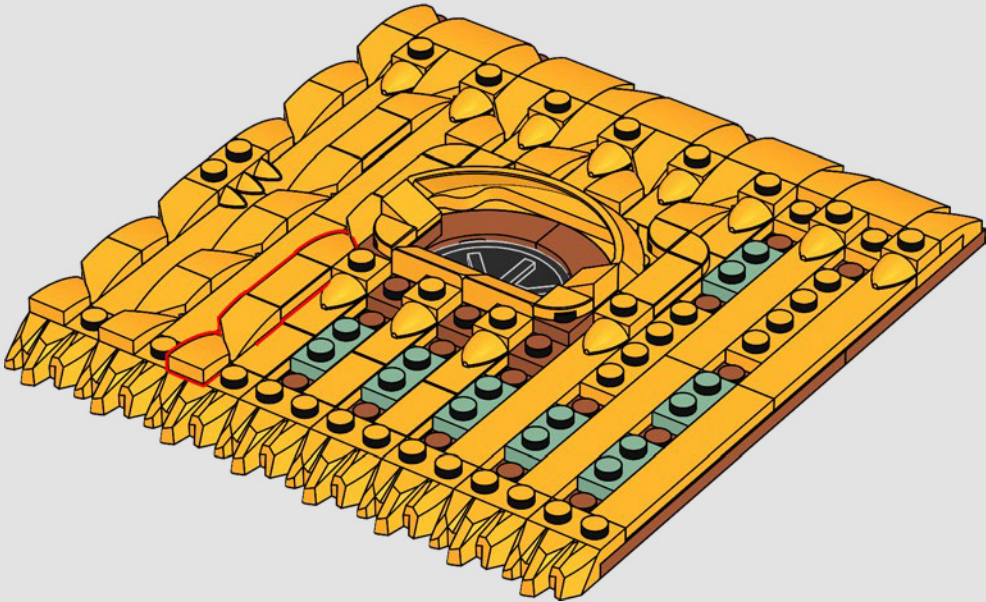

418

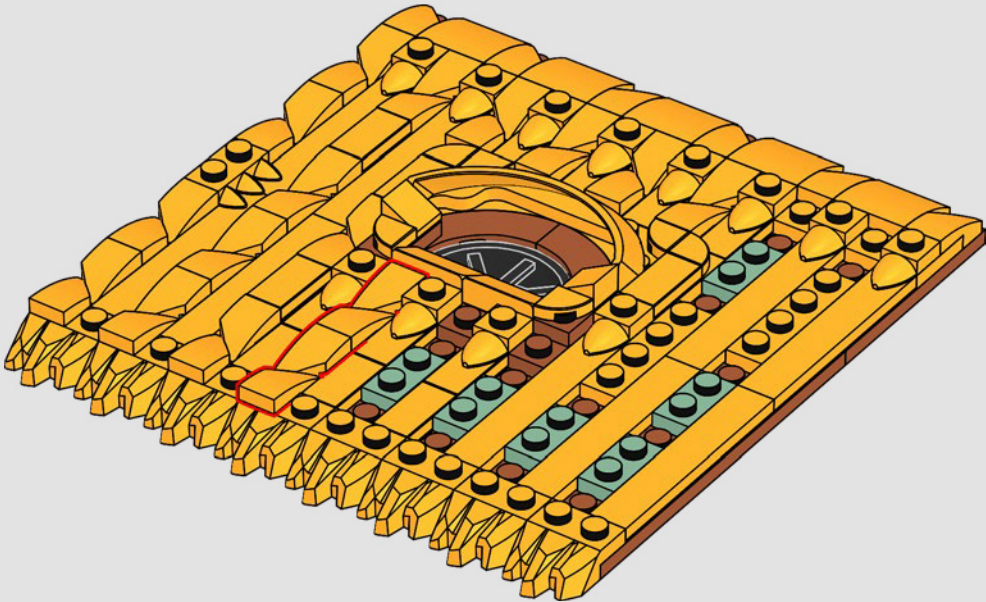





419

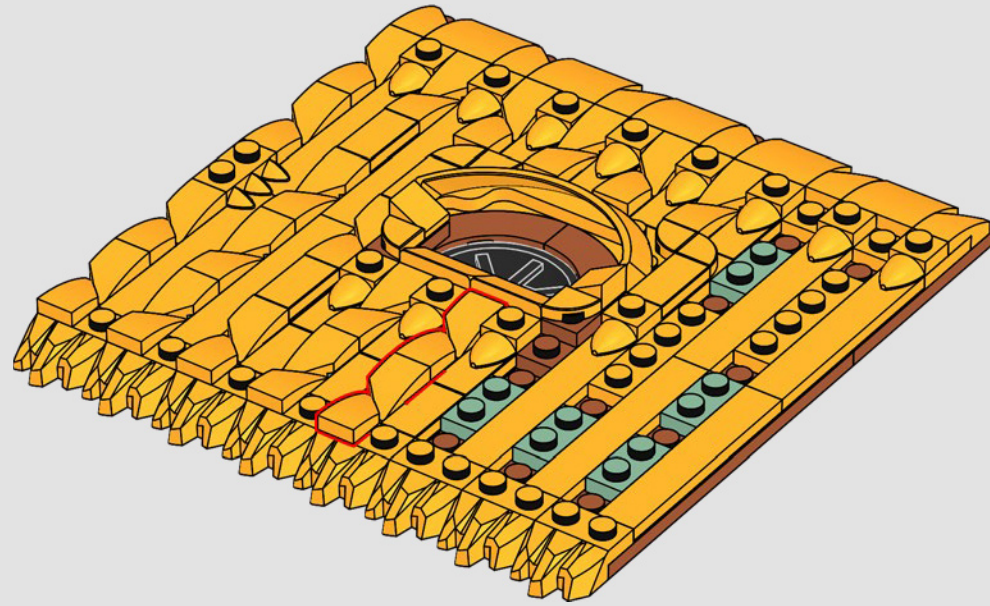

420

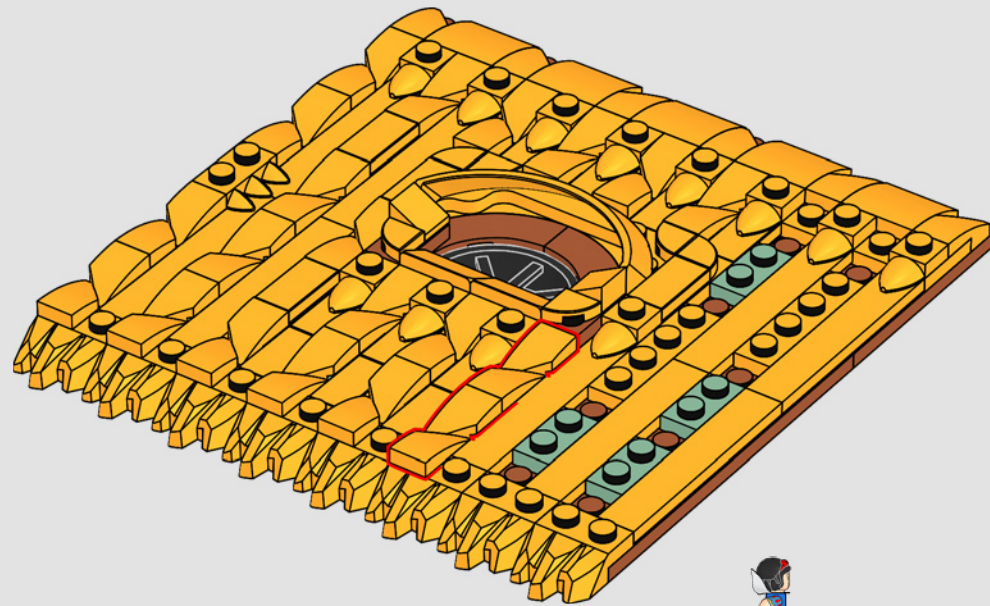

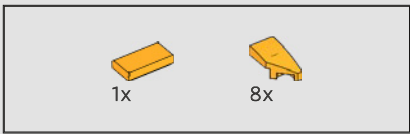

421

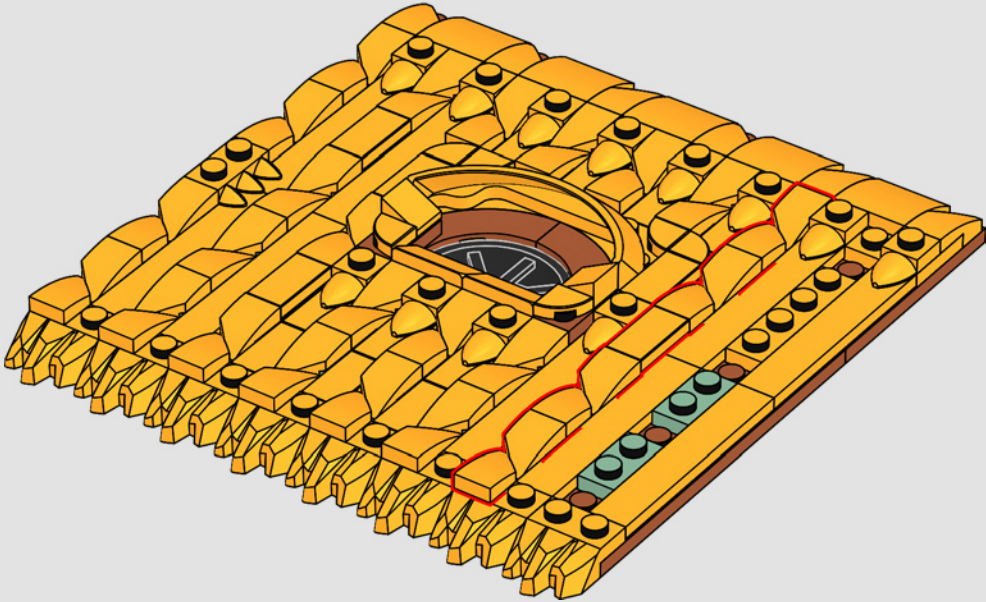

422

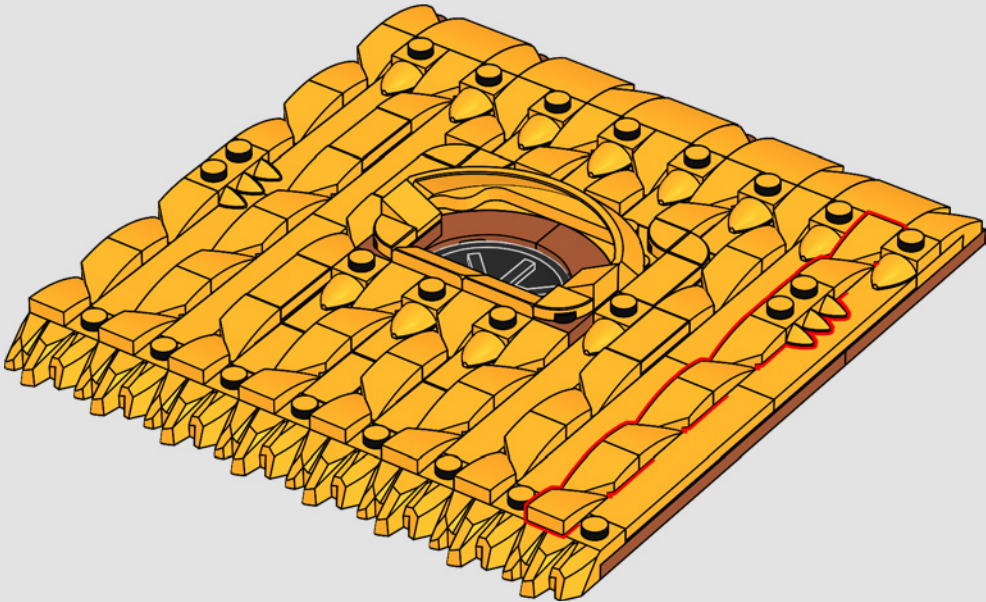

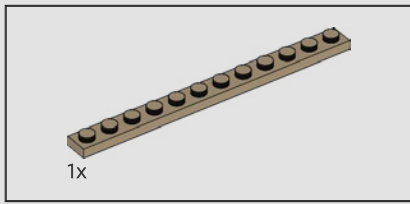

423

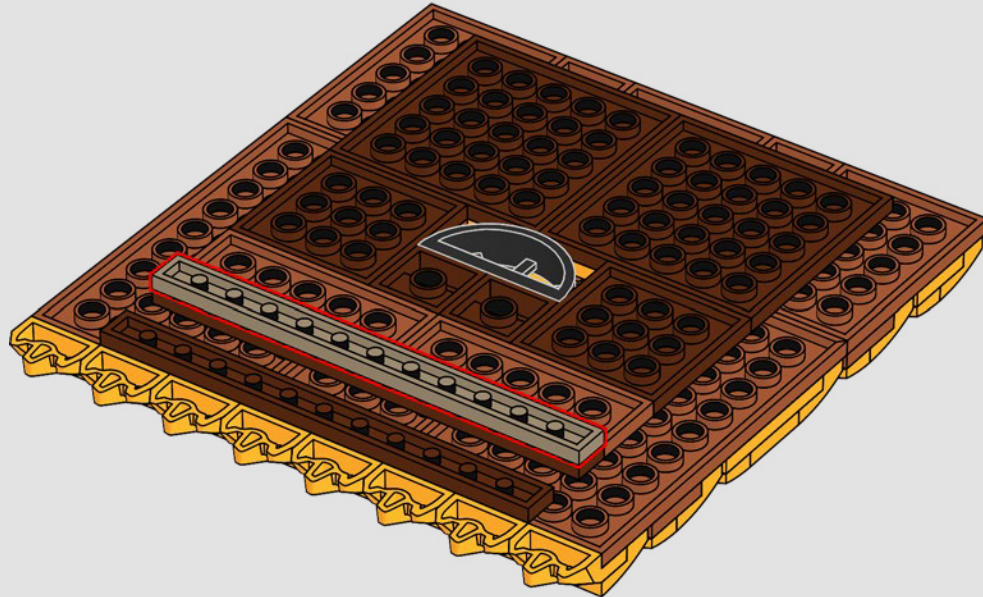

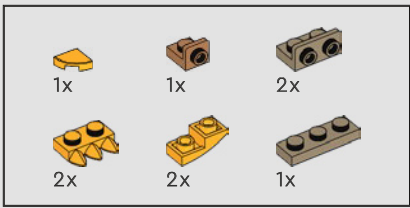

424

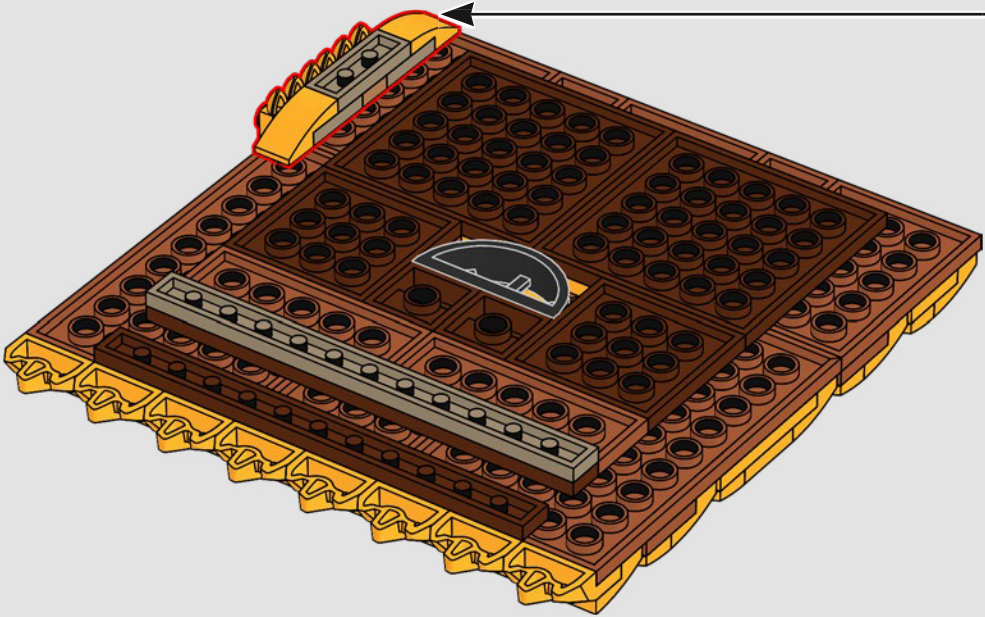
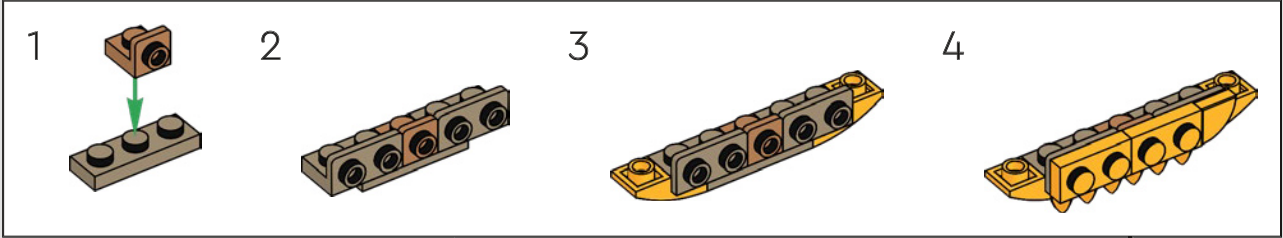



425

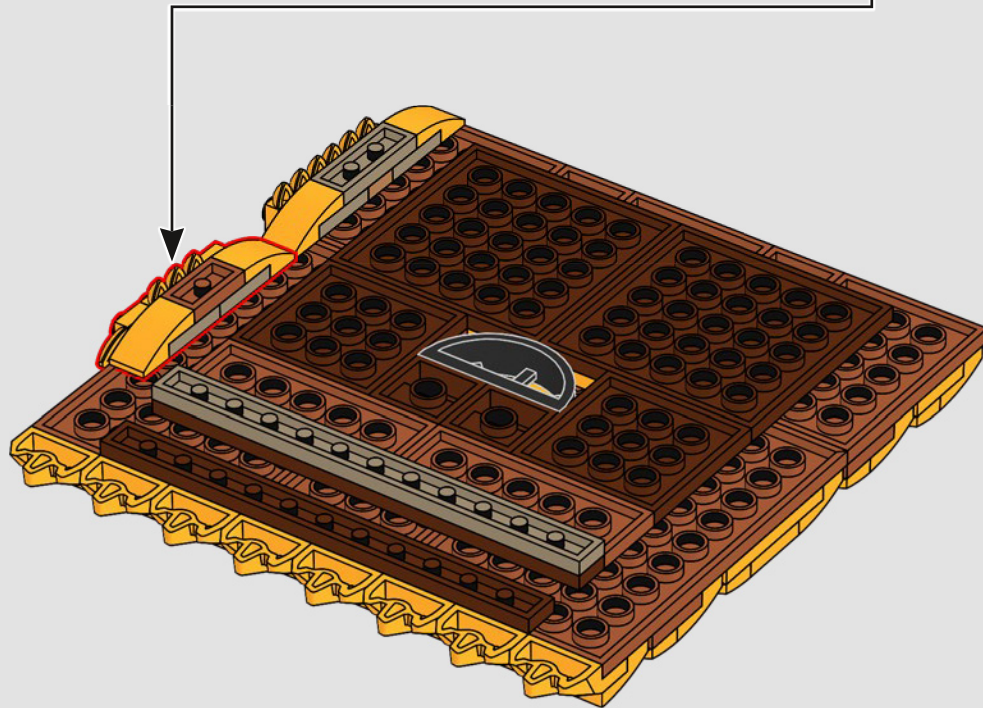
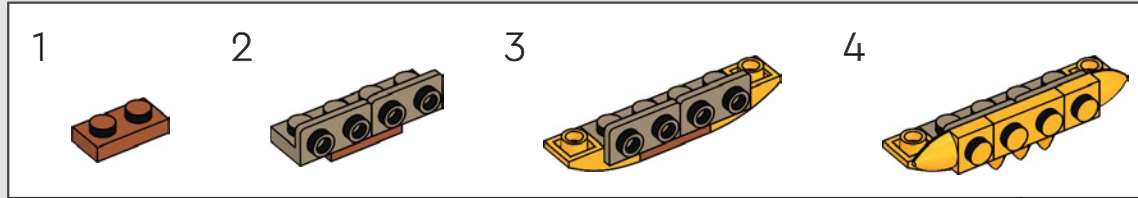



426

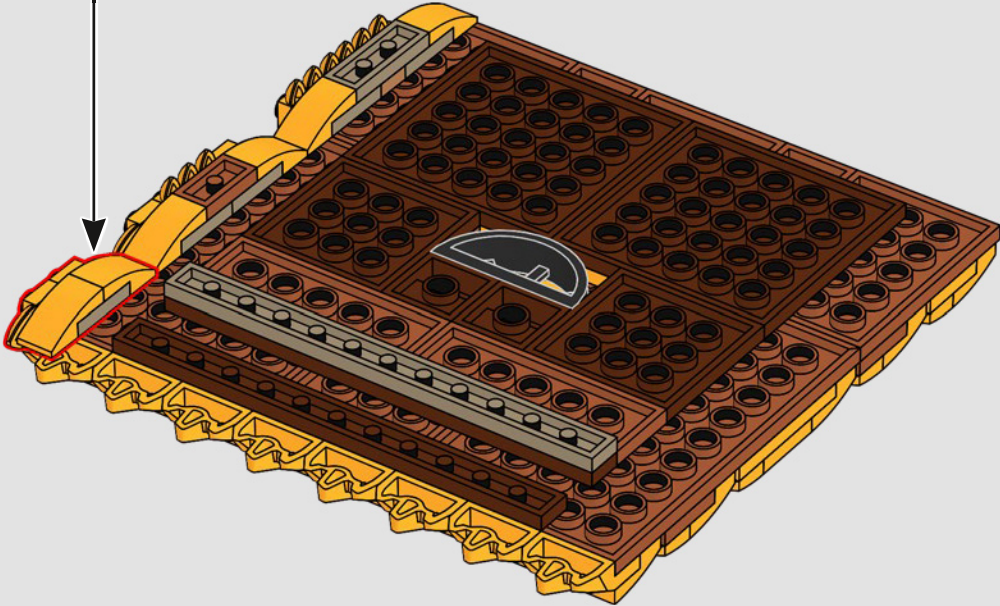
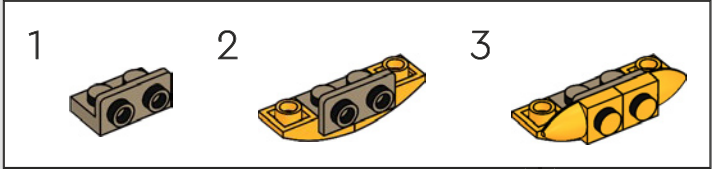



427

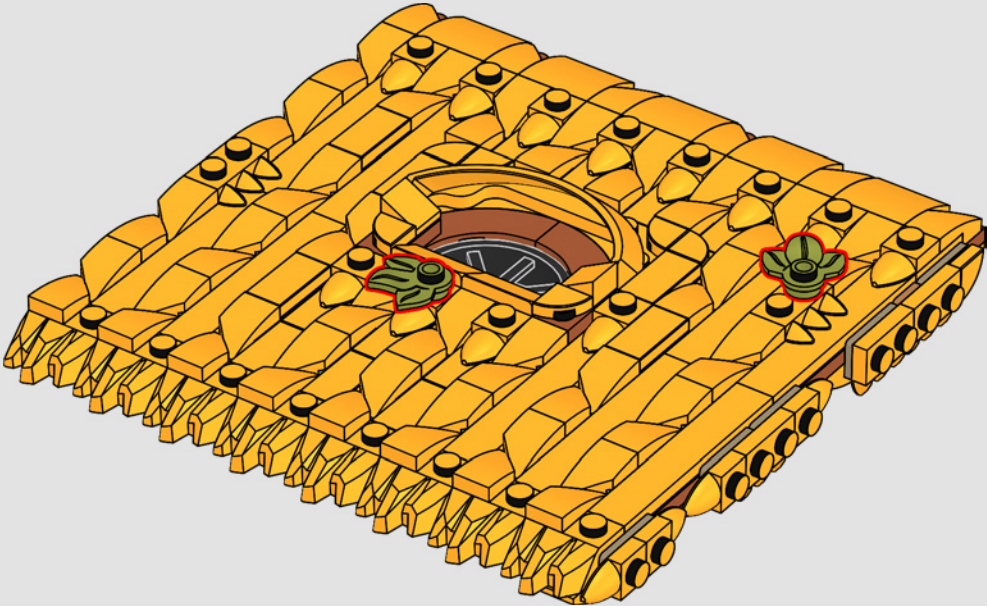





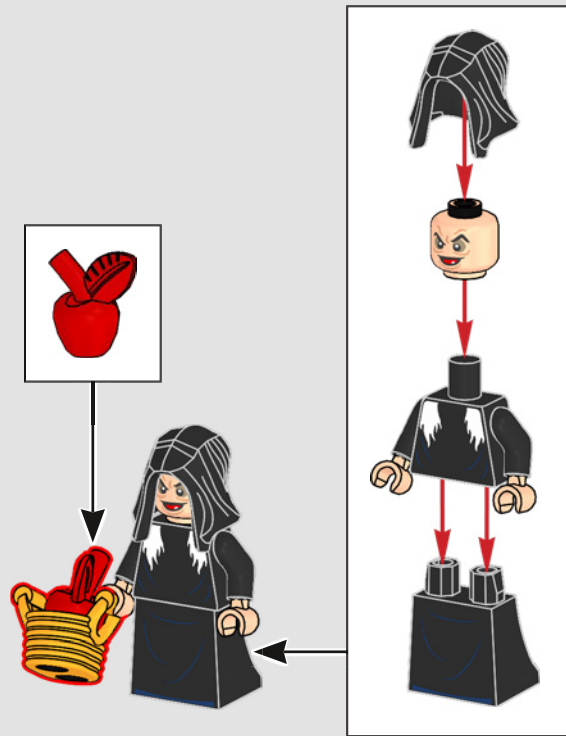

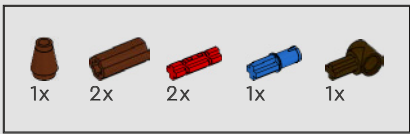

429

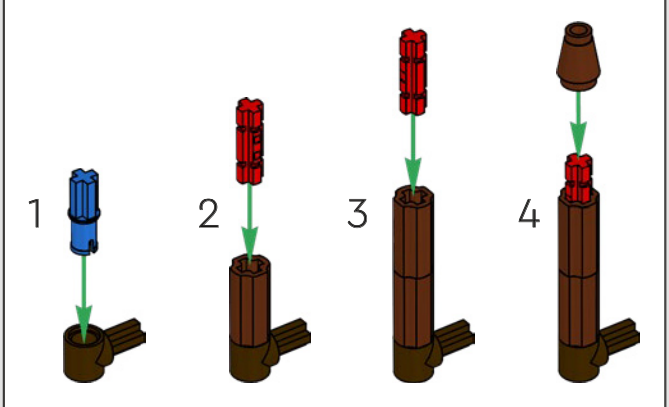

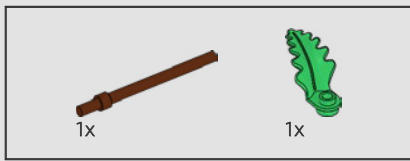

430

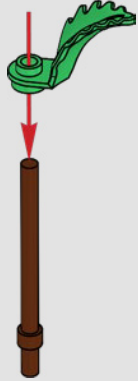

431

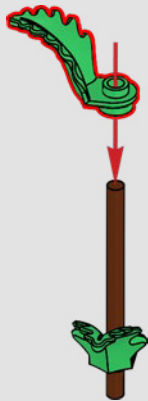

432

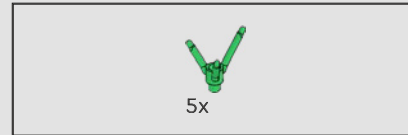

433

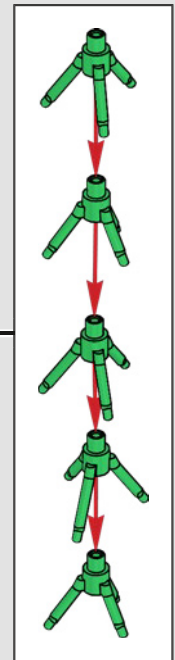





435

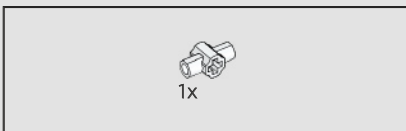
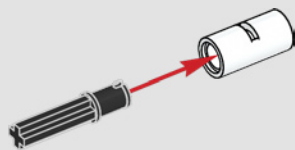

436

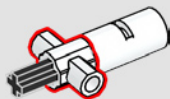

437

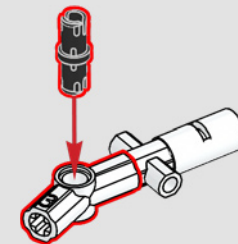

438

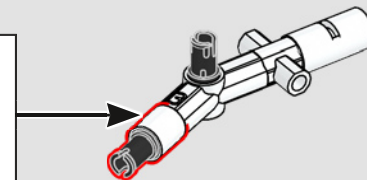
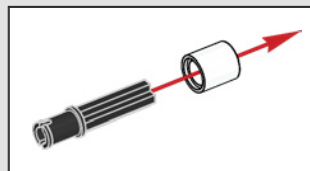



439

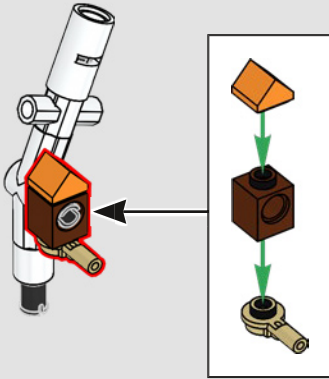

440

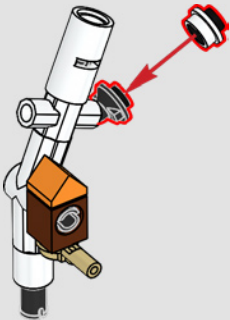

441

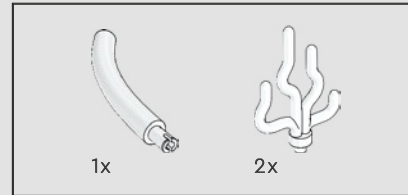
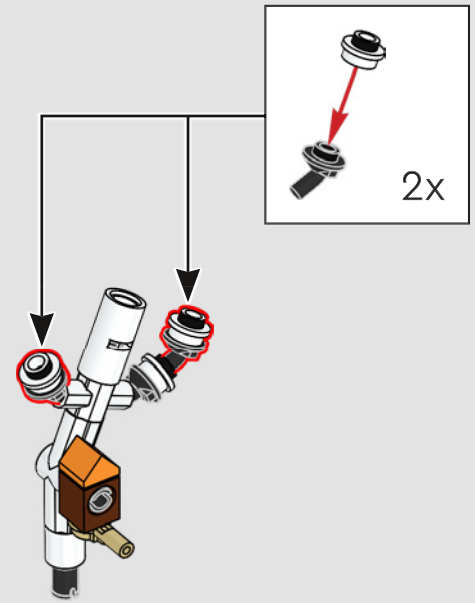

442

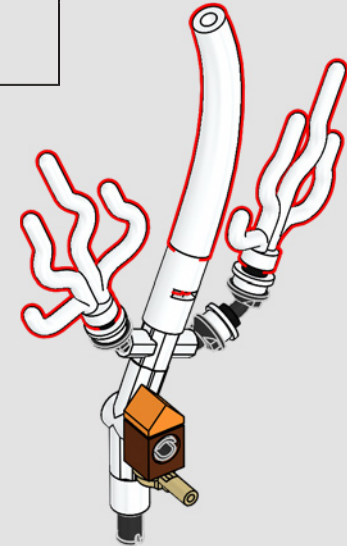





444

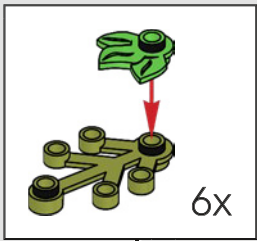



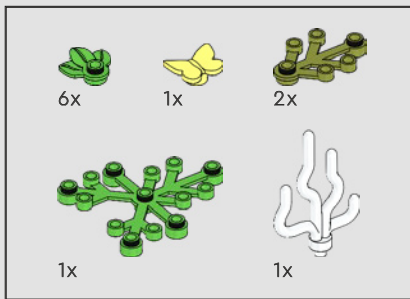

445

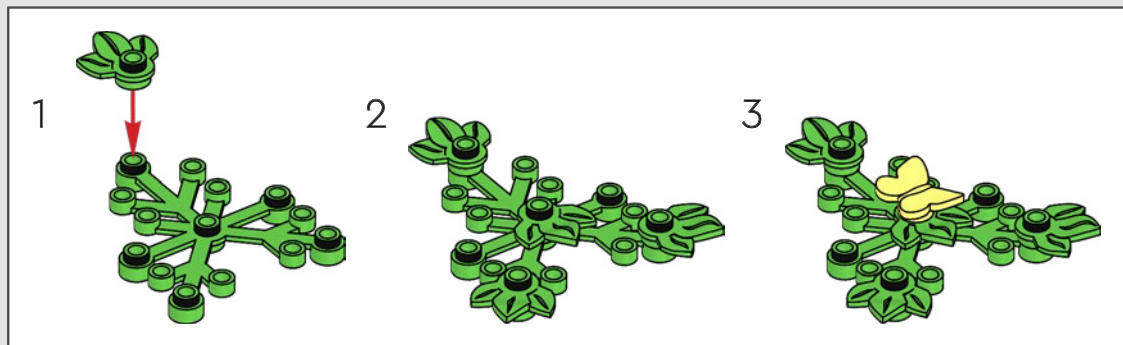
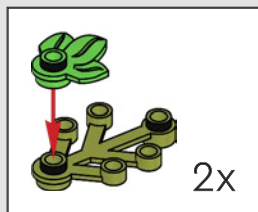

1

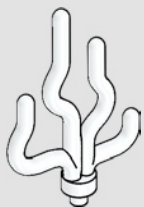

2

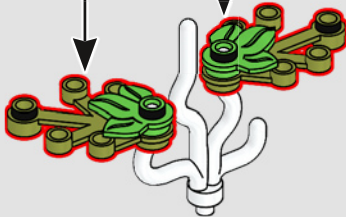

3

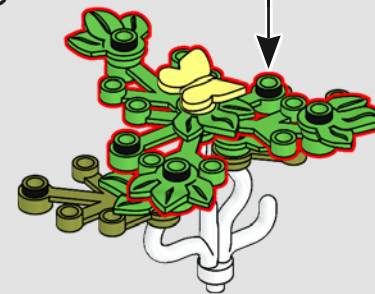

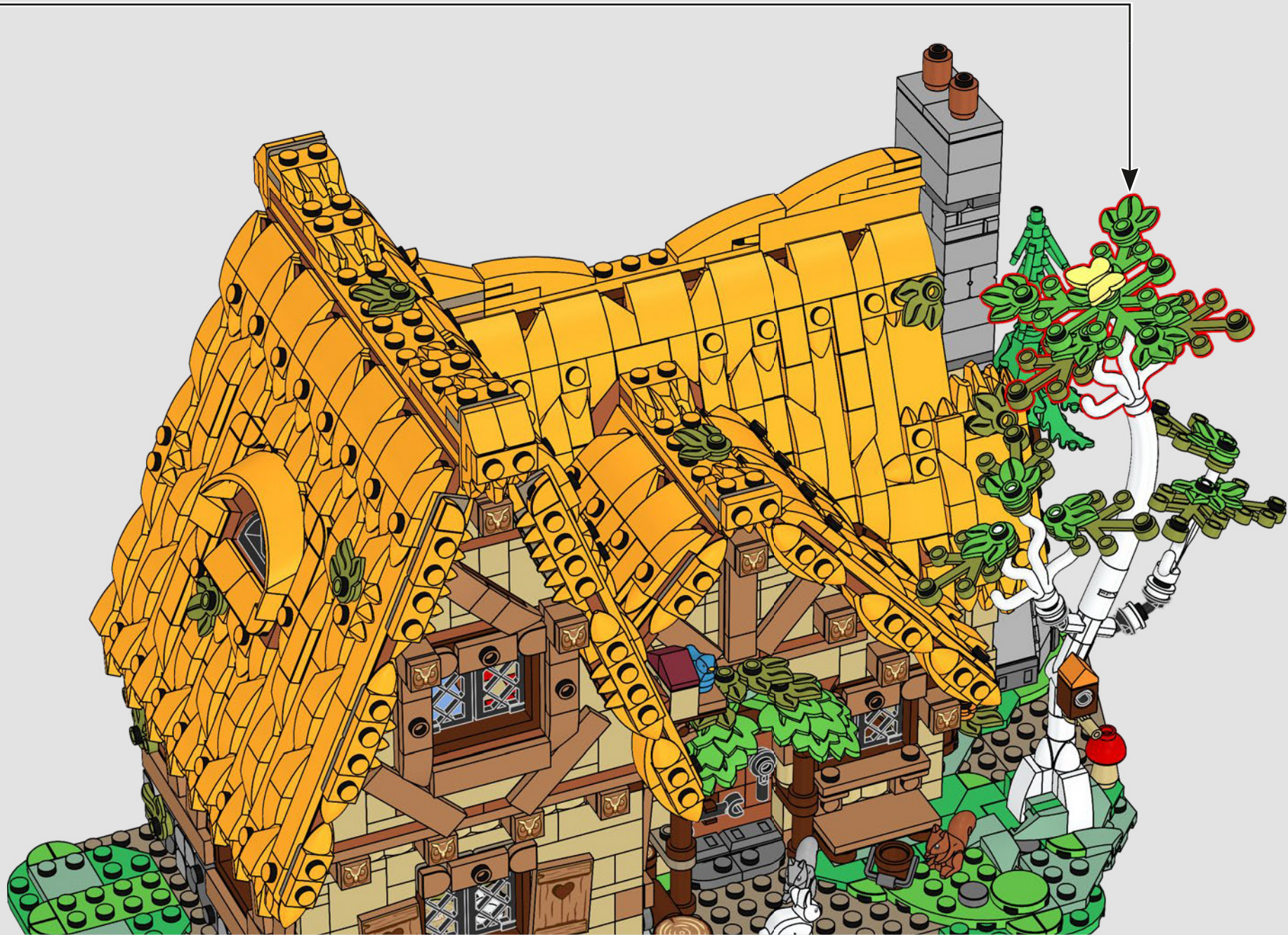

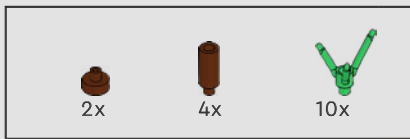

446

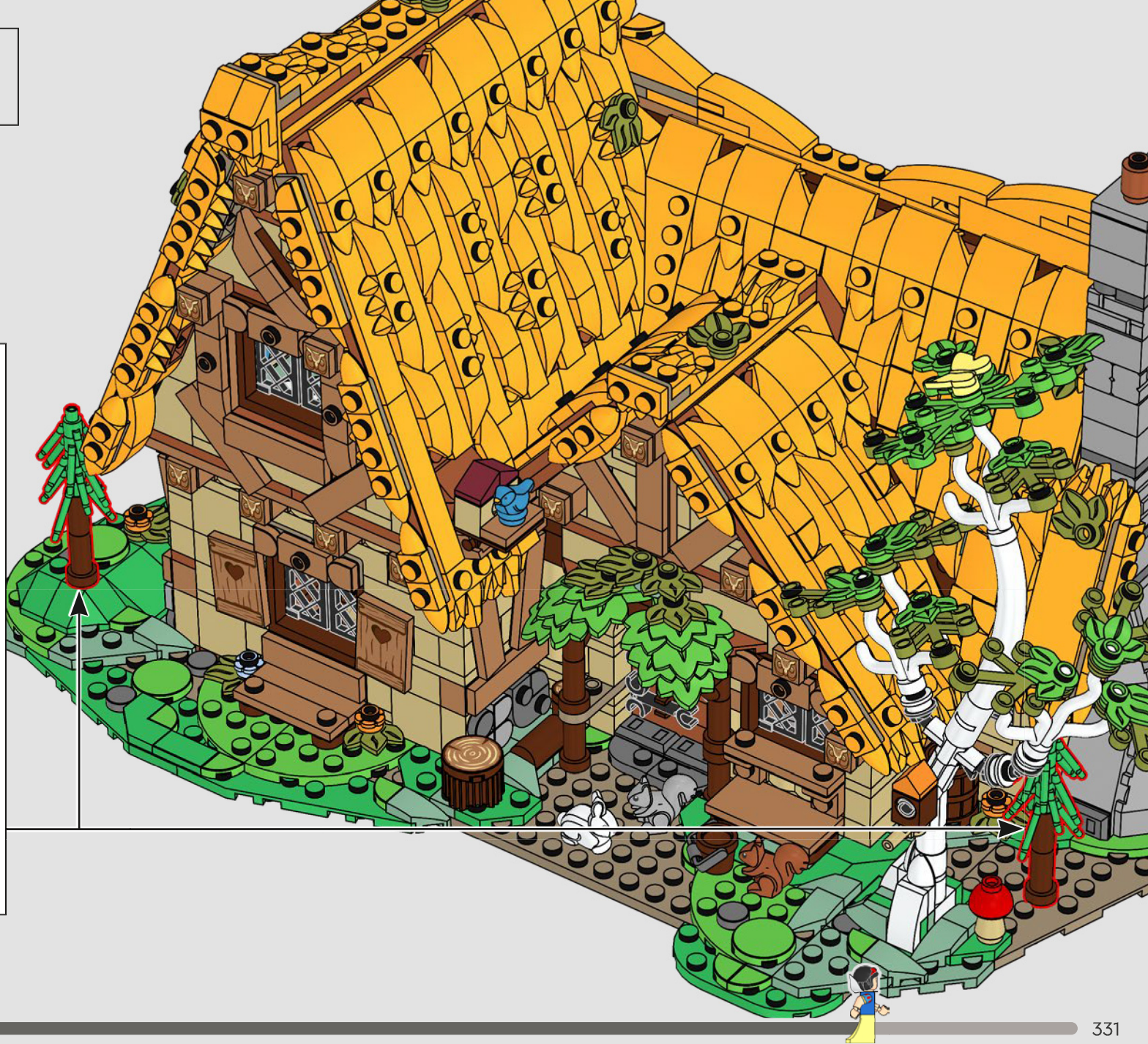
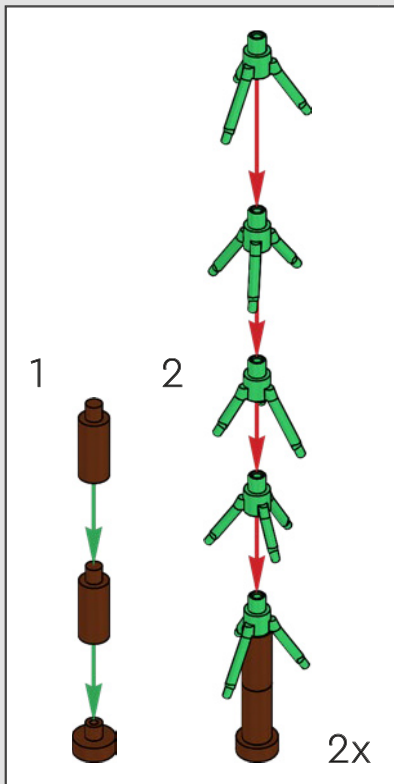



447





448



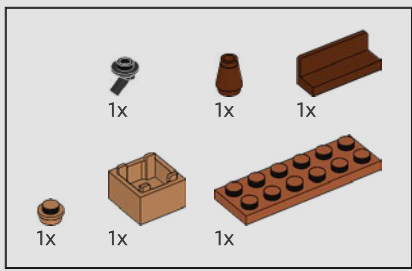

449

1

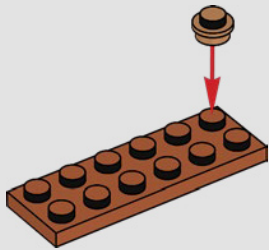

2

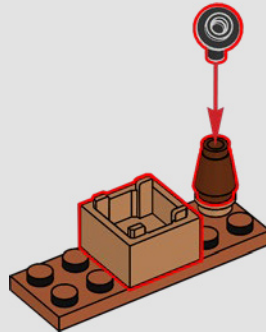

3

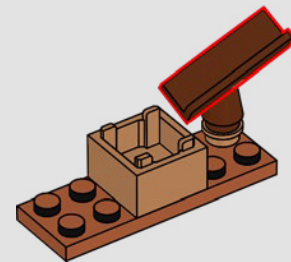





450





-  1x
-  1x
-  1x
-  1x

451



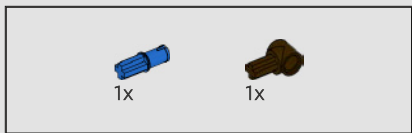

452

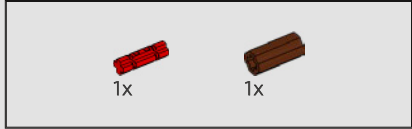
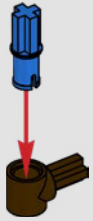

453

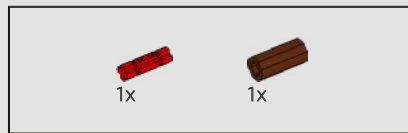

454



455

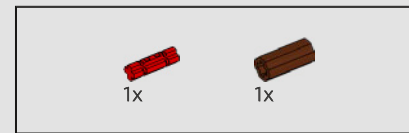

456

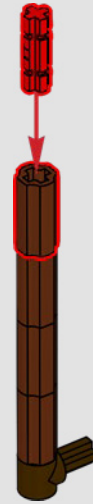

457

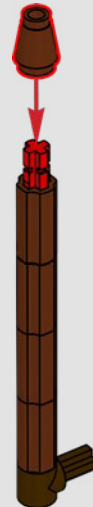

458



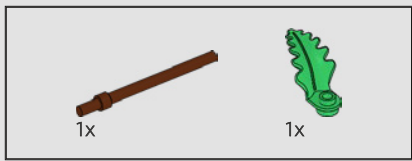

459

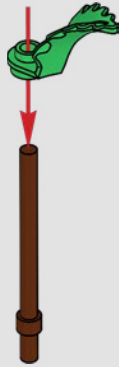

460

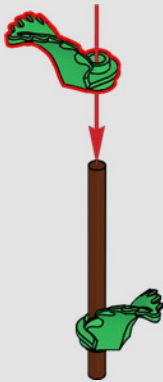

461

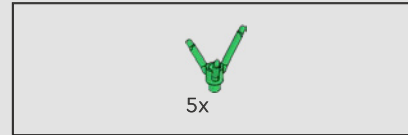

462

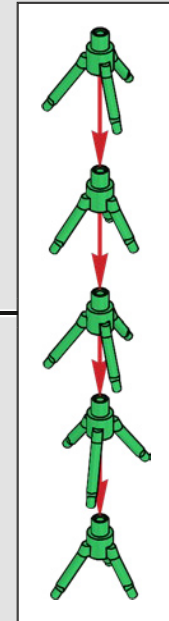



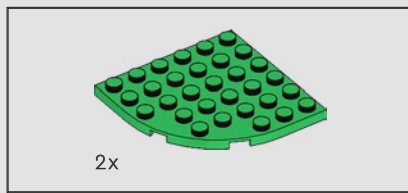

1

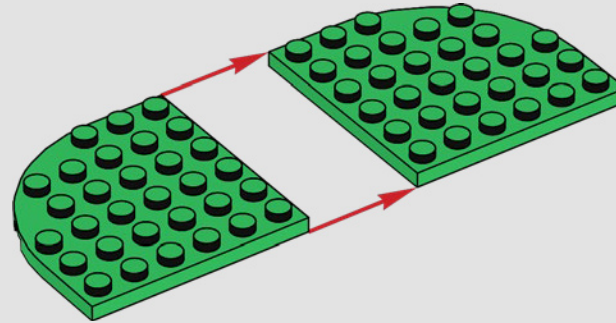

2

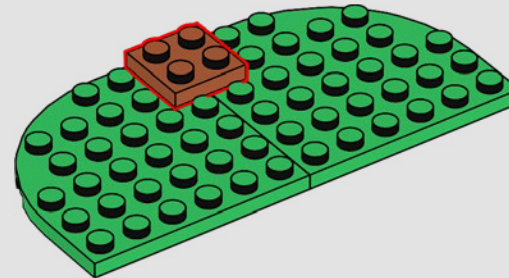

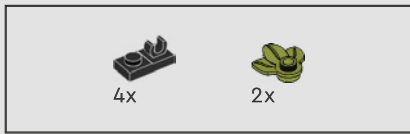

3

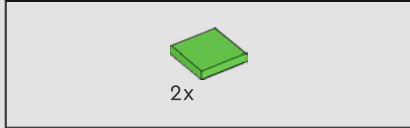
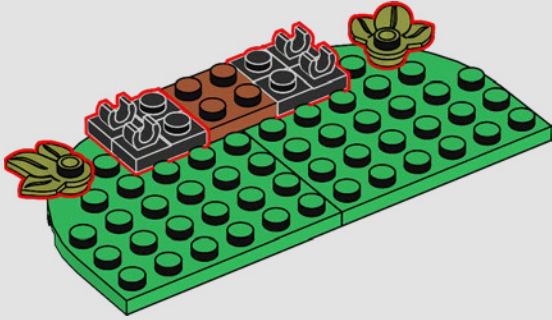

4

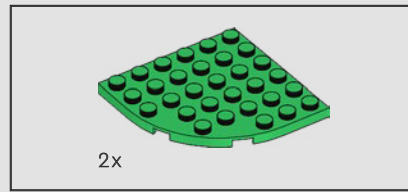
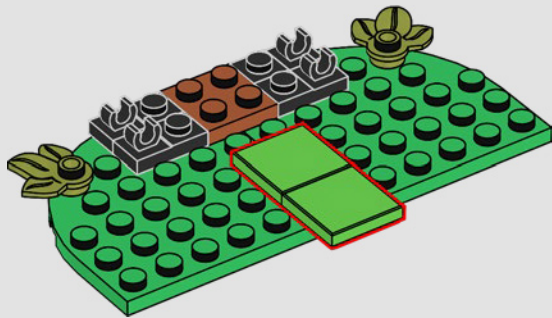

5

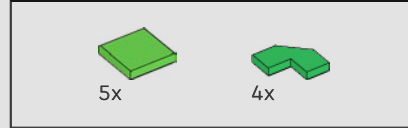

6

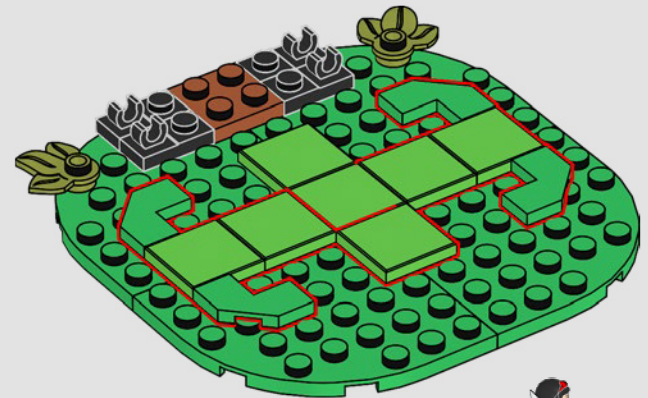

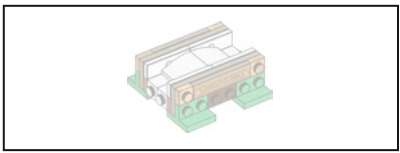

7

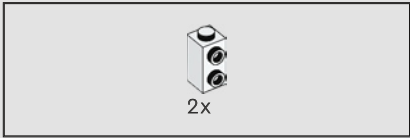

8

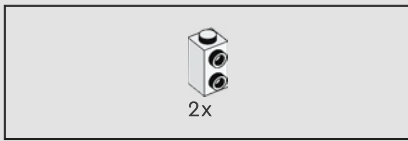
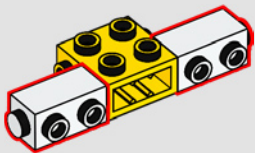

9

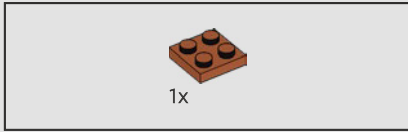
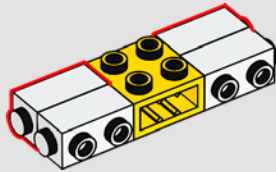

10

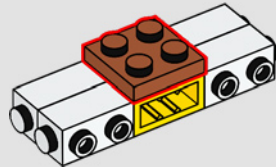



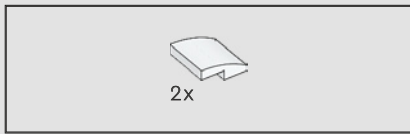

11

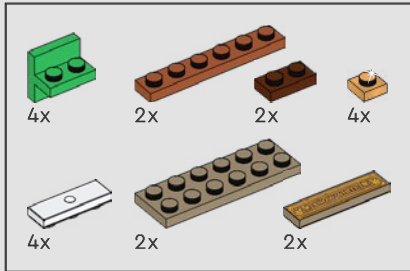
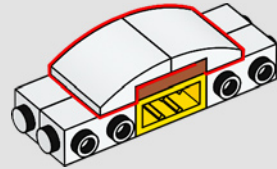

12

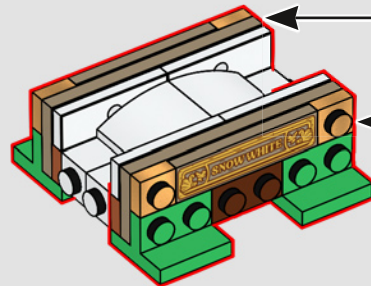
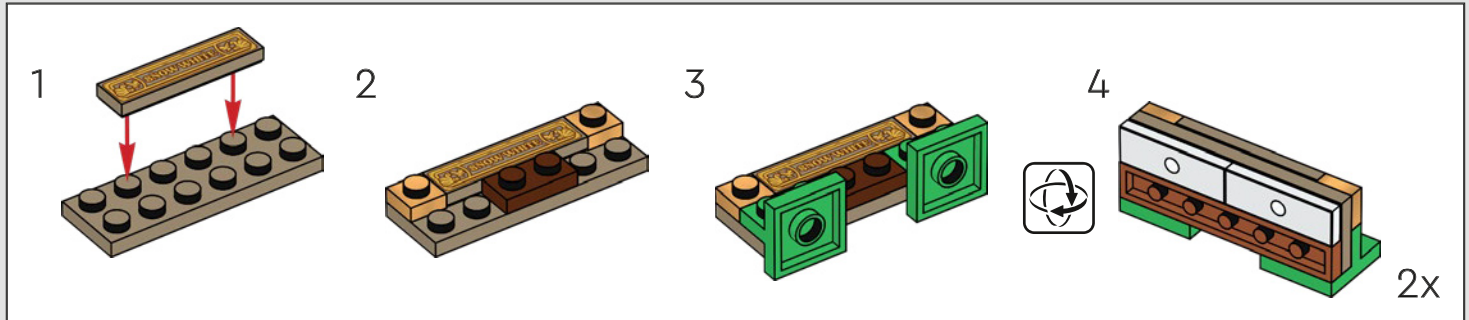

13

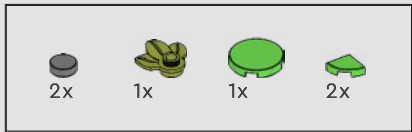
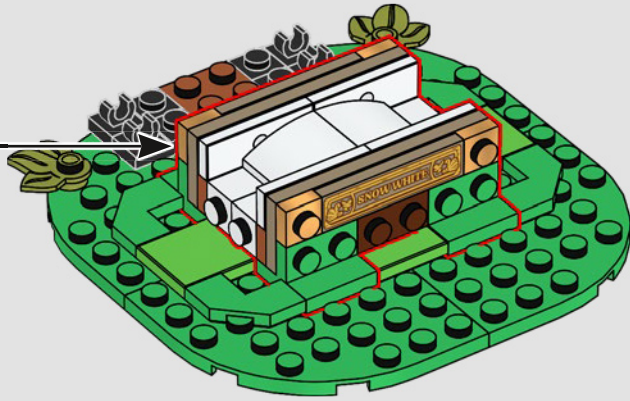

14

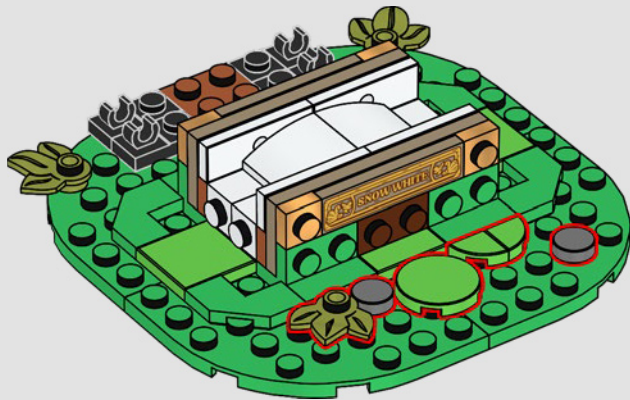

15

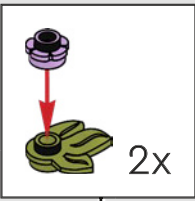
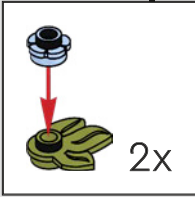
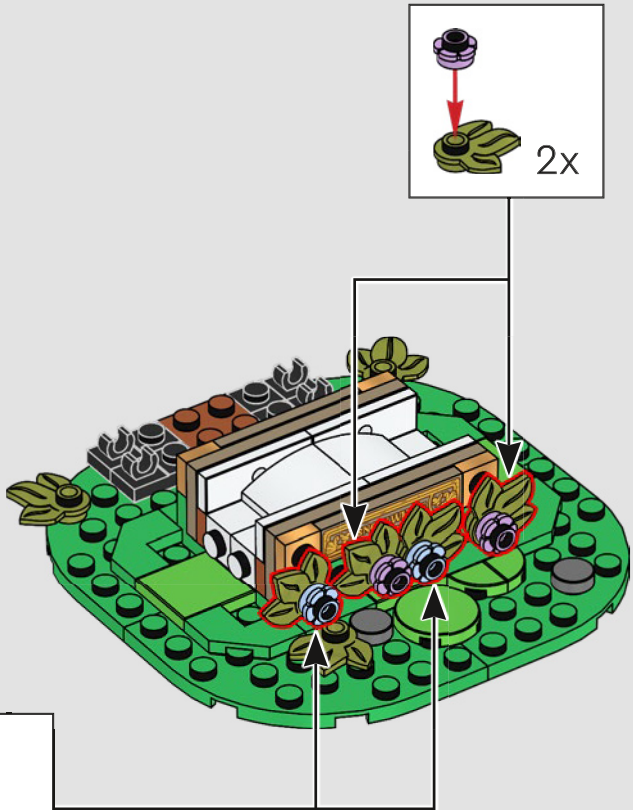

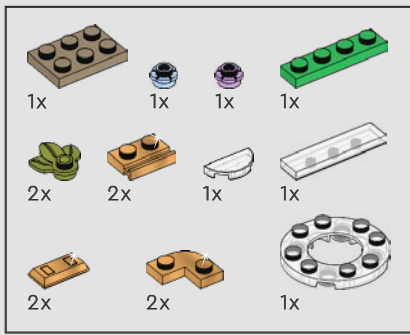

# 16

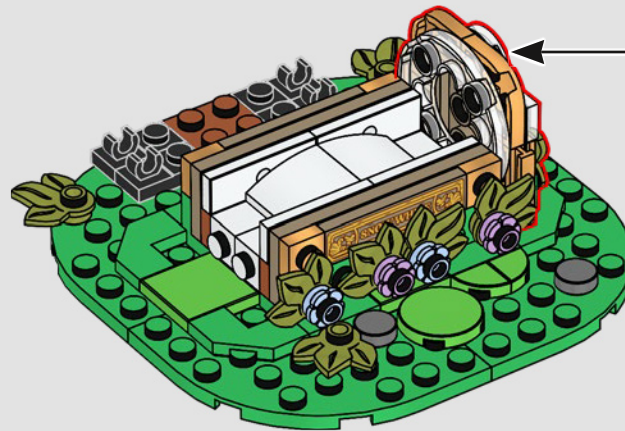
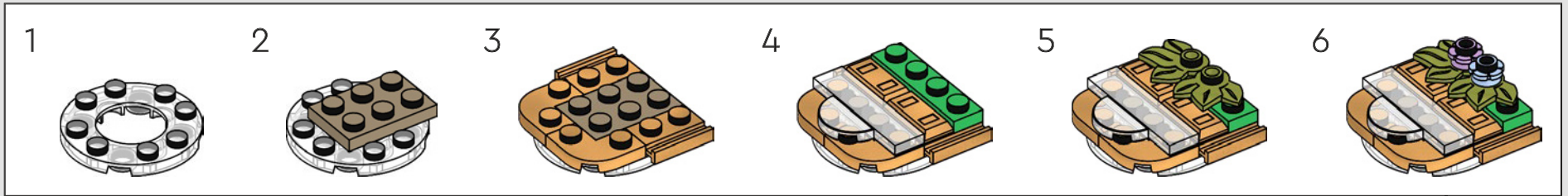

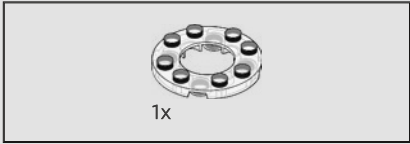
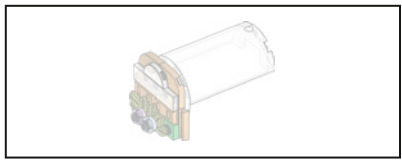

17

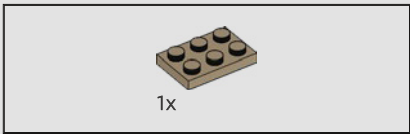

18

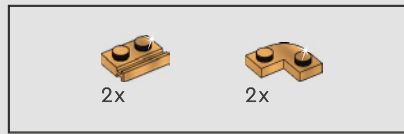

19

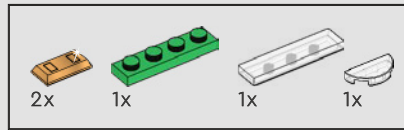
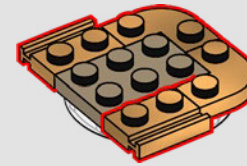

20

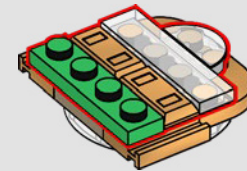

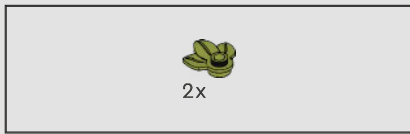

21

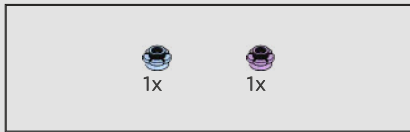
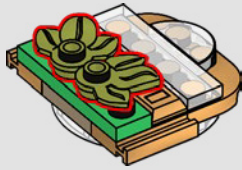

22

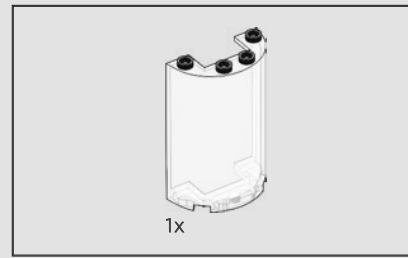
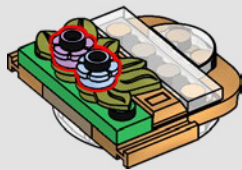

23

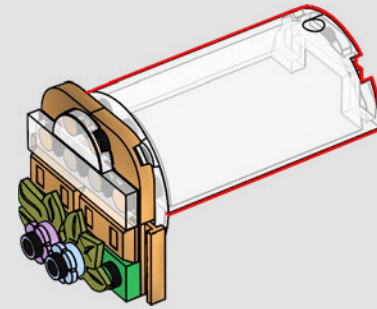

24

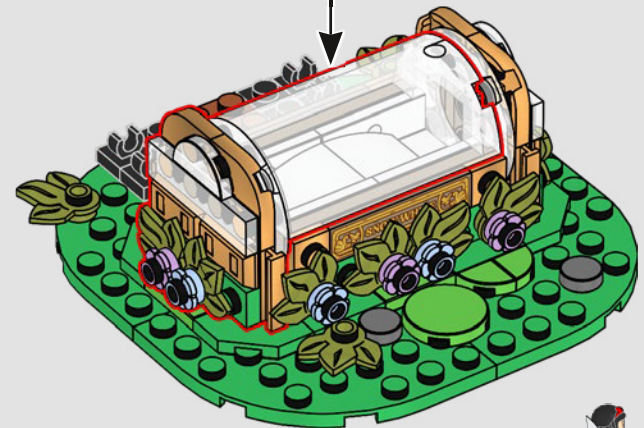

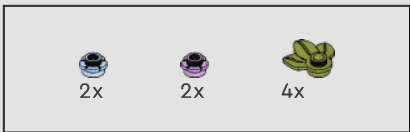

25

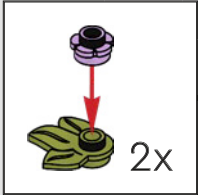
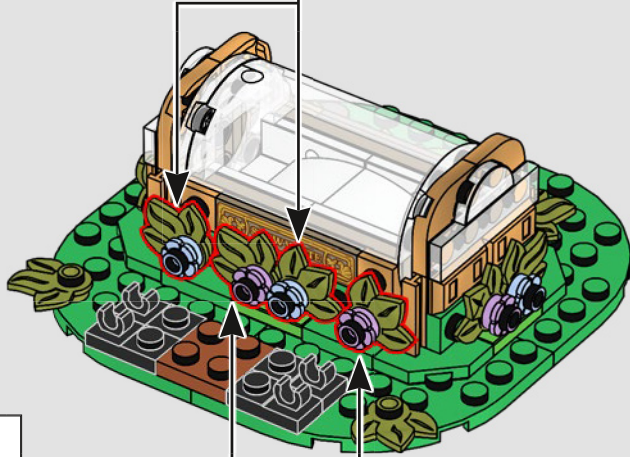
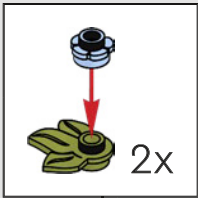

26

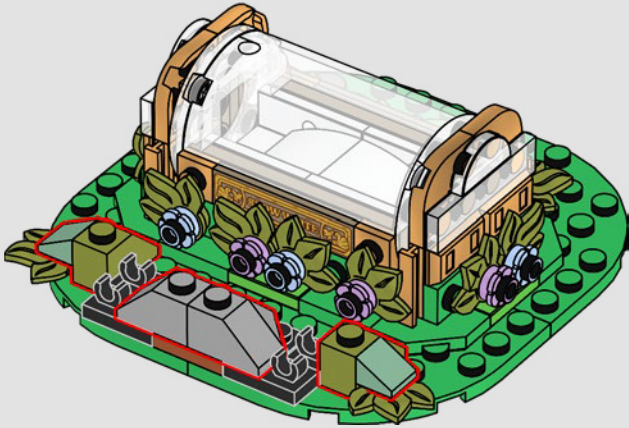



27

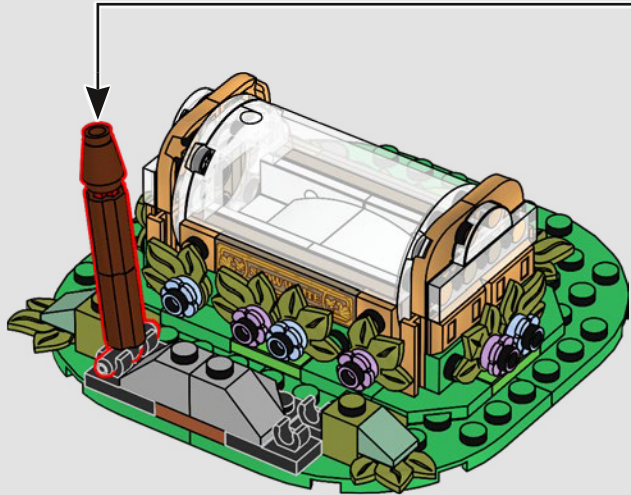
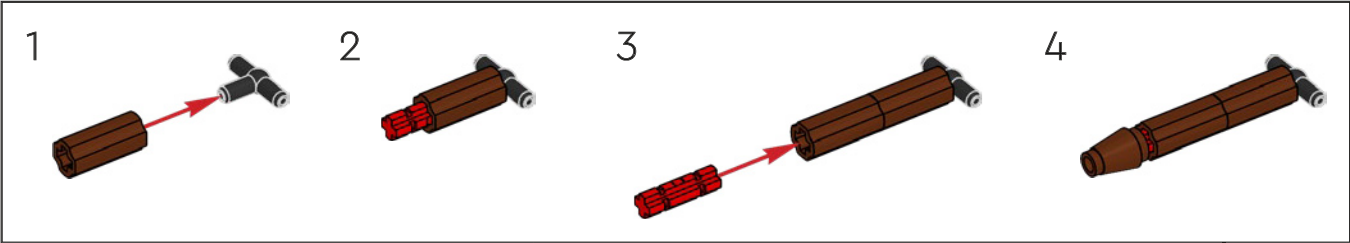

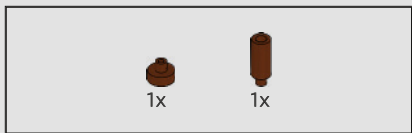

28

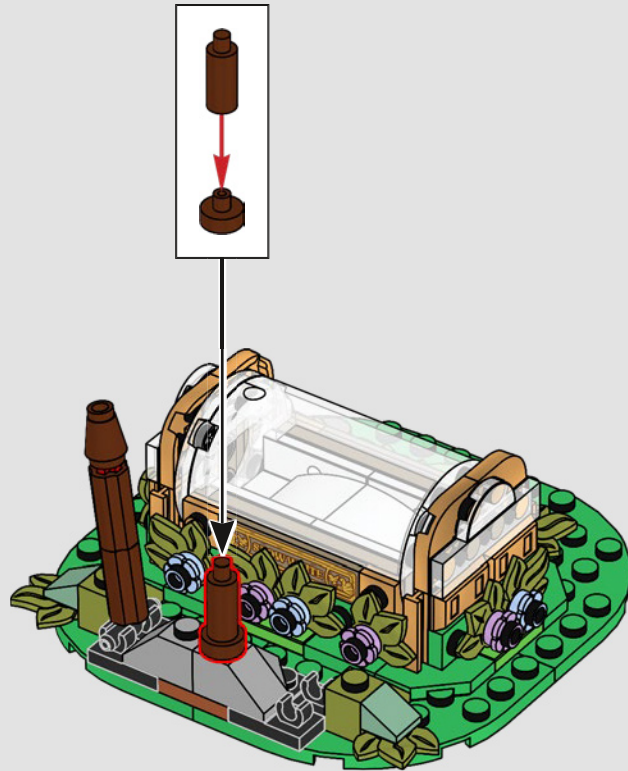



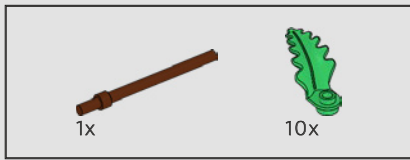

29

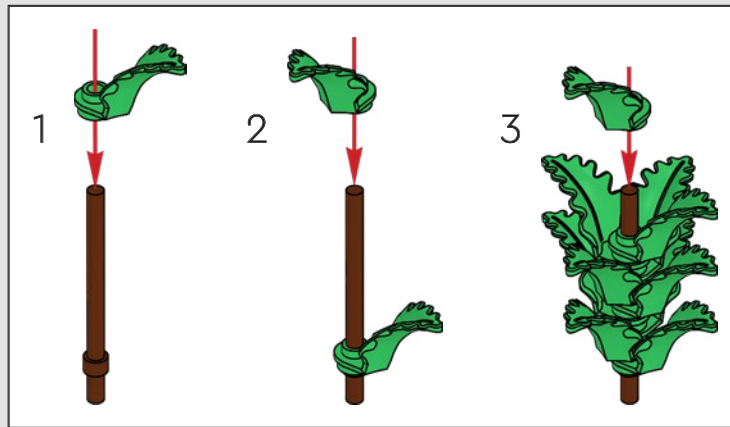



10x

30

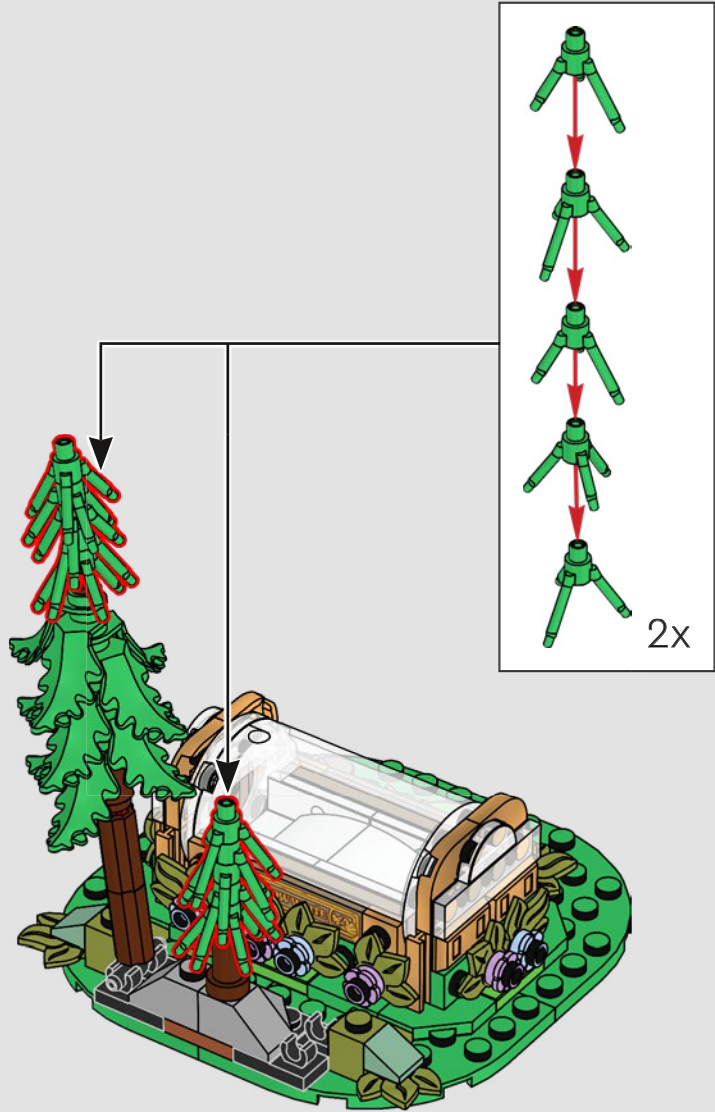

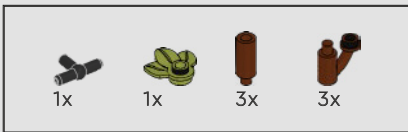

31

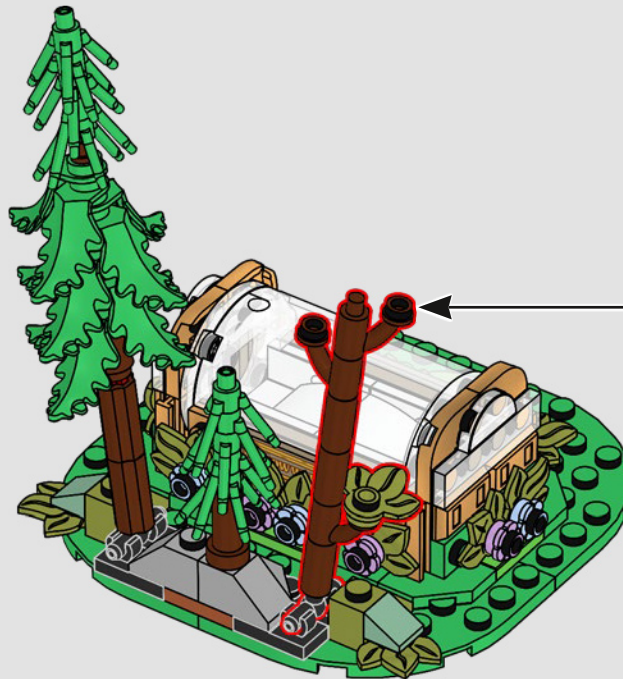
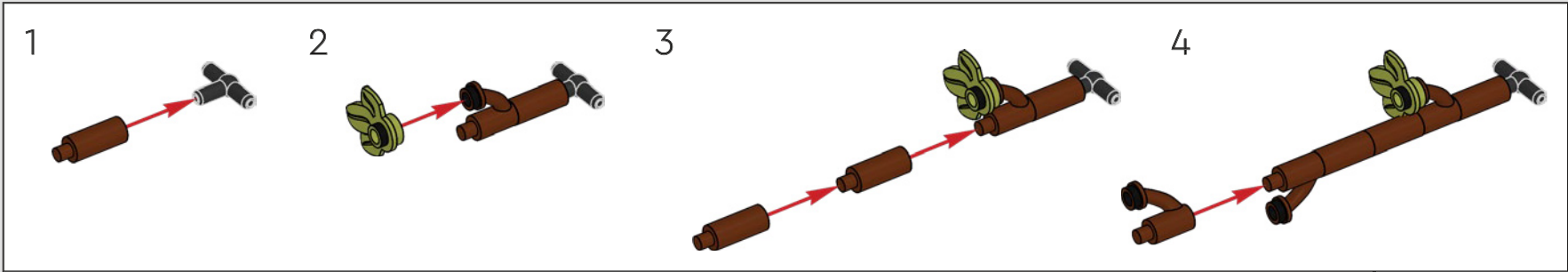

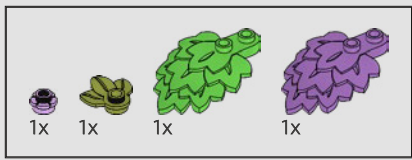

32

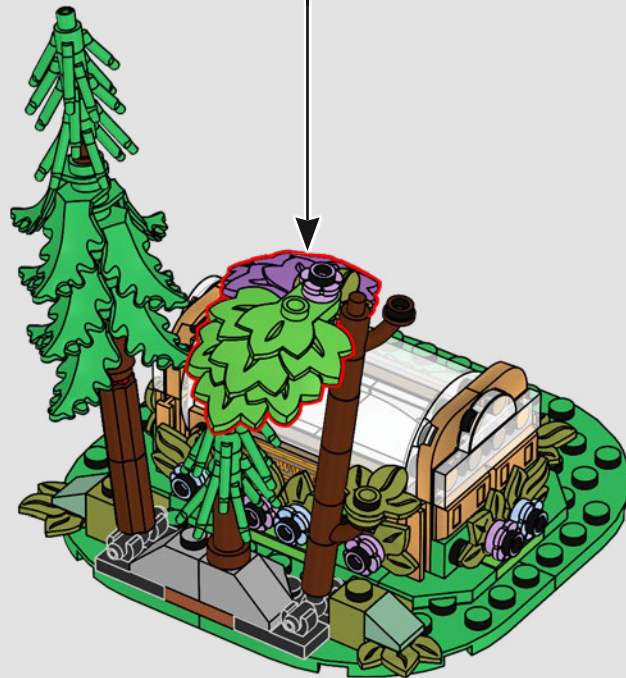
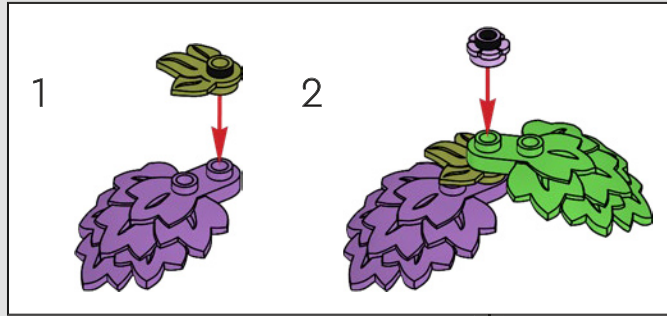

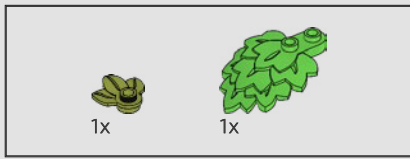

33

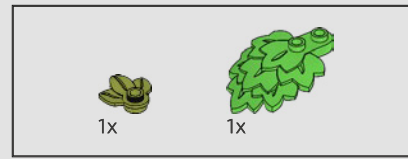
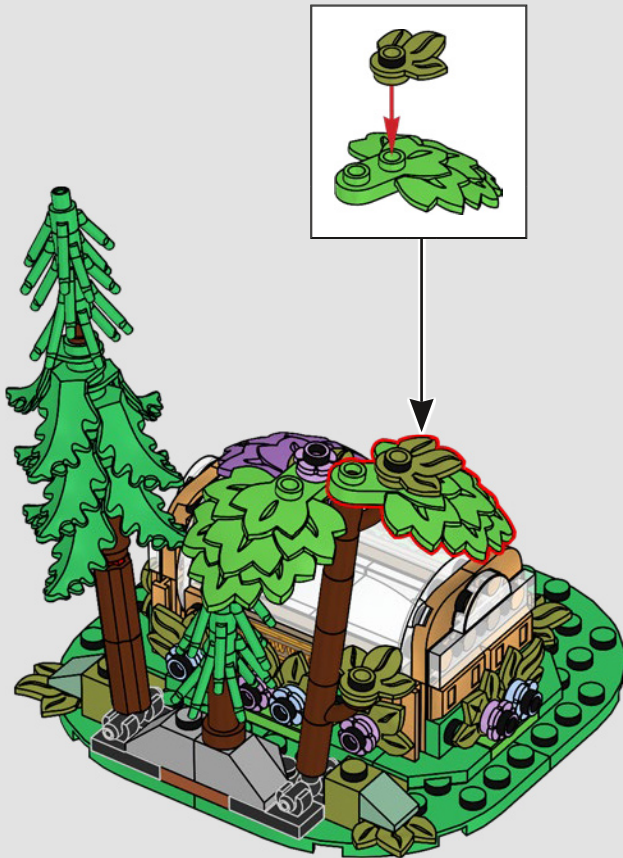

34

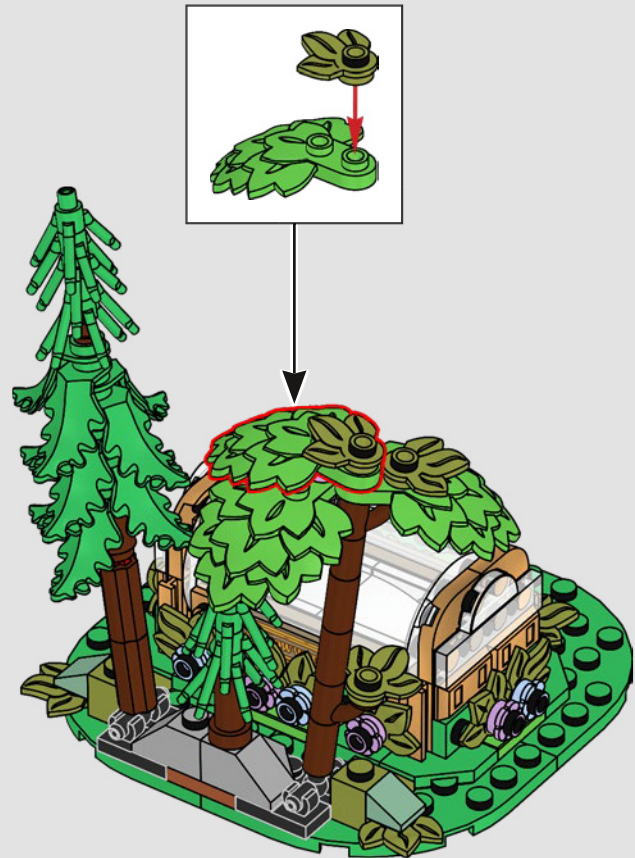





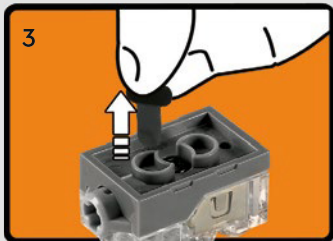

1:1  
2x LR 41 1.5V



## EN

### Important information about batteries

Never use different types of batteries together, or a combination of old and new batteries. Always remove the batteries if the product is not to be used for a long time or if the batteries have run down. Never use damaged batteries. Only use alkaline type batteries. Insert the batteries so that the poles are correctly positioned. Never attempt to recharge non-rechargeable batteries. Never short-circuit the battery holder.

## DE

### Wichtige Informationen zu Batterien

Benutzen Sie niemals unterschiedliche Arten von Batterien oder alte und neue gleichzeitig. Nehmen Sie stets die Batterien heraus, wenn mit dem Modell längere Zeit nicht gespielt wird oder wenn die Batterien leer sind. Verwenden Sie niemals beschädigte Batterien. Verwenden Sie ausschließlich Alkali-Batterien. Achten Sie beim Einsetzen der Batterien auf die richtige Polung. Versuchen Sie unter keinen Umständen, „normale“ Batterien wieder aufzuladen. Schließen Sie das Batteriefach niemals kurz.

## FR

### Informations importantes concernant les piles

Ne jamais utiliser un mélange de différents types de piles, ou de piles neuves et de piles anciennes ou déjà utilisées. Toujours retirer les piles si le produit n'est pas utilisé durant une période prolongée ou si les piles sont vides. Ne jamais utiliser de piles endommagées. N'utiliser que des piles alcalines. En insérant les piles, respecter scrupuleusement le sens d'orientation des pôles (+/-). Ne jamais essayer de recharger des piles non rechargeables. Ne jamais court-circuiter le compartiment des piles.

## IT

### Importanti informazioni sulle batterie

Non usare mai contemporaneamente batterie di tipo diverso o batterie nuove e usate insieme. Rimuovere sempre le batterie qualora il prodotto non venga utilizzato per periodi prolungati, oppure se le batterie sono esauste. Non utilizzare mai batterie danneggiate. Utilizzare solo batterie di tipo alcalino. Inserire le batterie avendo cura che la loro polarità sia corretta. Non tentare mai di ricaricare batterie non ricaricabili. Non cortocircuitare mai il portabatterie.

## NL

### Belangrijke informatie over batterijen

Gebruik nooit verschillende soorten of een combinatie van oude en nieuwe batterijen tegelijkertijd. Verwijder de batterijen altijd als je het product lange tijd niet wilt gebruiken of als batterijen leeg zijn. Gebruik nooit beschadigde batterijen. Gebruik alleen alkalinebatterijen. Plaats de batterijen met de polen in de juiste richting. Probeer nooit niet-oplaadbare batterijen opnieuw op te laden. Laat de batterijhouder nooit kortsluiten.

## ES

### Información importante acerca de las pilas

No use pilas de diferentes tipos ni pilas nuevas y antiguas para alimentar el producto. Extraiga las pilas del producto si este va a permanecer sin uso durante un período prolongado de tiempo o aquellas se han agotado. No use pilas dañadas. Use solo pilas alcalinas. Inserte las pilas de modo que los polos queden situados en las posiciones correctas. No trate de cargar pilas no recargables. No cortocircuite el compartimento de las pilas.

## DA

### Vigtige oplysninger om batterier

Brug aldrig forskellige batterityper sammen eller en kombination af gamle og nye batterier. Fjern altid batterierne, hvis produktet ikke skal bruges i lang tid, eller hvis batterierne er flade. Brug aldrig beskadigede batterier. Brug kun alkaliske batterier. Sæt batterierne i, så polerne vender den rigtige vej. Forsøg aldrig at oplade ikke-genopladelige batterier. Kortslut aldrig batteriholderen.

## IS

### Mikilvægar upplýsingar um rafhlöður

Aldrei skal nota mismunandi gerðir rafhlaðna samtímis, né nýjar og eldri rafhlöður samtímis. Ef ekki á að nota tækið í lengri tíma eða ef rafhlöðurnar eru orðnar tómar skal fjarlægja rafhlöðurnar. Aldrei skal nota rafhlöður sem hafa skemmt. Eingöngu má nota alkaline-rafhlöður. Setja skal rafhlöðurnar í þannig að plús- og mínusskaut þeirra snúi rétt. Aldrei skal reyna að endurhlaða rafhlöður sem ekki eru endurhlaðanlegar. Aldrei ætti að valda skammhlaupi í rafhlöðuhólfinu.

## FI

### Tärkeää tietoa paristoista

Älä koskaan käytä erityyppisiä paristoja yhdessä. Älä myöskään käytä samassa laitteessa sekä vanhoja että uusia paristoja. Poista paristot tuotteesta aina, kun se on pitemmän aikaa käyttämättä, tai kun paristot ovat tyhjentyneet. Älä koskaan käytä viallisia paristoja. Käytä vain alkaliparistoja. Aseta paristot siten, että navat osoittavat oikeaan suuntaan. Älä koskaan aiheuta oikosulkua pariston kosketinten välillä.

## SV

### Viktig information om batterier

Använd aldrig olika sorters batterier samtidigt, och inte heller en kombination av gamla och nya batterier. Ta alltid ur batterierna om produkten inte ska användas under en längre tid eller om batterierna är slut. Använd aldrig skadade batterier. Använd endast alkaliska batterier. Sätt i batterierna så att polerna hamnar i rätt läge. Försök aldrig ladda icke-laddningsbara batterier. Kortslut aldrig batteriutrymmets kontaktytor.

## NO

### Viktig informasjon om batterier

Bruk aldri ulike typer batterier sammen og heller aldri gamle og nye batterier sammen. Ta alltid ut batteriene hvis produktet ikke skal brukes på lang tid, eller hvis batteriene er brukt opp. Bruk aldri skadde batterier. Bruk bare alkaliske batterier. Sett inn batteriene med polene vendt riktig vei. Forsøk aldri å lade opp ikke-oppladbare batterier. Kortslett aldri batteriholderen.

## PT

### Informação importante sobre as pilhas

Nunca use diferentes tipos de pilhas em simultâneo, ou uma combinação de pilhas usadas e novas. Retire sempre as pilhas se o produto não for usado durante muito tempo ou se as pilhas já não tiverem carga. Nunca use pilhas danificadas. Use apenas pilhas alcalinas. Insira as pilhas de forma a que os polos fiquem corretamente posicionados. Nunca tente recarregar pilhas não recarregáveis. Nunca deixe o compartimento das pilhas entrar em curto-circuito.

## EL

### Σημαντικές πληροφορίες για τις μπαταρίες

Μην χρησιμοποιείτε ποτέ διαφορετικού τύπου μπαταριών μαζί και μην συνδυάζετε παλιές και καινούριες μπαταρίες. Αφαιρείτε πάντα τις μπαταρίες αν δεν σκοπεύετε να χρησιμοποιήσετε το προϊόν για αρκετό καιρό ή αν οι μπαταρίες έχουν αδειάσει. Ποτέ μην χρησιμοποιείτε μπαταρίες που έχουν φθορές. Χρησιμοποιείτε μόνο αλκαλικές μπαταρίες. Τοποθετήστε τις μπαταρίες με τους πόλους στη σωστή θέση. Μην επιχειρήσετε ποτέ να επαναφορτίσετε μη επαναφορτιζόμενες μπαταρίες. Ποτέ μην βραχυκυκλώνετε τη θήκη των μπαταριών.

## JA

### 電池取扱いに関する重要事項

異なるタイプの電池や古い電池を混ぜて使用しないでください。商品を長時間使用しないときや電池が切れたときは、電池を必ず取り外してください。不具合のある電池は絶対に使用しないでください。アルカリタイプの電池のみを使用してください。電極を確認して電池を正しい向きに入れてください。充電式ではない電池は絶対に充電しないでください。電池ホルダをショートさせないでください。

## ZH

### 電池使用注意事項

请勿同时使用不同类型的电池，或把新旧程度不同的电池混合使用。如果产品将有很长时间不会使用，或者电池已经没电，请注意取出电池。切勿使用已破损的电池。仅可使用碱性电池。装入电池时请注意正负极。请勿尝试给非充电电池充电。切勿对电池仓进行短路连接。

## KO

### 배터리 사용 시 주의사항

다른 종류의 배터리를 함께 사용하거나, 새 전지와 오래된 전지를 혼용하지 마세요. 배터리가 방전되었거나 장기간 제품을 작동하지 않을 때에는 반드시 배터리를 분리하세요. 파손된 배터리는 사용하지 마세요. 알칼라인 타입의 배터리만을 사용하세요. 양극과 음극의 위치를 잘 맞춰서 넣으세요. 일반 배터리는 충전해서 사용할 수 없습니다. 배터리 홀더의 접촉부에 배터리를 정확히 끼워서 사용하세요.

## RU

### Необходимая информация об элементах питания

Ни в коем случае не используйте одновременно элементы питания различных типов, а также элементы питания с разным сроком годности. В обязательном порядке вынимайте элементы питания из терминалов в случае, если вы не пользуетесь прибором в течение долгого времени, либо в случае, если в элементах питания закончился заряд. Ни в коем случае не используйте поврежденные элементы питания. Используйте только элементы питания щелочного типа. Установите элементы питания, соблюдая указанную полярность. Ни в коем случае не пытайтесь подзаряжать непerezаряжаемые элементы питания. Ни в коем случае не пытайтесь замкнуть полюса в устройстве для элементов питания.

## PL

### Ważne informacje dotyczące baterii

Nigdy nie należy stosować razem różnych rodzajów baterii ani stosować równocześnie starych i nowych baterii. Jeżeli produkt nie jest używany przez dłuższy czas lub jeżeli baterie się wyczerpały, należy wyjąć baterie. Nigdy nie należy stosować uszkodzonych baterii. Należy używać wyłącznie baterii alkalicznych. Przy wkładaniu baterii należy zwrócić uwagę na właściwe położenie biegunów. Nigdy nie należy próbować ładowania baterii jednorazowych. Nigdy nie należy doprowadzać do zwarcia w gnieździe baterii.

## CZ

### Důležitá informace o bateriích

Nikdy nepoužívejte najednou různé typy baterií nebo kombinaci starých a nových baterií. Nebude-li se výrobek delší dobu používat nebo jsou-li baterie vybité, vždy je vyjměte z výrobku. Nikdy nepoužívejte poškozené baterie. Používejte pouze alkalické baterie. Baterie instalujte se správnou orientací pólů. Nikdy se nesazte nabíjet baterie, které nejsou nabíjitelné. Nikdy nezkratujte kontakty v prostoru pro baterie.

## SK

### **Důležitá informace o bateriích**

Nikdy nepoužívejte naraz odlišné typy baterií ani nekombinujte staré baterie s novými. Baterie vždy vyberte, ak sa výrobok nebude dlhšie používať, alebo ak sa baterie vybili. Nikdy nepoužívejte poškodené baterie. Používajte iba alkalické baterie. Baterie vkladajte so správnou orientáciou pólov. Nikdy sa nesnažte nabíjať batérie, ktoré nie sú nabíjateľné. Nikdy neskratujte kontakty v priestore pre batérie.

## HU

### **Fontos tudnivalók az elemekről**

Soha ne használjon különböző típusú elemeket, illetve ne használjon vegyesen új és használt elemeket. Mindig távolítsa el az elemeket, ha a készüléket előre láthatóan hosszabb ideig nem fogják használni, vagy ha az elemek lemerültek. Soha ne használjon megrongálódott elemeket. Csak alkáli elemeket használjon! Az elemeket helyesen helyezze be, a polaritásuknak megfelelően. Soha ne próbálja meg feltölteni a nem tölthető elemeket. Soha ne hozzon létre rövidzárlatot az elemtartó kivezetésein.

## UA

### **Необхідна інформація про батареї**

Ніколи не використовуйте одночасно батареї різних типів або батареї з різним терміном придатності. Обов'язково вилучайте батареї з приладу, якщо довго не користуетесь ним, або якщо в батареях уже скінчився заряд. Ніколи не використовуйте пошкоджені батареї. Використовуйте лише лужні батареї. Вставляйте батареї, враховуючи задану полярність. У будь-якому випадку не намагайтеся підзарядити батареї, що не підлягають підзарядці. У будь-якому випадку не намагайтеся зробити коротке замикання в приладі для батарей.

## HR

### **Važne obavijesti o bateriji**

Nikada nemoj koristiti različite vrste baterija zajedno, isto tako ni kombinaciju starih i novih baterija. Uvijek izvadi baterije ako dugo nećeš koristiti proizvod ili ako su one potrošene. Nikada nemoj koristiti oštećene baterije. Upotrebljavajte samo alkalne baterije. Umetni baterije pazeći da dobro okreneš polove. Nikada ne pokušavaj puniti baterije koje nisu predviđene za punjenje. Nikada ne izazivaj kratki spoj u držaču baterija.

## SR

### **Важне информације о батеријама**

Никада не користите различите типове батерија заједно нити комбинацију старих и нових батерија. Увек извадите батерије уколико производ нећете дуже време користити или уколико су батерије празне. Никада не користите оштећене батерије. Користите само алкалне батерије. Ставите батерије тако да су полови правилно позиционирани. Никада не покушавајте да пуните батерије које не могу да се пуне. Никада не изазивајте кратак спој у кућишту за батерије.

## MK

### **Важни информации за батериите**

Никогаш не користете различни типови батери заедно или комбинација од стари и нови батери. Секогаш отстранувајте ги батериите доколку не го користите производот подолго време или доколку се потрошиле. Никогаш не користете оштетени батери. Користете само алкални батери. Вметнете ги батериите така што точно ќе ги наместите половите. Никогаш не обидувајте се да ги полните батериите за еднократна употреба. Никогаш не предизвикувајте краток спој на држачот за батери.

## SL

### **Pomembne informacije o baterijah**

Nikoli ne uporabljajte skupaj različnih baterij ali kombinacije starih in novih baterij. Vedno odstranite baterije, če izdelka dlje časa ne boste uporabljali ali če so iztrošene. Nikoli ne uporabljajte poškodovanih baterij. Uporabljajte le alkalne baterije. Baterije vstavite tako, da so njihovi polji pravilno obrnjeni. Nikoli ne poskušajte polniti baterij, ki niso akumulatorske. Pazite, da ležišč za baterije ne boste spravili v kratek stik.

## RO

### **Informații importante despre baterii**

Nu folosiți niciodată împreună tipuri diferite de baterii, sau o combinație de baterii vechi și noi. Îndepărtați întotdeauna bateriile dacă produsul nu este folosit timp îndelungat sau dacă bateriile s-au epuizat. Nu folosiți niciodată baterii deteriorate. Utilizați numai baterii de tip alcalin. Introduceți bateriile astfel ca polii să fie poziționați corect. Nu încercați niciodată să reîncărcați baterii nereîncărcabile. Nu scurtcircuitați niciodată suportul bateriei.

## BG

### Важна информация за батериите

Никога не използвайте едновременно различни типове батерии или комбинация от стари и нови батерии. Винаги изваждайте батериите, ако izdelieto няма да се използва продължително време или ако батериите са се изтощили. Никога не използвайте повредени батерии. Използвайте само алкални батерии. Поставете батериите така, че полюсите да са разположени правилно. Никога не опитвайте да зареждате батерии, които не са акумулаторни. Никога не свързвайте на късо контактите на отделението за батериите.

## LV

### Svarīga informācija par baterijām

Nekad vienlaikus nelietojiet dažādu tipu, kā arī vecas un jaunas baterijas. Vienmēr izņemiet baterijas, ja tās ir izlādējušās vai ja produkts ilgāku laiku netiek lietots. Nekad nelietojiet bojātas baterijas. Izmantojiet tikai sārma tipa baterijas. Ievietojot baterijas, ievērojiet pareizu polaritāti. Nekad nemēģiniet uzlādēt baterijas, kas nav uzlādējamās. Nepieļaujiet issavienojumu bateriju nodalījumā.

## ET

### Oluline teave patareide kohta

Ära kunagi kasuta koos erinevat tüüpi patareisid, samuti vanu ja uusi patareisid. Kui mänguasja ei kasutata pika aja jooksul, võta patarei sellest välja. Ära kunagi kasuta kahjustatud patareisid. Kasuta ainult leelispatareisid. Pane patareid mänguasja sisse nii, et pluss- ja miinusklemmi asend oleks õige. Ära kunagi proovi akulaadijaga laadida tavalisi patareisid. Patareipesa klemmide vahel ei tohi tekkida lühist.

## LT

### Svarbi informacija apie elementus

Vienu metu nenaudokite skirtingų elementų, taip pat su naujais elementais nenaudokite senų. Jei nenaudosite gaminio ilgesnį laiką arba jei elementai išseko, visuomet išimkite juos iš gaminio. Niekada nenaudokite pažeistų elementų. Naudokite tik šarminius elementus. Elementus dėkite atsižvelgdami į jų poliškumą. Niekada nebandykite įkrauti vienkartinį elementų. Saugokitės, kad elementų įdėkle nesukeltumėte trumpojo jungimo.

## TR

### Piller hakkında önemli bilgiler

Hiçbir zaman farklı tipte pilleri ya da eski pillerle yeni pilleri bir arada kullanmayın. Ürün uzun süre kullanılmayacaksa ya da piller bitmişse, pilleri ürünün içinden çıkarın. Hiçbir zaman zedelenmiş piller kullanmayın. Sadece alkaalin piller kullanın. Pilleri kutupları doğru konumda olacak şekilde yerleştirin. Hiçbir zaman, şarj edilebilir olmayan pilleri şarj etmeye çalışmayın. Hiçbir zaman pil kutusuna kısa devre yaptırmayın.

## AR

### معلومات مهمة عن البطاريات

يحظر استخدام أنواع مختلفة من البطاريات معا أو مزيج من البطاريات القديمة و الجديدة. أحرص دائما على نزع البطاريات في حال عدم استخدام المنتج لفترة طويلة أو إذا نفذت طاقة البطاريات. تجنب استخدام البطاريات التالفة. لا تستخدم إلا البطاريات القلوية فقط. قم بتكيب البطاريات بحيث تكون الأقطاب في موضعها الصحيح. يحظر إعادة شحن البطاريات غير القابلة لإعادة الشحن. تجنب إحداث دائرة قصر في حامل البطارية.

## ID

### Informasi penting tentang baterai

Jangan gunakan baterai yang jenisnya berlainan, atau mencampur baterai lama dan baterai baru. Lepas baterai jika produk tidak akan digunakan untuk waktu lama atau jika baterai sudah lemah. Jangan gunakan baterai yang rusak. Gunakan hanya baterai alkali. Masukkan baterai dengan posisi kutub yang tepat. Jangan pernah coba mengisi ulang baterai biasa. Jangan pernah membuat arus pendek pada dudukan baterai.

## MS

### Maklumat penting tentang bateri

Jangan guna jenis bateri yang berbeza bersama-sama, atau gabungan bateri baharu dan lama. Tanggalkan bateri jika produk tidak akan digunakan untuk tempoh masa yang lama atau jika bateri telah kehabisan kuasa. Jangan guna bateri yang rosak. Guna bateri jenis alkali sahaja. Selitkan bateri supaya paksi berada pada kedudukan yang betul. Jangan cuba untuk mengecas semula bateri yang tidak boleh dicaskan semula. Jangan pintas litar pemegang bateri.



EN  
WARNING: This product contains a Button or Coin Cell Battery. A swallowed Button or Coin Cell battery can cause internal chemical burns in as little as two hours and lead to death. Dispose of used batteries immediately. Keep new and used batteries away from children. If you think batteries might have been swallowed or placed inside any part of the body, seek immediate medical attention.

DE  
ACHTUNG: Dieses Produkt enthält eine Knopfzellenbatterie. Eine verschluckte Knopfzellenbatterie kann innere chemische Verbrennungen verursachen und in weniger als zwei Stunden zum Tod führen. Entsorge umgehend gebrauchte Batterien. Halte neue und gebrauchte Batterien von Kindern fern. Wenn du glaubst, dass Batterien verschluckt wurden oder sich in einem Körperteil befinden, hole umgehend medizinische Hilfe.

FR  
AVERTISSEMENT : Ce produit contient une pile bouton. L'ingestion d'une pile bouton peut provoquer des brûlures chimiques internes en seulement deux heures et provoquer la mort. Jeter immédiatement les piles usagées. Conserver les piles neuves et usagées hors de portée des enfants. Si vous suspectez l'ingestion d'une pile ou sa présence où que ce soit à l'intérieur du corps, consultez immédiatement un médecin.

IT  
ATTENZIONE: questo prodotto contiene una batteria a bottone. Se inghiottita, una batteria a bottone può causare ustioni chimiche interne in sole due ore, con possibile morte. Smaltire immediatamente le batterie usate. Tenere le batterie nuove e usate lontano dai bambini. Se si pensa che una batteria sia stata inghiottita o inserita in una parte del corpo, rivolgersi immediatamente a un medico.

NL  
WAARSCHUWING: dit product bevat een knoopcelbatterij. Als een knoopcelbatterij wordt ingeslikt, kan deze binnen twee uur chemische brandwonden veroorzaken in het lichaam. Het inslikken van een dergelijke batterij kan zelfs leiden tot overlijden. Gooi gebruikte batterijen onmiddellijk weg. Bewaar nieuwe en gebruikte batterijen buiten bereik van kinderen. Als je denkt dat een kind batterijen heeft ingeslikt of ze in een lichaamsopening heeft gestopt, raadpleeg je direct een arts.

ES  
ADVERTENCIA: Este producto contiene una pila de botón. Ingerir una pila de botón puede dar lugar a quemaduras químicas internas en tan sólo dos horas y provocar la muerte. Las pilas usadas deben desecharse inmediatamente. Mantenga las pilas nuevas y usadas fuera del alcance de los niños. Si sospecha de la ingestión o la introducción de pilas en cualquier parte del cuerpo, busque atención médica inmediatamente.

DA  
ADVARSEL: Dette produkt indeholder et knap- eller møntcellebatteri. Hvis et knap- eller møntcellebatteri sluges, kan det forårsage indvendige ætsninger på blot to timer og medføre døden. Bortskaf brugte batterier omgående. Hold både nye og brugte batterier uden for børns rækkevidde. Hvis du har mistanke om, at batterierne kan være blevet slugt eller kommet ind i nogen del af kroppen, skal du omgående søge lægehjælp.

IS  
VIÐVÖRUN: Þessi vara inniheldur hnapparafhlöðu eða flata rafhlöðu. Ef hnapparafhlaða eða flöt rafhlaða er gleypt getur hún valdið innvortis efnabruna á innan við tveimur klukkustundum og leitt til dauða. Fargaðu notuðum rafhlöðum tafarlaust. Geymdu nýjar og notaðar rafhlöður þar sem börn ná ekki til. Ef þú telur að rafhlöður hafi verið gleyptar eða á annan hátt komist inn í einhvern hluta líkamans skaltu tafarlaust leita læknaástoðar.

FI  
VAROITUS: Tämä tuote sisältää pienen tai isokokaisen nappipariston. Nieltynä pieni tai isokokoinen nappiparisto voi aiheuttaa sisäisiä kemiallisia palovammoja jo kahden tunnin kuluessa ja johtaa kuolemaan. Käytetyt paristot on toimitettava heti keräyspisteeseen. Pidä uudet ja käytetyt paristot poissa lasten ulottuvilta. Jos epäilet jonkun nielaissseen pariston tai laittaneensa pariston kehoonsa, vie hänet välittömästi lääkäriin.

SV  
VARNING: Denna produkt innehåller ett knapp- eller myntcells batteri. Förtäring av ett knapp- eller myntcells batteri kan orsaka inre kemiska brännskador på så kort tid som två timmar och leda till döden. Kasserat förbrukade batterier omedelbart. Förvara nya och använda batterier utom räckhåll för barn. Om du tror att batterierna kan ha svalts eller placerats inuti någon del av kroppen, sök omedelbart läkarvård.

NO  
ADVARSEL: Dette produktet inneholder et knapp- eller myntcellebatteri. Ved svelging kan knapp- eller myntcellebatterier gi kjemisk brannskade innvendig på bare to timer og føre til død. Brukte batterier skal avhendes øyeblikkelig. Nye og brukte batterier skal oppbevares utilgjengelig for barn. Hvis du tror at batterier har blitt svelget eller puttet inn andre steder i kroppen, må du kontakte lege øyeblikkelig.



**PT**  
AVISO: Este produto contém uma pilha tipo botão ou moeda. Uma pilha tipo botão ou moeda que tenha sido engolidas pode provocar queimaduras químicas internas em menos de duas horas e levar à morte. Elimine as pilhas usadas imediatamente. Mantenha as pilhas novas e usadas fora do alcance das crianças. Se pensa que as pilhas podem ter sido engolidas ou colocadas no interior de alguma parte do corpo, procure de imediato assistência médica.

**EL**  
ΠΡΟΕΙΔΟΠΟΙΗΣΗ: Αυτό το προϊόν περιέχει μία Στρογγυλή Μπαταρία Μεγέθους Κουμπιού ή Κέρματος. Η κατάποση μιας Στρογγυλής Μπαταρίας Μεγέθους Κουμπιού ή Κέρματος μπορεί να προκαλέσει εσωτερικά χημικά εγκαύματα σε μόλις δύο ώρες και να οδηγήσει σε θάνατο. Πετάξτε αμέσως τις χρησιμοποιημένες μπαταρίες. Κρατήστε τις καινούργιες και τις χρησιμοποιημένες μπαταρίες μακριά από τα παιδιά. Εάν νομίζετε ότι κάποια μπαταρία έχει καταποθεί ή τοποθετηθεί εντός οποιουδήποτε μέρους του σώματος, ζητήστε αμέσως ιατρική βοήθεια.

**JA**  
警告：本製品には、ボタン型またはコイン型の電池が使用されています。  
ボタン型またはコイン型電池は誤飲すると2時間以内に体内で化学火傷を起こし、死に至る恐れがあります。使用済みの電池は直ちに廃棄してください。新しい電池および使用済み電池は、どちらもお子様の手の届かないところに保管してください。電池を誤飲した恐れがある、または電池が身体のとこかに入った恐れがある場合は、直ちに医師の診察を受けてください。

**ZH**  
警告：本品内含一颗纽扣电池。  
吞咽的纽扣电池仅在两小时内就会引起体内化学灼伤并导致死亡！请立即处理使用过的电池。请将新、旧电池放置到儿童接触不到的地方。如果电池被不慎吞下，或被置入身体的任何一个部位，请立即就医！

**KO**  
경고: 이 제품에는 버튼 또는 코인 셀 배터리가 포함되어 있습니다. 코인 셀 배터리를 삼킬 경우, 빠르면 2시간 이내에 체내에서 화학적 화상이 일어나고 심하면 사망에 이를 수 있습니다. 다른 배터리는 즉시 폐기하십시오. 배터리를 어린이의 손에 닿지 않는 곳에 보관하십시오. 배터리를 삼켰거나 신체 어느 부위에든 들어간 것으로 판단될 경우, 즉각 의사의 도움을 구하십시오.

**RU**  
ПРЕДОСТЕРЕЖЕНИЕ. Эта игрушка работает от батарейки таблеточного или кнопочного типа. Проглатывание батарейки таблеточного или кнопочного типа может (в течение двух часов) вызвать химические ожоги внутренних органов и привести к летальному исходу. Своевременно утилизируйте использованные батарейки. Храните новые и использованные батарейки в местах, недоступных для детей. Если у вас есть основания полагать, что ребенок проглотил батарейку или она попала внутрь какой-либо части его тела, немедленно обратитесь за медицинской помощью.

**PL**  
OSTRZEŻENIE: w tym produkcji znajduje się płaska okrągła bateria.

Połknięcie takiej baterii może spowodować chemiczne oparzenia wewnętrzne już po dwóch godzinach, a także doprowadzić do śmierci. Gdy bateria się zużyje, należy ją natychmiast zutylizować. Nowe i używane baterie należy przechowywać z dala od dzieci. W przypadku stwierdzenia, że baterie mogły zostać połknięte lub inaczej trafić do organizmu, należy natychmiast poszukać pomocy lekarskiej.

**CZ**  
VAROVÁNÍ: Tento výrobek obsahuje knoflíkovou nebo mincovou baterii. Společně knoflíkové nebo mincové baterie může během pouhých 2 hodin způsobit vnitřní poleptání sliznice a v některých případech mít za následek smrt. Použité baterie ihned vyjměte a zlikvidujte. Nové i použité baterie uchovávejte mimo dosah dětí. V případě spolknutí či uviznutí baterie v některé části těla okamžitě vyhledejte lékařskou pomoc.

**SK**  
UPOZORNENIE: Tento produkt obsahuje gombíkovú alebo mincovú batériu. Prehltnutie gombíkovej alebo mincovej batérie môže spôsobiť vnútorné chemické popáleniny už do dvoch hodín a viesť k úmrtiu. Použité batérie ihneď vyhod'te. Nové aj použité batérie uchovávajú mimo dosahu detí. Ak si myslíte, že mohlo dôjsť k prehltnutiu batérie alebo sa batéria mohla dostať do vnútra ktorejkoľvek časti tela, okamžite vyhľadajte lekársku pomoc.

**HU**  
FIGYELMEZTETÉS: Ez a termék gombelemet illetve lapos gombelemet tartalmaz!  
A lenyelt gombelem vagy lapos gombelem akár két óra alatt is belső vegyi sérüléseket okozhat, ami halálhoz vezethet. Az elhasznált elemeket azonnal dobja ki! Az új és a használt elemeket ne adja gyermekek kezébe! Ha úgy gondolja, hogy valaki lenyelt egy elemet, vagy bekerült valakinek valamely testrészébe, akkor azonnal kérjen orvosi segítséget!

**UA**  
ОБЕРЕЖНО. Продукт містить мініатюрну батарейку типу «таблетка». Якщо проковтнути мініатюрну батарейку, вона може спричинити внутрішні хімічні опіки протягом двох годин і призвести до смерті. негайно утилізуйте використані батарейки. Зберігайте нові та використані батарейки недоступними для дітей. Якщо вам здається, що дитина проковтнула батарейку чи вона опинилася в будь-якій частині тіла дитини, негайно зверніться до лікаря.

**HR**  
UPOZORENJE: Ovaj proizvod sadrži gumbastu bateriju ili bateriju oblika kovanice. Ako se gumbasta baterija ili baterija oblika kovanice proguta, za samo dva sata može uzrokovati unutarnje kemijske opekline i izazvati smrt. Iskorištene baterije odmah odložite u otpad. Čuvajte nove i stare baterije dalje od djece. Ako mislite da je baterija progutana ili je dospjela u bilo koji dijela tijela, odmah zatražite liječničku pomoć.



SR  
УПОЗОРЕЊЕ: Овај производ садржи дугмасту батерију. Прогутана дугмаста батерија може да доведе до интерних хемијских опекотина већ за два сата и доводи до смрти. Одмах одложите искоришћене батерије у отпад. Чувајте нове и искоришћене батерије ван домаћаја деце. Ако мислите да је дошло до гутања батерија или стављања у било који део тела, одмах потражите помоћ лекара.

МК  
ПРЕДУПРЕДУВАЊЕ: Овој производ садржи батерија тип копче или тип монета. Проголтувањето на батерија тип копче или тип монета може да предизвика внатрешно хемиско горење во рок од два часа и да доведе до смрт. Исфрлете ги веднаш искористените батерији. Држете ги новите и користените батерији подалеку од деца. Ако мислите дека е можно батериите да се проголтани или поставени во кој било дел на телото, веднаш побарајте медицинска помош.

SL  
ОПОЗОРИЛО: Ta izdelek vsebuje gumbasto baterijo. Če oseba požre gumbasto baterijo, lahko to povzroči kemične opekline notranjih organov že v dveh urah po zaužitju. Tovrstne poškodbe lahko vodijo v smrt. Iztrošene baterije takoj zavrzite. Pazite, da nove ali iztrošene baterije ne bodo v dosegu otrok. Če menite, da je oseba zaužila baterijo ali si jo vstavila v kateri koli del telesa, takoj poiščite zdravniško pomoč.

RO  
AVERTIZARE: Acest produs conține o baterie de tip pastilă. Înghițirea unei baterii de tip pastilă poate cauza arsuri chimice interne în doar două ore, ducând la deces. Debarasați-vă imediat de bateriile uzate. Nu lăsați bateriile noi și uzate la îndemâna copiilor. Dacă credeți că bateriile ar fi putut fi înghițite sau ar fi putut ajunge în interiorul oricărei părți a corpului, solicitați imediat asistență medicală.

BG  
ПРЕДУПРЕЖДЕНИЕ: Този продукт съдържа батерия тип „копче“ или „монета“. При поглъщане батериите тип „копче“ или „монета“ могат да предизвикат вътрешни химически изгаряния в рамките на по-малко от два часа и да доведат до смърт. Незабавно изхвърляйте използваните батерији. Дръжете новите и стари батерији далек от деца. Ако смятате, че е възможно батериите да са били погълнати или да са попаднали където и да е вътре в тялото, потърсете незабавно медицинска помощ.

LV  
BRĪDINĀJUMS. Šim produktam ir pogas jeb monētas tipa akumulators. Ja pogas jeb monētas tipa akumulators tiek norīts, tas jau divu stundu laikā var izraisīt iekšējus ķīmiskus apdegumus un izraisīt nāvi. Nekavējoties utilizējiet izlietotos akumulatorus. Jaunus un lietotus akumulatorus glabājiet bērniem nepieejamā vietā. Ja uzskatāt, ka akumulators varētu būt norīts vai ievietots kādā ķermeņa daļā, nekavējoties vērsieties pēc medicīniskās palīdzības.

ET  
HOIATUS! See toode sisaldab nõõp- või müntpatareid. Alla neelatud nõõp- või müntpatarei võib tekitada sisemisi keemilisi põletusi kõigest kahe tunniga ning põhjustada surma. Kõrvaldage kasutatud patareid viivitamatult. Hoidke uusi ja kasutatud patareid lastele kättesaamatus kohas. Kui arvate, et keegi on patareid alla neelanud või need on sattunud mõnda kehaosasse, pöörduge kohe arsti poole.

LT  
JSPĖJIMAS. Šiame gaminyje yra sagos arba monetos formos baterija. Praryta sagos arba monetos formos baterija gali sukelti vidinius cheminius nudeginimus greičiau nei per dvi valandas ir galiusiai sukelti mirtį. Panaudotas baterijas nedelsiant utilizuokite. Naujas ir panaudotas baterijas laikykite atokiau nuo vaikų. Jei manote, kad vaikas galėjo praryti arba įsprausti bateriją sau į kūną, nedelsdami kreipkitės medicininės pagalbos.

TR  
UYARI: Bu ürün bir düğme pil içerir. Yutulmuş düğme pil, iki saat gibi kısa bir sürede iç kimyasal yanıklara neden olabilir ve ölüme yol açabilir. Kullanılmış pilleri derhal atın. Yeni ve kullanılmıř pilleri çocuklardan uzak tutun. Pillerin yutulmuş ya da vücudun başka bir yerine sokulmuş olabileceğini düşünürseniz derhal doktora başvurun.

AR  
تحذير: يحتوي هذا المنتج على بطارية خلايا قرصية أو بطارية خلايا على شكل عملة. قد يؤدي ابتلاع بطارية خلايا قرصية أو بطارية خلايا على شكل عملة إلى حدوث حروق كيميائية داخلية خلال فترة قصيرة لا تتجاوز ساعتين وقد يؤدي إلى الوفاة. يرجى التخلص من البطاريات المستعملة على الفور. مع الاحتفاظ بالبطاريات الجديدة والمستعملة بعيداً عن متناول الأطفال. إذا كنت تعتقد أن البطاريات تم ابتلاعها أو إدخالها إلى أي جزء من أجزاء الجسم، فاطلب المساعدة الطبية على الفور.

ID  
PERINGATAN: Produk ini berisi Baterai Sel Kancing. Baterai Sel Kancing yang tertelan dapat mengakibatkan luka bakar kimiawi dalam tubuh minimal setelah dua jam dan dapat mengakibatkan kematian. Segera buang baterai yang sudah tidak digunakan. Jauhkan baterai baru maupun bekas dari jangkauan anak-anak. Jika Anda curiga baterai telah tertelan atau masuk ke dalam tubuh, segeralah minta bantuan dokter.

MS  
AMARAN: Produk ini mengandungi Bateri Sel Butang atau Syiling. Tertelan bateri Sel Butang atau Syiling boleh mengakibatkan lecuran kimia dalaman dalam tempoh sekurang-kurangnya dua jam dan menyebabkan kematian. Buang bateri terpakai dengan serta-merta. Jauhkan bateri baharu dan terpakai daripada kanak-kanak. Jika anda mendapati bateri mungkin telah ditelan atau termasuk ke dalam mana-mana bahagian badan, dapatkan rawatan perubatan dengan segera.



EN

Protect the environment by not disposing of this product with your household waste. Check with your local authority for recycling advice and facilities. Penalties may apply for improper disposal.

DE

Schützen Sie die Umwelt und entsorgen Sie dieses Produkt nicht mit Ihrem Hausmüll. Informationen zu Recycling-Möglichkeiten erhalten Sie bei den örtlichen Behörden. Bei unsachgemäßer Entsorgung können Strafen verhängt werden.

FR

Protégez l'environnement : ne jetez pas ce produit avec vos autres déchets ménagers. Contactez les autorités locales pour obtenir des informations sur le recyclage et connaître les points de collecte. Des sanctions peuvent être appliquées en cas d'élimination inappropriée.



IT

Proteggi l'ambiente! Non smaltire questo prodotto con i rifiuti domestici. Per consulenza sul riciclaggio dei rifiuti e le strutture di riciclaggio, rivolgersi alle proprie autorità locali. Uno smaltimento improprio può comportare sanzioni.

NL

Bescherm het milieu: gooi dit product niet samen met het andere huisvuil weg. Raadpleeg de plaatselijke instanties voor locaties van milieustations en advies over hergebruik. In geval van onjuiste verwijdering kunnen boetes worden opgelegd.

ES

Proteja el medio ambiente no deshaciéndose de este producto junto con sus residuos domésticos. Solicite asesoramiento e información sobre instalaciones de reciclaje a las autoridades locales. La eliminación inadecuada puede ser objeto de sanciones.

DA

Beskyt miljøet! Smid ikke dette produkt ud sammen med husholdningsaffaldet. Få vejledning om genbrug og genbrugsstationer hos din kommune. Ukorrekt bortskaftelse kan medføre bøde eller straf.

IS

Stuðlið að umhverfisvernd með því að farga þessari vöru ekki með heimilissorpi. Leitid upplýsinga um endurvinnslu- og förgunarstaði hjá yfirvöldum á hverjum stað. Viðurlögum kann að vera beitt ef förgun er ekki með réttum hætti.

FI

Tämä tuote on hävitettävä ympäristöstävällisesti ja erillään muusta talousjätteestä. Tietoja kierrätyksestä ja keräyspisteiden sijainnista saat paikkakuntasi teknisestä virastosta. Epäasianmukaisesta hävittämisestä saattaa aiheutua seuraamuksia.

SV

Skydda miljön genom att inte kasta denna produkt bland ditt hushållsavfall. Kontakta din kommun för frågor om återvinning och miljöstationer. Påföljder kan tillkomma för felaktig avyttring.

NO

Beskytt miljøet. Ikke kast dette produktet i husholdningsavfallet. Kontakt kommunen for veiledning om gjenbruk og miljøstasjoner. Feil avfallshåndtering kan være straffbart.

PT

Proteja o ambiente não eliminando este produto com o seu lixo doméstico. Consulte as autoridades locais para informação sobre reciclagem e sistemas de recolha. Podem ser aplicadas coimas por eliminação inadequada.

EL

Προστατέψτε το περιβάλλον. Μην πετάτε αυτό το προϊόν μαζί με τα συνηθισμένα οικιακά απορρίμματα. Επικοινωνήστε με τις τοπικές αρχές σχετικά με συμβουλές και εγκαταστάσεις ανακύκλωσης. Ενδέχεται να επιβάλλονται κυρώσεις για ακατάλληλη διάθεση απορριμμάτων.

JA

環境保護のため、本製品は家庭ごみとは別に処分してください。リサイクルに関する指示や施設については、お住まいの地方自治体にお問い合わせください。不適切な廃棄を行った場合、罰則が適用されることがあります。





#### ZH

注意保护环境, 请勿将本产品与生活垃圾一起丢弃处理。  
请咨询当地相关部门, 了解与回收相关的设施与建议。  
处理不当可能会导致处罚。

#### KO

환경 보호를 위해 이 제품을 생활폐기물과 함께 버리지 마십시오.  
재활용 방법 및 시설에 관한 사항은 현지 관계 당국에 문의하십시오. 부적절하게 폐기할  
경우 벌칙이 부과될 수 있습니다.

#### RU

Позаботьтесь об окружающей среде: не утилизируйте этот продукт  
вместе с бытовым мусором.  
Узнайте в органах местного самоуправления правила вторичной  
переработки и утилизации таких отходов.  
В случае ненадлежащей утилизации могут быть наложены штрафы.

#### PL

Aby chronić środowisko naturalne, nie należy wyrzucać tego produktu wraz z  
odpadkami z gospodarstwa domowego.  
W celu uzyskania wskazówek dotyczących recyklingu oraz adresów zakładów  
należy skontaktować się z lokalnym urzędem.  
Za nieprzestrzeganie zasad związanych z utylizacją odpadów grożą kary.

#### CZ

Nevyhazujte tento produkt do domácího odpadu, chráňte životní prostředí.  
Zjistěte si prosím u místních úřadů možnosti recyklace a dostupná zařízení.  
Nesprávná likvidace může být pokutována.

#### SK

Nevyhazujte tento produkt do domáceho odpadu, chráňte životné  
prostredie.  
Zistite si na miestnych úradoch možnosti recyklácie a dostupné zariadenia.  
Za nesprávnú likvidáciu môžu byť uložené sankcie.

#### HU

Környezetét óvja, ha ettől a terméktől nem a háztartási hulladékkal együtt  
vállik meg.  
Érdeklődjék a lakóhelyéhez közel eső hatóságnál az újrahasznosítás módjáról  
és lehetőségéről. A nem megfelelő hulladékelhelyezésért büntetés járhat.

#### UA

Допоможіть захистити довкілля: не утилізуйте цей виріб разом із  
побутовим сміттям.  
Вказівки з утилізації та відомості про пункти прийому з'ясуйте в місцевих  
компетентних органів. У разі неналежної утилізації можуть  
застосовуватися штрафи.

#### HR

Zaštítite okoliš tako da ovaj proizvod ne odložite u otpad zajedno s  
kućanskim otpadom.  
Od lokalnih vlasti zatražite savjet ili informacije o pogonima za recikliranje.  
Moguća je kazna za nepropisno zbrinjavanje.

#### SR

Zaštítite životnu sredinu tako što nećete da odlažete ovaj proizvod  
sa kućnim otpadom.  
Raspitajte se kod lokalnog nadležnog organa o načinu reciklaže i o  
sabitrom centru. U slučaju nepravilnog odlagaња u otpad, mogu biti  
izrecene kazne.

#### MK

Zaštítite ja okolinata tako što nema da se oslobodite od proizvodot  
so domashniot otpad.  
Konsultirajte se so lokalnite vlasti za da doznaete za sovetite i  
objektite za recikliraње. Vozmožno e da bidat primeneti kazni za  
nepravilno isfrplaње.

#### SL

Zaščitite okolje! Okolje varujte tako, da tega izdelka ne zavržete skupaj z  
gospodinjiskimi odpadki.  
Pri krajevni upravi preverite, kakšne možnosti in kateri obrati za recikliranje  
obstajajo v vaši okolici. Za nepravilno odlaganje odpadkov vas lahko doleti  
kazen.

#### RO

Protejați mediul înconjurător și nu vă debarasați de acest produs împreună  
cu deșeurile menajere.  
Consultați autoritățile locale pentru îndrumări și facilități de reciclare.  
Dezafectarea necorespunzătoare poate atrage sancțiuni.

#### BG

Zaštítite okolnata sreda i ne izhvǎryajte tozi produkt zaedno s  
bitovite si otpadyци.  
Svǎryжете се с местните власти относно съвети и съоръжения за  
рециклиране. Възможно е да има глоби за неправолно изхвърляне.

#### LV

Lai saudzētu vidi, neizmetiet šo izstrādājumu kopā ar sadzīves atkritumiem.  
Vērsieties vietējās varas iestādēs, lai noskaidrotu, kur un kā tas nododams  
pārstrādei. Par neatbilstošu likvidēšanu var tikt piemērots sods.



ET

Keskkonda saate kaitsta nii, et ei kõrvalda seda toodet koos olmejäätmetega.

Nõuandeid toote taaskasutusse võtmise ja ümbertöötlemispunktide kohta saate asjaomaselt kohalikult asutuselt.

Nõuetele mittevastav kasutuselt kõrvaldamine võib kaasa tuua trahvid.

LT

Saugokite aplinką: nemeskite šio produkto kartu su buitinėmis atliekomis.

Atsižvelkite į savo vietos valdžios rekomendacijas dėl pakartotinio panaudojimo ir sąlygas. Už netinkamą šalinimą gali būti taikomos baudos.

TR

Bu ürünü, evsel atıklarla birlikte atmayarak çevreyi koruyun.

Geri dönüşüm tavsiyeleri ve tesisler hakkında bilgi için yerel yönetimle iletişim kurun. Uygunsuz atılması durumunda cezalar uygulanabilir.

AR

احم البيئة بعدم التخلص من هذا المنتج مع المخلفات المنزلية.  
استشر السلطة المحلية لديك للحصول على نصح بخصوص إعادة تدوير المخلفات ومراقبه.  
قد يتم تطبيق عقوبات على التخلص غير السليم.

ID

Jagalah lingkungan dengan tidak membuang produk ini bersama sampah rumah tangga Anda.

Periksa peraturan pemerintah setempat tentang saran dan fasilitas daur ulang. Pembuangan yang tidak sesuai ketentuan dapat dikenakan denda.

MS

Lindungi alam sekitar dengan tidak melupuskan produk ini bersama sisa isi rumah anda.

Rujuk pihak berkuasa tempatan anda tentang nasihat dan kemudahan kitar semula. Penalti boleh dikenakan untuk pelupusan yang tidak wajar.



EN Please retain the leaflet and packaging as they contain important information  
DE Broschüre und Verpackung bitte aufbewahren, sie enthalten wichtige Informationen  
FR Veuillez conserver le dépliant et l'emballage, car ils contiennent des informations importantes  
IT Conserva l'opuscolo e la confezione in quanto contengono informazioni importanti  
NL Bewaar a.u.b. de folder en verpakking: die bevatten belangrijke informatie  
ES Conserve el folleto y el embalaje; contienen información importante  
DA Gem hæftet og emballagen, da de indeholder vigtige oplysninger  
IS Geymið bæklinginn og umbúðirnar þar sem þau innihalda mikilvægar upplýsingar  
FI Säilytä esite ja pakkaus, koska ne sisältävät tärkeää tietoa  
SV Spara broschyren och förpackningen eftersom de innehåller viktig information  
NO Heftet og emballasjen inneholder viktig informasjon og skal beholdes  
PT Por favor guarde o folheto e a embalagem, pois contém informação importante  
EL Κρατήστε το φυλλάδιο και τη συσκευασία γιατί περιέχουν σημαντικές πληροφορίες  
JA 説明書とパッケージには重要な情報が含まれていますので保管しておいてください  
ZH 说明书和包装均包含重要信息, 请妥善保管  
KO 중요한 정보가 담겨 있으므로 리플릿과 포장을 보관해주세요  
RU Пожалуйста, сохраните эту брошюру и упаковку, поскольку они содержат важную информацию  
PL Prosimy zachować ulotkę i opakowanie, ponieważ zawierają one ważne informacje  
CZ Ponechte si prosím leták i obal, neboť obsahují důležité informace  
SK Ponechajte si prosím leták aj obal, pretože obsahujú dôležité informácie  
HU Kérjük, őrizze meg a szórólapot és a csomagolást, mert fontos tudnivalókat tartalmaznak  
UA Будь ласка, зберігайте вкладиш та упаковку, оскільки вони містять важливу інформацію

HR Spremite letak i ambalažu jer sadrže važne obavijesti  
SR Молимо да сачувате упутство и паковање јер се на њима налазе важне информације  
MK Чувајте ги брошурата и амбалажата бидејќи содржат важна информација  
SL Prosimo, da brošurico in embalažo shranite, saj vključujeta pomembne informacije  
RO Vă rugăm să păstrați prospectul și ambalajul întrucât conțin informații importante  
BG Запазете листовката и опаковката, тъй като съдържат важна информация  
LV Lūdzu, saglabājiet bukletu un iepakojumu, jo uz tā ir norādīta svarīga informācija  
ET Hoidke infoleht ja pakend alles, sest nendele on märgitud oluline teave  
LT Išsaugokite informacinį lapelį ir pakuotę, nes ant jų pateikiama svarbi informacija  
TR Önemli bilgiler içerdiği için broşürü ve ambalajı saklayın  
AR الرجاء الاحتفاظ بالنشرة والغلاف لاحتوائهما على معلومات هامة  
ID Harap simpan brosur dan kemasan ini karena berisi informasi penting  
MS Sila simpan risalah dan pembungkusan kerana ia mengandungi maklumat penting

LEGO System A/S  
Aastvej 1  
DK-7190 Billund

- 2x 6186681
- 3x 6168642
- 2x 6253309
- 1x 6177114
- 6x 6258135
- 4x 6235083
- 1x 654101
- 6x 6172366
- 2x 6348055
- 4x 6218841
- 7x 6474222
- 3x 6466031
- 1x 6461276
- 3x 6466029
- 2x 4224792
- 2x 4547489
- 3x 6093053
- 1x 6310183
- 2x 6173116
- 4x 6034044
- 2x 6293665
- 2x 6217875
- 2x 6047220
- 1x 6261390
- 4x 6223491
- 3x 6478180
- 1x 6323929
- 1x 6444853
- 1x 4529237
- 1x 4117070
- 1x 6400380
- 15x 4113915
- 24x 4159553
- 2x 6232135
- 3x 4125253
- 2x 4516055
- 3x 6360037
- 1x 6286492
- 3x 4624086
- 1x 6476341
- 15x 4218749
- 14x 6478176
- 15x 6214334
- 2x 6092587
- 17x 4113917
- 1x 4626200
- 17x 4118790
- 4x 4118790
- 1x 6034852
- 10x 6069165
- 1x 4205107
- 2x 6387150
- 2x 6148262
- 1x 6226564
- 4x 6226565
- 2x 4124455
- 4x 6055868
- 9x 4162465
- 6x 4121921
- 1x 4618651
- 1x 6484242
- 4x 4118790
- 1x 6034852
- 11x 4113916
- 6x 6213676
- 1x 4113233
- 3x 4112982
- 1x 6106187
- 1x 6378358
- 1x 4249019
- 2x 4295313
- 1x 6337734
- 6x 307021
- 1x 6054438
- 8x 4142865
- 1x 6484474
- 2x 4206482
- 1x 6444727
- 1x 6444735
- 2x 6284577
- 4x 6168644
- 1x 4504381
- 1x 6310247
- 1x 6315887
- 4x 6443416
- 2x 6273589
- 2x 6445341
- 1x 6477141
- 8x 6478177
- 1x 6325525
- 3x 6104209
- 1x 6390775
- 3x 6196548
- 2x 6279875
- 1x 6057397
- 1x 6281919
- 10x 6347310
- 1x 6234806
- 1x 6436038
- 2x 6089119
- 2x 452226
- 1x 6446030
- 1x 383526
- 1x 6177083
- 6x 6338221
- 30x 6411022
- 30x 6269971
- 7x 6311453
- 5x 306928
- 6x 6352550
- 1x 6425442
- 2x 6190040
- 4x 6297286
- 10x 6385275
- 1x 6226928
- 2x 371028
- 2x 6133852
- 4x 6021999
- 1x 6266964
- 5x 6070506
- 1x 6141590
- 5x 6457953
- 2x 6406233
- 22x 6275873
- 27x 6182261
- 4x 6422433
- 7x 6294513
- 4x 6074890
- 7x 6420468
- 1x 6315782
- 14x 6502193
- 1x 6374150
- 5x 6143431
- 2x 6228968
- 1x 6384077
- 1x 6466026
- 2x 6188477
- 9x 4616027
- 2x 6295081
- 22x 4570877
- 1x 6313129
- 2x 6186009
- 7x 6396922
- 1x 6092602
- 15x 4615606
- 2x 6340042
- 4x 6253425
- 1x 6265679
- 1x 6340118
- 18x 6074892
- 1x 6074893
- 2x 6468066
- 1x 6400293
- 8x 4535928
- 13x 6253418
- 11x 6219673
- 15x 6426644
- 1x 6310668
- 2x 6263971
- 3x 6247798
- 2x 6443797
- 1x 6466045



- 1x 6116613
- 2x 6258989
- 1x 6234270
- 1x 6313665
- 6x 4217848
- 1x 4223683
- 2x 6469351
- 1x 4223729
- 2x 6055145
- 5x 6170468
- 2x 6357946
- 2x 4211204
- 1x 4655611
- 1x 6476005
- 2x 4243838
- 2x 4211247
- 4x 4211189
- 2x 6126082
- 1x 4211181
- 4x 4595889
- 7x 6153594
- 1x 4224732
- 2x 6044725
- 13x 6250597
- 6x 6448793
- 1x 6057487
- 1x 4211389
- 2x 6311384
- 4x 6248890
- 2x 6407767
- 1x 6390506
- 2x 6126082
- 2x 6034676
- 2x 6199549
- 2x 6314891
- 2x 6013497
- 2x 4180418
- 4x 4509915
- 1x 6167798
- 2x 4180408
- 4x 4211475
- 2x 4211526
- 4x 6000066
- 5x 4211349
- 2x 4515374
- 5x 4211385
- 11x 6284596
- 3x 4211429
- 6x 6228923
- 3x 6245283
- 2x 6221607
- 2x 6178919
- 10x 6331866
- 2x 6069164
- 4x 4211007
- 6x 6411395
- 4x 4210635
- 2x 4211043
- 3x 4211001
- 1x 4211065
- 7x 6209683
- 1x 6440633
- 1x 6379176
- 1x 6440631
- 1x 6192037
- 1x 6440627
- 1x 6476347
- 1x 6476353
- 1x 6440901
- 1x 6476345
- 1x 6476343
- 1x 6476355
- 1x 6476349
- 1x 6476351
- 1x 6274711
- 17x 6190252
- 1x 6372427
- 4x 6069887
- 2x 6284379
- 4x 6207933
- 4x 6338242
- 6x 6473751
- 2x 6134197
- 2x 6272144
- 3x 6167641
- 18x 6349124
- 10x 6177146
- 16x 6383946
- 12x 6476342
- 2x 6296061
- 6x 6248536
- 37x 6292154
- 6x 6167642
- 9x 6021997
- 14x 6474122
- 9x 6102994
- 4x 6351381
- 3x 6435640
- 3x 6365746
- 2x 4622738
- 2x 4651231
- 2x 6454169
- 4x 6167690
- 5x 6324205
- 2x 6454171
- 2x 6454171
- 2x 6368592
- 17x 6314190
- 2x 6423217
- 3x 6351301
- 1x 6254218
- 1x 6102984
- 6x 6343854
- 20x 6102995
- 17x 6102998
- 2x 6476340
- 2x 6467273
- 14x 6257605
- 3x 6431822
- 1x 6218359
- 1x 6287960
- 2x 6151658
- 2x 6137300
- 2x 6354673
- 1x 6145255
- 2x 6258069
- 21x 6214235
- 42x 6398008
- 2x 6100158
- 1x 6278087
- 2x 6064670
- 9x 6268815
- 4x 6362965
- 3x 6247800
- 2x 6446914
- 1x 6490141
- 1x 6429472
- 3x 6363148
- 1x 6361354
- 3x 6236213
- 1x 6210601
- 1x 6234116
- 1x 6363146



 [LEGO.com/service](https://www.LEGO.com/service)



# YOU COULD WIN



## YOU COULD WIN

Your feedback will help shape the future development of this product series.

Visit:

## DU KÖNNTEST GEWINNEN

Dein Feedback trägt zur Weiterentwicklung dieser Produktreihe bei.

Geh auf:

## VOUS POURRIEZ GAGNER

Vos commentaires nous aideront à concevoir les futurs produits de cette gamme.

Visitez :

## POTRESTI VINCERE TU

La tua opinione ci aiuterà a migliorare la creazione futura di questa linea di prodotti.

Visita:

## PUEDES GANAR

Tu opinión contribuirá al futuro de esta serie de productos.

Visita:

## 轻松获奖

您的反馈将有助于我们在今后改进本产品系列。

请访问:

---

[LEGO.com/productfeedback](https://www.lego.com/productfeedback)

---

You also have the chance to win a LEGO® set.

Terms and conditions apply.\*

Außerdem hast du die Chance, ein LEGO® Set zu gewinnen.

Es gelten die Teilnahmebedingungen.\*

Vous pourriez également gagner un ensemble LEGO®.

Des conditions s'appliquent.\*

Hai anche la possibilità di vincere un set LEGO®.

Termini e condizioni sono applicabili.\*

También tienes la oportunidad de ganar un set LEGO®.

Aplican términos y condiciones.\*

您还有机会赢取乐高®套装。

条款和条件适用。\*

\*[LEGO.com/productfeedback-terms](https://www.lego.com/productfeedback-terms)

