

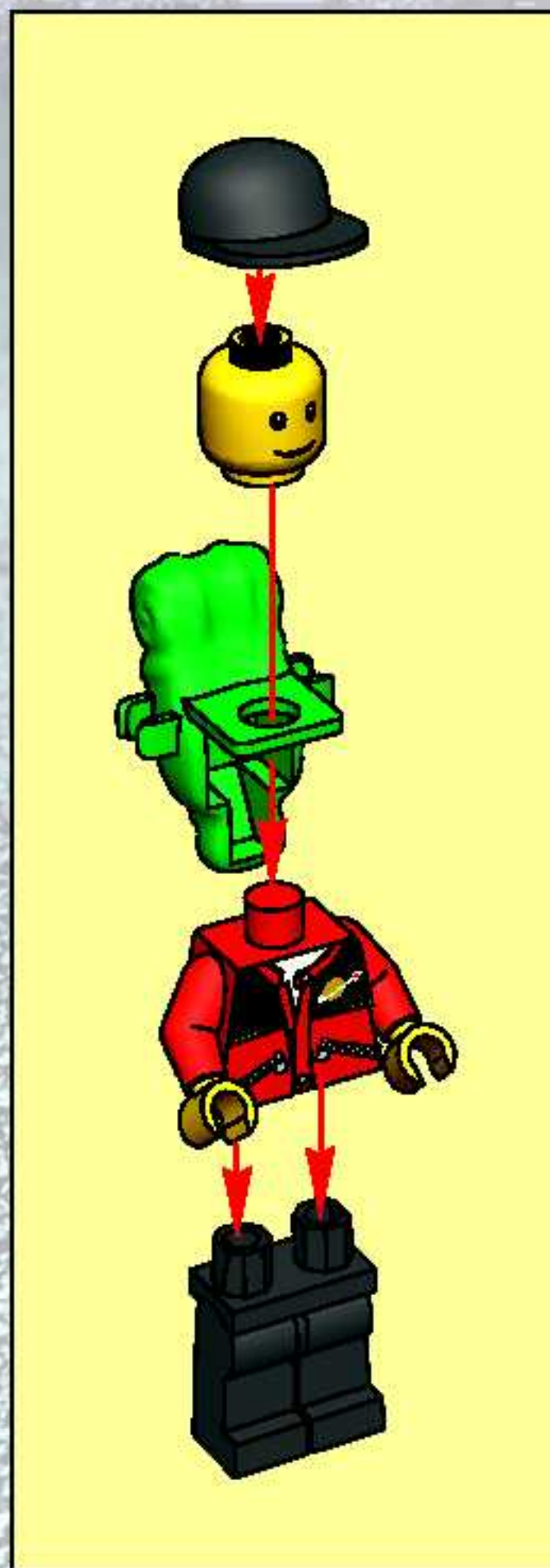

4513

World City ↑





1



2

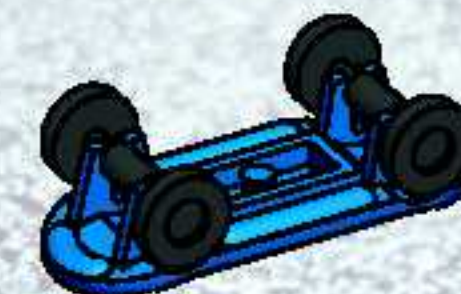

3



4





1

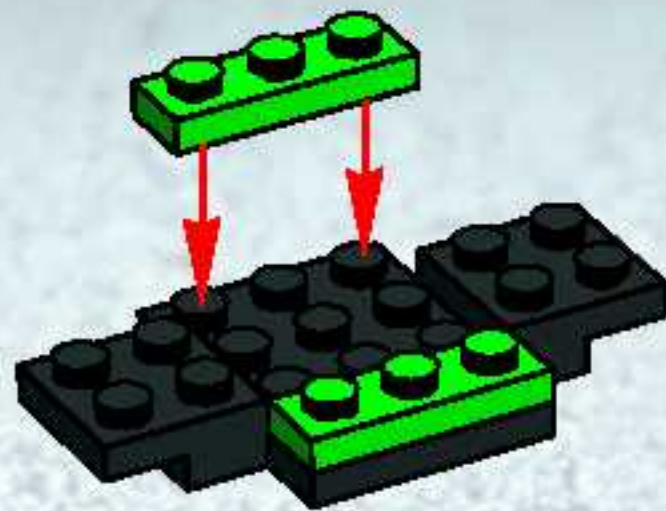

2



3

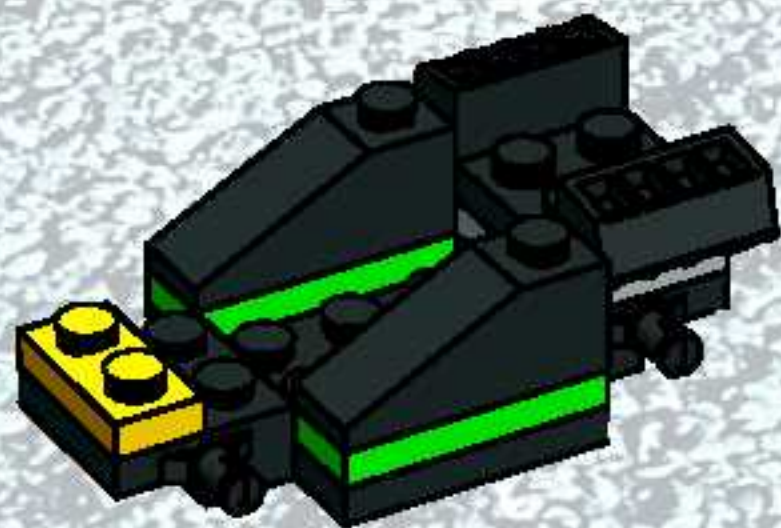

4

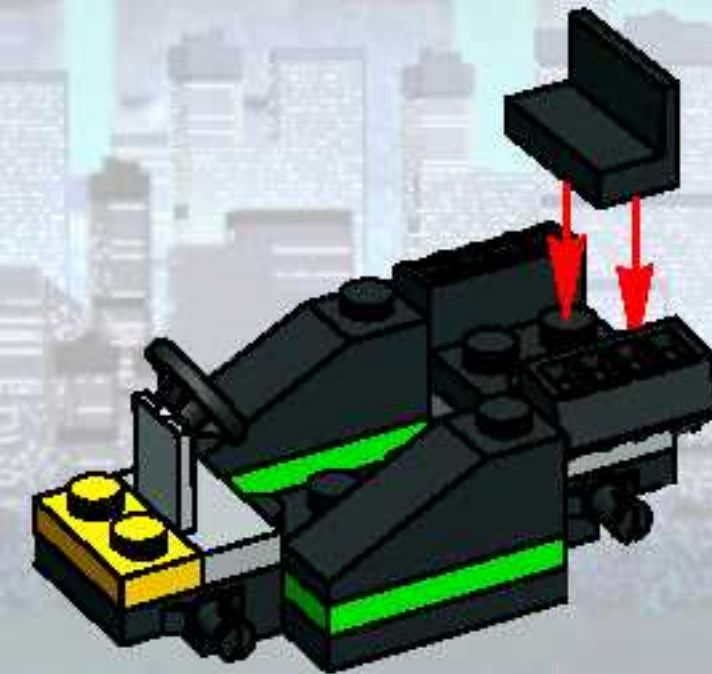

1



2

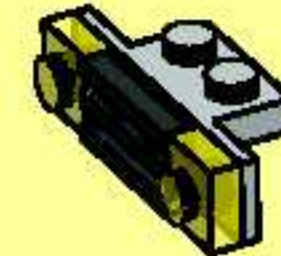

5

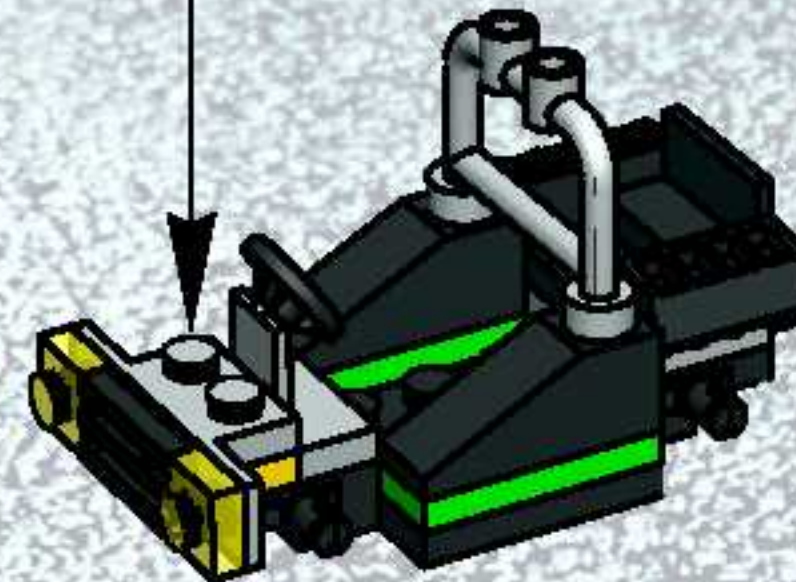

6



1

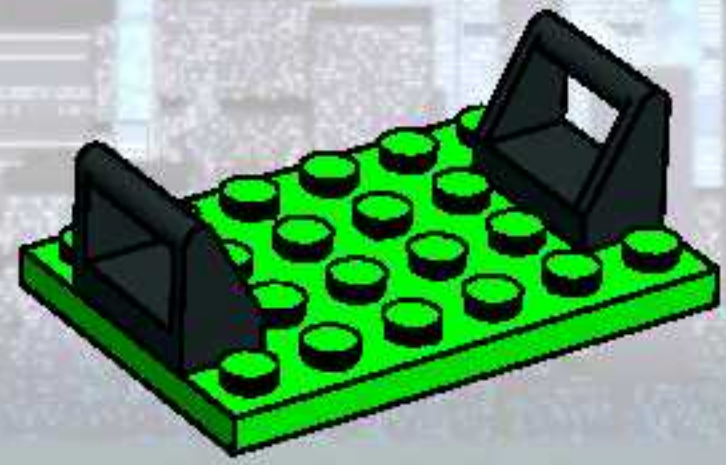

2

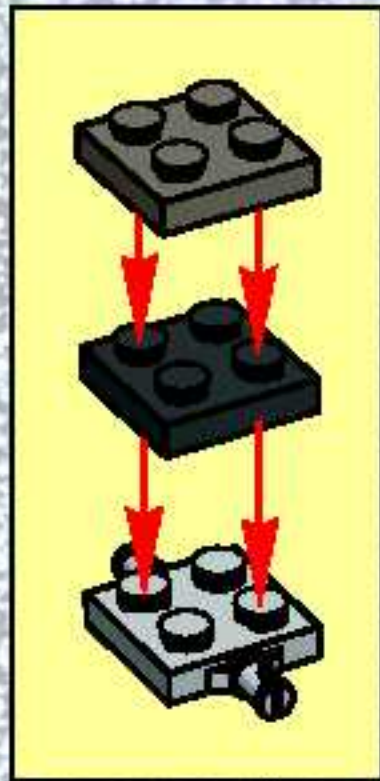
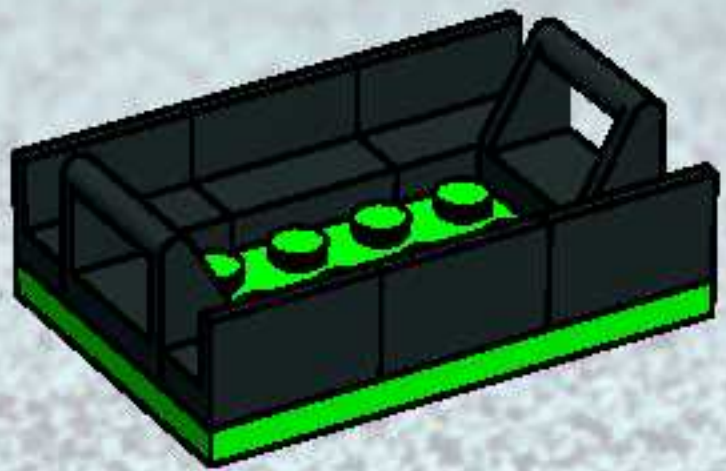

3

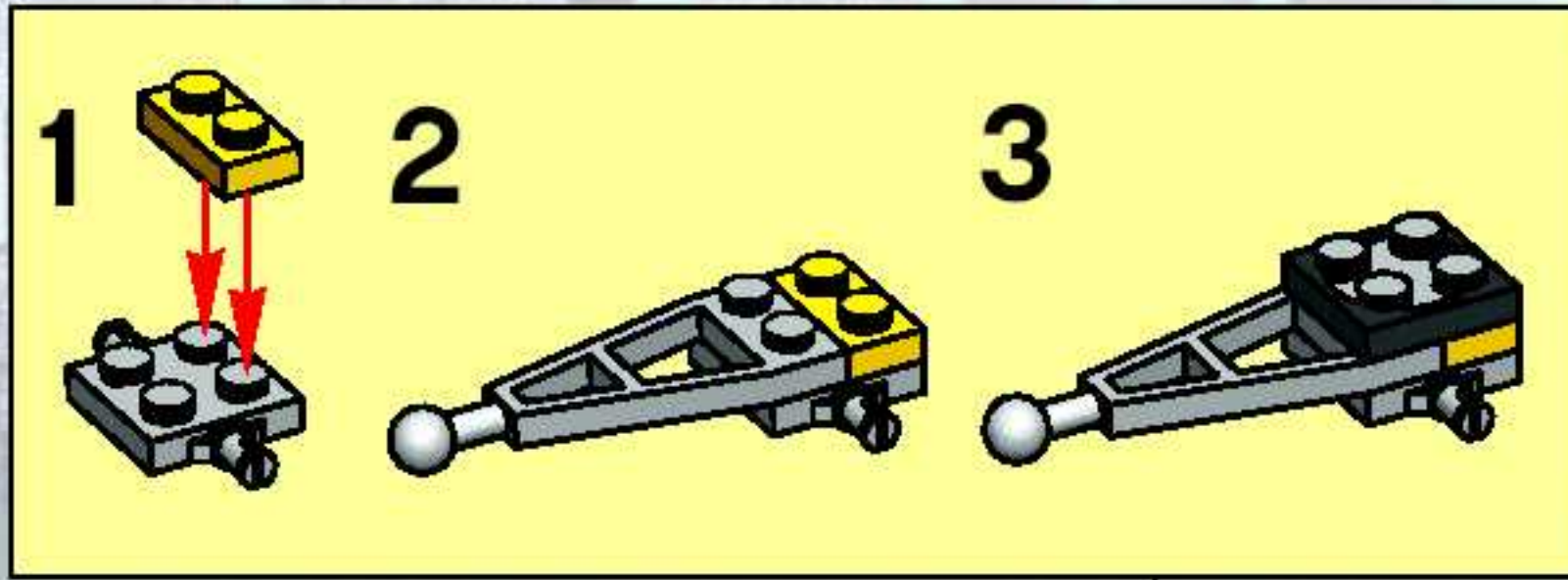
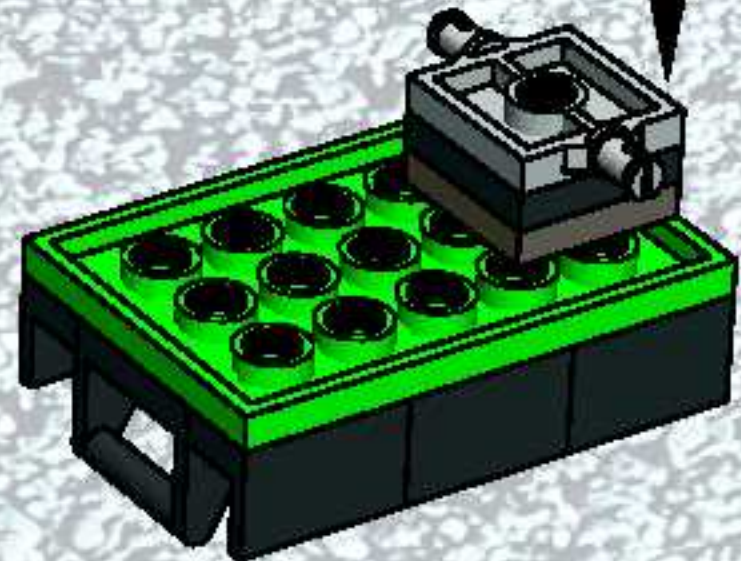

4

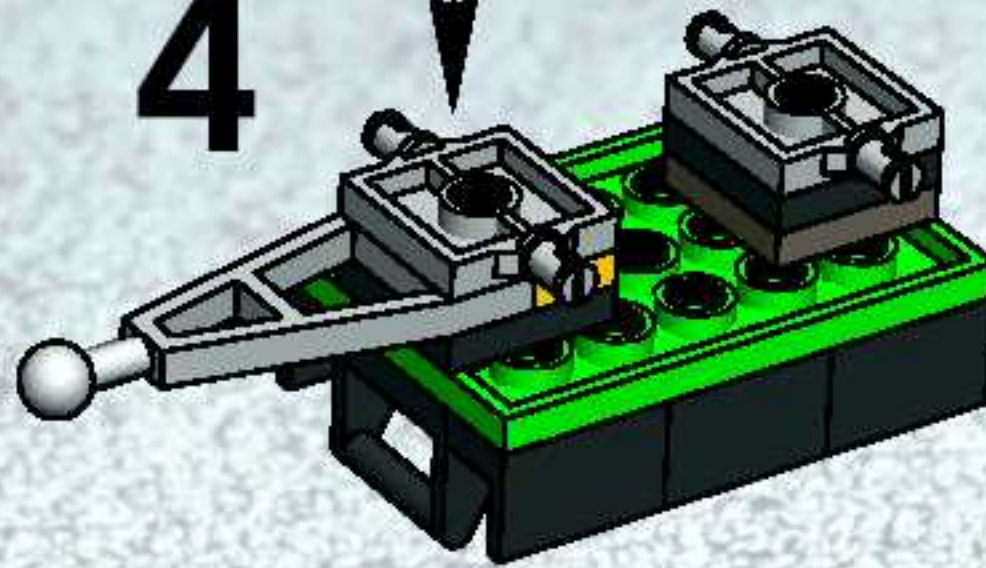

5

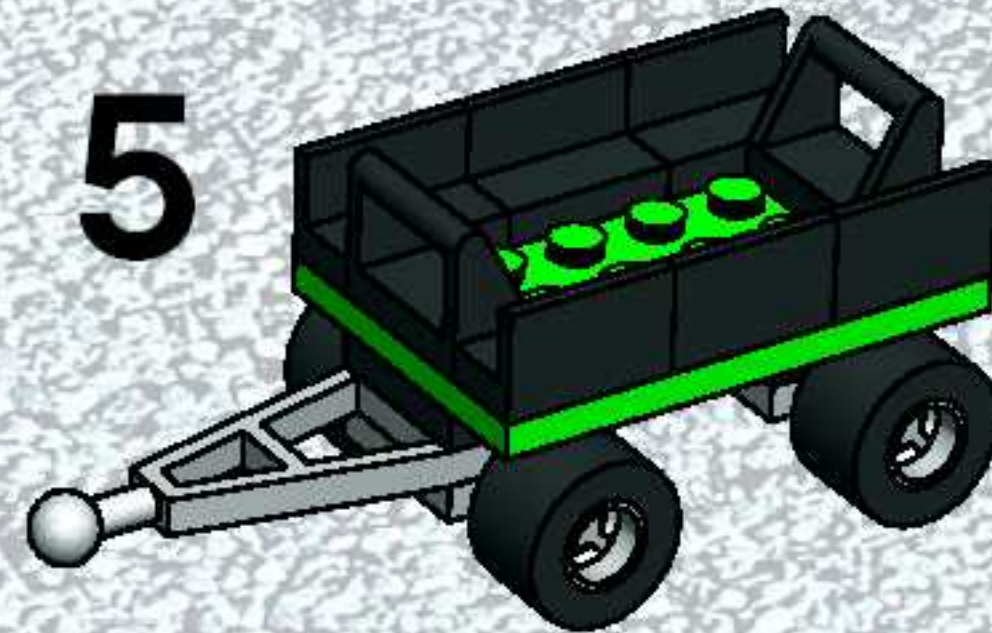

6



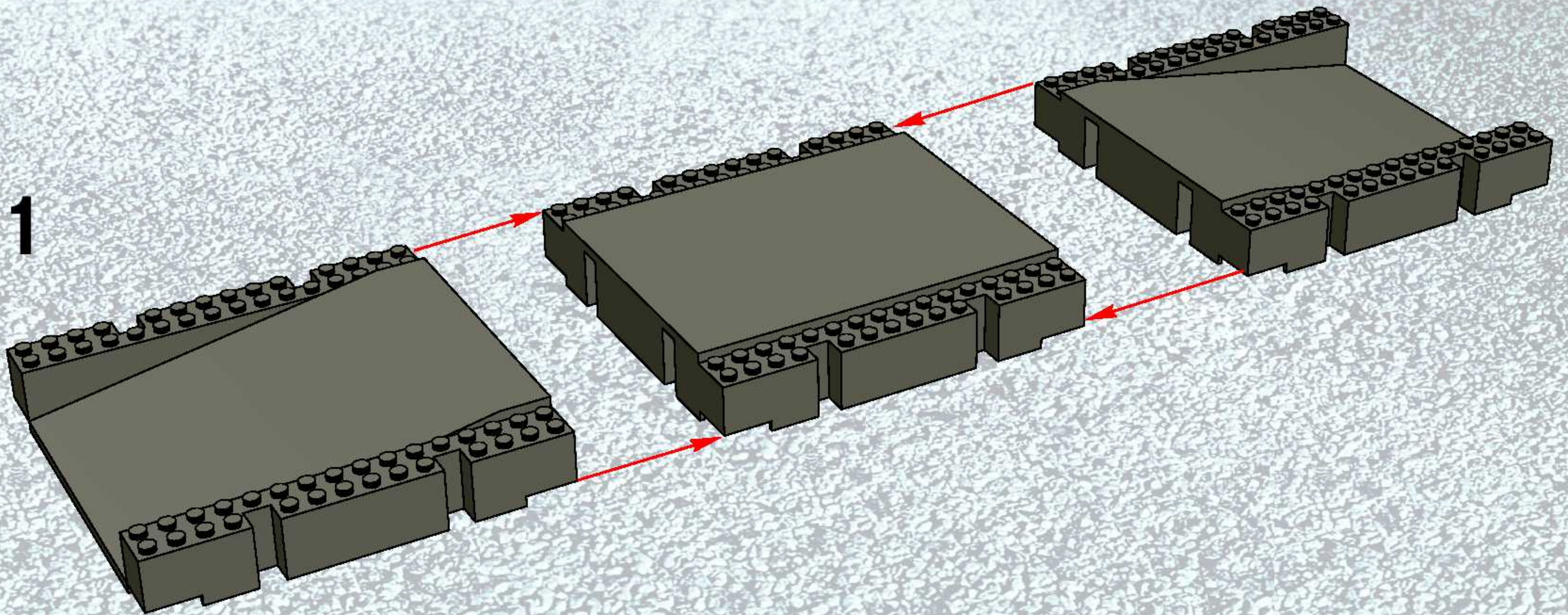

2

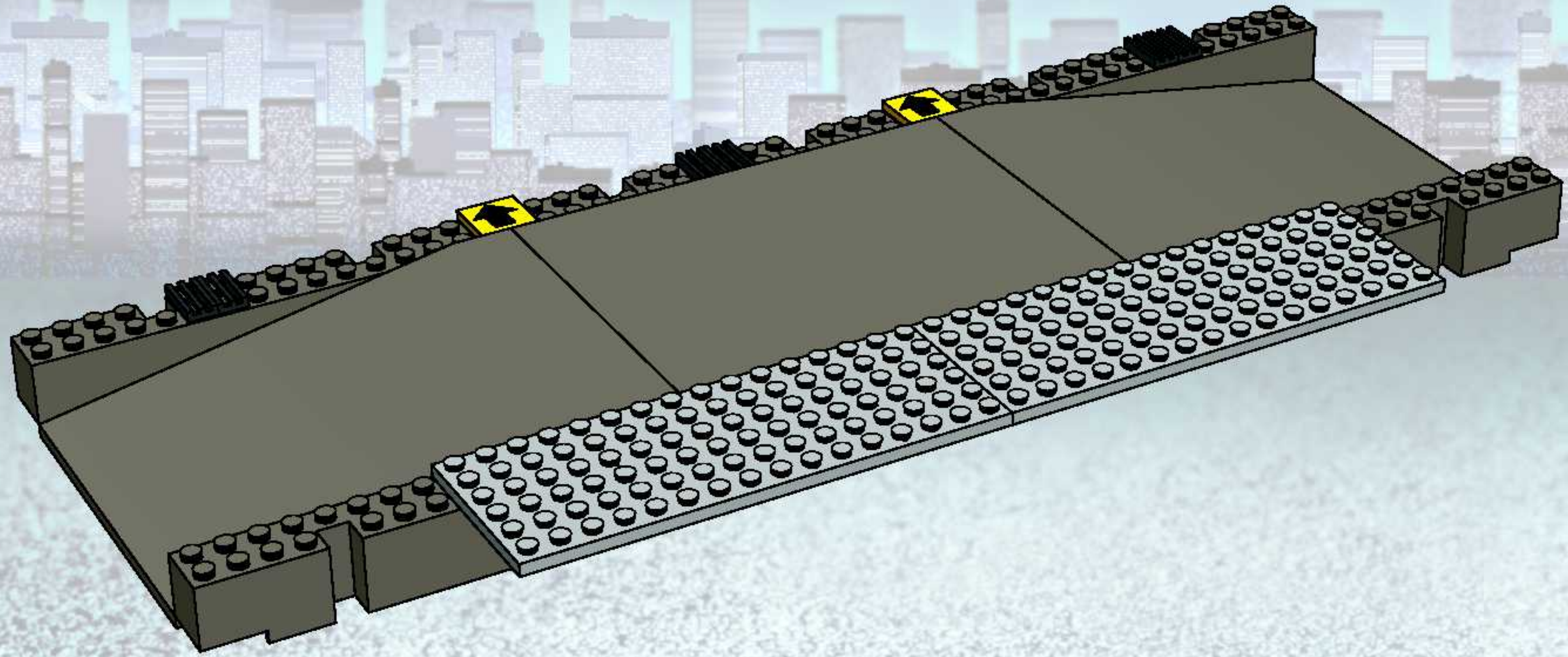

3

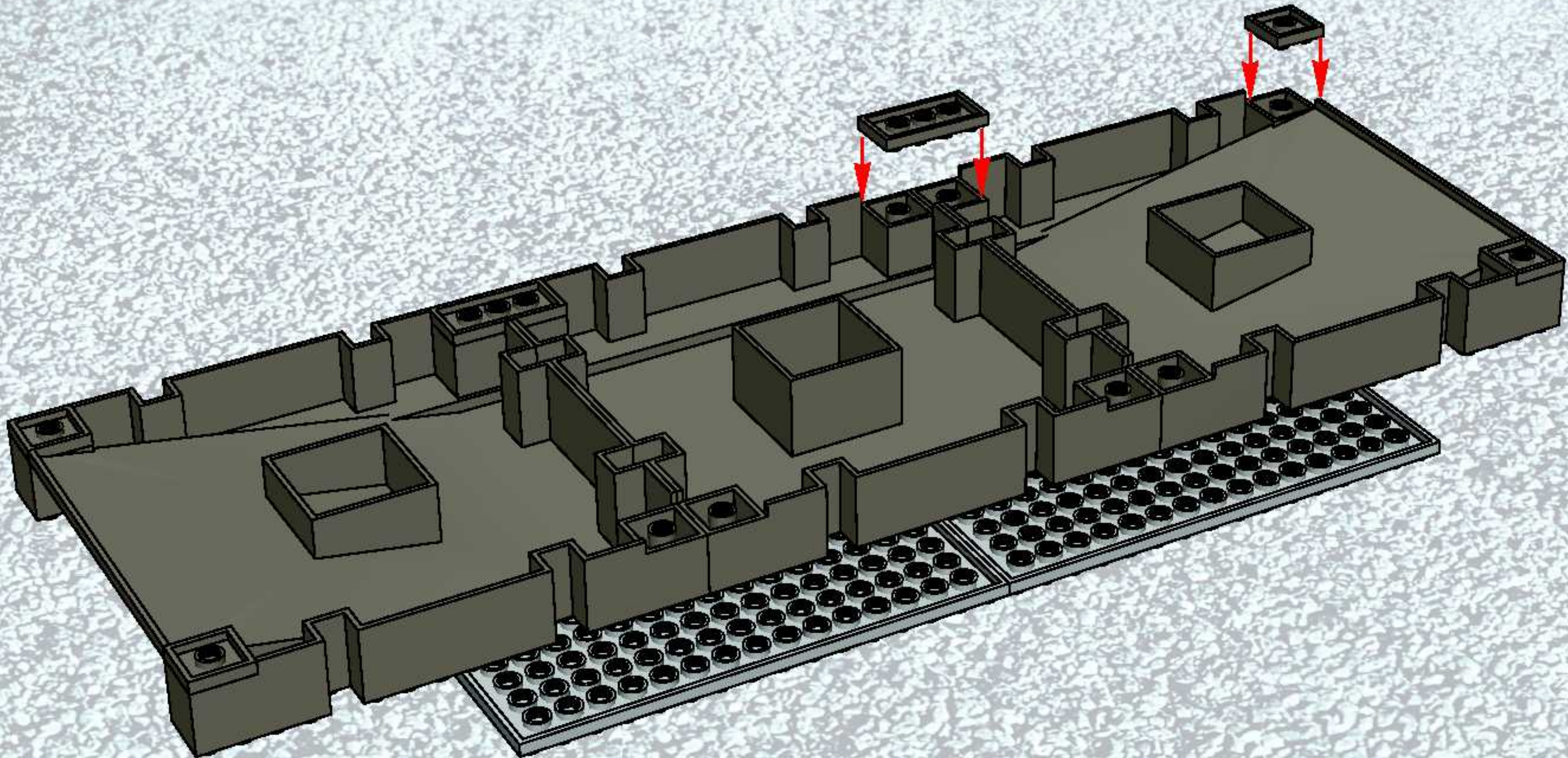

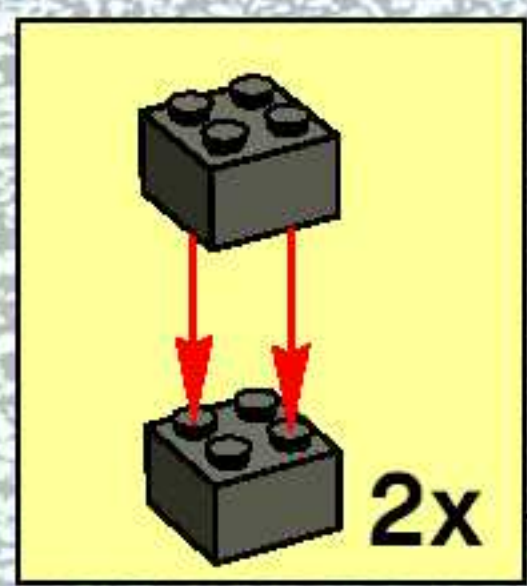
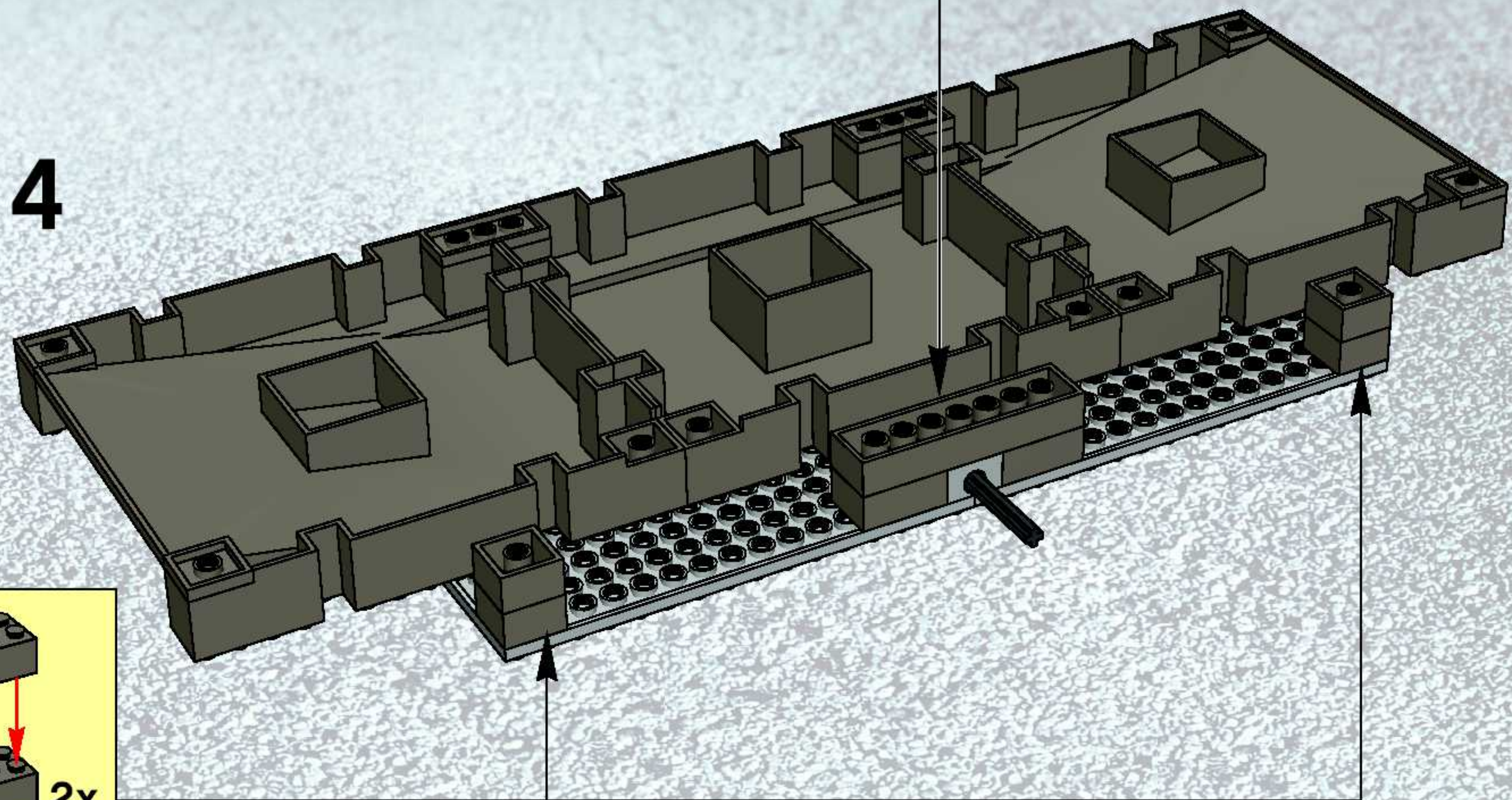
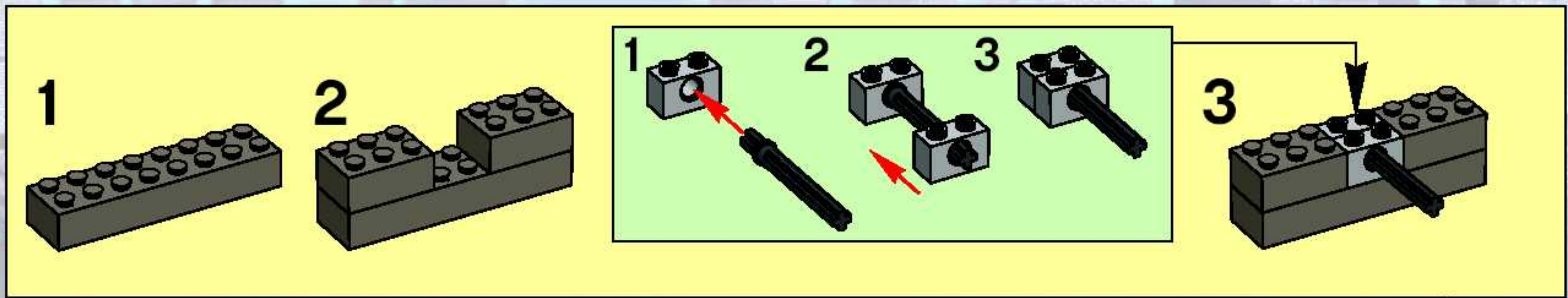

5

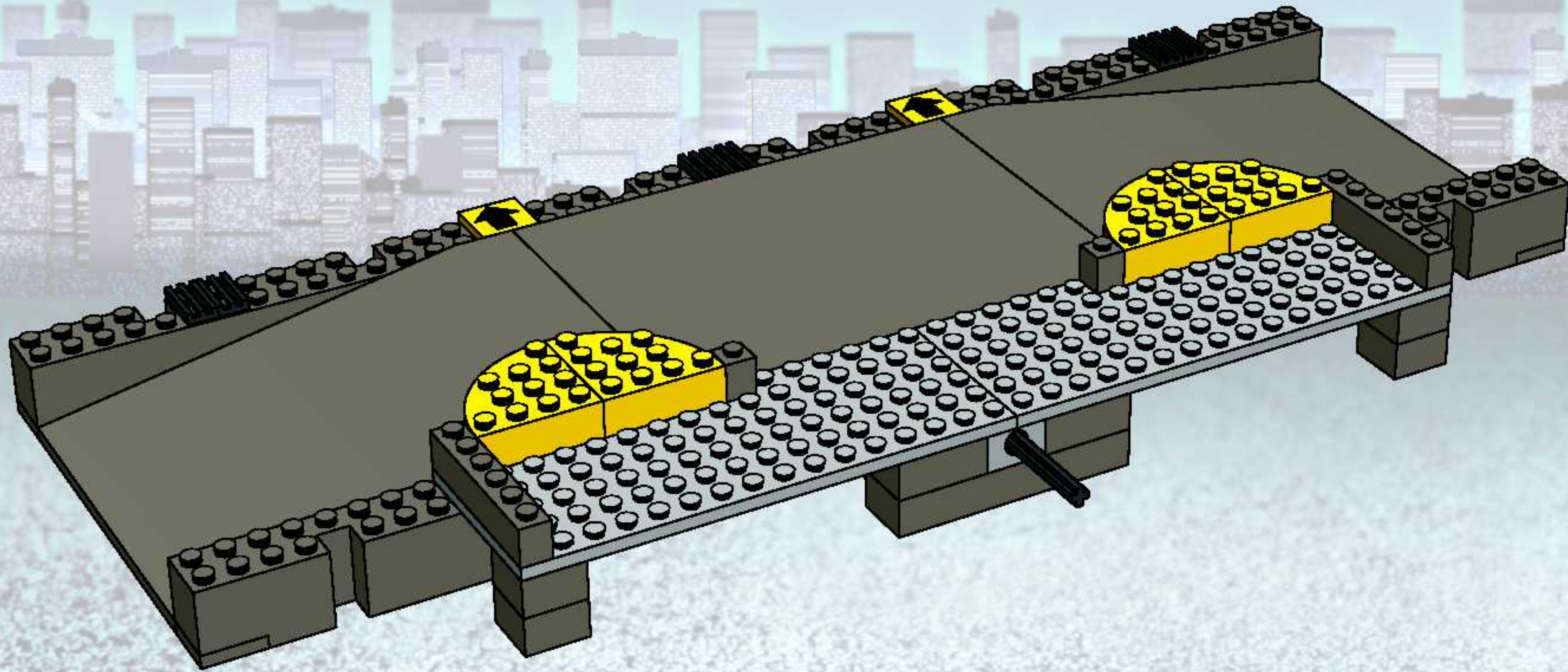

6

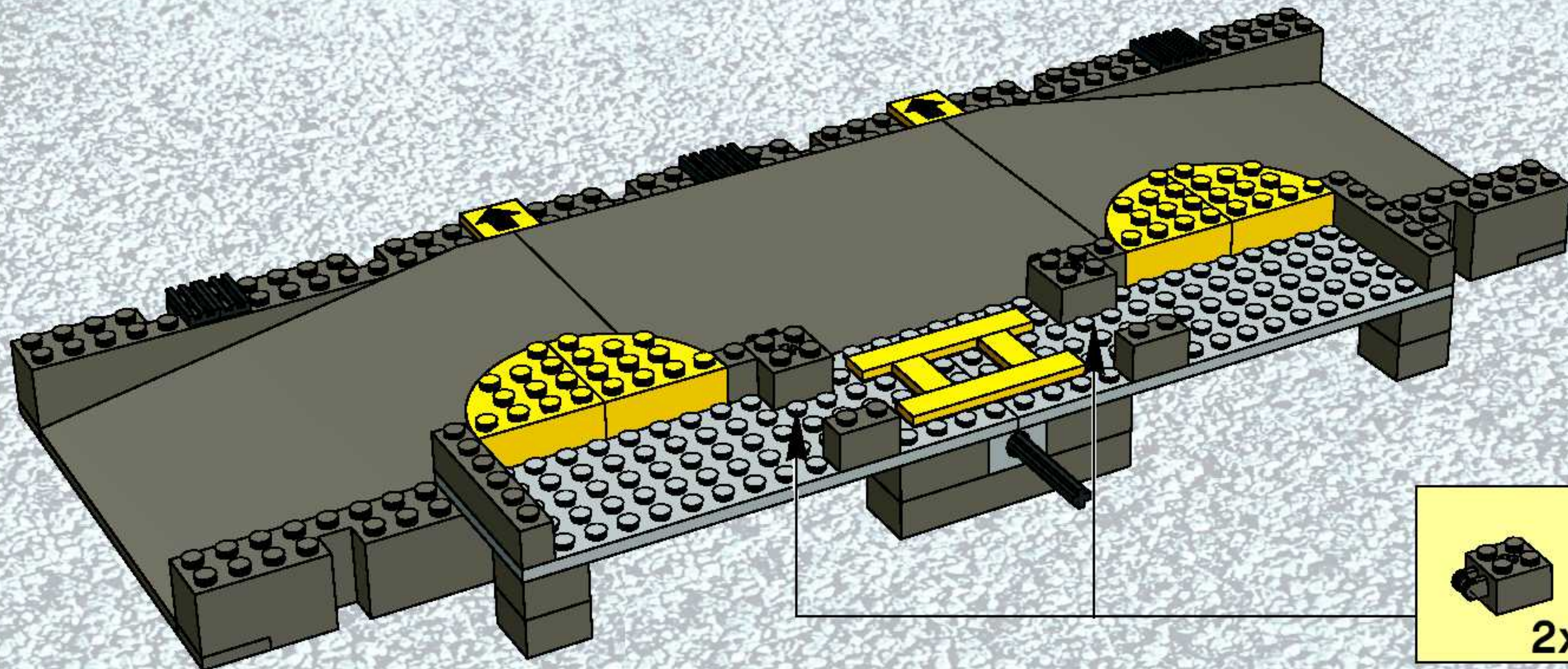

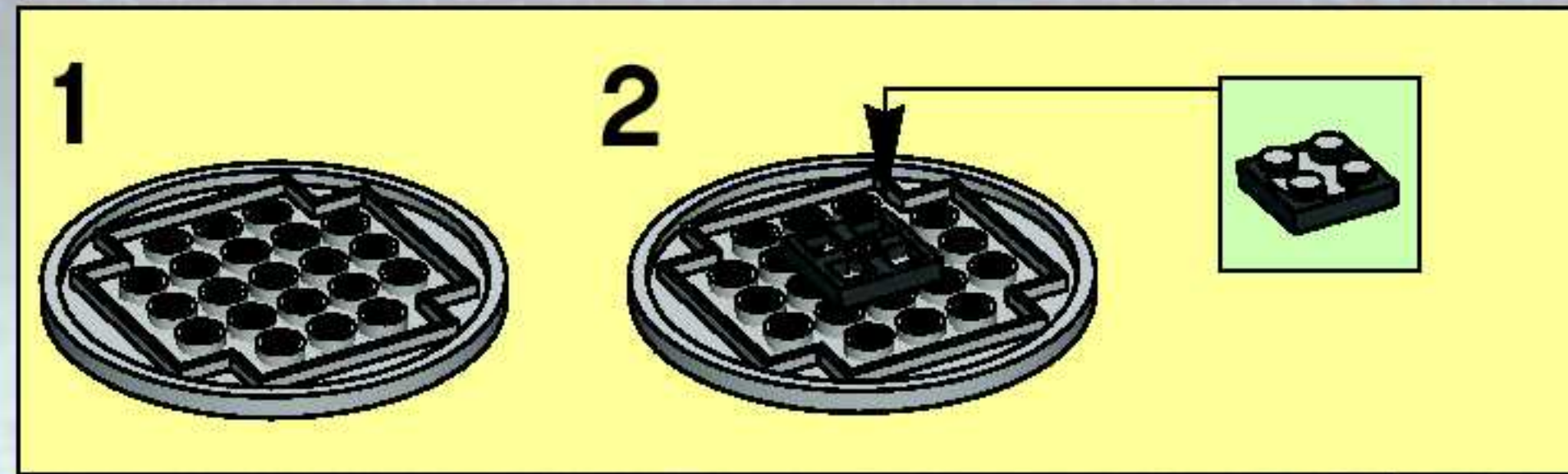

7

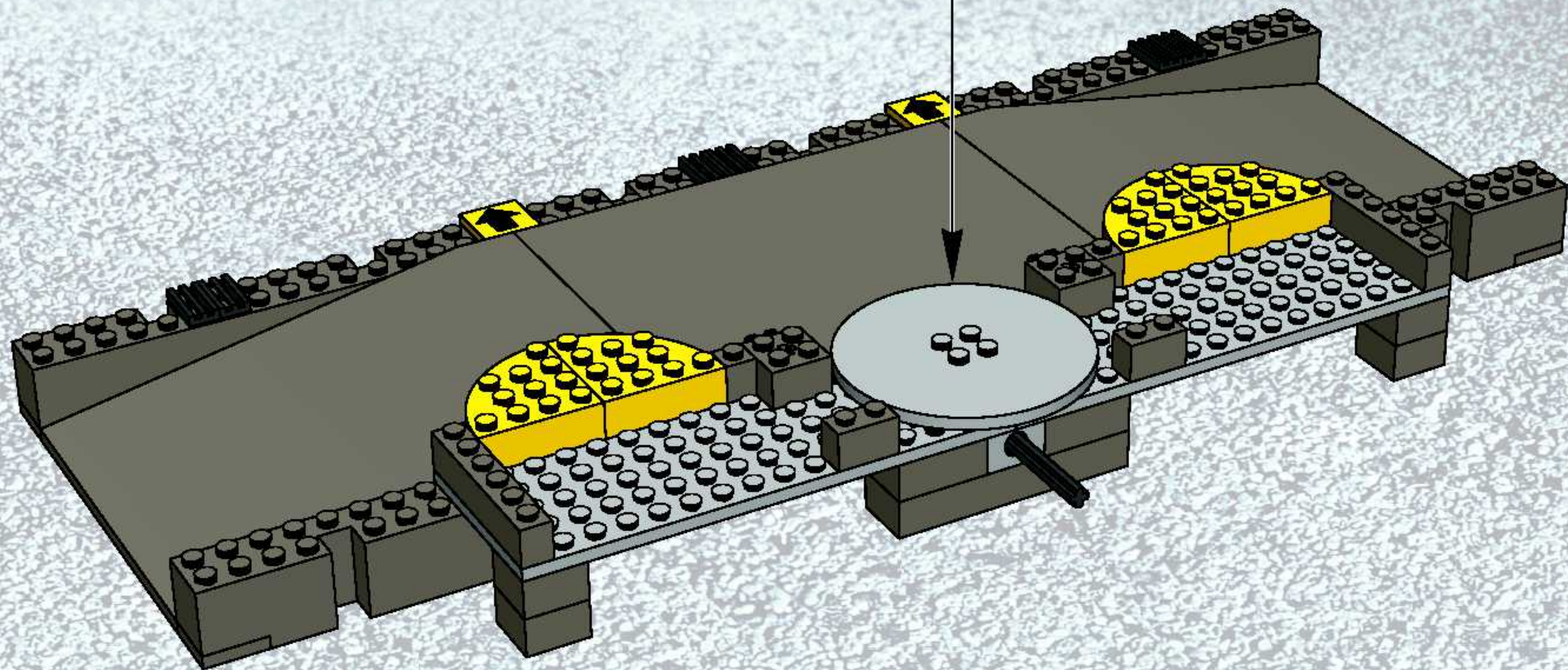

8

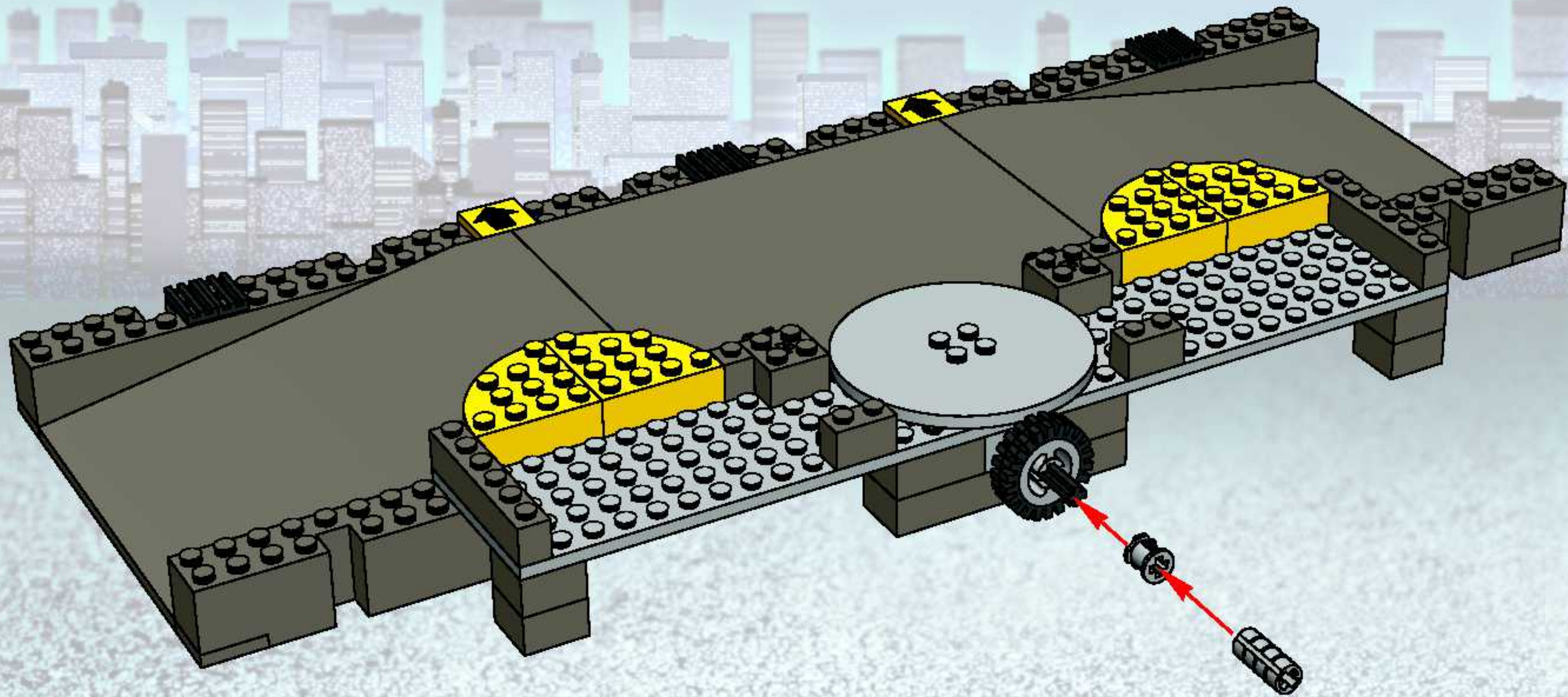

9

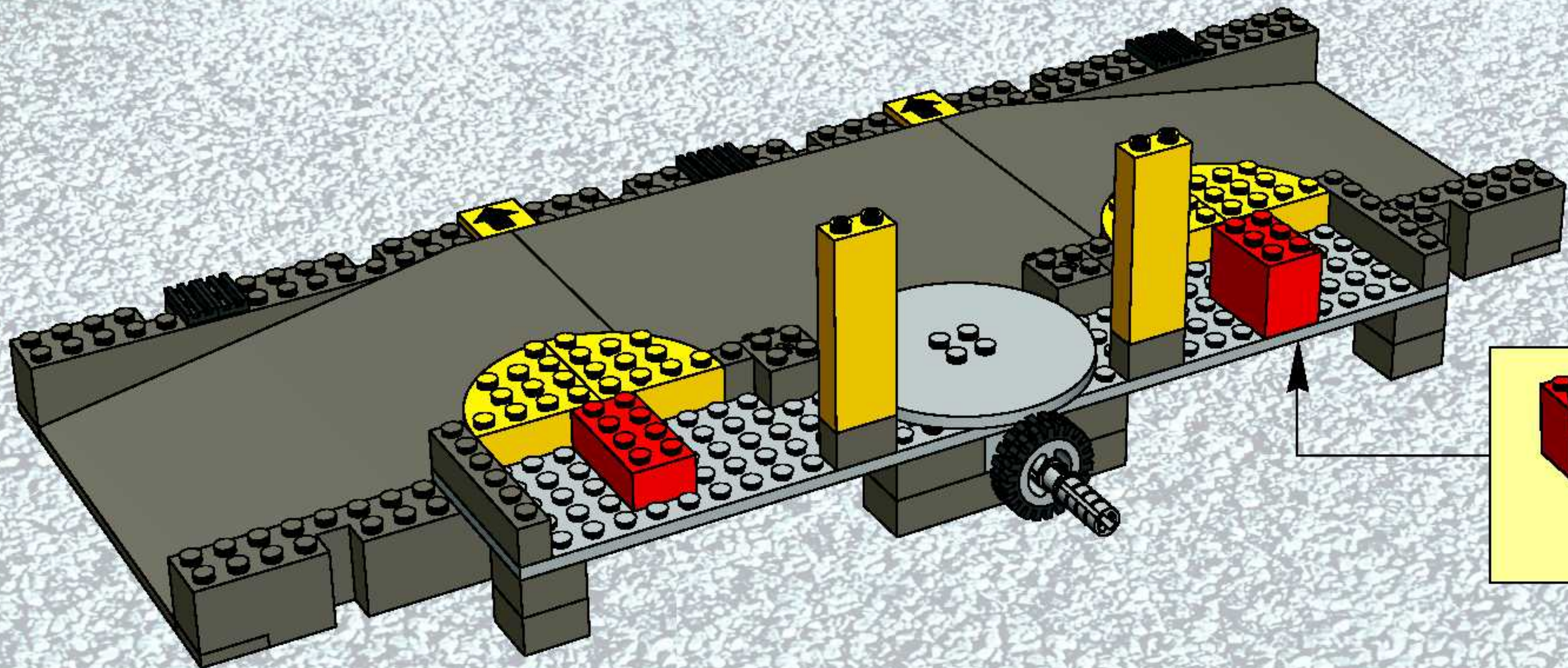

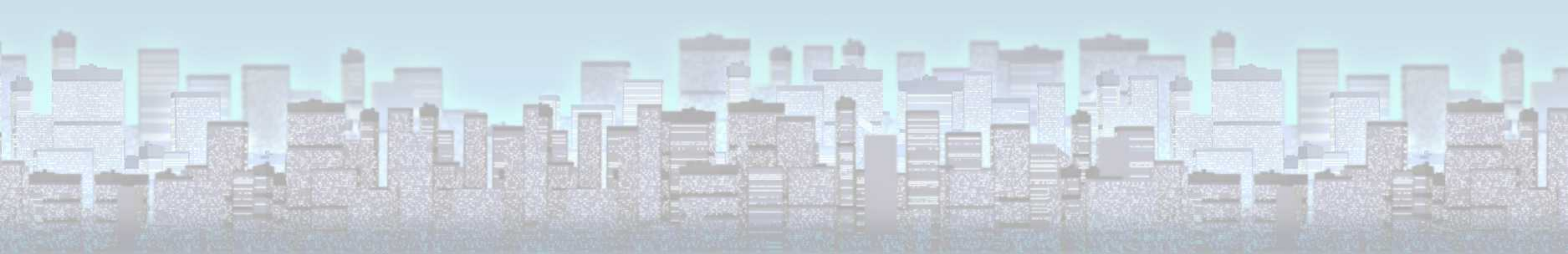

10

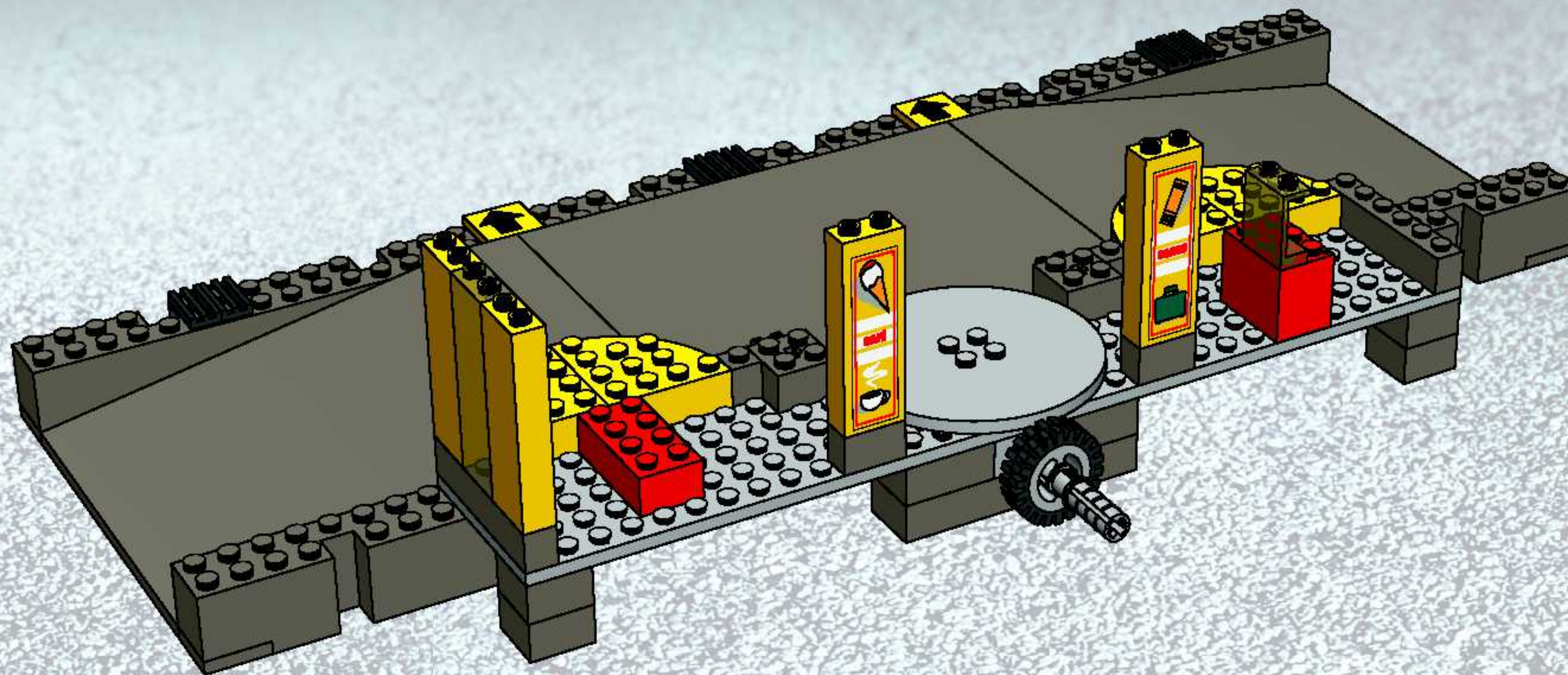

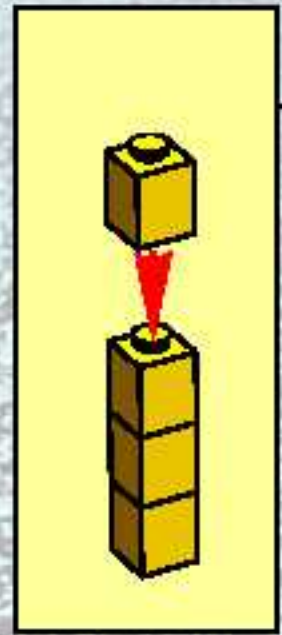

11

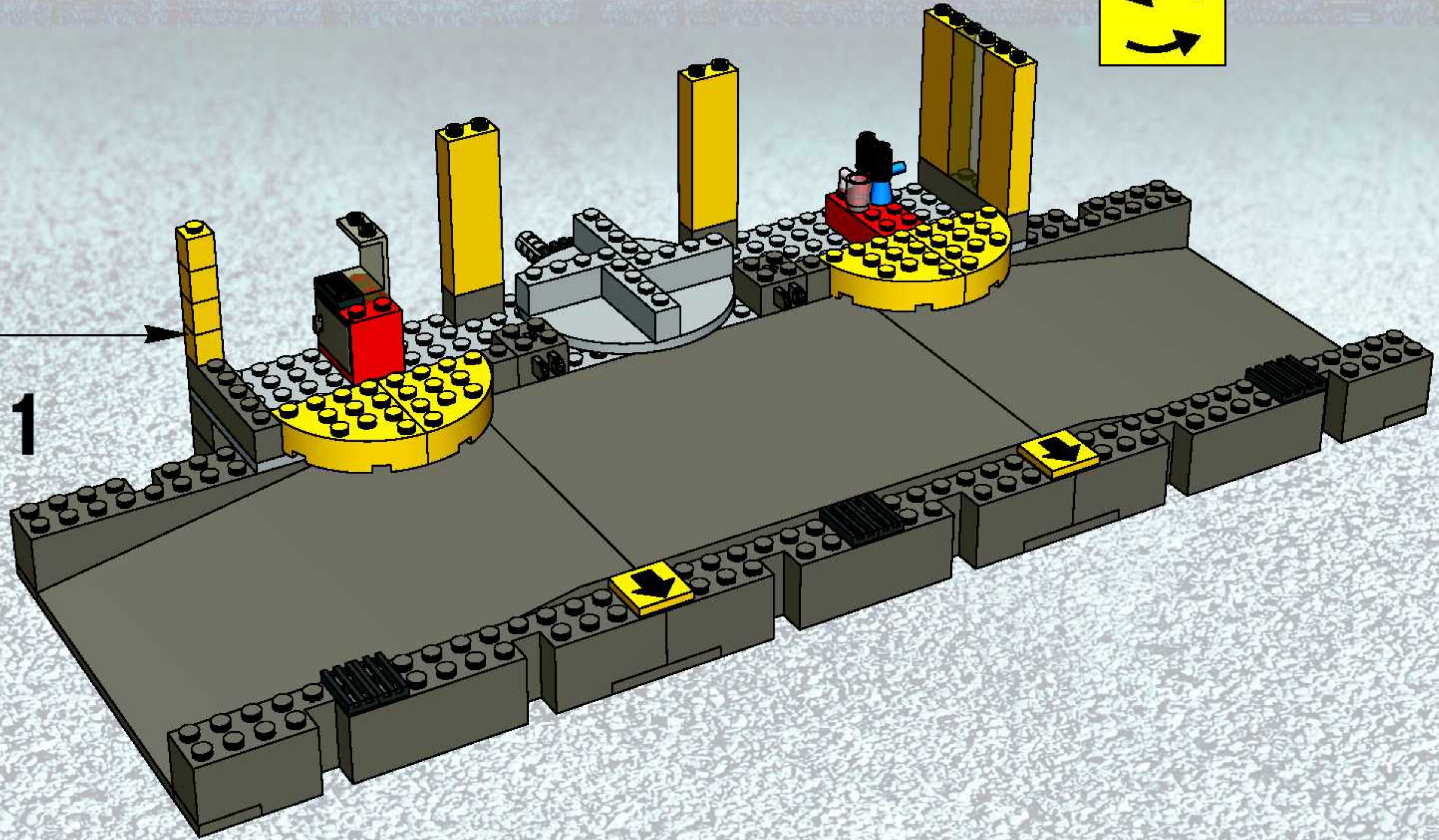

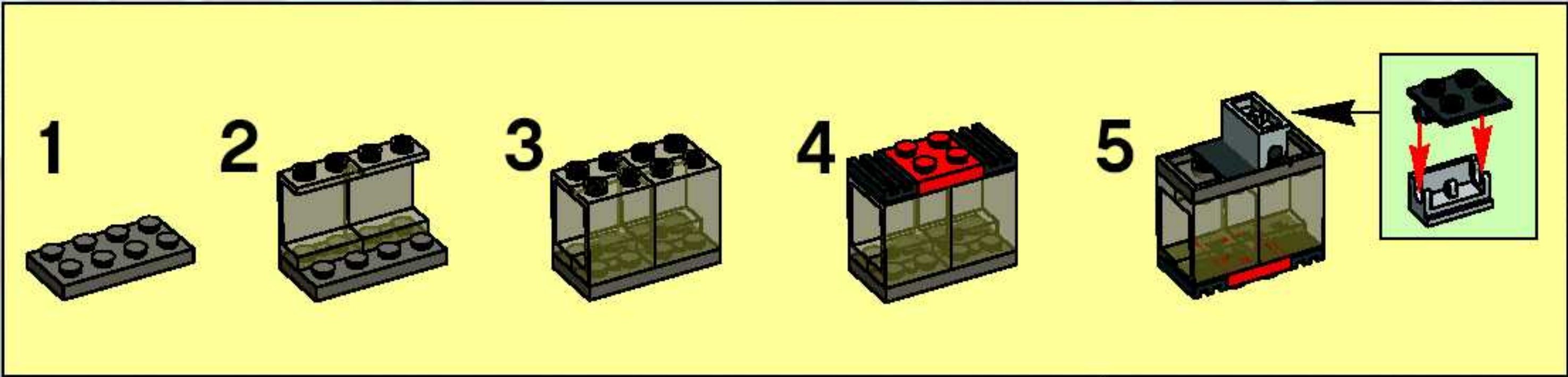

12

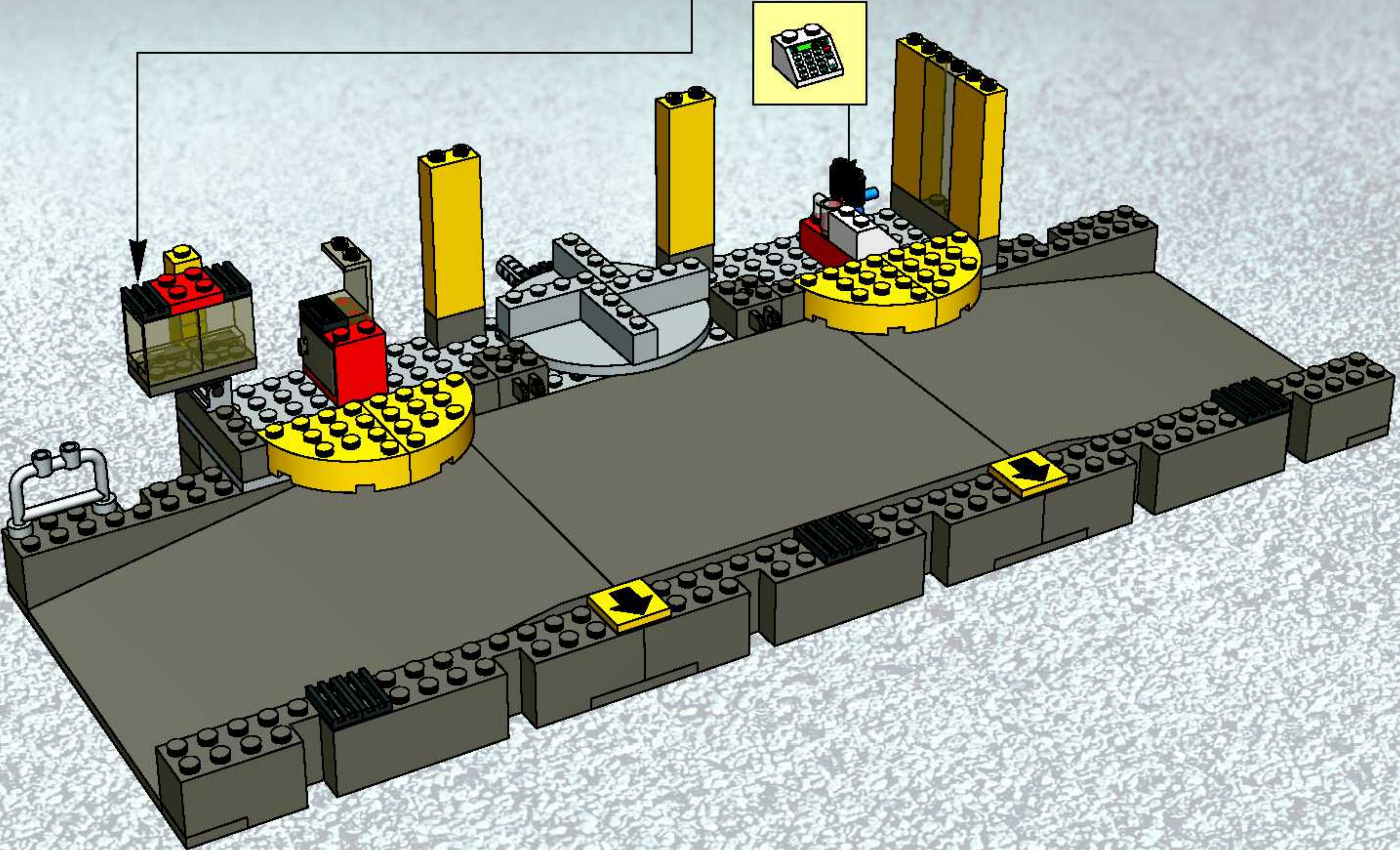



13

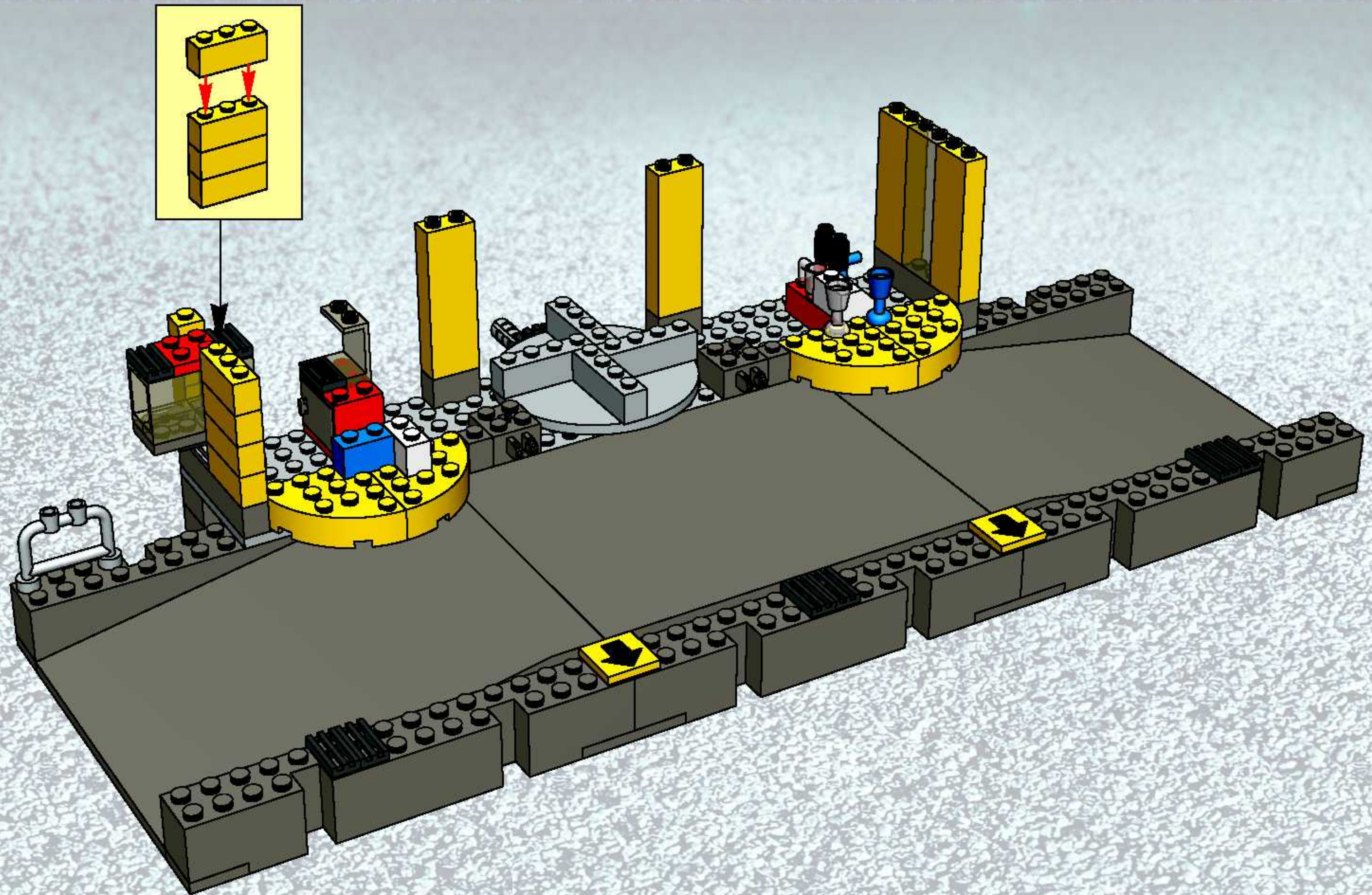

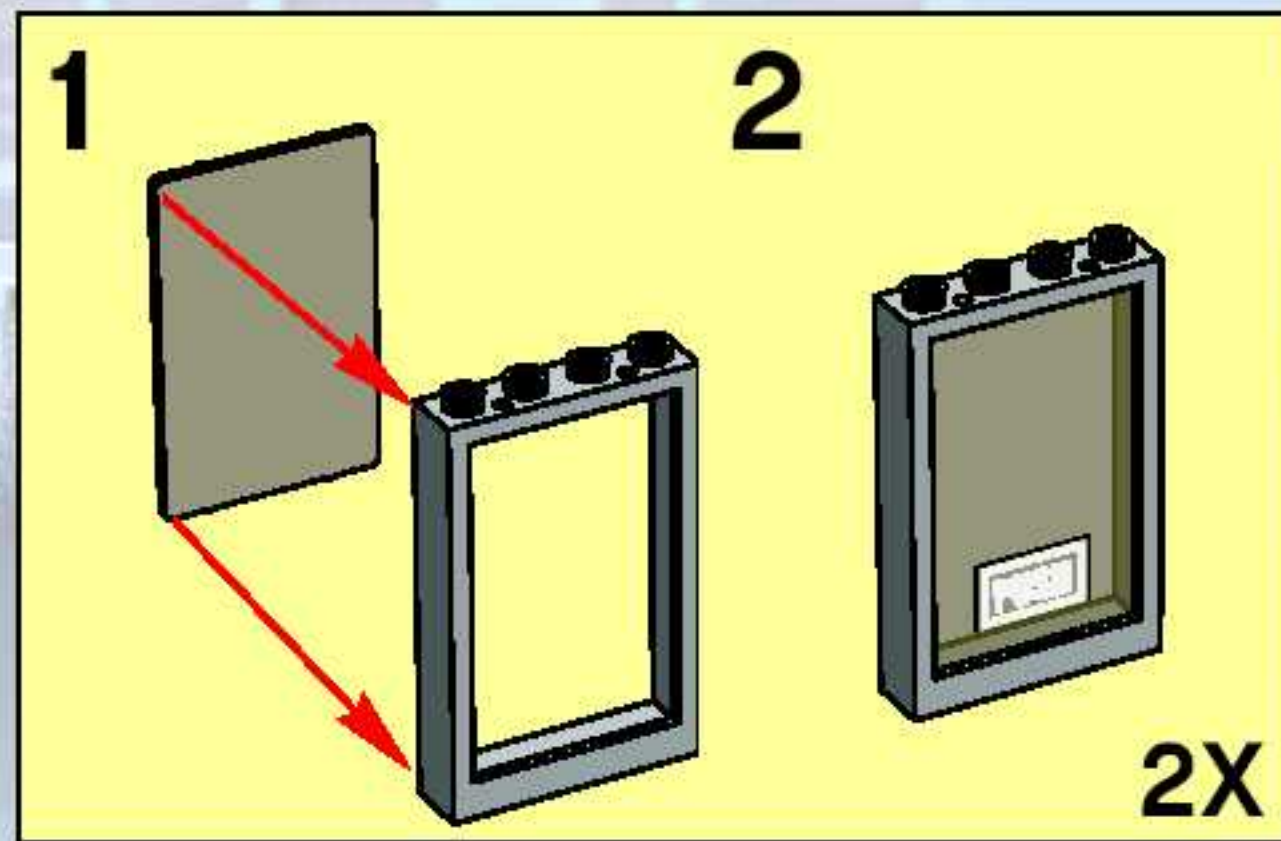

14

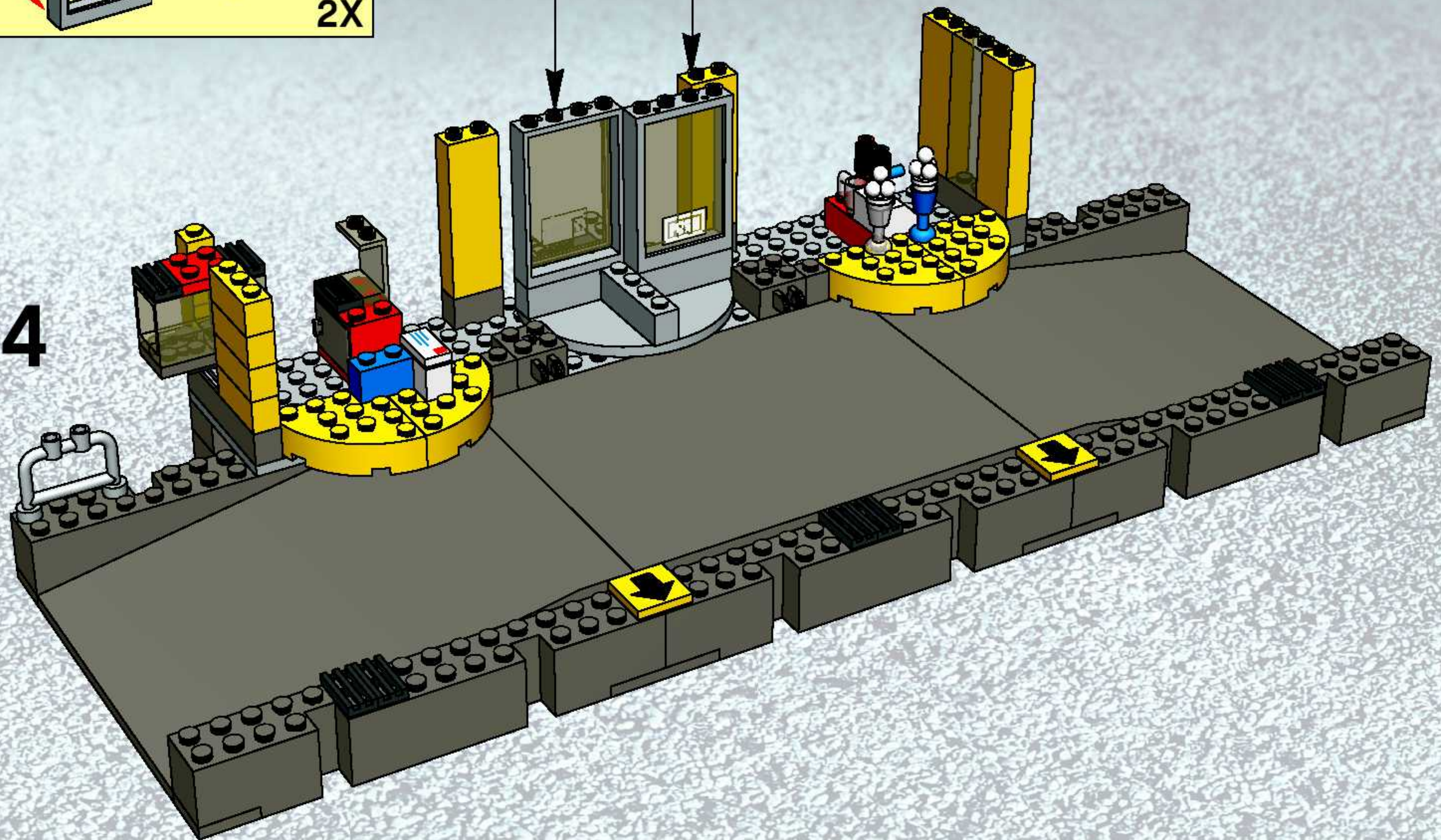

15

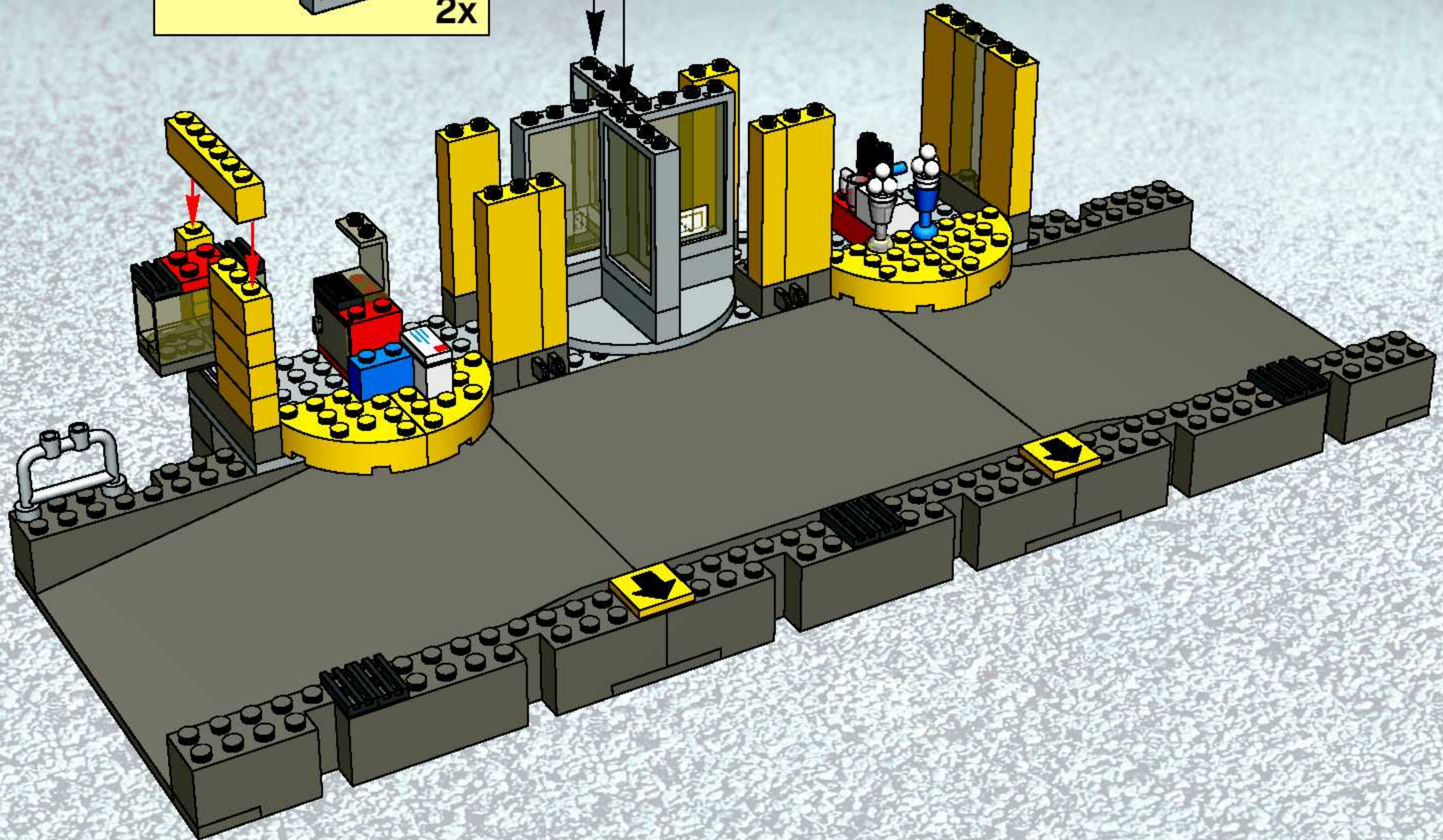
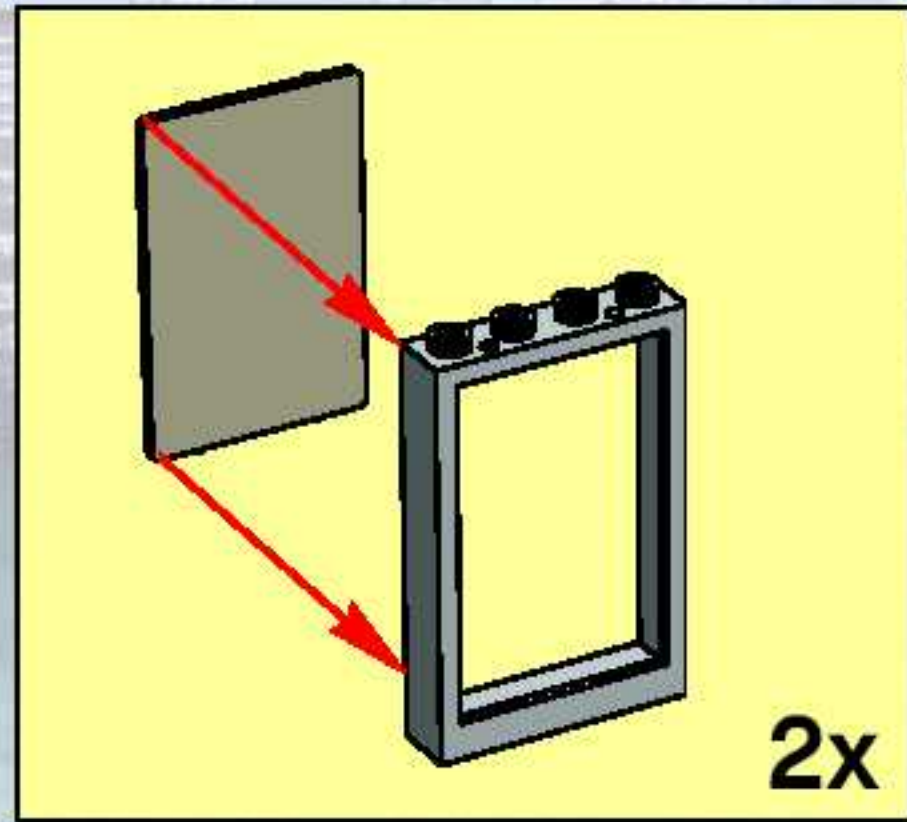

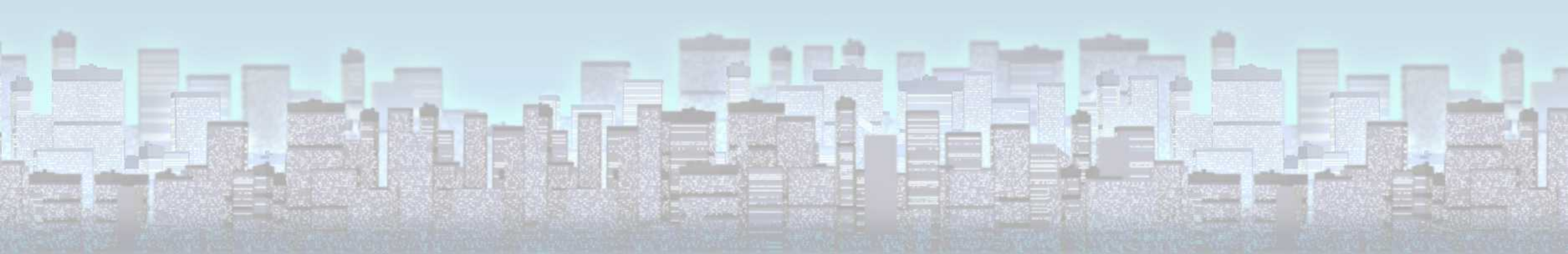

16

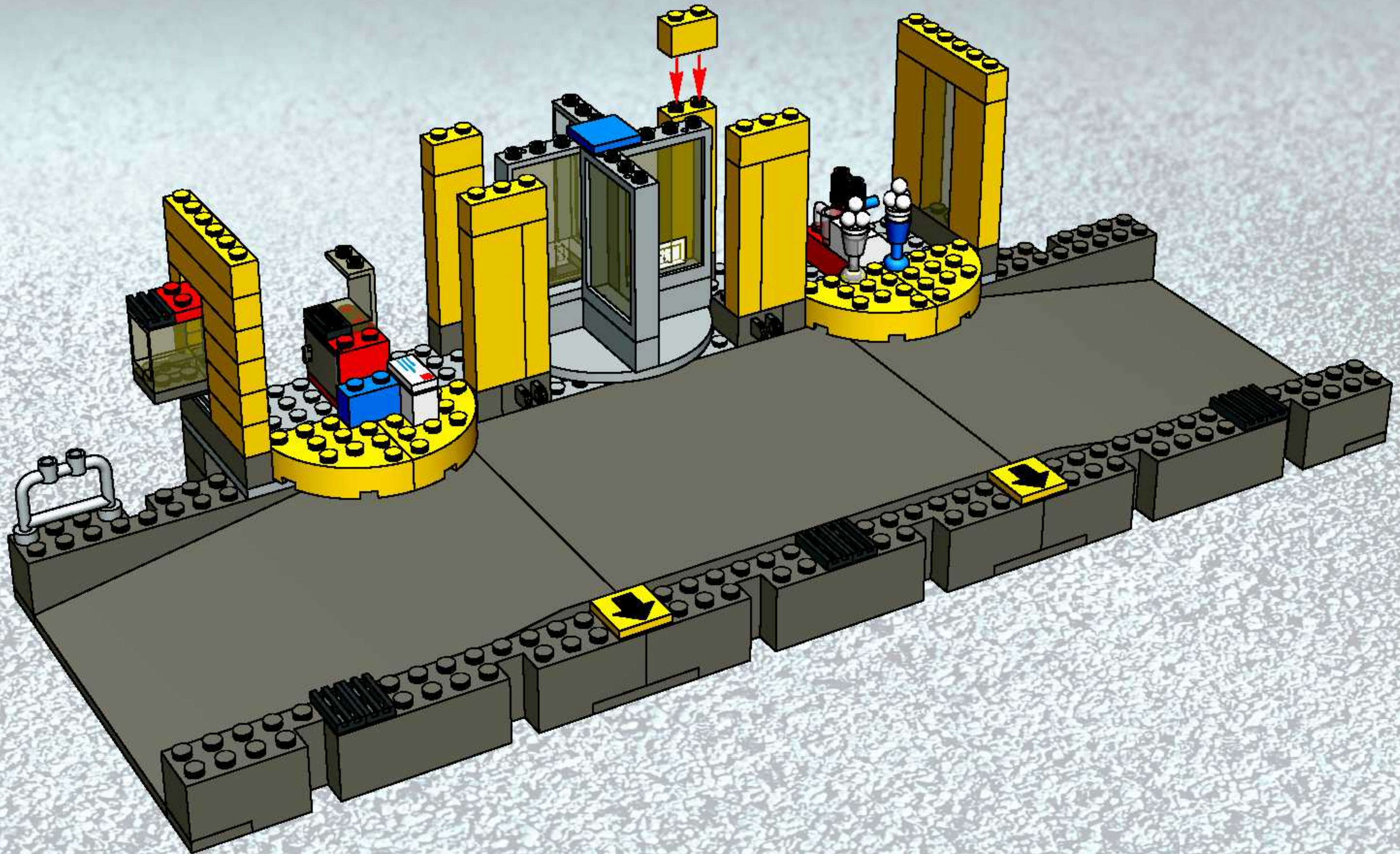

17

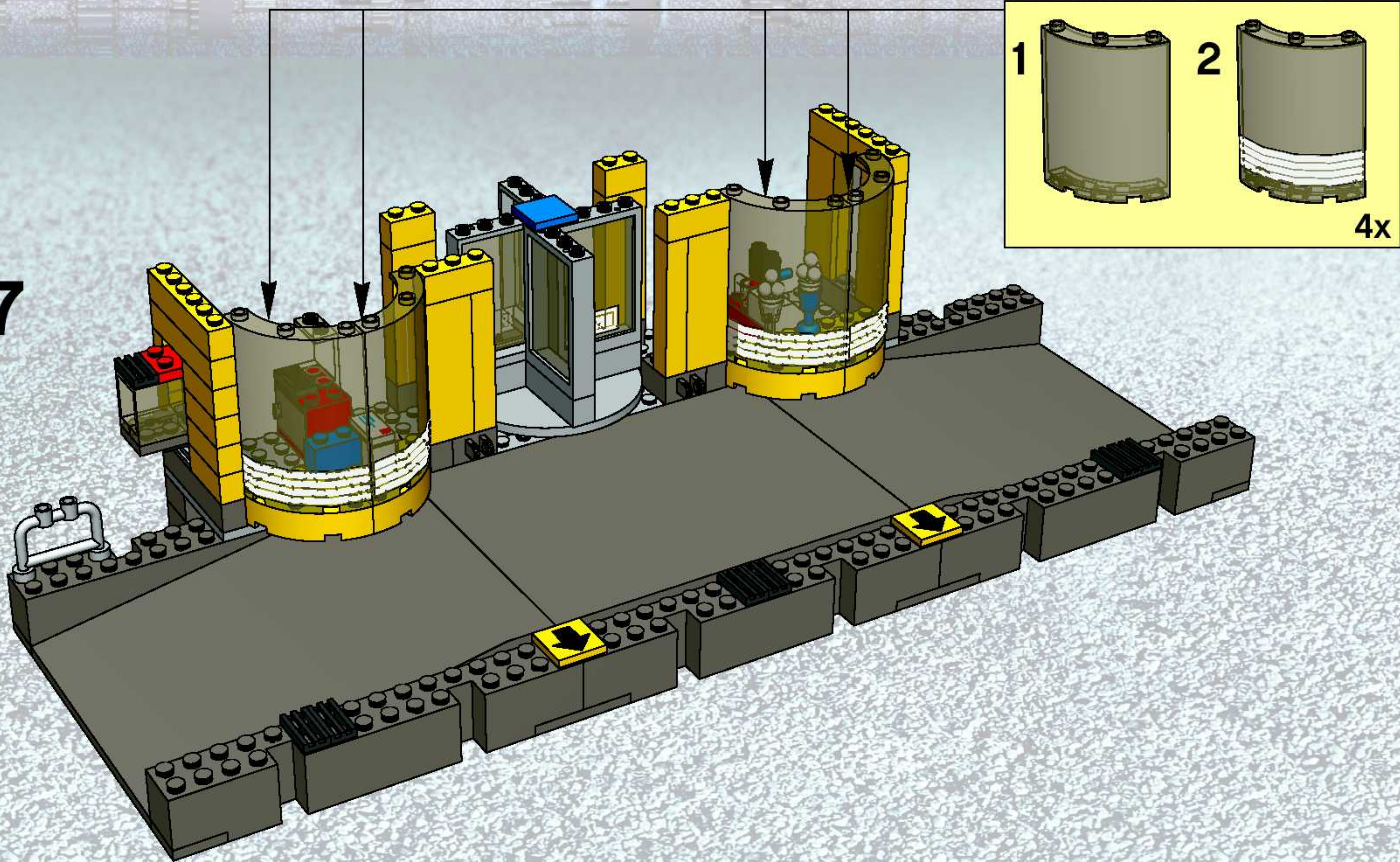

18

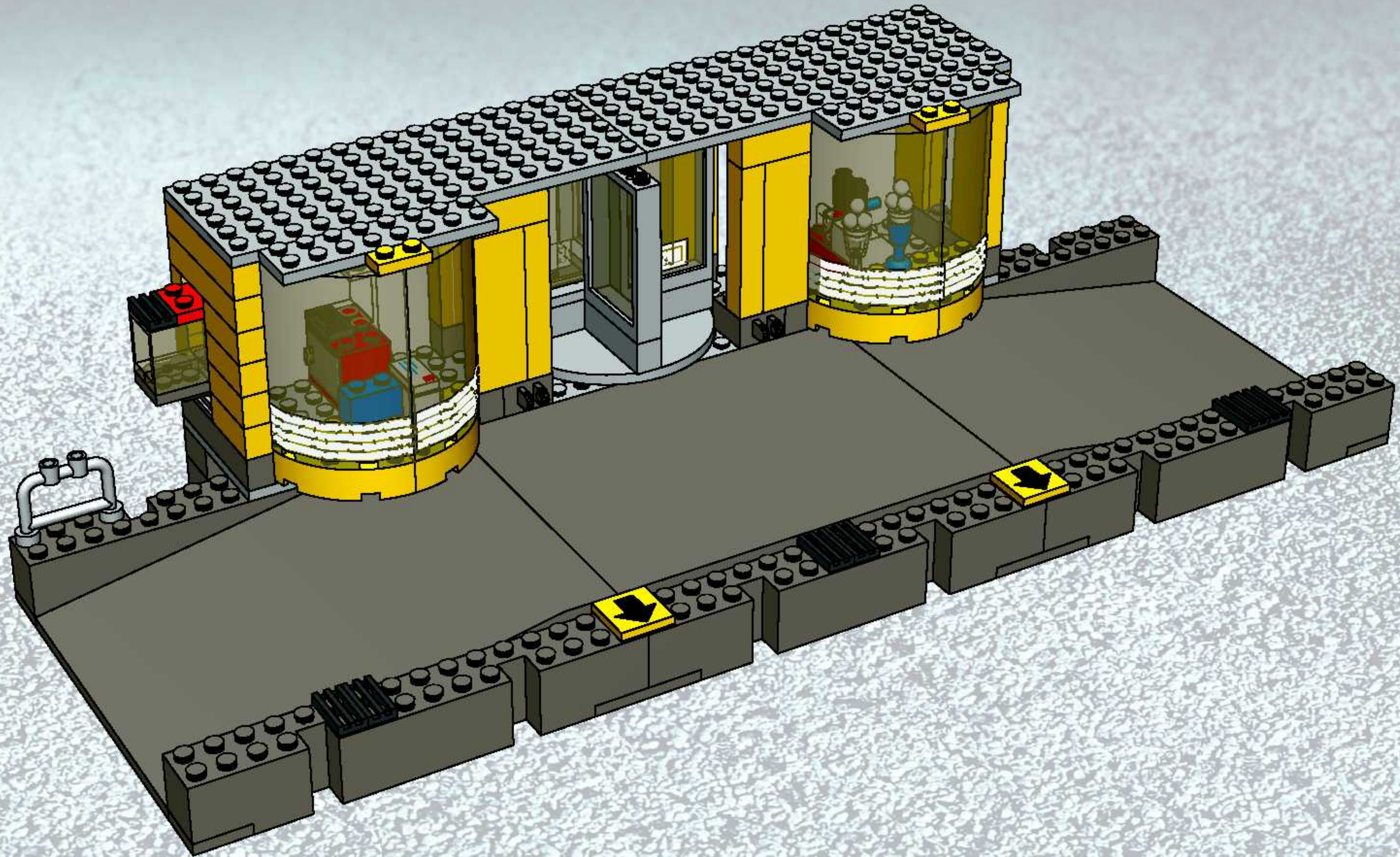

19

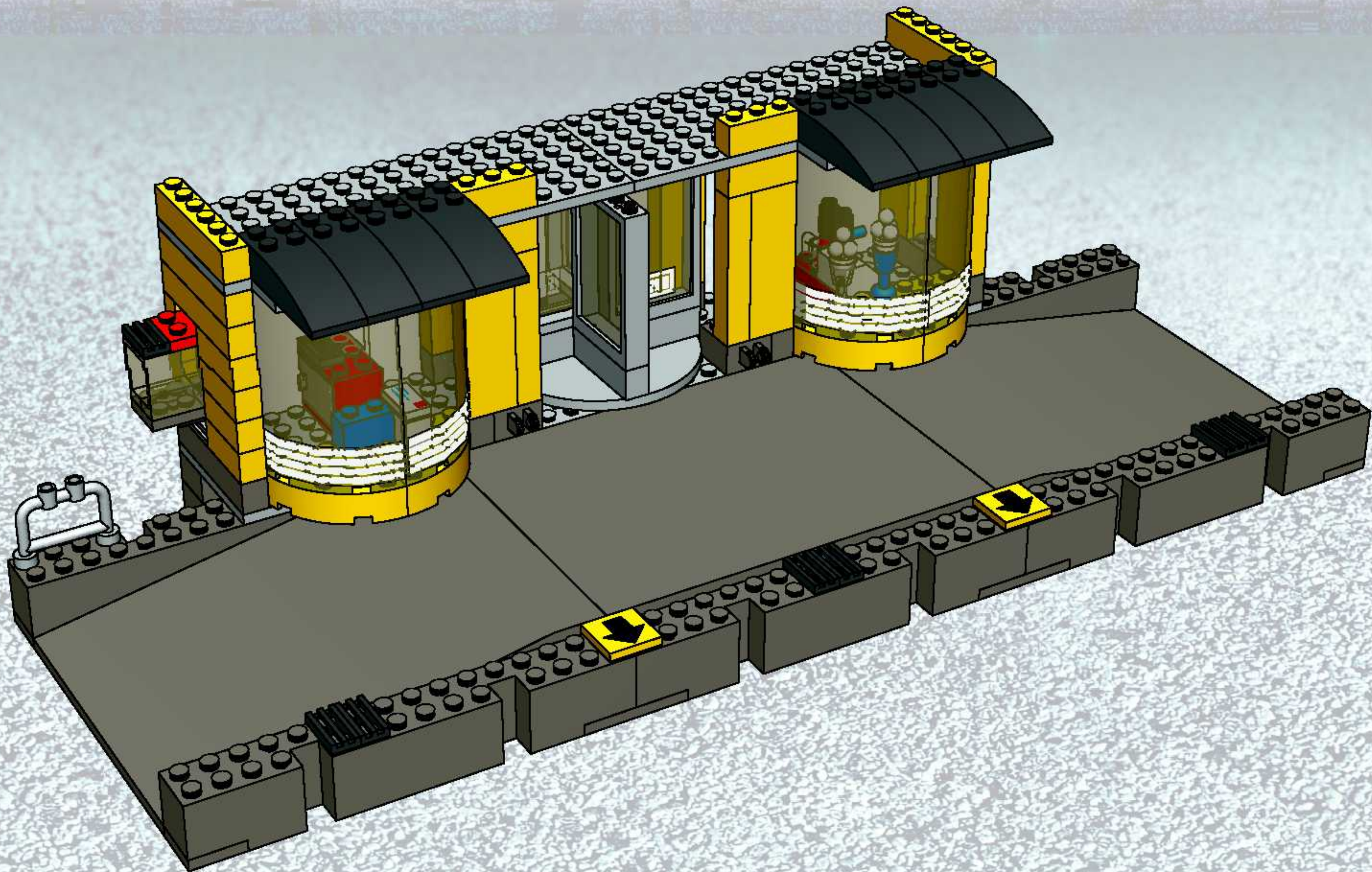

20



21

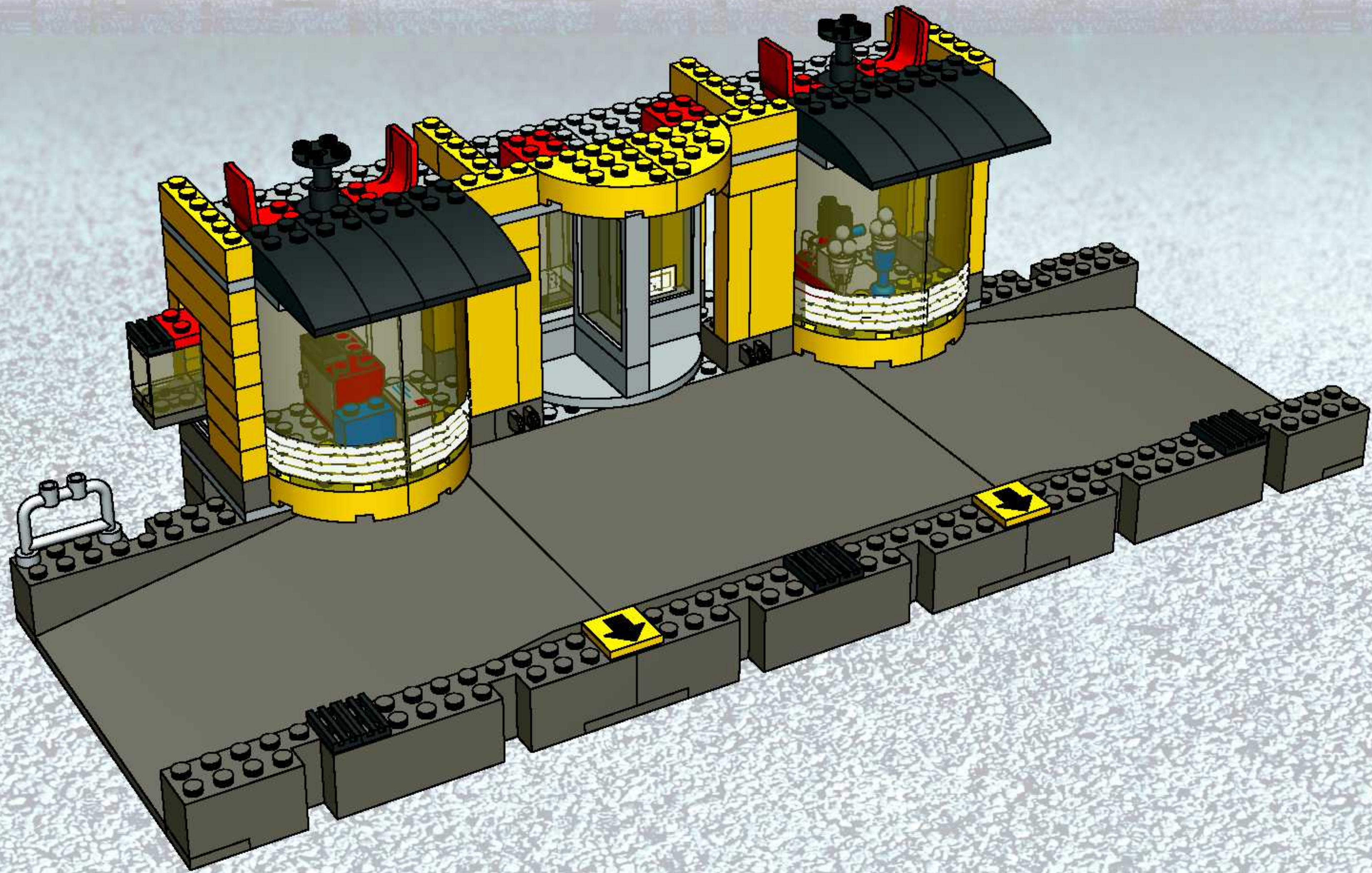

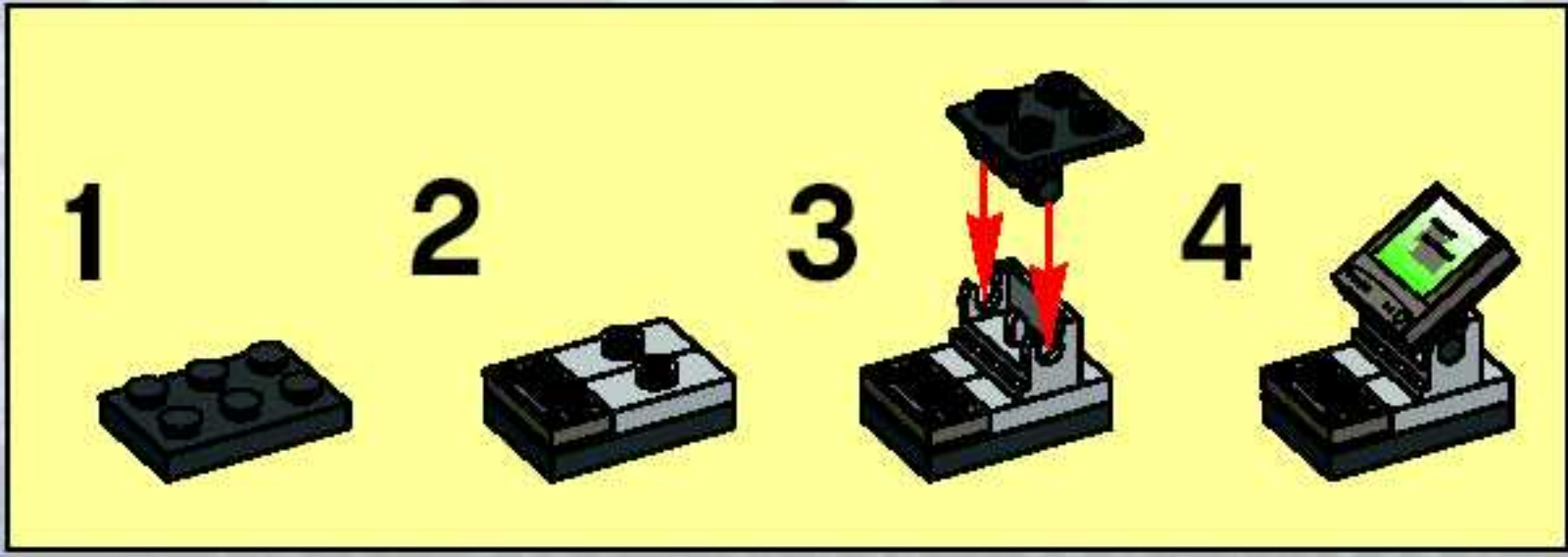

22

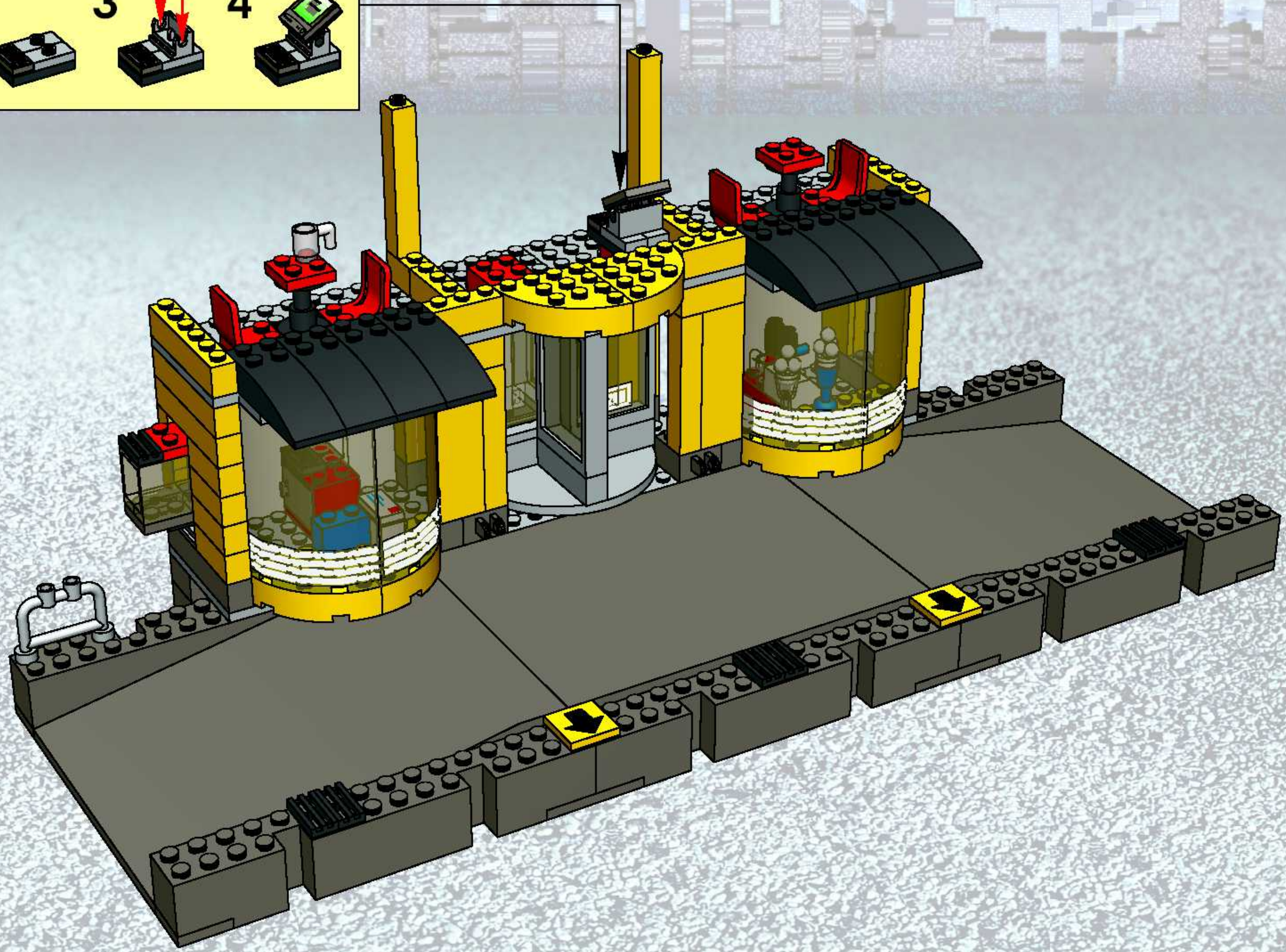

23

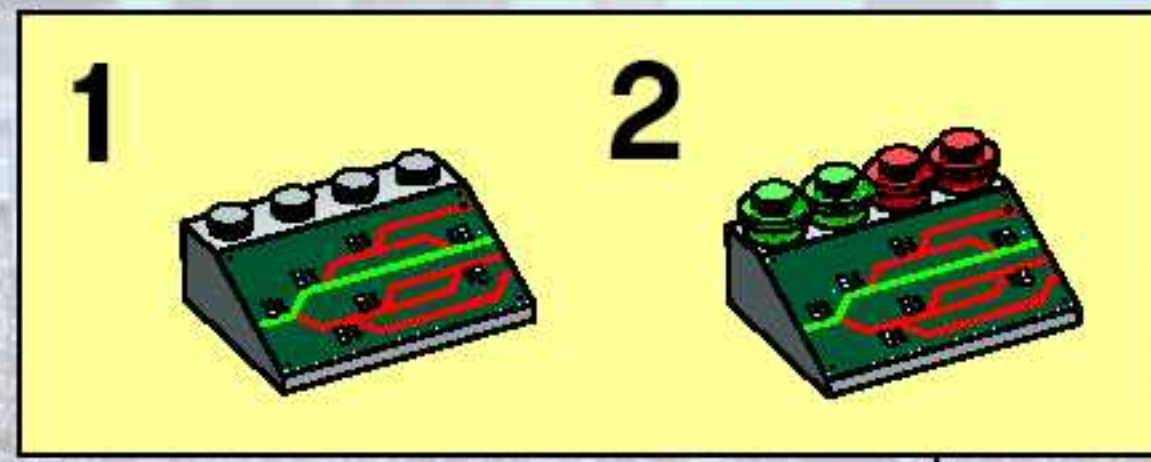

24

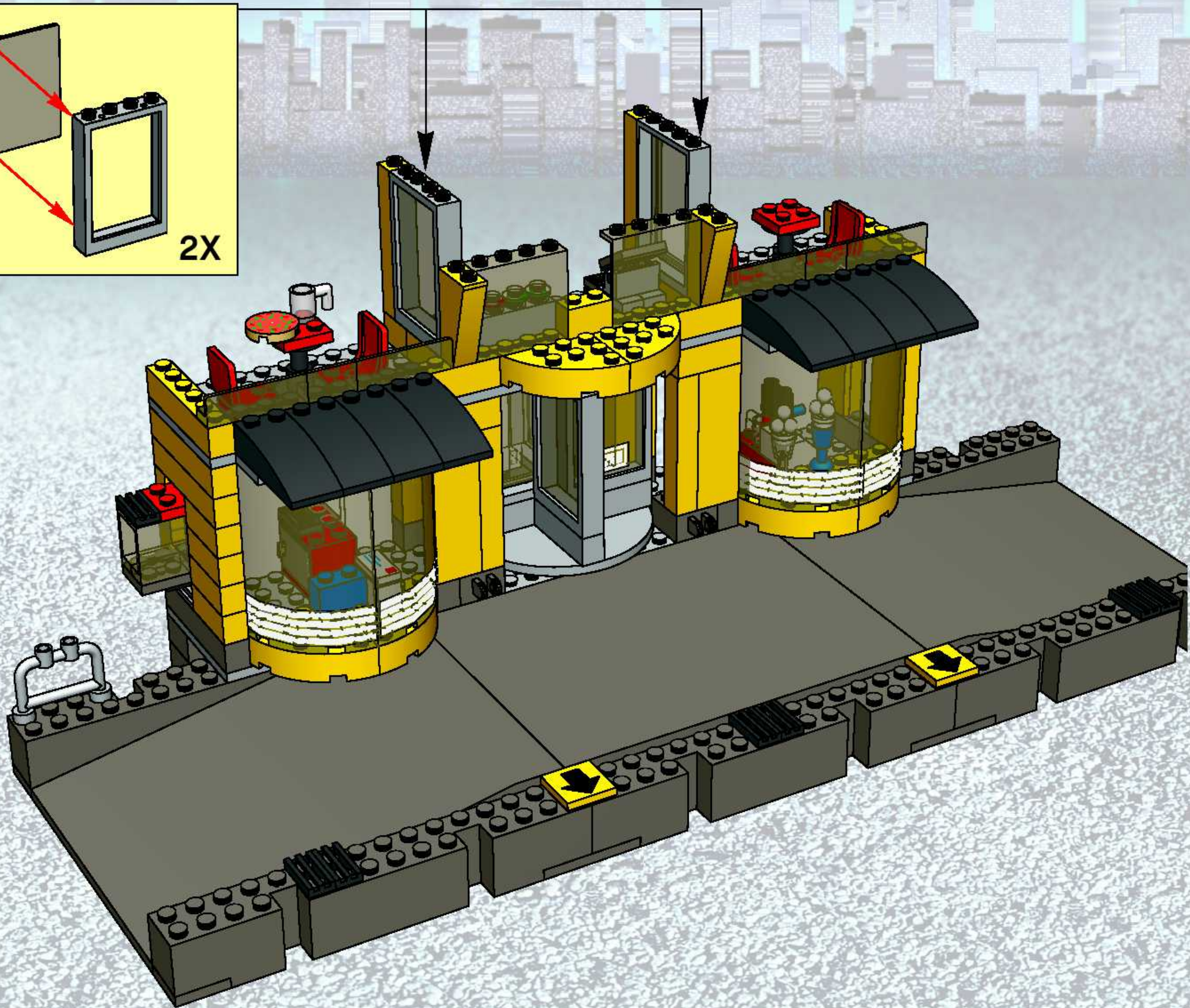
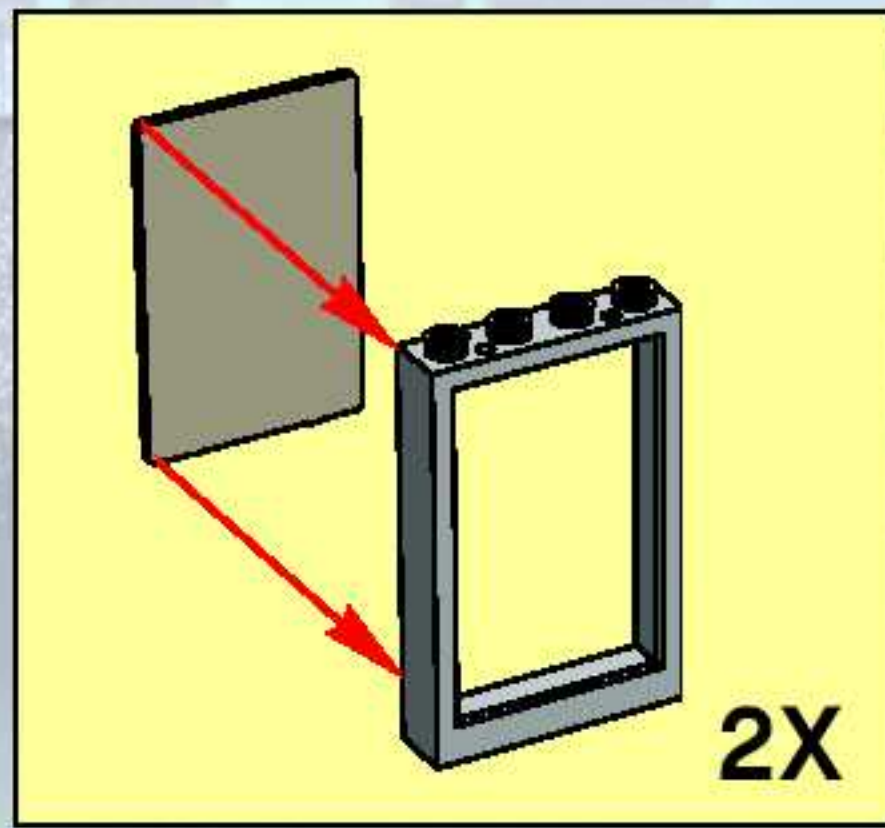

25

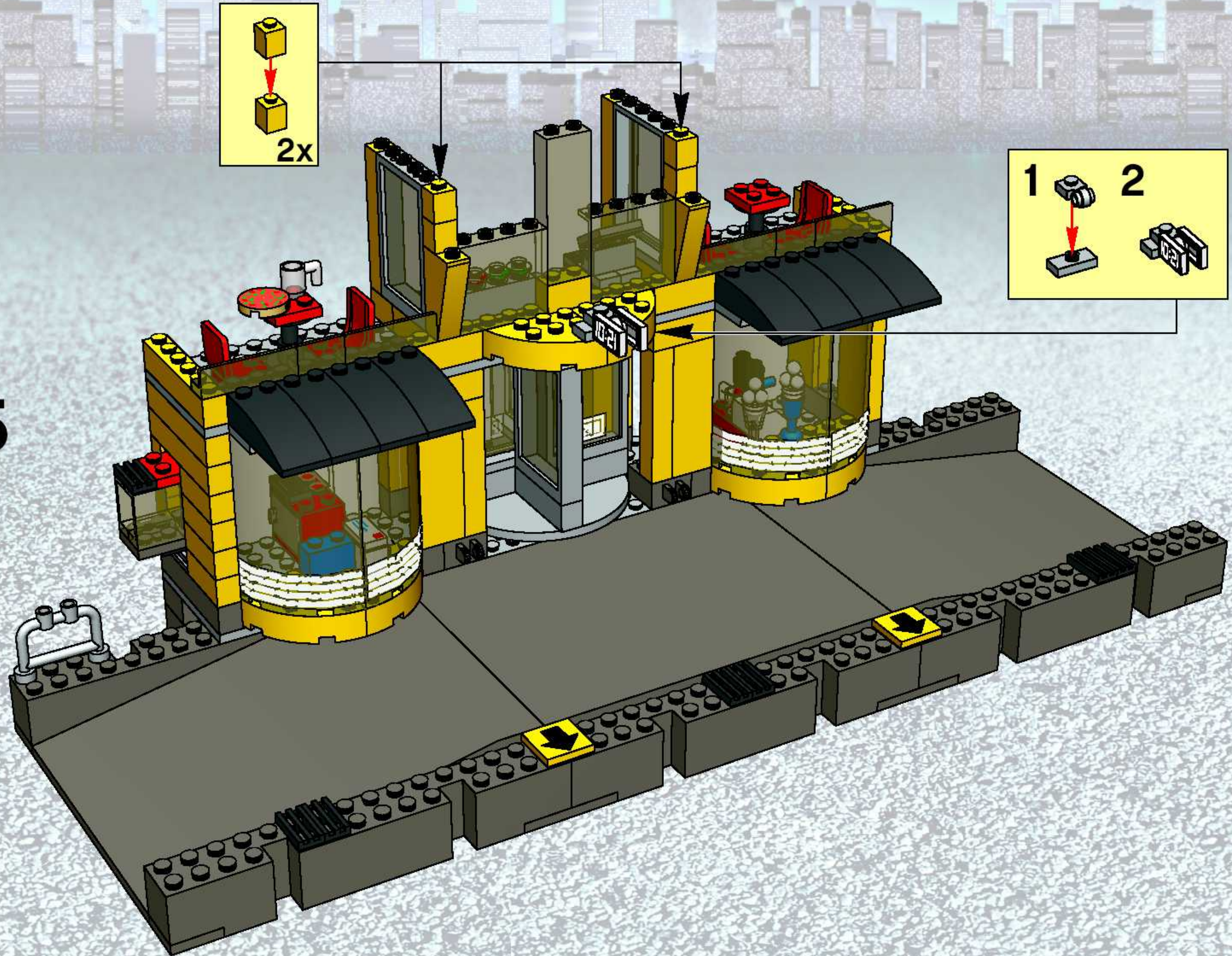

26

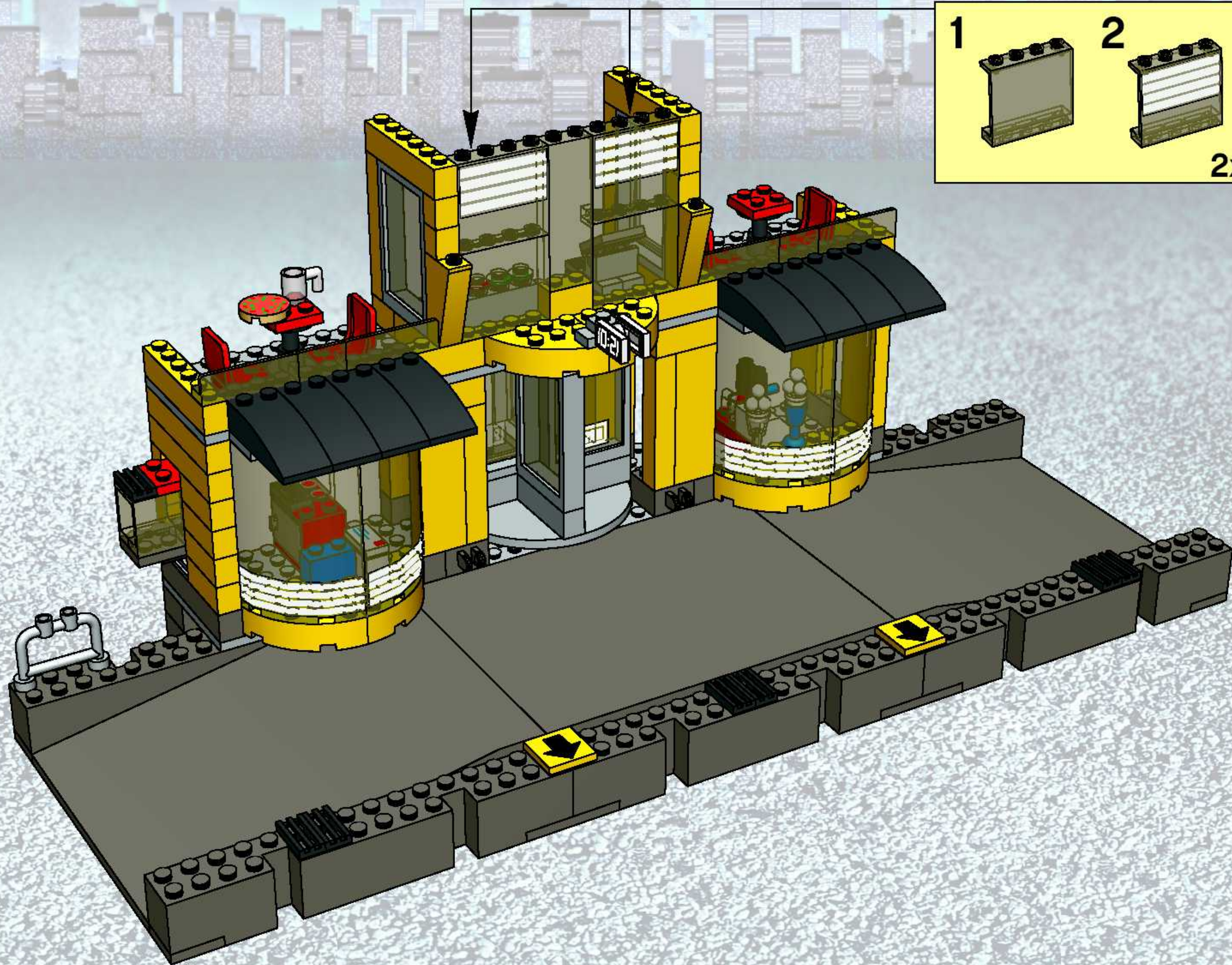

27

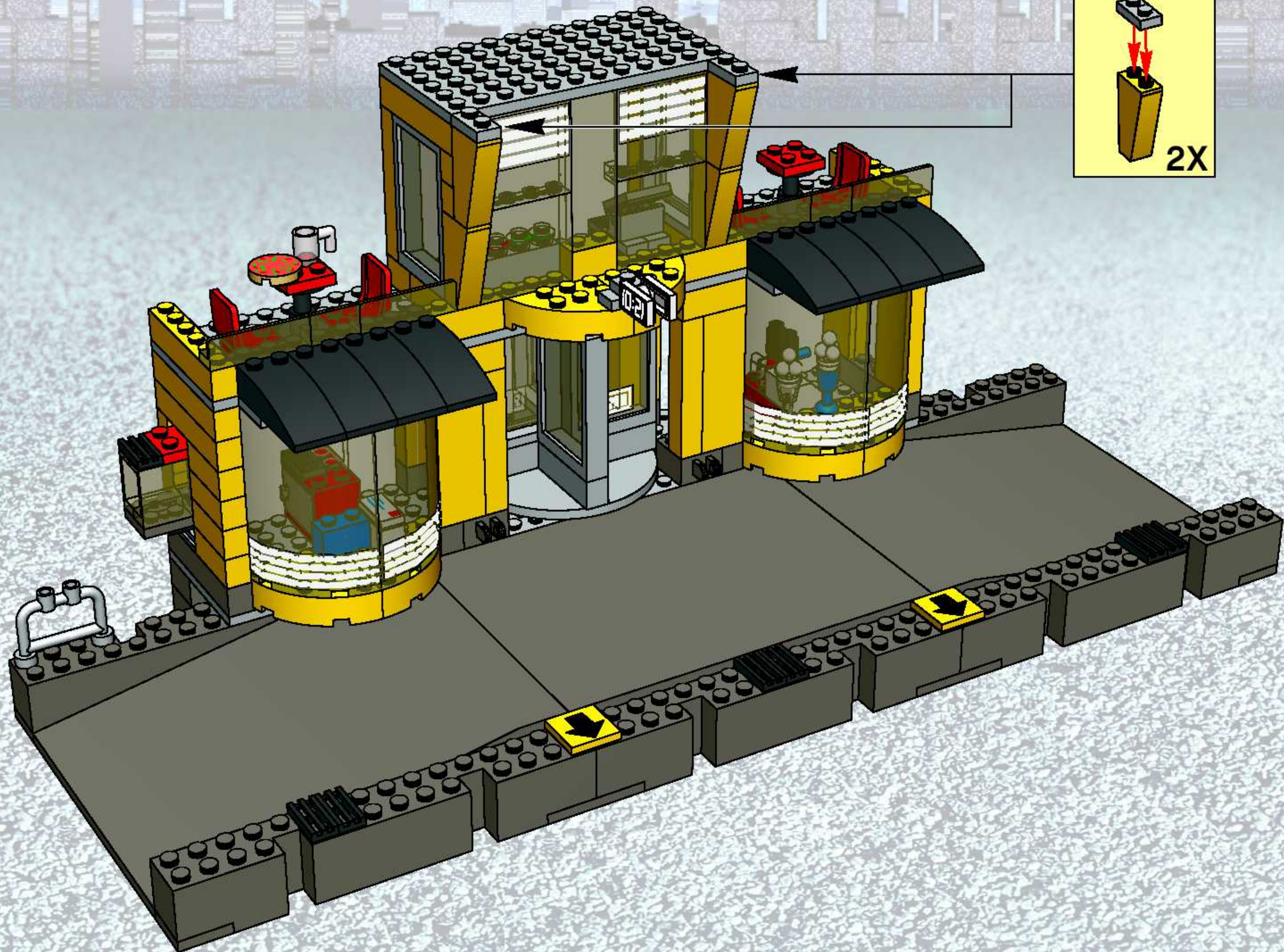

28

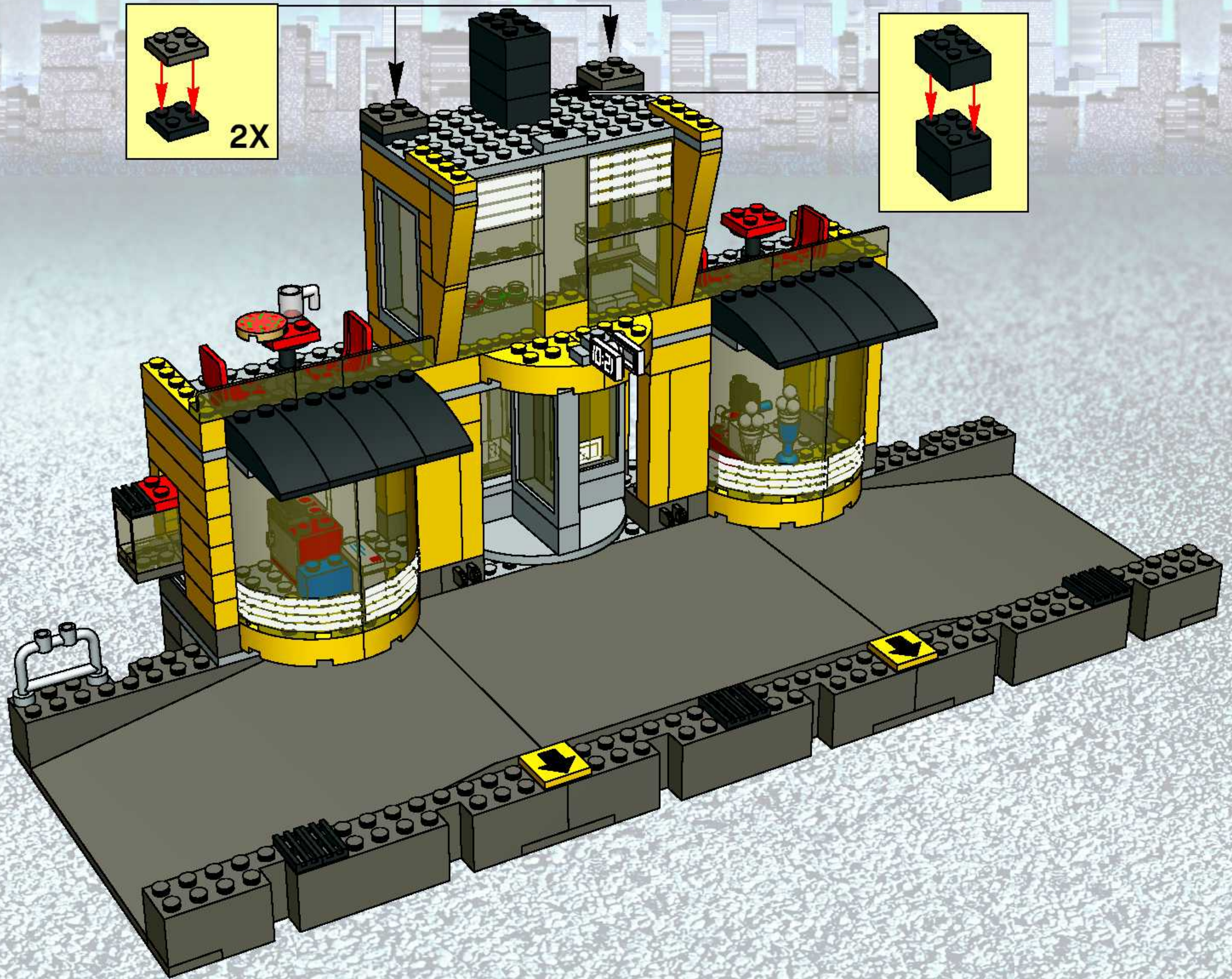

1

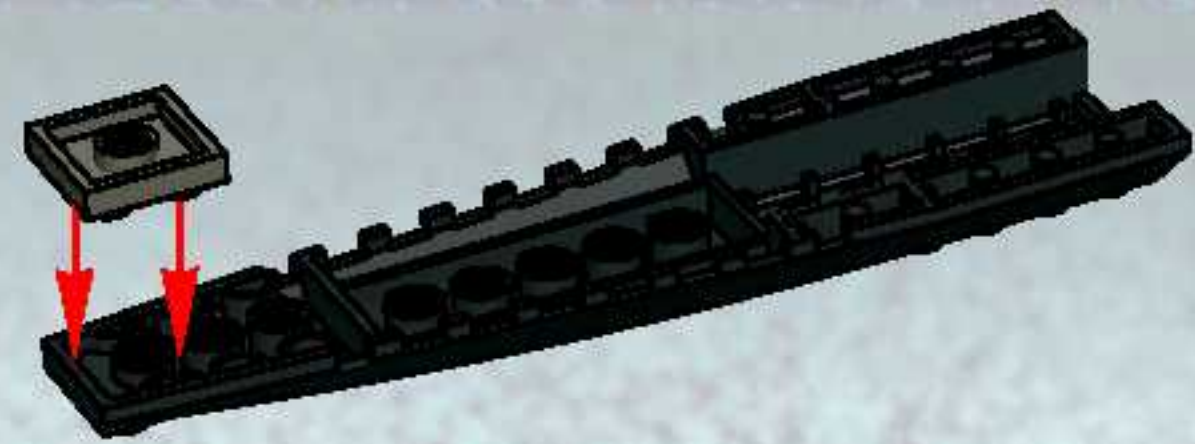

2

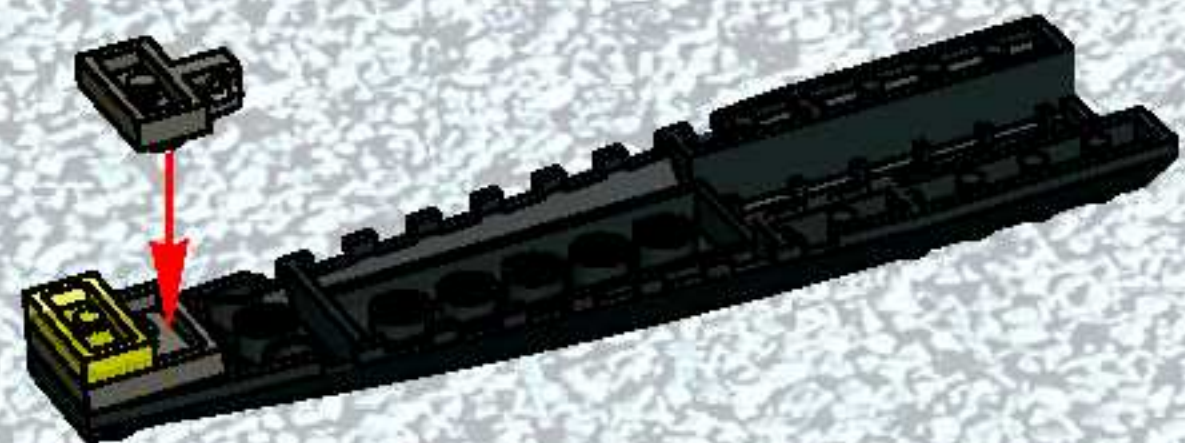

3

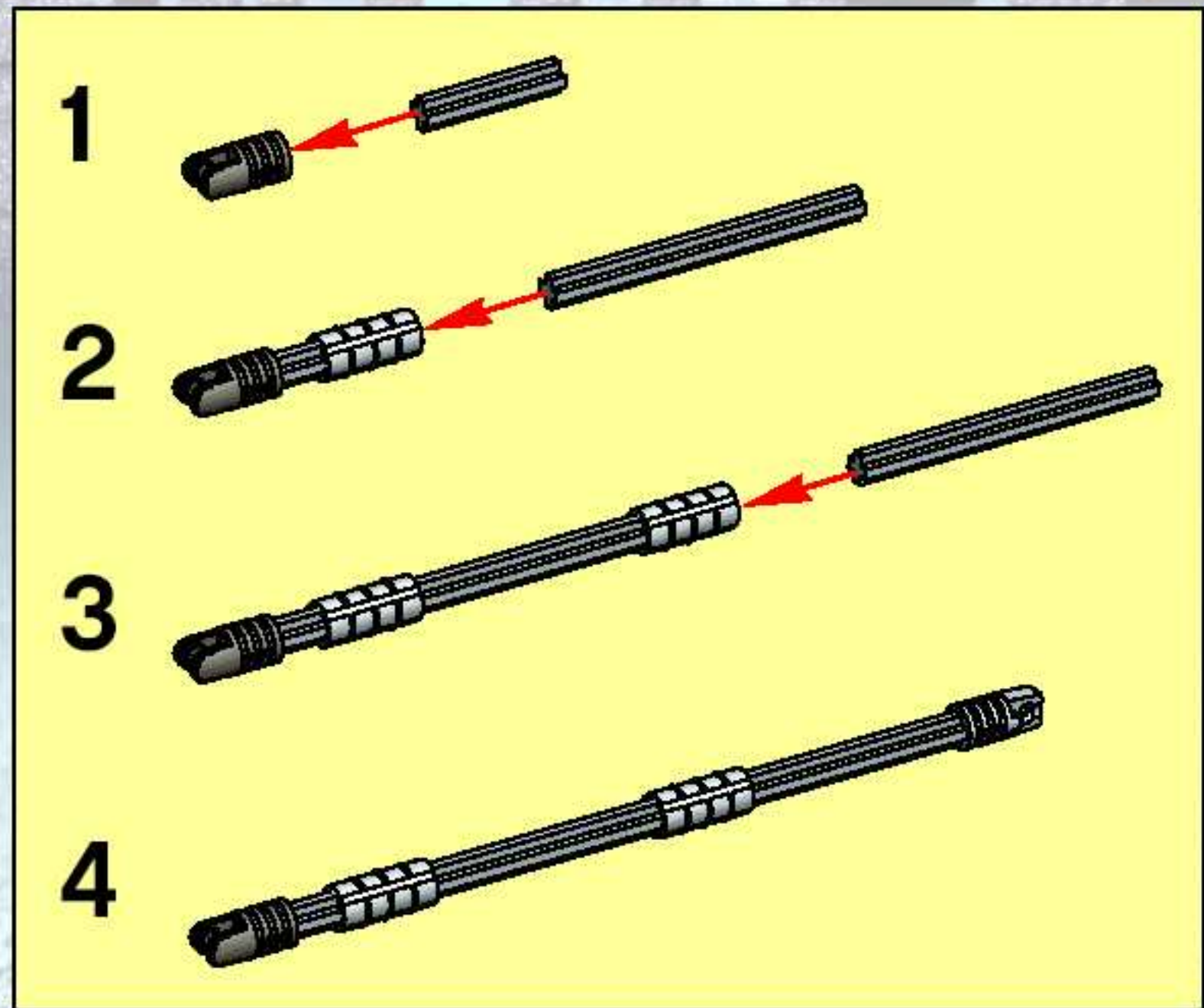
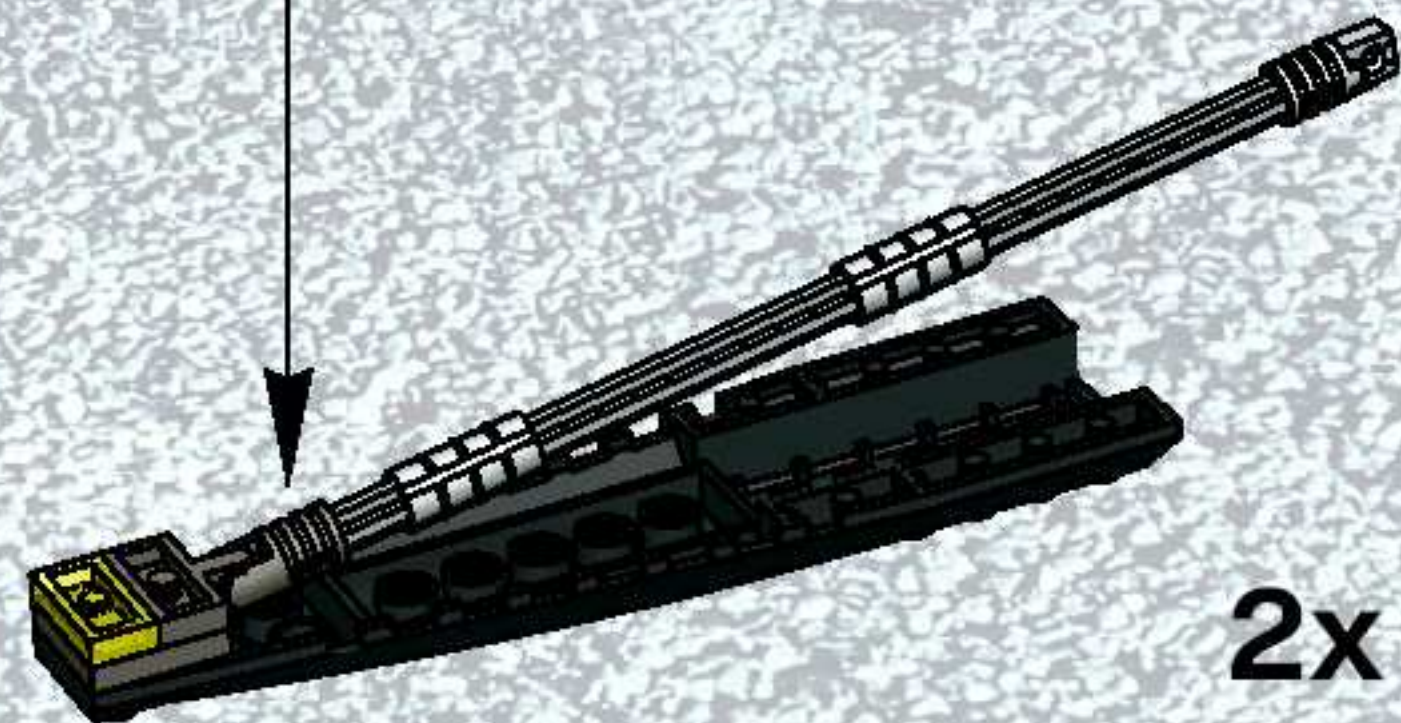

29

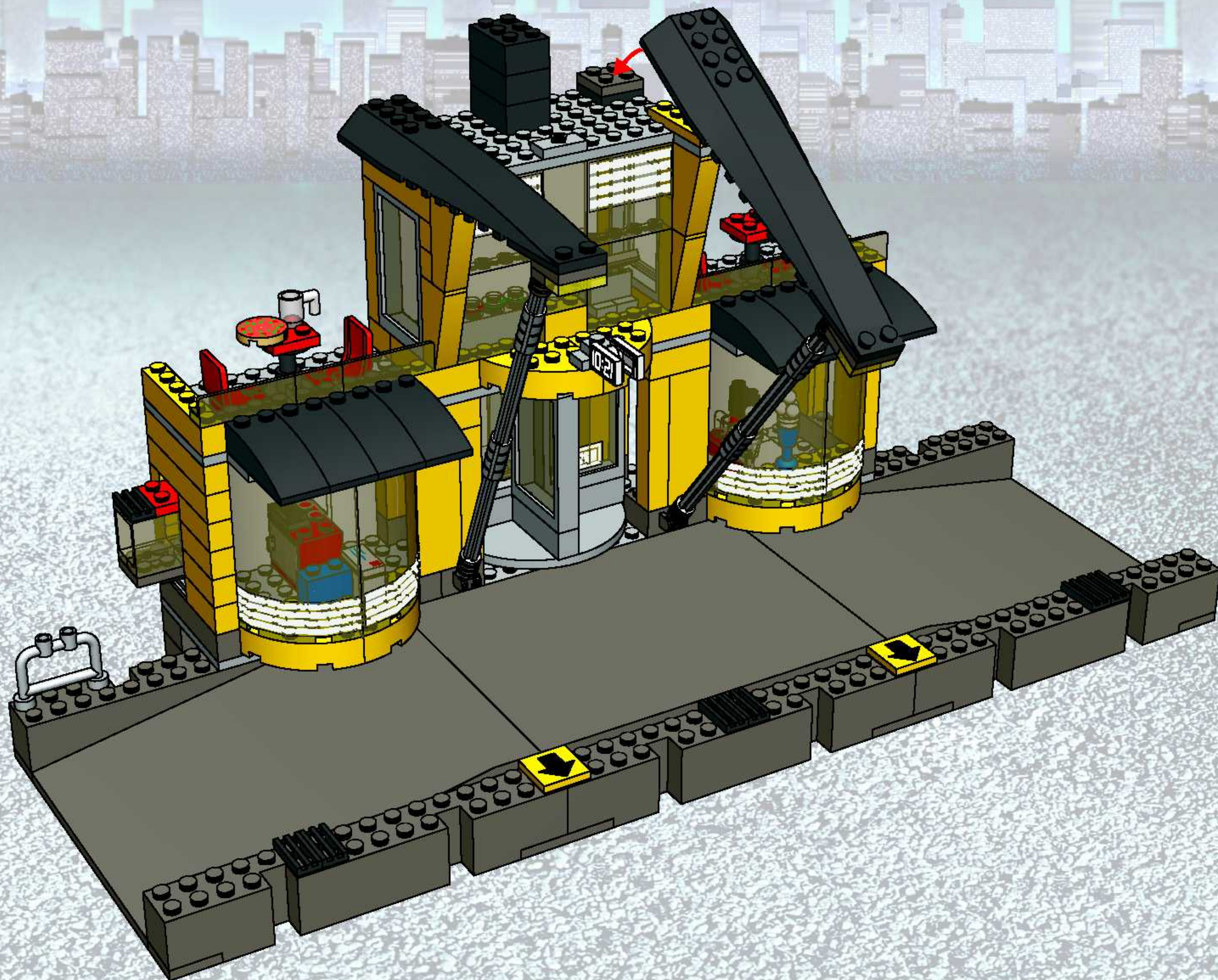

30

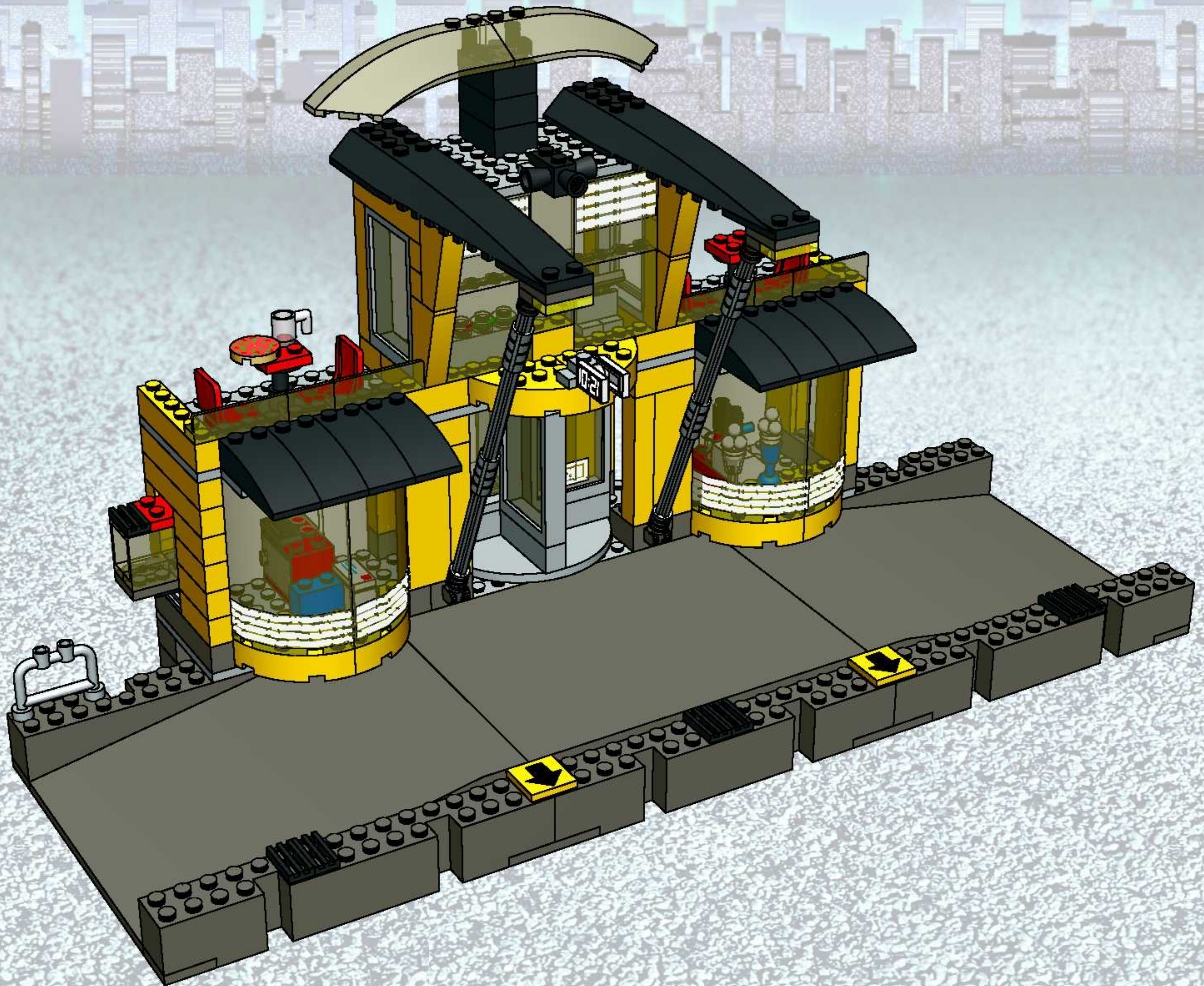

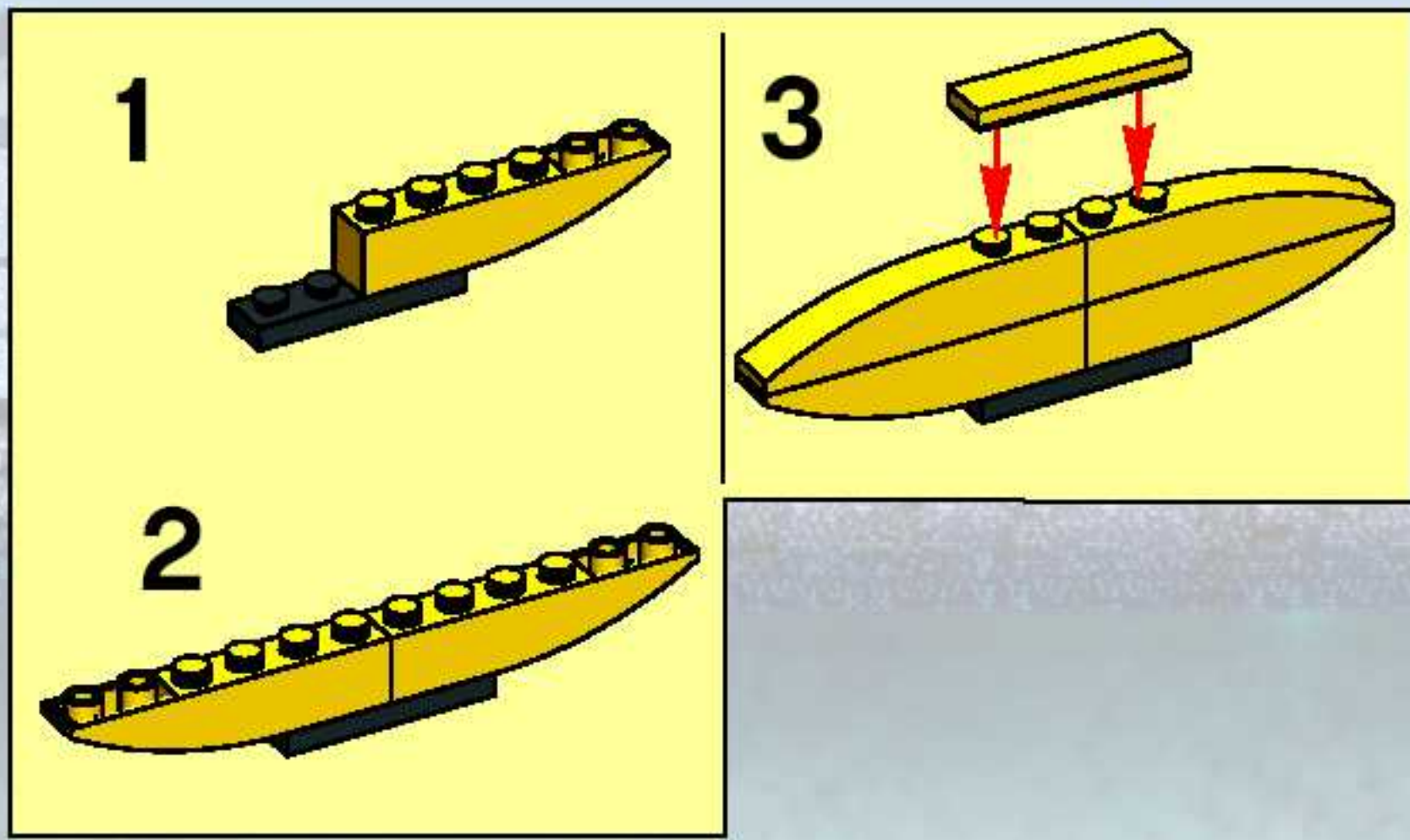

31

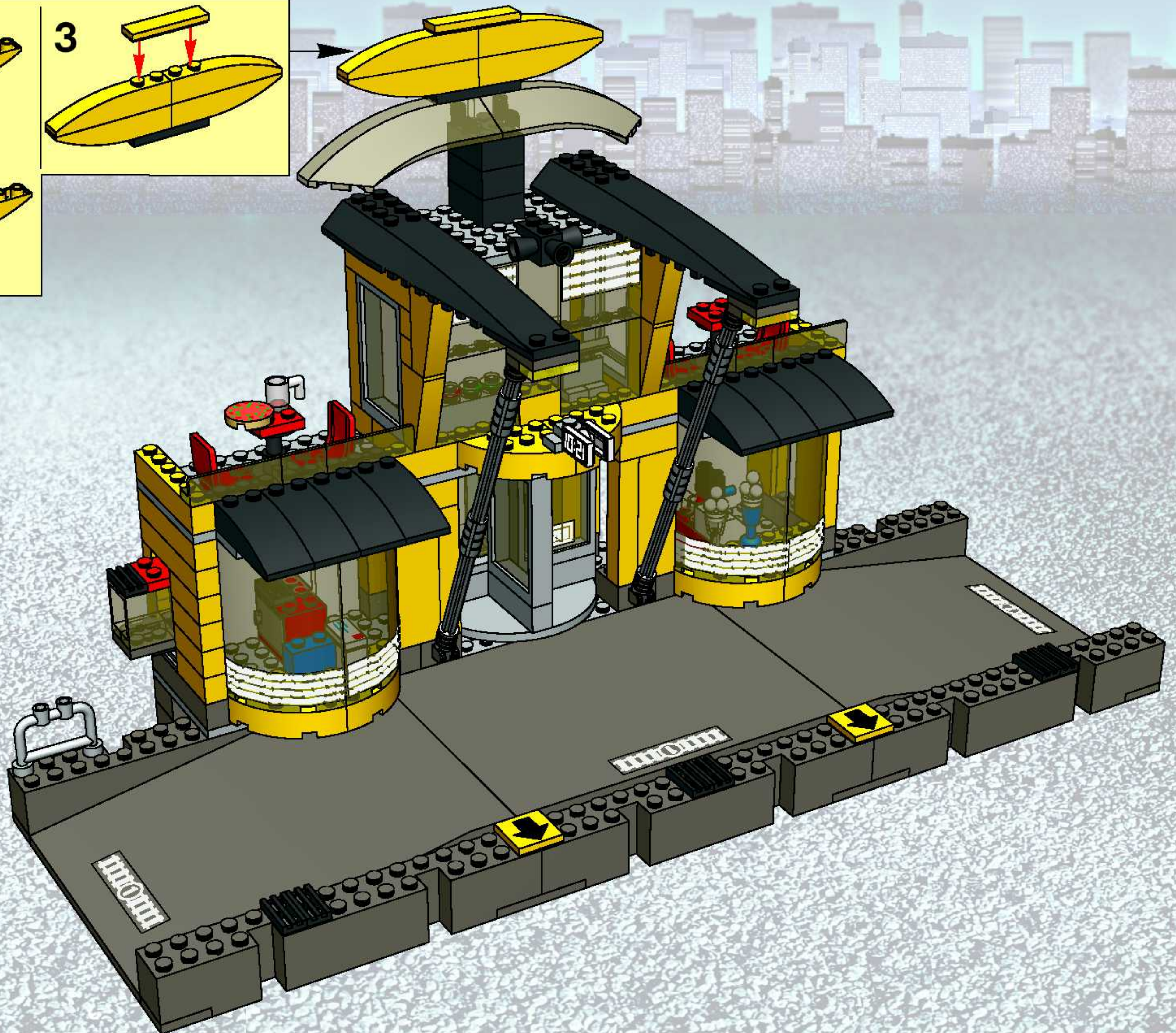

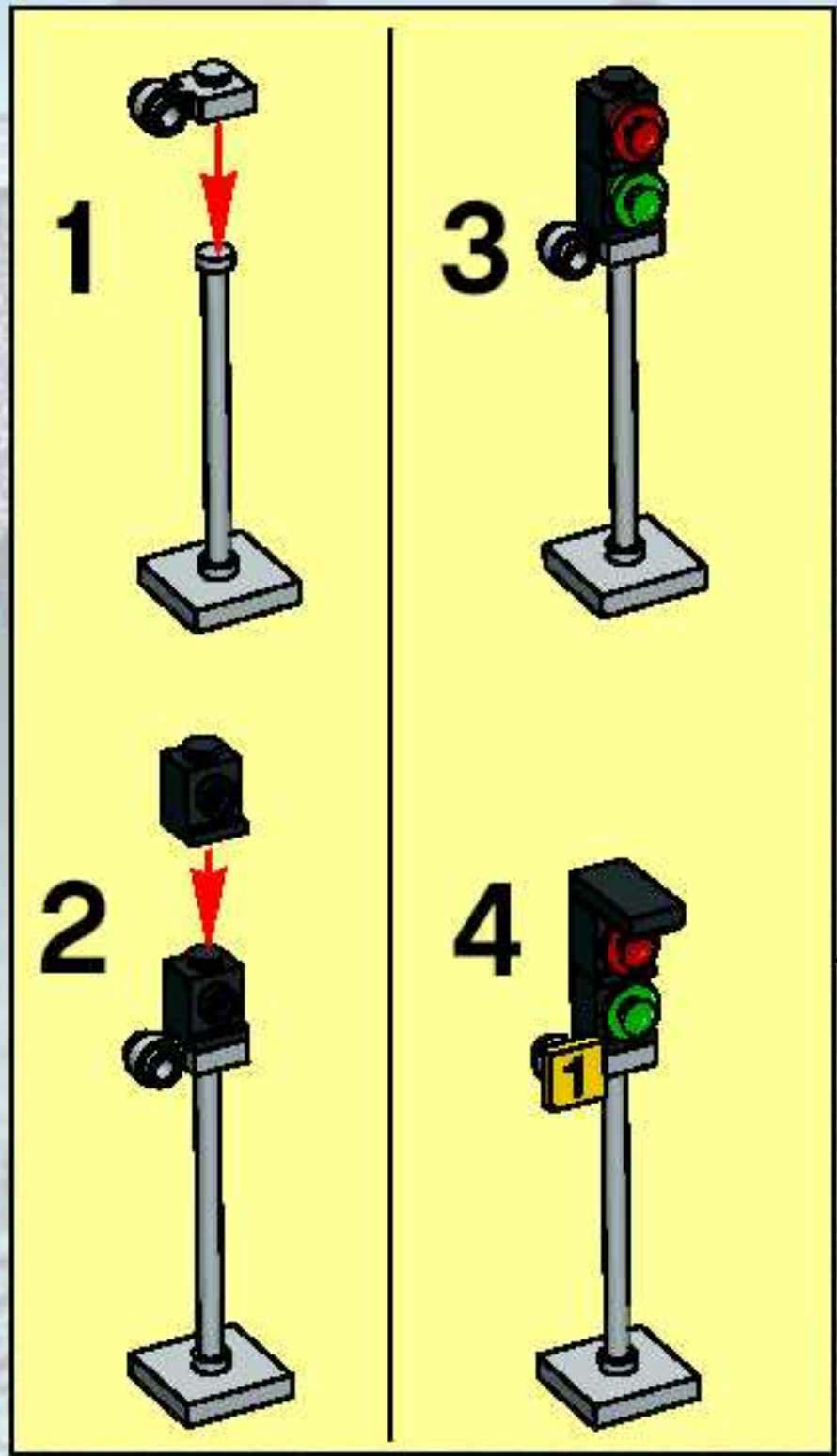

32

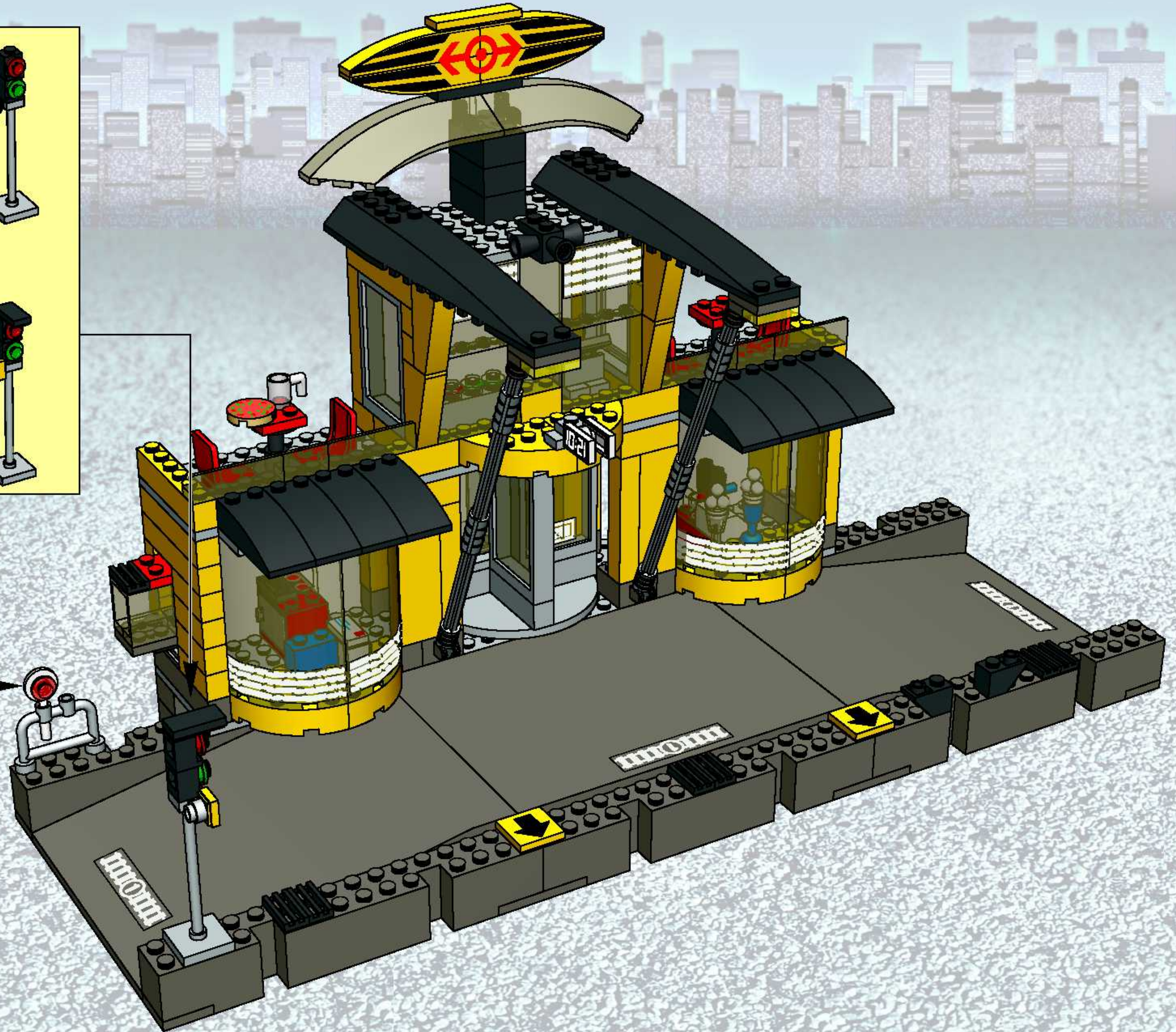
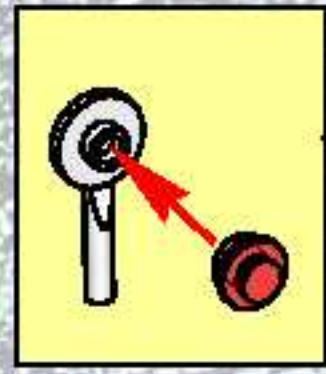

33

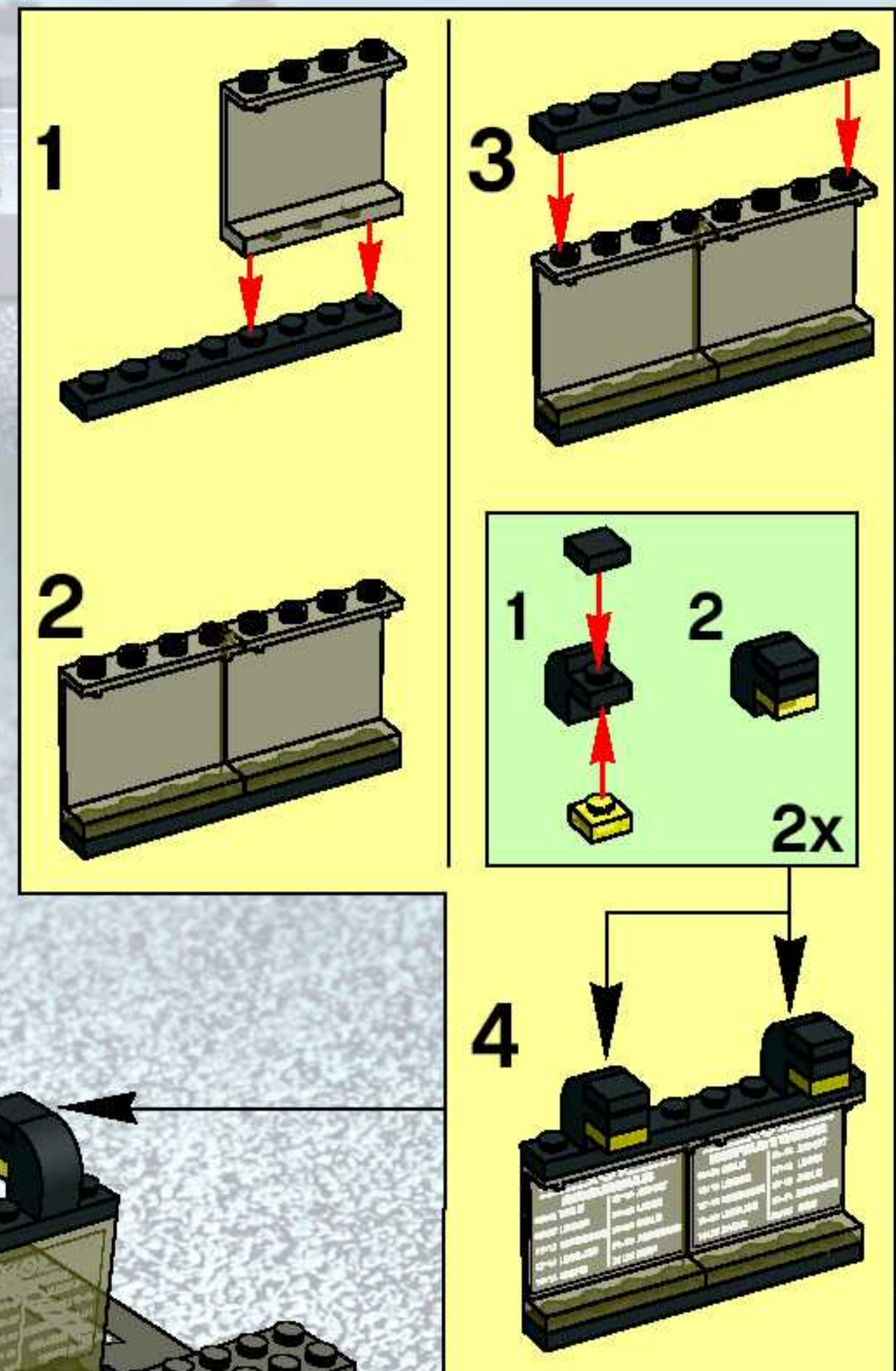
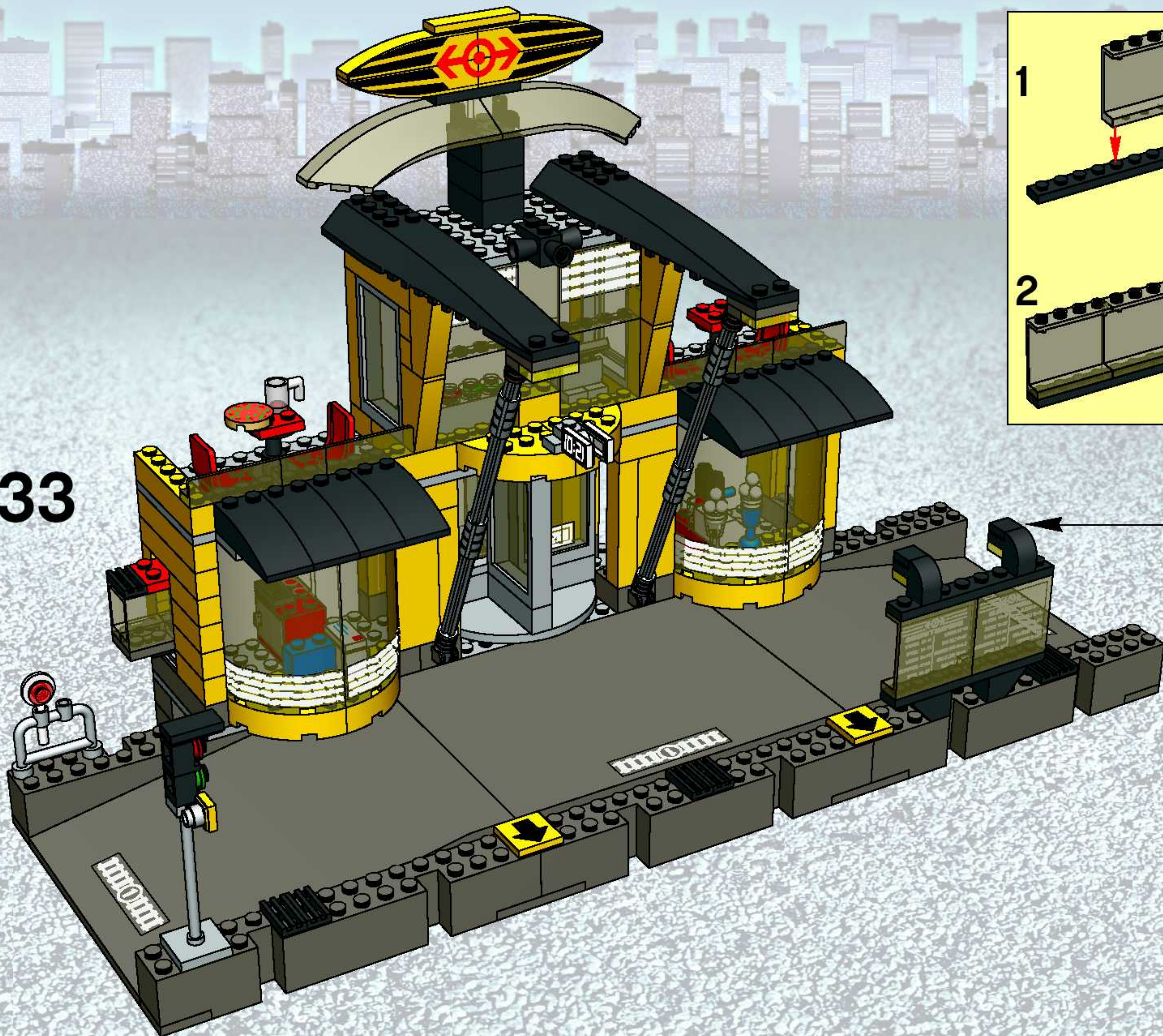

34

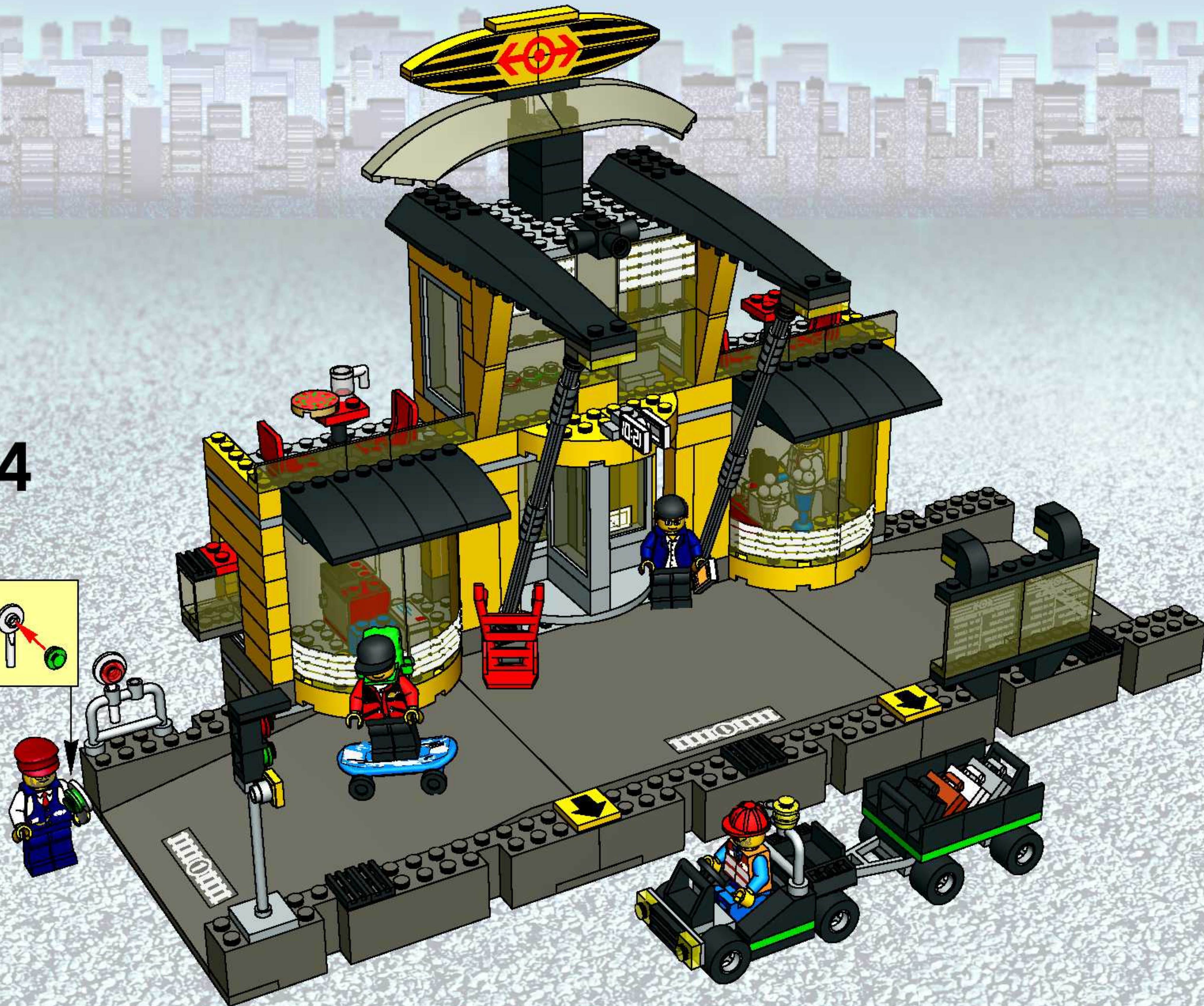





World City ↑



Win! Gagne! Gewinne! 当たります



Win LEGO® products

We would really like to know what you think about your new LEGO® product.

If you could help us by answering a few questions at www.acnielsen.aim.dk/lego then you are in with a chance of winning an exciting LEGO prize.

It will only take you about 3 minutes!



Estimado usuario LEGO®

Al contestar algunas preguntas en inglés, francés, alemán o japonés, en el sitio www.acnielsen.aim.dk/lego, podrás participar en el sorteo de algunos valiosos premios LEGO®.



Gagne des produits LEGO®

Nous aimerions beaucoup savoir ce que tu penses de ton nouveau produit LEGO®.

Si tu veux bien nous aider en répondant à quelques questions sur www.acnielsen.aim.dk/lego, tu recevras peut-être bientôt l'un des nombreux super-prix offerts par LEGO aux participants.

Et cela ne te prendra que 3 minutes environ !



Kedves Ifjú LEGO® Vásárló

Ha ellátogatsz a www.acnielsen.aim.dk/lego honlapra és ott angol, francia, német vagy japán nyelven megválaszolsz néhány kérdést, akkor részt veszel egy versenyben, amelyben értékes LEGO® díjakat nyerhetsz.



Gewinne LEGO® Produkte

Wir sind sehr an deiner Meinung über dein neues LEGO® Produkt interessiert.

Wenn du uns den Gefallen tust und unter www.acnielsen.aim.dk/lego Fragen beantwortest, kannst du einen tollen LEGO Preis gewinnen.

Das Ganze dauert nur etwa 3 Minuten!



Caro Consumidor da LEGO®

Ao responder a algumas perguntas em Inglês, Francês, Alemão ou Japonês no endereço www.acnielsen.aim.dk/lego irá participar num concurso para ganhar valiosos prémios da LEGO®.



抽選でレゴ製品が当たります

私たちは、皆さんがレゴ製品についてどんな感想をお持ちか、是非知りたいと思っています。

www.acnielsen.aim.dk/legoにアクセスいただき、質問にご回答いただきますと、抽選で楽しいレゴ製品が当たります。

アンケートのご回答には、ほんの3分ほどしかかかりません!

51550

4511



4512



4513



4514

