



CITY

60047





4



5



6

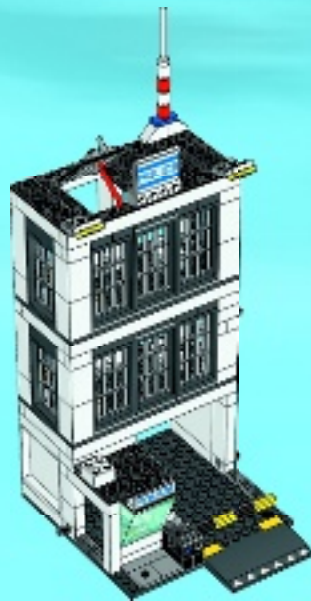

7



8



9

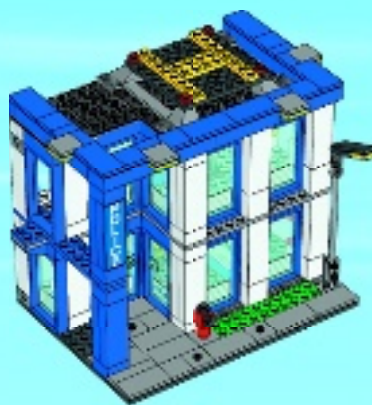

10



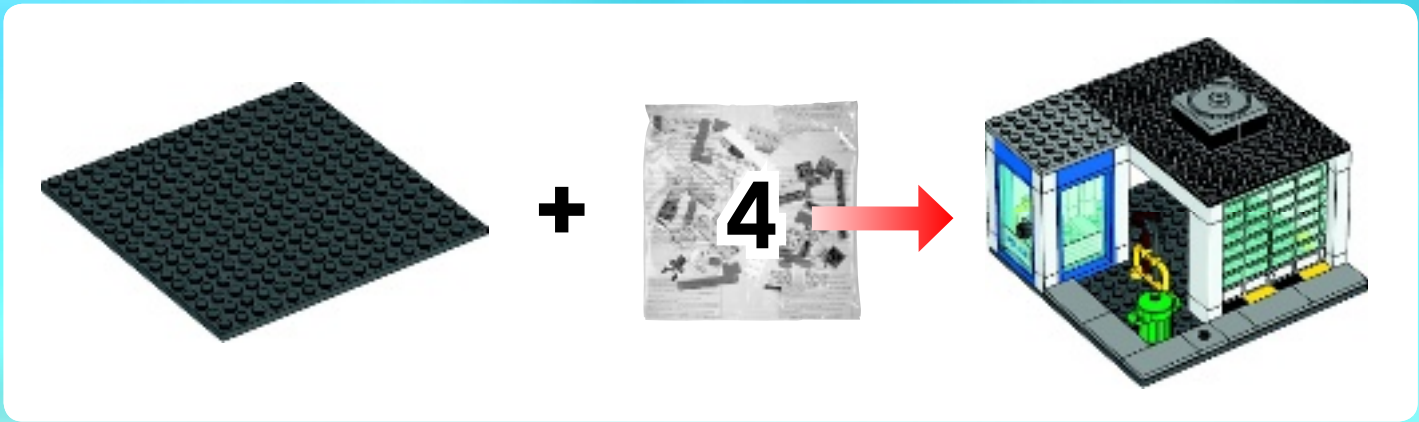

1x

1

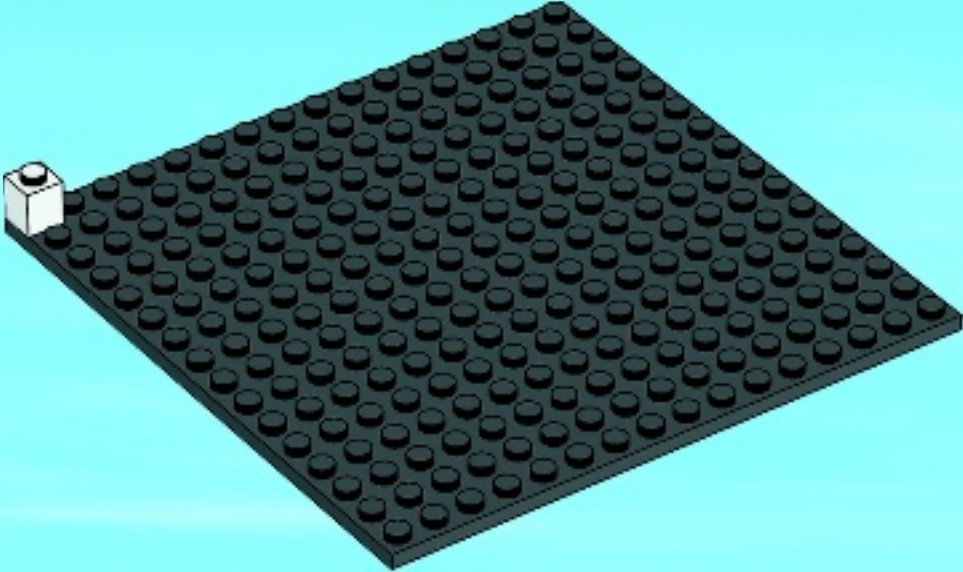



2

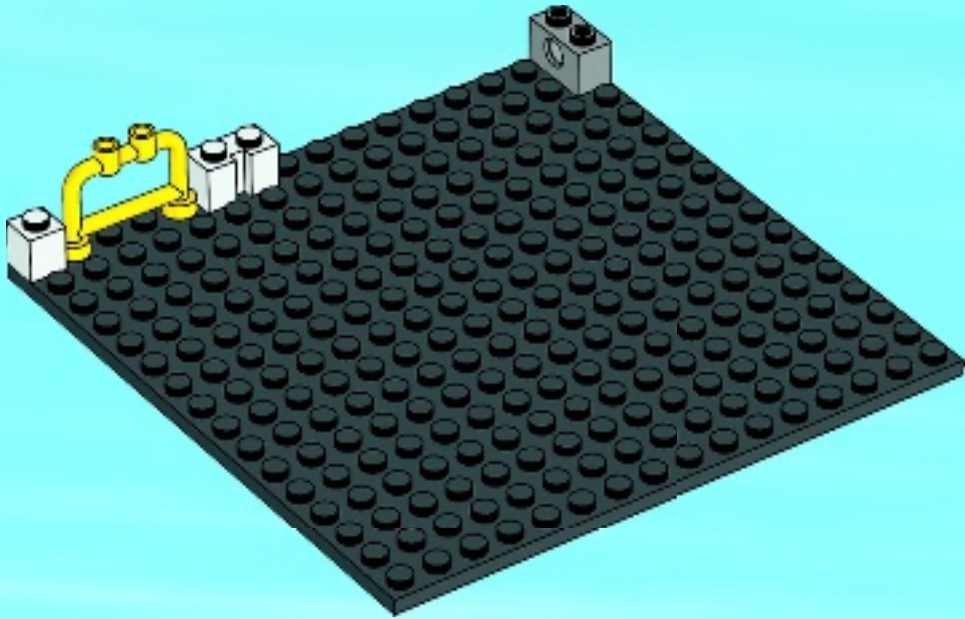



1x



1x

3

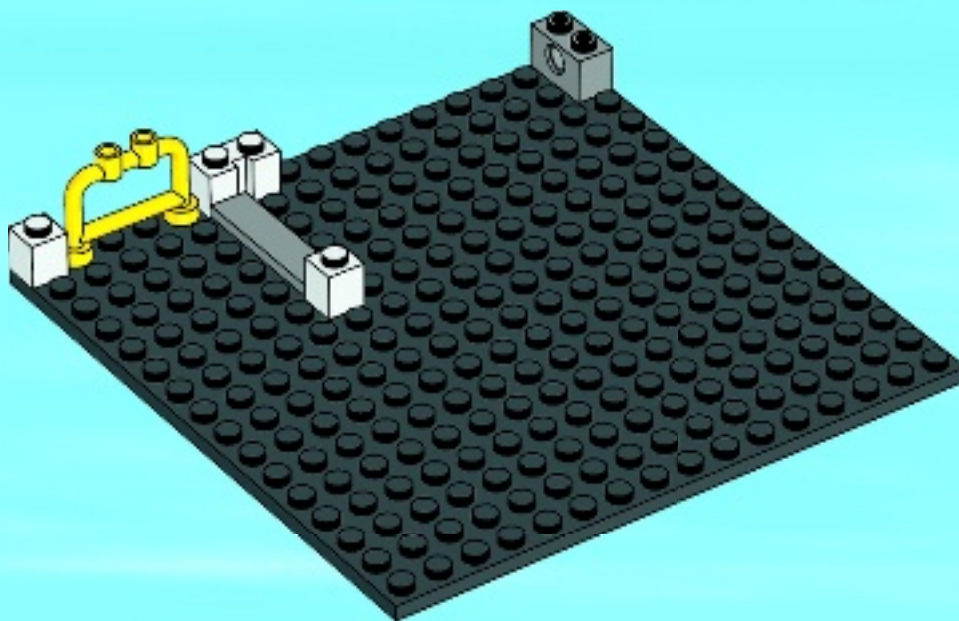



1x

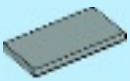

2x

4

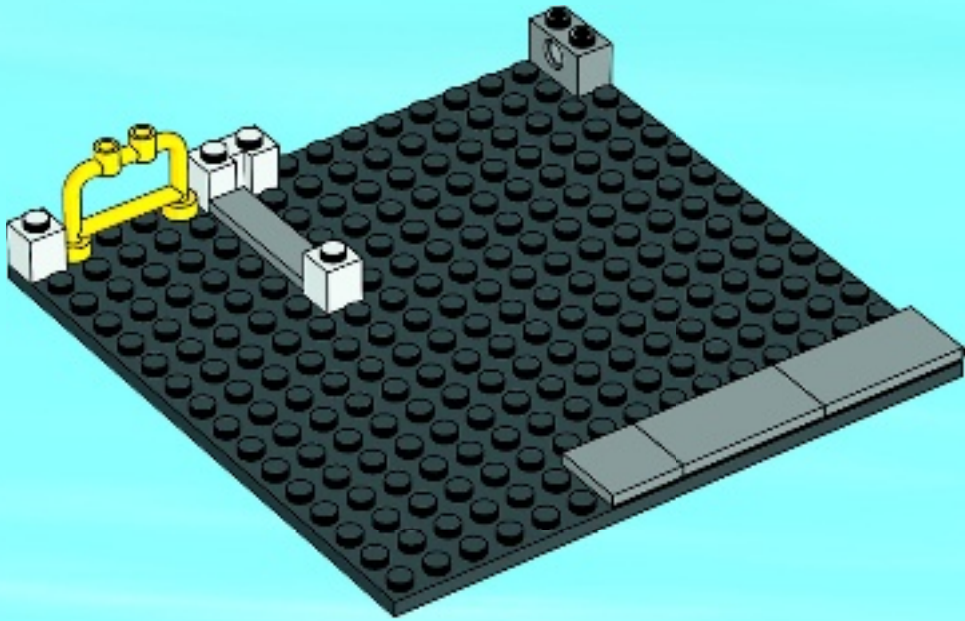



2x

5

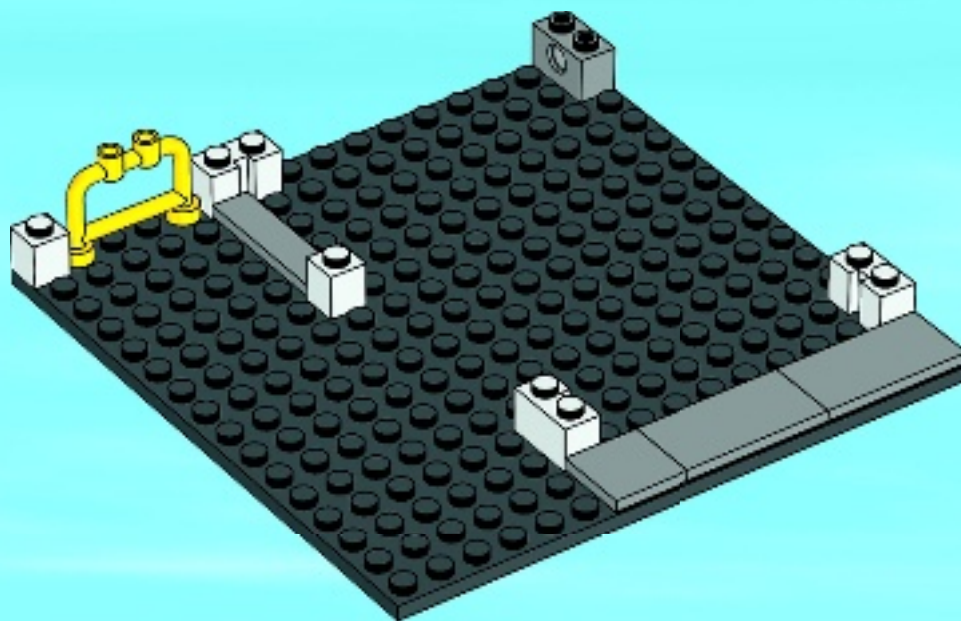



3x



2x

6

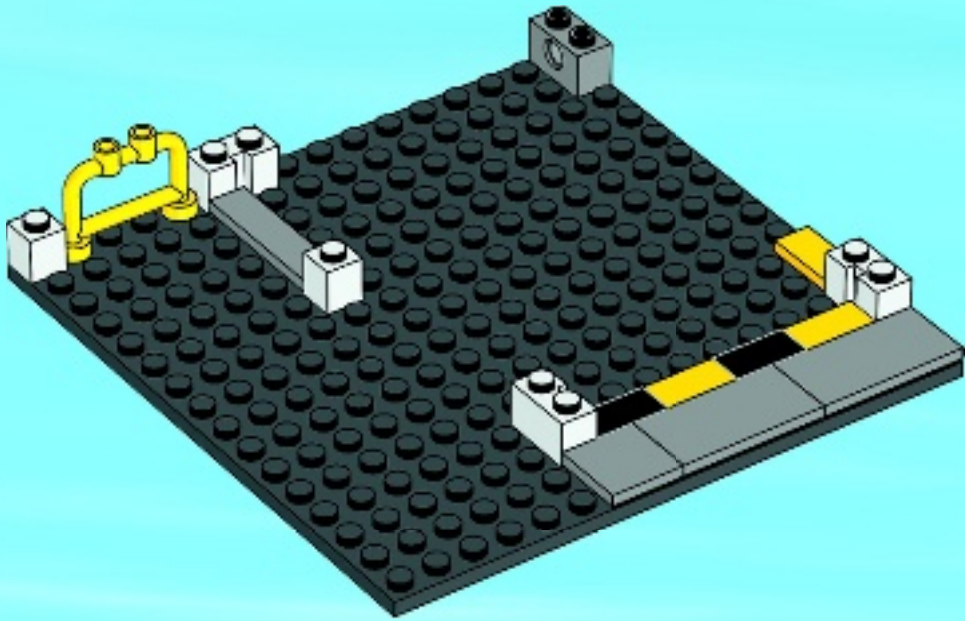



1x



1x

7

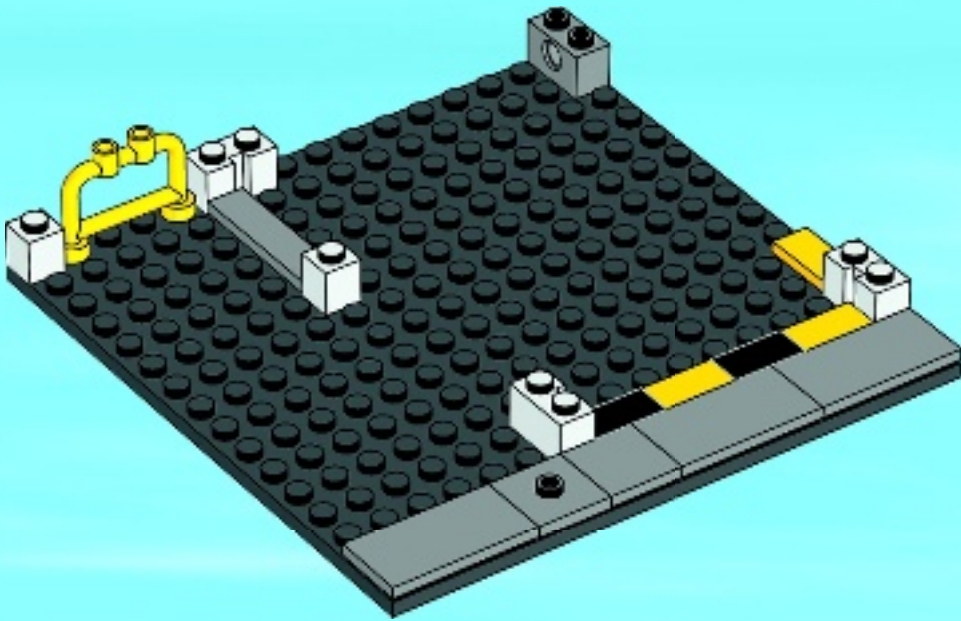



1x



2x

8

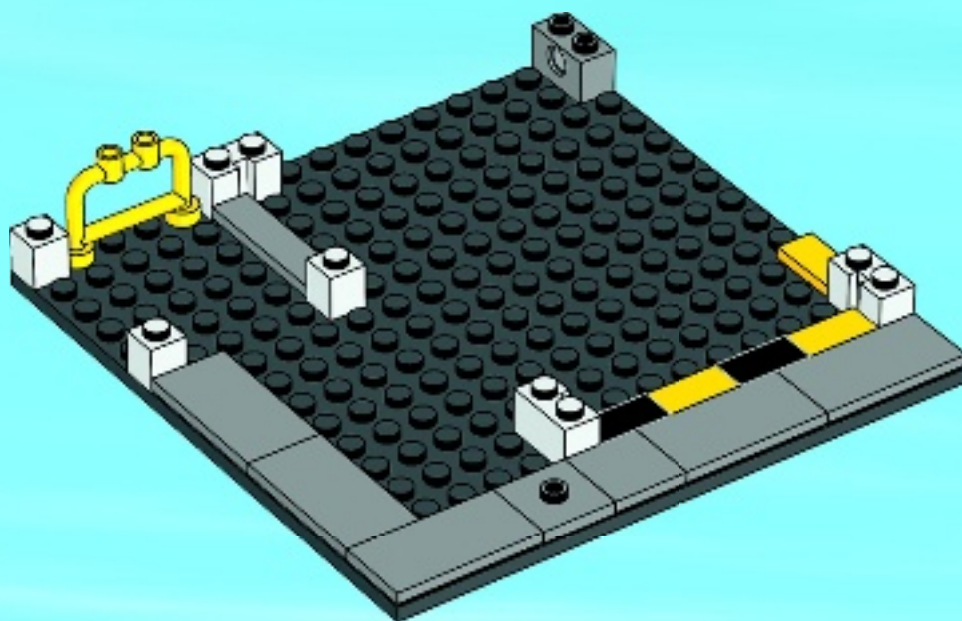



9

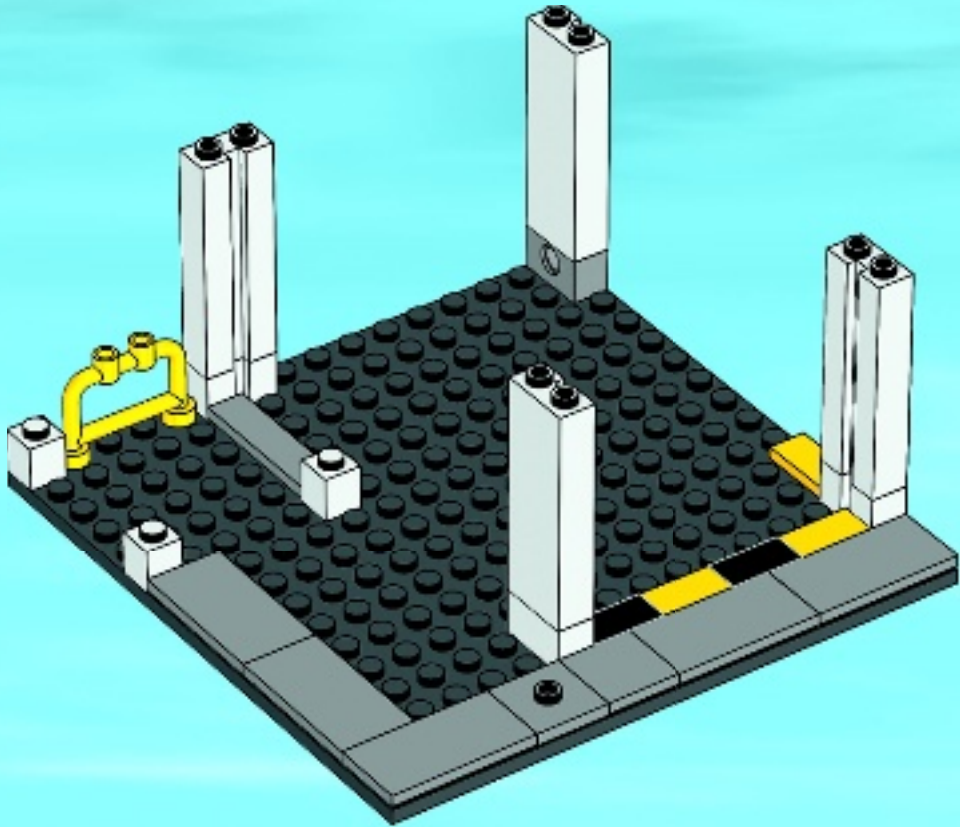

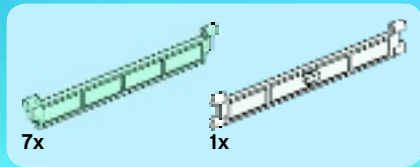

10

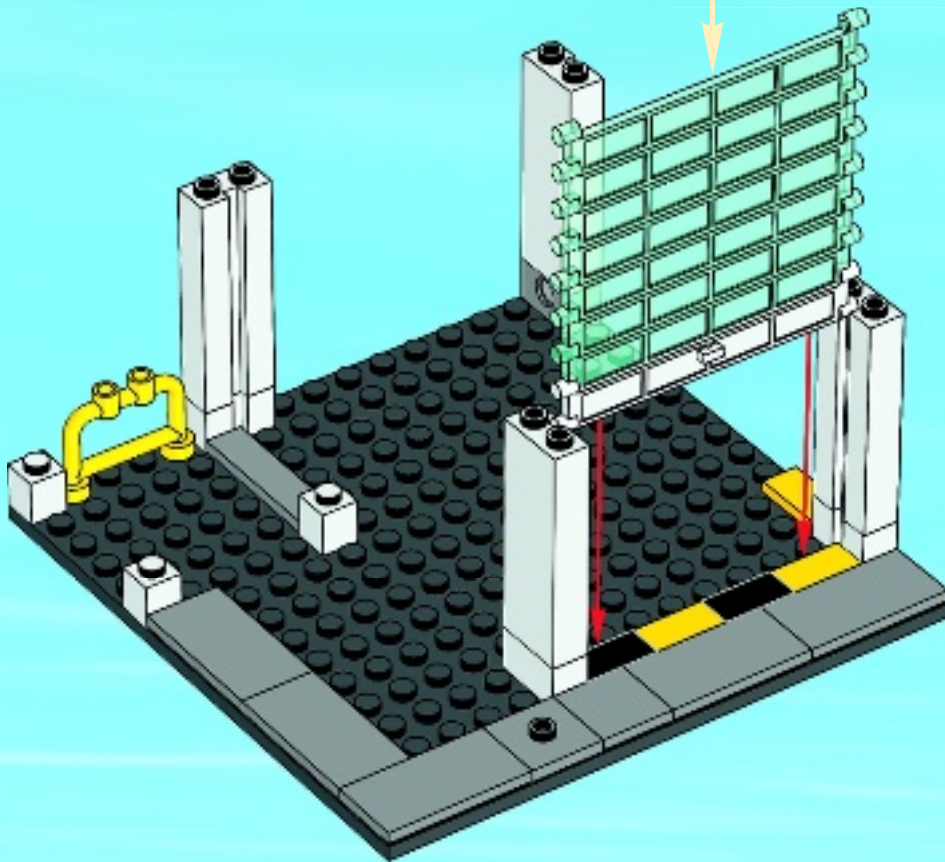
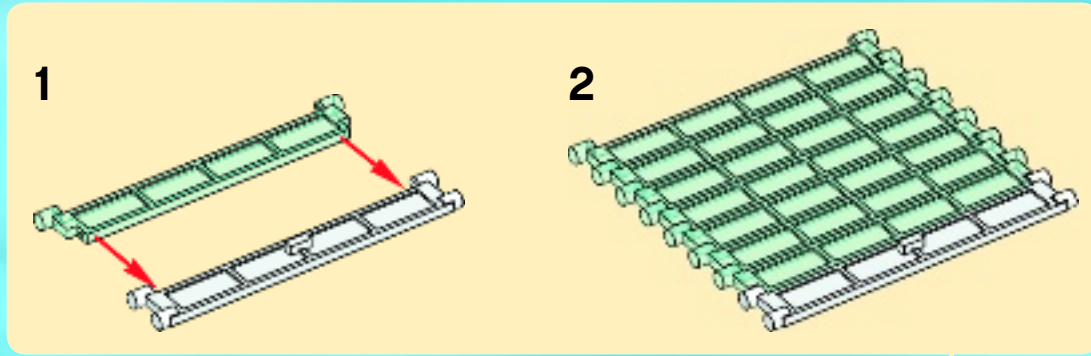

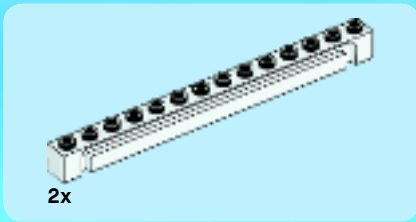

11

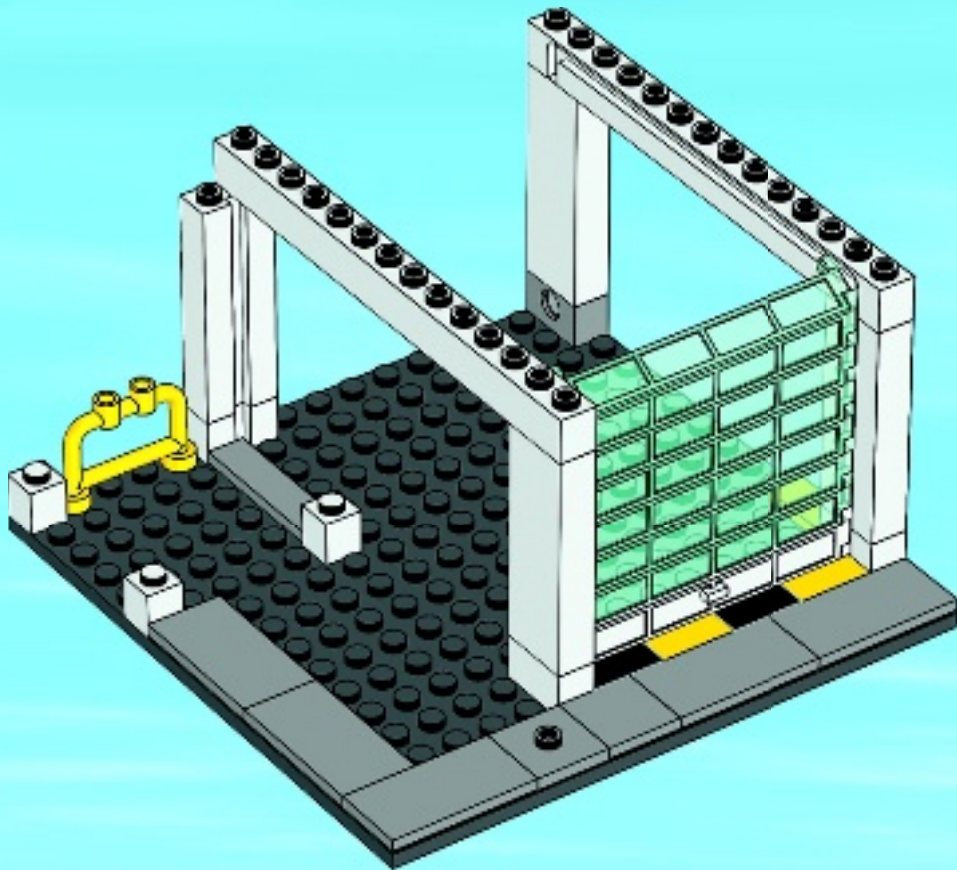

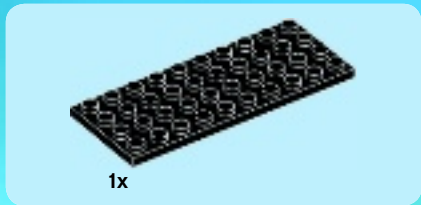

12

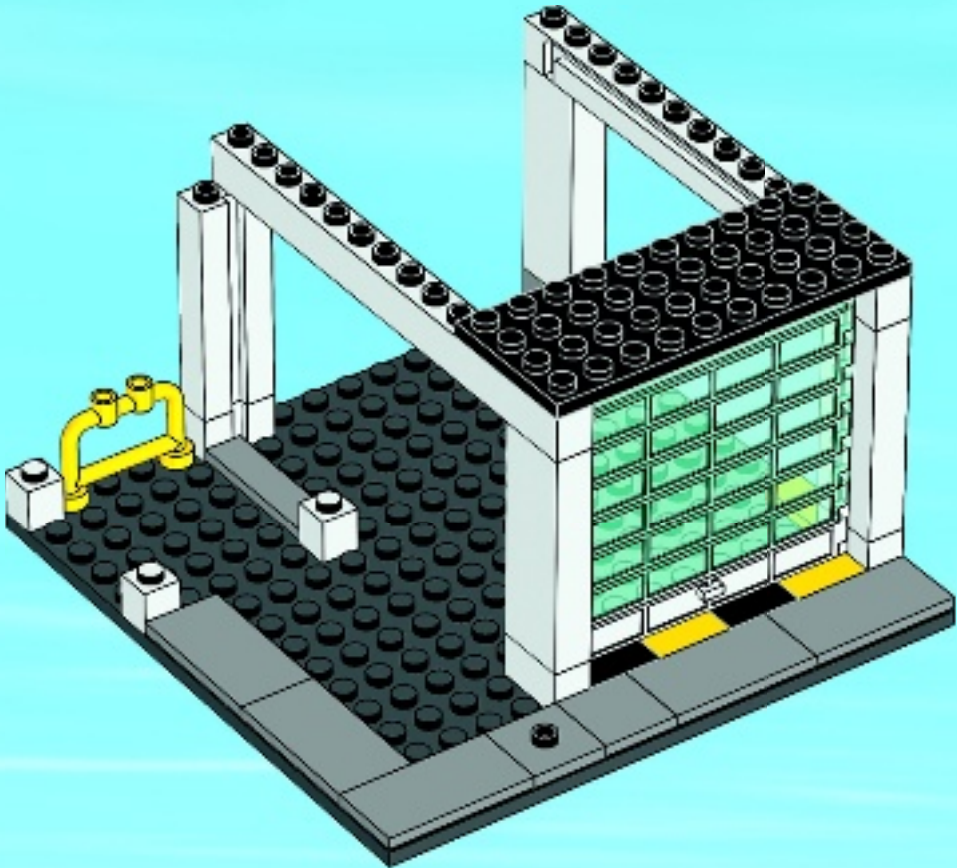

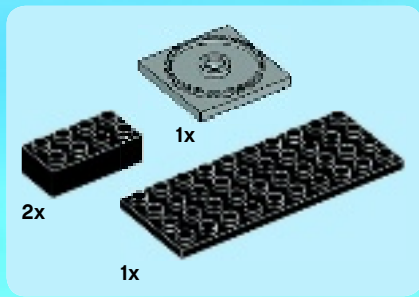

13

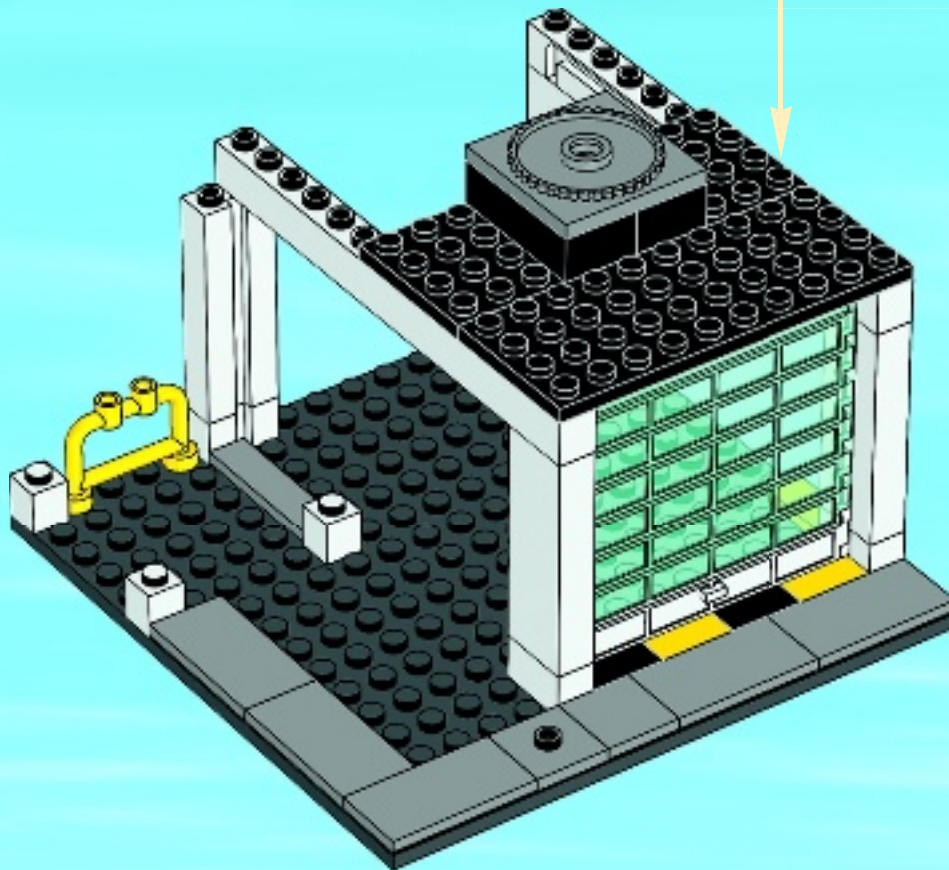
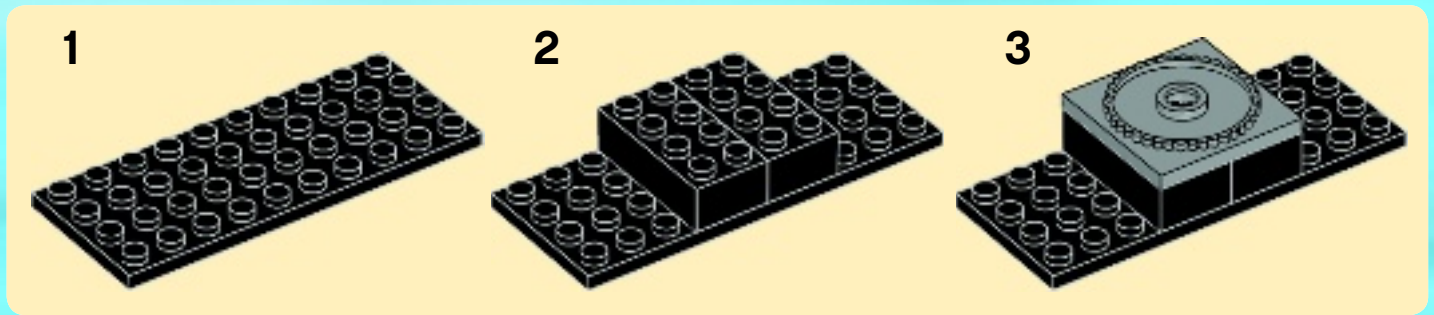

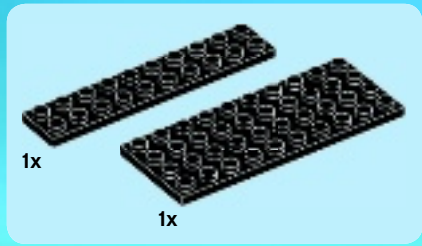

14

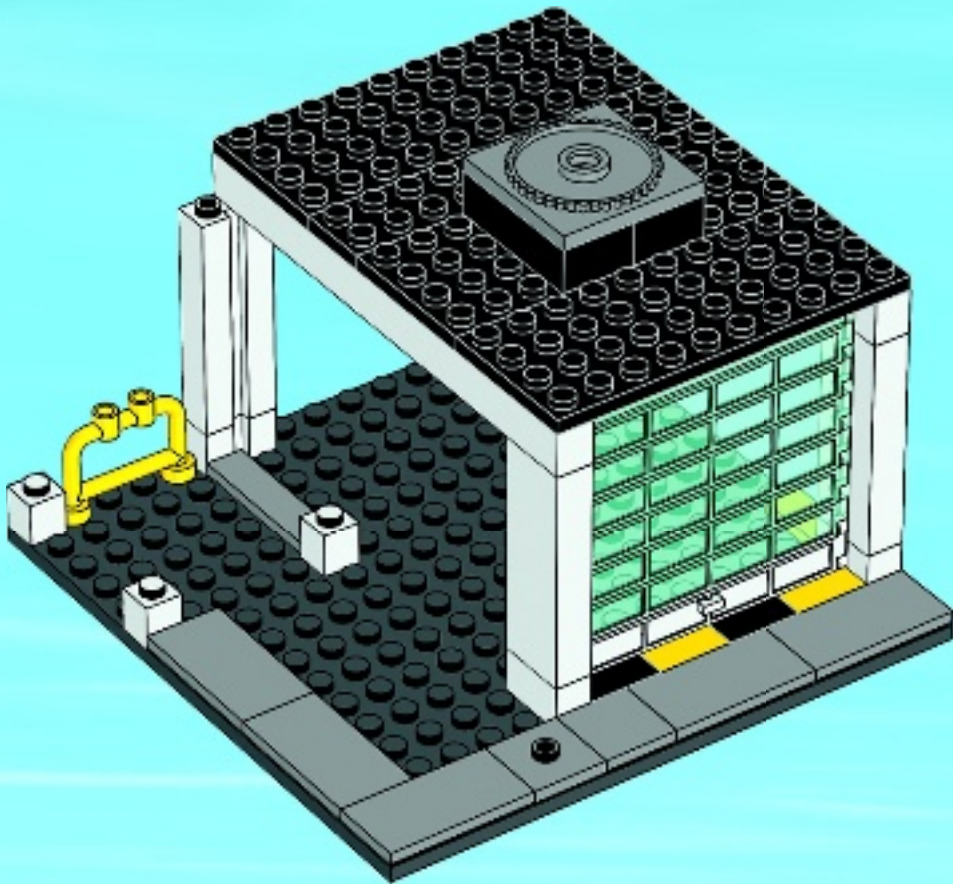



3x

15

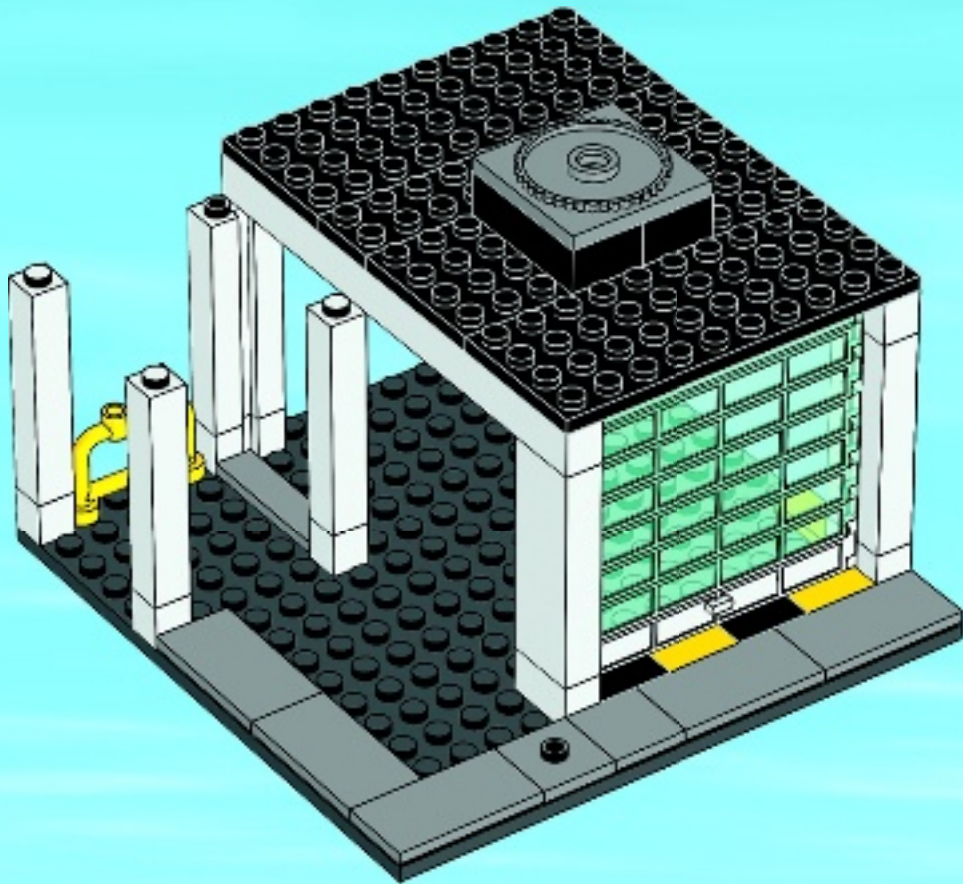



1x

16

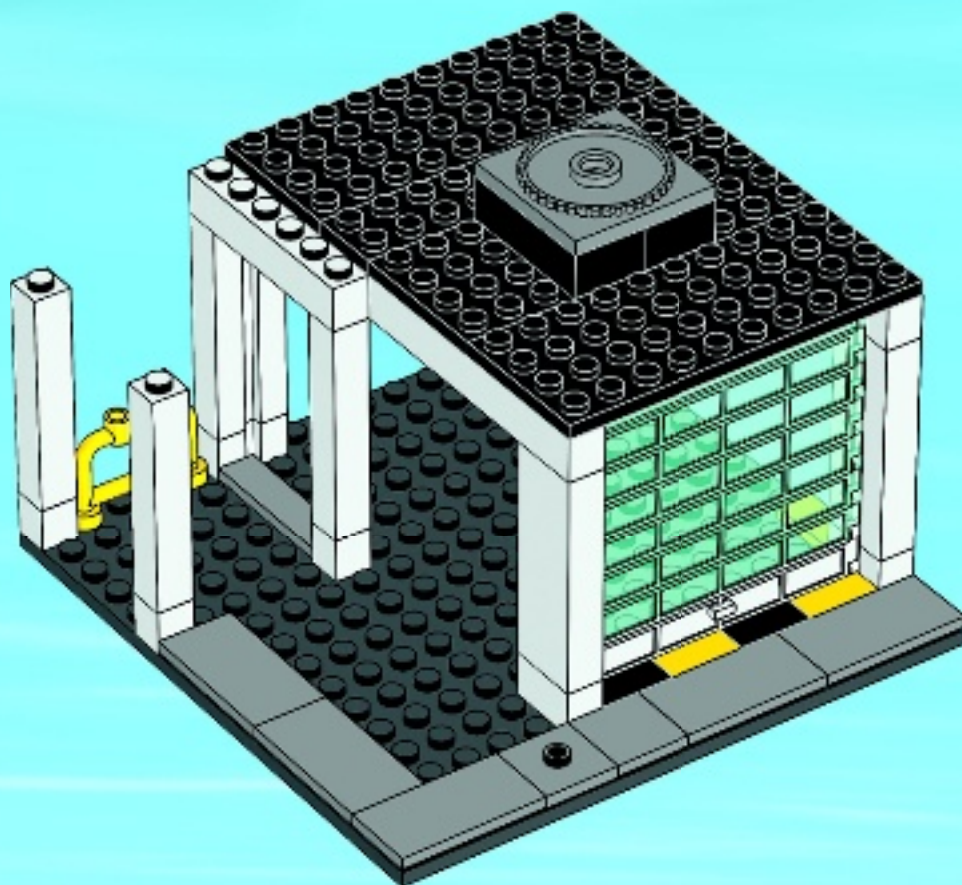

17

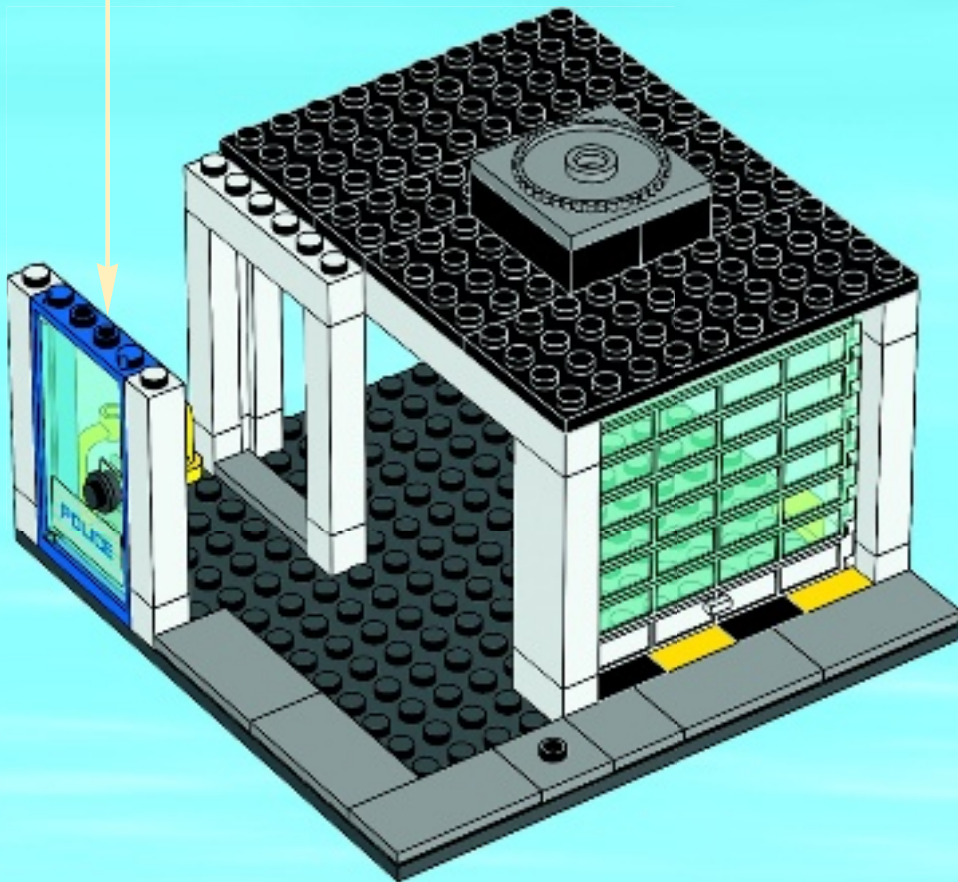
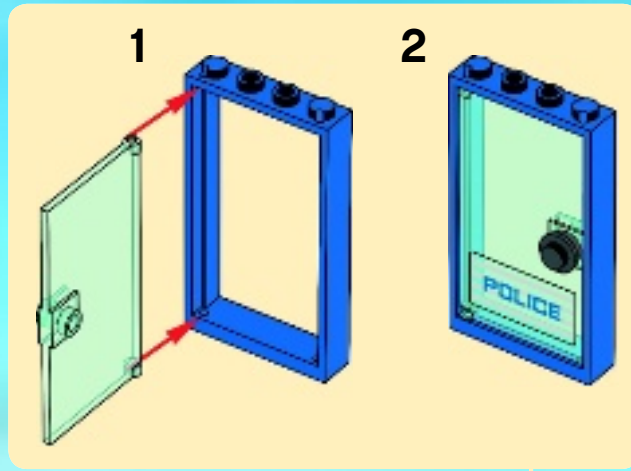
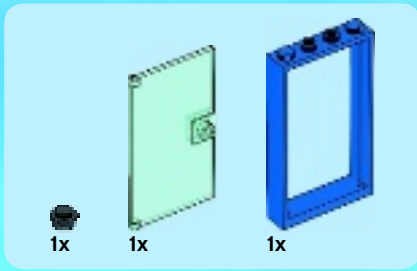

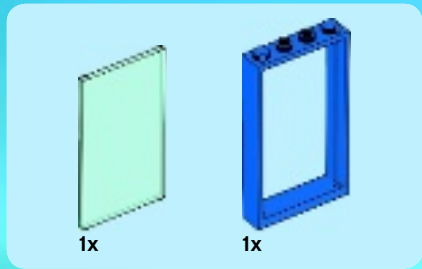

18

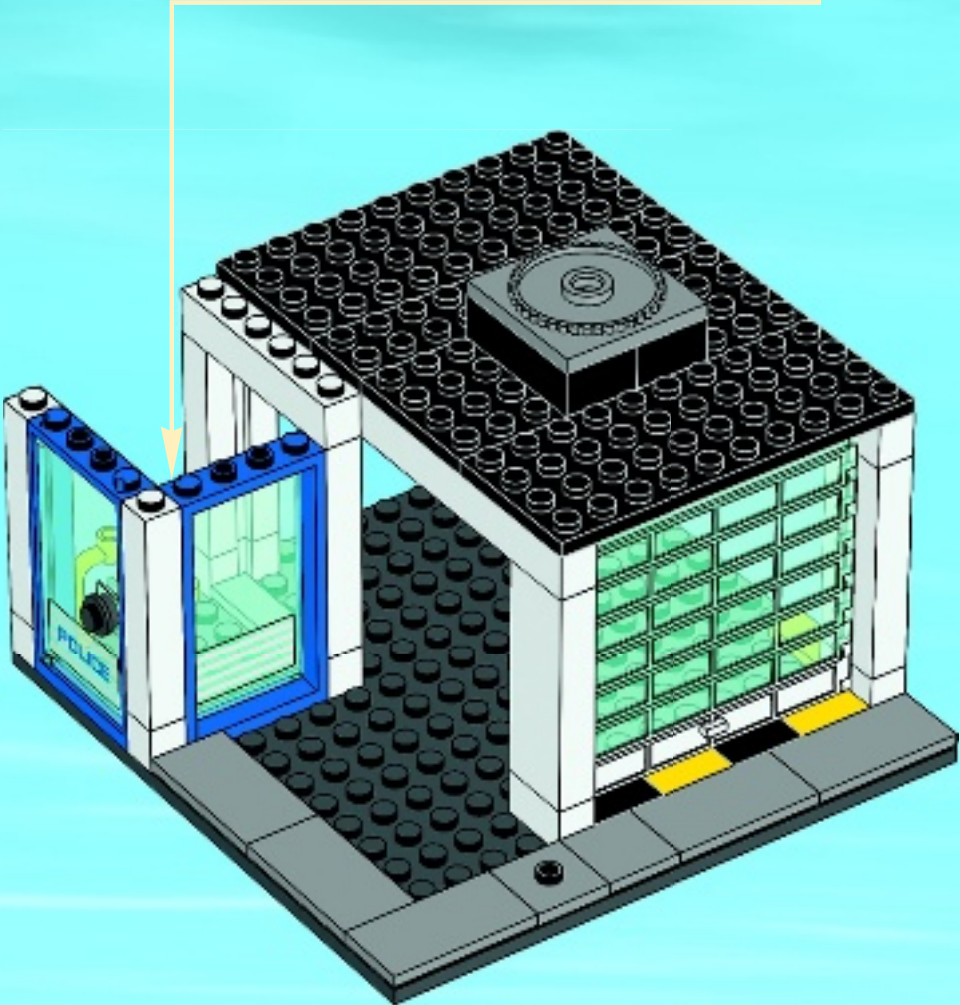
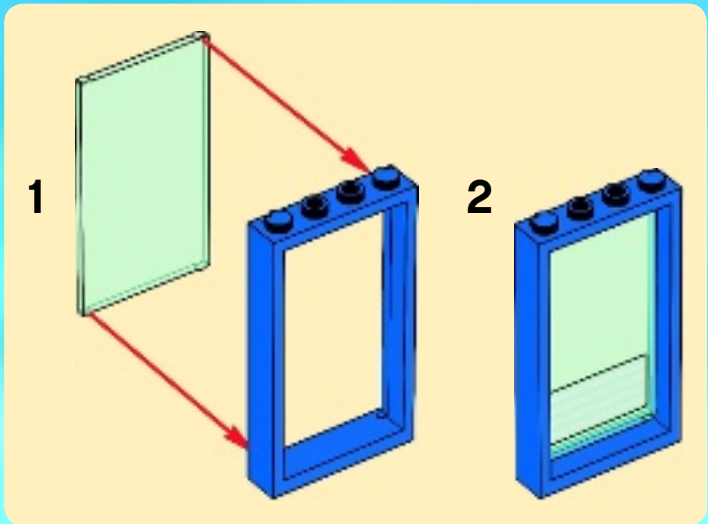



2x



2x

19

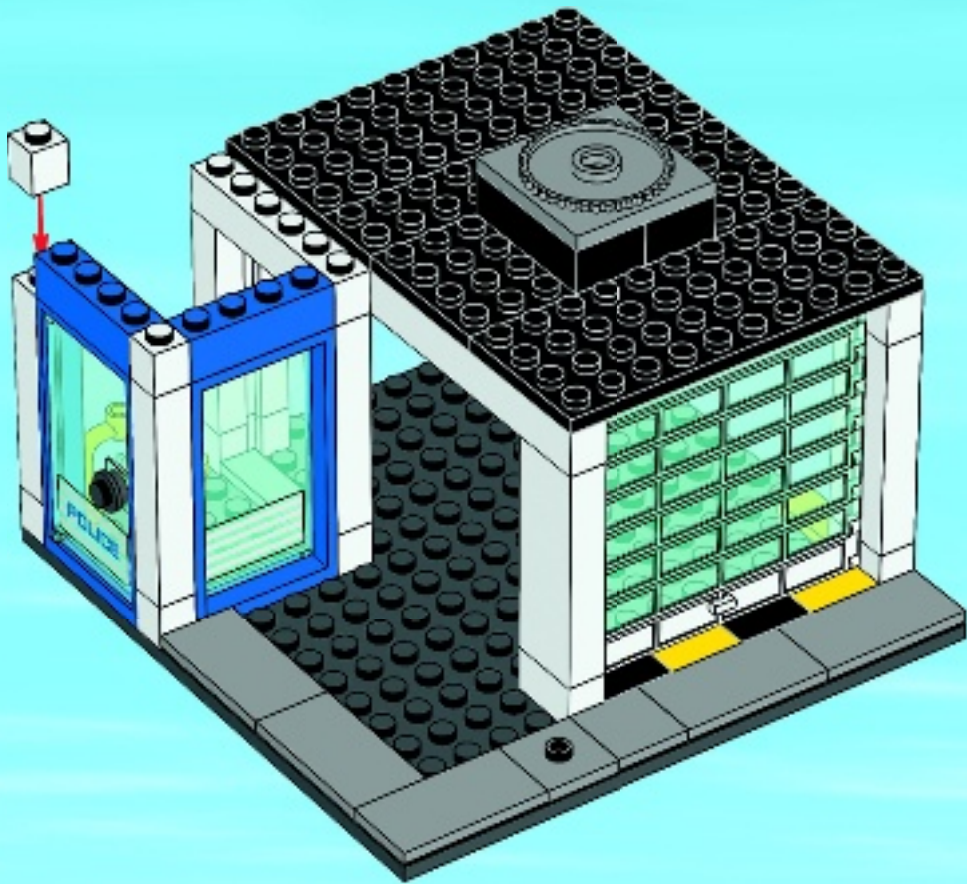



1x

20

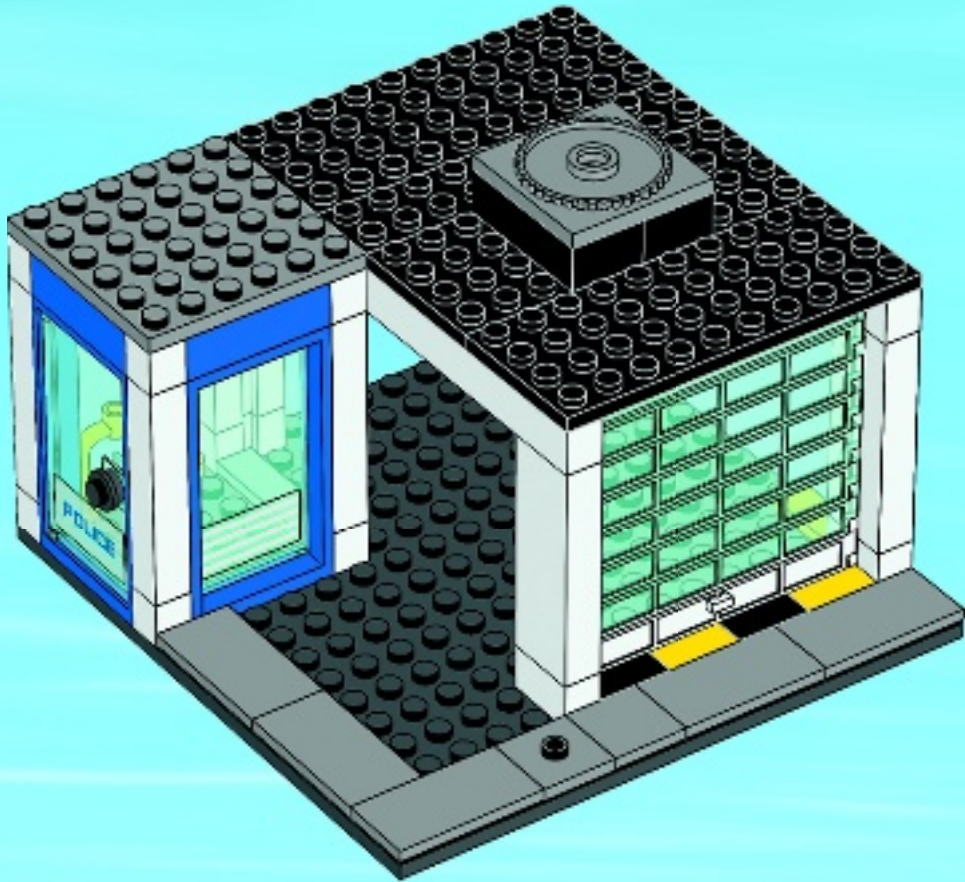



21

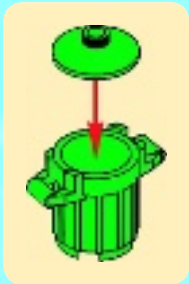
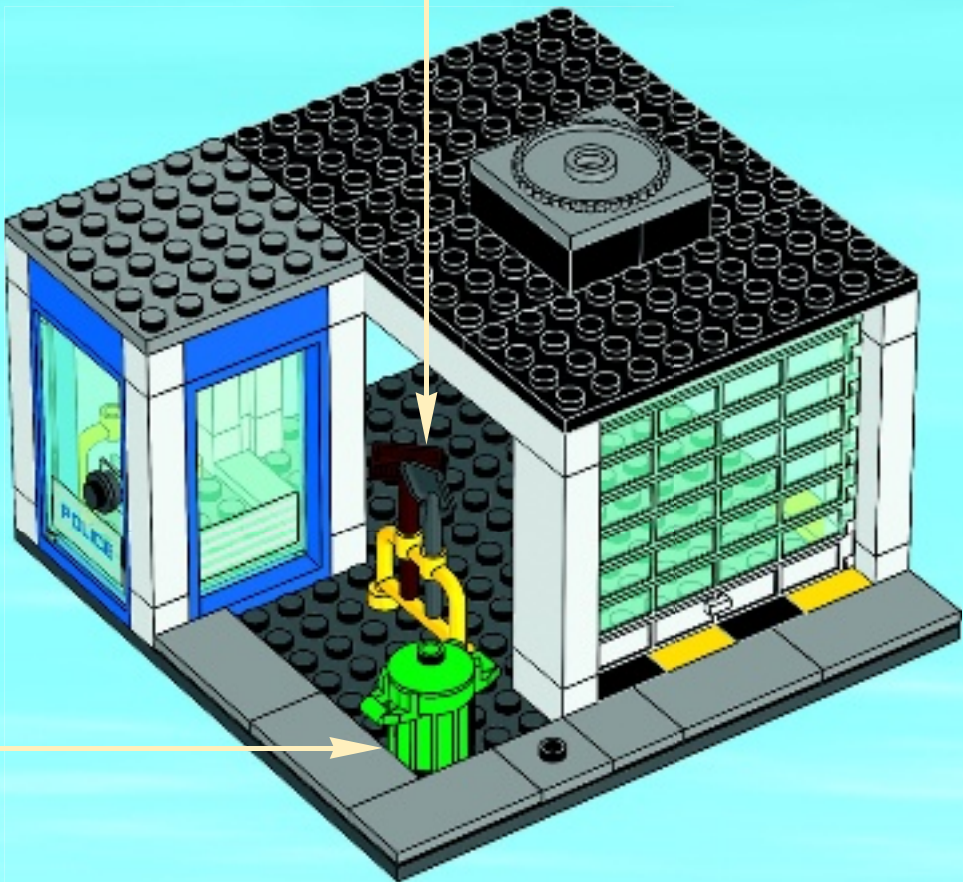
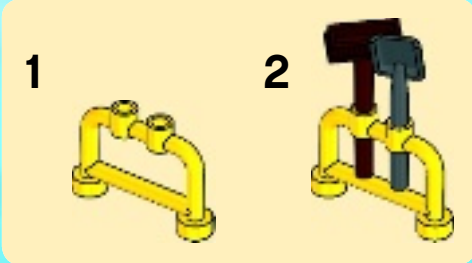

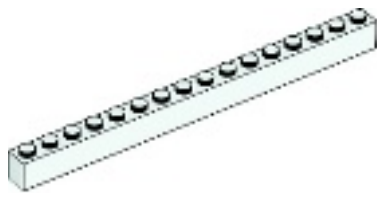

+



5

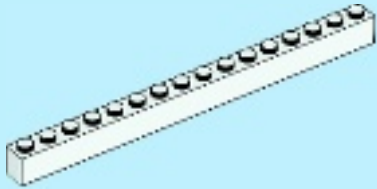
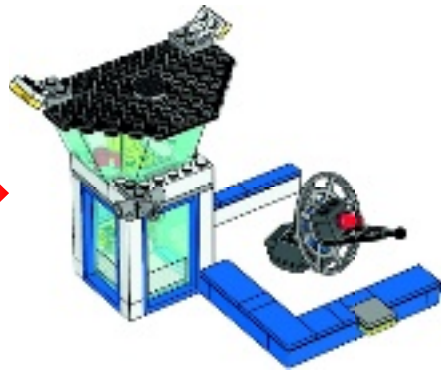

1x

22

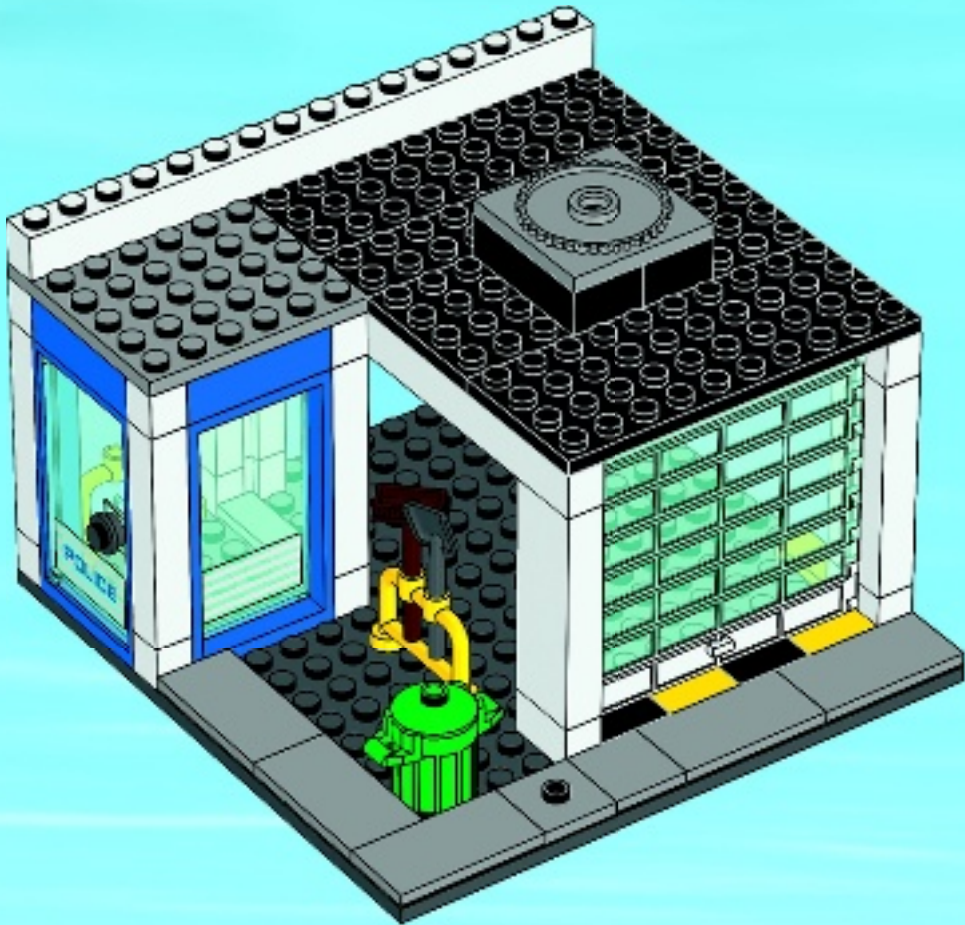

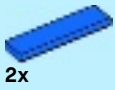

2x



1x

23

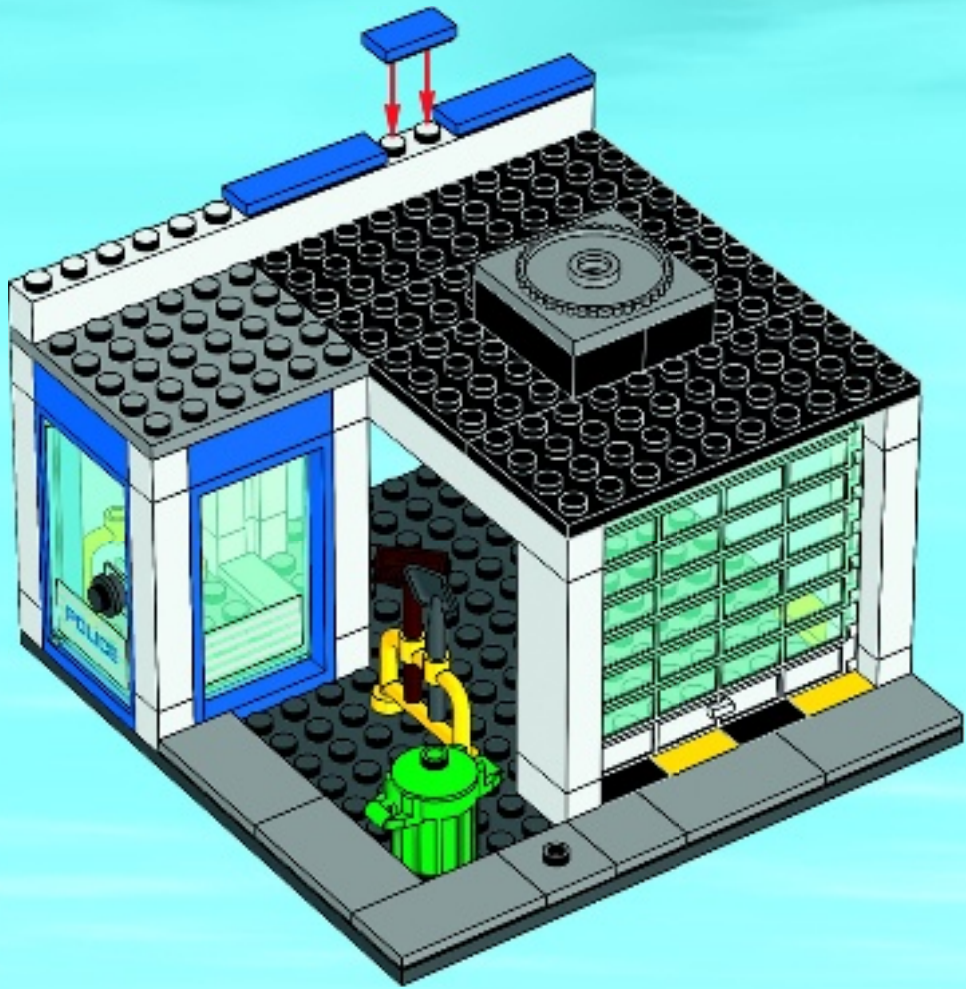



2x



1x

24

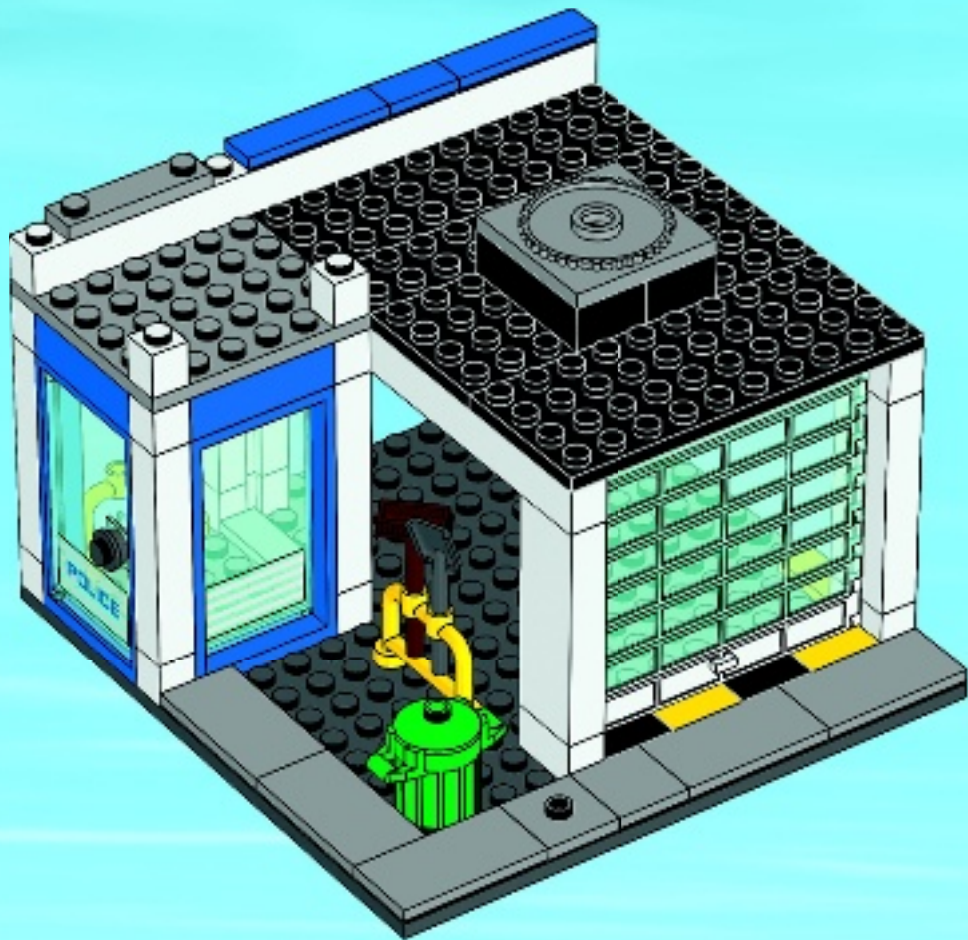

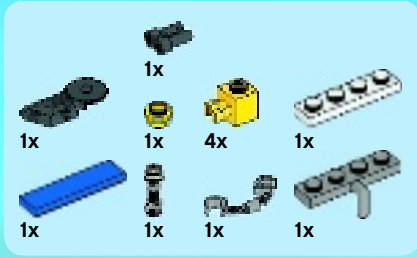

25

1



2

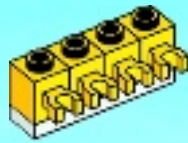

3

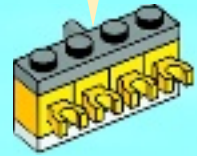
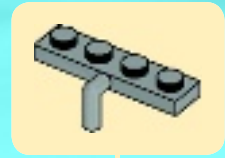

4



5

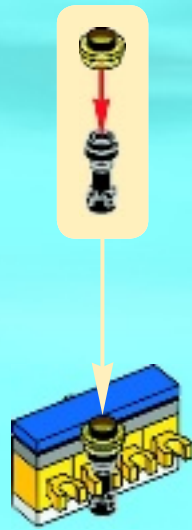

6



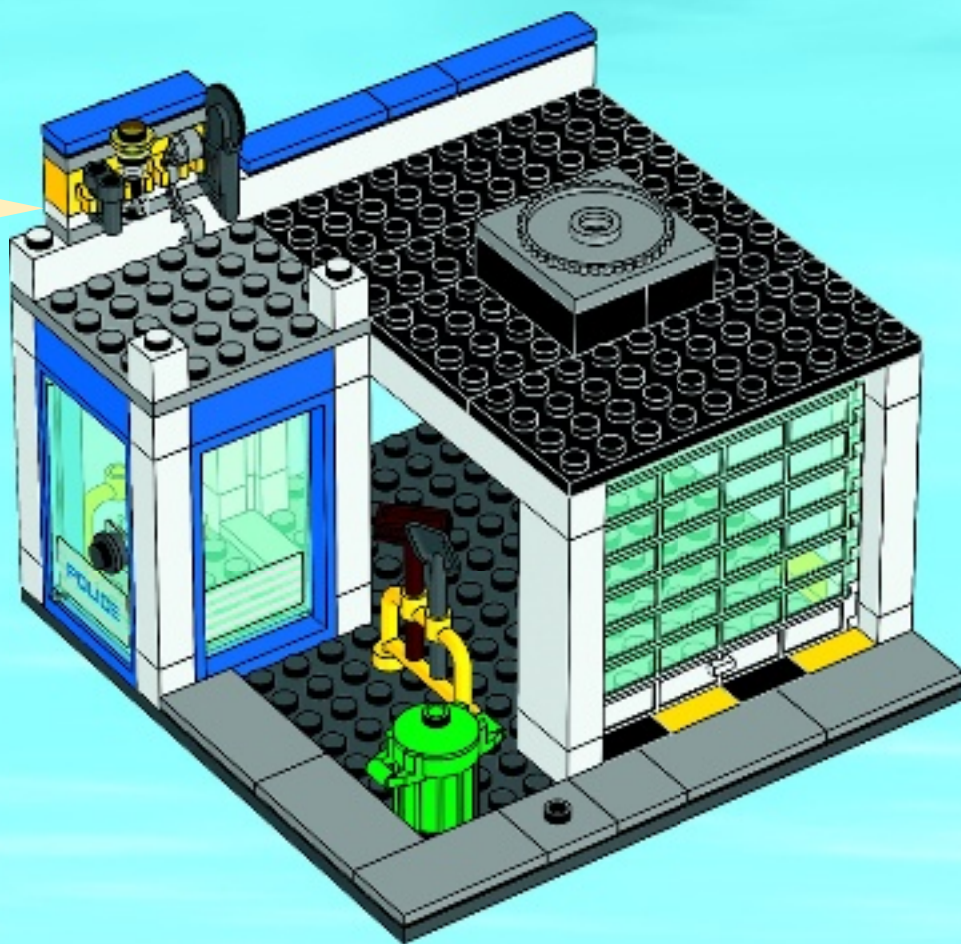

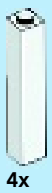

4x

26

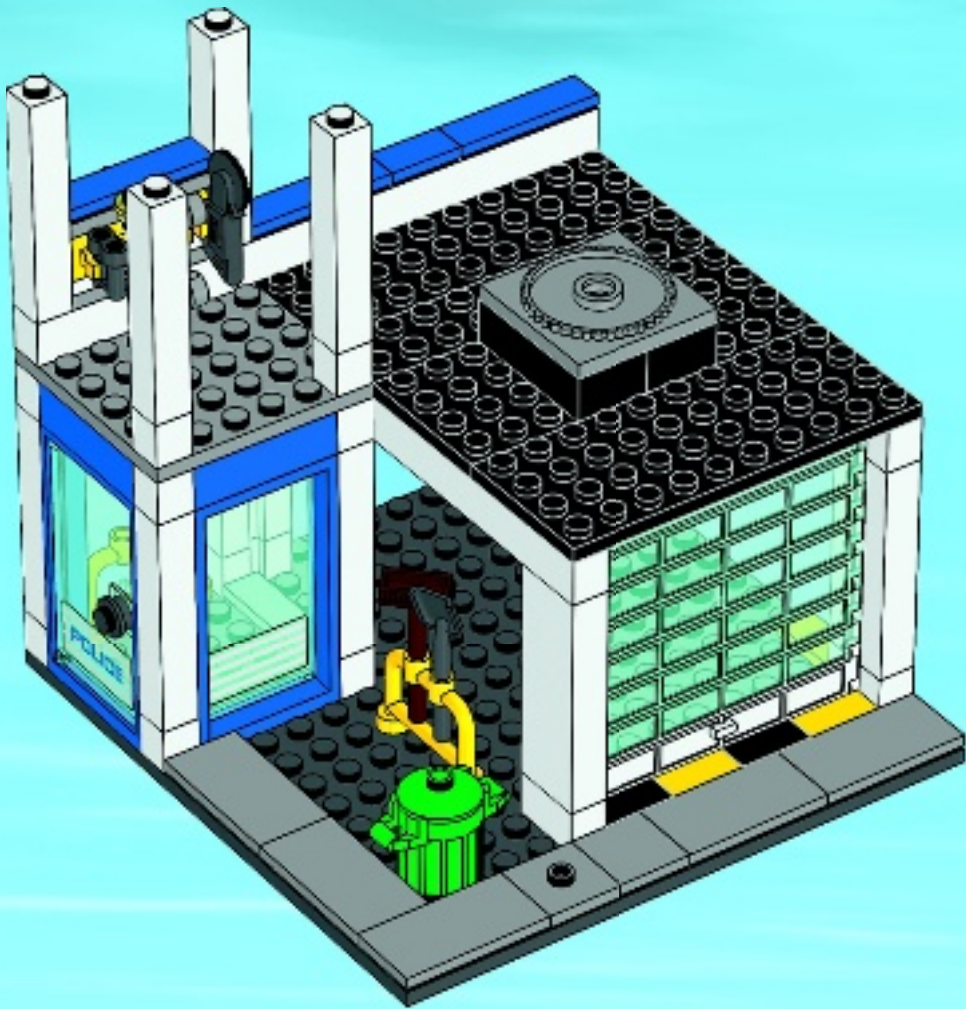

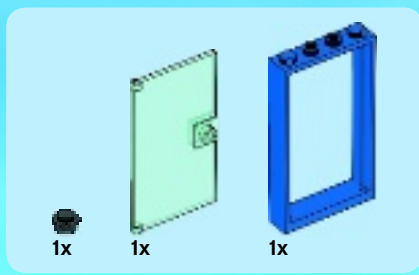

27

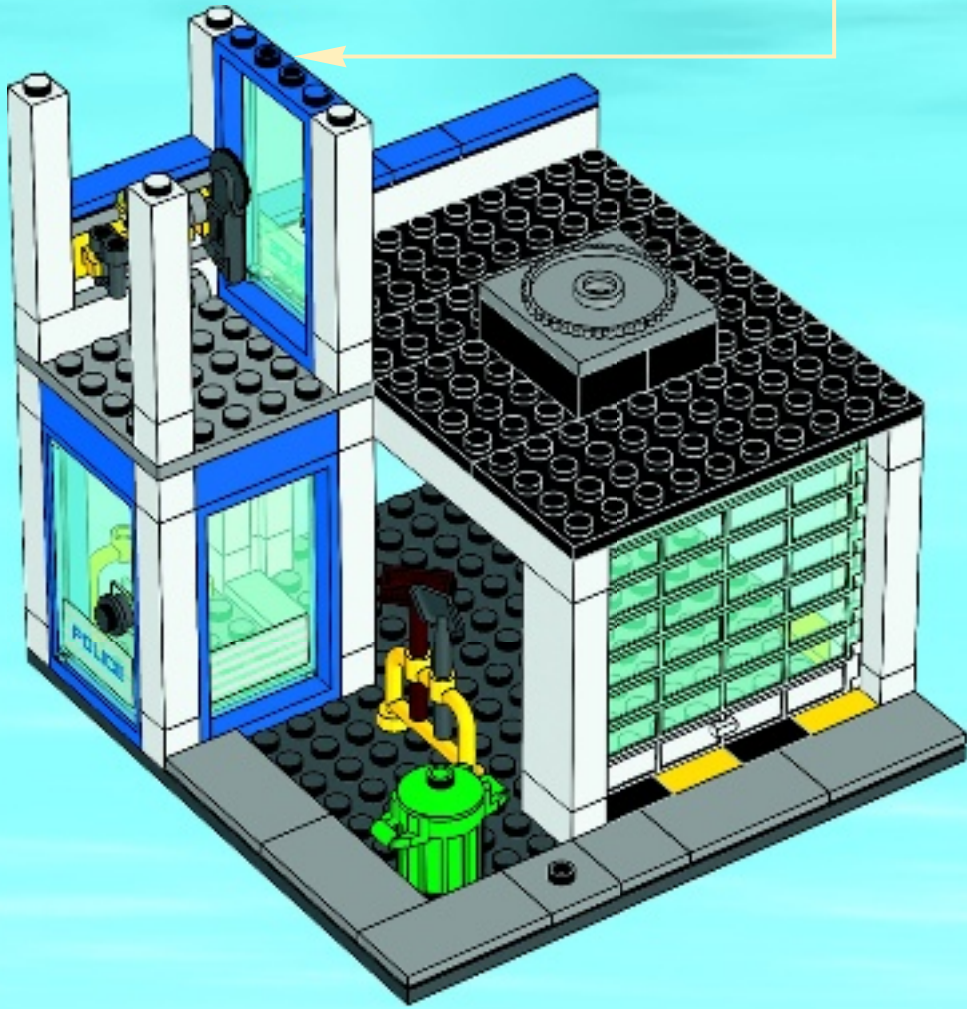
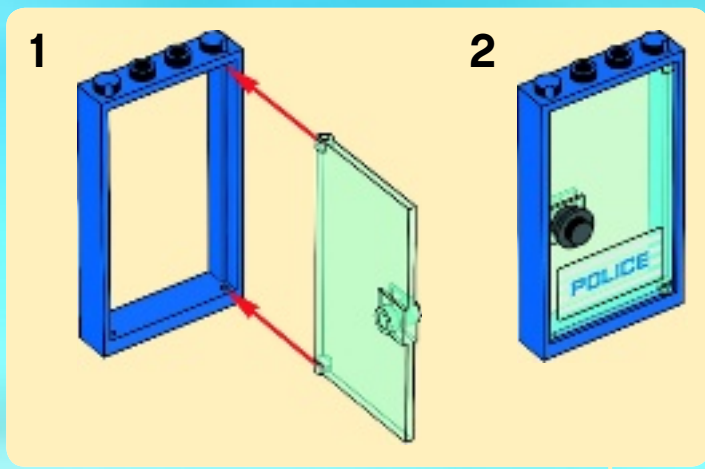

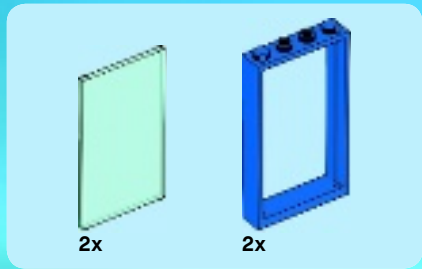

28

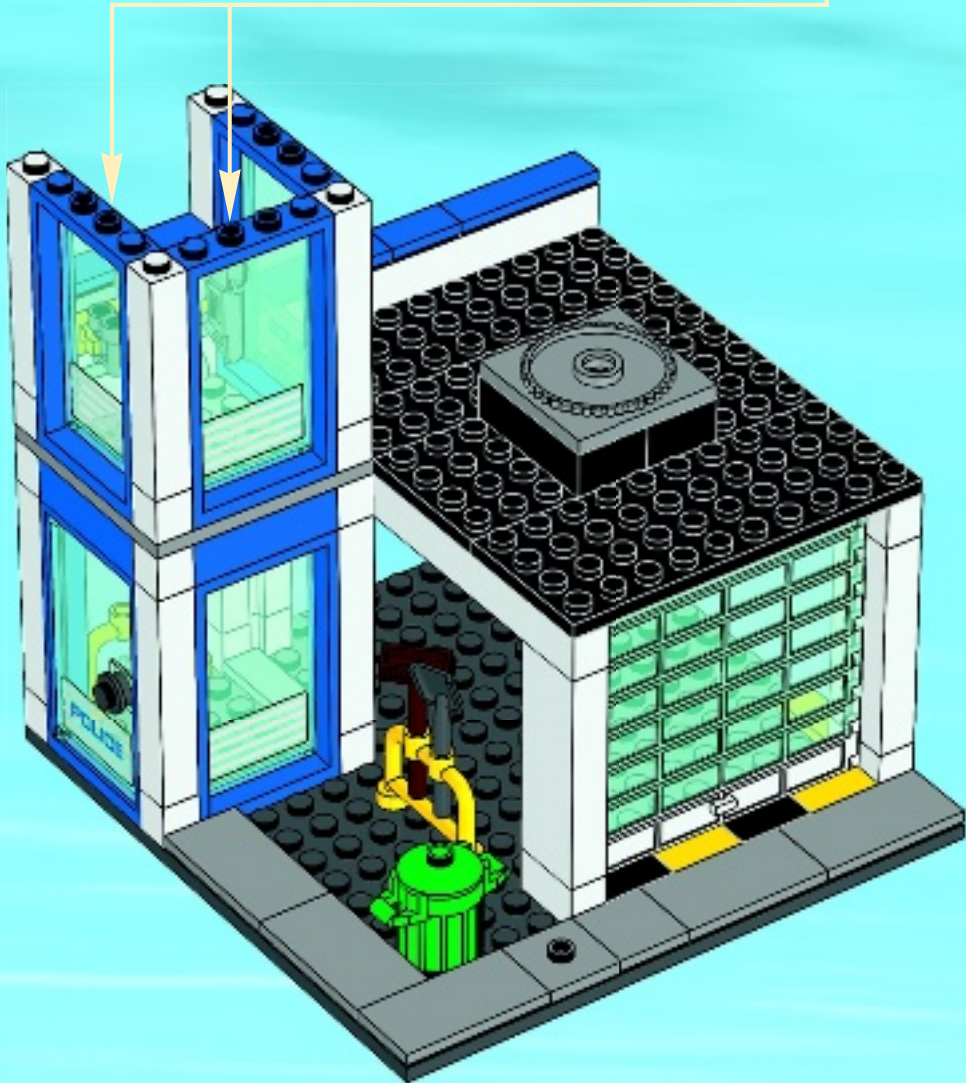
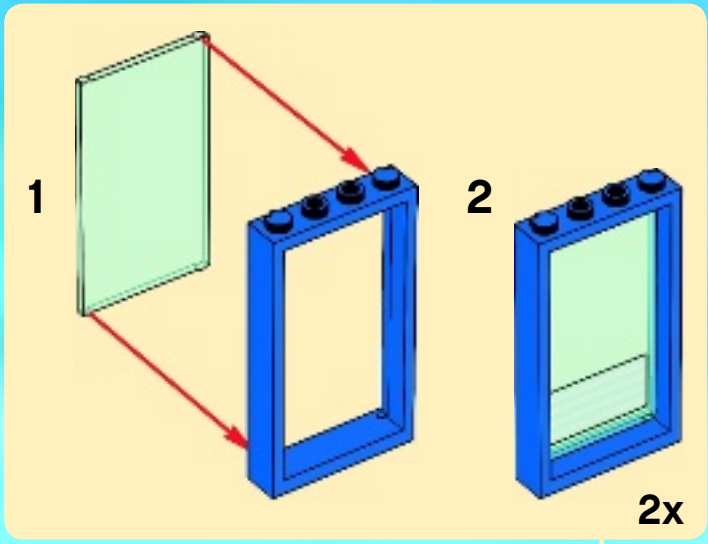



1x

29

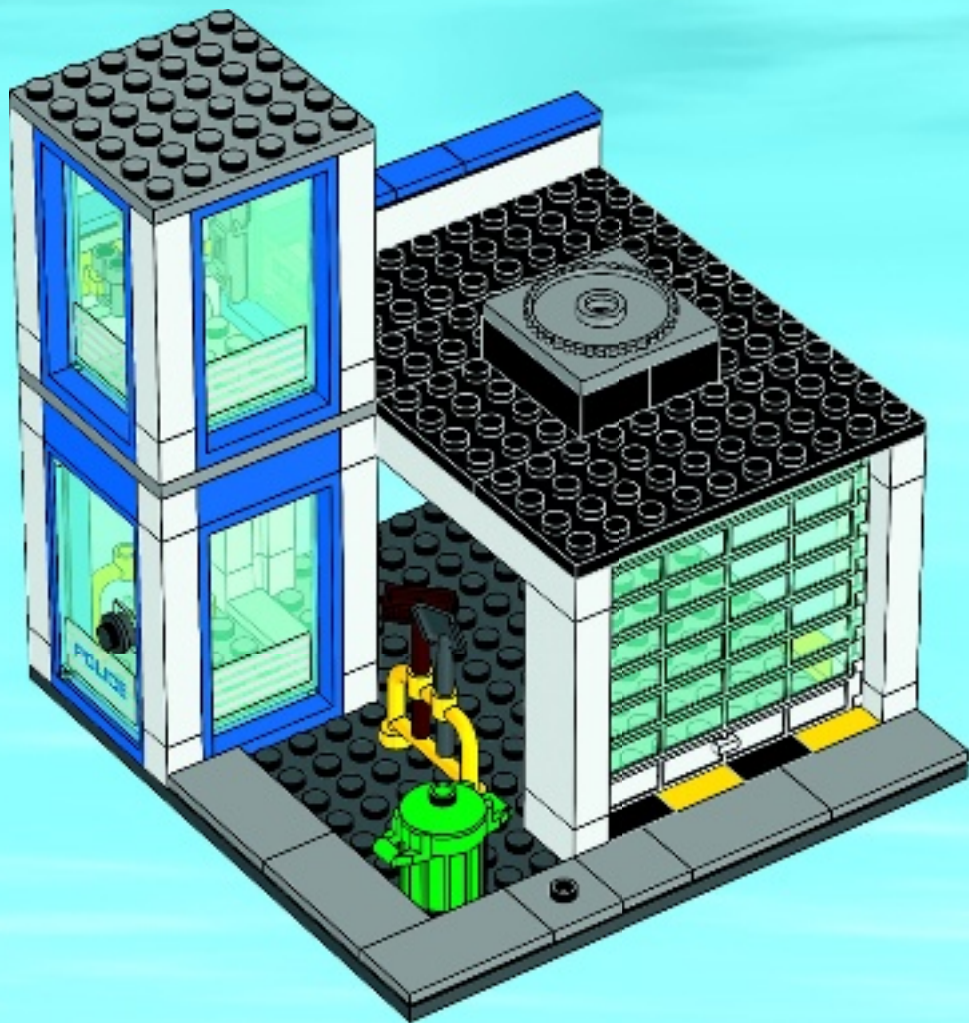



2x



1x

30

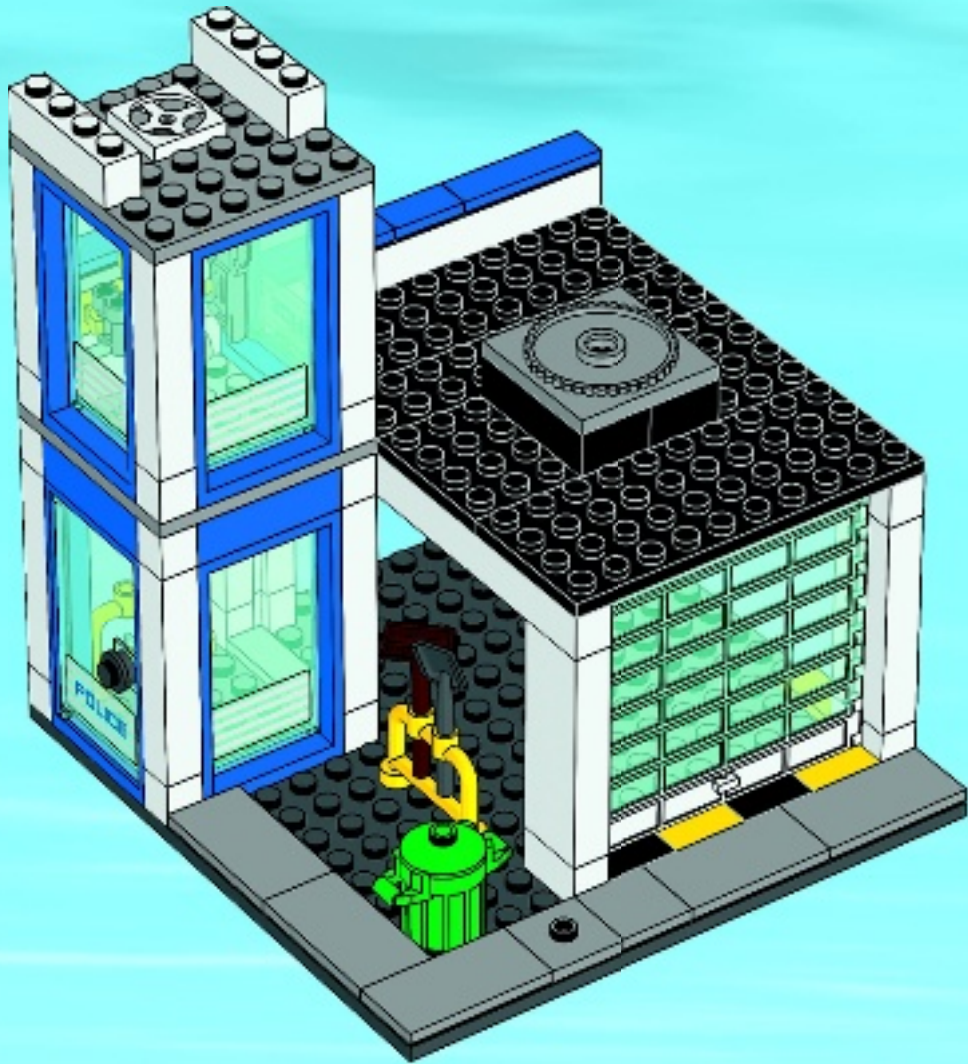

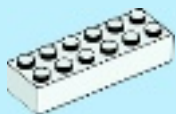

1x



1x

31

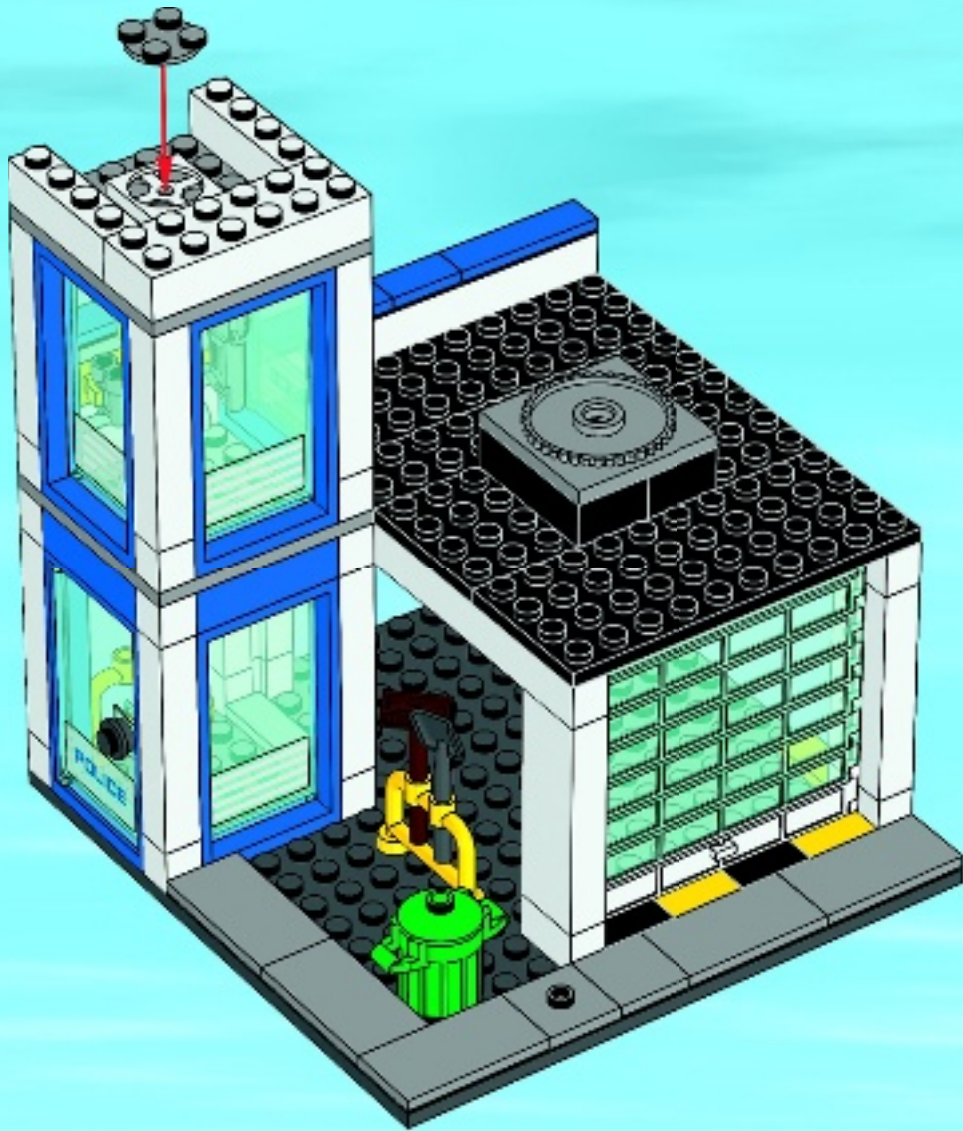



1x



1x

32

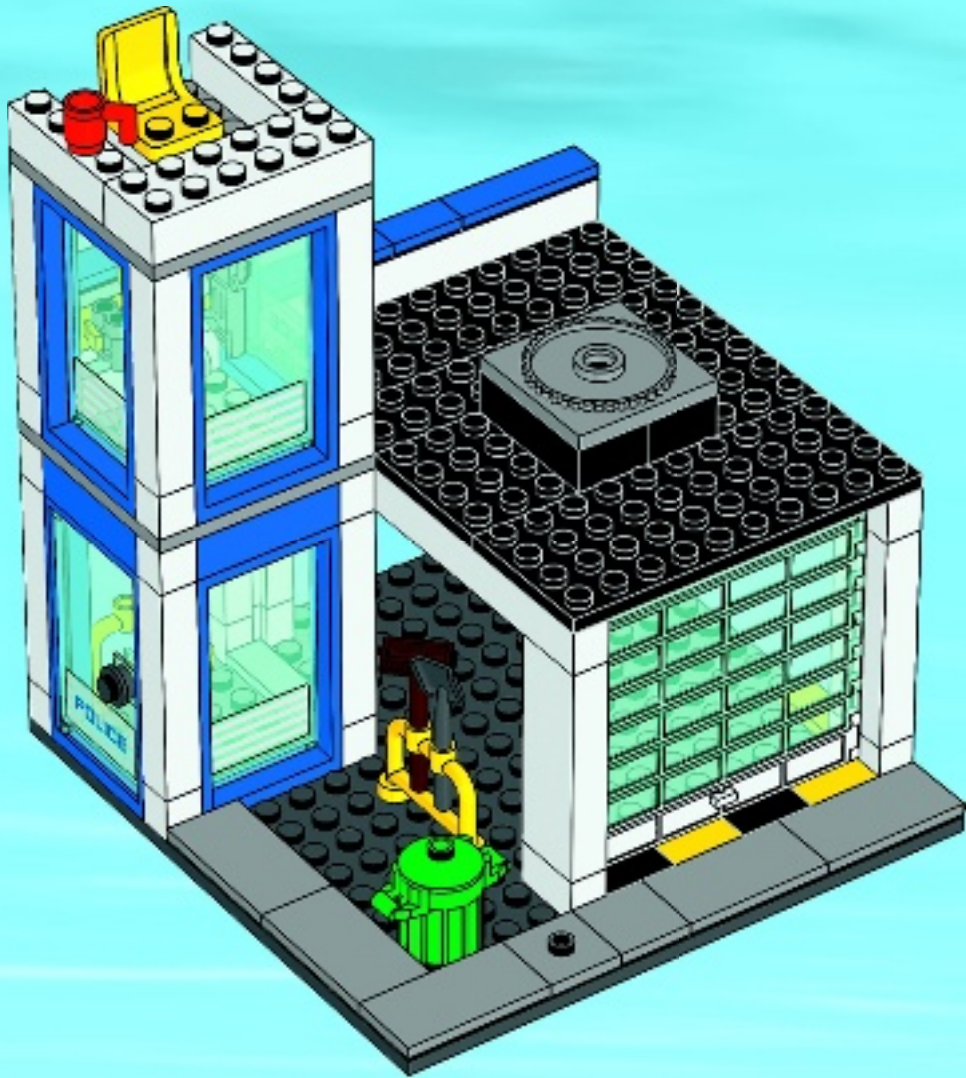



1x

33

1



2

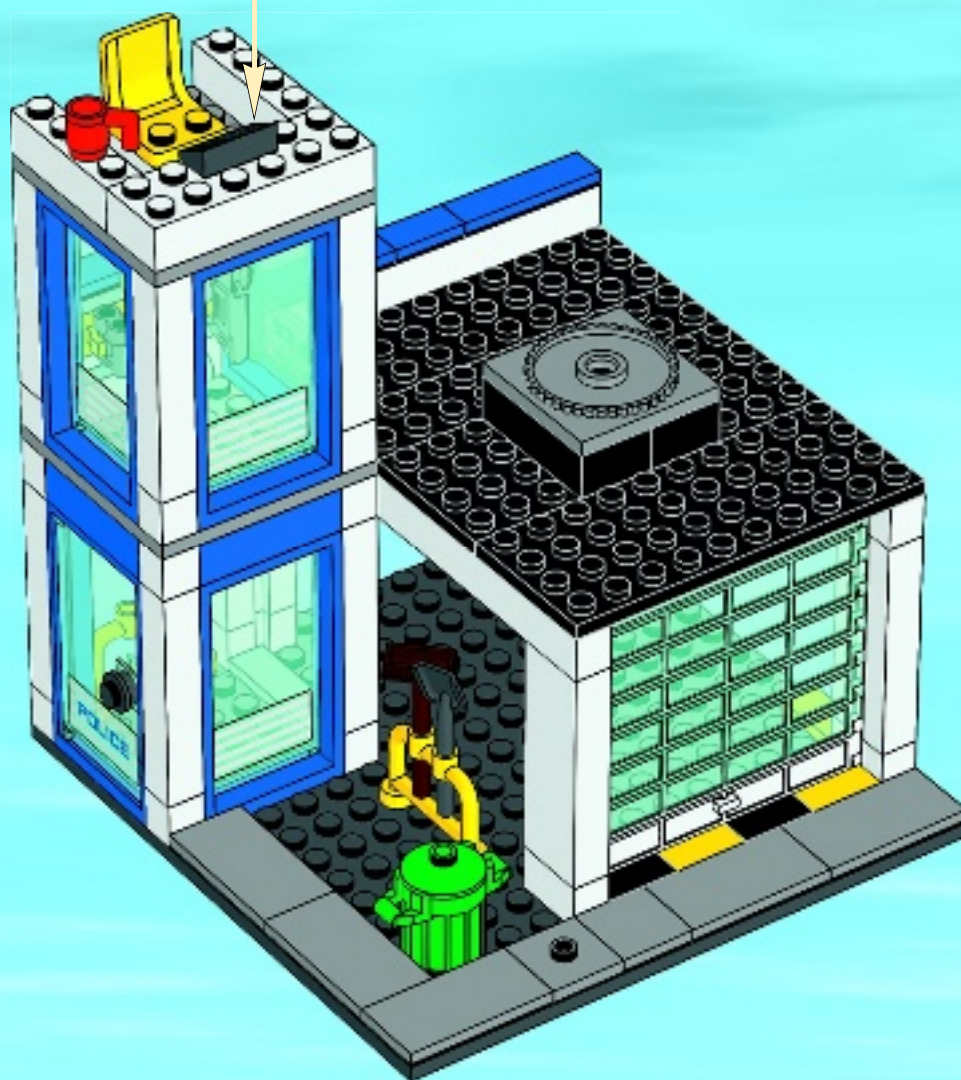

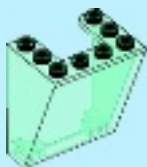

2x

34

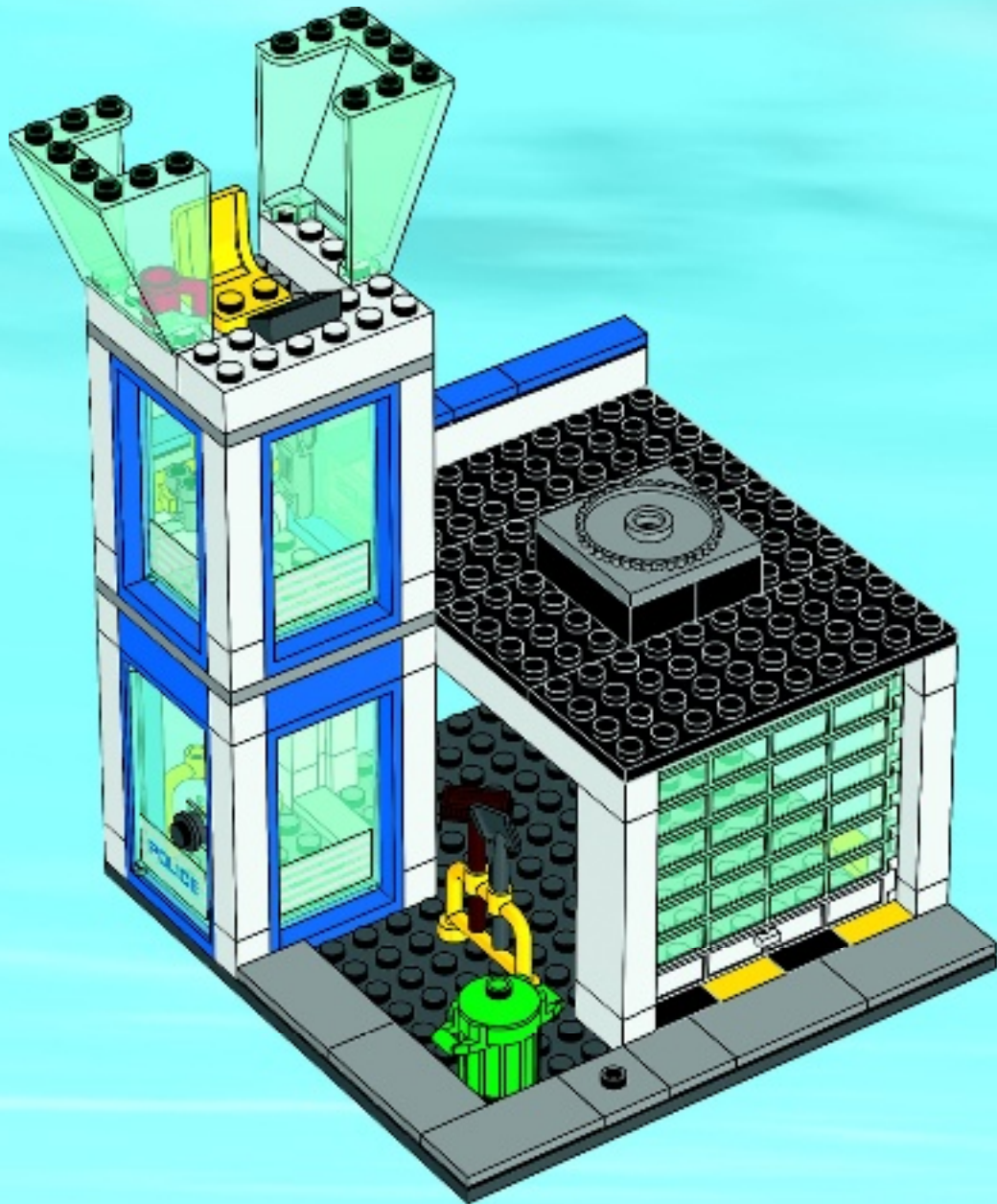

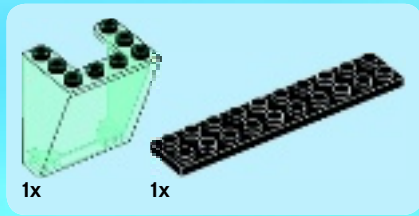

35





2x

36





1x



1x

37





2x



2x



2x

38



1

2

2x

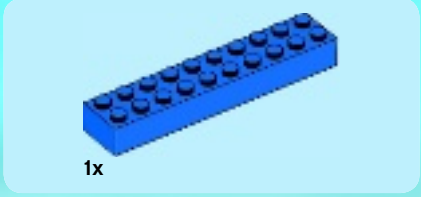
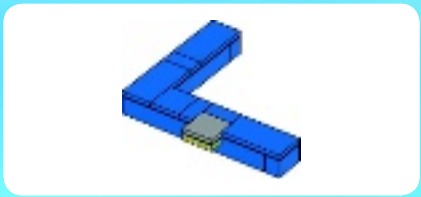

1

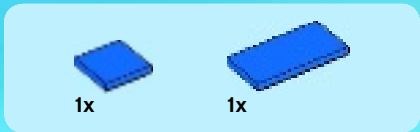
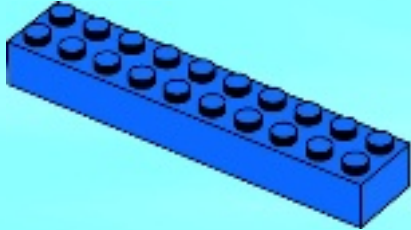

2

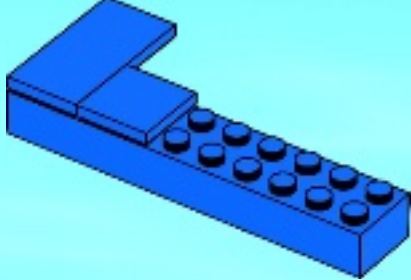

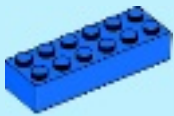

1x

3

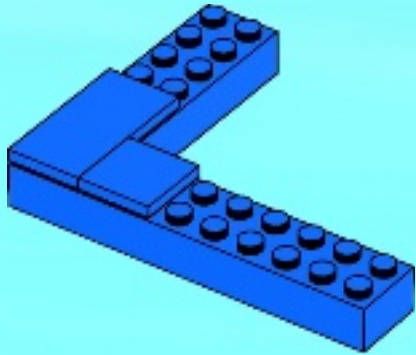

1x

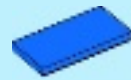

1x

4

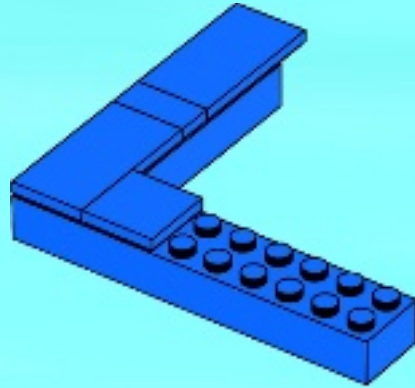

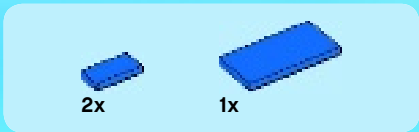

5

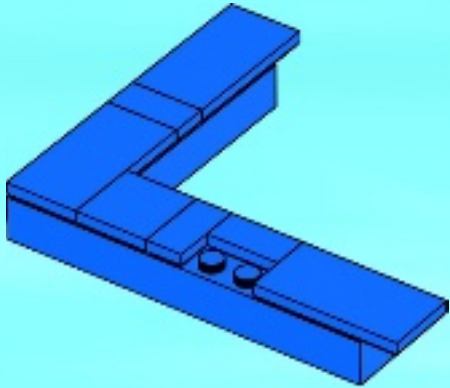

6

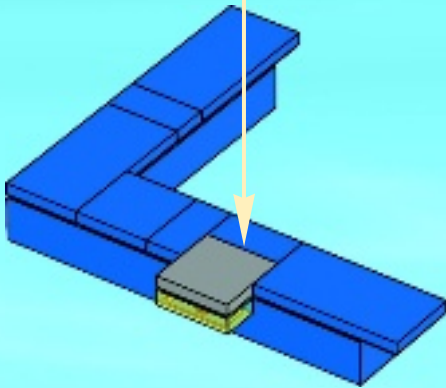
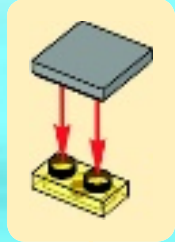



2x

7

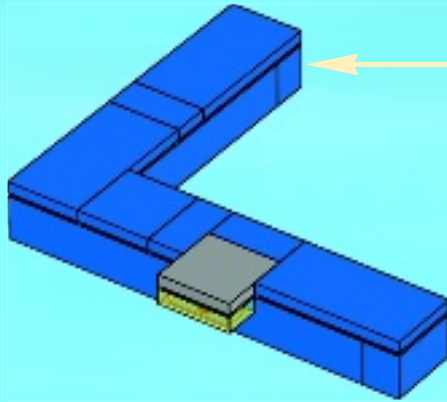

2x

39

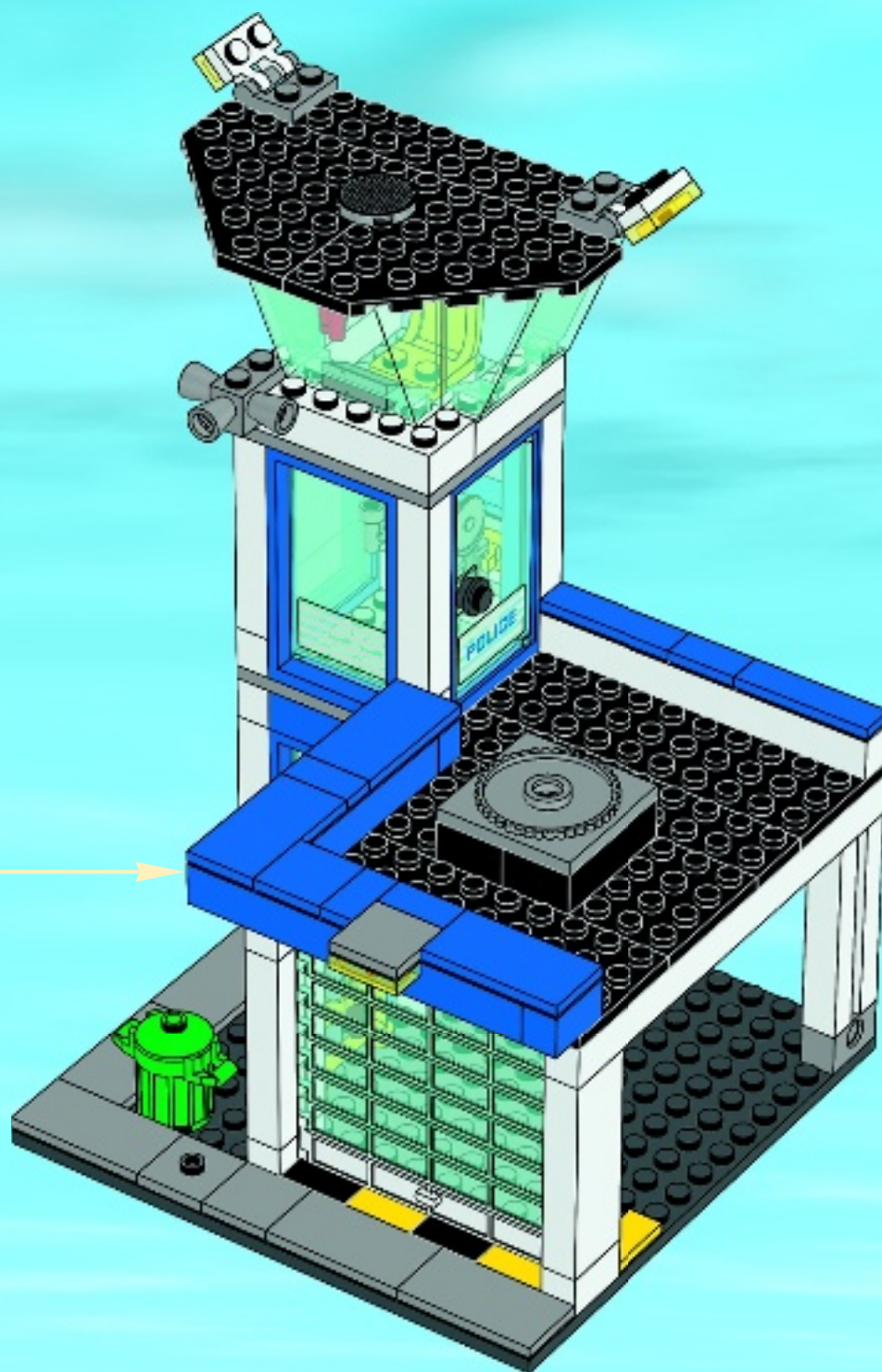

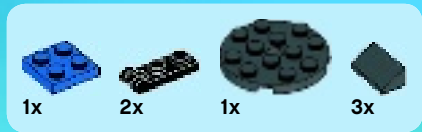

40

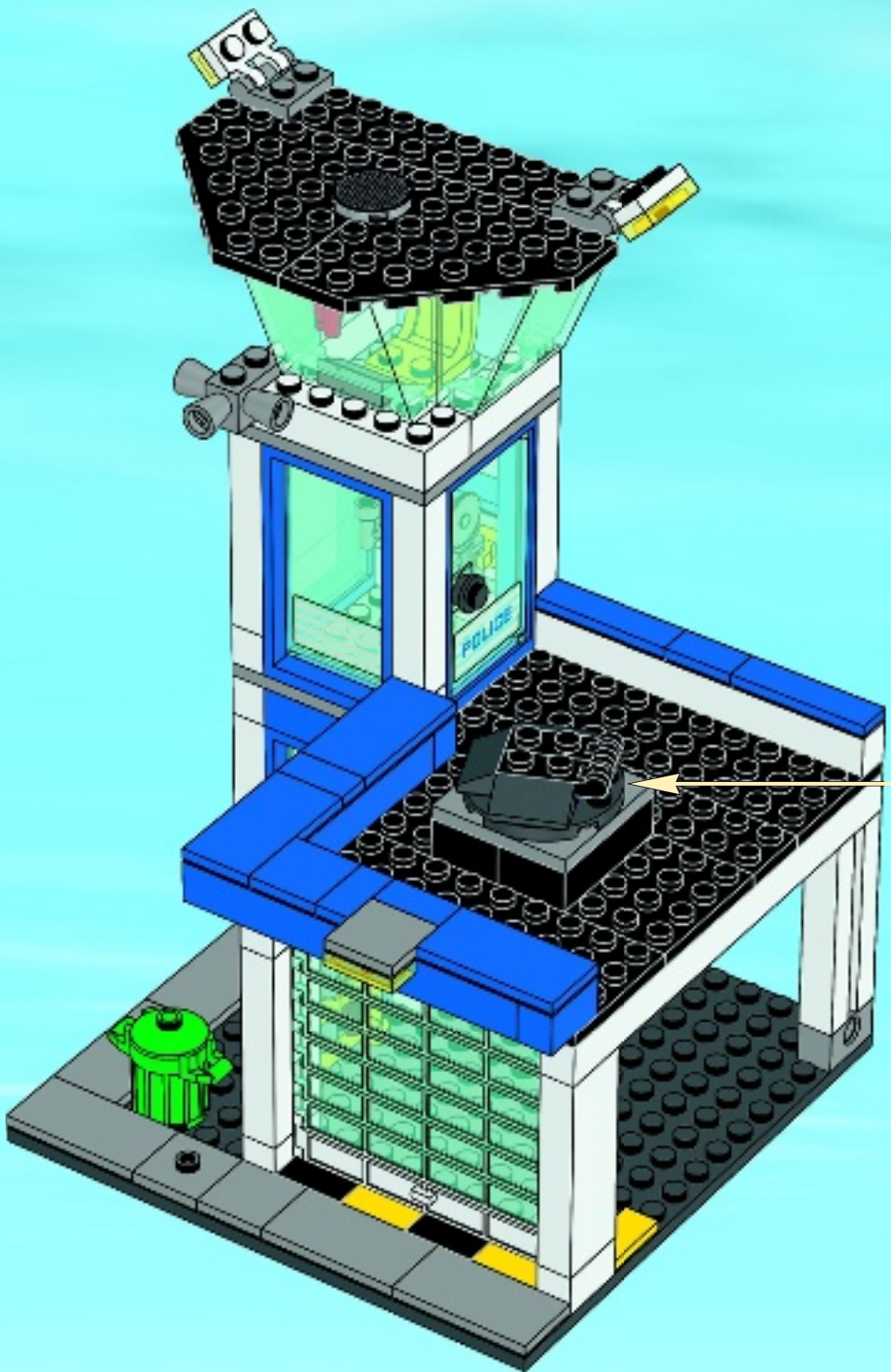



1x



2x

41

1



2

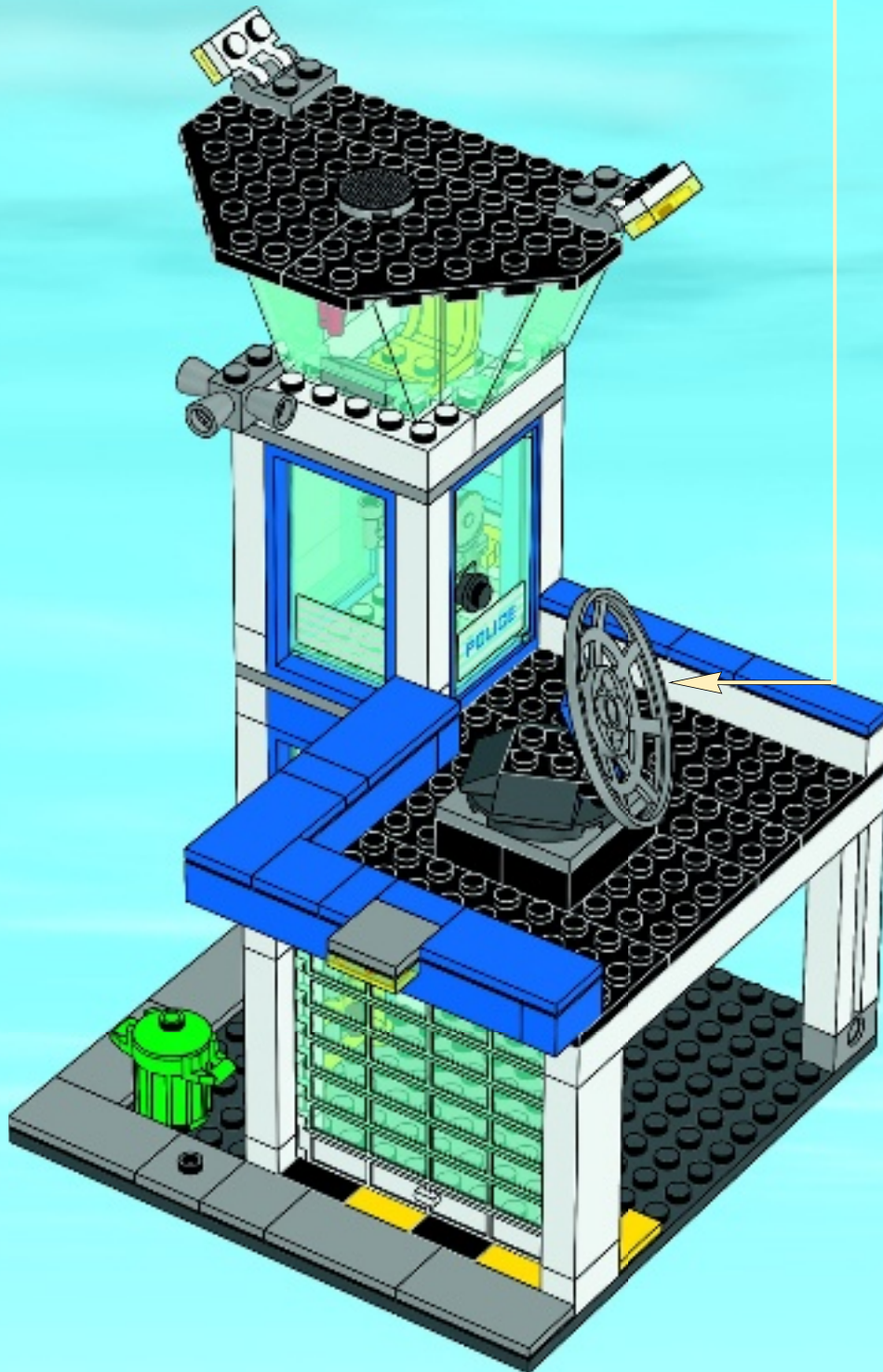

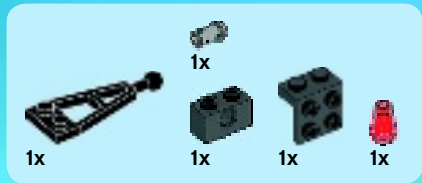

42

1



2

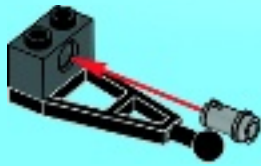

3



4

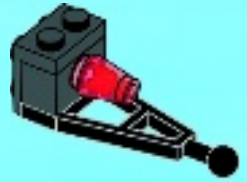

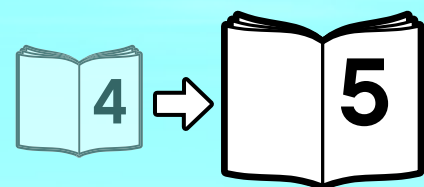
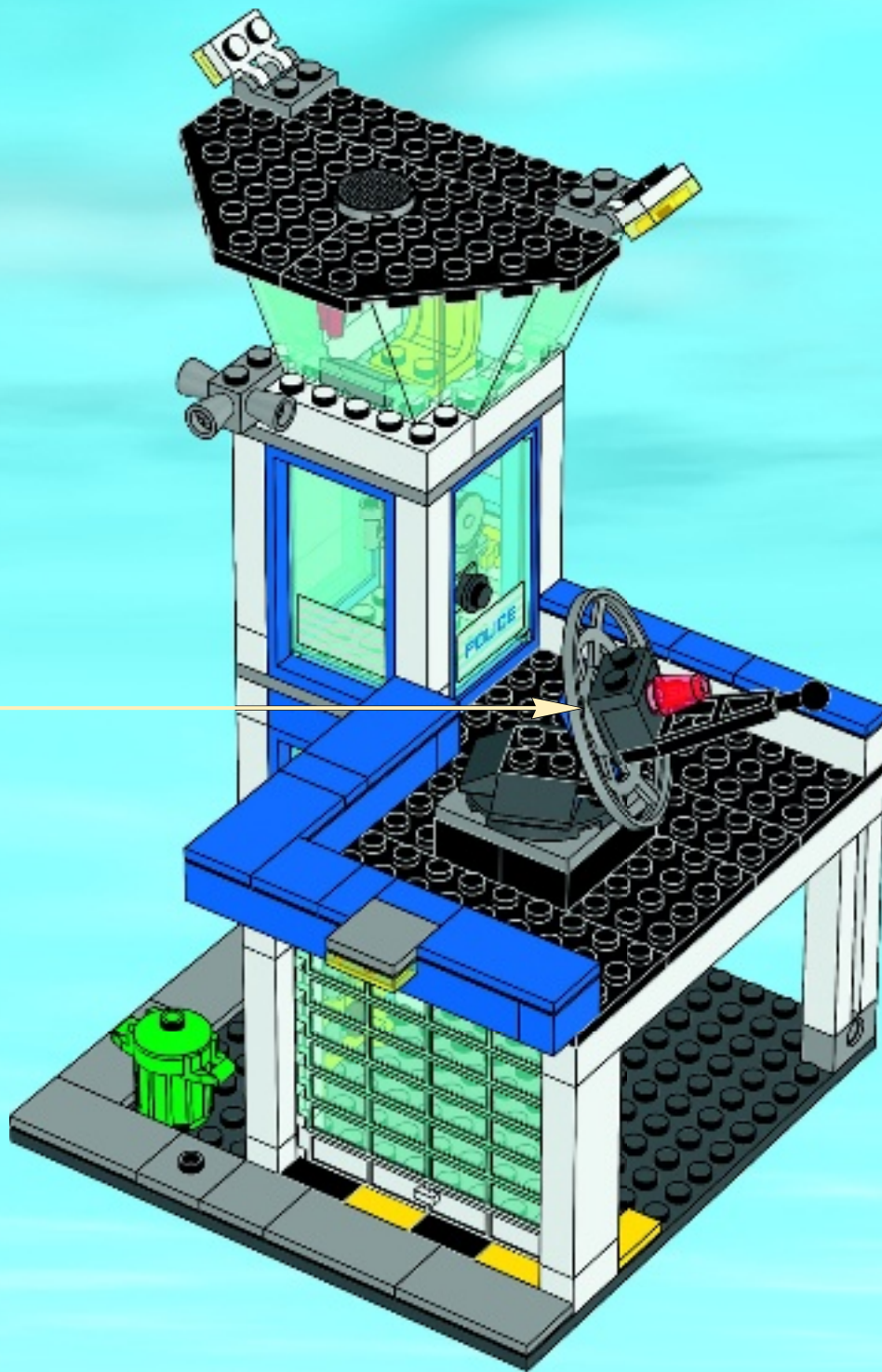

WOW!



Go to LEGO.com/productfeedback to fill out a survey for a chance to win a cool LEGO® Product. No purchase necessary. Open to all residents where not prohibited.



LEGO.com/productfeedback

GEWINNE!

Nimm an der Umfrage auf LEGO.com/productfeedback teil und hab die Chance ein cooles LEGO® Produkt zu gewinnen! Die Teilnahme am Gewinnspiel führt zu keinerlei Kaufverpflichtungen. Teilnahme in allen nicht ausgeschlossenen Ländern möglich.

WIN!

Ga naar LEGO.com/productfeedback, vul een enquêteformulier in en maak kans op een cool LEGO® product. Geen aankoopverplichting. Ledereen mag deelnemen, uitgezonderd ingezetenden van landen waar een enquêteverbod geldt.

GAGNE!

Visite LEGO.com/productfeedback pour répondre à un questionnaire et avoir une chance de gagner un produit LEGO® très cool! Aucune obligation d'achat. Ouvrez à tous les résidents des pays autorisés.

当てよう!

LEGO.com/productfeedbackにアクセスしてアンケートにご記入ください。当選者にはレゴ製品を差し上げます。お買い上げの必要はありません。禁止されていない限り、すべての国籍にご利用いただけます。

