



CITY

60397



1

2



 **FR**
DONNEZ
OU
RECYCLEZ

 OU  OU 

ASSOCIATION MAGASIN DÉCHÈTERIE

Adresses sur quefairedemesdechets.fr



LEGO.com/sustainable-packaging

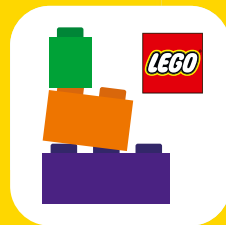

BUILDER



Apple and the Apple logo are trademarks of Apple Inc., registered in the U.S. and other countries and regions. App Store is a service mark of Apple Inc. Google Play and the Google Play logo are trademarks of Google LLC. Tencent and the Tencent logo are trademarks of Tencent Inc.

Q [LEGO.com/devicecheck](https://www.lego.com/devicecheck)

EN Ask parents' permission before going online | **DE** Eltern um Erlaubnis bitten, bevor du online gehst | **FR** Demande l'autorisation d'un parent avant d'aller en ligne | **IT** Chiedi il permesso ai tuoi genitori prima di andare online | **ES** Pídeles permiso a tus papás antes de conectarte a Internet | **PT** Peça autorização aos pais antes de acederes online | **ZH** 上网前应先征得父母的同意 | **PL** Poproś rodziców o zgodę, zanim wejdiesz do Internetu | **CS** Než půjdeš na internet, požádej rodiče o svolení | **SK** Skôr než pôjdeš na internet, vypýtaj si povolenie od rodičov | **HU** Kérj szülői engedélyt, mielőtt online csatlakoznál! | **RO** Cere permisiunea părinților înainte de a te conecta online | **BG** Поискайте разрешение от родител, преди да влезете онлайн | **LV** Pirms došanās tiešsaistē palūdz atļauju vecākiem | **ET** Enne Interneti kasutamist küsi vanematelt luba | **LT** Prieš prisijungdami prie interneto, atsi klauskite tėvų

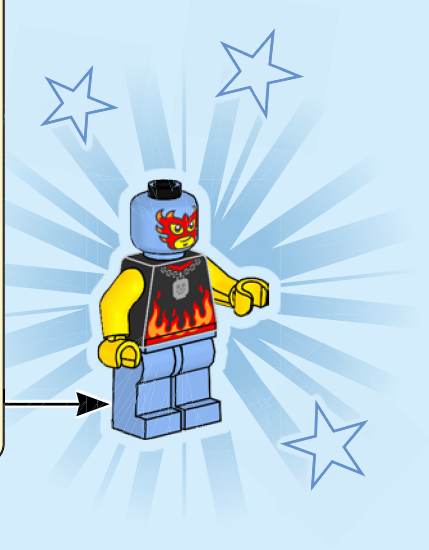
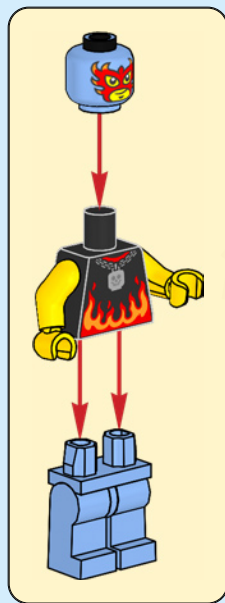

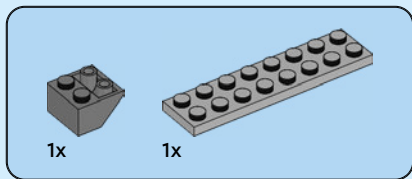

1

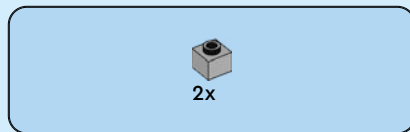
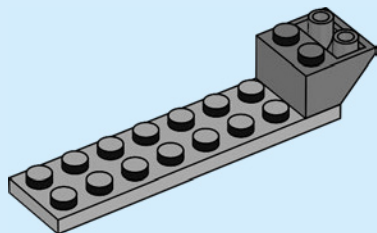

2

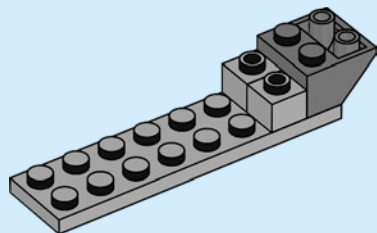



2x



1x

3

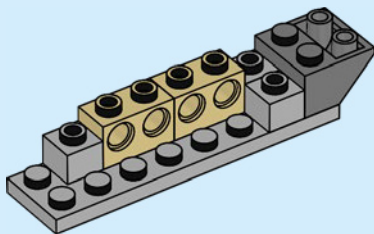



2x



1x

4

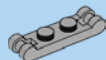
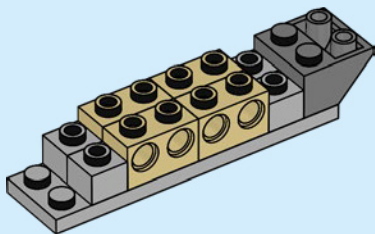

2x

5

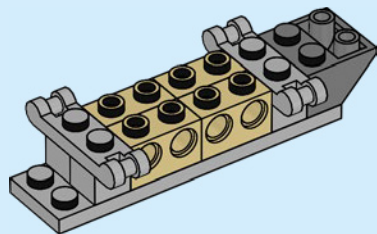



1x

6

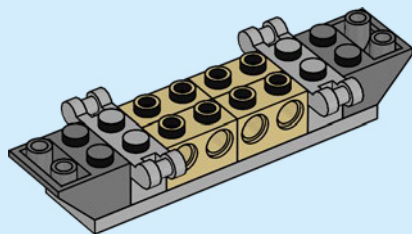

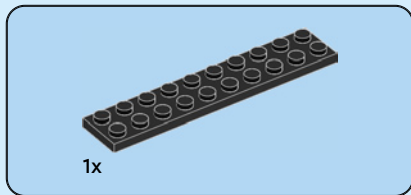

7

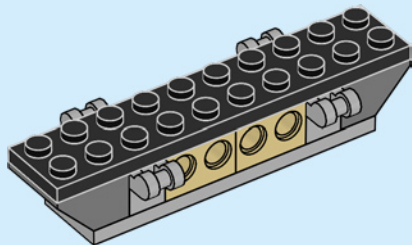

8

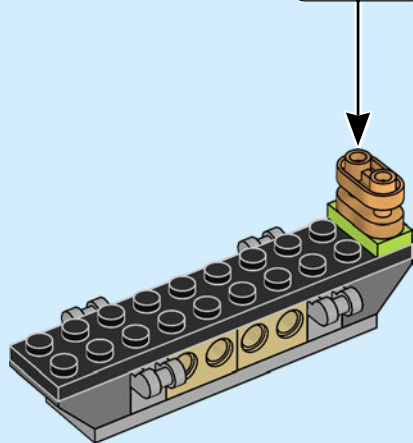
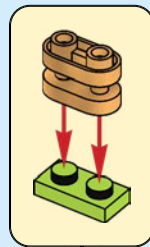

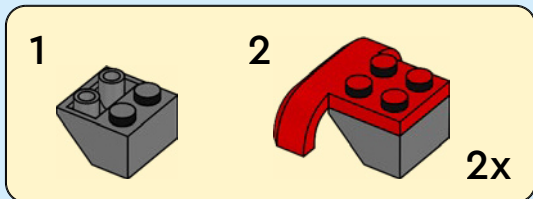
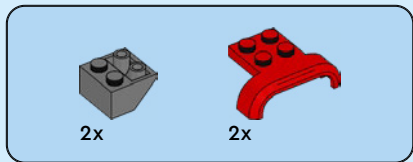

9

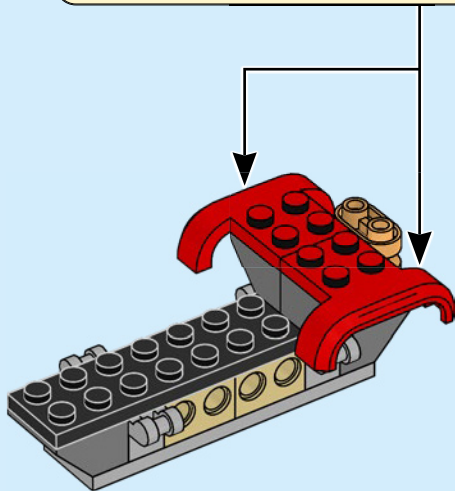

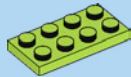

1x

10

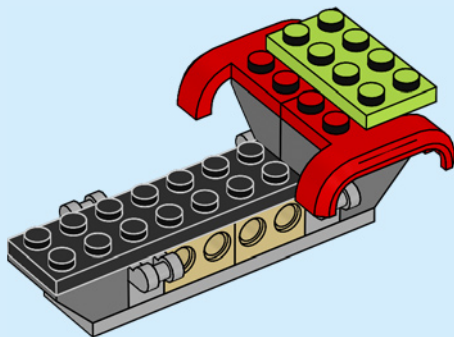

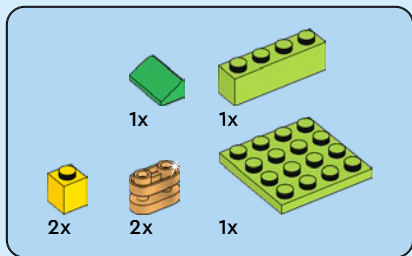

11

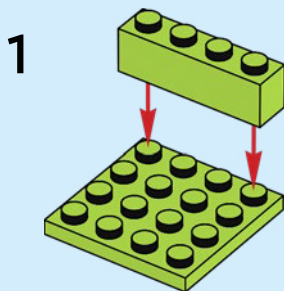

2

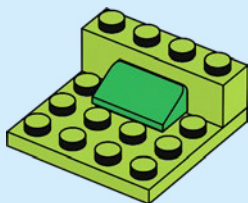

3

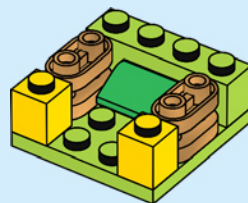

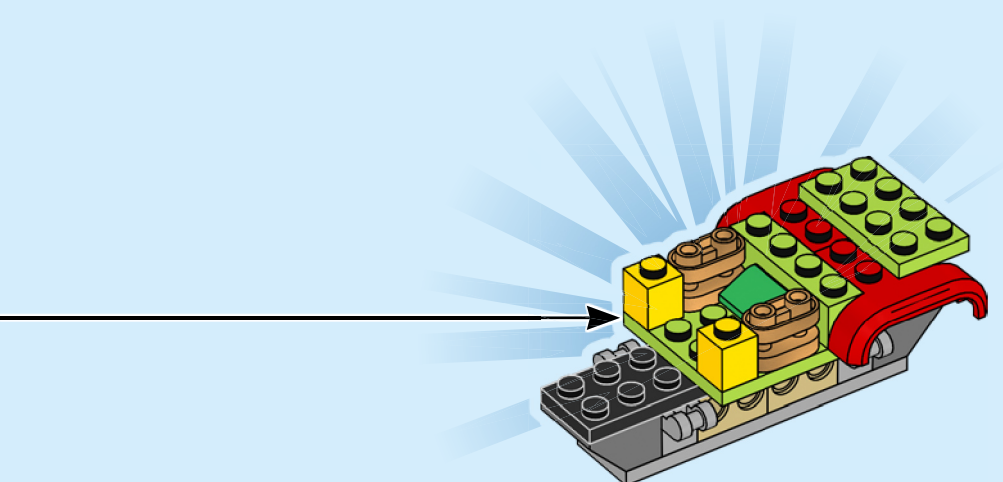

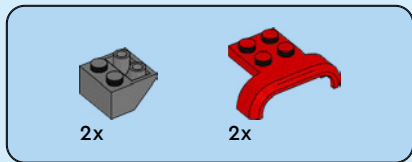

12

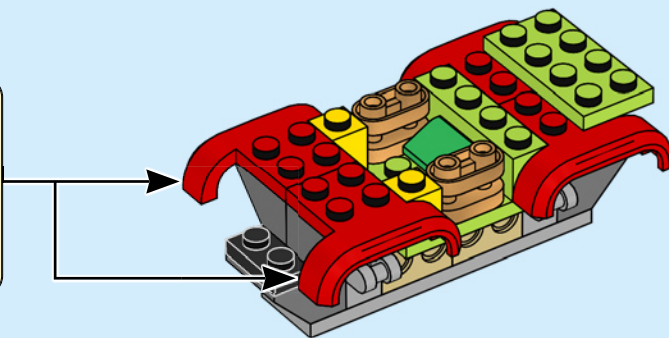
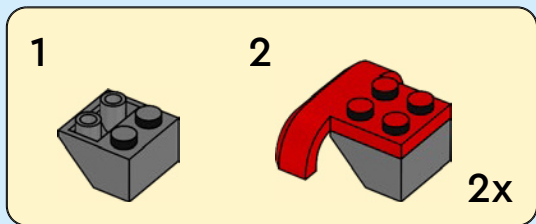

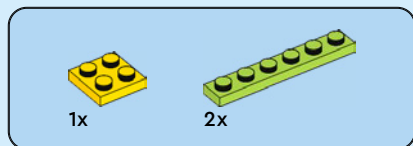

13

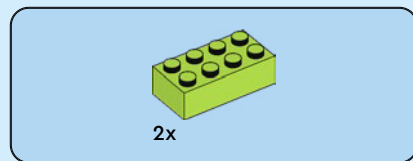
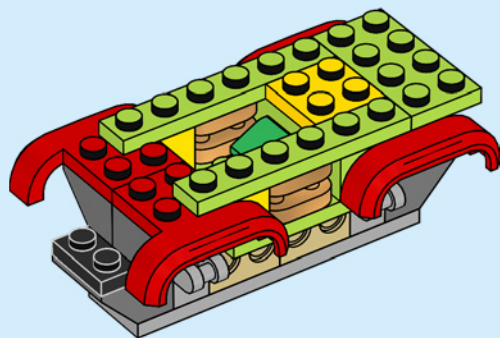

14

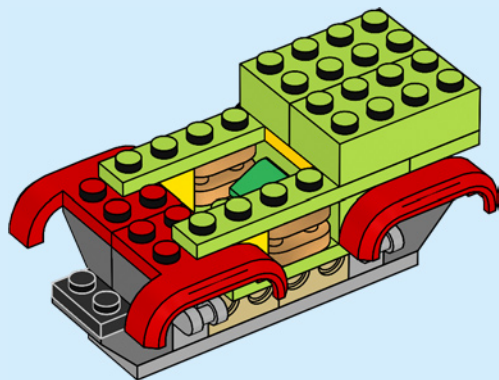

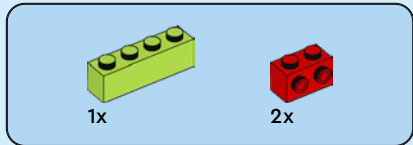

15

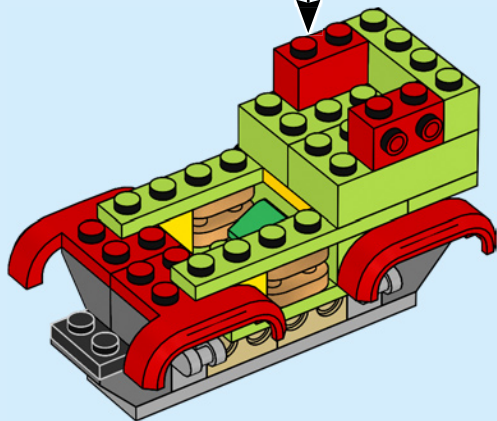
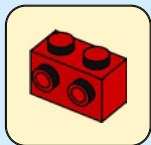

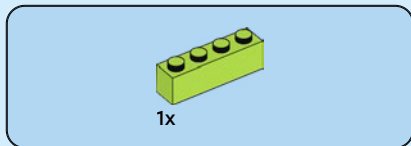

16

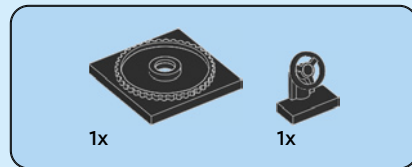
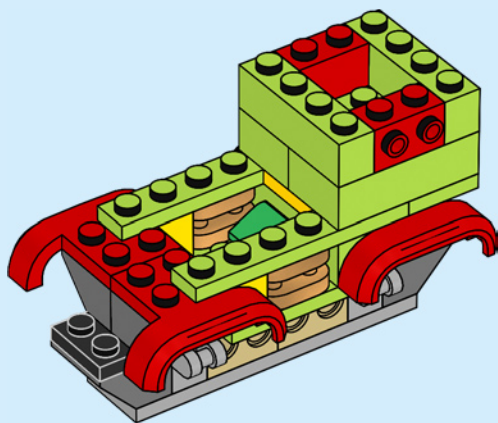

17

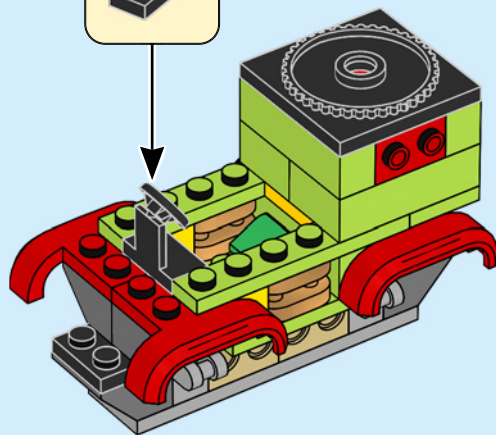



1x



1x

18

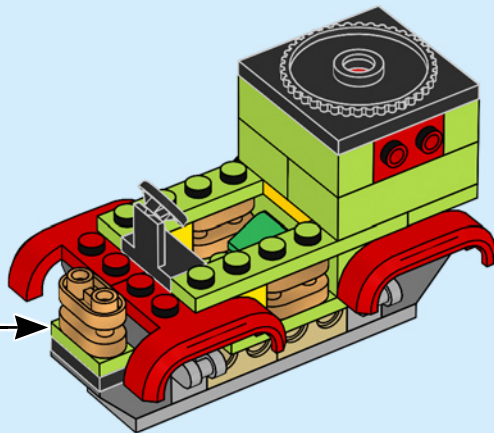
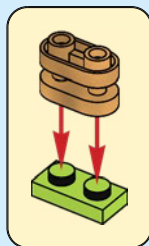

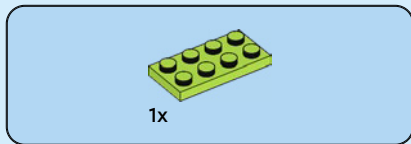

19

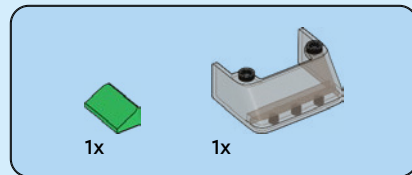
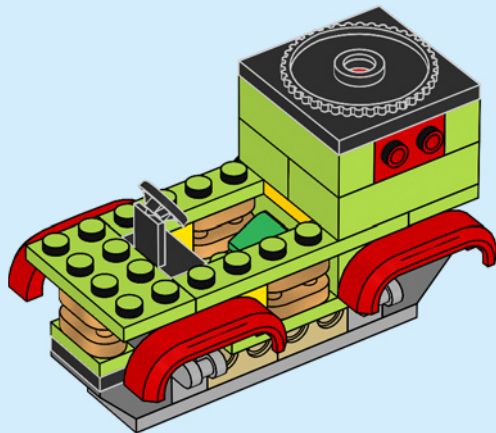

20

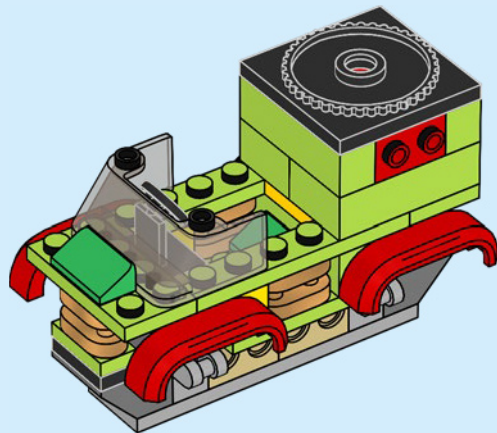

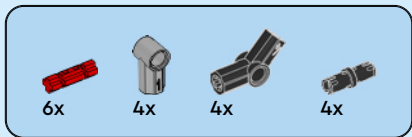
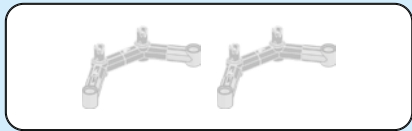

21

1

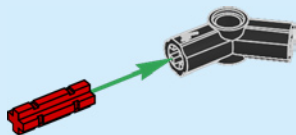

2

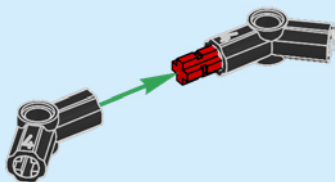

3

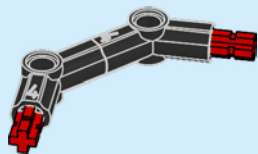

4

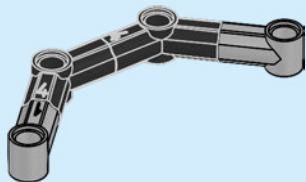

5

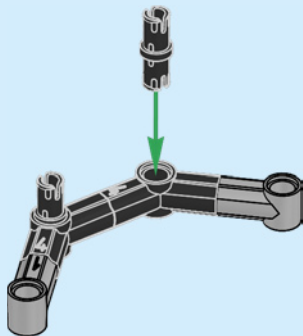

2x

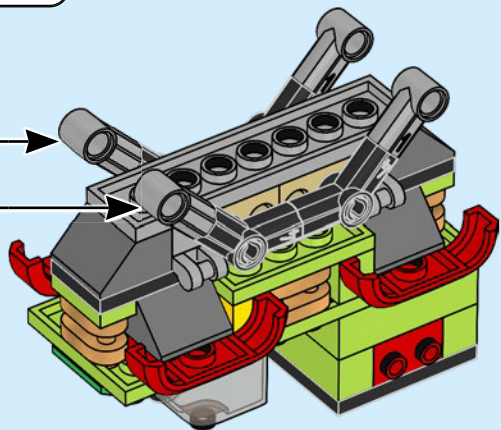
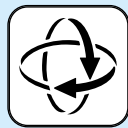

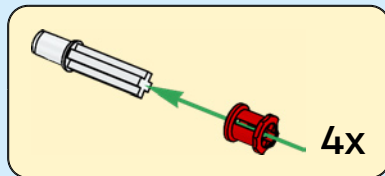
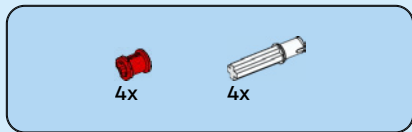

22

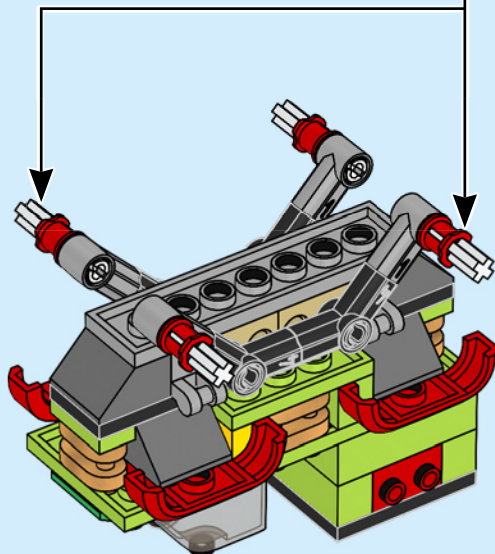



2x

23

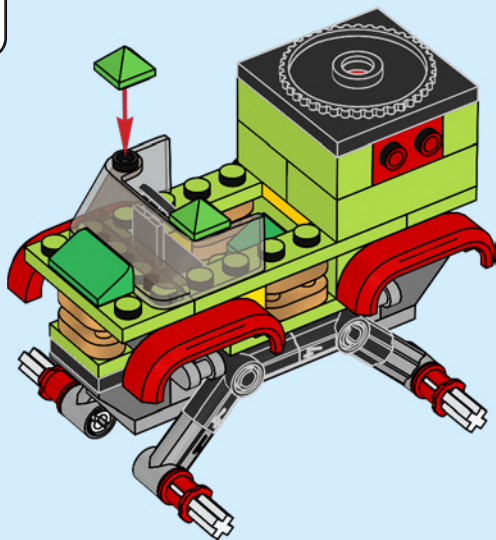
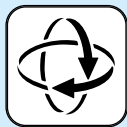

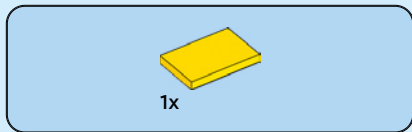

24

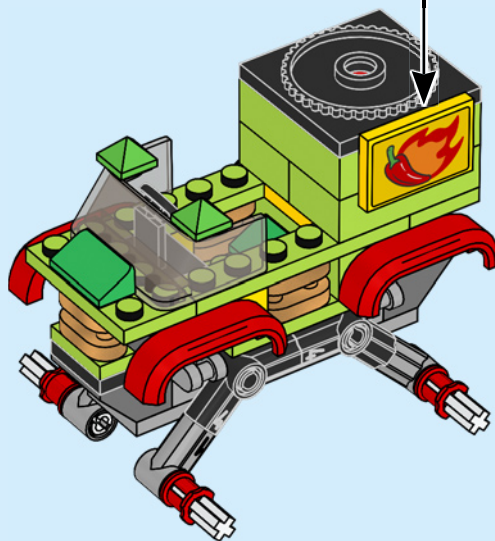
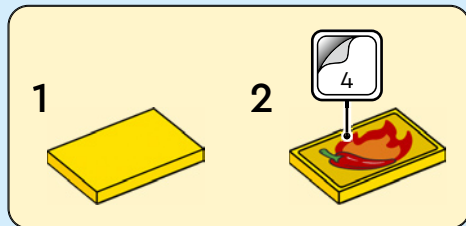

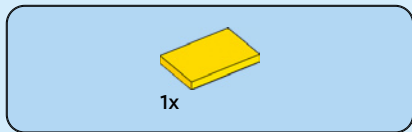

25

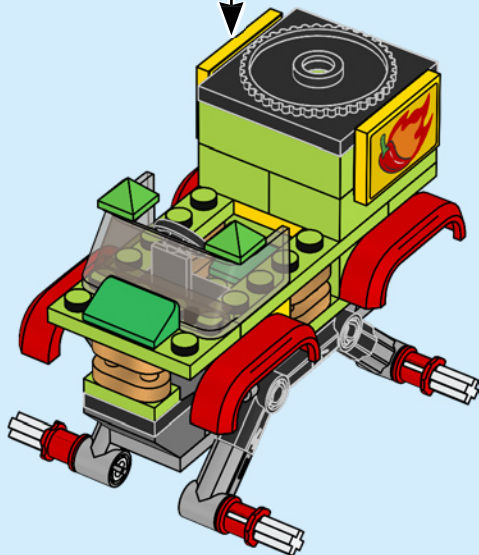
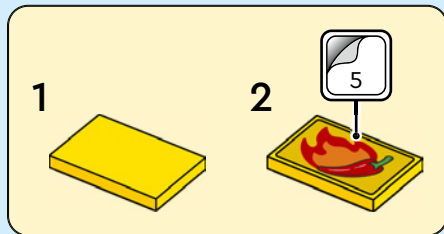

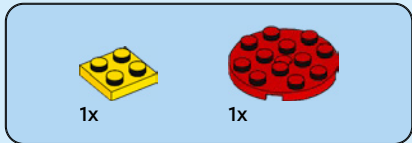
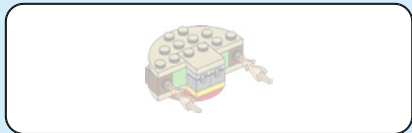

26

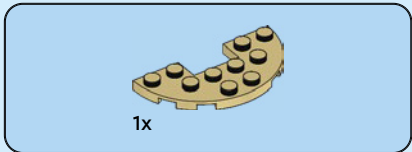
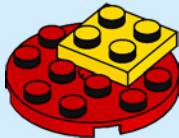

27



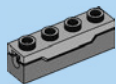

2x

28

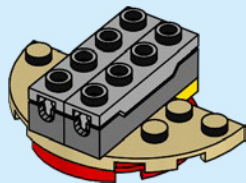

2x

29

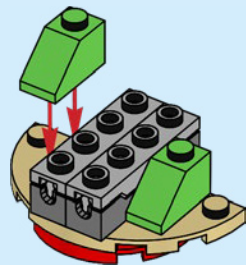

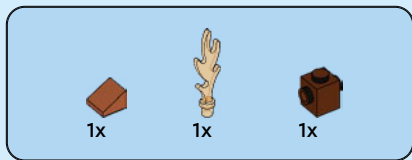

30

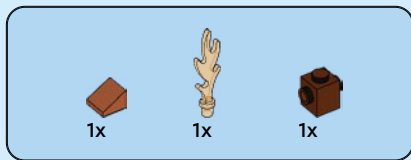
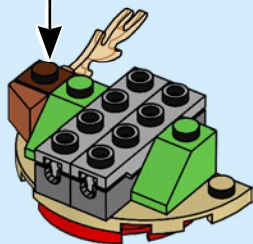
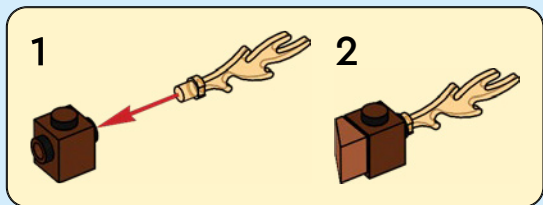

31

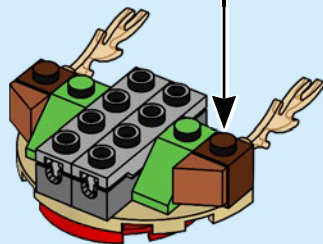
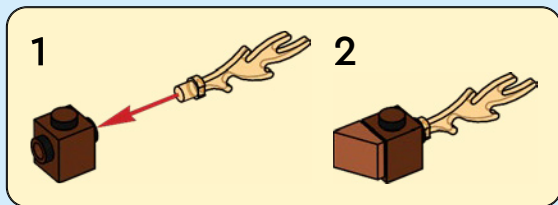

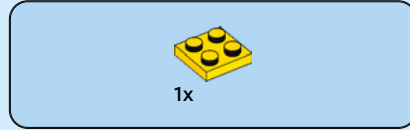
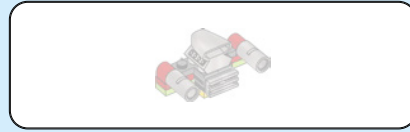

34



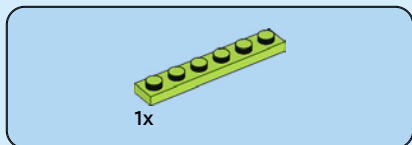

35

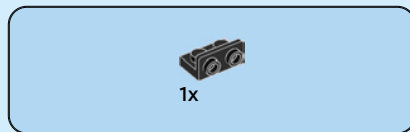
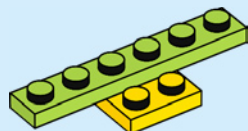

36

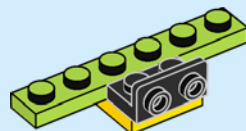



2x

37

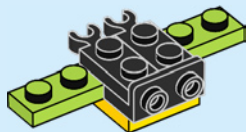

1x

38

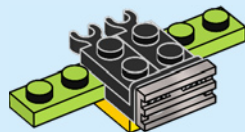



2x

39

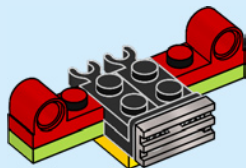

2x

40

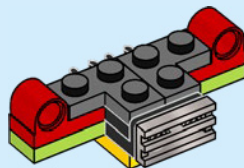



2x

41

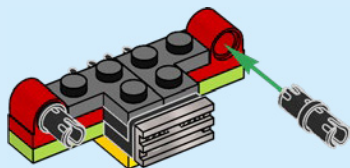



2x

42

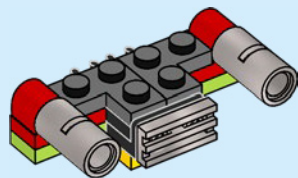

1x

43

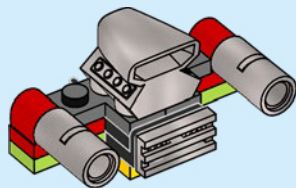

44

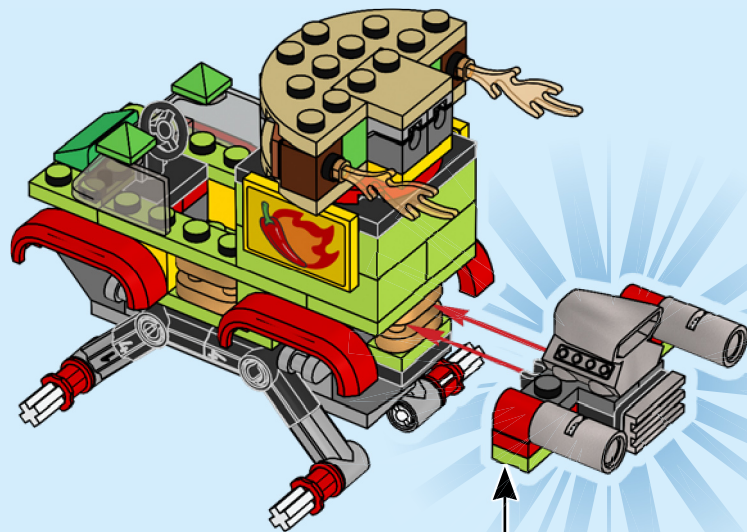

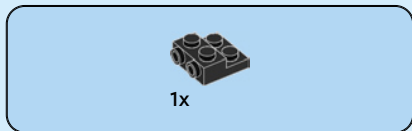

45

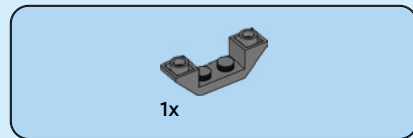
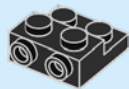

46

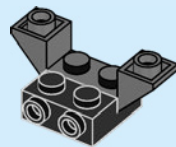



2x

47

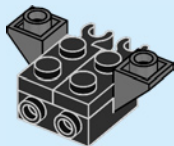

1x



1x

48





1x



1x

49

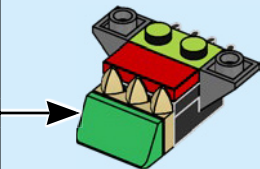
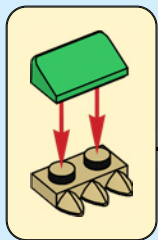

2x

50

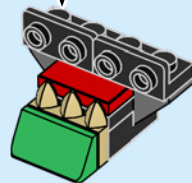
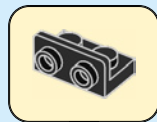



1x

51

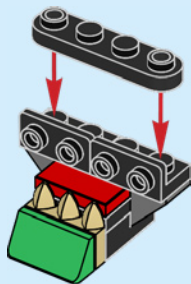



2x



1x

52

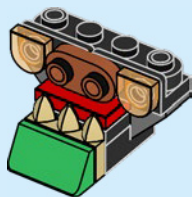

1x



2x

53

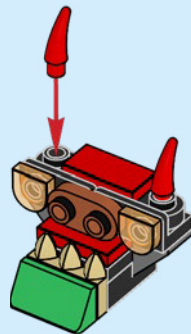

54

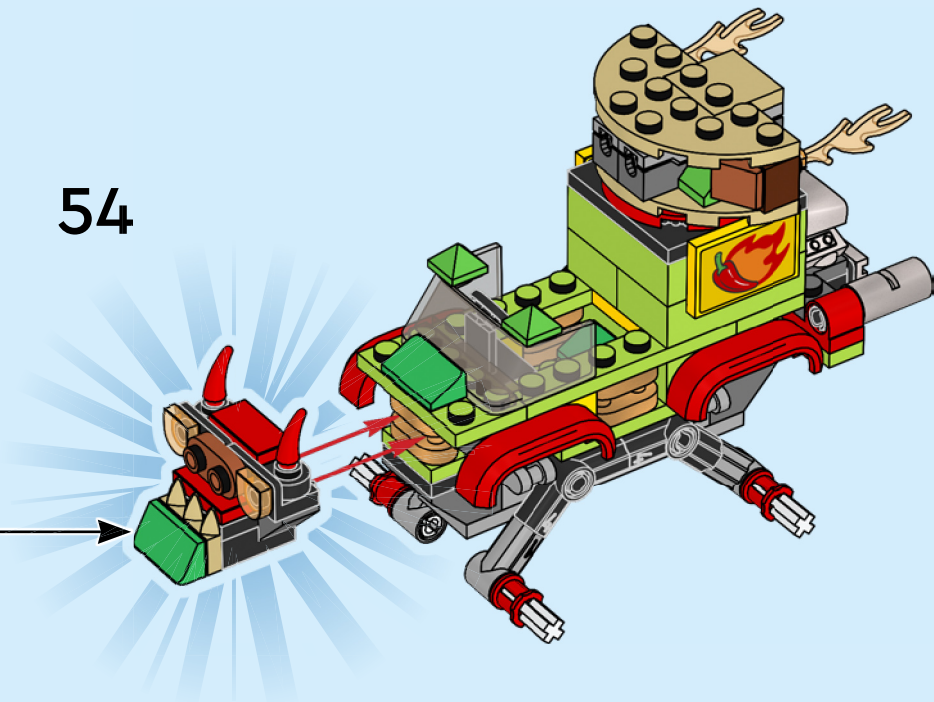

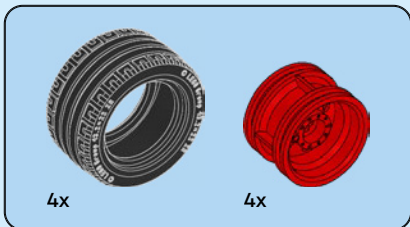

55

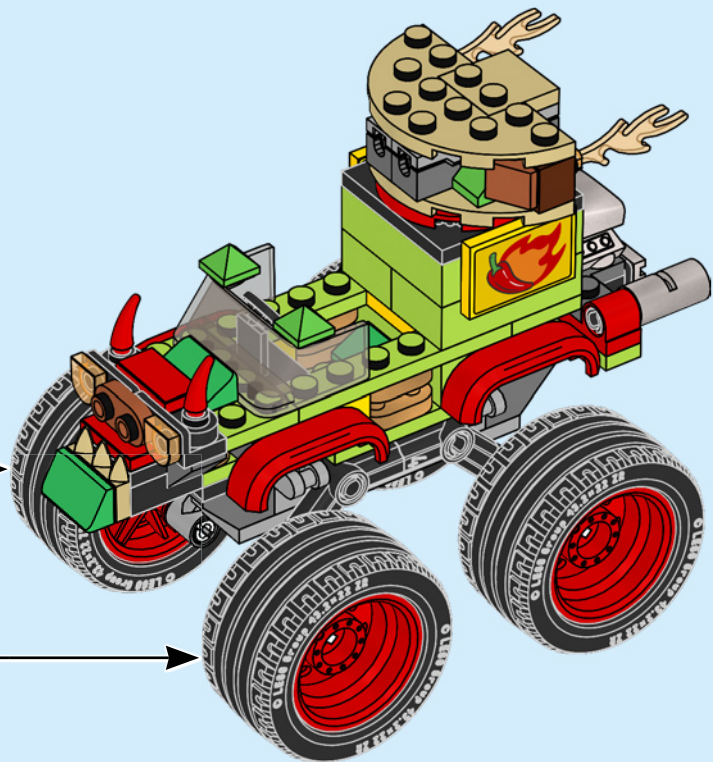
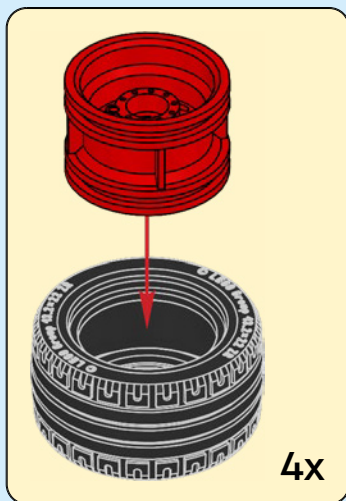



1x

56

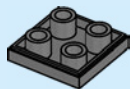

2x

57

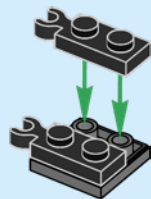



2x

58

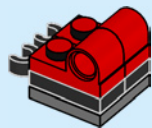

1x

59

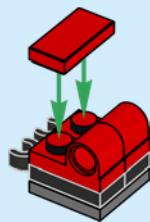



1x

60

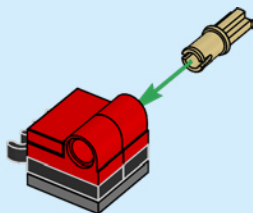

1x



1x

61

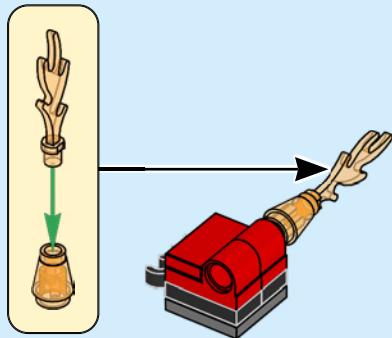



1x

62

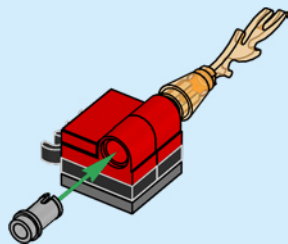

1x

63

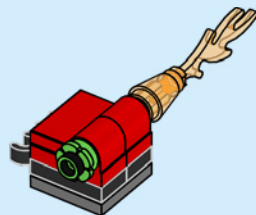

64

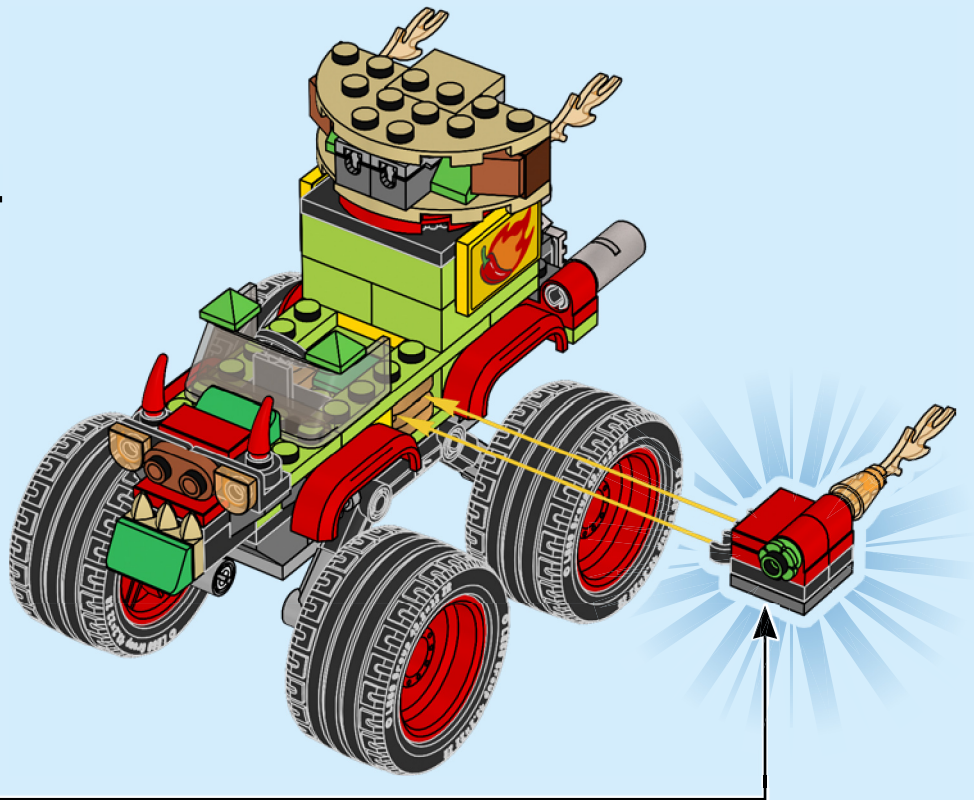



1x

65

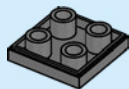

2x

66

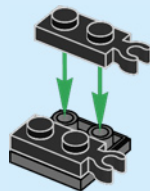



2x

67

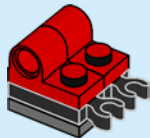

1x

68

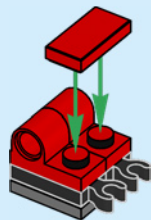



1x

69

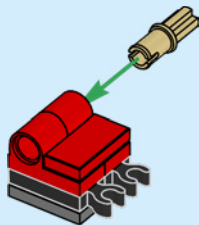

1x



1x

70

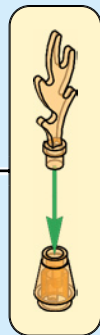
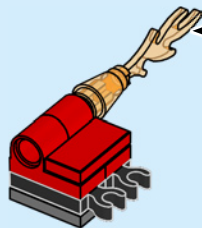



1x

71

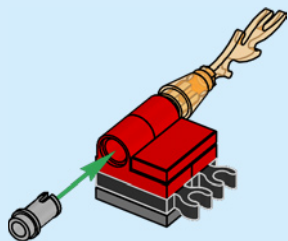

1x

72

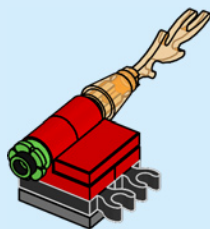

73

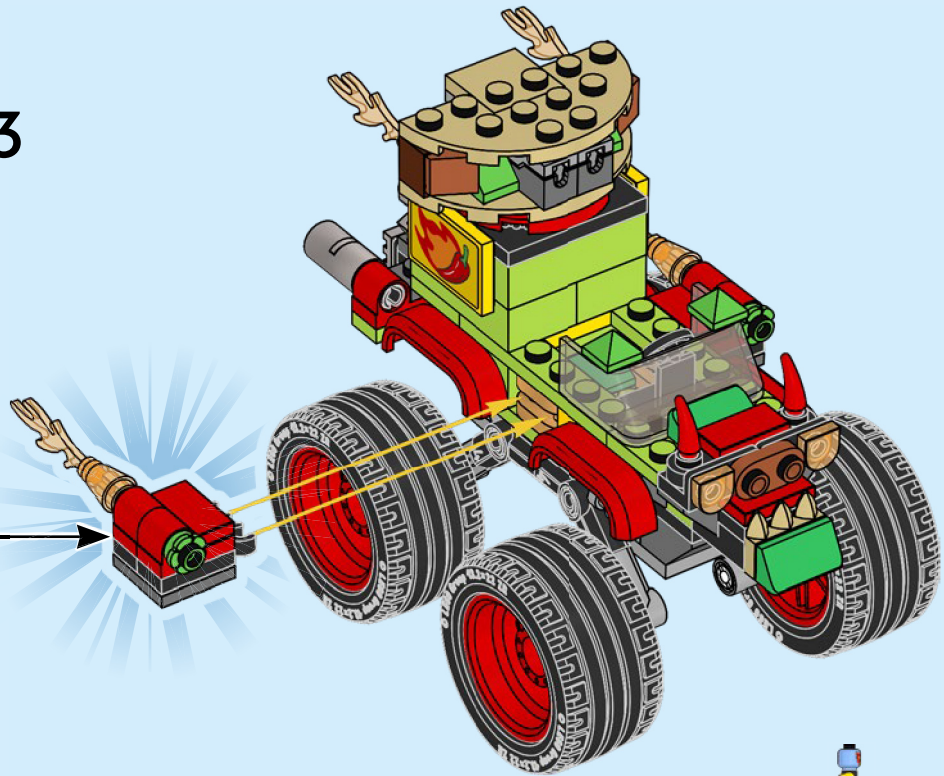

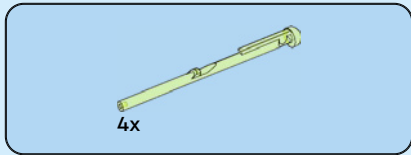

74

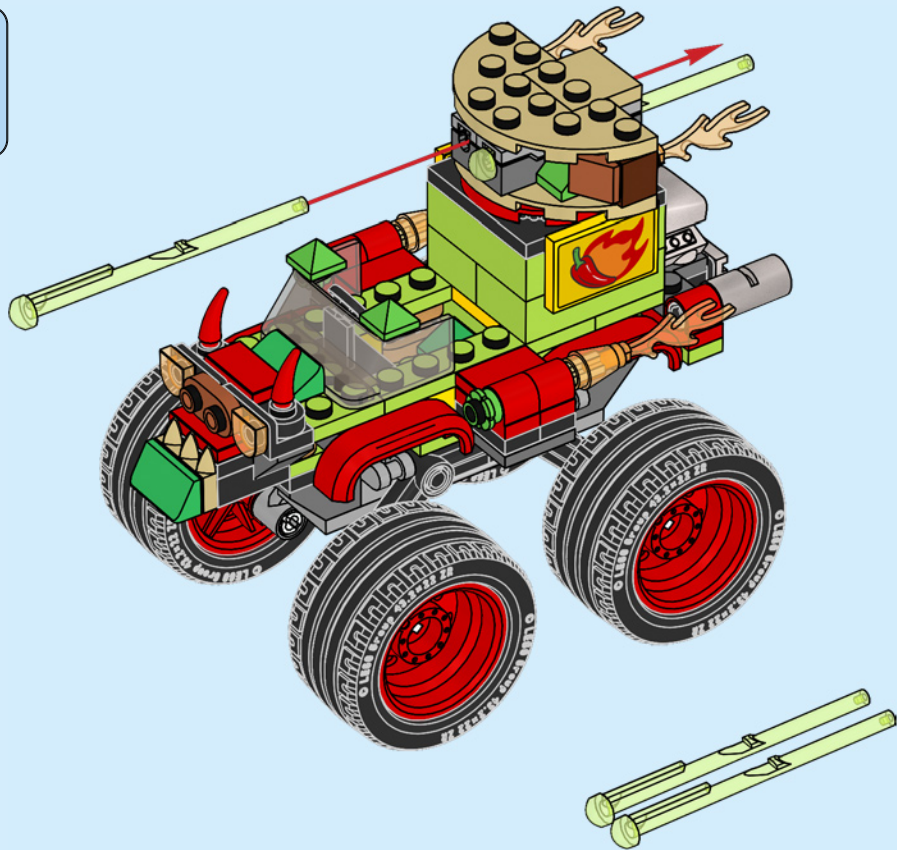



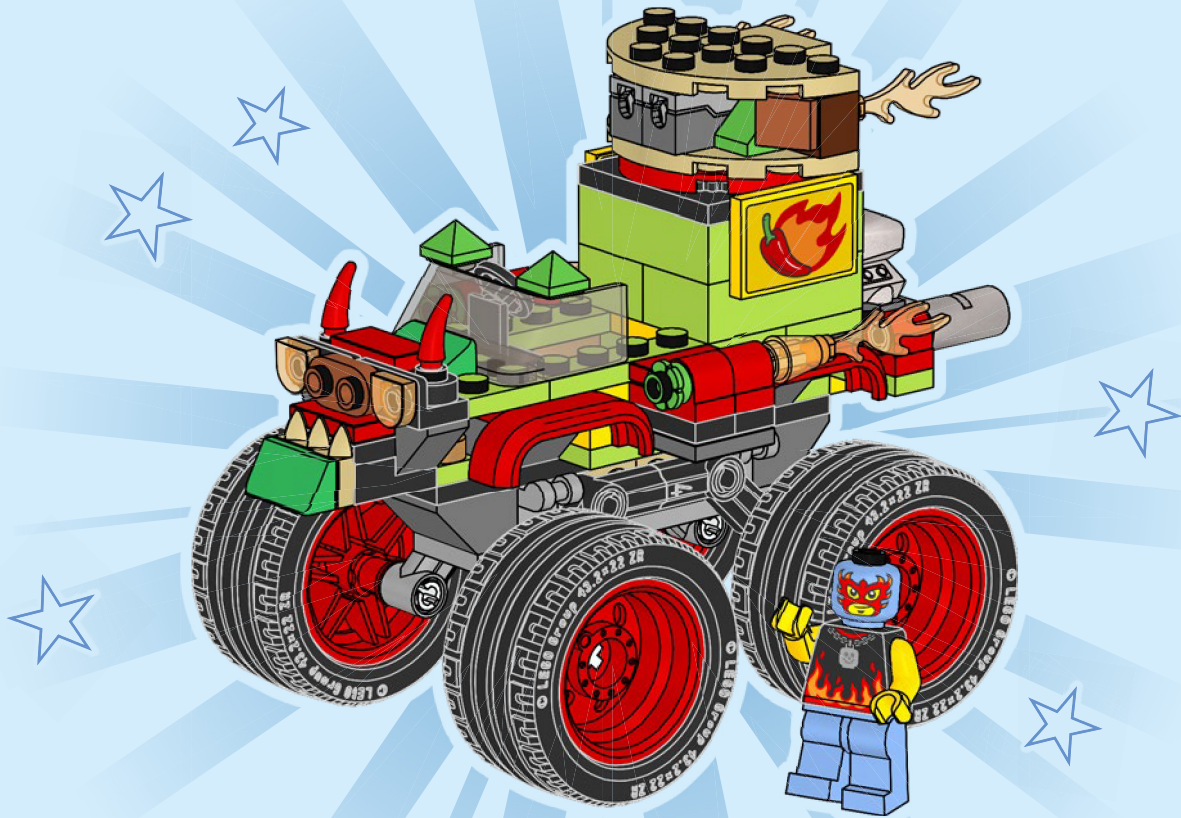

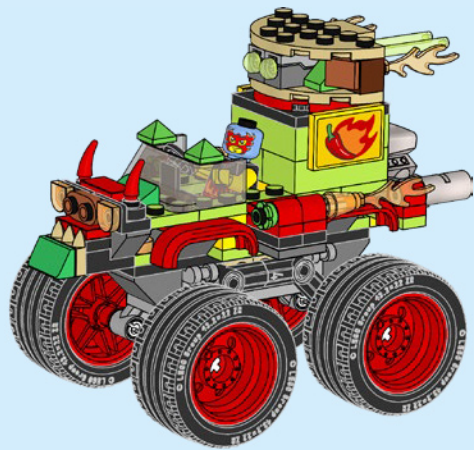
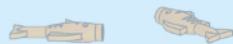
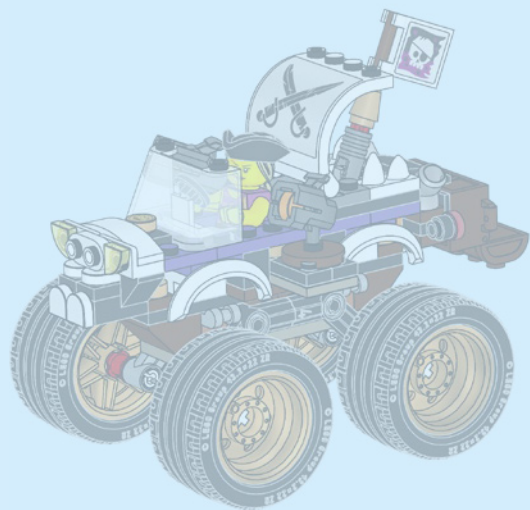



CITY



PLAY IT IN
SPIEL DAMIT IN
JOUÉ DANS
GIOCA IN
JUEGA CON EL MODELO EN
JOGA EM
可在下方游戏中玩乐
BAW SIŃ
ZAHRAJ SI V
JÁTSZD LE EBBEN:
JOACĂ-L ÎN
ИГРАЙТЕ В
ROTAĻĪJIES
MĀNGI SEE SISSE
ŽAISK



60395



60396



60397



CITY

60368



60377



60378



60379





Rebuild
the
world™

