

# BIONICLE®



TOA  
IRUINI  
SPECIAL EDITION

8762





1

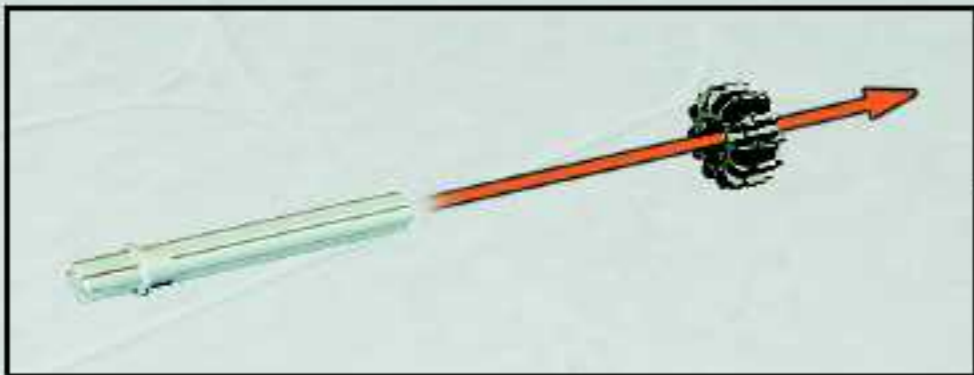
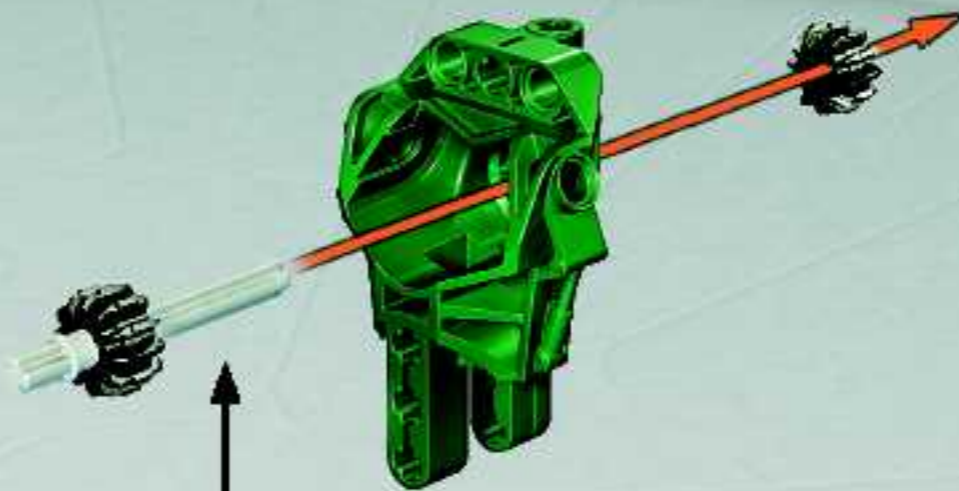

**2**



**3**

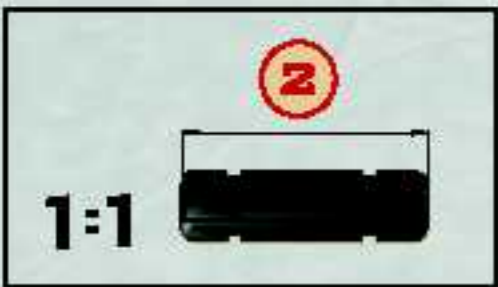
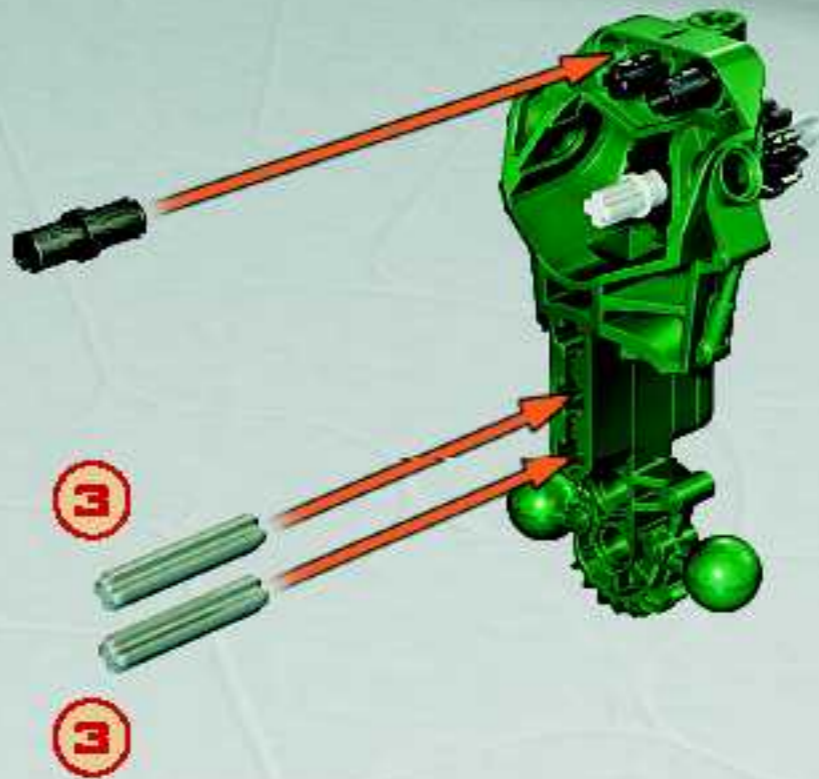

4

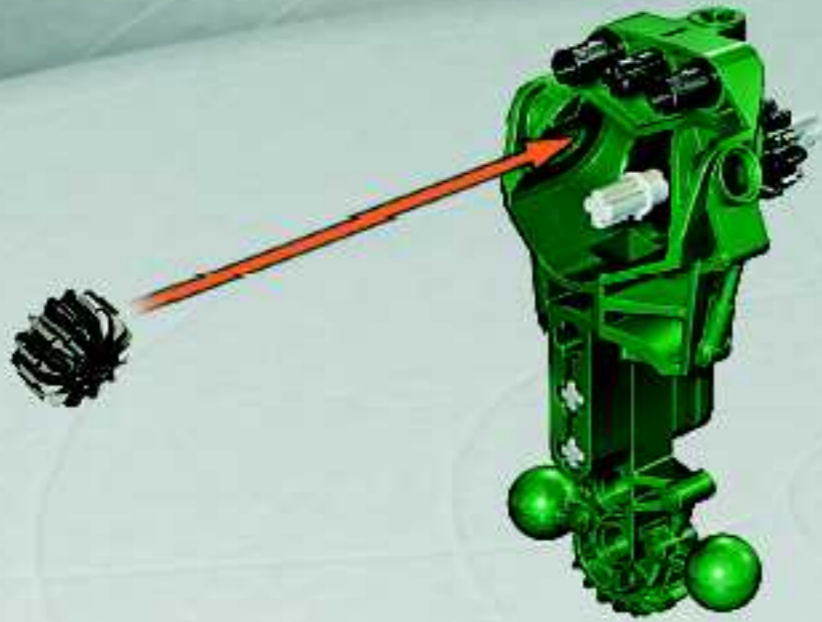

5



1



2



3



6

4



2x

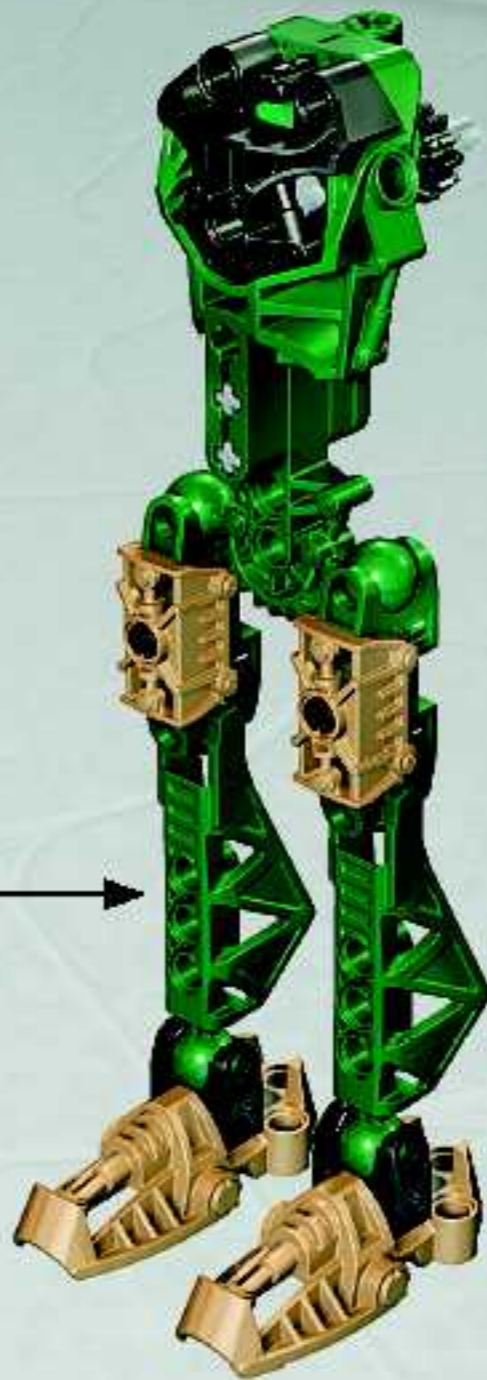

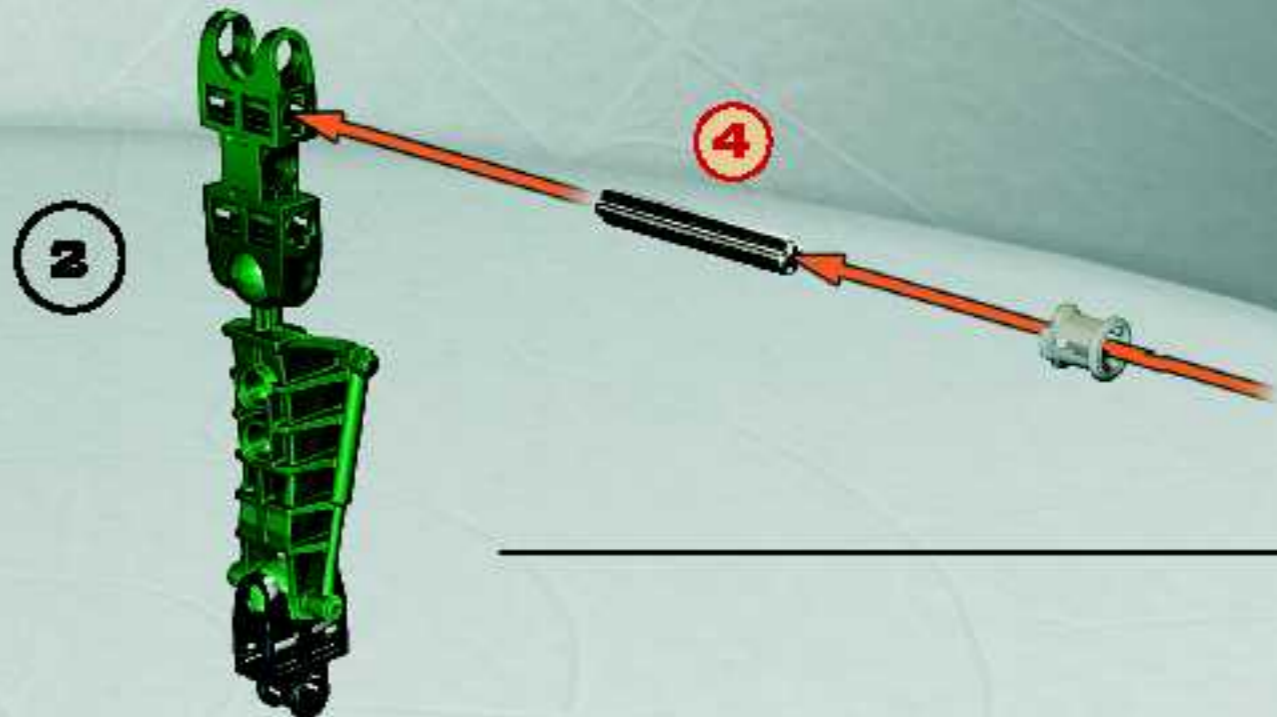
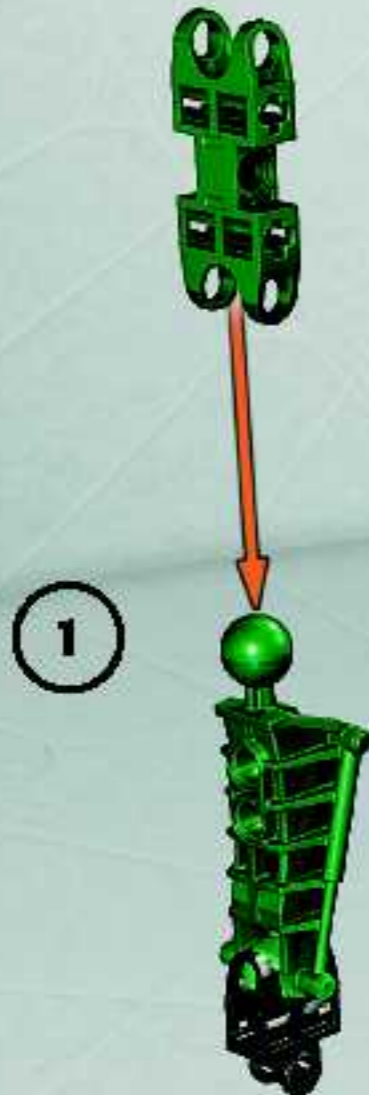



7

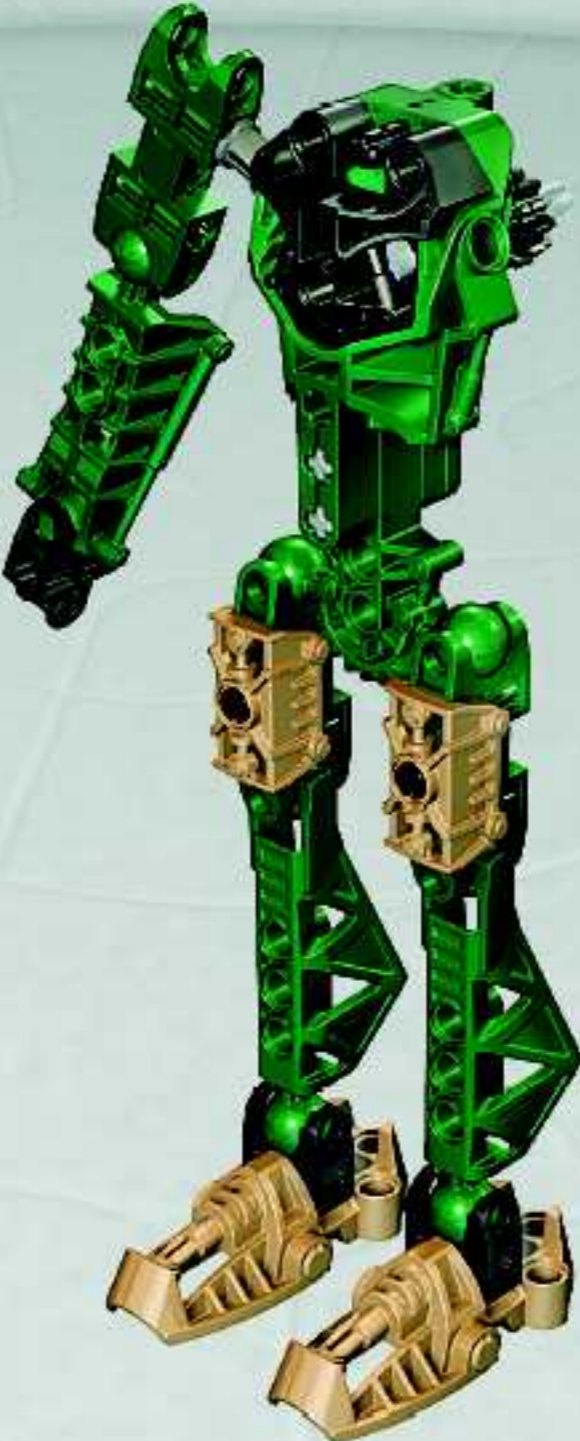

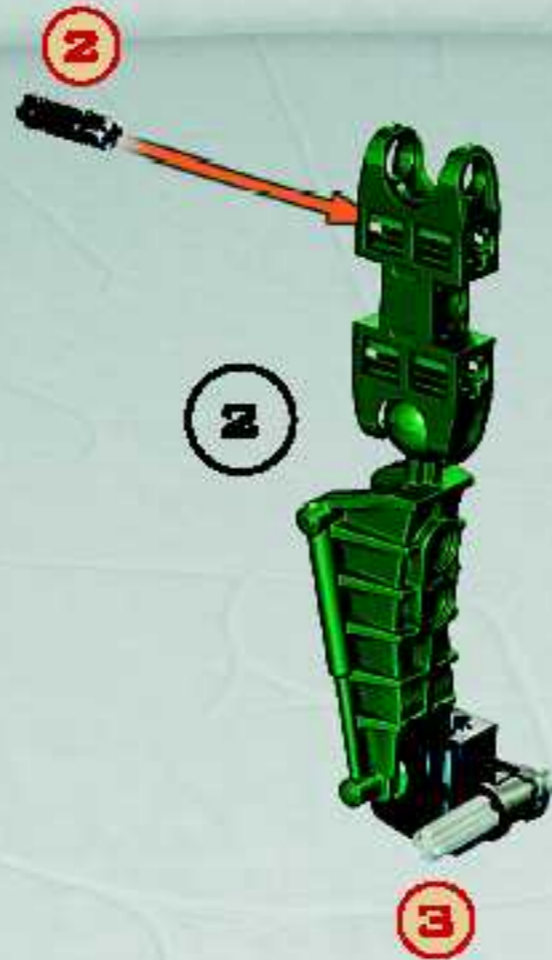
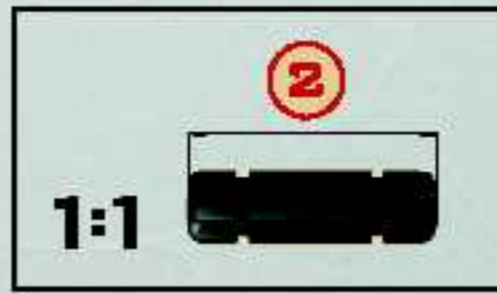
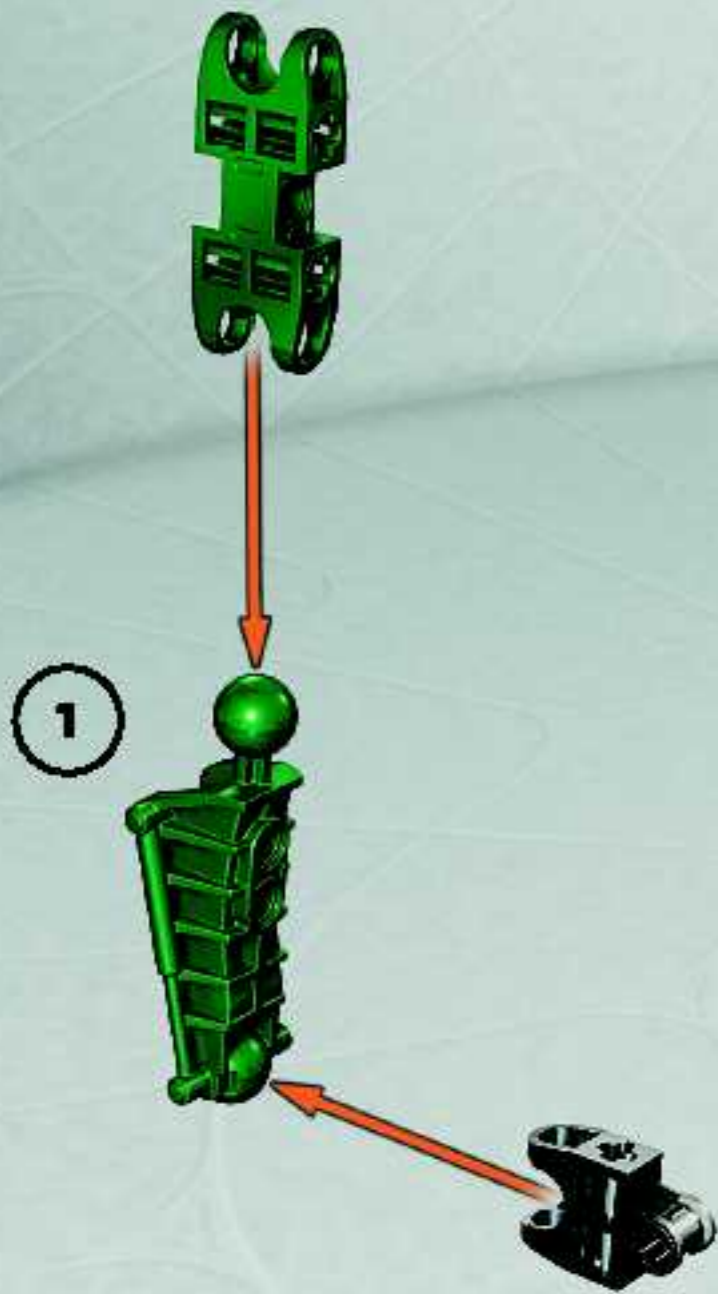

8



9



10

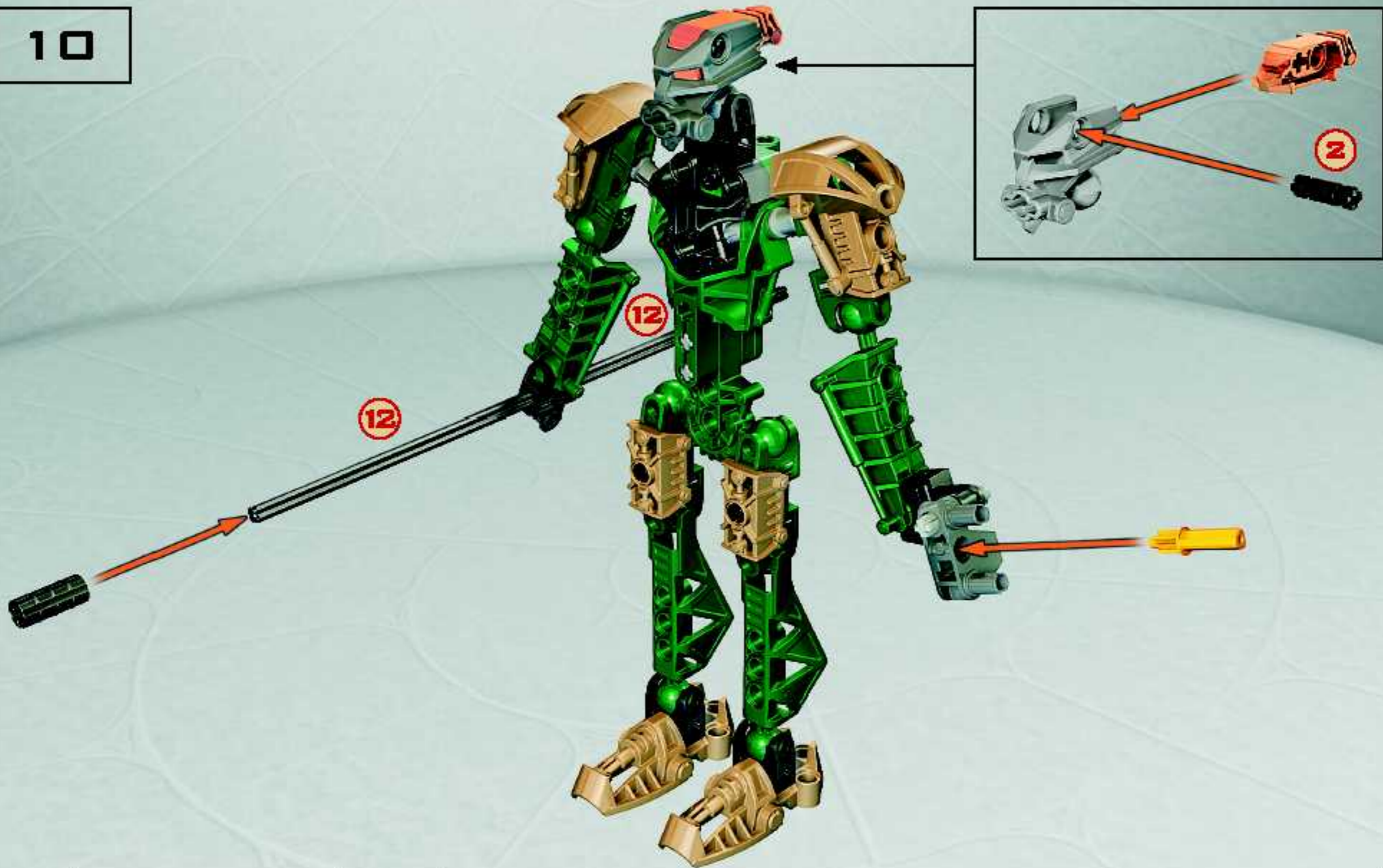

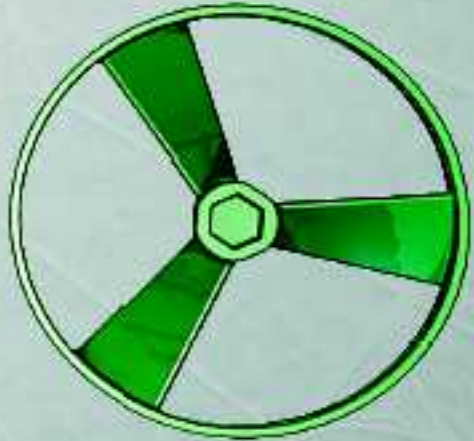



# club

**FREE!** Each LEGO Magazine features...

- Awesome creations by Kids like you!
- Cool Comics & Stories
- Building Tips & Ideas
- Special Offers & Contest to WIN Prizes!

## GRATUIT !

- Chaque Magazine LEGO offre...
- Des créations épatantes par des jeunes comme toi !
  - Des bandes dessinées et des récits super cool
  - Des idées de construction
  - Des offres spéciales et des concours pour gagner des prix !



Join Today! Abonne-toi dès aujourd'hui !

# 1-866-534-6258

# www.LEGOclub.com



LEGO, the LEGO logo are trademarks of/sont des marques de commerce de/The LEGO Group. ©2005 The LEGO Group.

# Win! Gagne !

### WIN LEGO® PRODUCTS

Log on to [www.acnielsen.aim.dk/LEGO](http://www.acnielsen.aim.dk/LEGO) for further instructions.

### GAGNE DES PRODUITS LEGO®

Visite [www.acnielsen.aim.dk/LEGO](http://www.acnielsen.aim.dk/LEGO) pour plus d'informations.

### ESTIMADO USARIO LEGO®

Al contestar algunas preguntas en ingles, frances, aleman o japonés en el sitio [www.acnielsen.aim.dk/LEGO](http://www.acnielsen.aim.dk/LEGO), podras participar en el sorteo de algunas valiosos premios LEGO®.

[www.acnielsen.aim.dk/LEGO](http://www.acnielsen.aim.dk/LEGO)





# SHOP at HOME

## The World's Biggest LEGO® Shop!

For a Free Catalog in the U.S.  
and Canada, call toll-free:

1-800-446-8107

Or go online:

[www.LEGOshop.com/catalog](http://www.LEGOshop.com/catalog)

Pour obtenir un Catalogue  
GRATUIT aux États-Unis  
et au Canada,  
téléphonez sans frais au :

1-800-267-5346

Ou venez en ligne sur :

[www.LEGOshop.com/catalog](http://www.LEGOshop.com/catalog)

2005

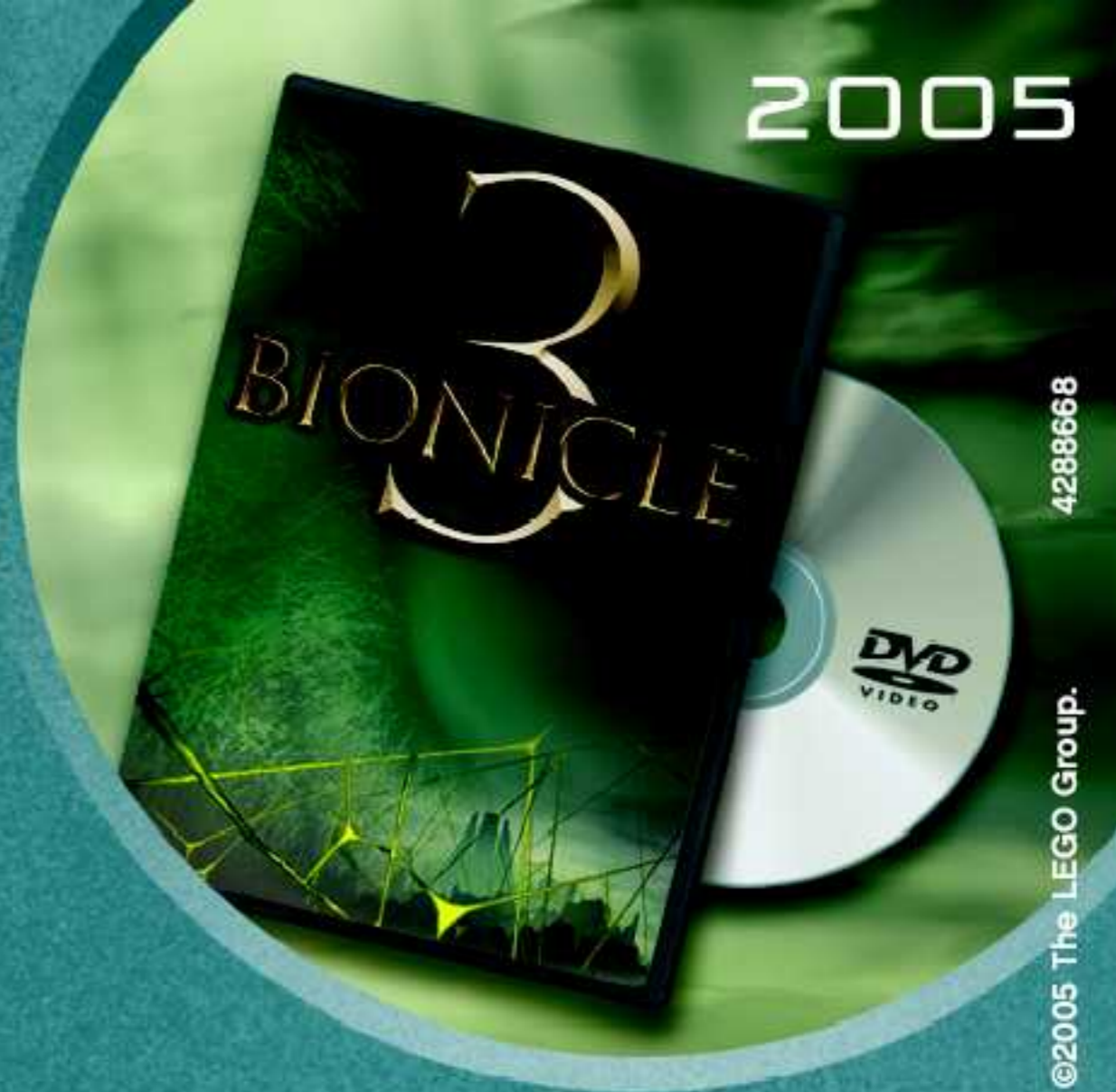

©2005 The LEGO Group. 4288668



[www.bionicle.com](http://www.bionicle.com)

