

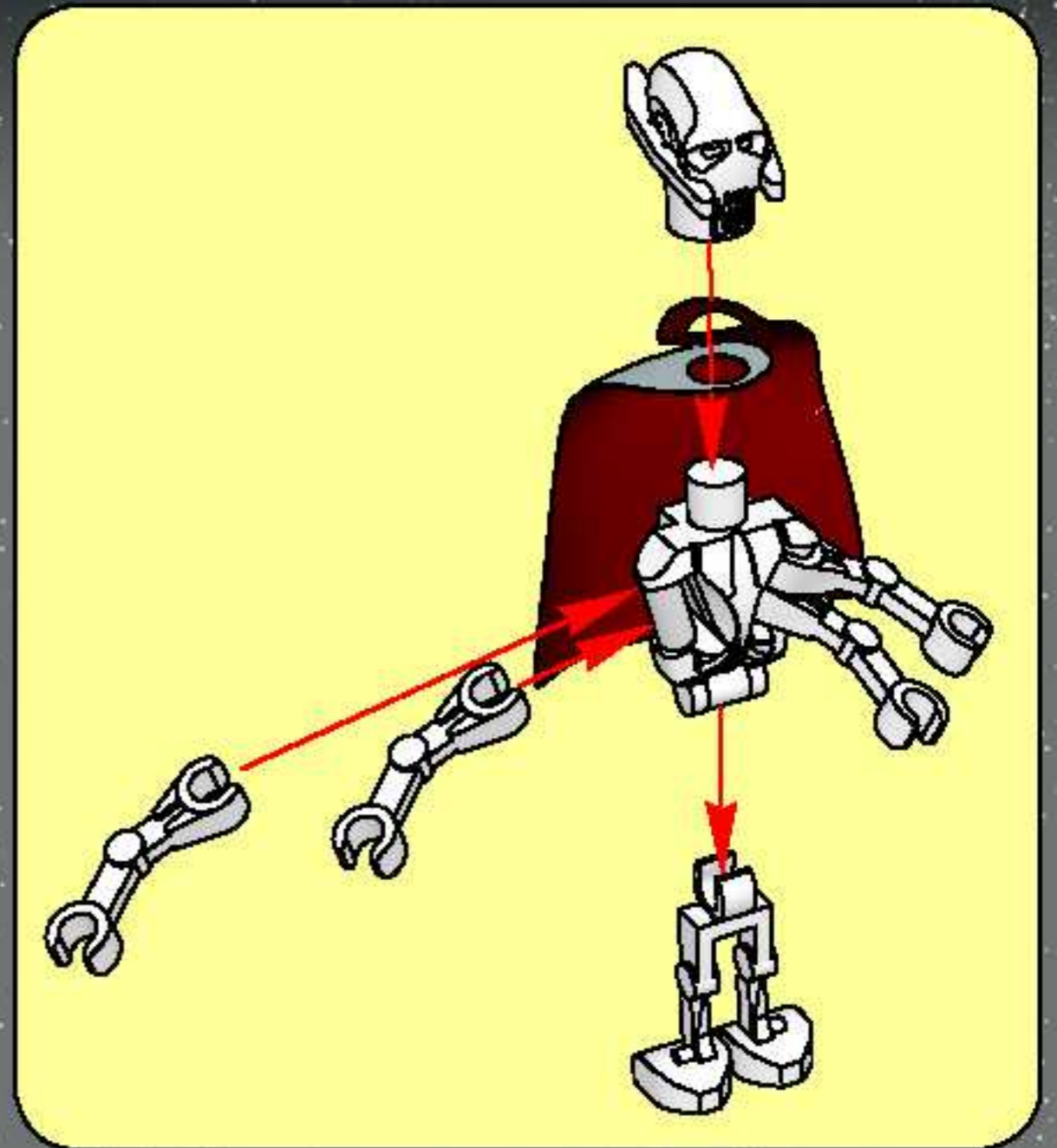

# STAR WARS

7255

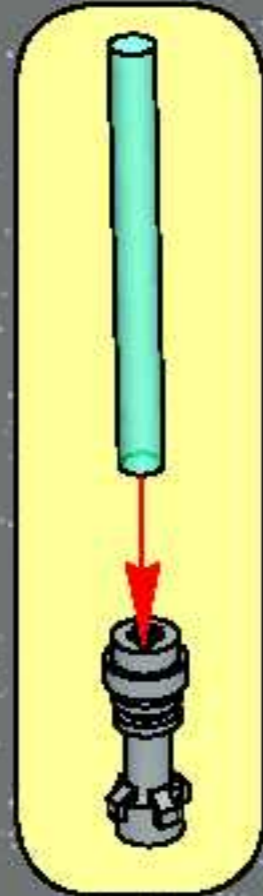

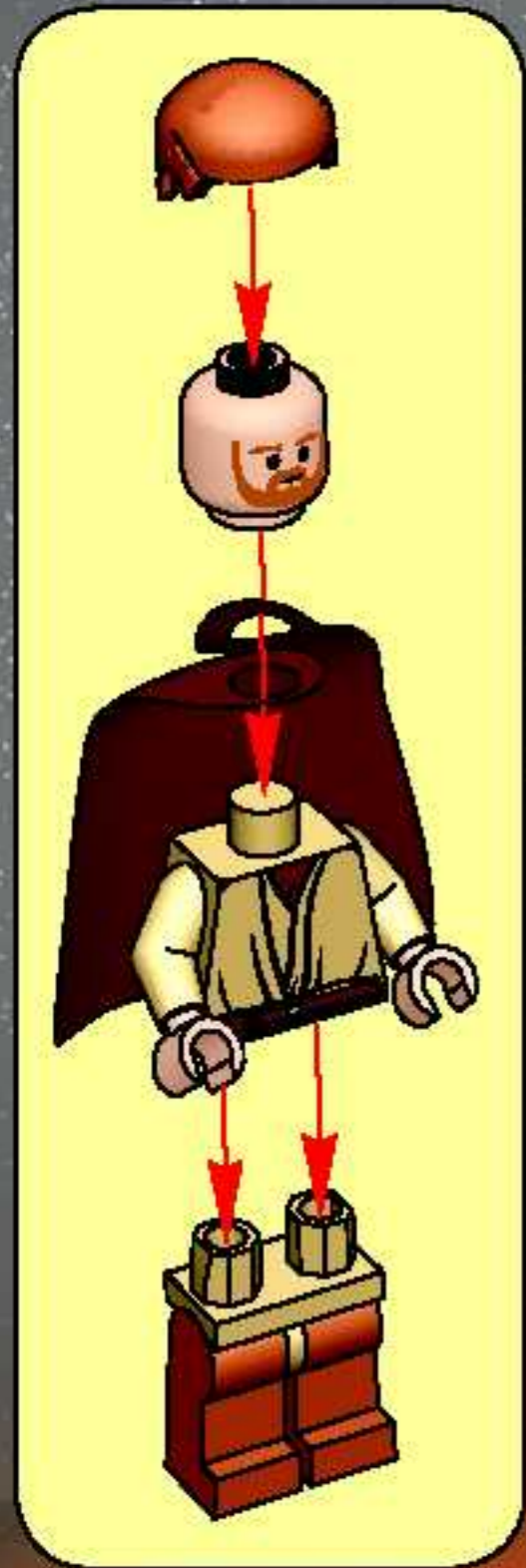



1



2



3



4



5



1

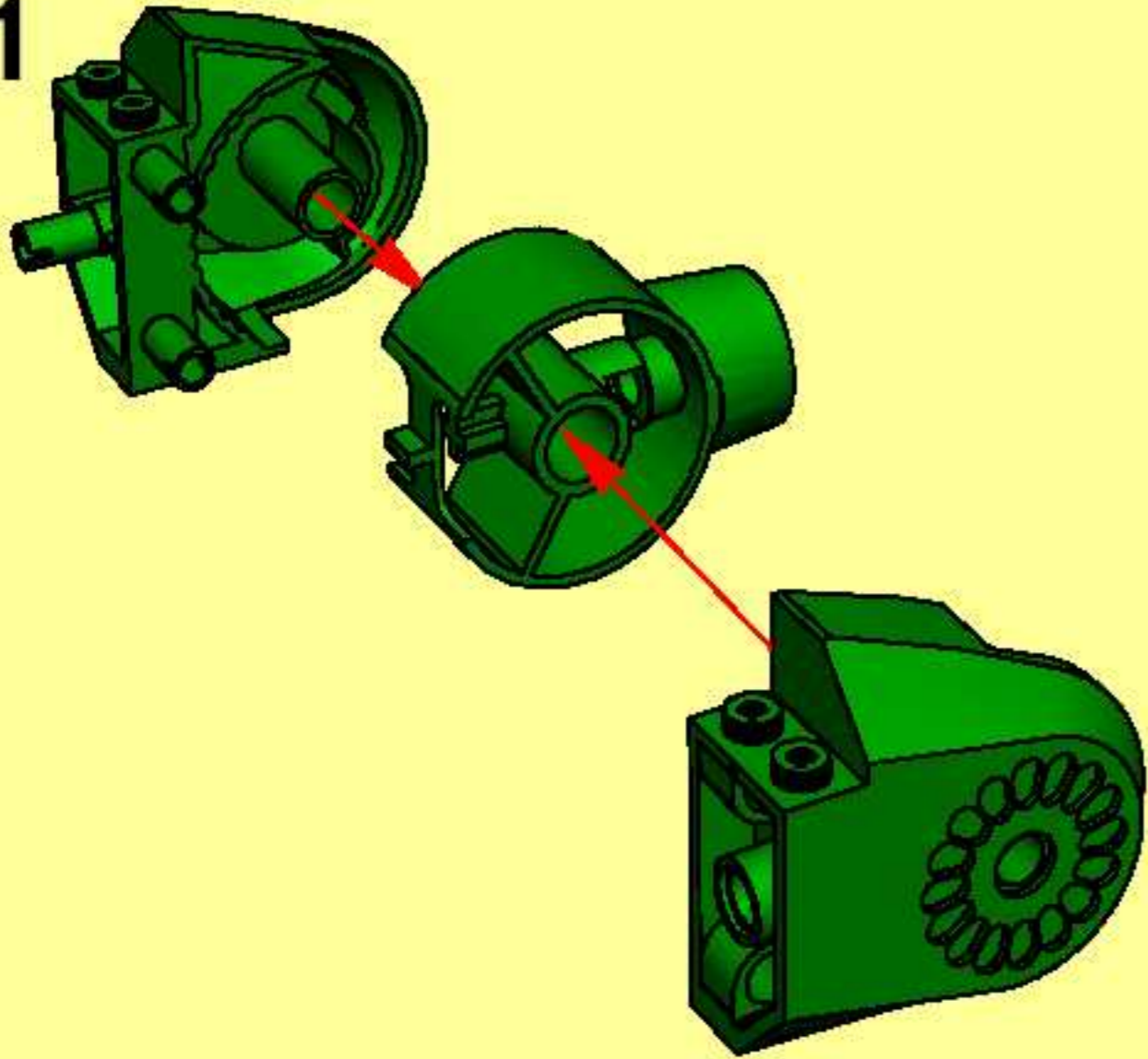

2

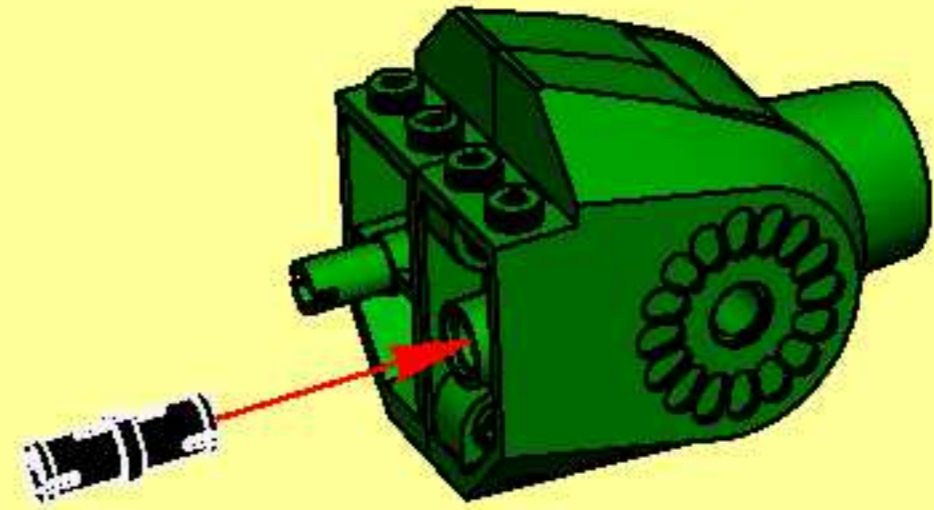

2x

6

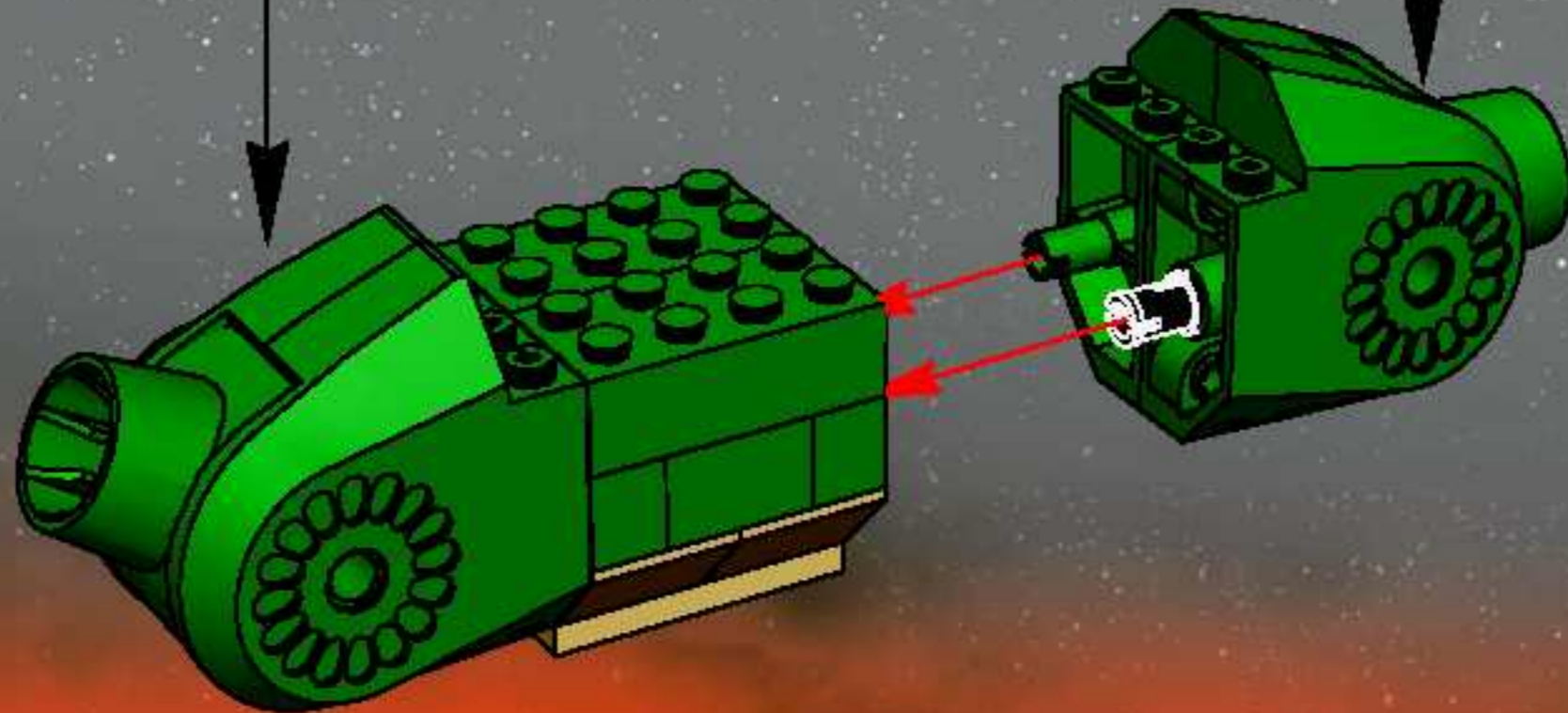

7

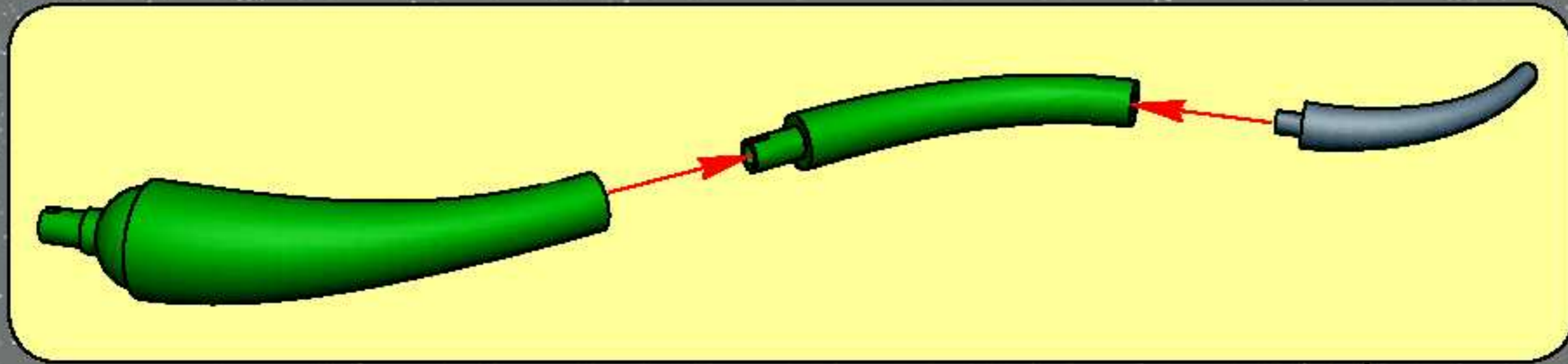
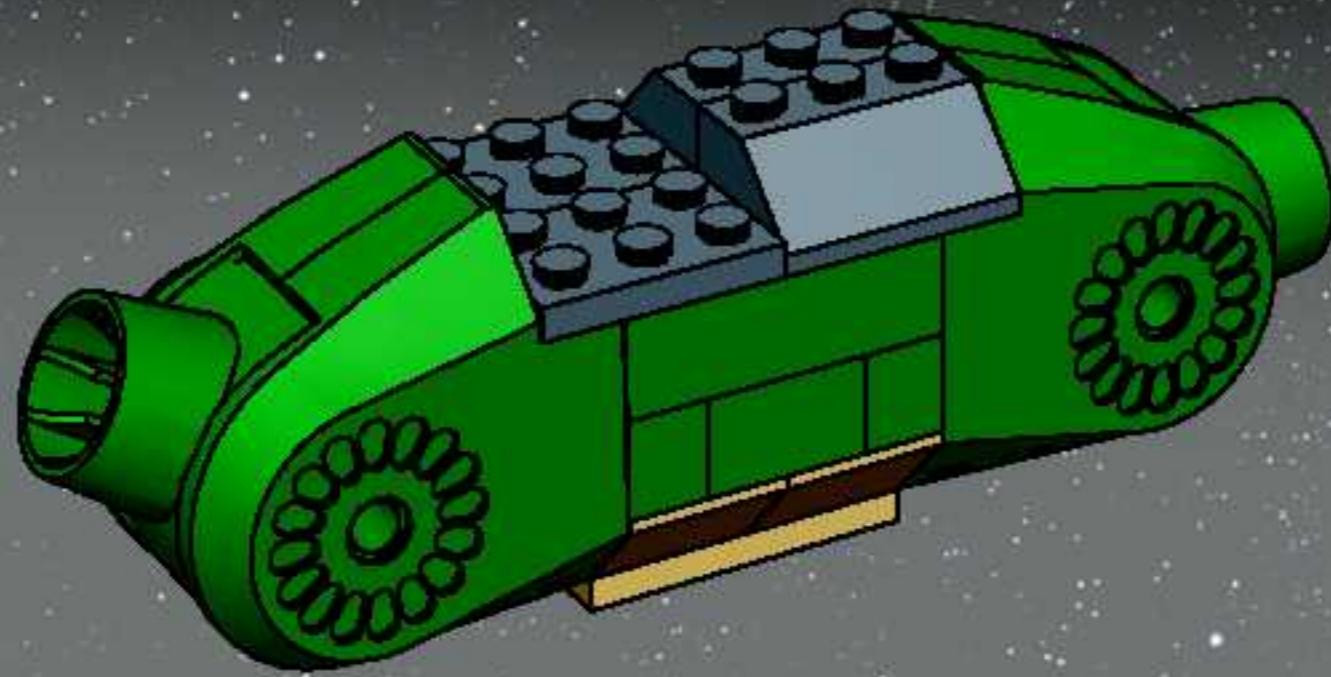

8

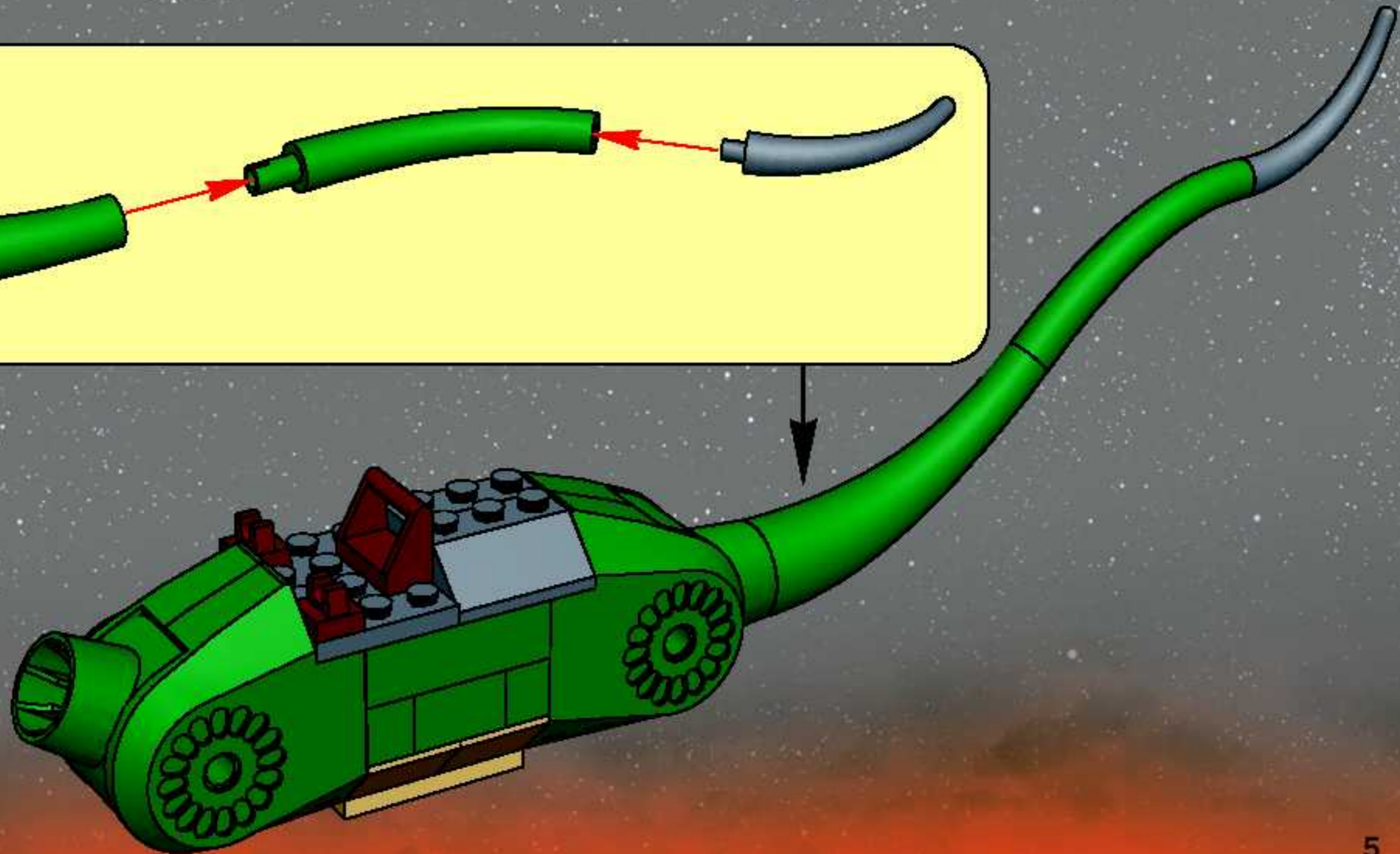

9

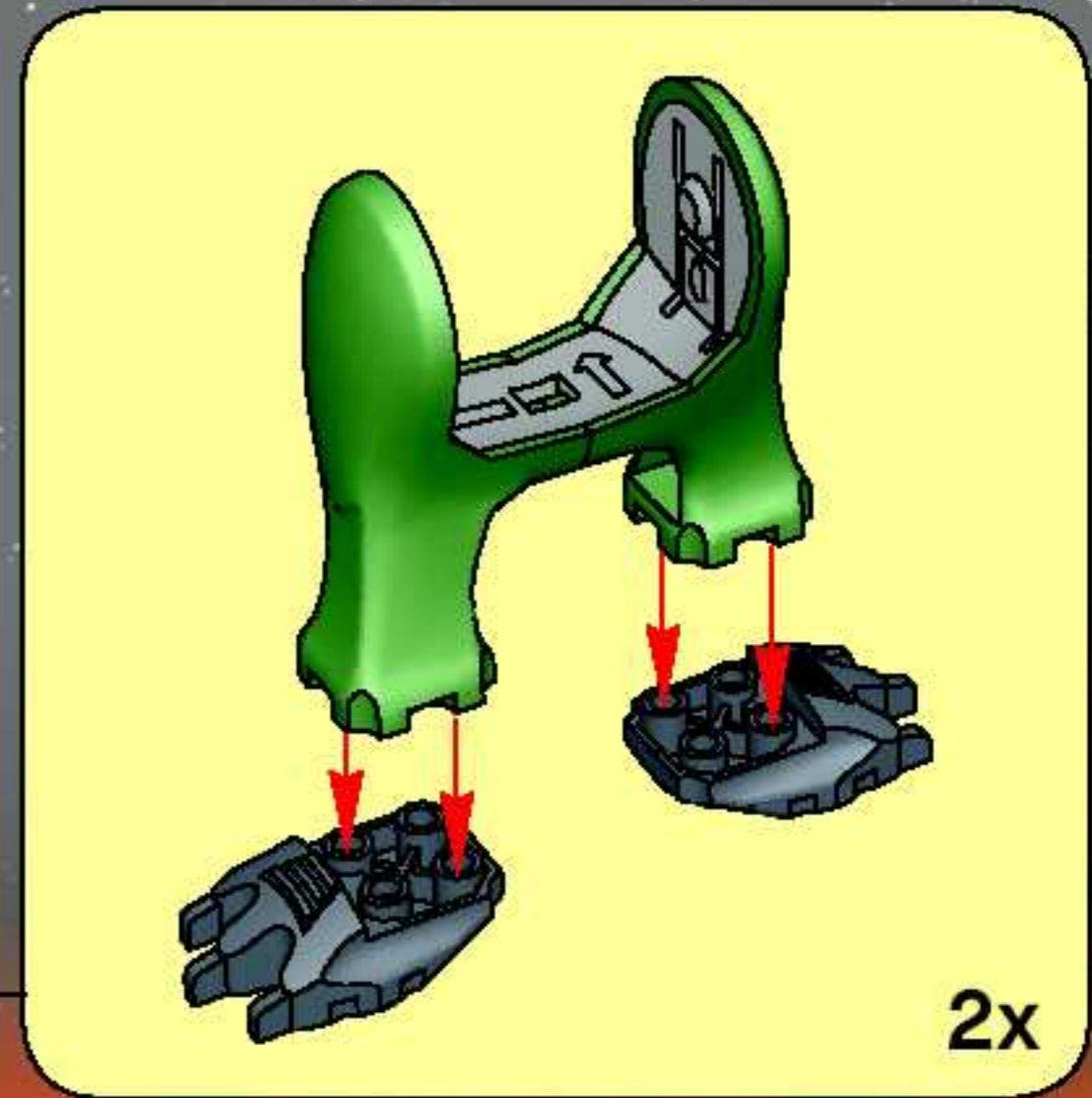
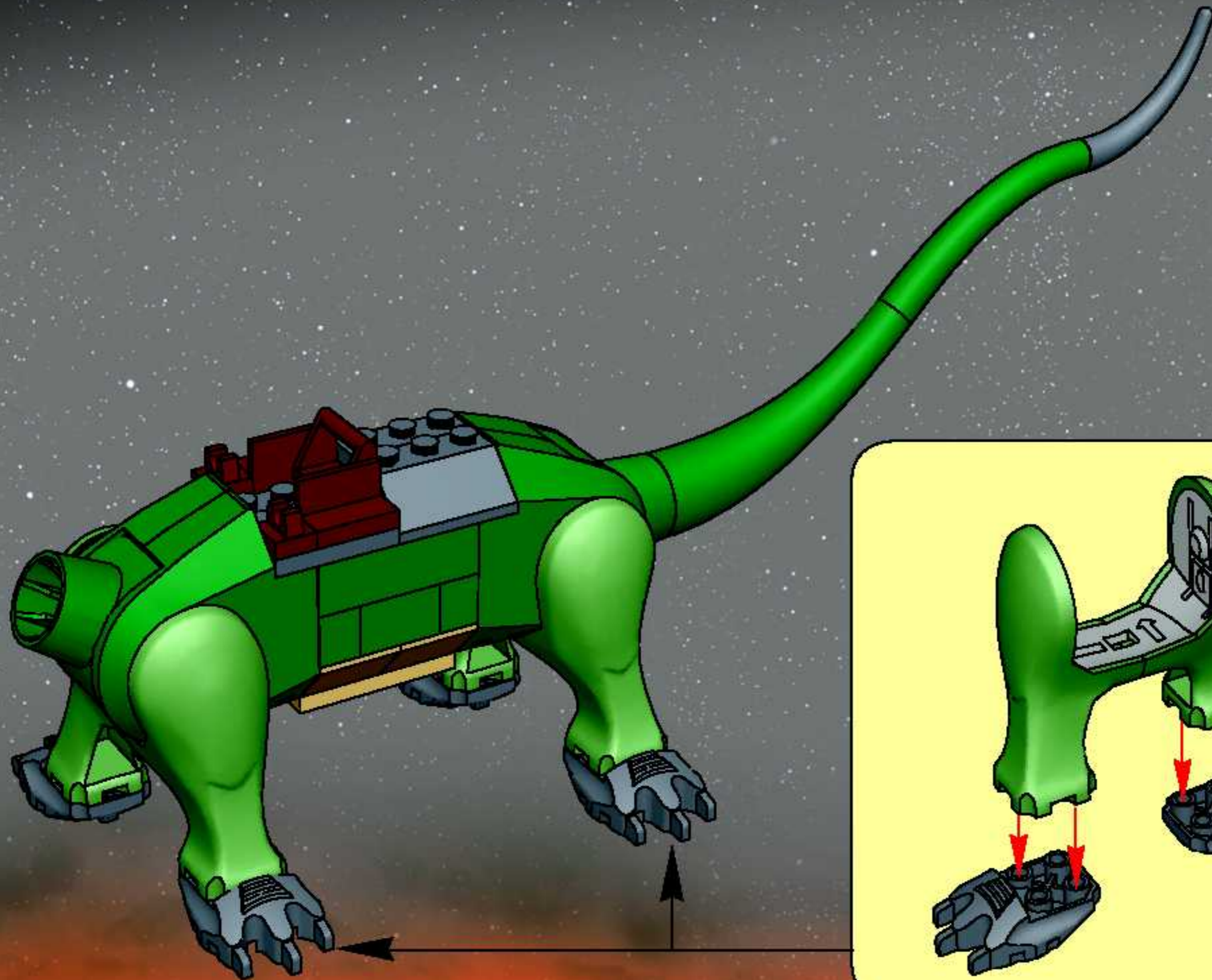

1

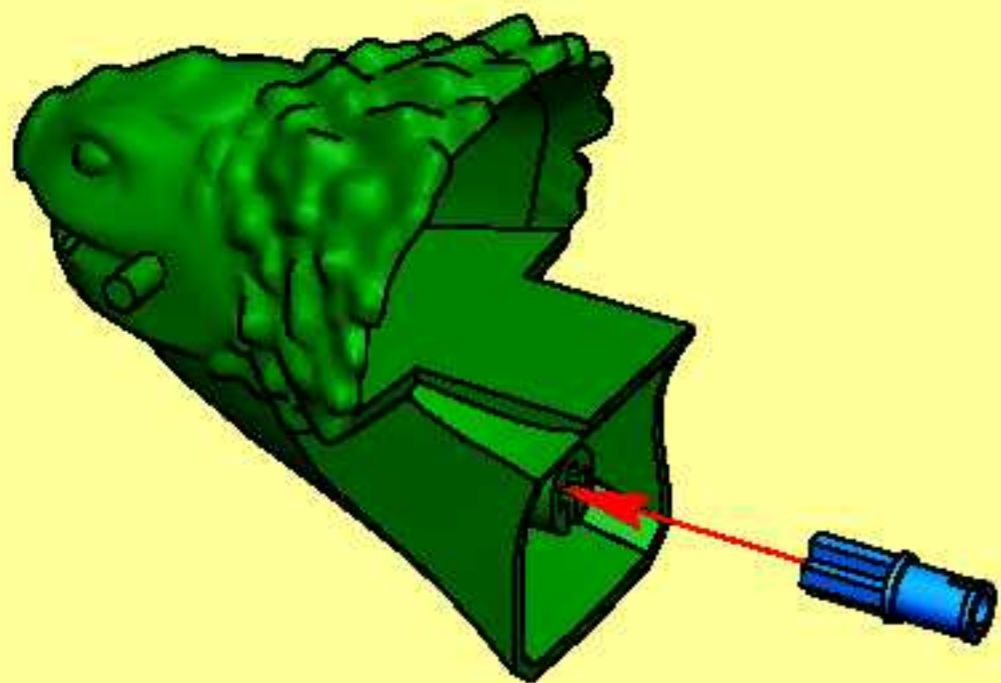

2

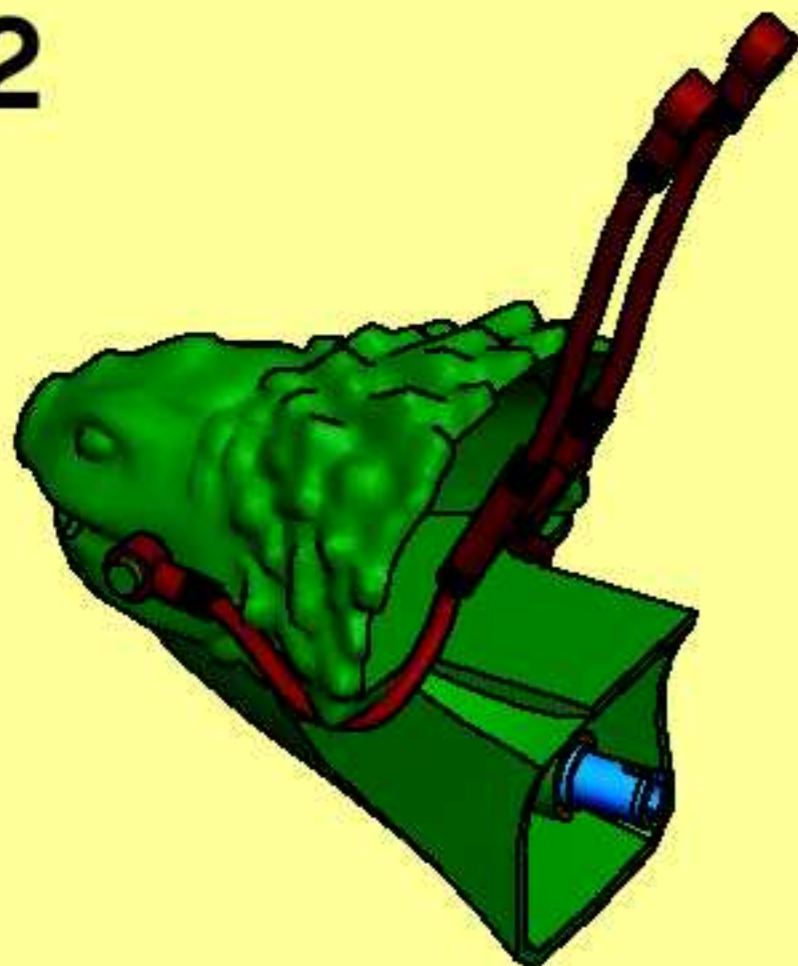

10

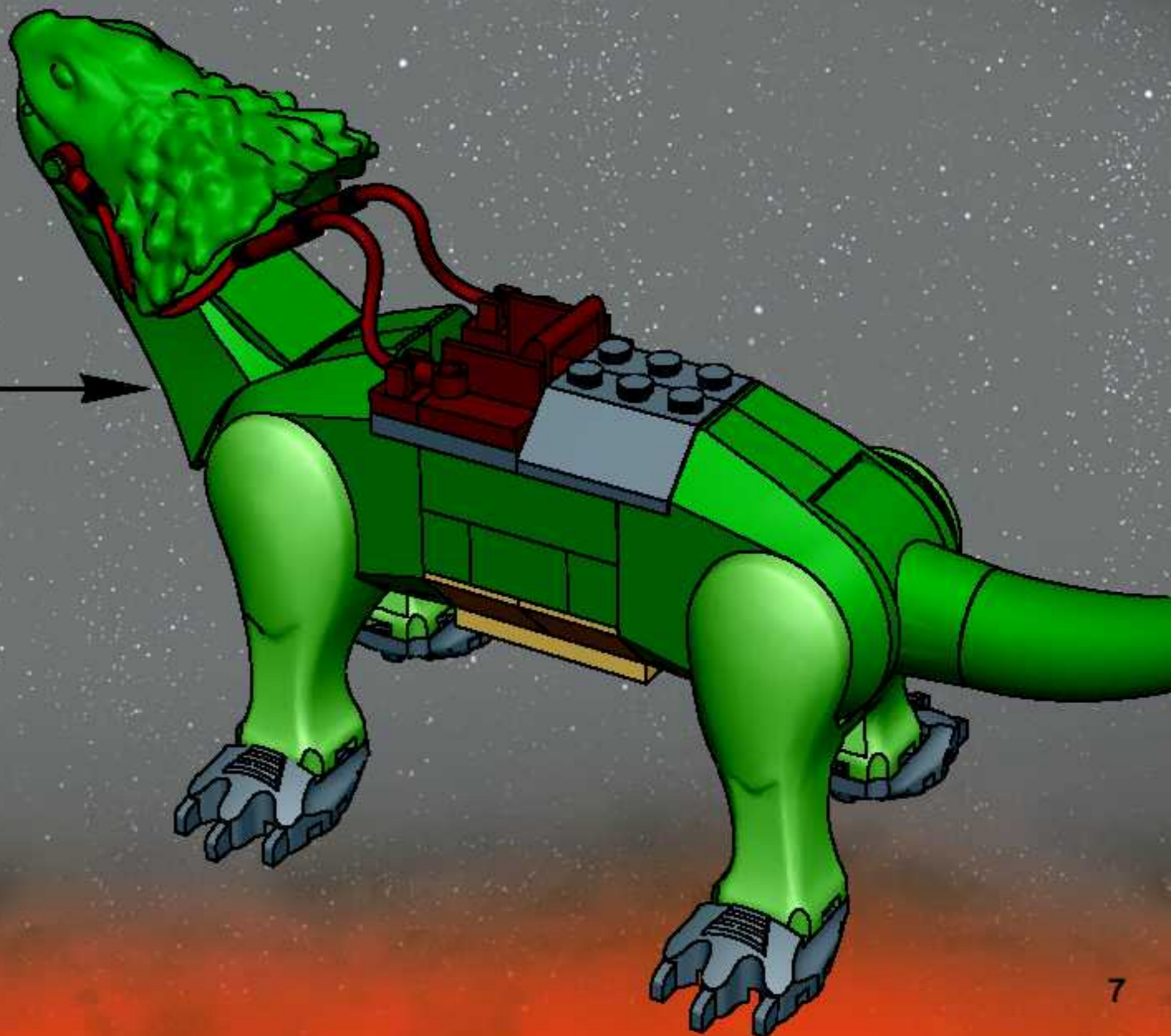

11

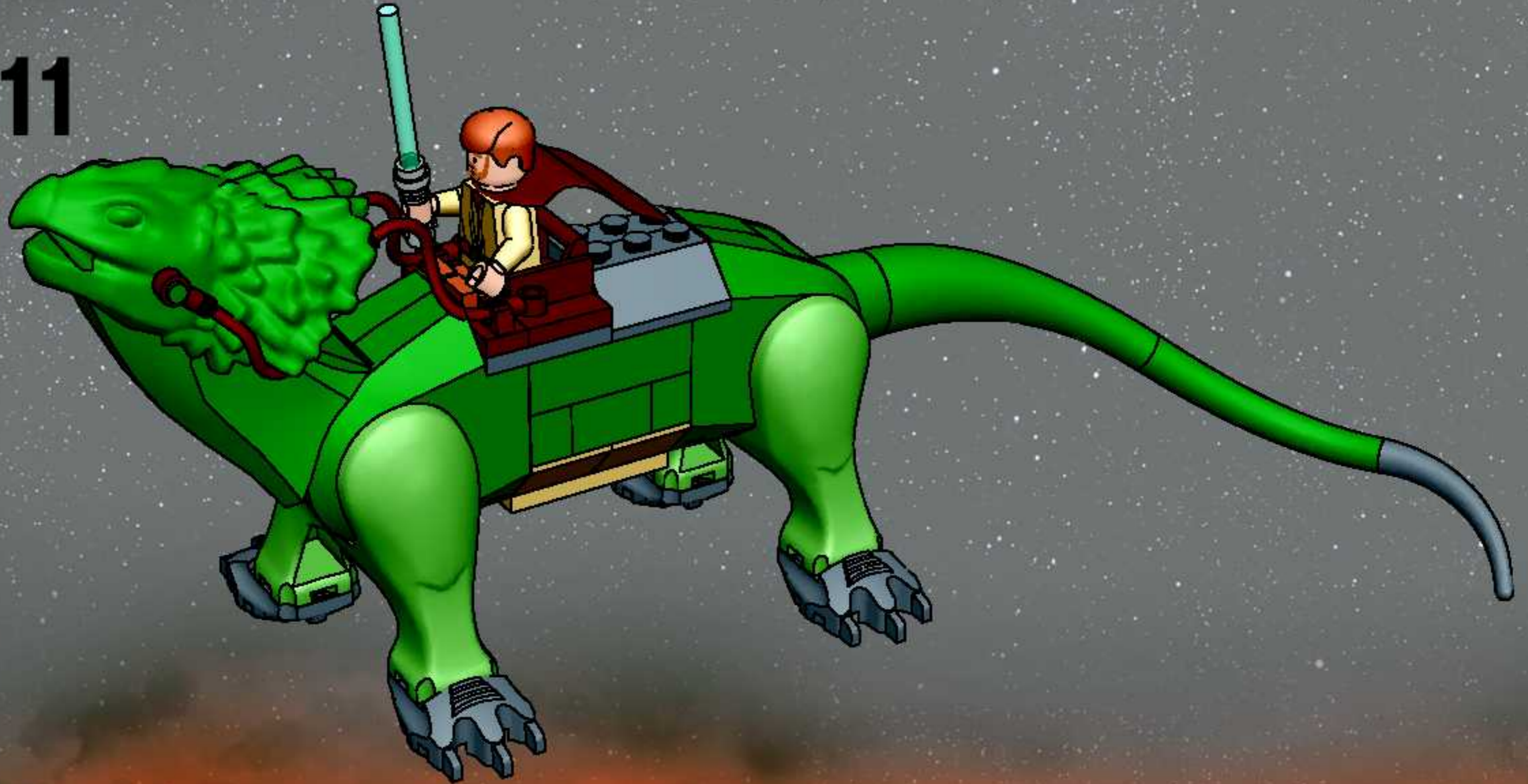



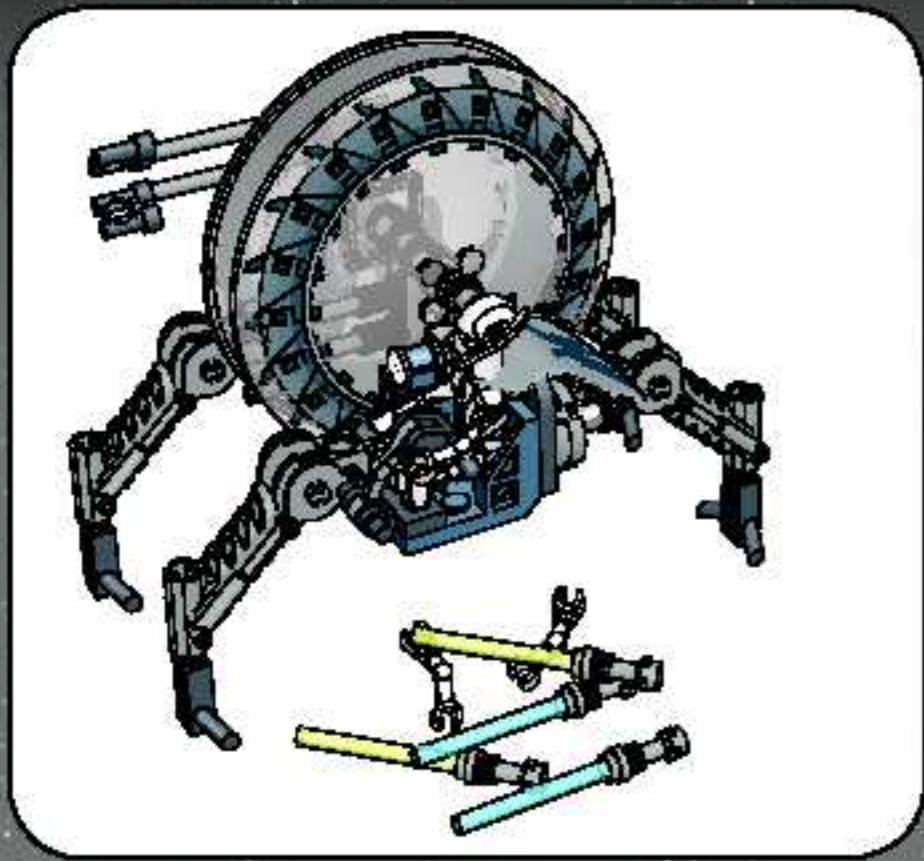

1

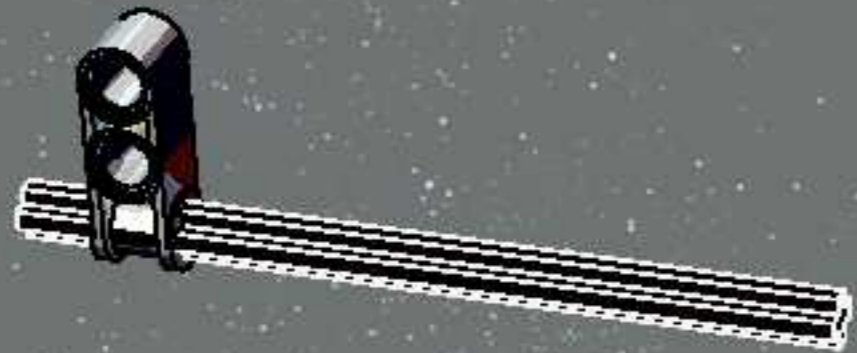

2

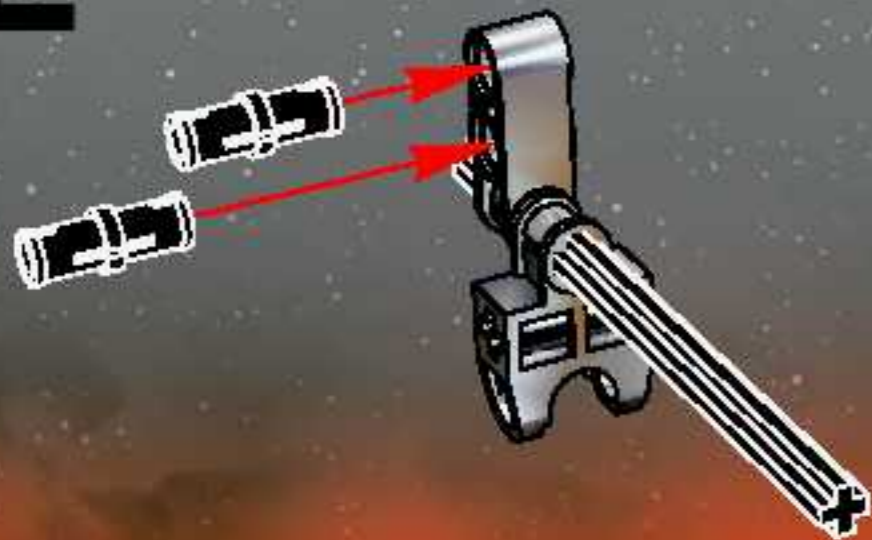

3

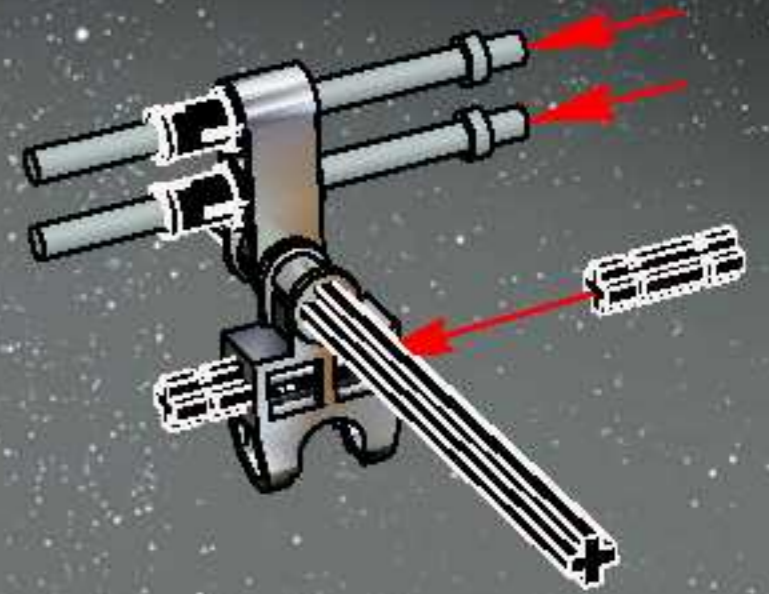

4

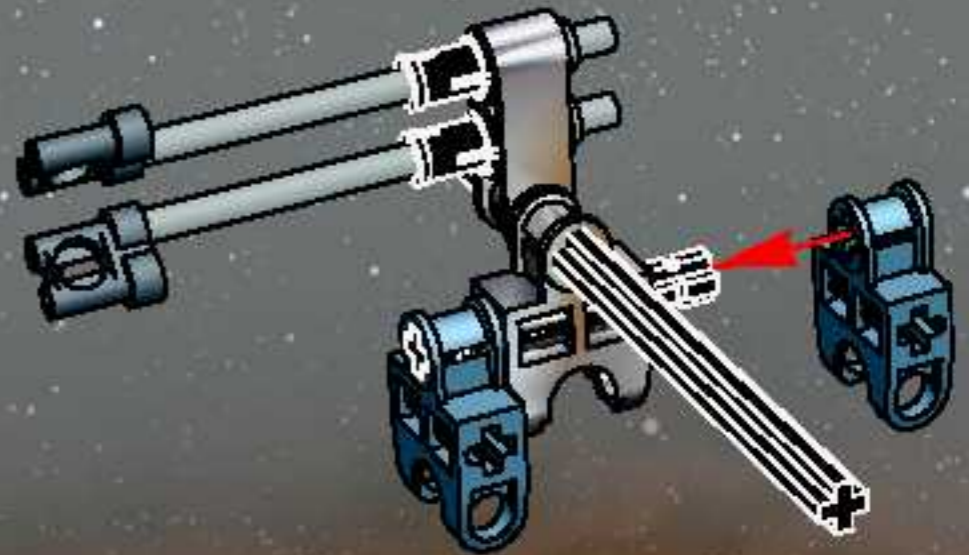

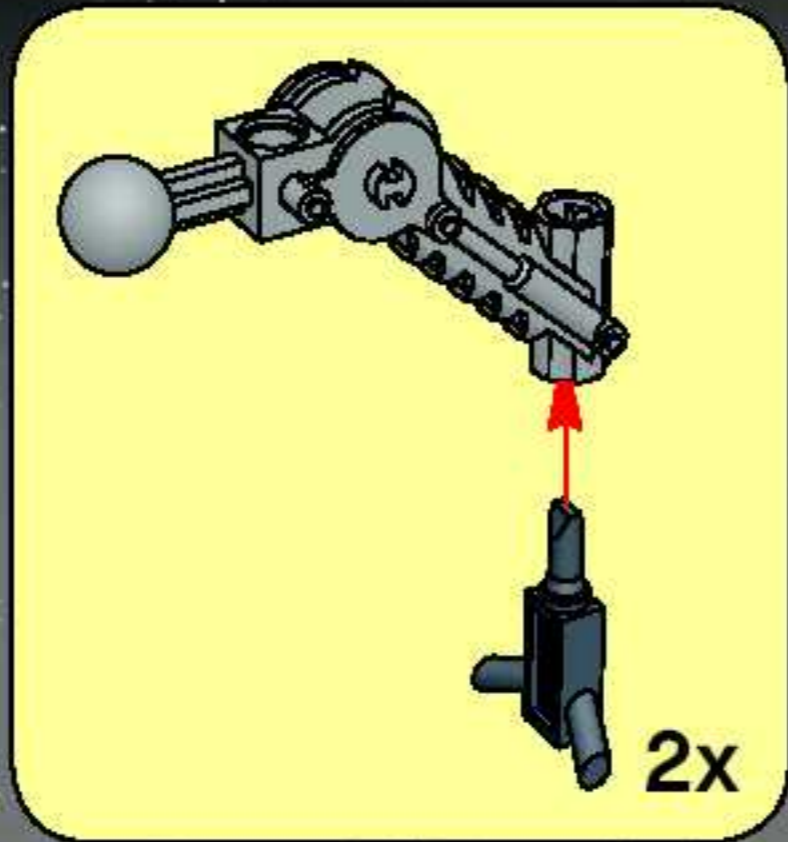

5

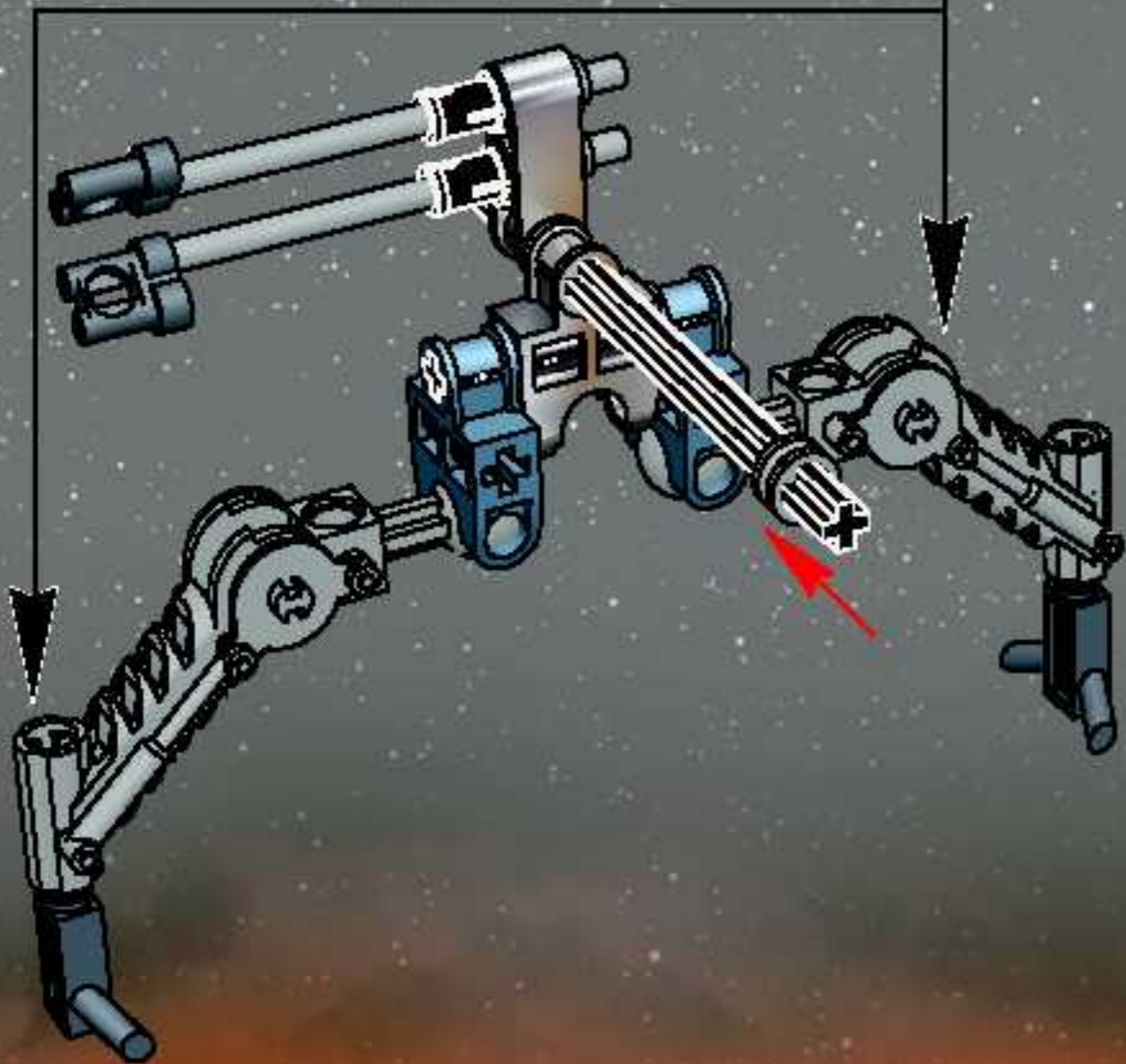

6

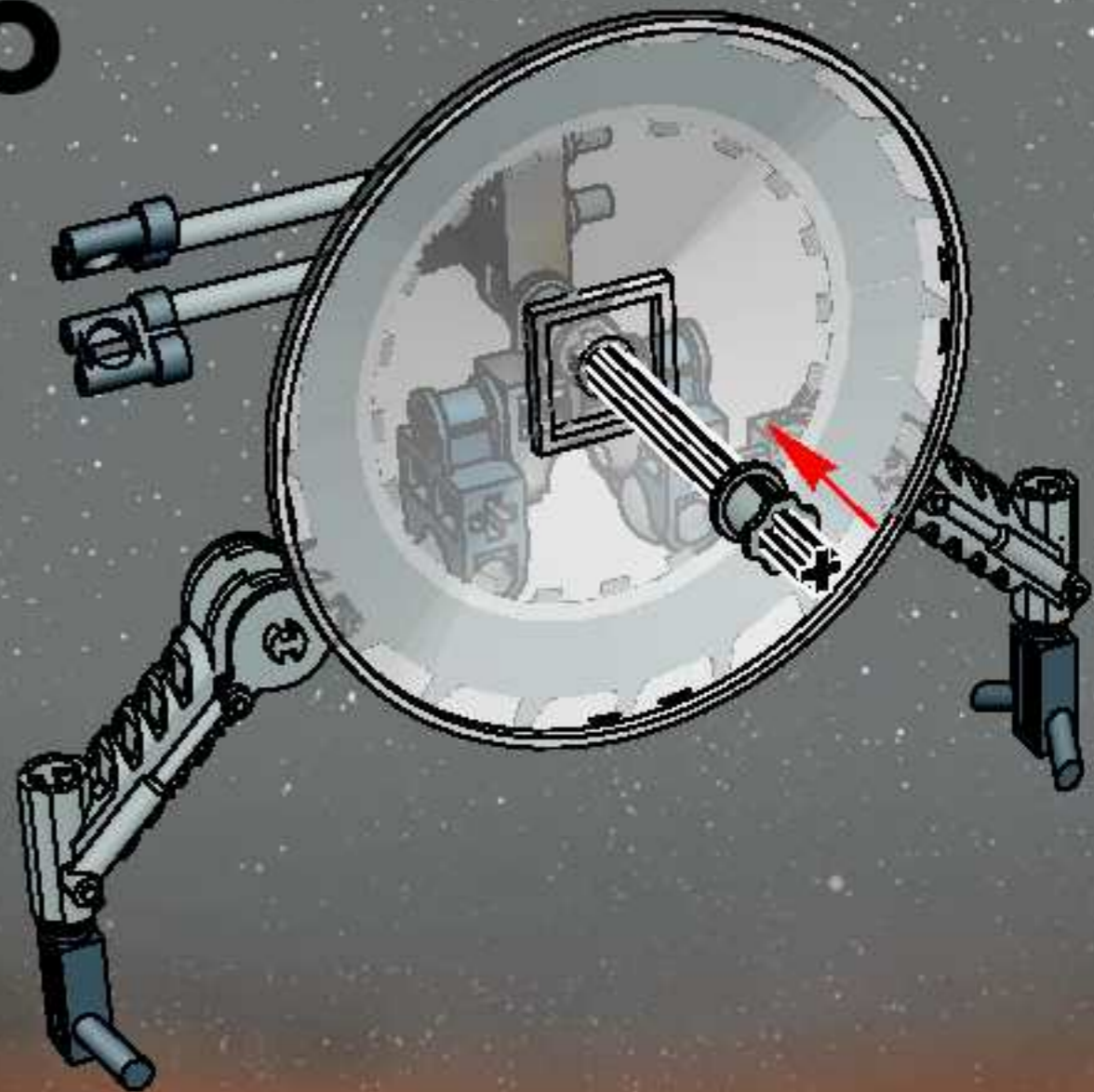

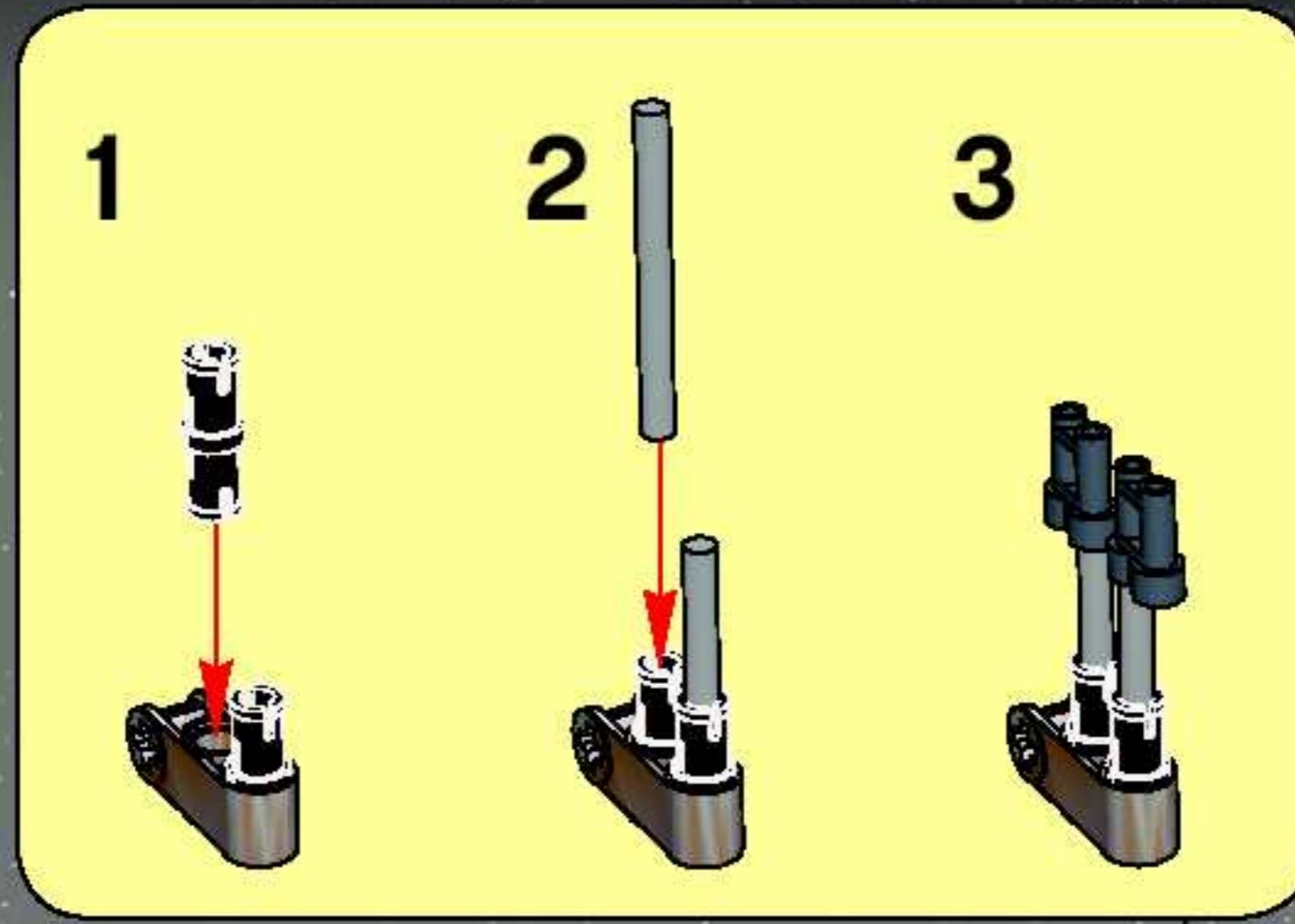

7

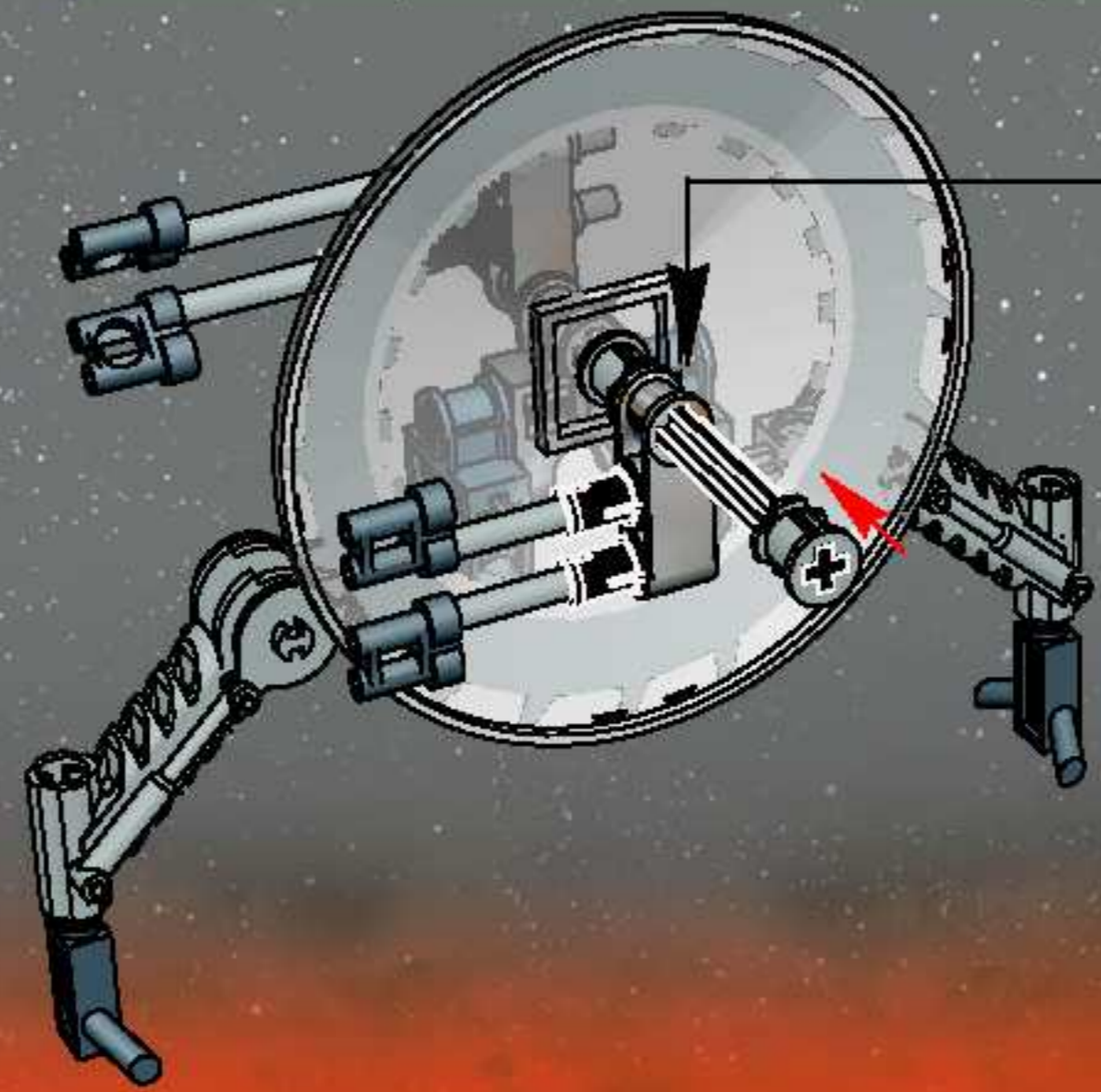

8

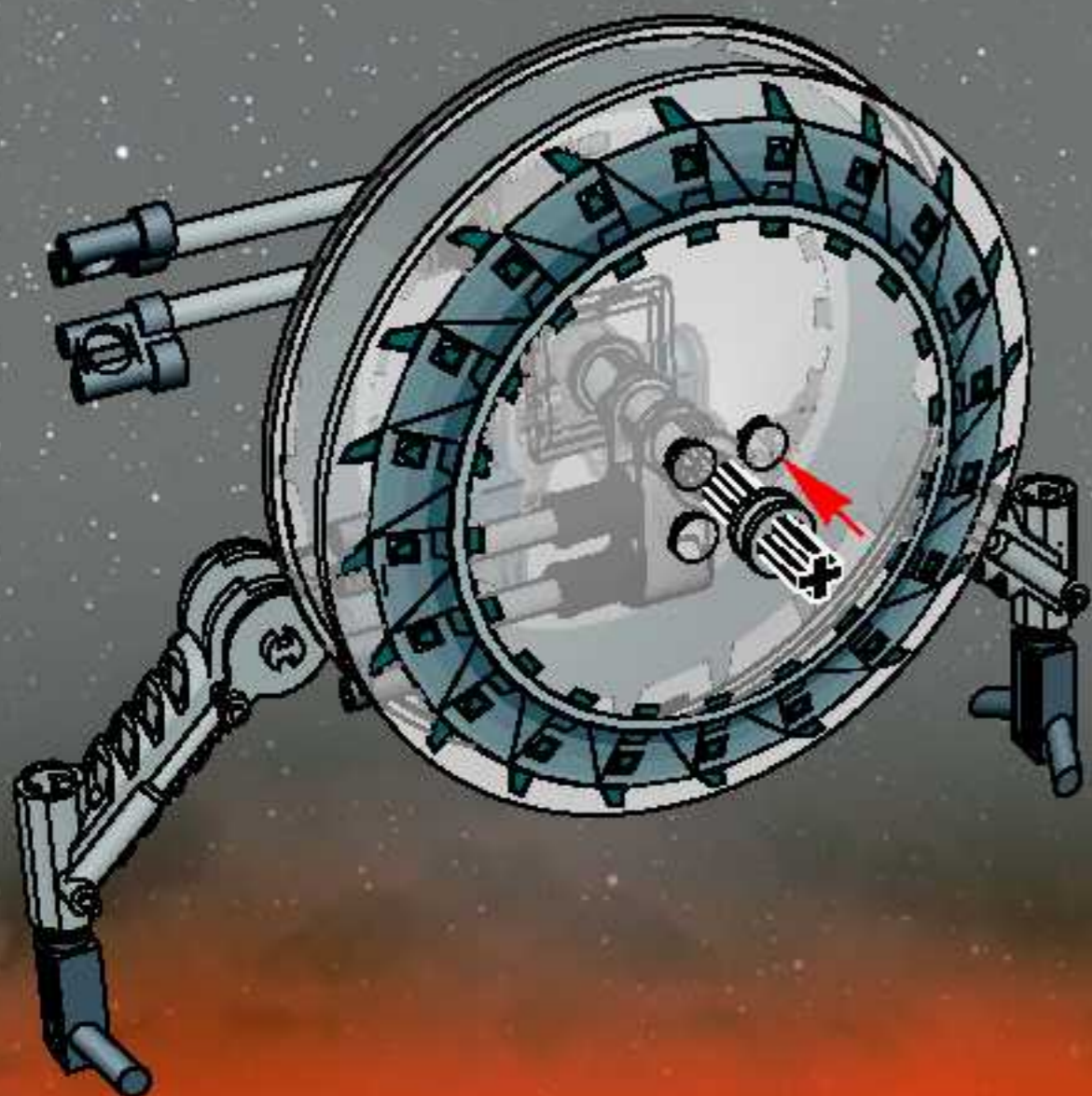

9

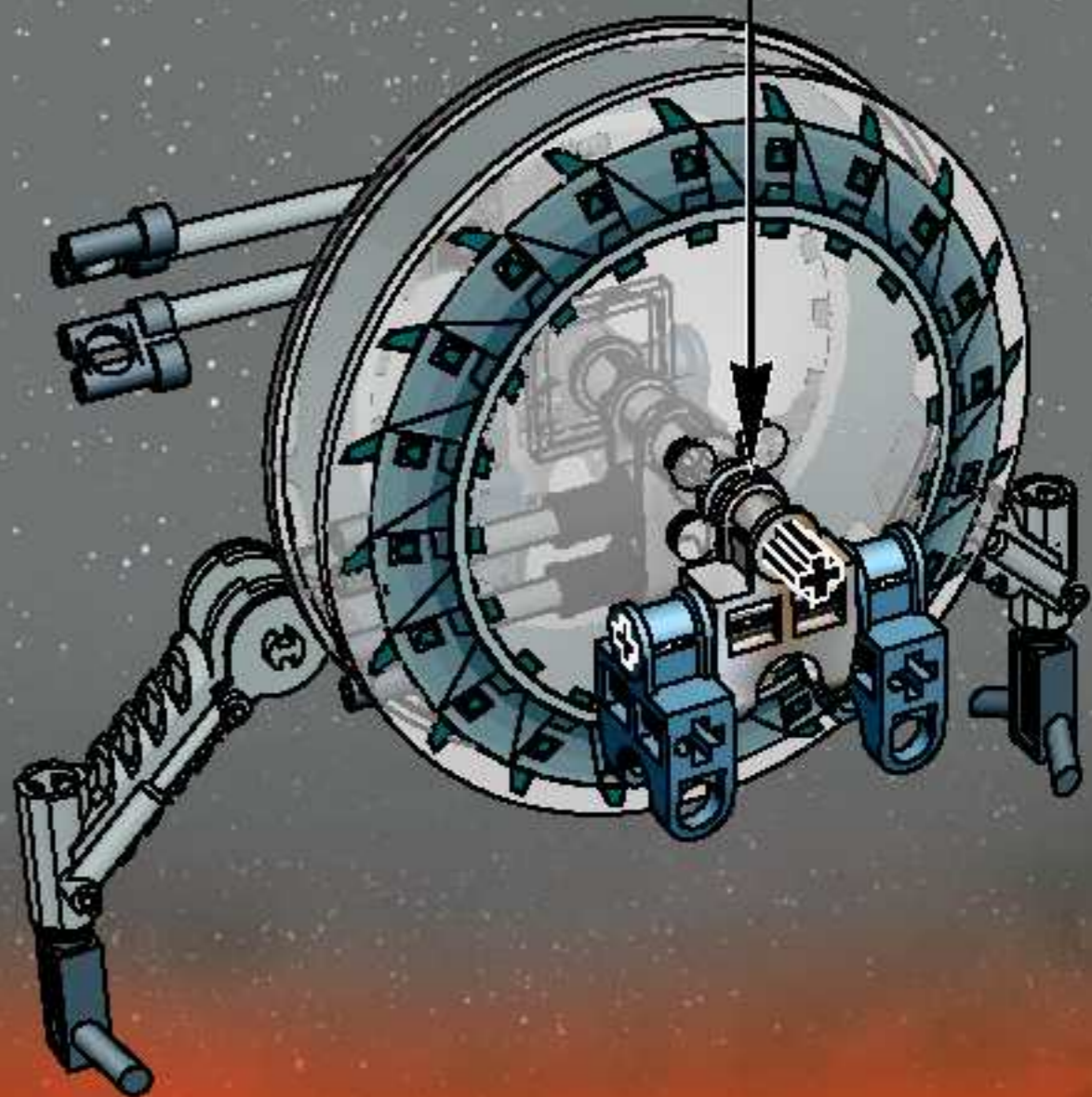

1

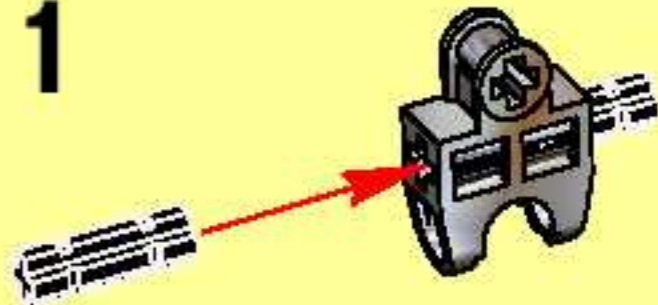

2

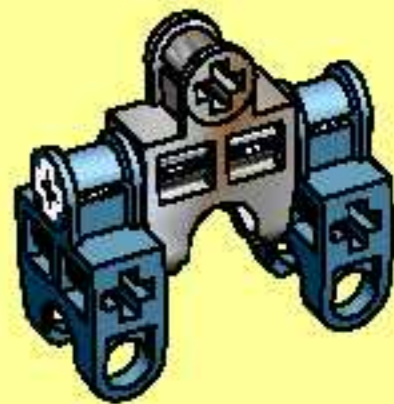

10

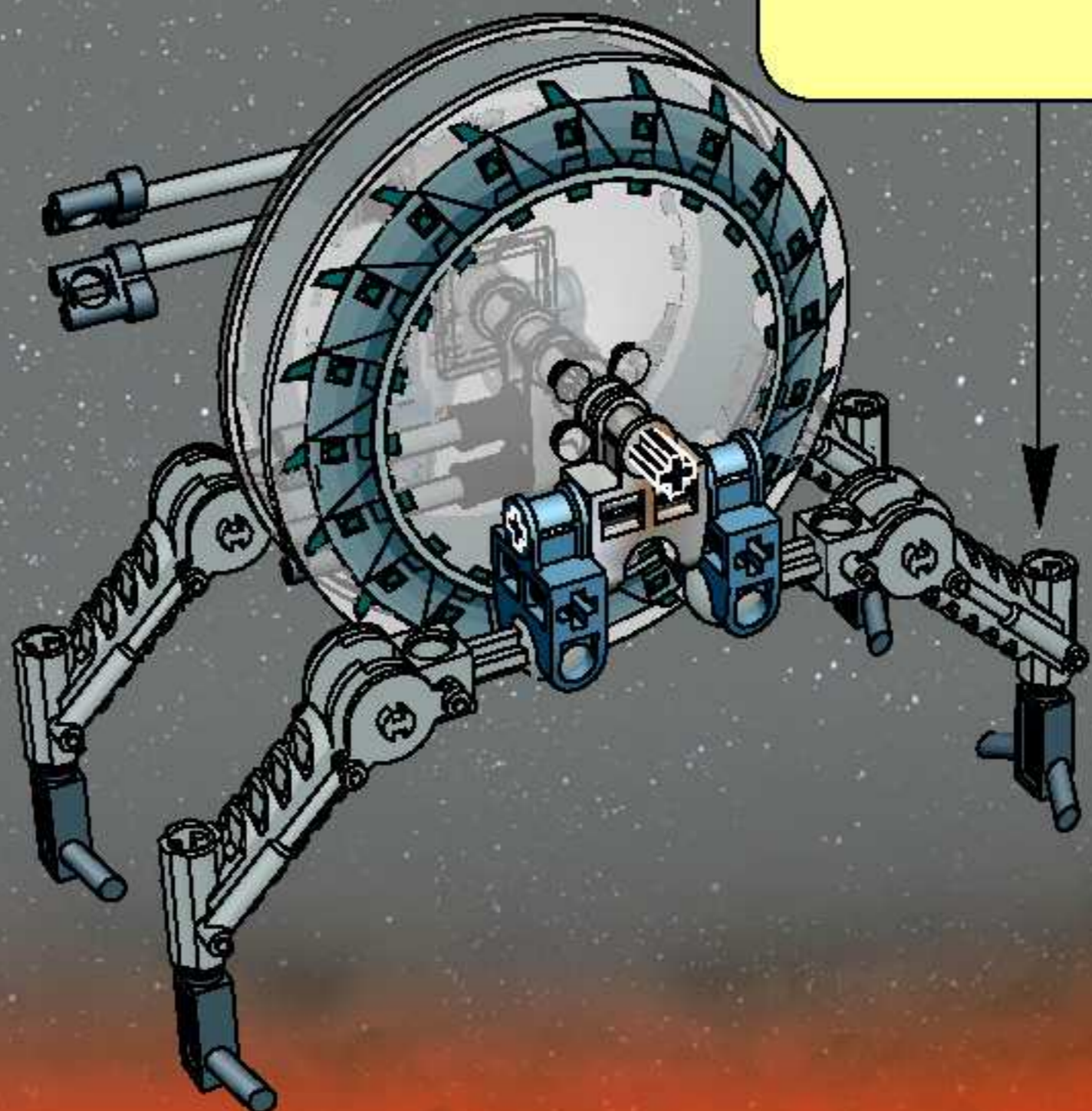
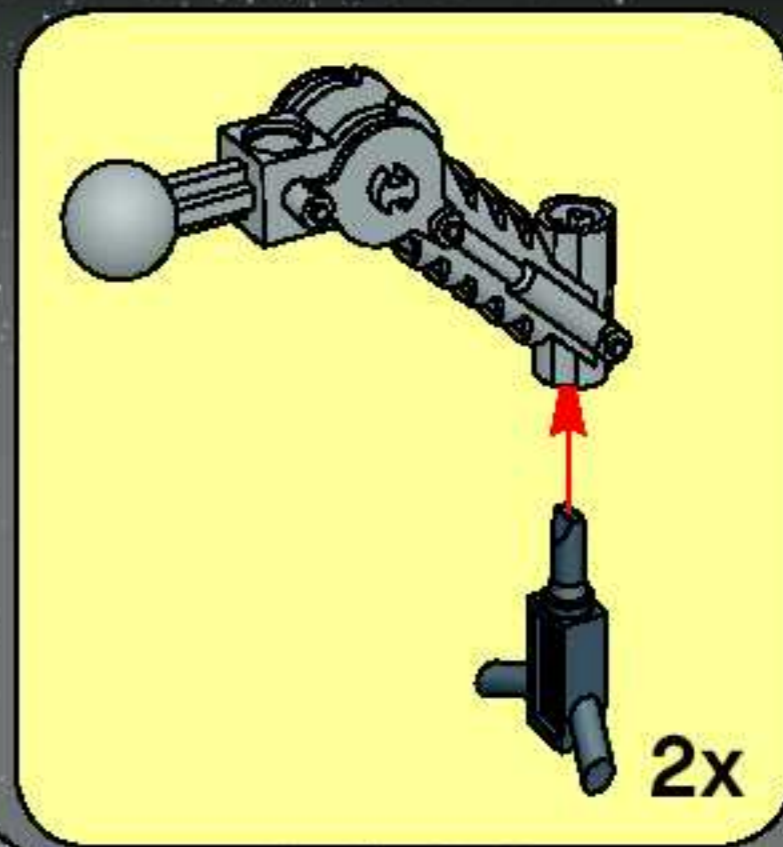

1

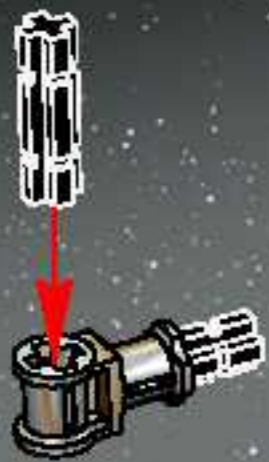

2

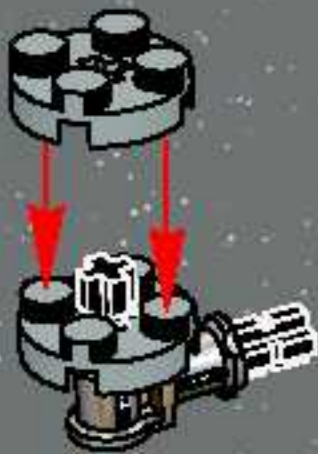

3



4



5

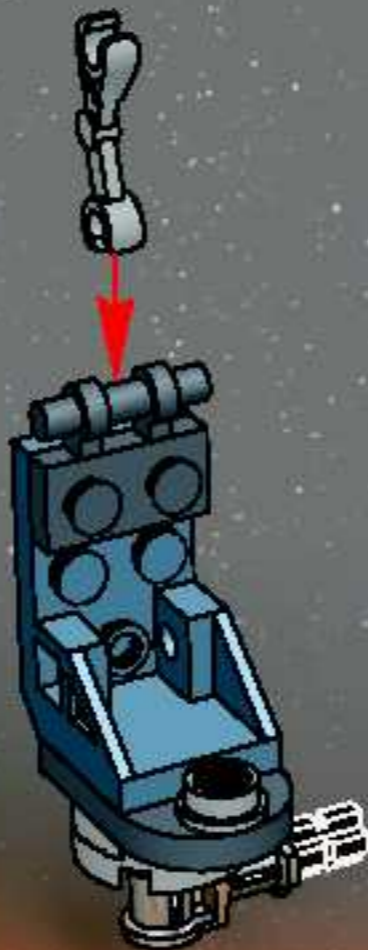

6



11

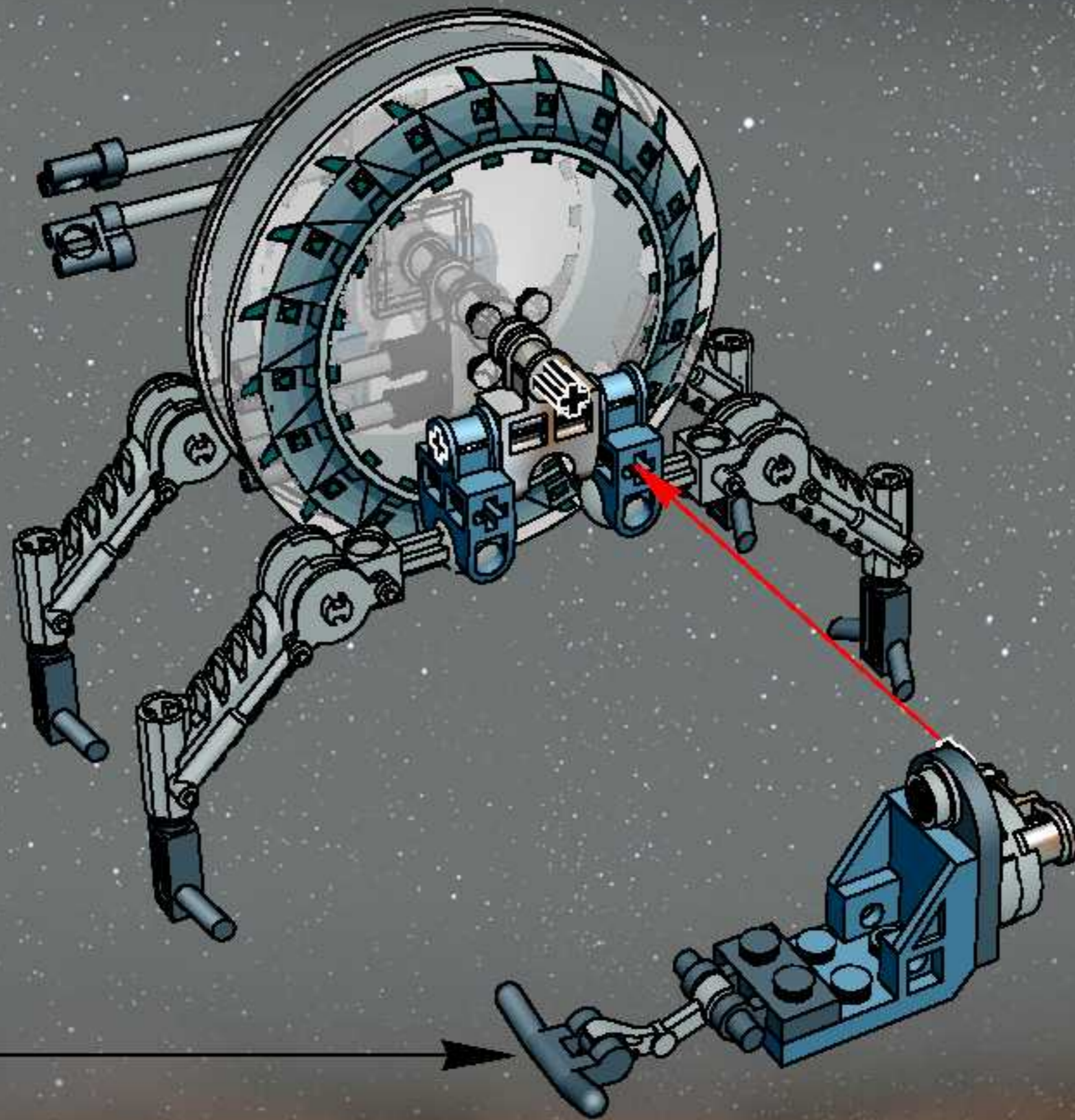

12

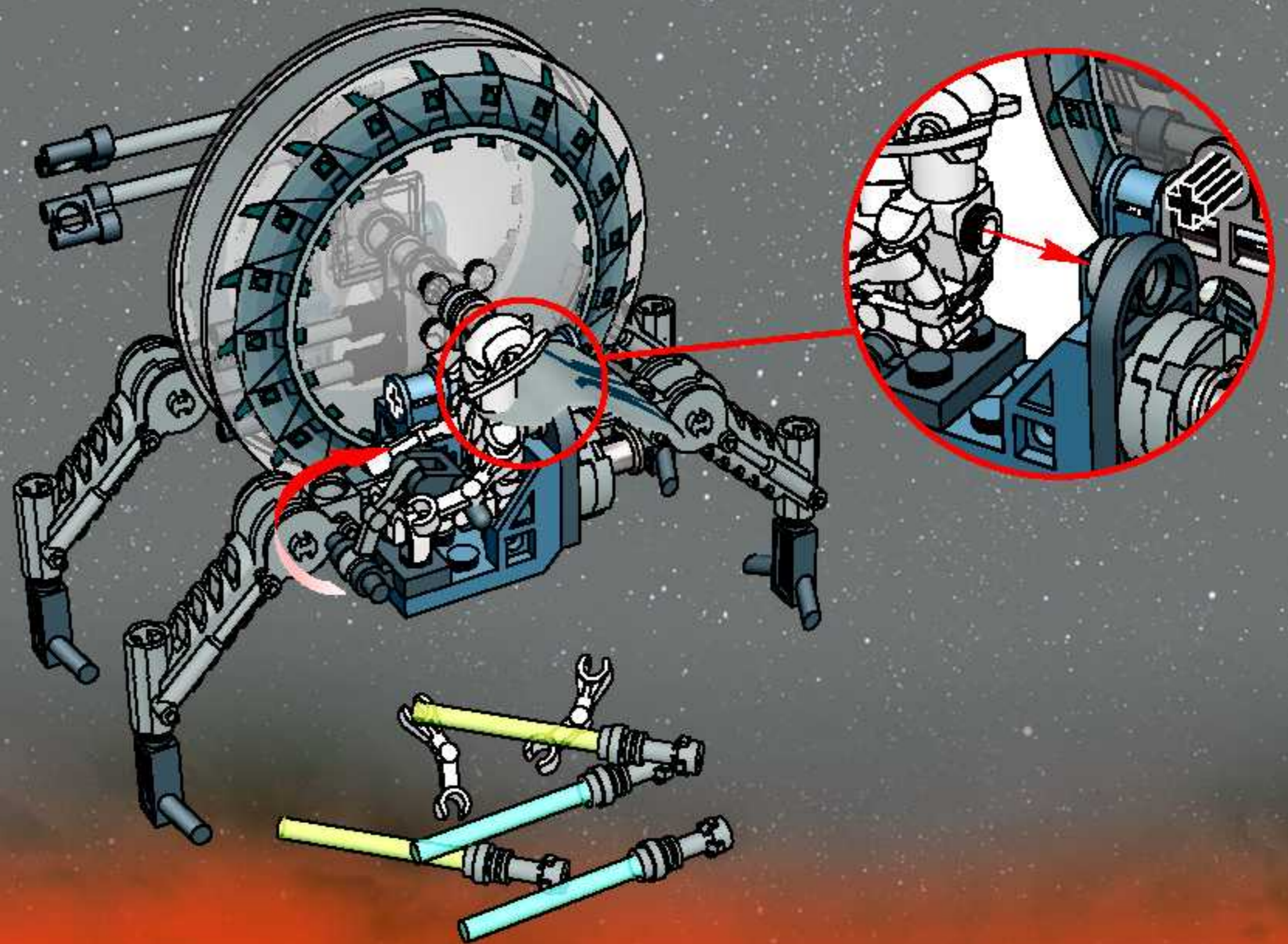



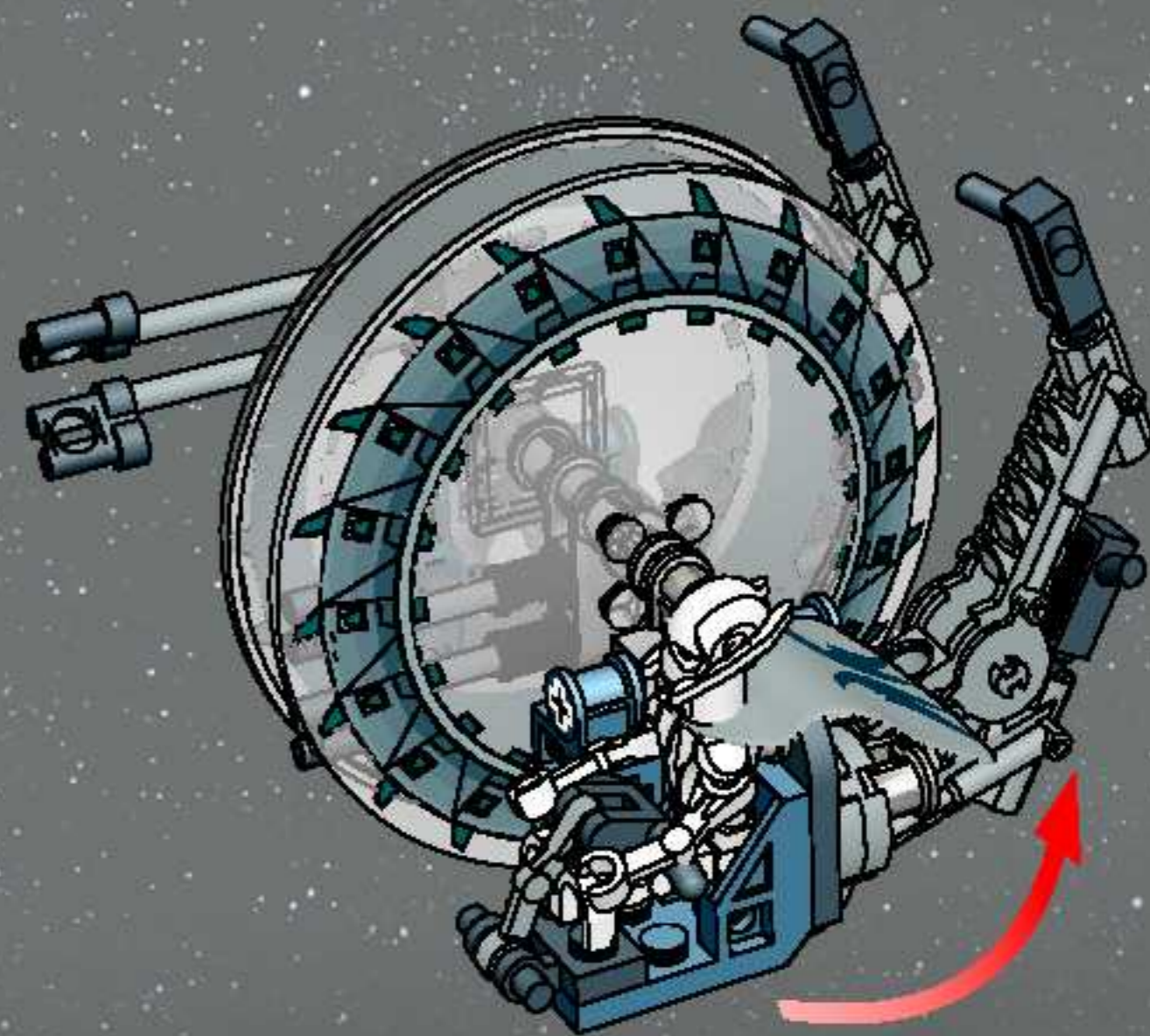
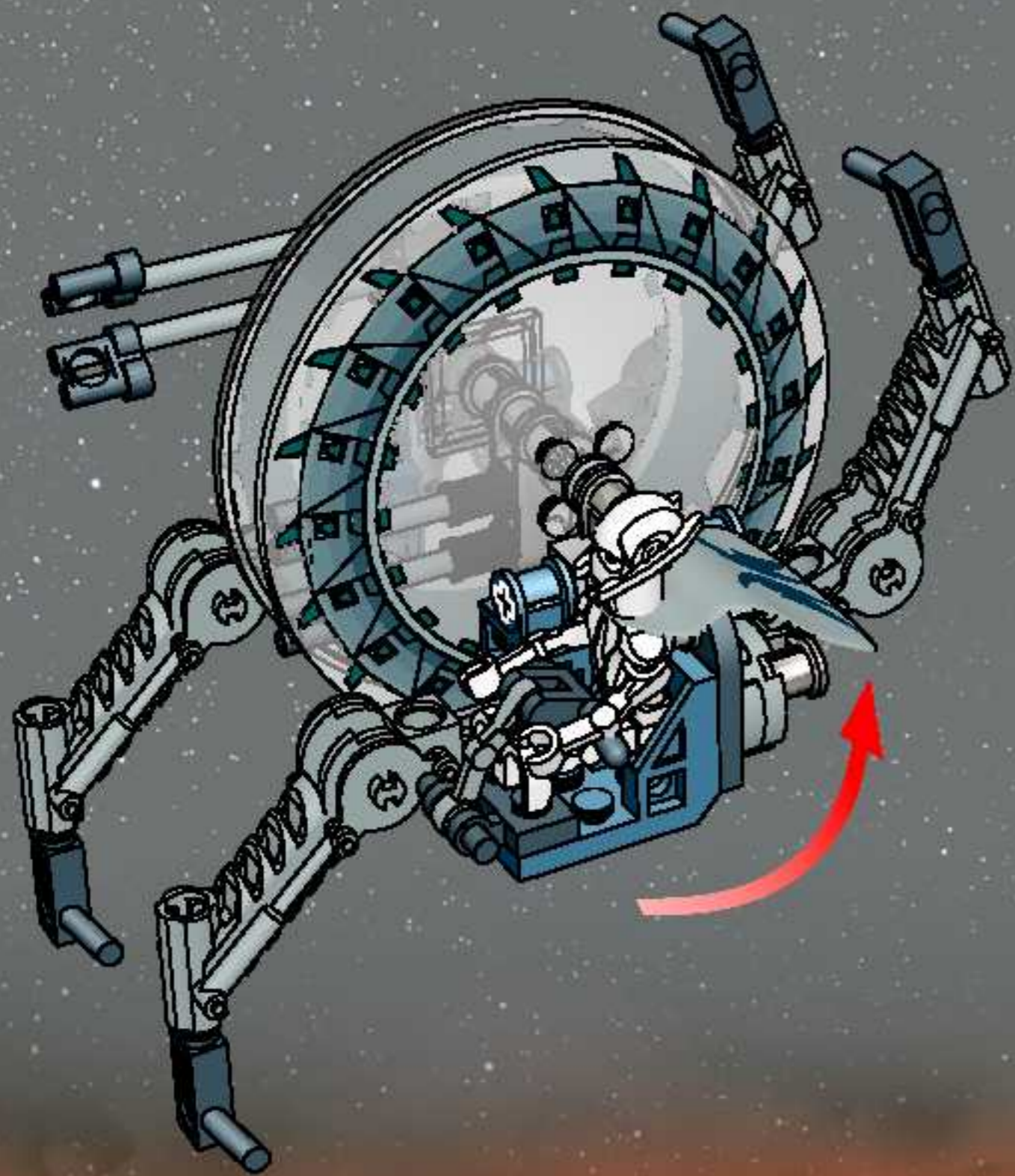

1.

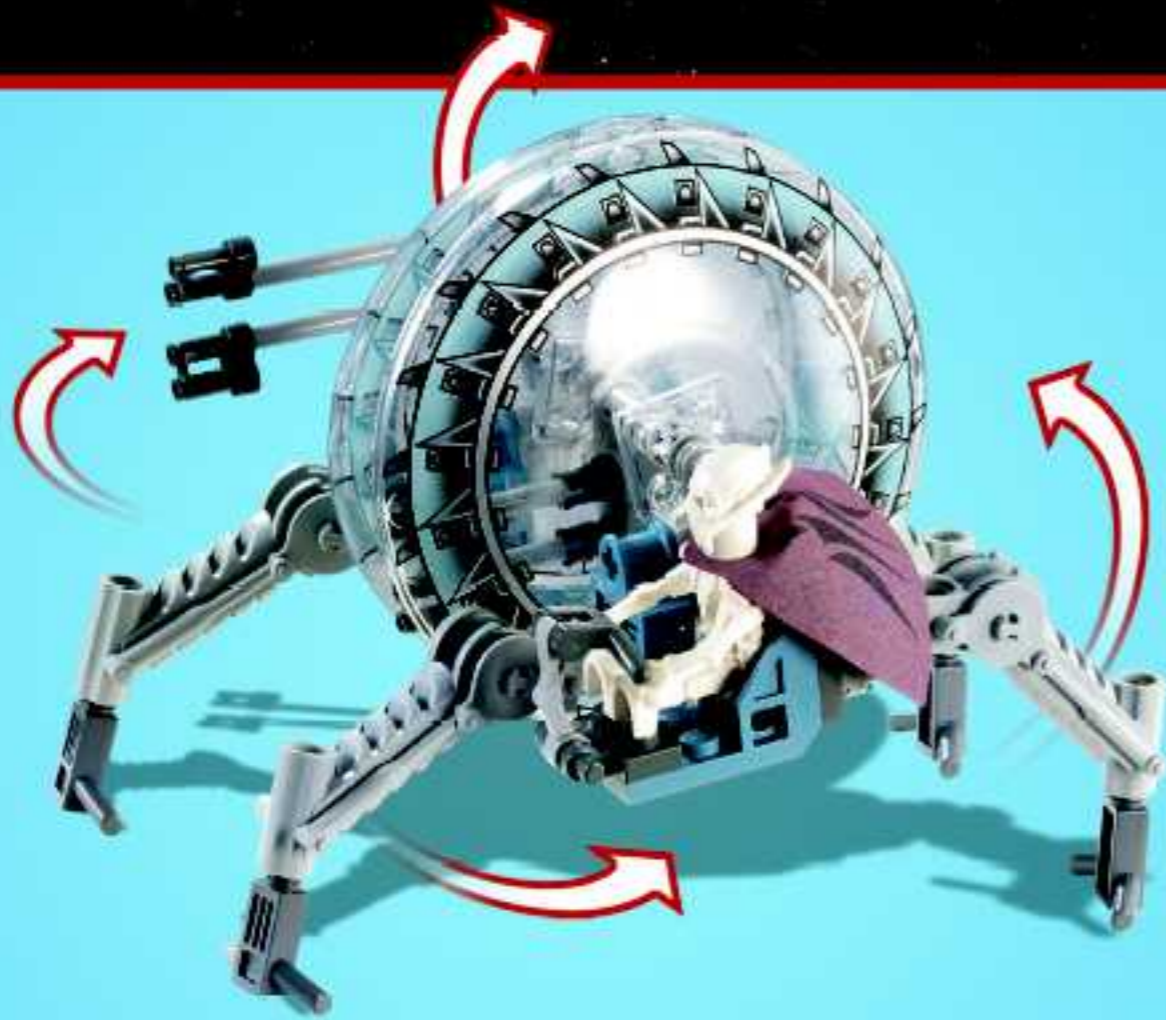

2.







7251  
Darth Vader™  
Transformation

7256  
Jedi Starfighter™  
and Vulture Droid™

7259  
Arc-170 Starfighter™



7261 Clone Turbo Tank™

7250  
Clone  
Scout  
Walker™



7257 Ultimate Lightsaber™ Duel



7252 Droid Tri-fighter™



7255 General Grievous™ Chase



7260 Wookiee Catamaran™



7258 Wookiee™ Attack



# club



## FREE!

Each LEGO Magazine features...

- Awesome creations by Kids like you!
- Cool Comics & Stories
- Building Tips & Ideas
- Special Offers & Contest to WIN Prizes!

## GRATUIT !

Chaque Magazine LEGO offre...

- Des créations épatantes par des jeunes comme toi !
- Des bandes dessinées et des récits super cool
- Des idées de construction
- Des offres spéciales et des concours pour gagner des prix !

Join Today! Abonne-toi dès aujourd'hui !

# 1-866-534-6258

# www.LEGOclub.com



LEGO, the LEGO logo are trademarks of/sont des marques de commerce de/The LEGO Group. ©2005 The LEGO Group.

# Win! Gagne !

**WIN LEGO® PRODUCTS**  
Log on to [www.acnielsen.aim.dk/LEGO](http://www.acnielsen.aim.dk/LEGO) for further instructions.

**GAGNE DES PRODUITS LEGO®**  
Visite [www.acnielsen.aim.dk/LEGO](http://www.acnielsen.aim.dk/LEGO) pour plus d'informations.

**ESTIMADO USARIO LEGO®**  
Al contestar algunas preguntas en ingles, frances, aleman o japones en el sitio [www.acnielsen.aim.dk/LEGO](http://www.acnielsen.aim.dk/LEGO), podras participar en el sorteo de algunas valiosos premios LEGO®.

[www.acnielsen.aim.dk/LEGO](http://www.acnielsen.aim.dk/LEGO)





# SHOP at HOME

## The World's Biggest LEGO® Shop!

For a Free Catalog in the U.S.  
and Canada, call toll-free:

1-800-446-8107

Or go online:

[www.LEGOshop.com/catalog](http://www.LEGOshop.com/catalog)

Pour obtenir un Catalogue GRATUIT  
aux États-Unis et au Canada,  
téléphonez sans frais au :

1-800-267-5346

Ou venez en ligne sur :

[www.LEGOshop.com/catalog](http://www.LEGOshop.com/catalog)

# LEGO STAR WARS™

THE VIDEO GAME



4276597

©2005 The LEGO Group.



LEGO, the LEGO logo and the Minifigure are trademarks of The LEGO Group. © 2004 The LEGO Group. © 2004 Lucasfilm Entertainment Company Ltd. or Lucasfilm Ltd. & ® or TM as indicated. All rights reserved. Microsoft, Xbox and the Xbox logos are either registered trademarks or trademarks of Microsoft Corporation in the U.S. and/or in other countries and are used under license from Microsoft. All rights reserved. "PS" and "PlayStation" are registered trademarks of Sony Computer Entertainment Inc. All rights reserved. GAME BOY ADVANCE IS A TRADEMARK OF NINTENDO. The NVIDIA logo and "The way it's meant to be played" logo are registered trademarks or trademarks of NVIDIA Corporation.