

# BIONICLE

VASTUS



CAUTION: Do not aim at eyes or face.  
ATTENTION: Ne pas viser les yeux ni le visage.  
PRECAUCIÓN: No lo dirija a los ojos o cara.

8986



1

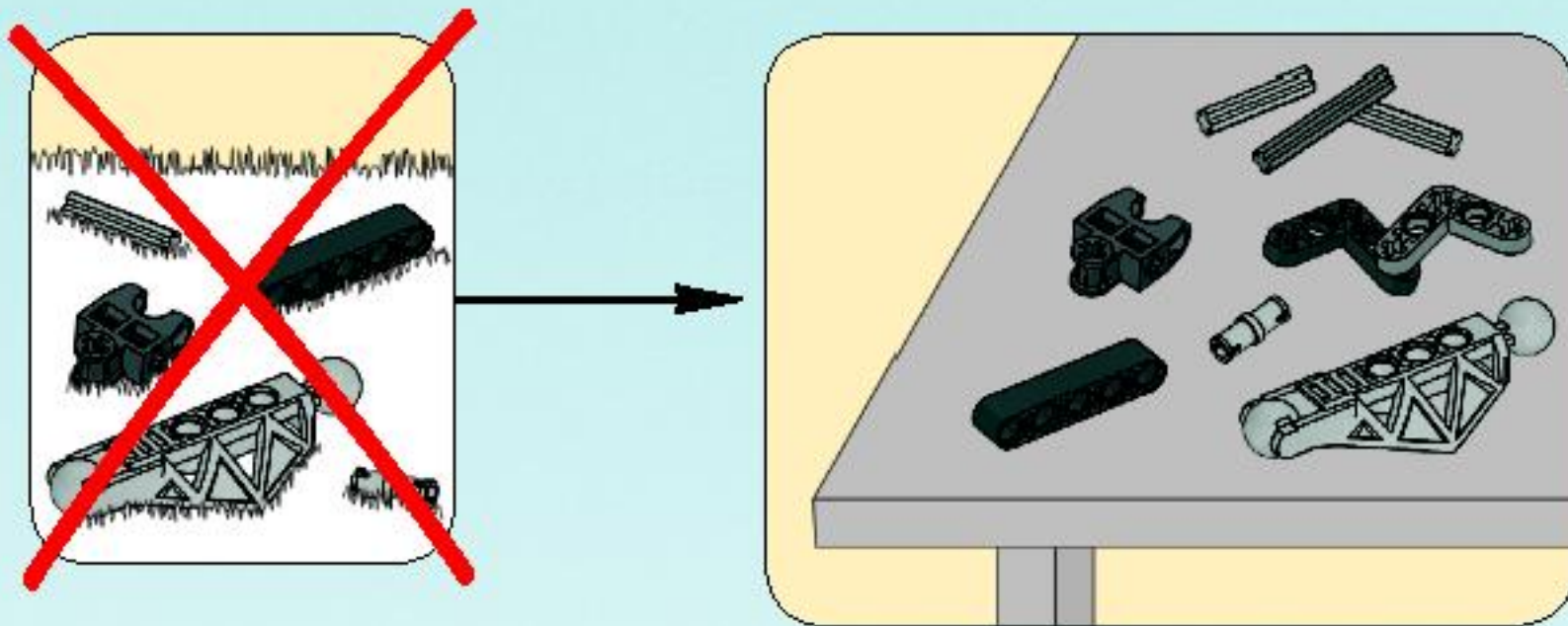

2

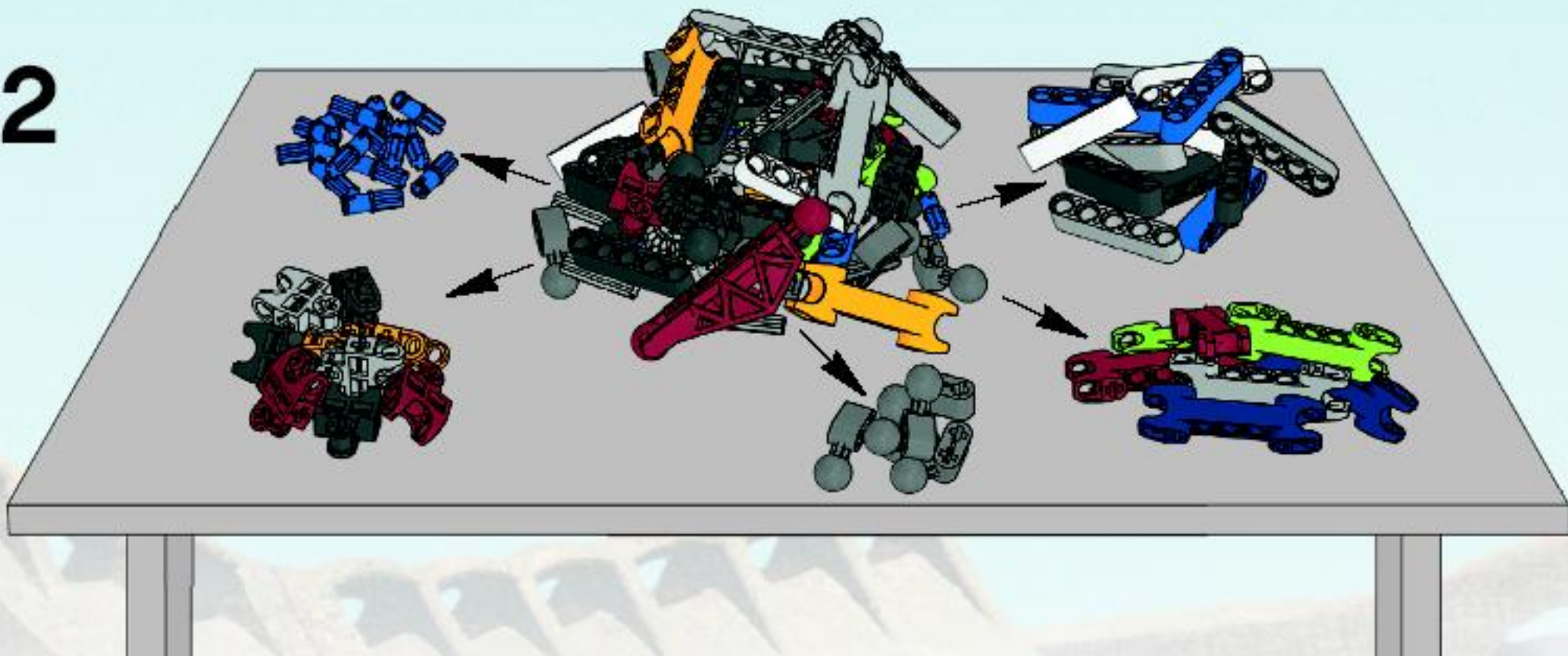

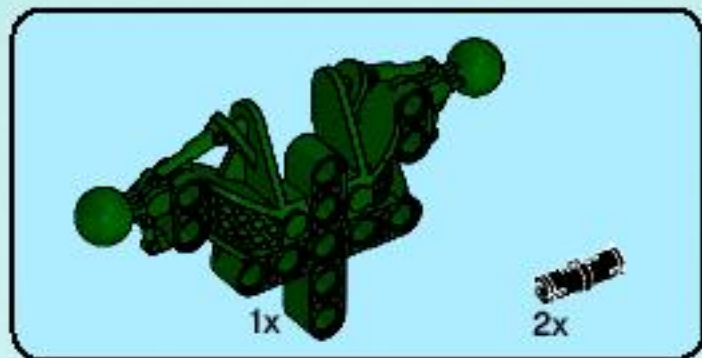

1

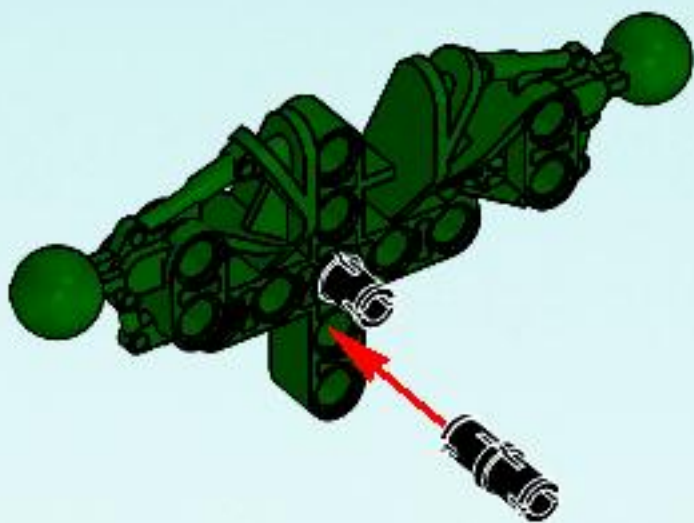

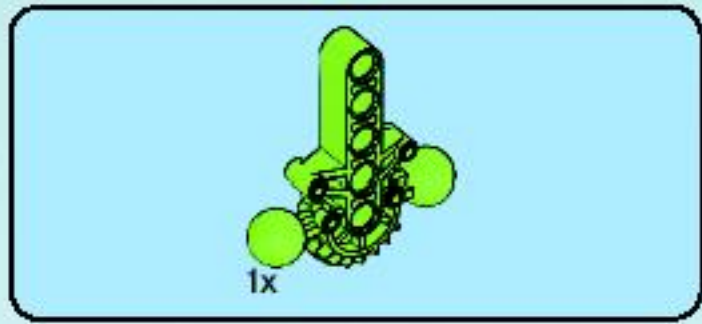

2

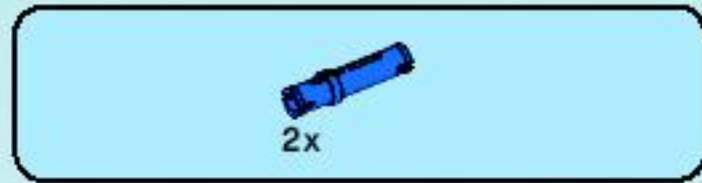
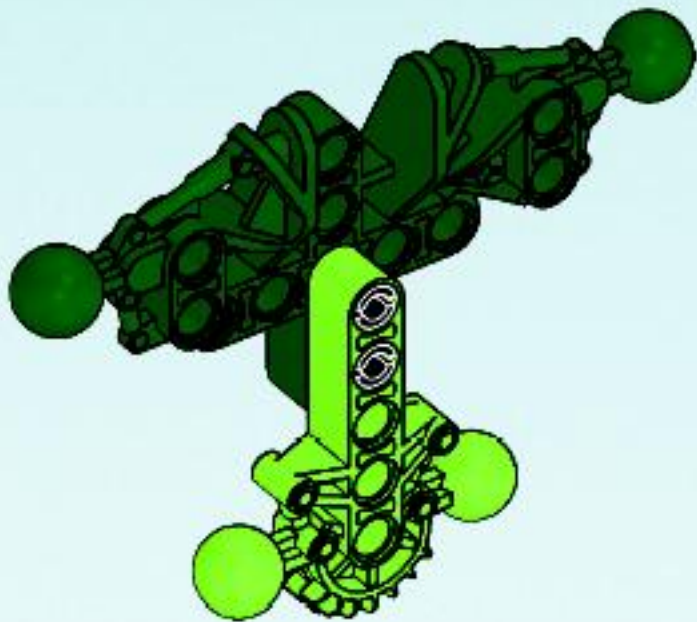

3

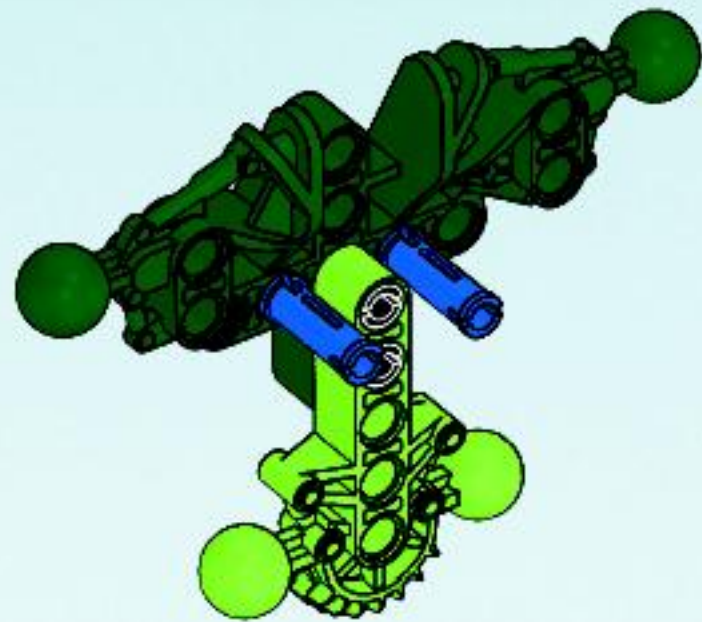



4

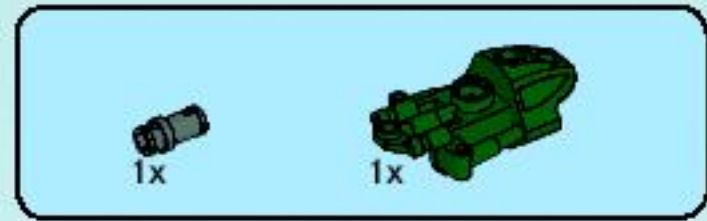

5

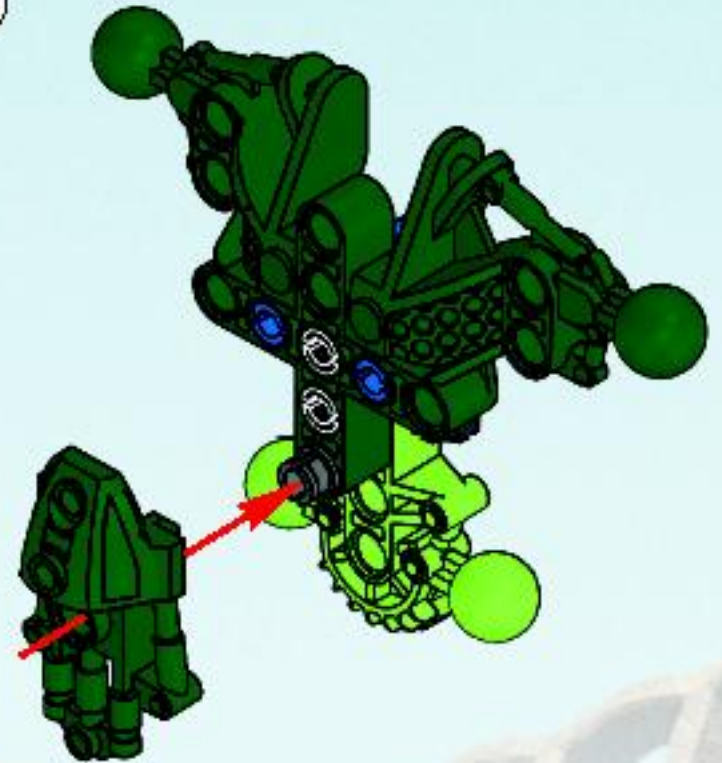

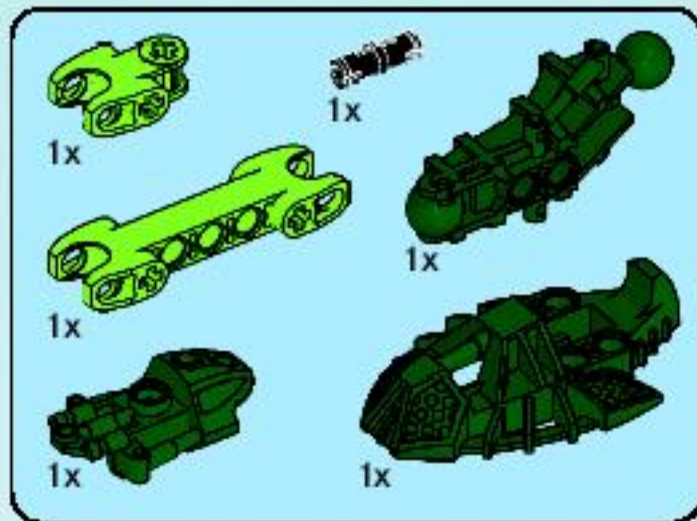

6

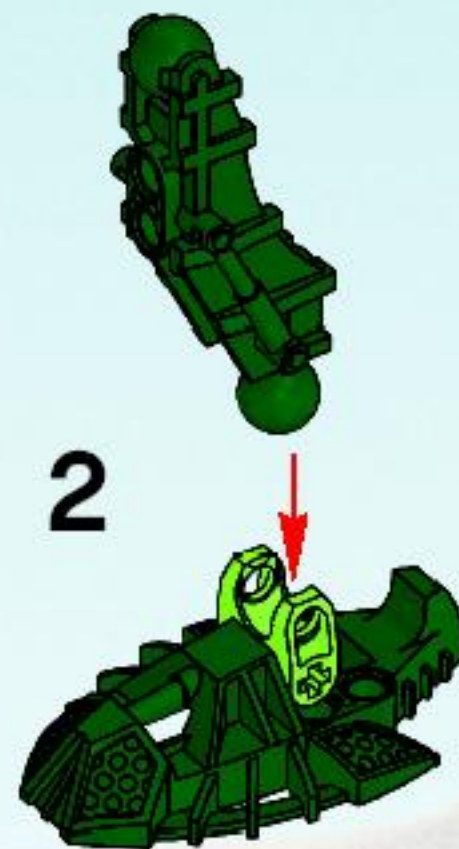
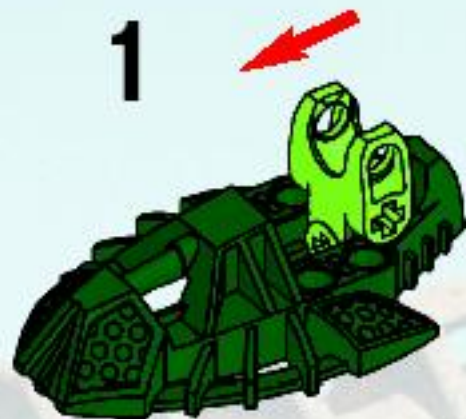

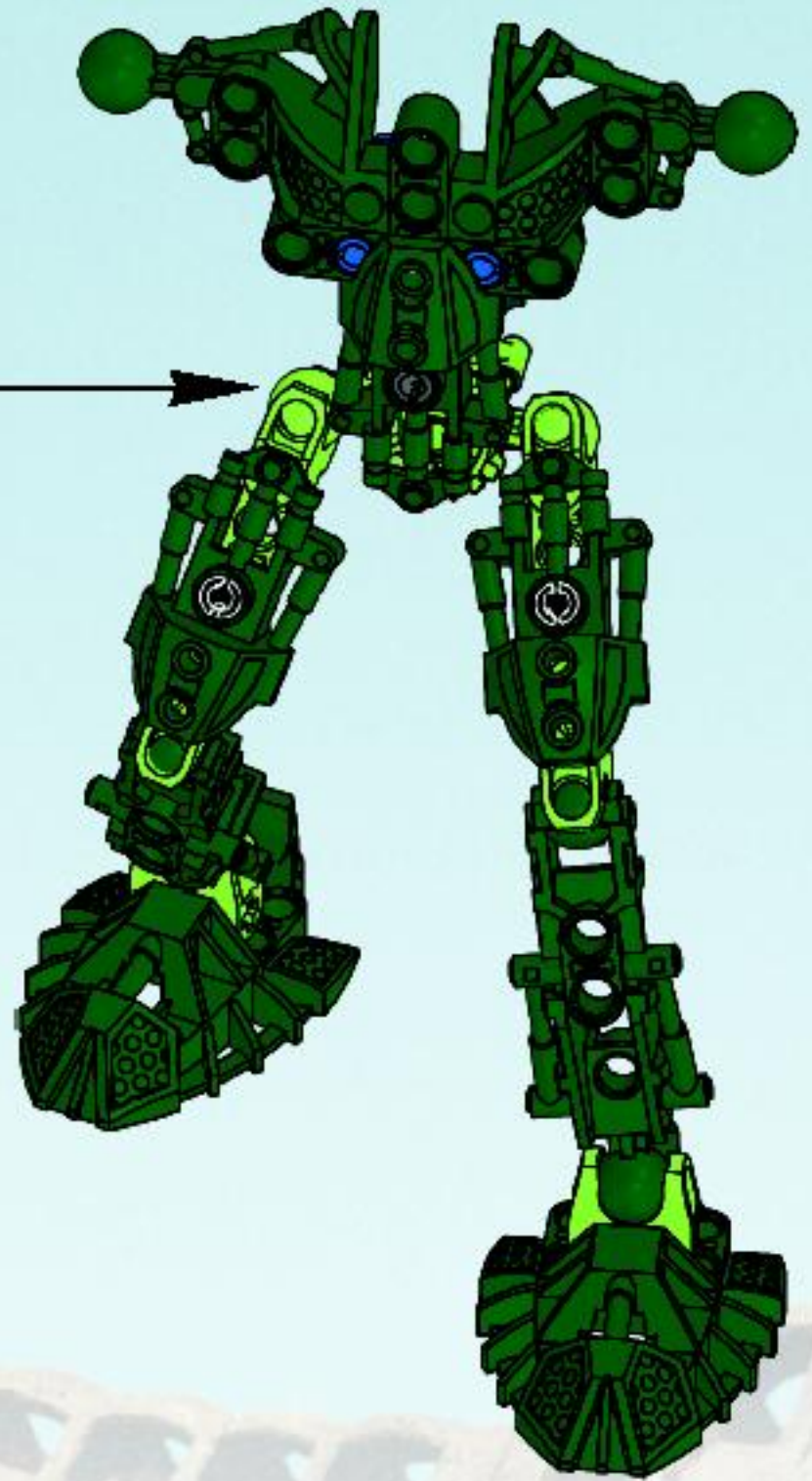
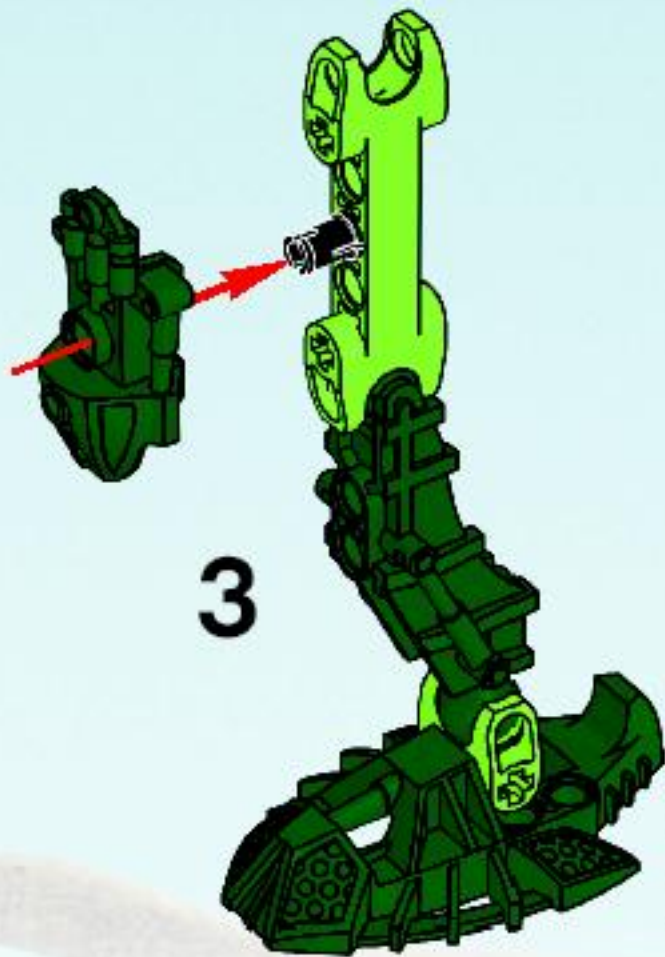

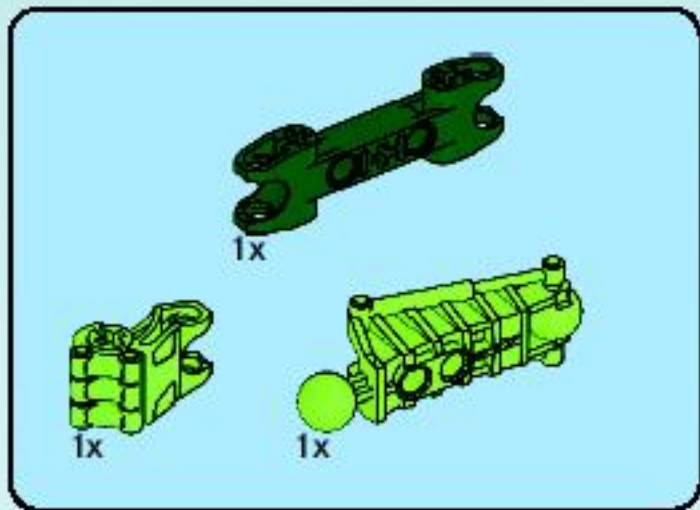

7

1

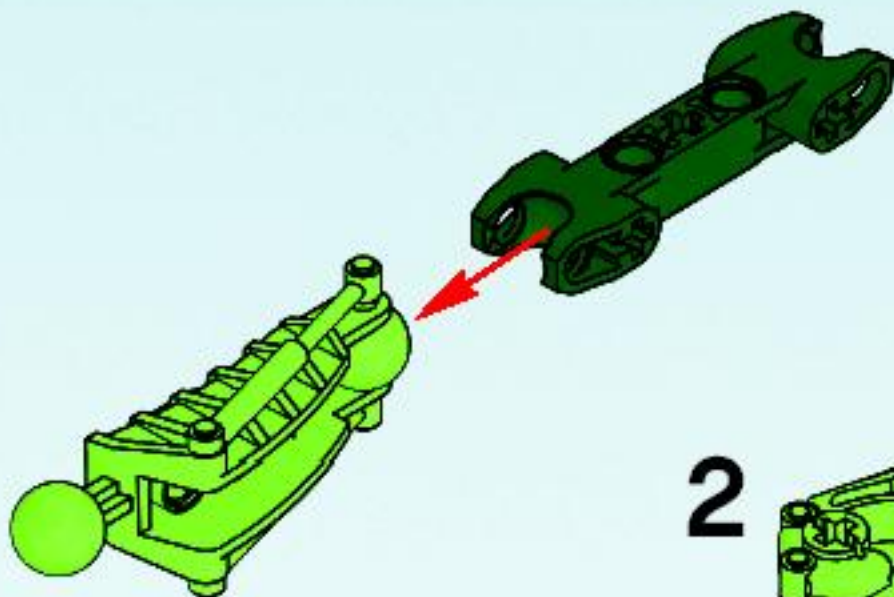

2

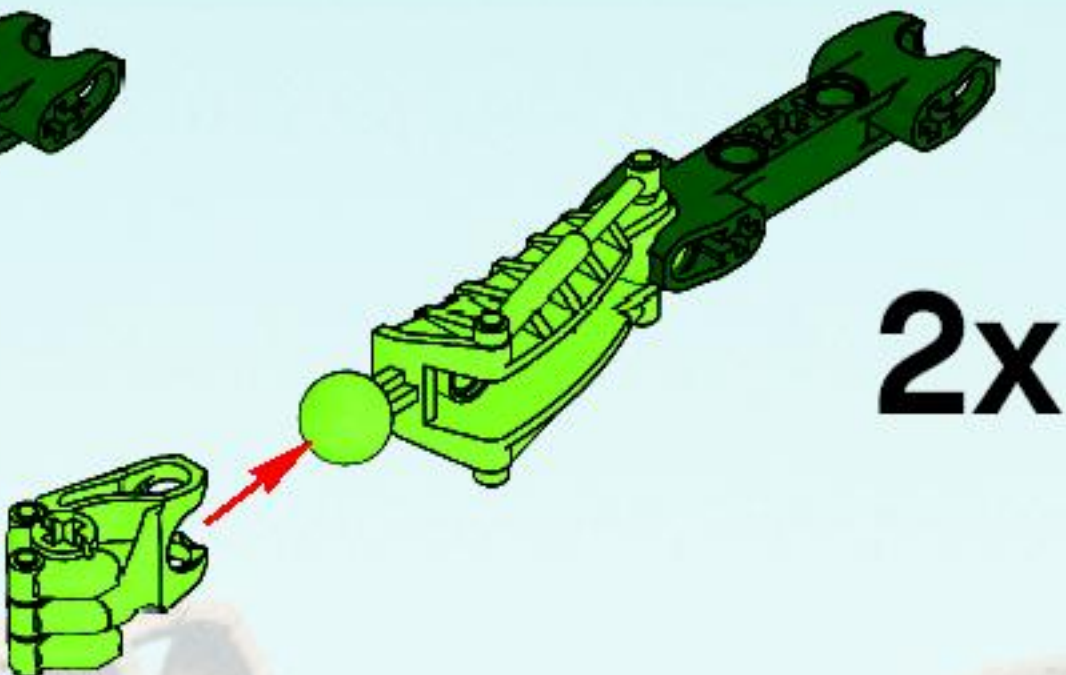



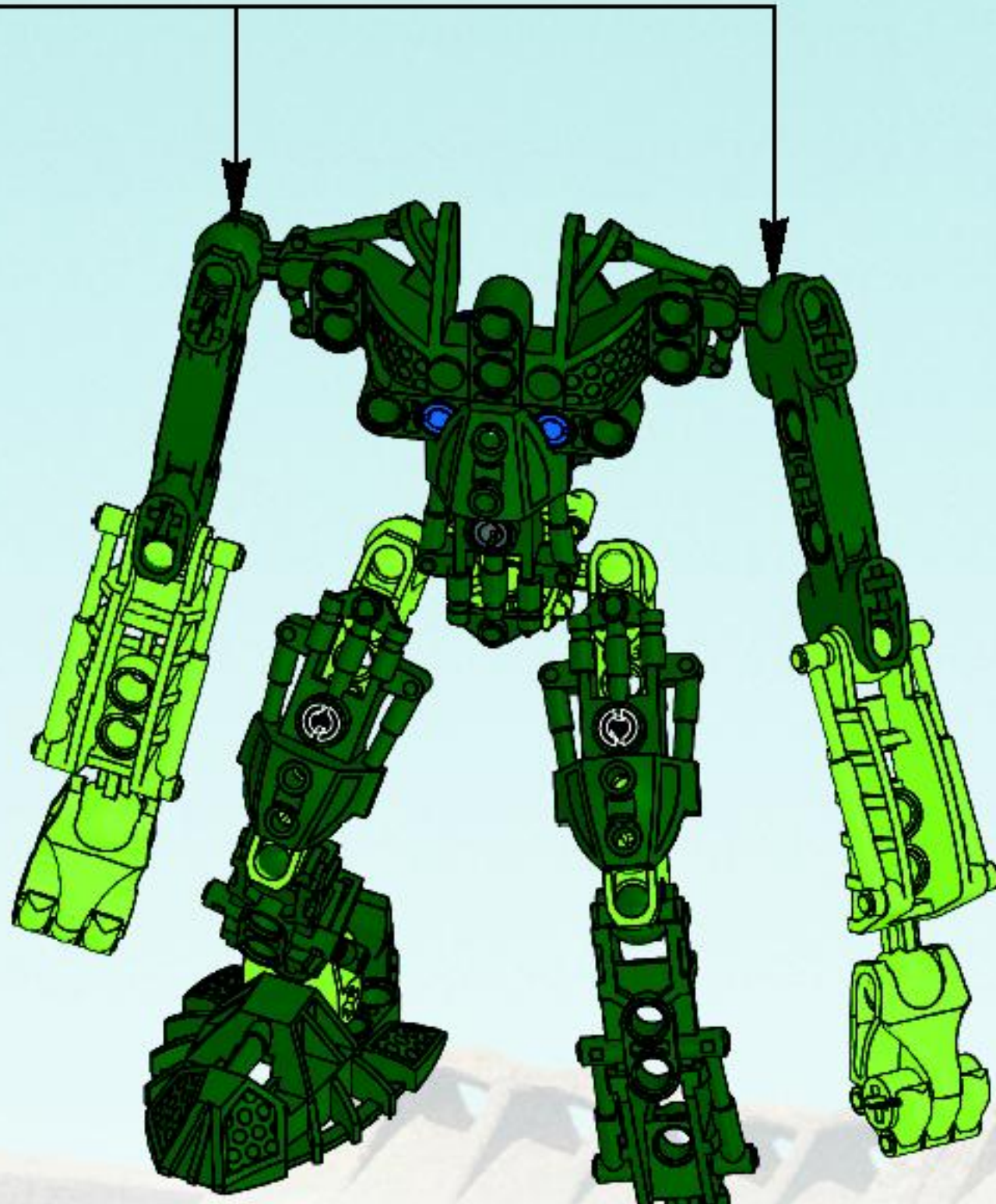



8

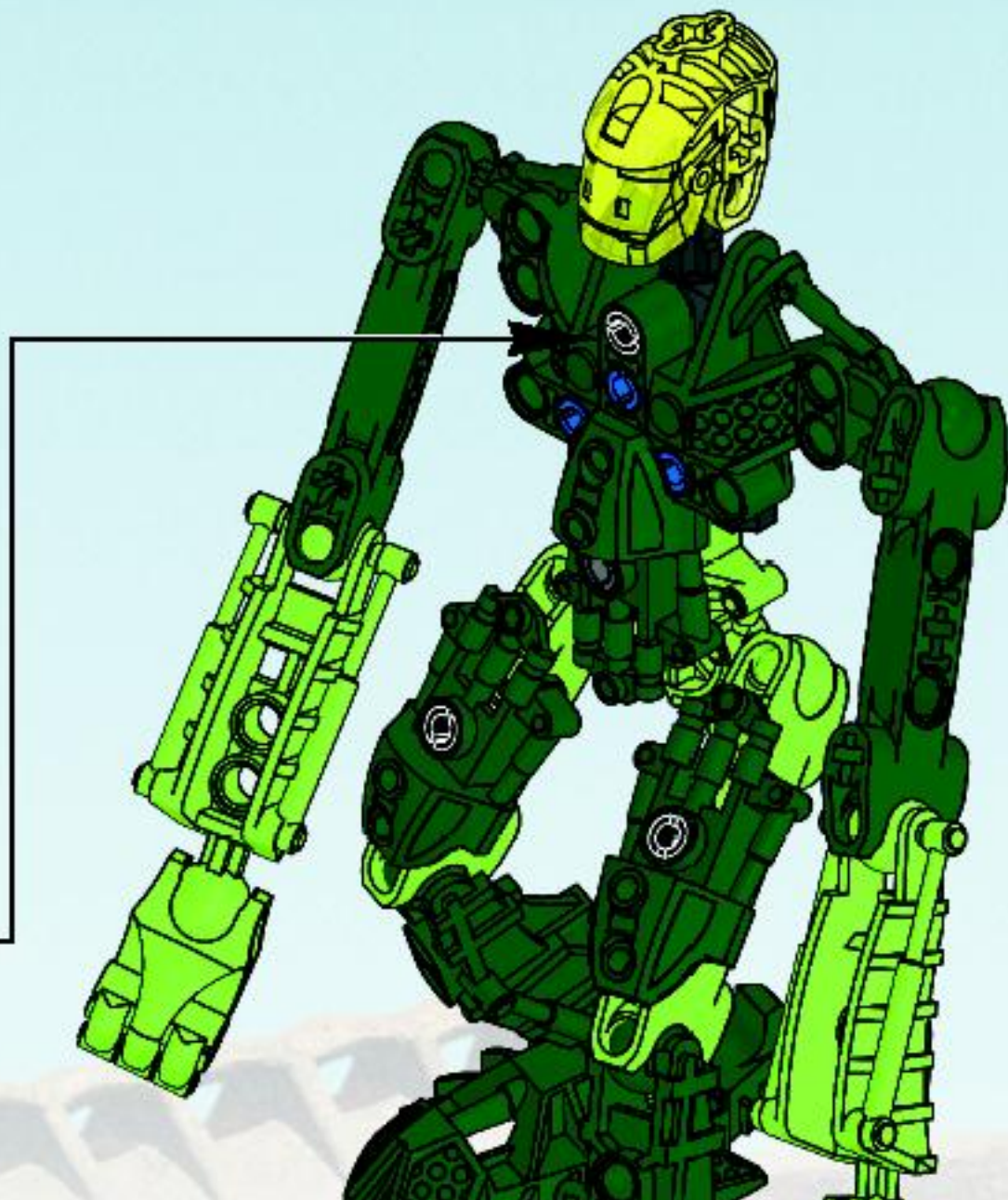
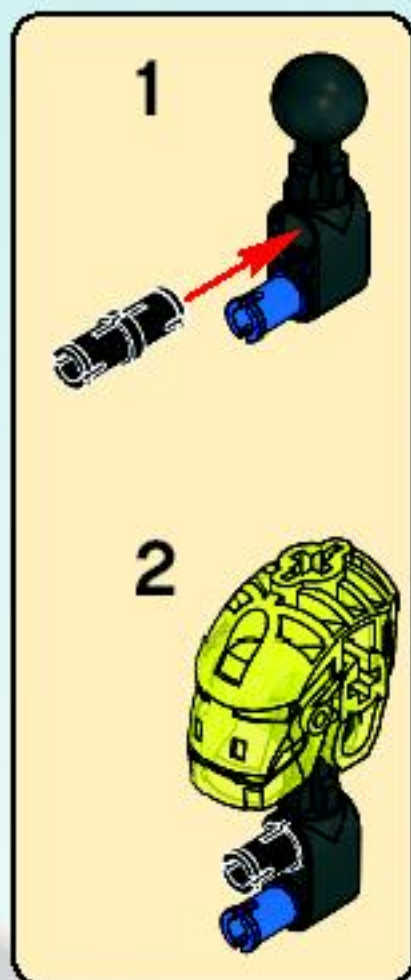

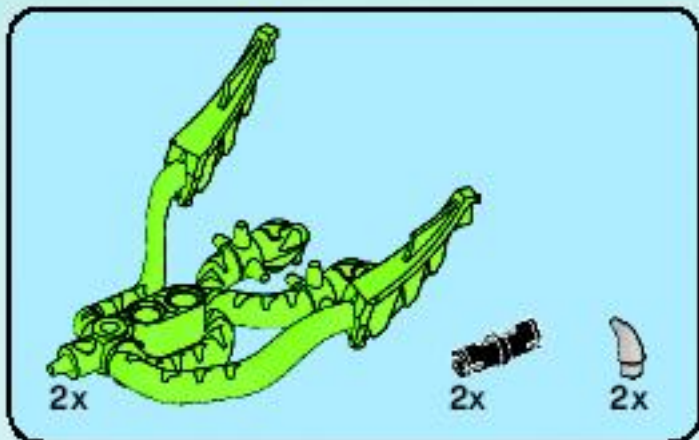

9

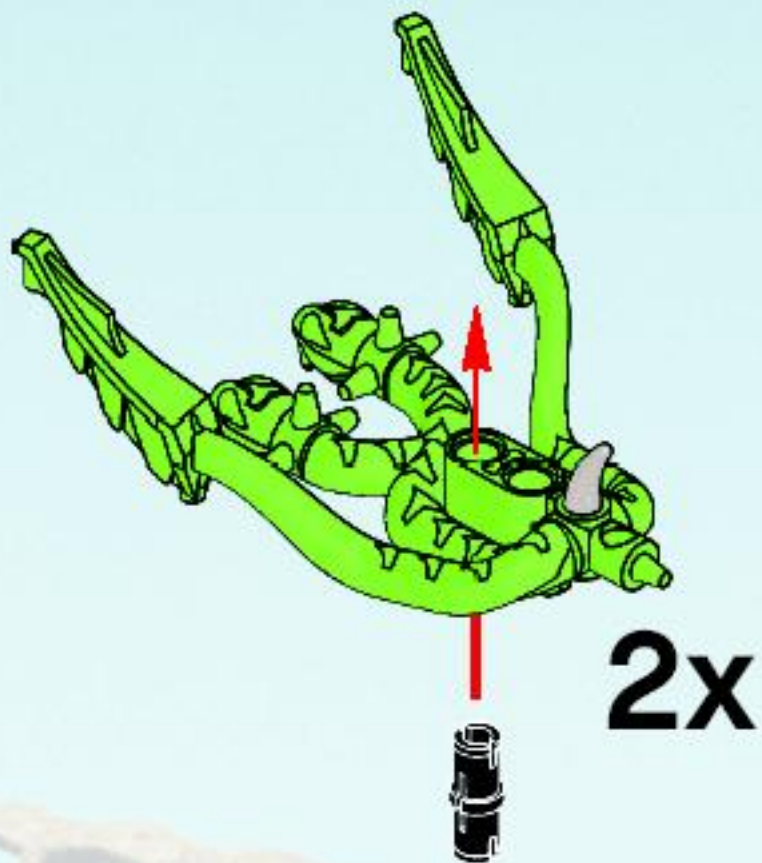

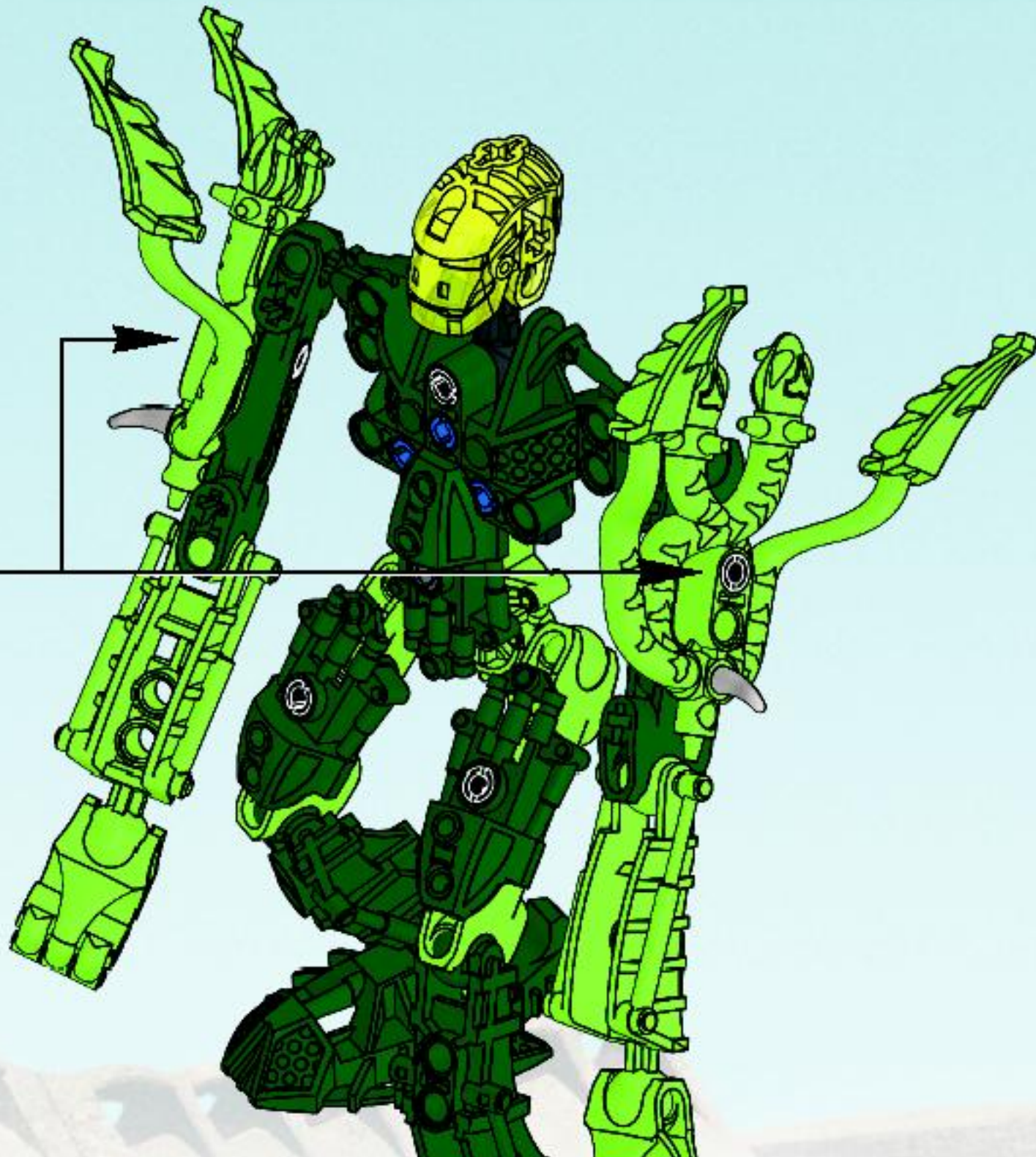

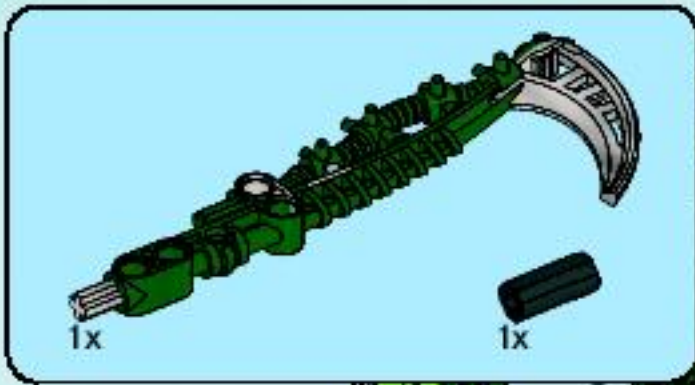

10

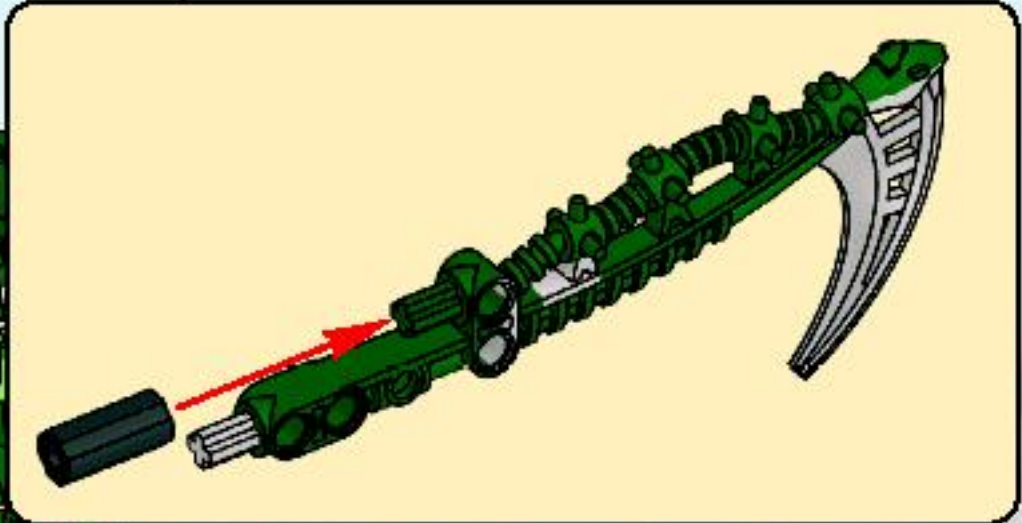
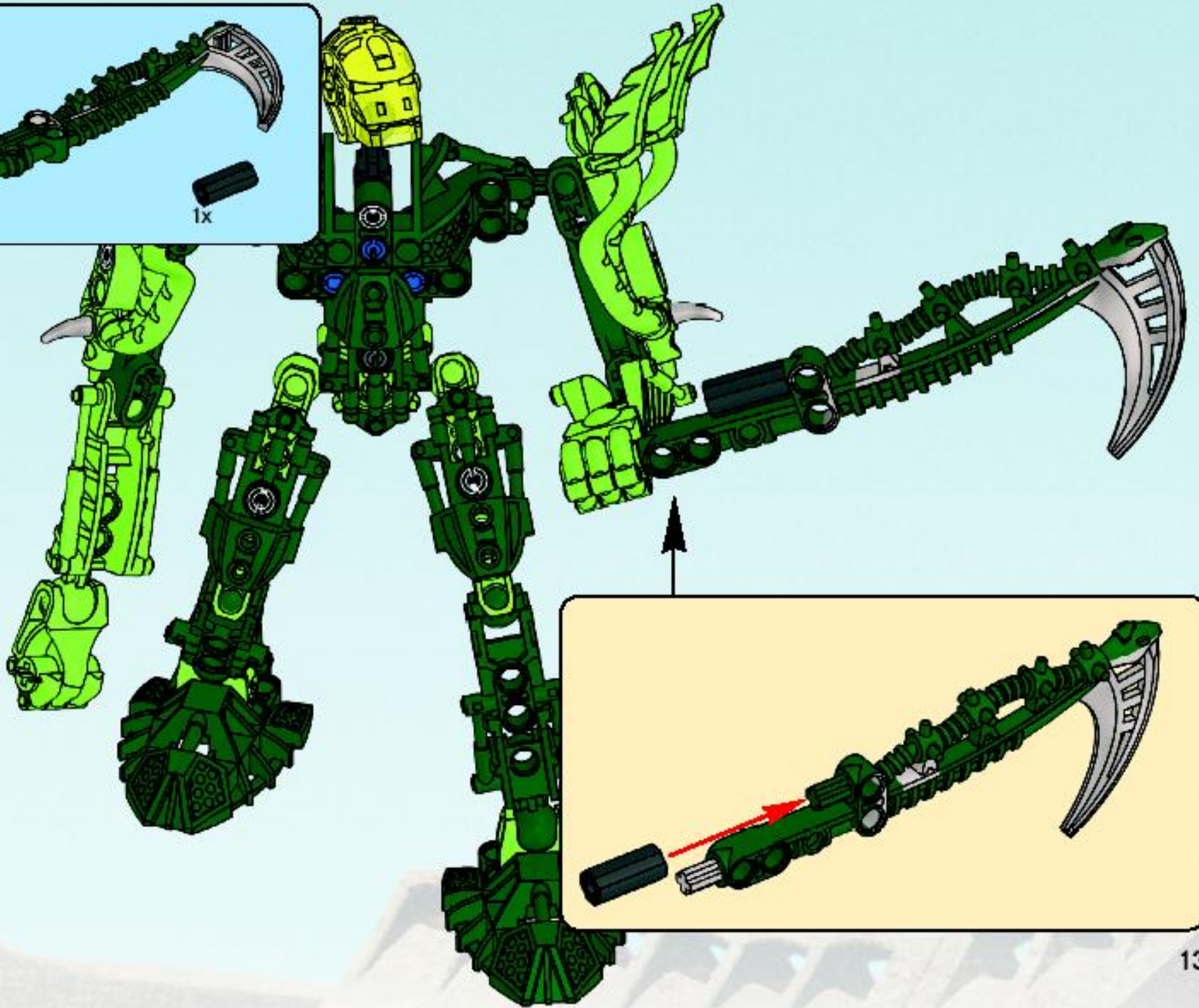

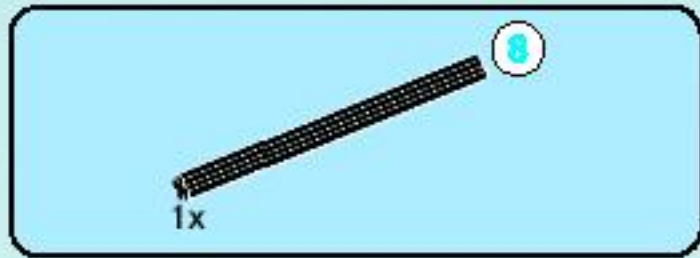

11



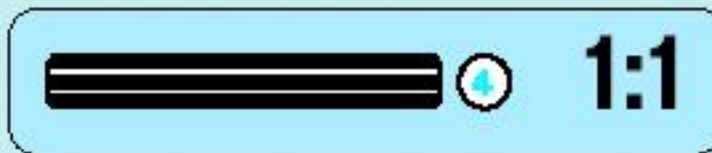

# 12

1

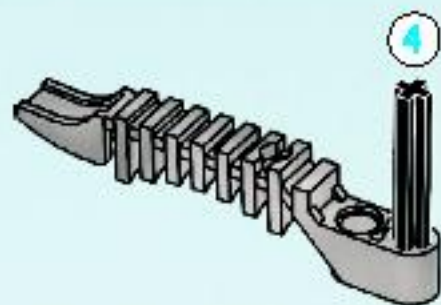

2

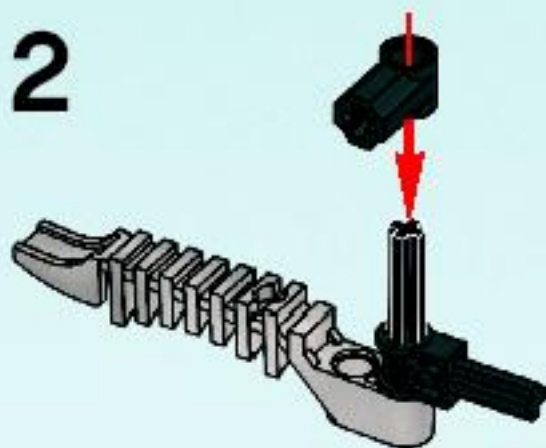

3

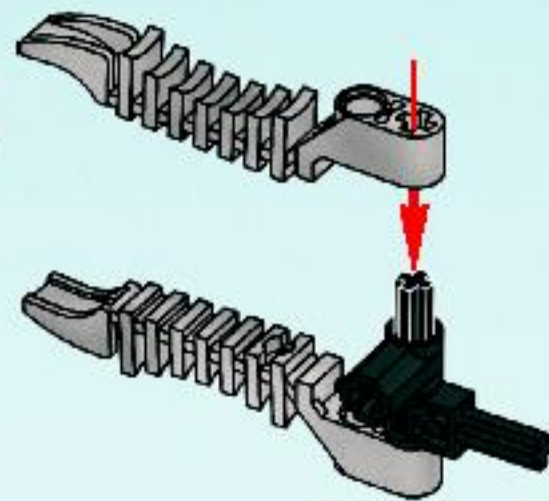

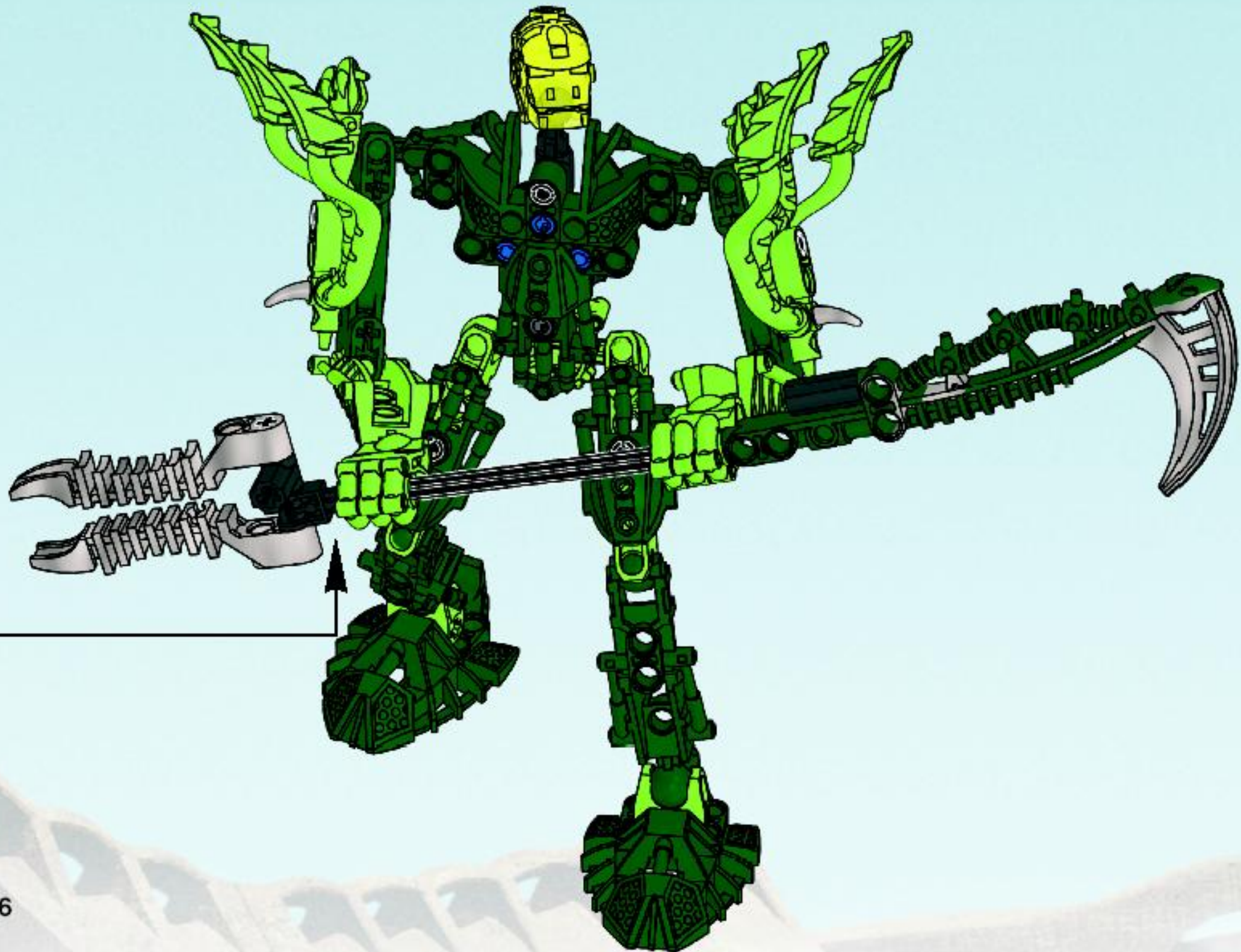



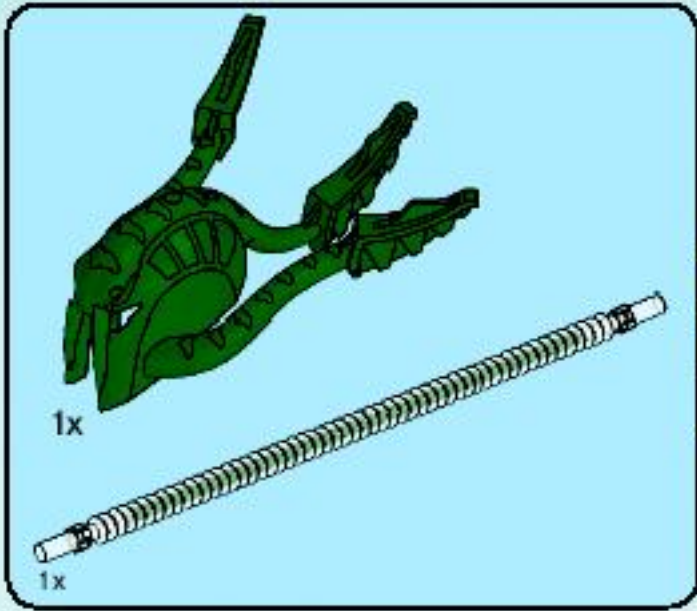

13

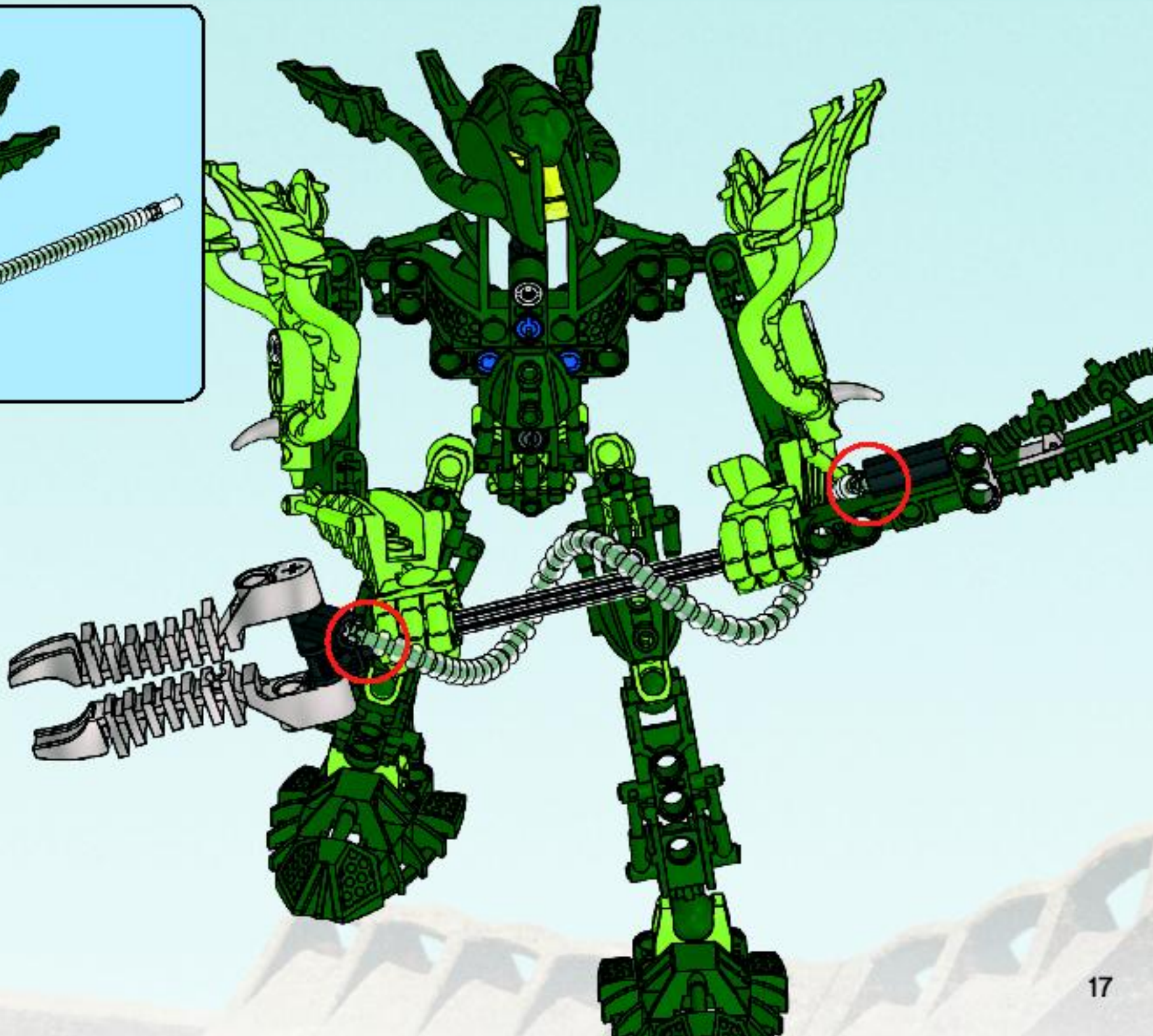

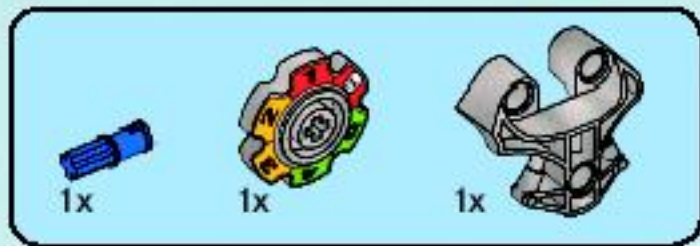

14

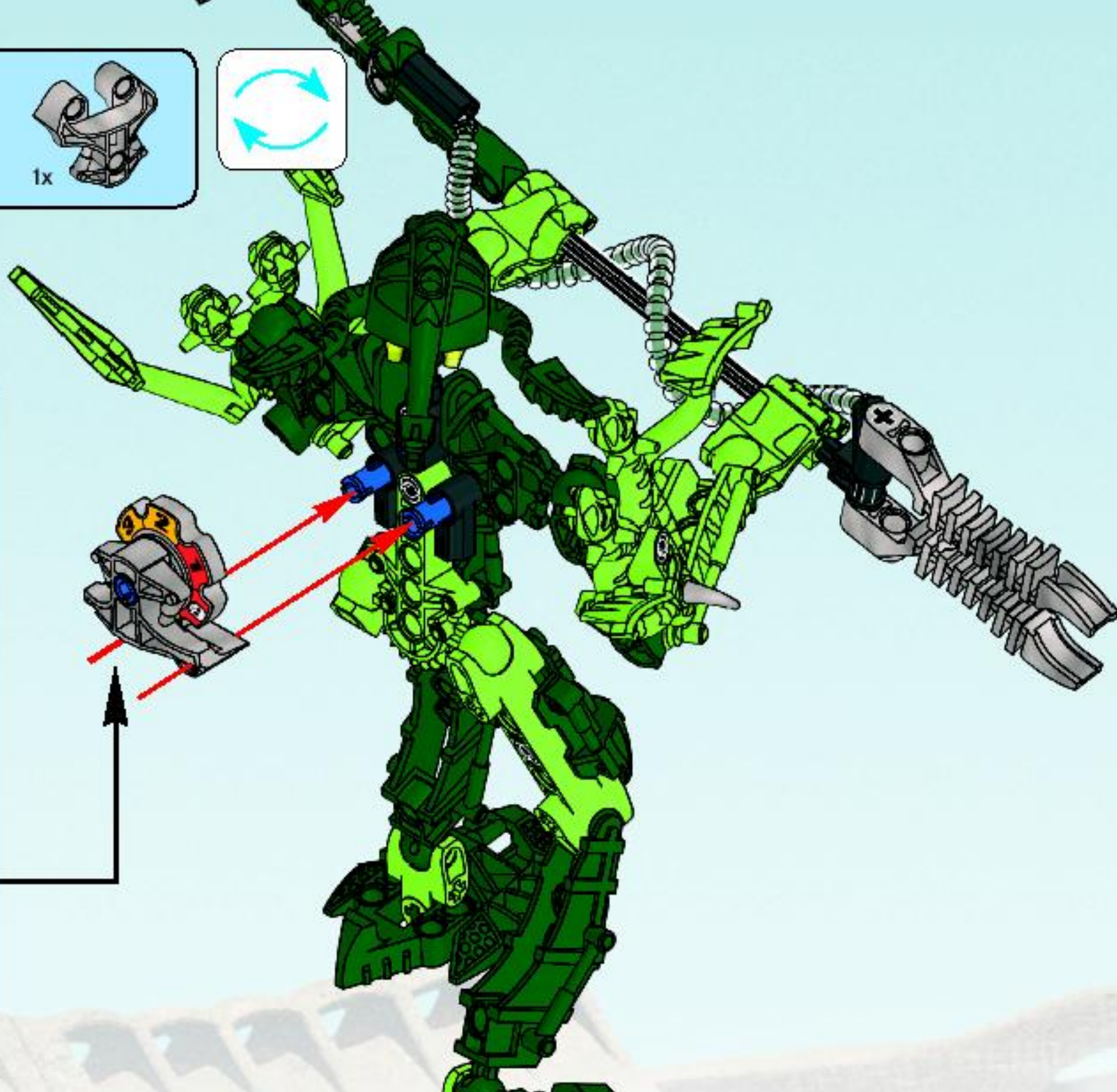
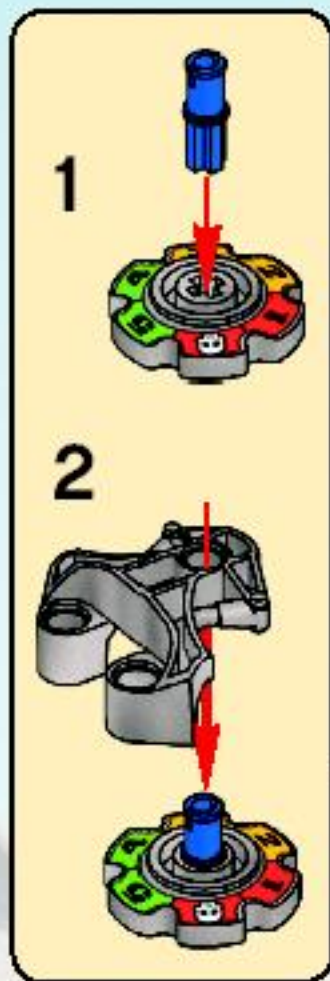



15

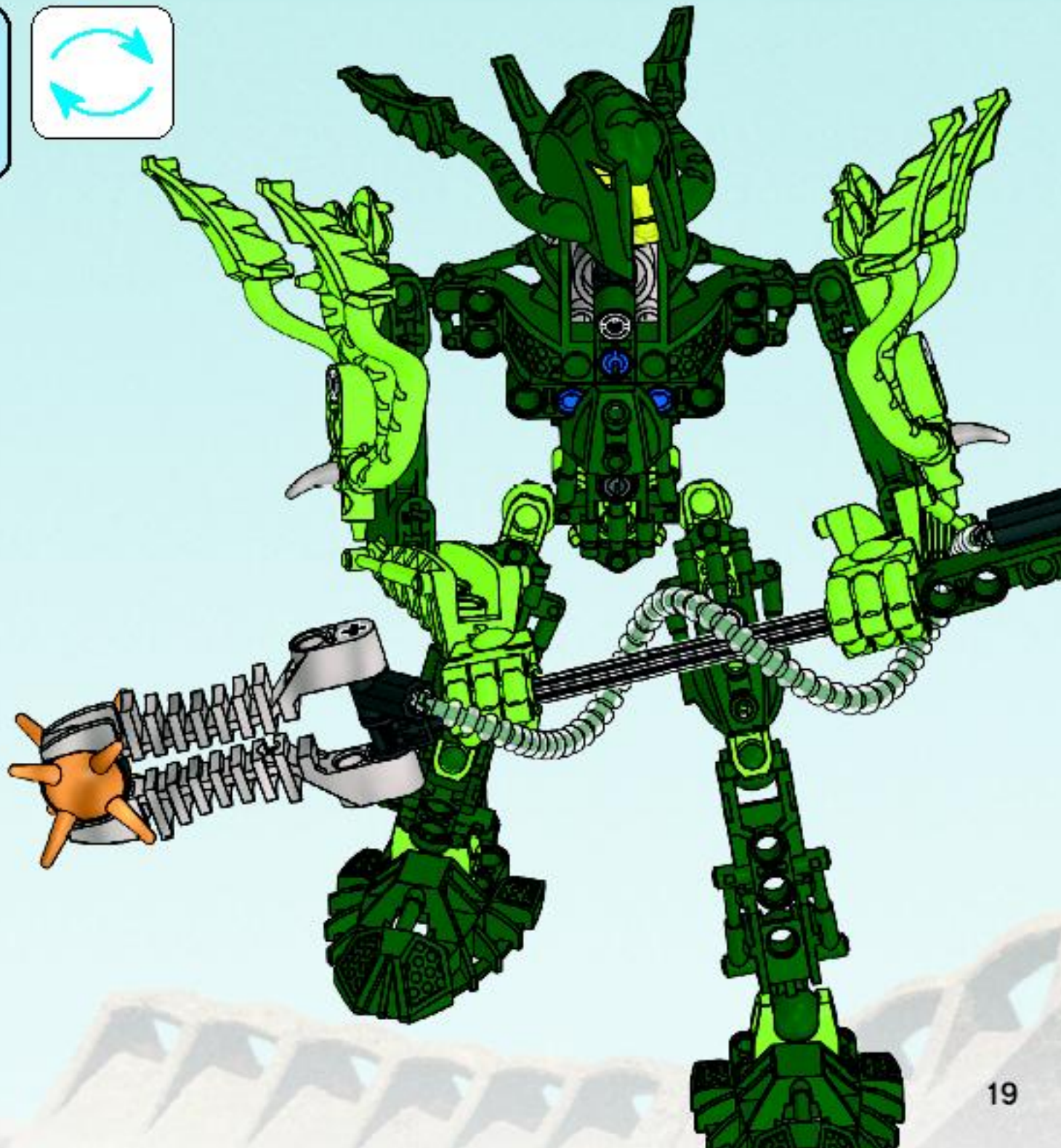

  
2x  
4494086

  
2x  
4206482

  
3x  
4107085

  
7x  
4121715

  
1x  
4247224

  
2x  
4514553

  
1x  
4512363

  
1x  
370526

  
1x  
4211050

  
1x  
4544529

  
1x  
4543428

  
1x  
4560108

  
1x  
370726

  
2x  
4546416

  
1x  
4546585

  
1x  
4107765

  
1x  
4527996



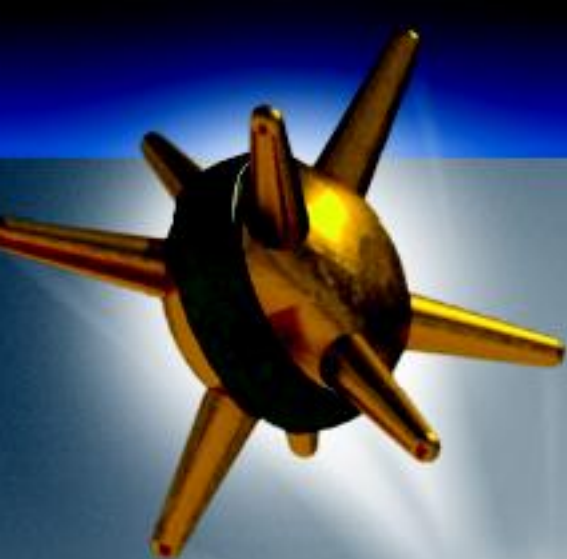

BIONICLE ACTION FIGURE  
**GAME**



## Setting Up Préparer le jeu

## Prepara el juego

This game is about taking the life of your opponent before he takes yours!

1. Set up the game using 2 cans & 2 figures
2. Set the dial to 5
3. Decide who goes first

Pour gagner, il faut que tu t'empares de la vie de ton adversaire avant qu'il ne s'empare de la tienne !

1. Installe le jeu en utilisant 2 boîtes et 2 figurines
2. Positionne le cadran sur 5
3. Décide qui commence

¡El objetivo de este juego es ganar la vida de tu oponente antes que él gane la tuya!

1. Prepara el juego utilizando 2 latas y 2 figuras
2. Coloca el marcador en 5
3. Decide quién empezará



1. Hit can and opponent loses 1 life point or hit figure and opponent loses 2 points.

1. Si tu touches la boîte, ton adversaire perd 1 point de vie et si tu touches la figurine, ton adversaire perd 2 points.

1. Golpea la lata para que tu oponente pierda 1 punto de vida, o golpea la figura para que pierda 2 puntos de vida.





Playing the game: **MOVE**  
Jouer au jeu : **AVANCE**

Cómo jugar: **AVANZA**

1. After shooting move figure to where ball lands.

1. Après avoir tiré, déplace la figurine à l'endroit où la balle a atterri.

1. Después de disparar, mueve la figura hasta el lugar en el que haya caído la bola.



Winning the game  
Gagner la partie

Gana el juego

1. The first player to take all the opponent's life points wins!

1. Le premier joueur qui s'empare de tous les points de vie de son adversaire gagne !

1. ¡El primer jugador que junte todos los puntos de vida de su oponente ganará!



For more rules on advanced multi-figure game play - check out



Weitere Informationen und Anleitungen für coole Spiele mit mehreren Figuren findest du unter



Retrouve toutes les règles du jeu multi-joueur sur



Pour plus d'information concernant les règles des jeux de niveau avancé avec plusieurs figurines, visite



Para más información sobre instrucciones de juego avanzado con varias figuras, consulta



Para más información sobre instrucciones de juego avanzado con varias figuras, consulta

[www.BIONICLE.com](http://www.BIONICLE.com)





8996



8995



8992



8993



8994





# ALL-NEW MOVIE ON DVD

## FALL 2009

UN TOUT NOUVEAU FILM EN DVD AUTOMNE 2009  
UNA PELÍCULA TOTALMENTE NUEVA EN DVD OTOÑO 2009





**STRONIUS**  
8984



**ACKAR**  
8985



**VASTUS**  
8986

# GLATORIAN LEGENDS



**KIINA**  
8987



**GELLU**  
8988



**MATA NUI**  
8989

[www.bionicle.com](http://www.bionicle.com)

# BIONICLE



SKOPIO XV-1  
8996



BARANUS V7  
8994



THORNATUS V9  
8995

[www.BIONICLE.com](http://www.BIONICLE.com)

**FREE! GRATIS! GRATUIT!**



**club**  
MAGAZINE™

**www.LEGOclub.com**



**00800 5346 5555\***        

  **1-866-534-6258 • 1-877-518-5346**

US & Canada only

Canada seulement

\* FreePhone. Mobile charges may apply. \* Numéro sans Frais. Les Frais peuvent s'appliquer avec les téléphones cellulaires.

\* GelbWahlPreis, Kosten für Anrufer aus Mobilfunknetzen können abweichen. \* Gratis telefonnummer via mobiele lijn. \* Telefoonnummer gratis, maar de ringer Pro kostzake Fox.

\* Tel gratuit, altda ringer Frais en kost teleFon.



VISIT THE WORLD'S  
BIGGEST LEGO® SHOP!

**www.LEGOshop.com**



## WIN LEGO® PRODUCTS

Fill out a survey and you might WIN a cool LEGO product!  
NO PURCHASE NECESSARY  
Open to all residents where not prohibited  
Go to [www.nielsenaim.dk/LEGO](http://www.nielsenaim.dk/LEGO) to fill out a survey for a chance to win a LEGO product.

## WIN LEGO® PRODUCTEN

Vul een enquêteformulier in en maak kans op een cool LEGO® product!  
Kopen niet nodig  
Iedereen uit landen waar geen enquêteverbod geldt mag deelnemen.  
Ga naar [www.nielsenaim.dk/LEGO](http://www.nielsenaim.dk/LEGO), vul een enquêteformulier in en maak kans op een LEGO product.

## GEWINNE LEGO® PRODUKTE

Nimm an der Umfrage teil und GEWINNE ein tolles LEGO® Produkt!  
Die Teilnahme am Gewinnspiel führt zu keinerlei Kaufverpflichtungen  
Teilnahme in allen nicht ausgeschlossenen Ländern möglich  
Wir verlosen unter allen Teilnehmern der Umfrage auf [www.nielsenaim.dk/LEGO](http://www.nielsenaim.dk/LEGO) LEGO Produkte.

## GAGNE DES PRODUITS LEGO®

Réponds à un questionnaire et tu pourrais GAGNER un produit LEGO® très cool !  
Aucune obligation d'achat.  
Ouvert à tous les résidents des pays autorisés.  
Visite [www.nielsenaim.dk/LEGO](http://www.nielsenaim.dk/LEGO) pour répondre à un questionnaire et avoir une chance de gagner un produit LEGO.

## レゴ®製品を「当てよう」

アンケートに記入して、カッコいいレゴ®製品を当てよう！  
お買い上げの必要はありません。  
禁止されていない限り、すべての皆様にご利用いただけます。  
[www.nielsenaim.dk/LEGO](http://www.nielsenaim.dk/LEGO)にアクセスして、アンケートにご記入ください。当選者にはレゴ®製品を差し上げます。

