



# NEXO KNIGHTS



70361







1

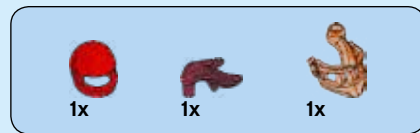

2



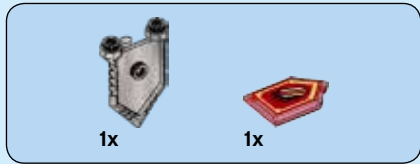

3



4

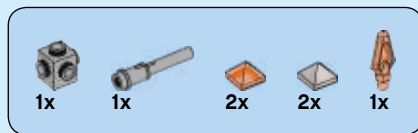

4

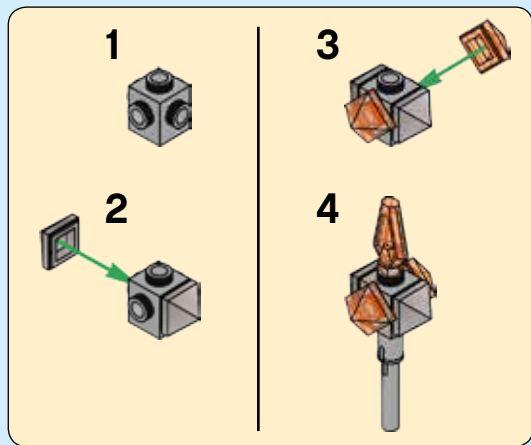



2x



1x

1

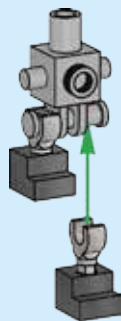

1x



1x

2

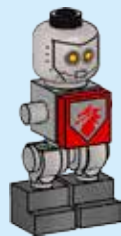



2x



2x

3

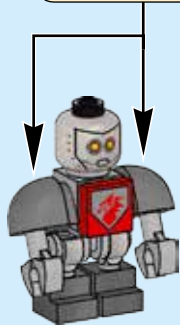
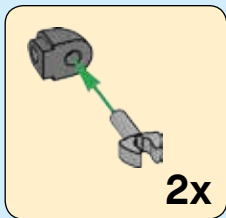

1x



1x



1x

4

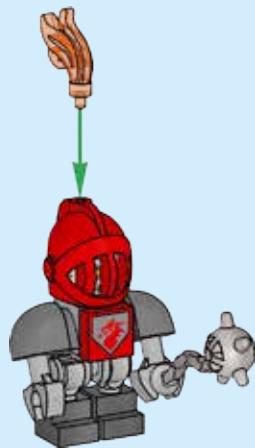

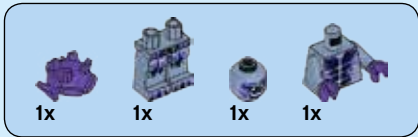

1

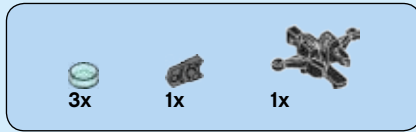
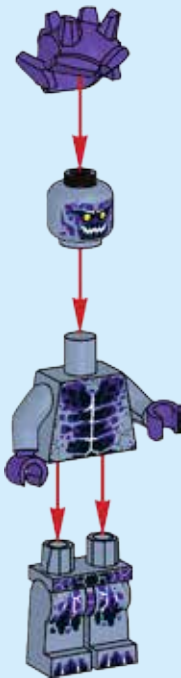

2

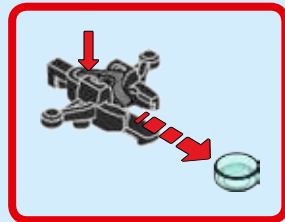
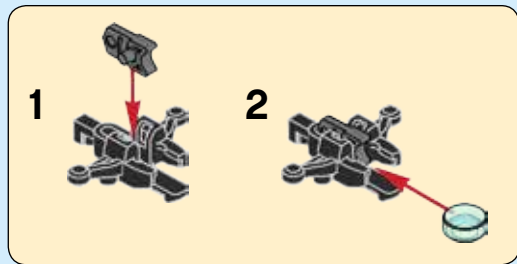





**3**

**1**



**2**



**3**





1

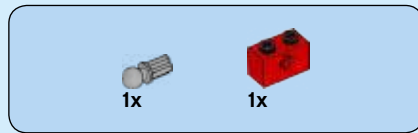
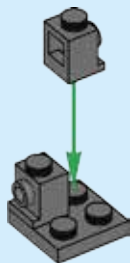

2

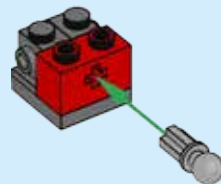



2x

3

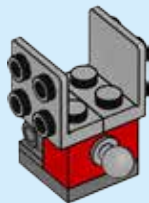

1x



1x

4

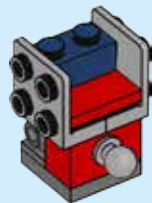



2x



2x

5

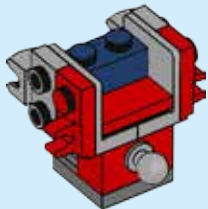

2x

6

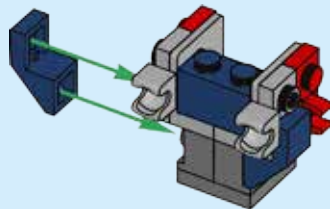
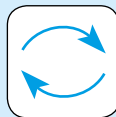

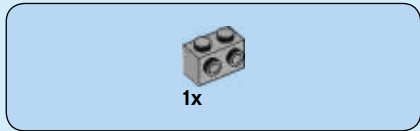

7

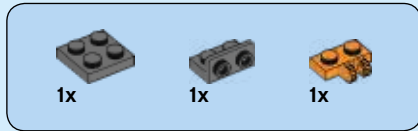
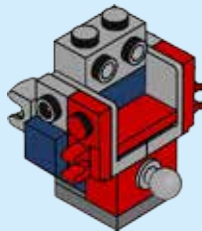
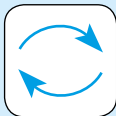

8

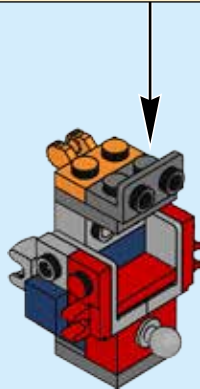
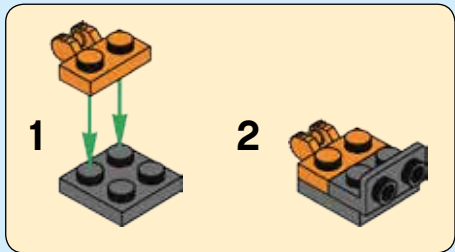

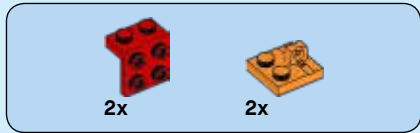

9

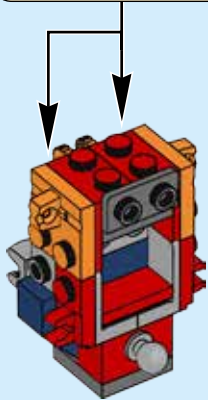
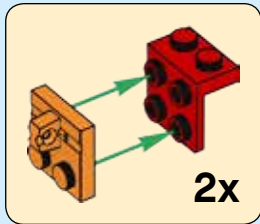

10

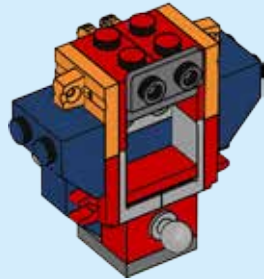



2x

11

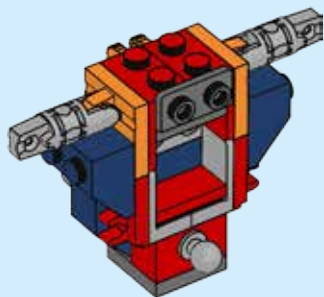

2x

12

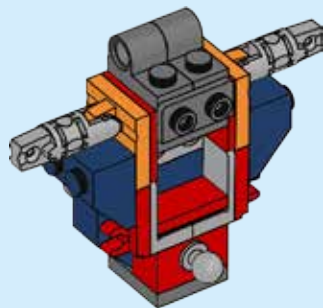



2x



1x

# 13

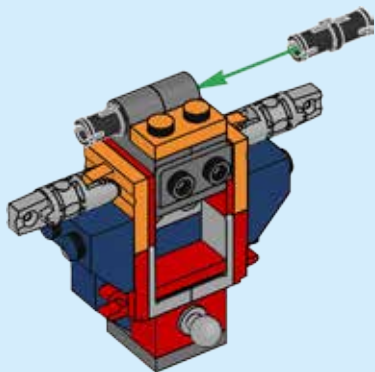

16



1x

# 14

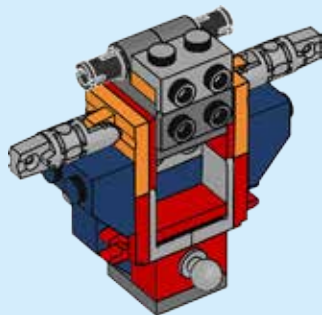





15

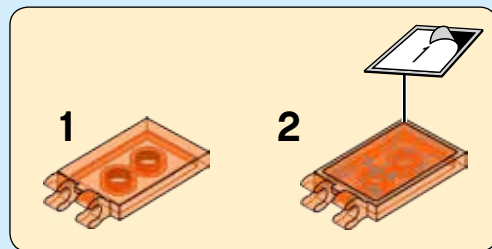

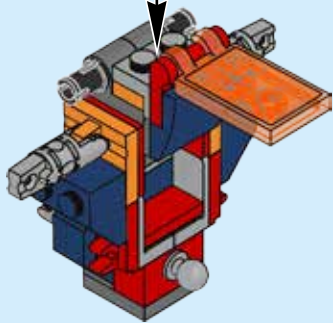

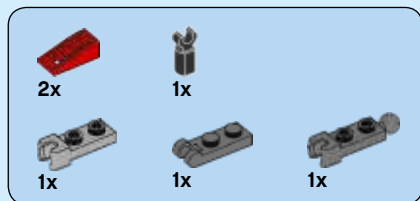

16

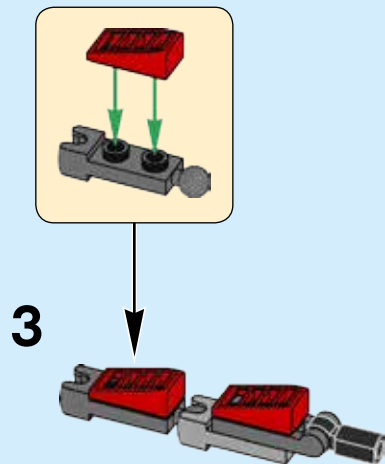
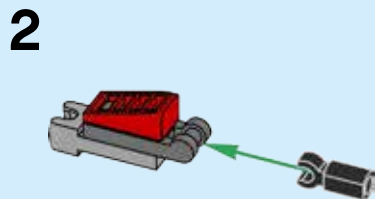
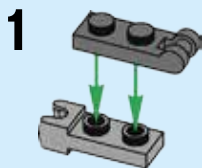

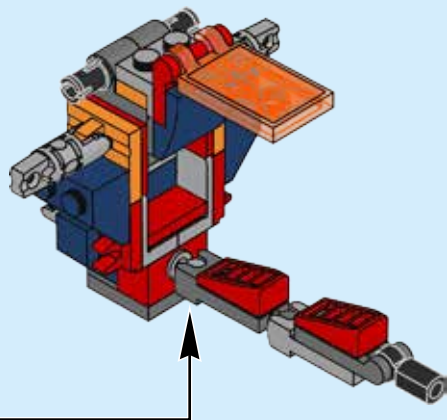

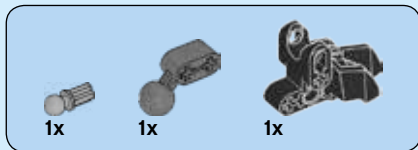

17

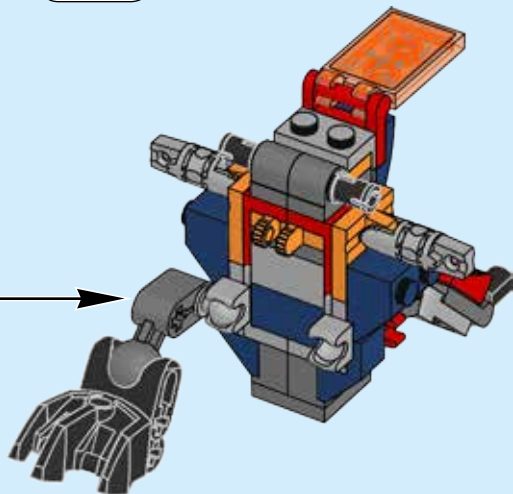
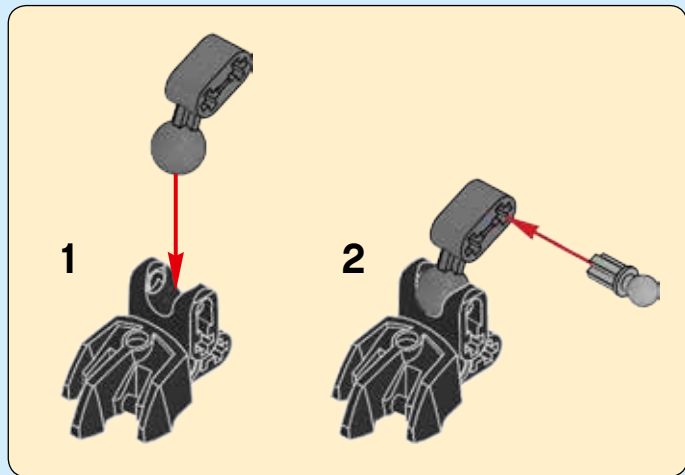
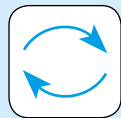

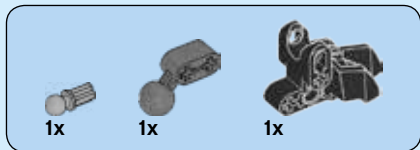

18

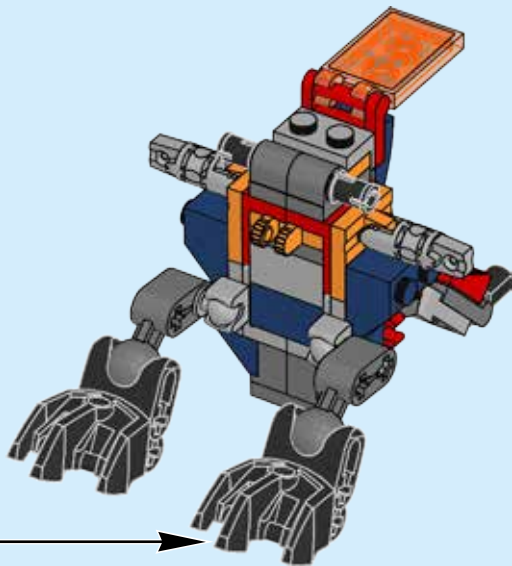
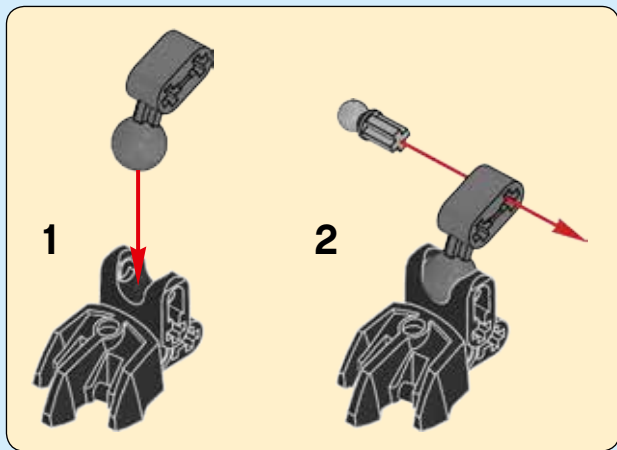



2x



1x

19

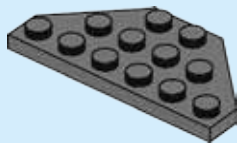

2x

20

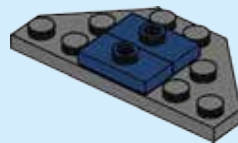

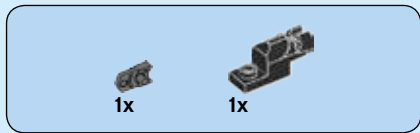

21

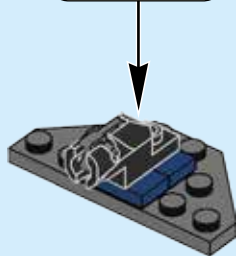
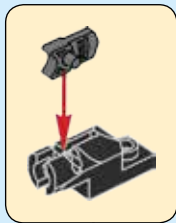

22

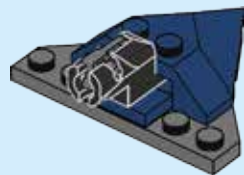



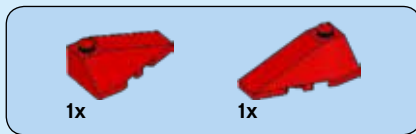

23

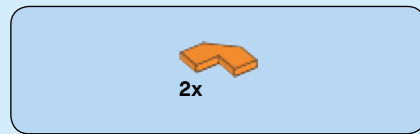
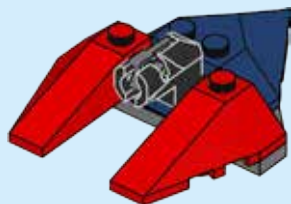

24

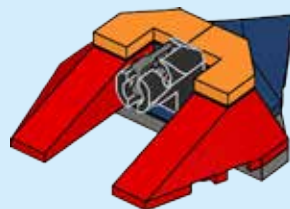

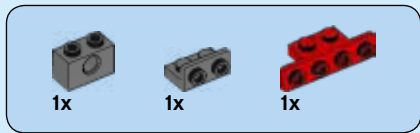

25

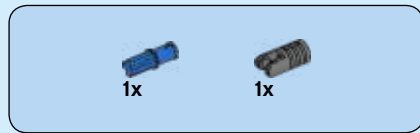
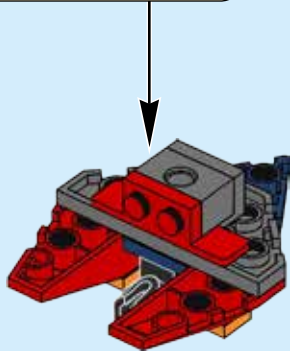
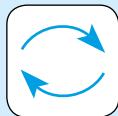
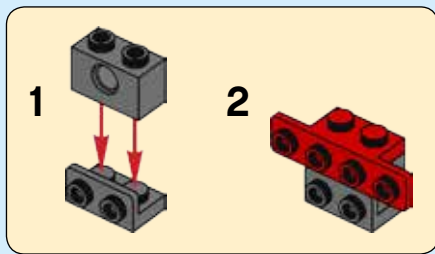

26

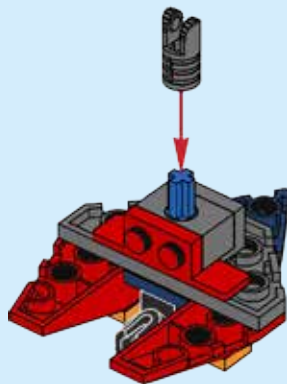

2x

27

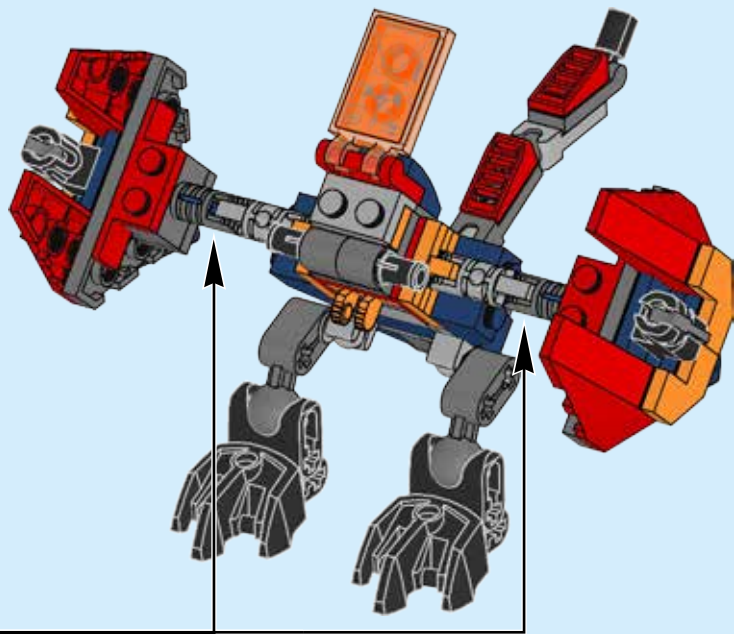

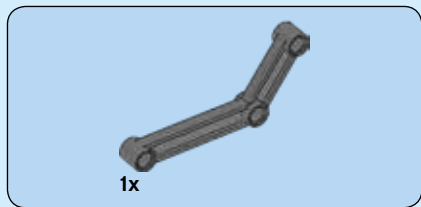

28

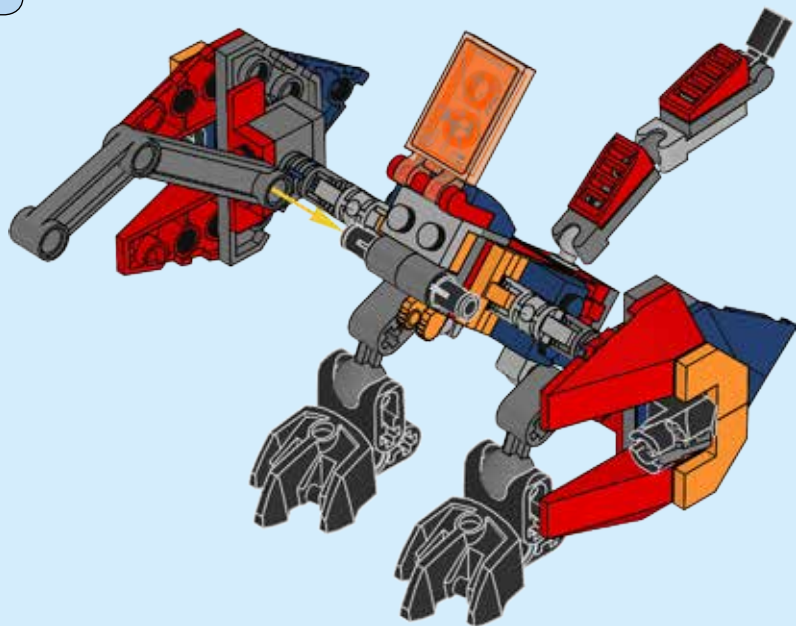



1x



1x

# 29

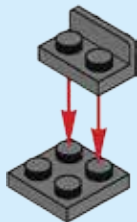

2x

# 30

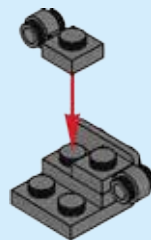



2x

31

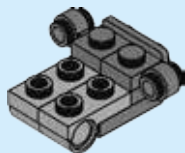

2x



1x

32

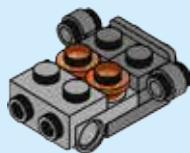



1x

**33**



2x

**34**

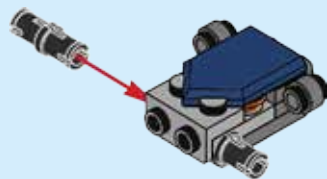



1x

35

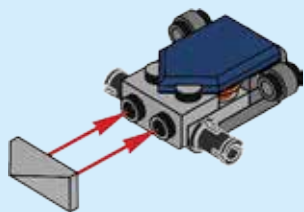

2x

36

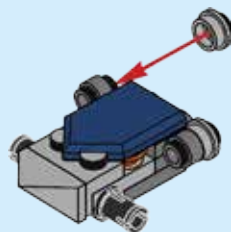





1x

37

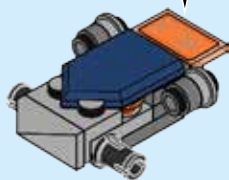
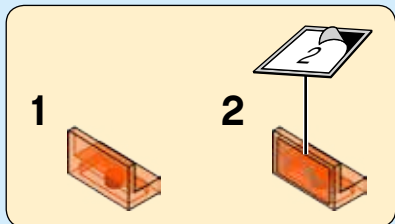

2x

38

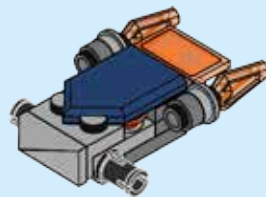

39

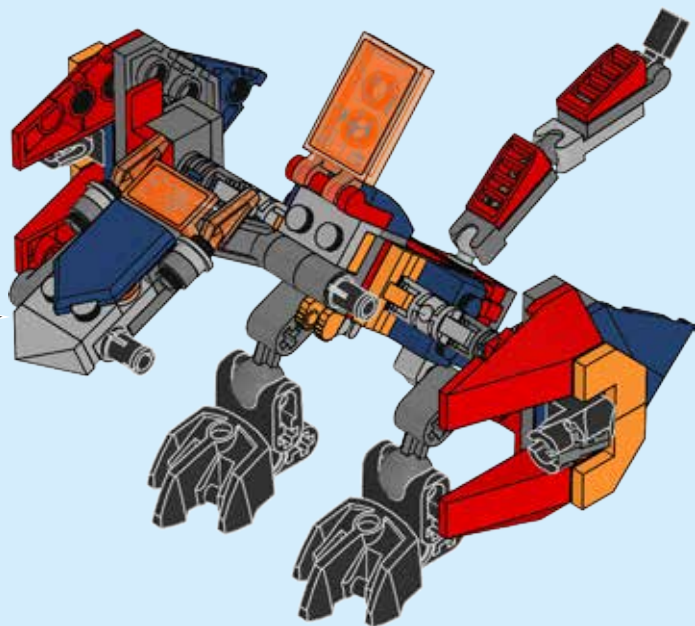

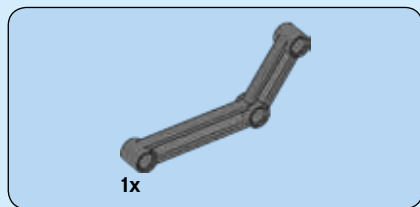

40

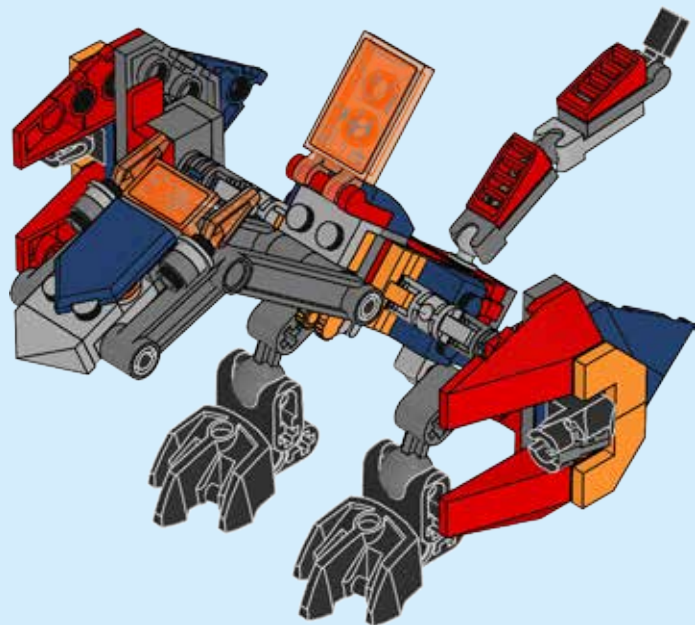

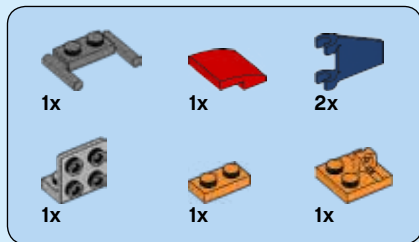

**41**

**1**

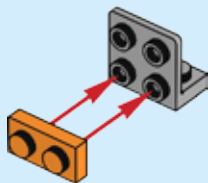

**2**



**3**

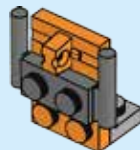

4

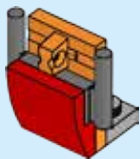

5

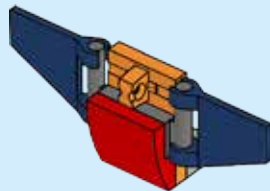

6

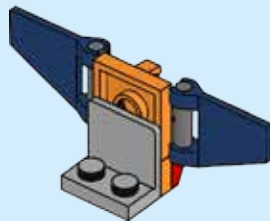

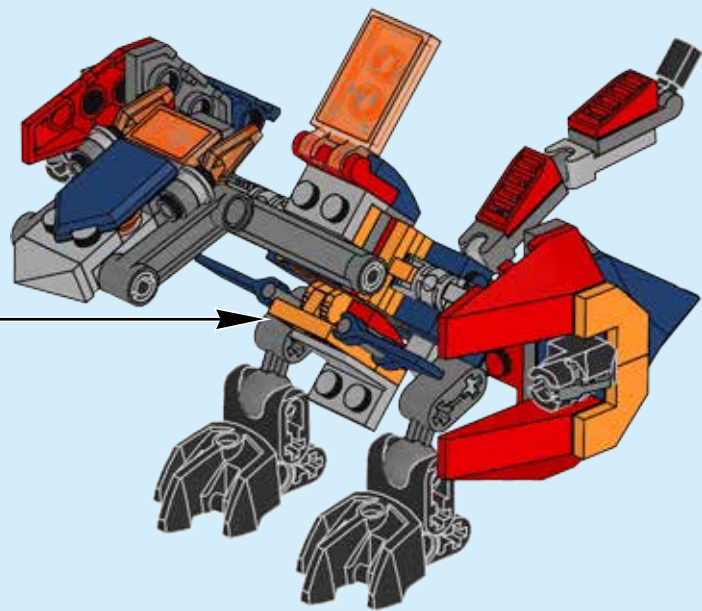



42

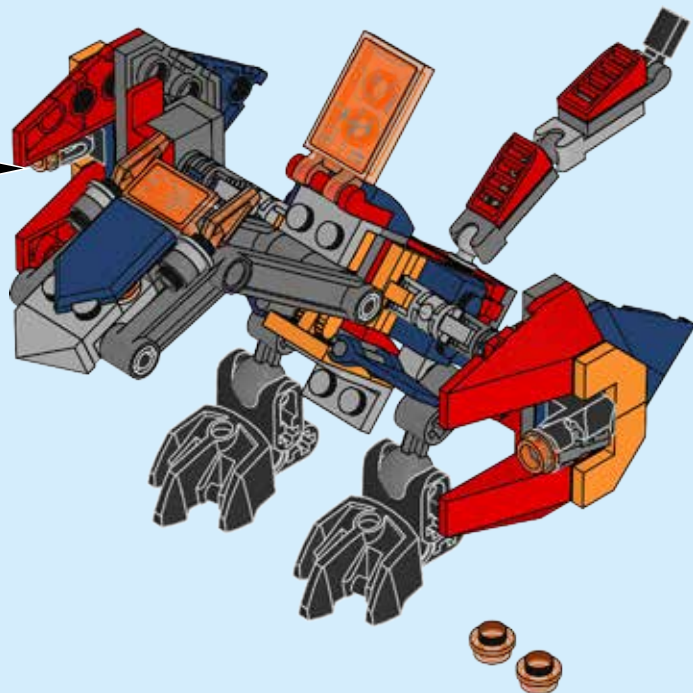

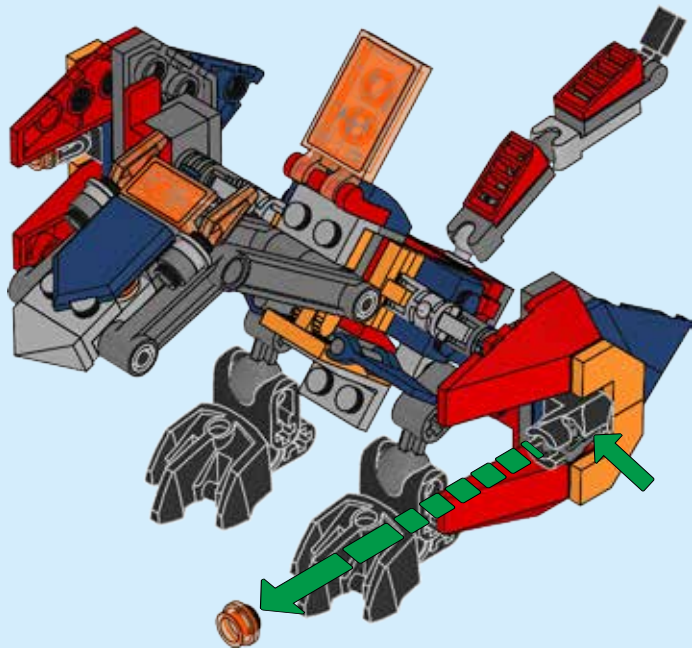



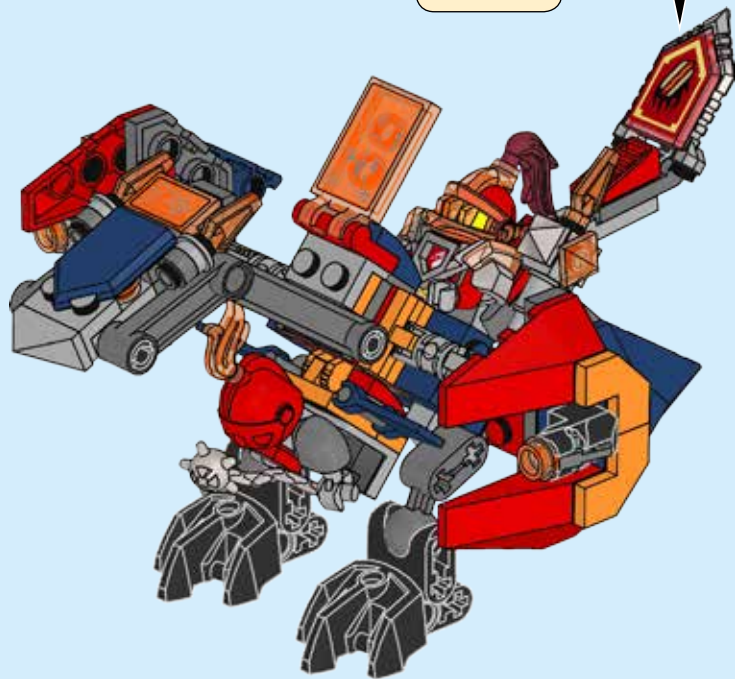





1



70363

70361

2



3



70361 + 70363

COMBINE  
YOUR POWERS  
COMBINE  
TES POUVOIRS  
COMBINA  
TUS PODERES



DISCOVER MORE COMBINATIONS  
DÉCOUVRE PLUS DE COMBINAISONS  
DESCUBRE MÁS COMBINACIONES



NEXO KNIGHTS



70362



70341



70363



70351



70354



70354



70355



70355



70356



70357



LEGO.COM/NEXOKNIGHTS



# NEXO KNIGHTS™



LEGO® NEXO KNIGHTS™: MERLOK 2.0



1



2



3

[LEGO.COM/DEVICECHECK](http://LEGO.COM/DEVICECHECK)



# NEXO KNIGHTS



70357



70356



70355



70354



70353



70361



70362



70363



70364



70365



70366



70373



# NEXO KNIGHTS™



**DOWNLOAD THE FREE APP:**  
**TÉLÉCHARGE L'APPLI GRATUITE :**  
**DESCARGA LA APP GRATIS:**

**LEGO® NEXO KNIGHTS™: MERLOK 2.0**  
[LEGO.com/devicecheck](http://LEGO.com/devicecheck)

All materials might not be available in all markets.  
Certains matériels peuvent ne pas être disponibles dans certains marchés.  
Ciertos materiales podrían no estar disponibles en todos los mercados.

[LEGO.COM/NEXOKNIGHTS](http://LEGO.COM/NEXOKNIGHTS)





**LEGO** NEXO KNIGHTS





# NEXO KNIGHTS



**ROGUL  
ROGOULE**  
70354



**BRICKSTER  
BRIQUEUR**  
70355



**BRICKSTER  
BRIQUEUR**  
70357



**BOULDRON  
CABOCHON**  
MONSTRUO DE PIEDRA  
70353 / 70356



**HARPY  
HARPIE**  
HARPIA  
70353



**WHITE STONE STATUE**  
STATUE DE PIERRE BLANCHE  
ESTATUA DE PIEDRA BLANCA  
70357



**BRICKSTER  
BRIQUEUR**  
70357



**BRICKSTER  
BRIQUEUR**  
70356



**BRICKSTER  
BRIQUEUR**  
70354

**JESTRO**  
70356



**STONE STOMPER**  
MARCHEUR DE PIERRE  
CAMINANTE DE PIEDRA  
70353 / 70357 / 70361



**STONE STOMPER**  
MARCHEUR DE PIERRE  
CAMINANTE DE PIEDRA  
70357



**STONE STOMPER**  
MARCHEUR DE PIERRE  
CAMINANTE DE PIEDRA  
70355



**LORD KRAKENSKULL**  
70355



**GENERAL GARG**  
GENERAL GARG  
70356

\* Weapons and decorations vary by set • Les armes et les décorations varient selon l'ensemble •



BATTLE SUIT CLAY  
CLAY EN ARMURE DE COMBAT  
CLAY CON ARMADURA  
DE COMBATE  
70362



BATTLE SUIT MACY  
MACY EN ARMURE DE COMBAT  
MACY CON ARMADURA  
DE COMBATE  
70363



BATTLE SUIT AARON  
AARON EN ARMURE DE COMBAT  
AARON CON ARMADURA  
DE COMBATE  
70364



BATTLE SUIT AXL  
AXL EN ARMURE DE COMBAT  
AXL CON ARMADURA  
DE COMBATE  
70365



BATTLE SUIT LANCE  
LANCE EN ARMURE DE COMBAT  
LANCE CON ARMADURA  
DE COMBATE  
70366



CLAY  
70353



MACY  
70356 / 70361



AARON  
70355 / 70357



AXL  
70354



LANCE  
70357



STONE CLAY  
CLAY DE PIERRE  
CLAY DE PIEDRA  
70356



KING'S GUARD  
GARDE DU ROI  
GUARDIA DEL REY  
70357



KING HALBERT  
ROI HALBERT  
REY HALBERT  
70357



FANCY PANTS  
70357



MACY BOT  
BOT DE MACY  
70361



AARON BOT  
BOT DE AARON  
70355



AXL BOT  
BOT DE AXL  
70354



ROBIN  
70357



HAMLETTA  
70357



MERLOK 2.0  
70357

Las armas y accesorios varían según el set

# WIN

GO TO [WWW.LEGO.COM/PRODUCTFEEDBACK](http://WWW.LEGO.COM/PRODUCTFEEDBACK) AND  
GIVE US YOUR SHORT **FEEDBACK** ABOUT THIS  
LEGO® SET FOR A CHANCE TO WIN  
A COOL LEGO PRIZE.

Terms & Conditions apply

## LEGO.com/productfeedback



### GEWINNE

Erzähle uns auf  
[www.LEGO.com/productfeedback](http://www.LEGO.com/productfeedback)

etwas über die Erfahrungen, die du mit  
diesem LEGO® Set gemacht hast, und  
sichere dir die Chance auf einen coolen  
LEGO Preis!

Es gelten die Teilnahmebedingungen

### GAGNE

Rends-toi sur  
[www.LEGO.com/productfeedback](http://www.LEGO.com/productfeedback)

et donne-nous quelques commentaires sur  
ce produit LEGO® pour avoir une chance  
de gagner un prix LEGO !

Voir Conditions Générales

### GANAN

Visita  
[www.LEGO.com/productfeedback](http://www.LEGO.com/productfeedback)

y envíanos tu opinión acerca de este set  
LEGO®. ¡Participarás en el sorteo de un  
premio LEGO!

Términos y Condiciones aplicables

### 获取奖品

登录  
[www.LEGO.com/productfeedback](http://www.LEGO.com/productfeedback)

给出关于此乐高®套装的简短反馈，  
就有机会获得炫酷乐高奖品

《条款及条件》适用

LEGO, the LEGO logo, NEXO KNIGHTS and the NEXO KNIGHTS logo are trademarks of the/son des marques de commerce du/son marcas registradas de LEGO Group.  
©2017 The LEGO Group.

6204041