

The LEGO logo is displayed in its characteristic white font with a black outline, set against a red square background.

BIONICLE®

70785



WARNING: CHOKING HAZARD.
Toy contains small parts and a small ball.
Not for children under 3 years.



LEGO.com/bionicle





AVERTISSEMENT : RISQUE D'ÉTOUFFEMENT.

Le jouet contient des petites pièces ainsi qu'une petite boule.
Il ne convient pas aux enfants de moins de 3 ans.



ADVERTENCIA: PELIGRO DE ASFIXIA.

Juguete que contiene partes pequeñas y una pelota pequeña.
No recomendado para niños menores de 3 años.



MIX
Paper

FSC FSC® C117818

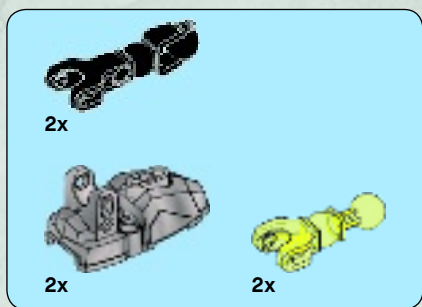

1

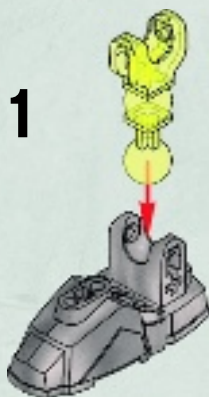

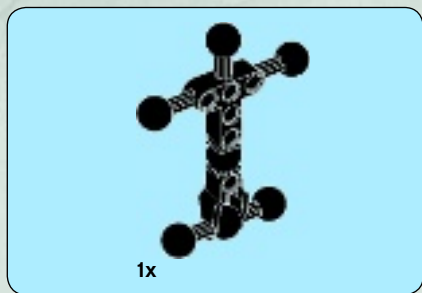

2

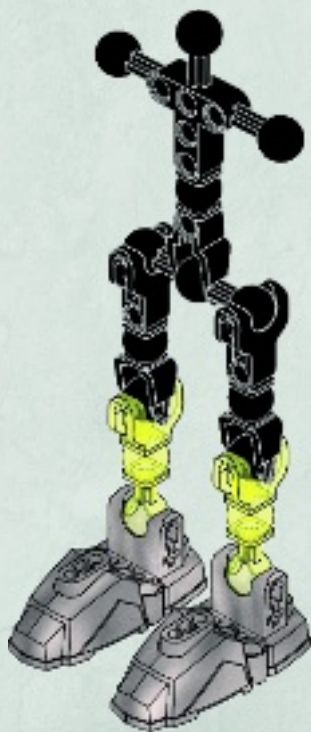



2x

3

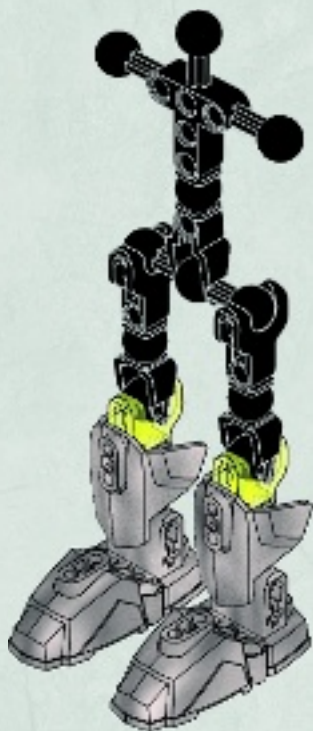

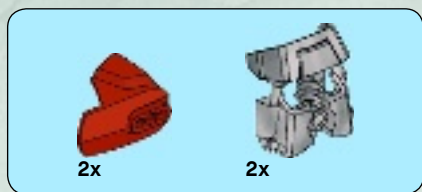

4

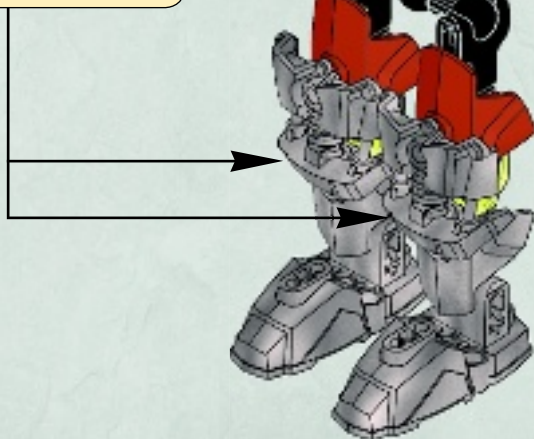
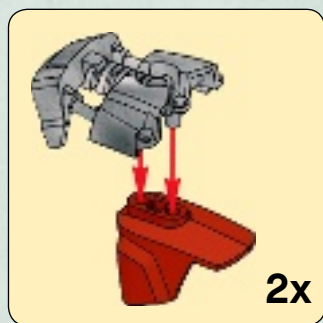



5



6





7

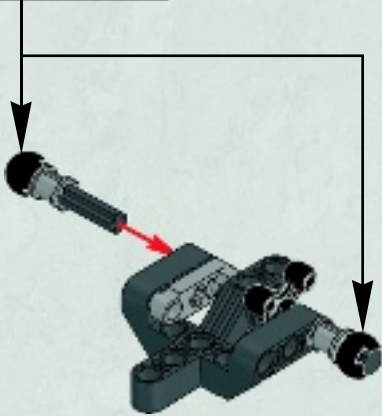
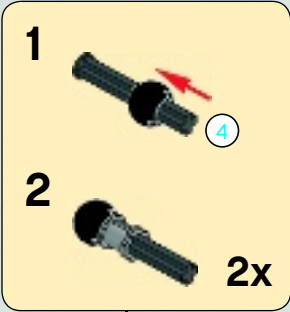

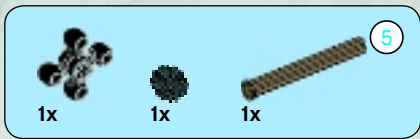

8

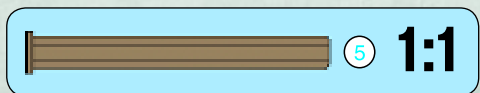
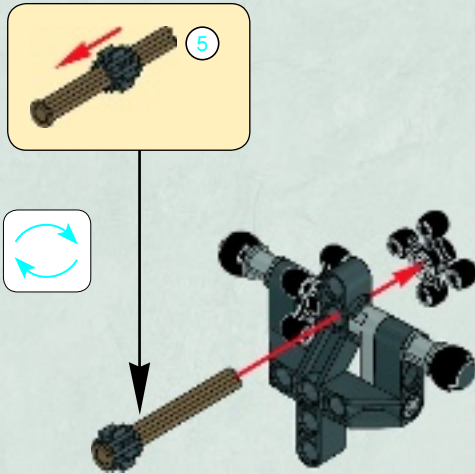



1x



1x

9

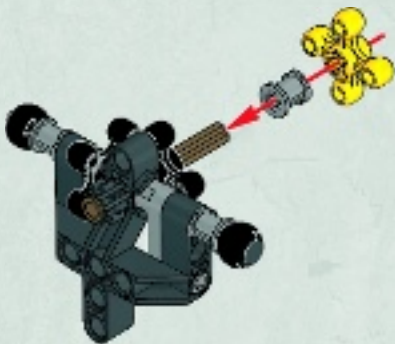

1x



1x



1x

10

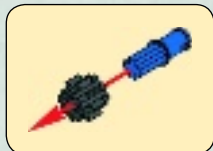

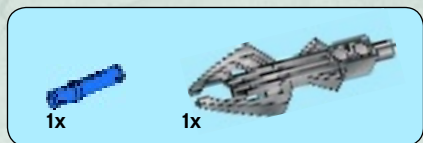

11

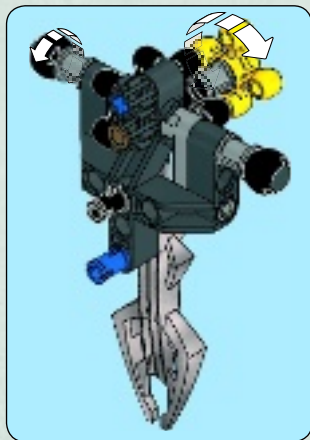
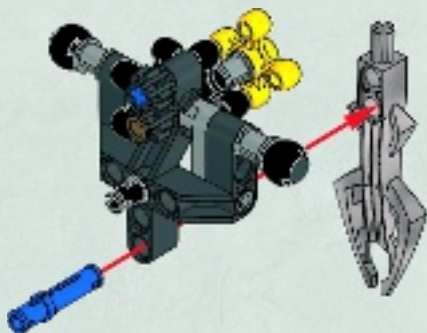

12

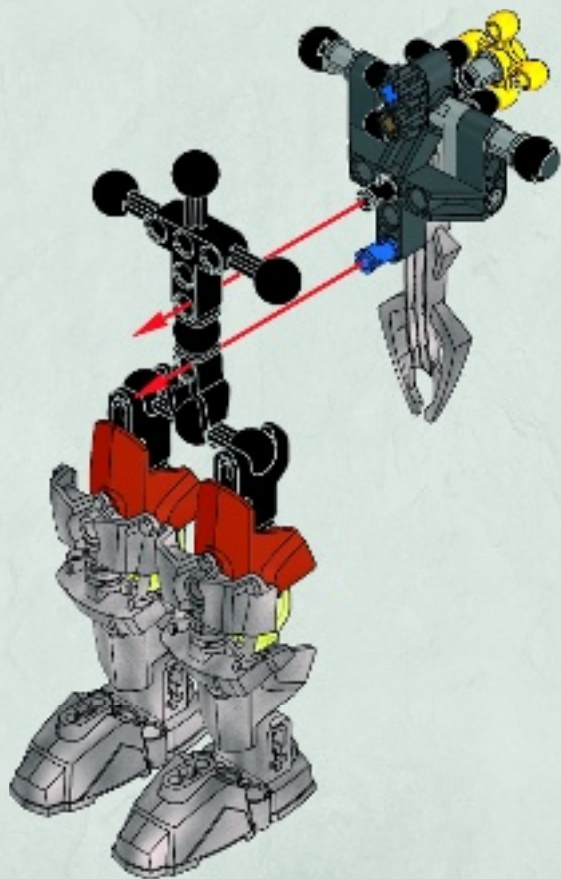



1x



2x

13

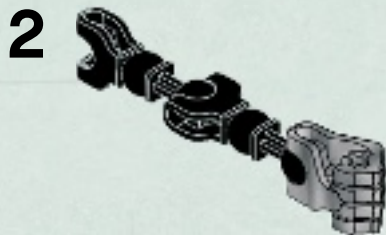
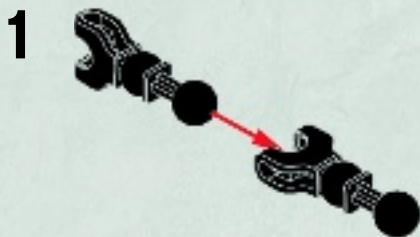

14

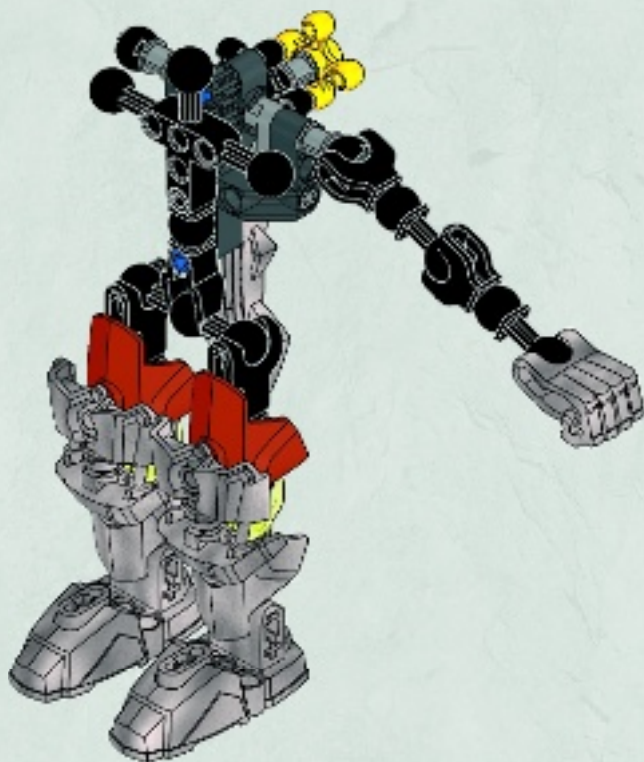



1x



2x

15

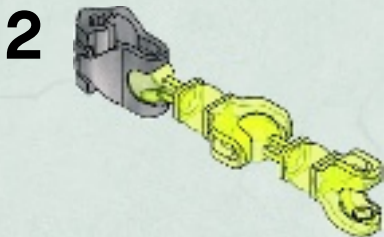
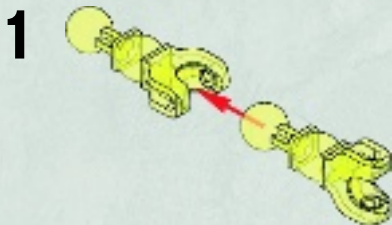

16

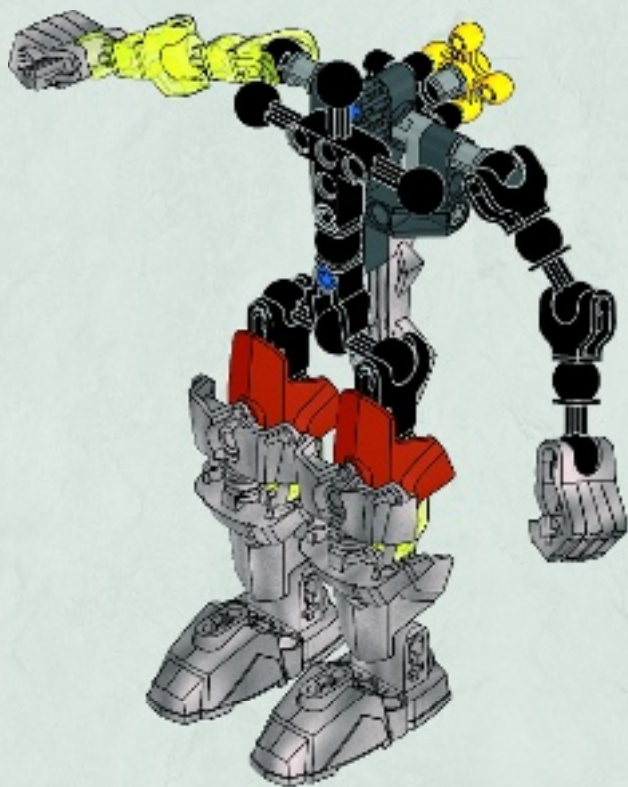



2x

17

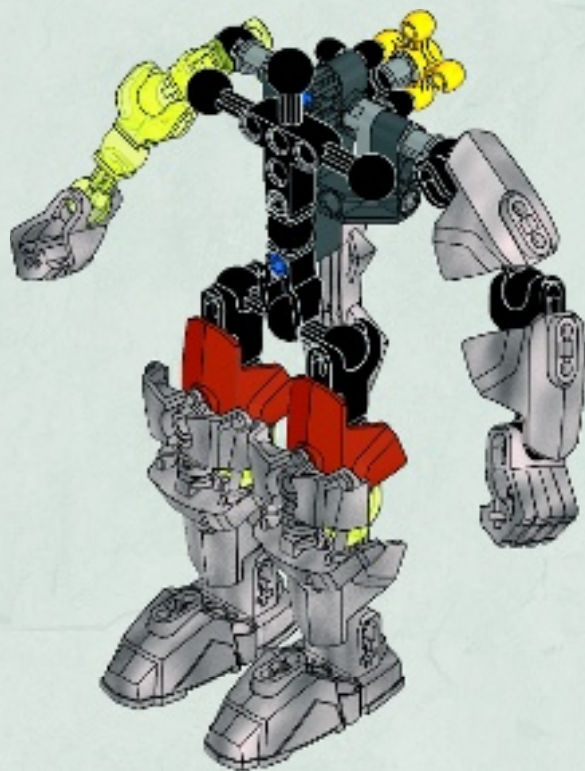

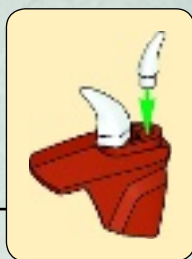
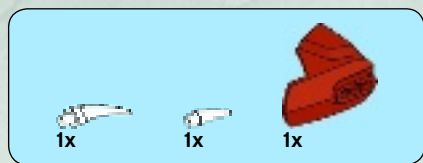

18

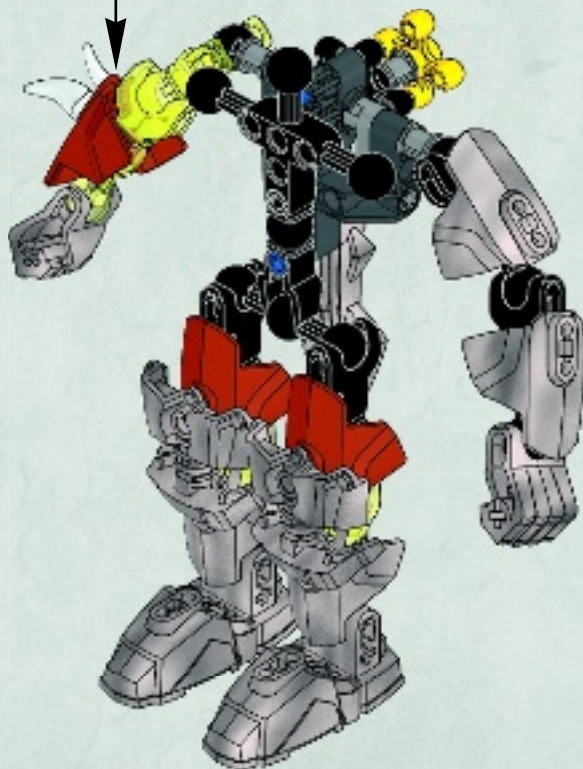

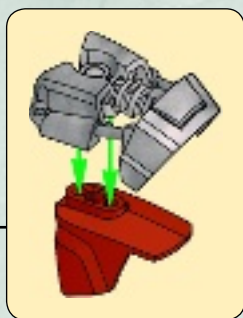
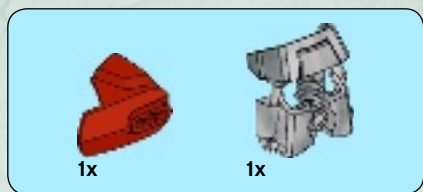

19

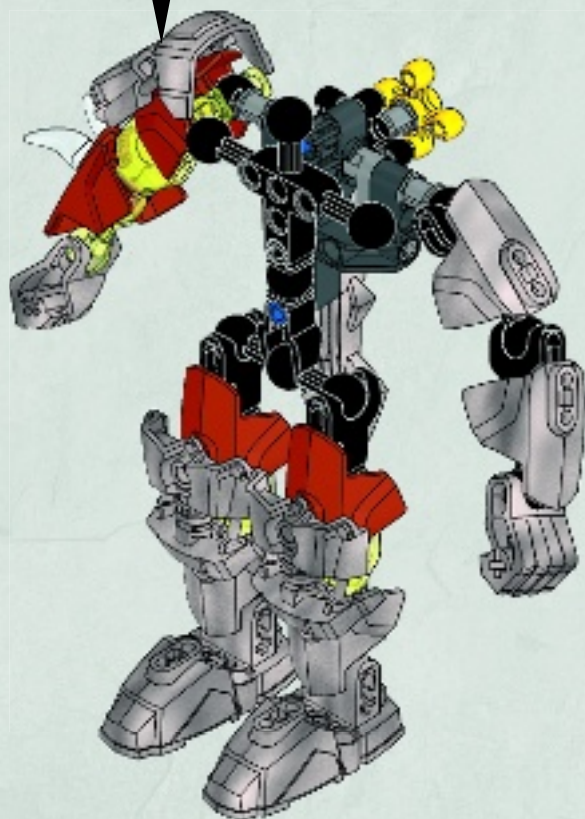



20

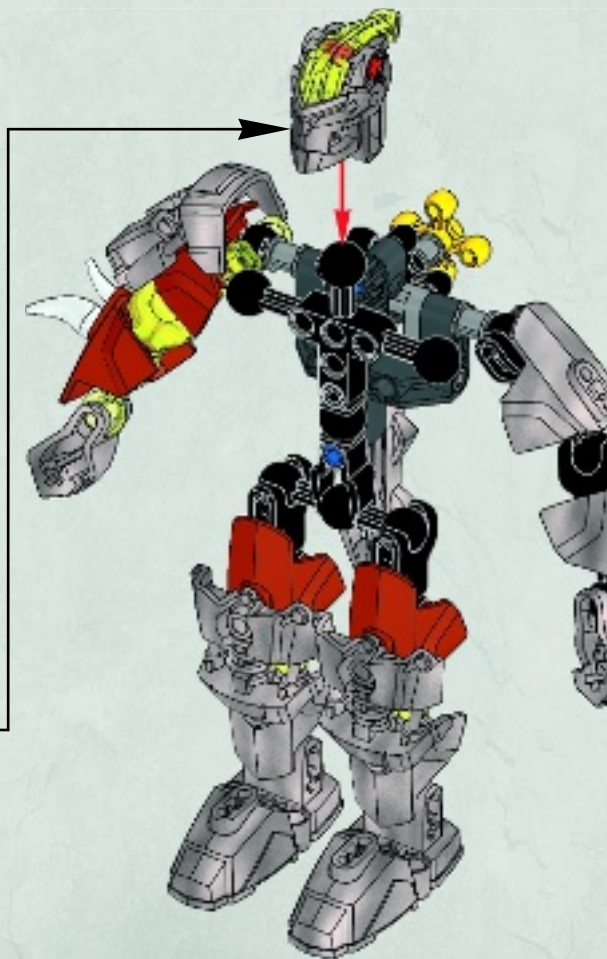

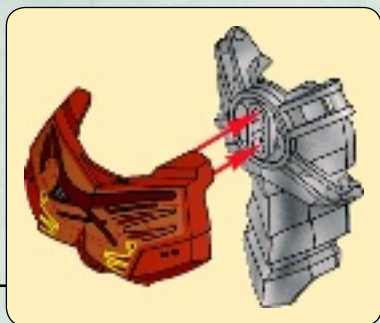
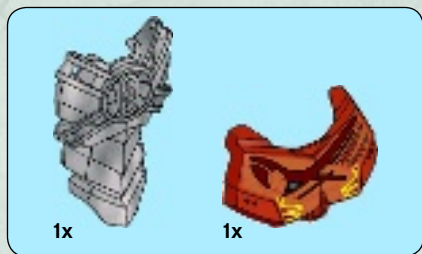

21

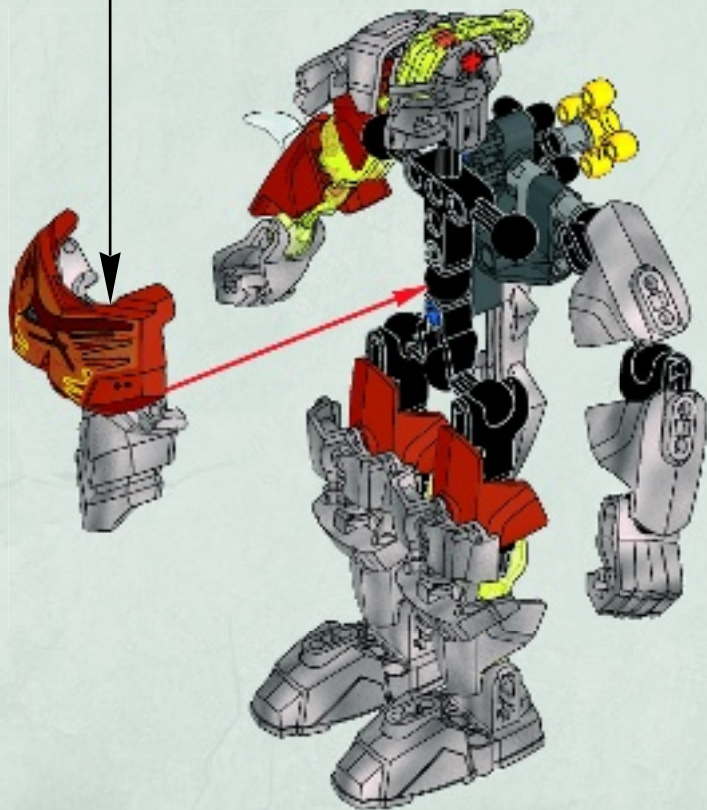



2x



2x



4x

22

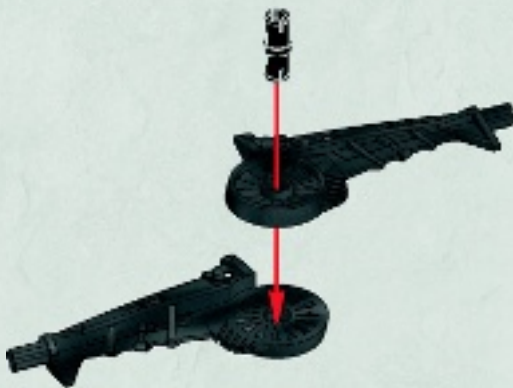

2x

23



24



2x

24



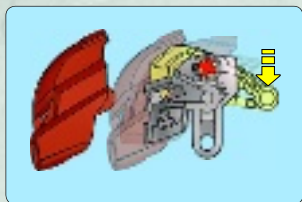

25

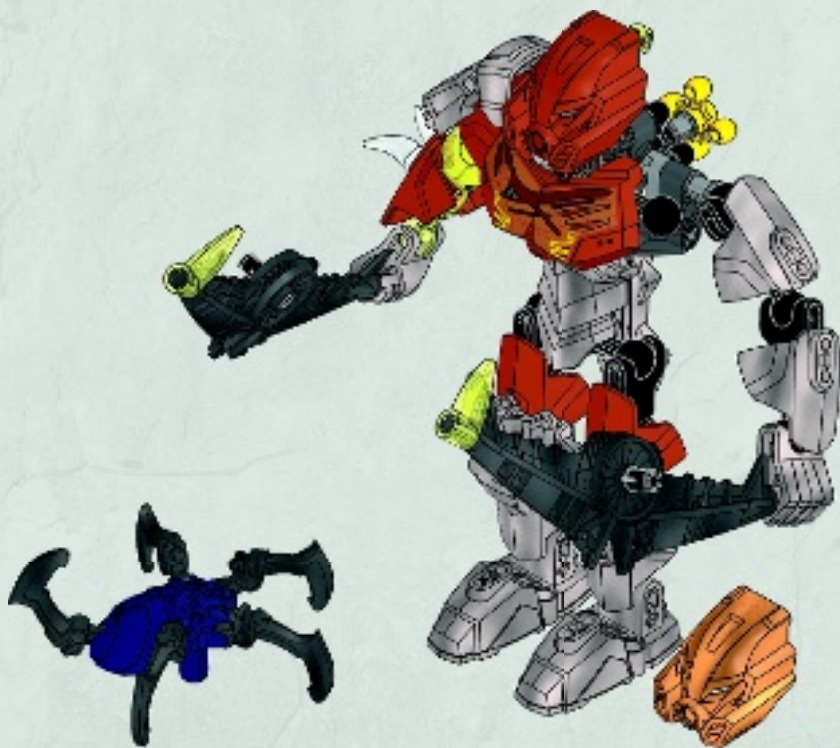



1

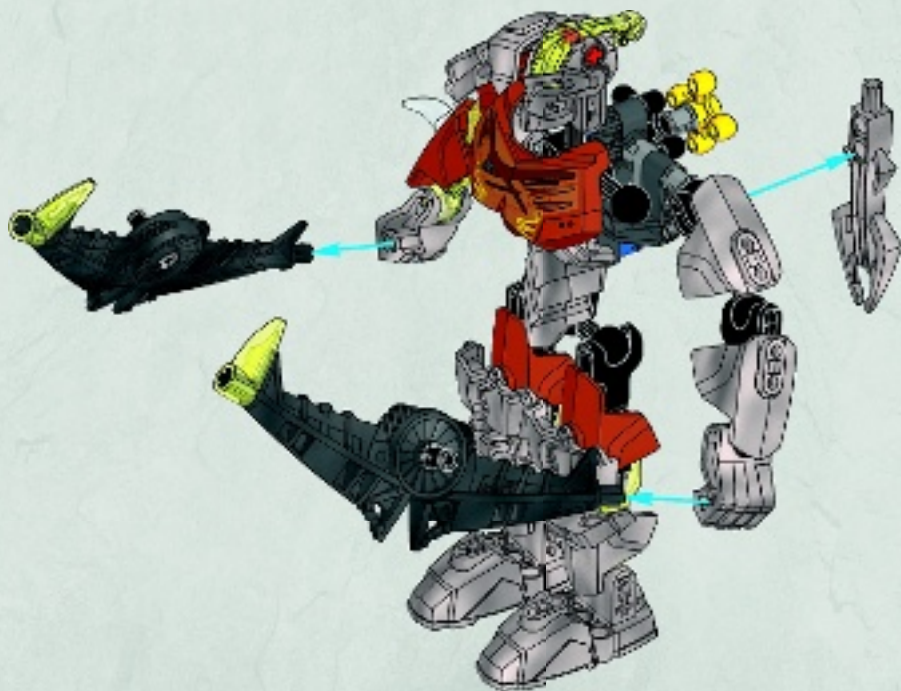

2



3

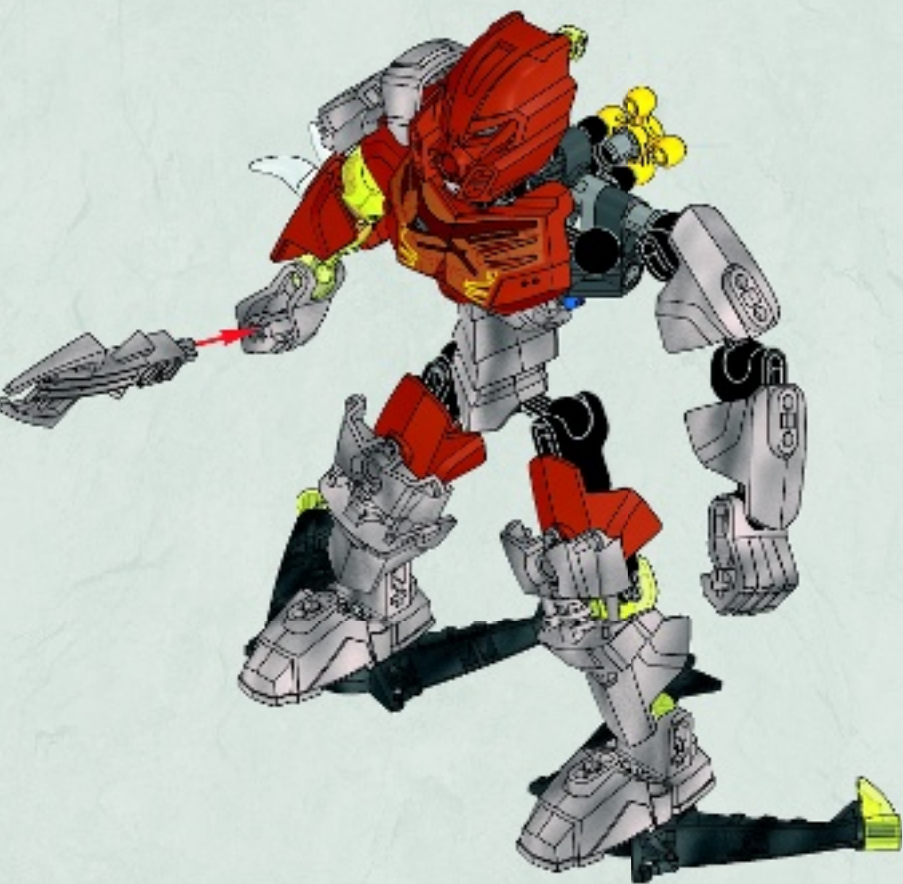

1x
4568387

1x
4566256

1x
4142865

1x
4206482

1x
4514553

1x
4203493

2x
4286267

2x
4593555

2x
4593562

1x
4589953

3x
4121715

2x
4248204

1x
6102761

4x
6108828

1x
6104414

1x
6102639

4x
6078388

2x
4163577

1x
6055631

1x
4563045

3x
4211622

1x
6102645

2x
6083620

2x
6012451

1x
6102762

1x
6102606

2x
4632585

2x
4619077

1x
6100089

4x
6100086

3x
6102789

1x
6016208

4x
6102797

1x
6106709

5x
6106738



Customer Service

Kundenservice

Service Consommateurs

Servicio Al Consumidor

LEGO.com/service or dial



00800 5346 5555 :

1-800-422-5346 :



70786



70788

70785



70787

70784

70789



70779



70785



LEGO.com/bionicle/bi

LEGO® BIONICLE®

Download App
Télécharger l'application
Descarga la App

Available on the
 App Store

GET IT ON
 Google play

Apple, the Apple logo, iPad, iPhone and iPod touch are trademarks of Apple Inc., registered in the U.S. and other countries. App Store is a service mark of Apple Inc.

Apple, le logo Apple, iPad, iPhone et iPod touch sont des marques de commerce d'Apple Inc., déposées aux États-Unis et dans d'autres pays. App Store est une marque de service d'Apple Inc.

Apple, el logotipo de Apple, iPad, iPhone e iPod touch son marcas comerciales de Apple Inc. registradas en EE. UU. y otros países. App Store es una marca de servicio de Apple Inc.

Google Play is a trademark of Google Inc. Google Play est une marque de commerce de Google Inc. Google Play es una marca comercial de Google Inc.

LEGO.com/bionicle

Power up

Plus de puissance

Máximo poder

