

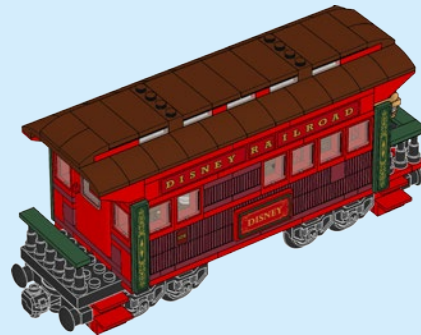

Disney

71044

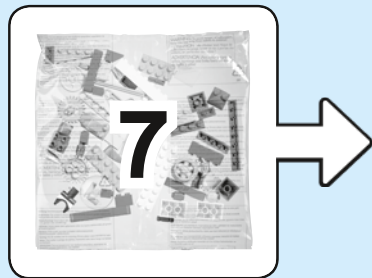

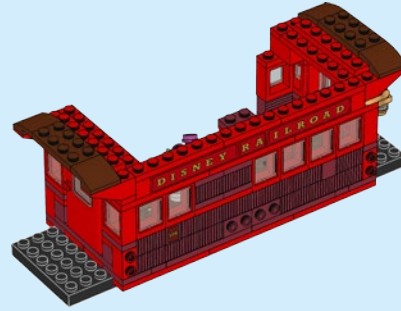
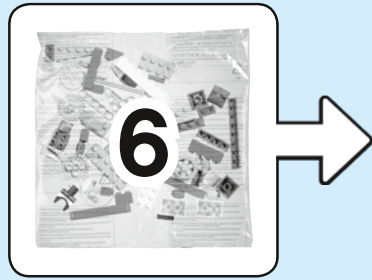

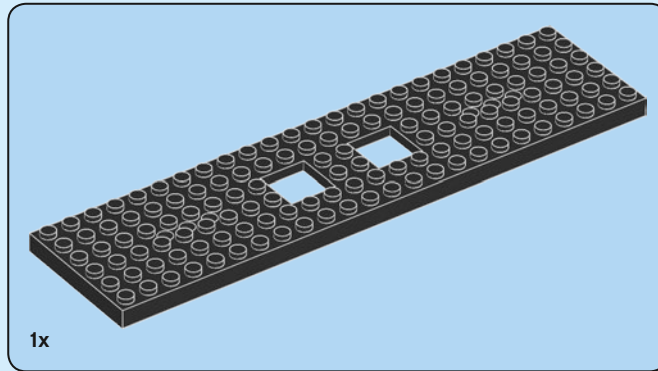
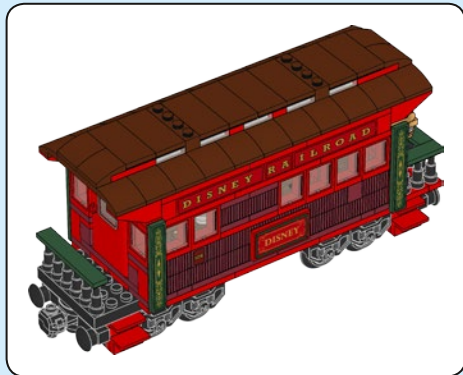
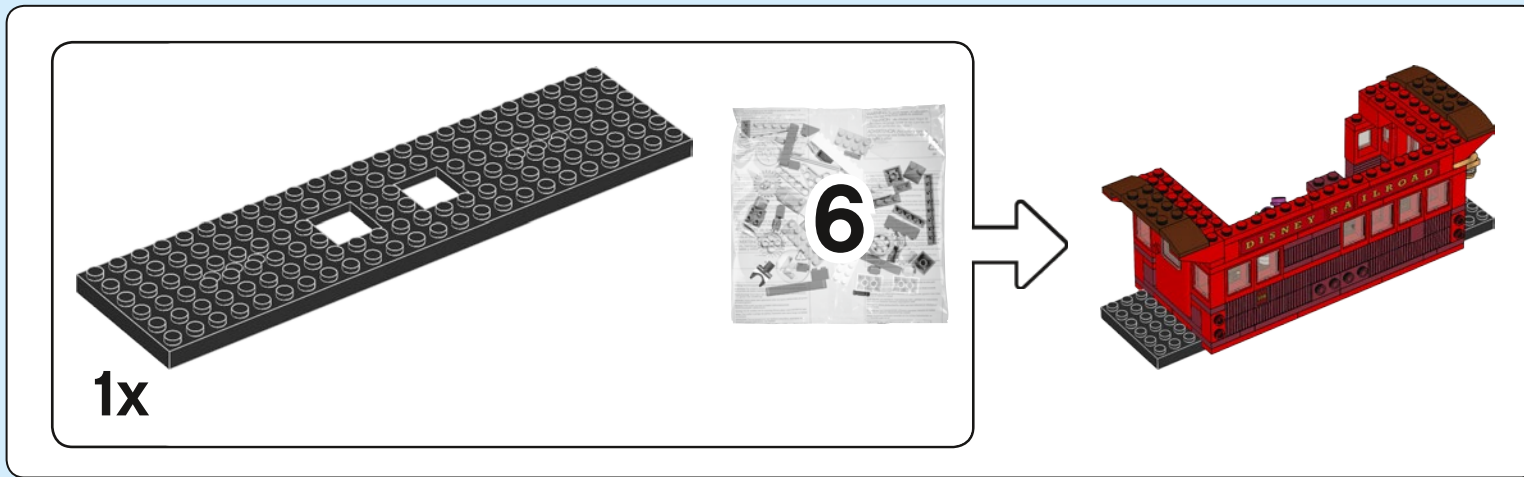

1

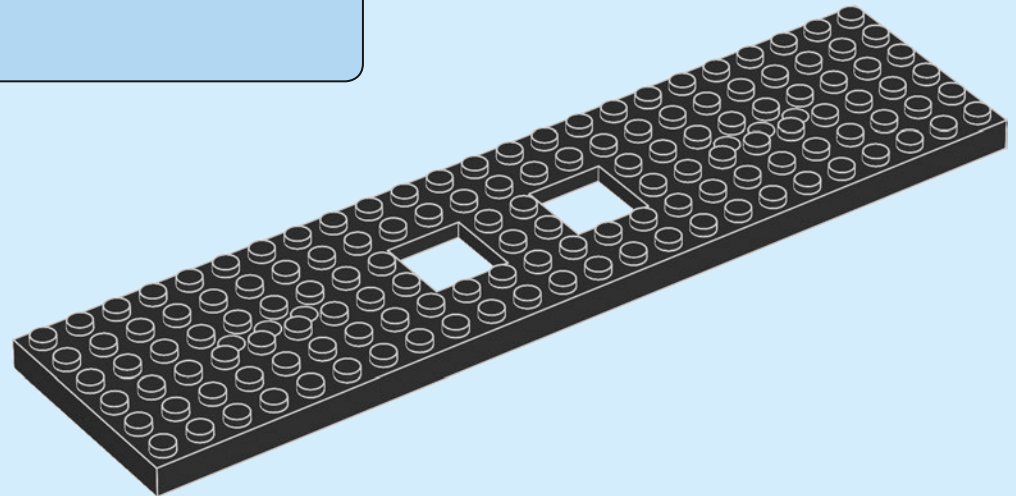

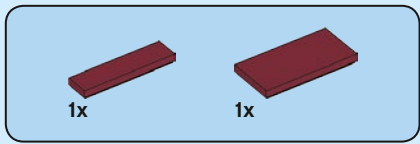

2

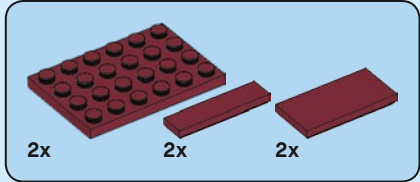
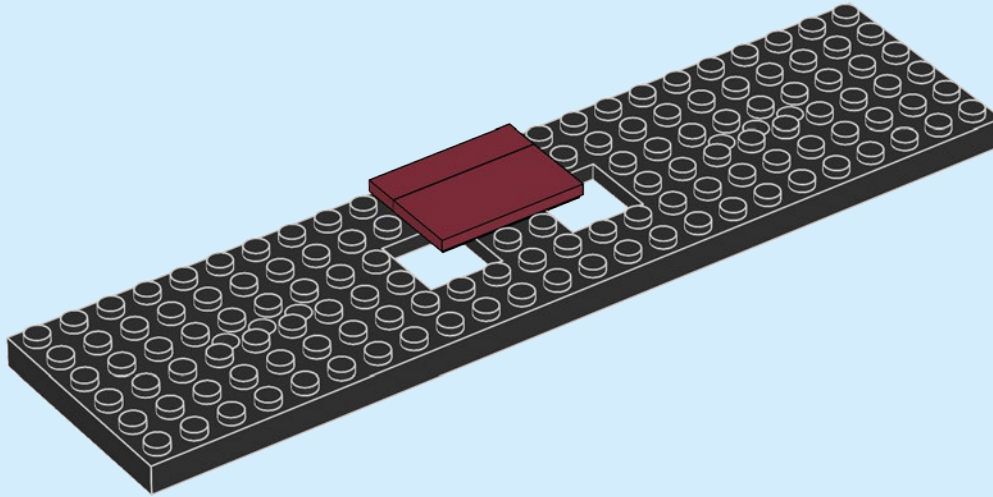

3

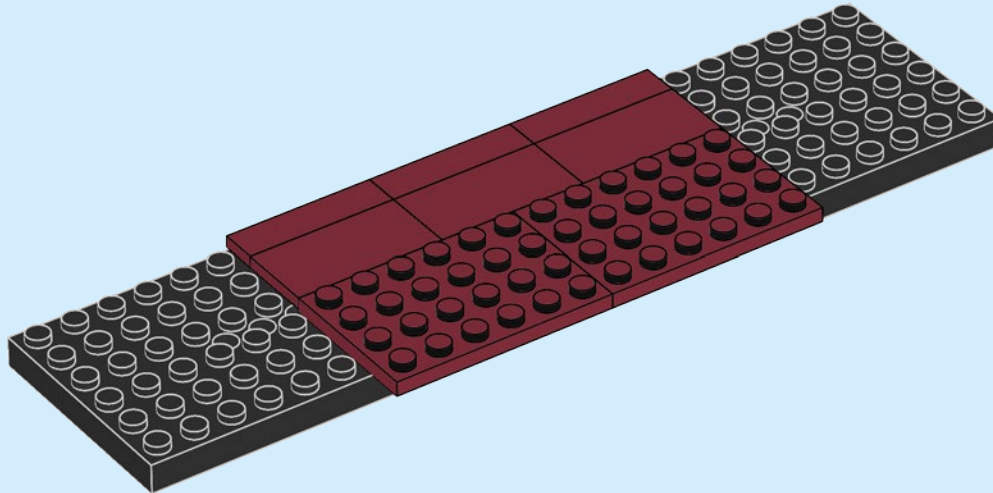

4

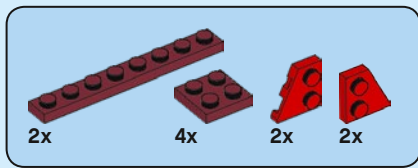

4

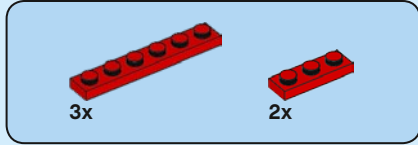
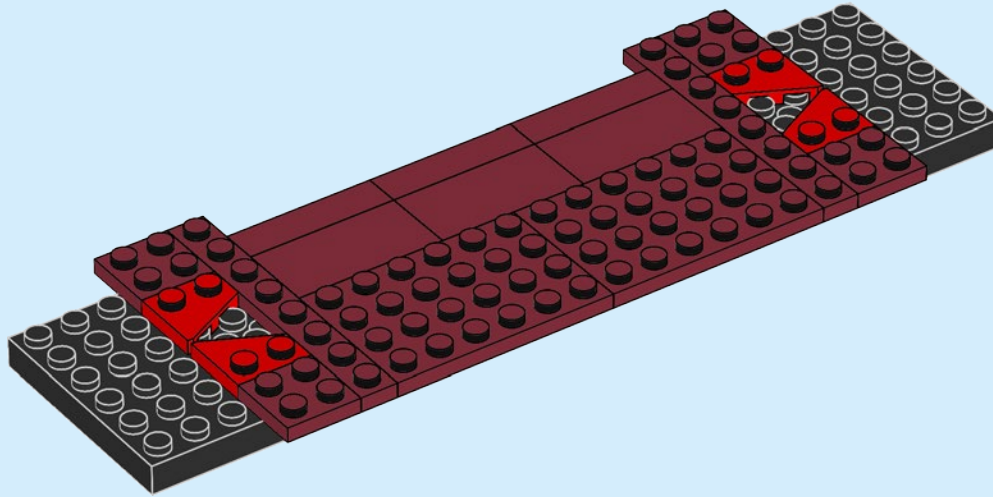

5

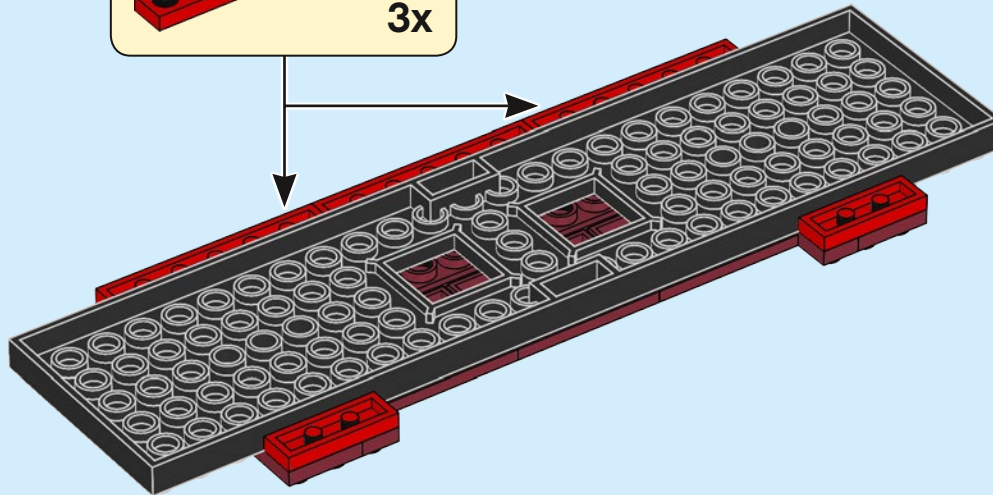
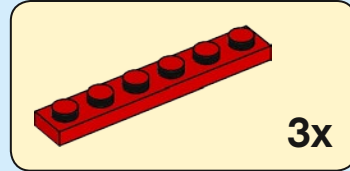

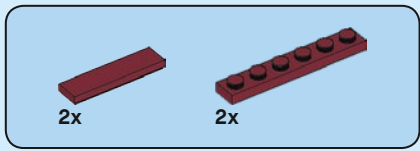

6

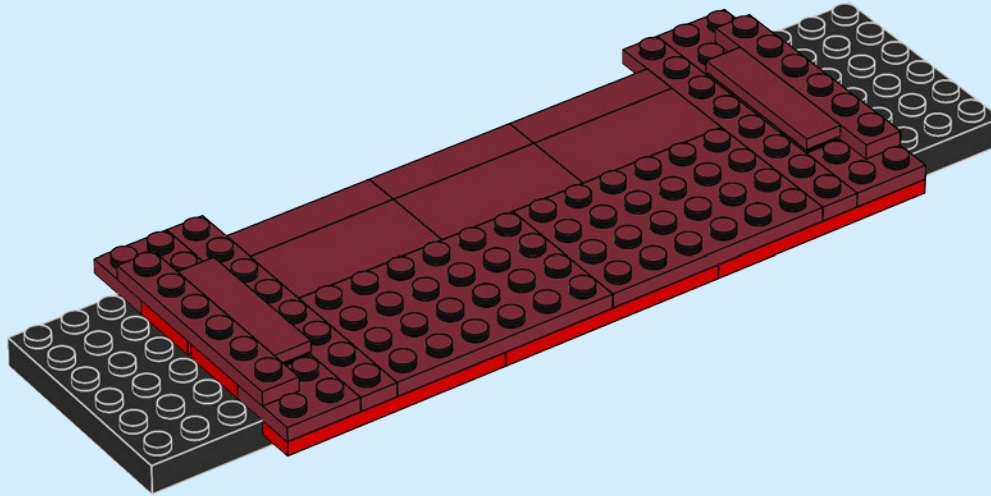

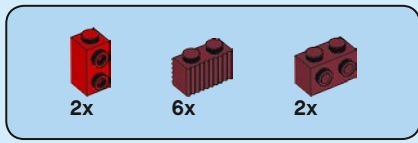

7

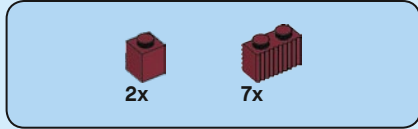
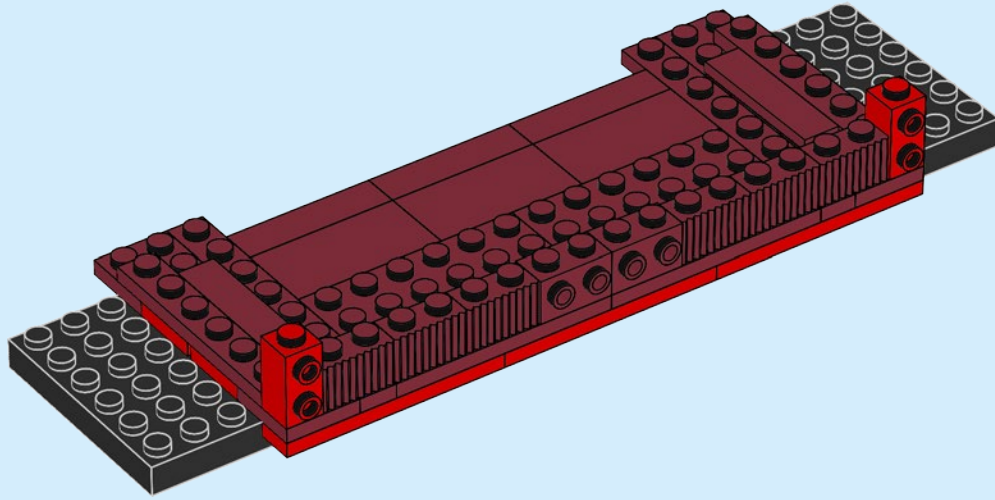

8

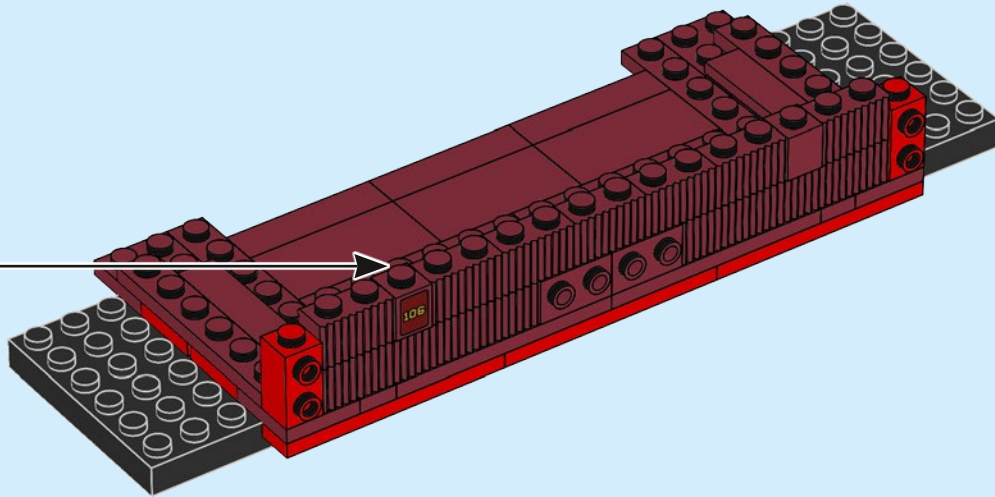



1x

9



1x



2x

10

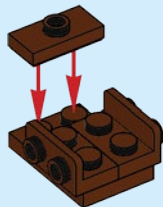

1x



1x

11



1x



2x

12

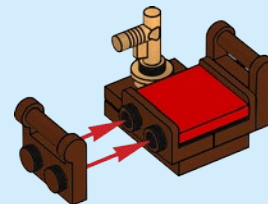



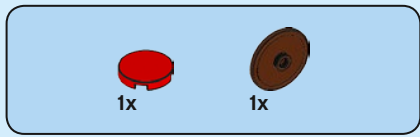

13

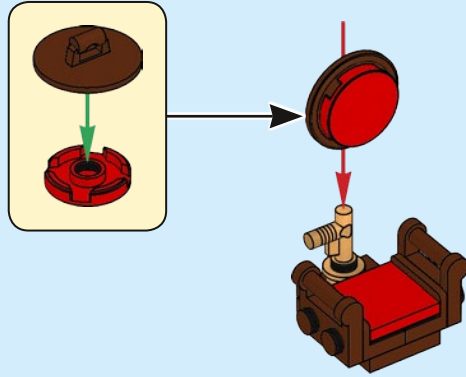

14

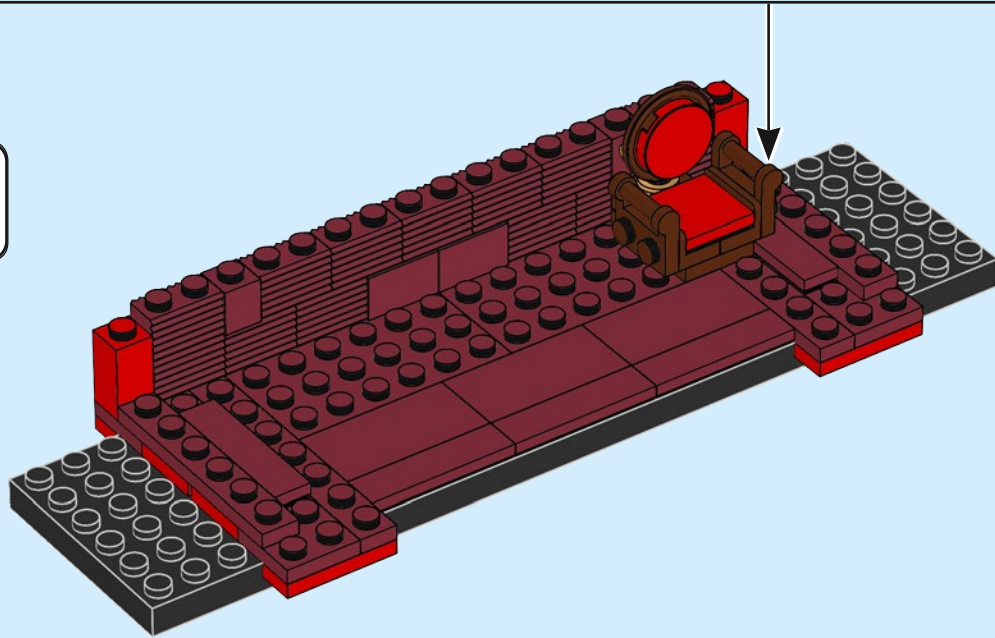

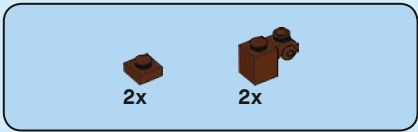

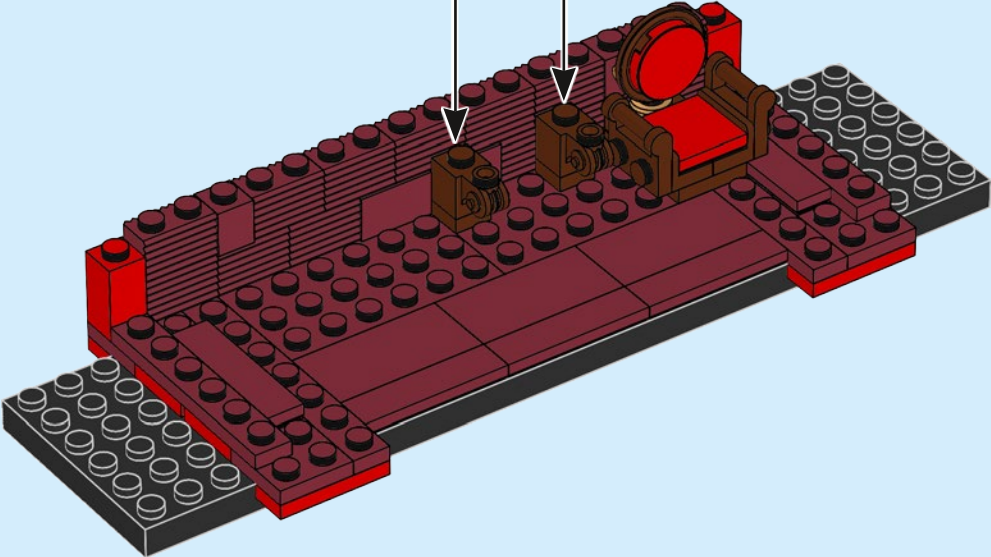
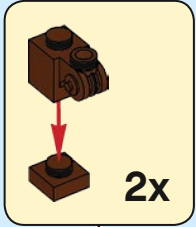

15

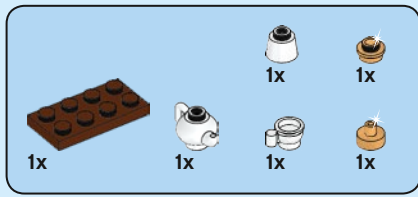



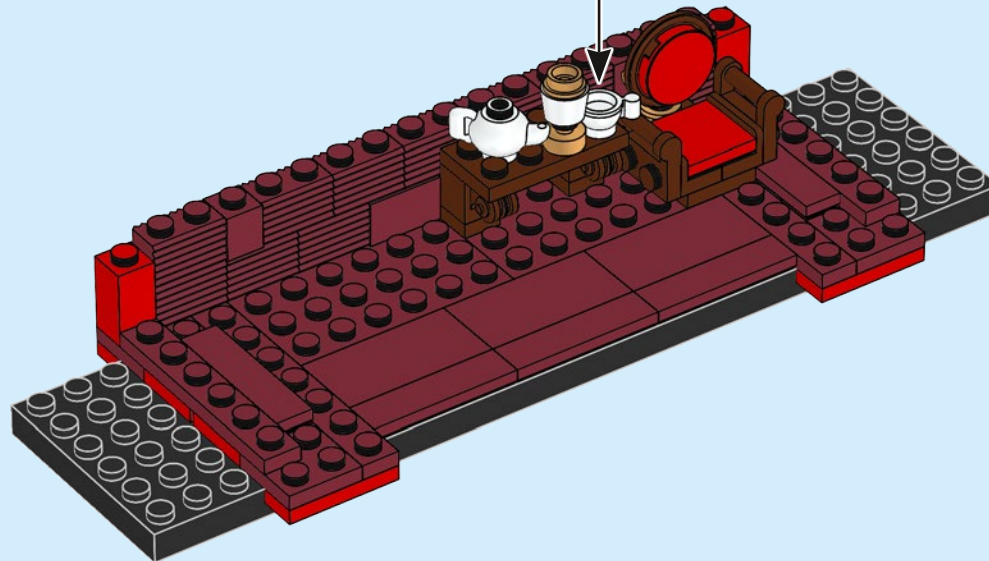
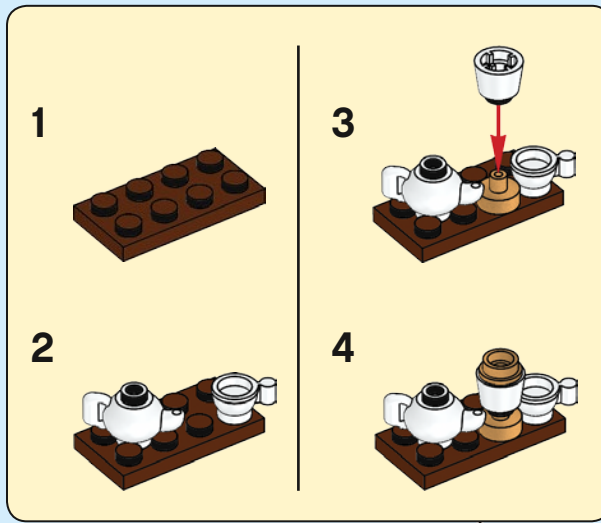

16



3x  1x 

17

1  2 

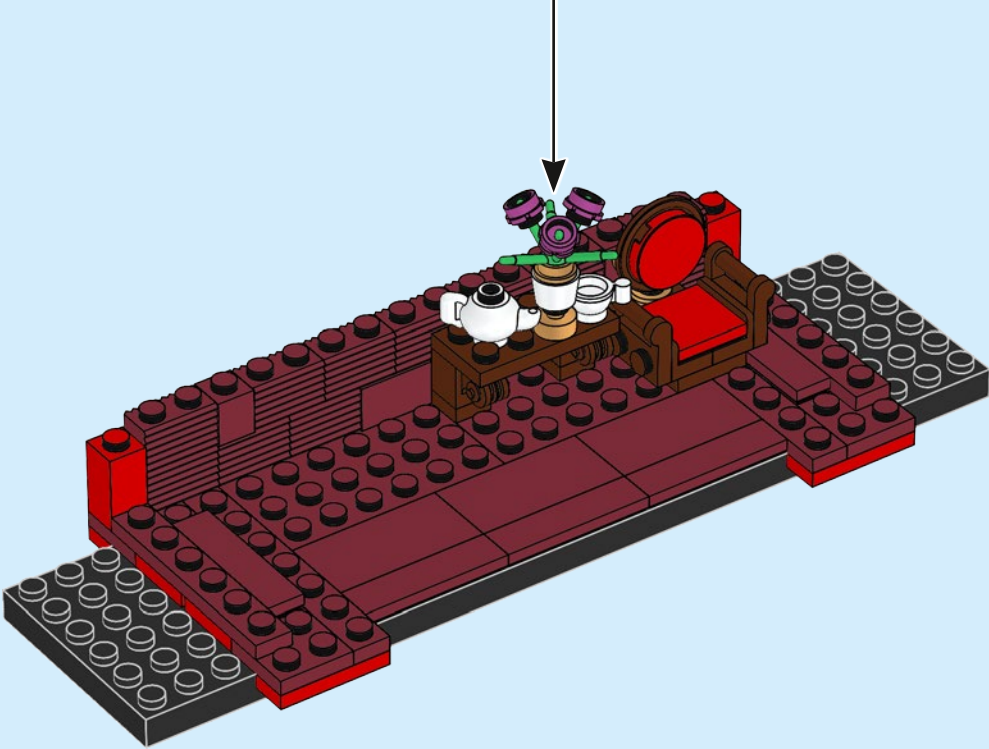

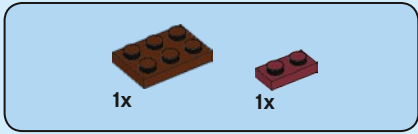

18

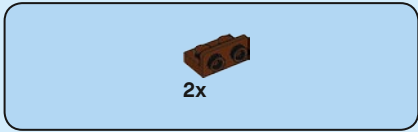
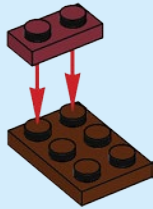

19

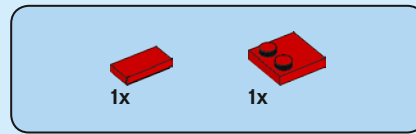
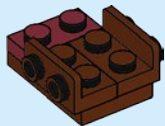

20

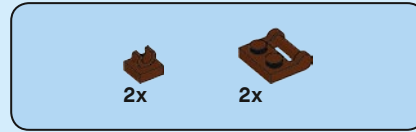
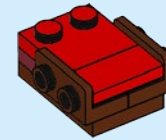

21

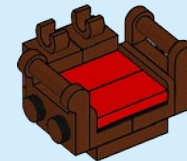

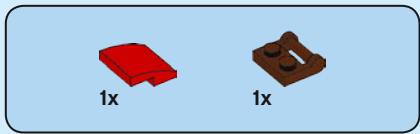

22

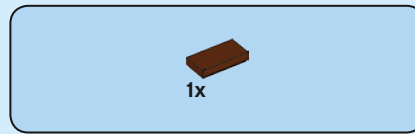
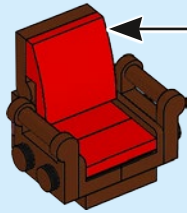
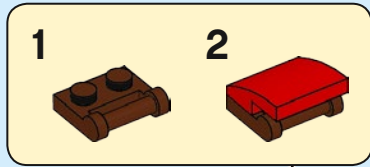

23

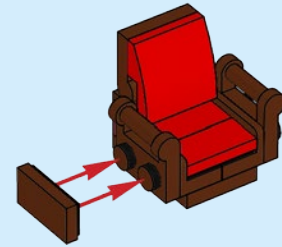

24

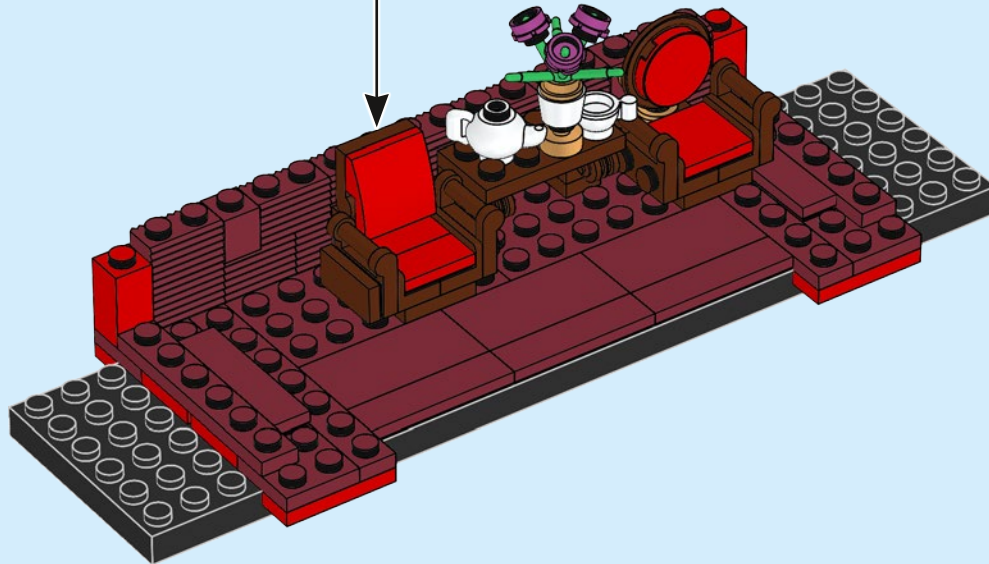

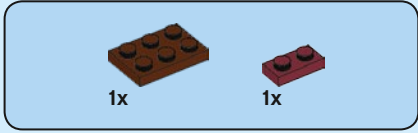

25

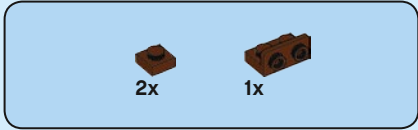
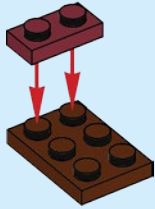

26

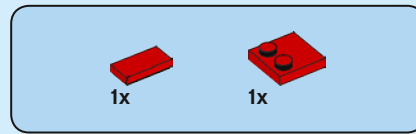

27

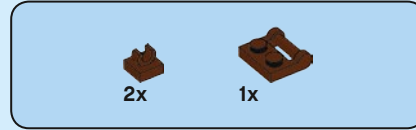
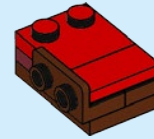

28

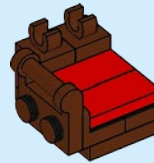

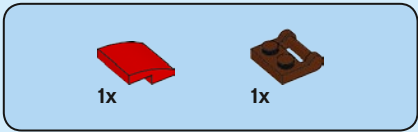

29

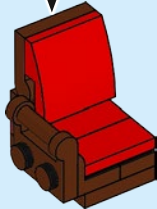
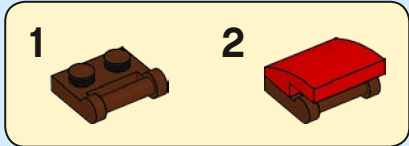

30

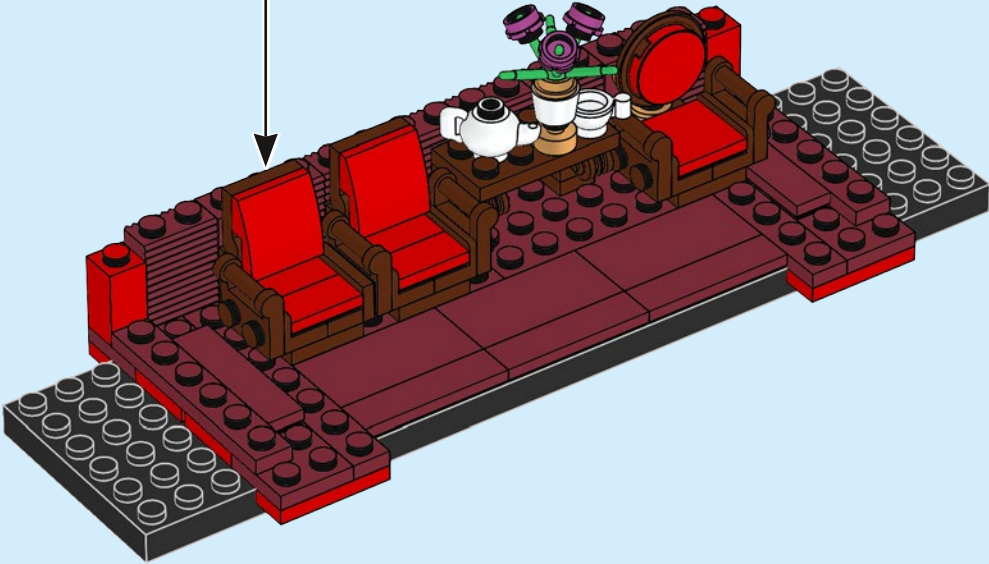



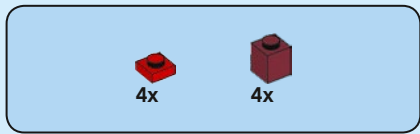

31

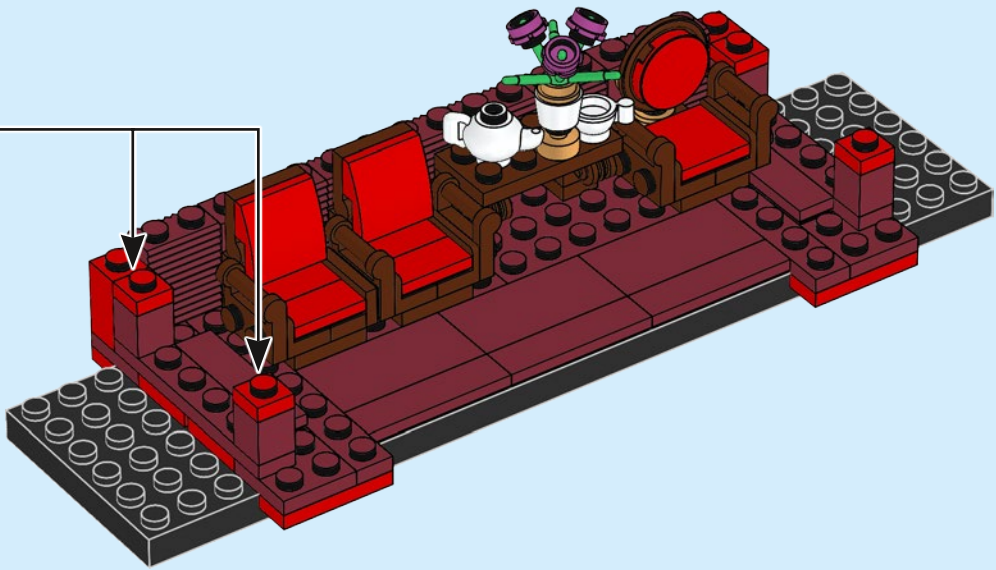
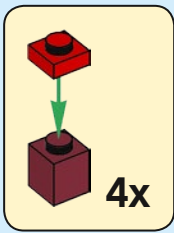

32

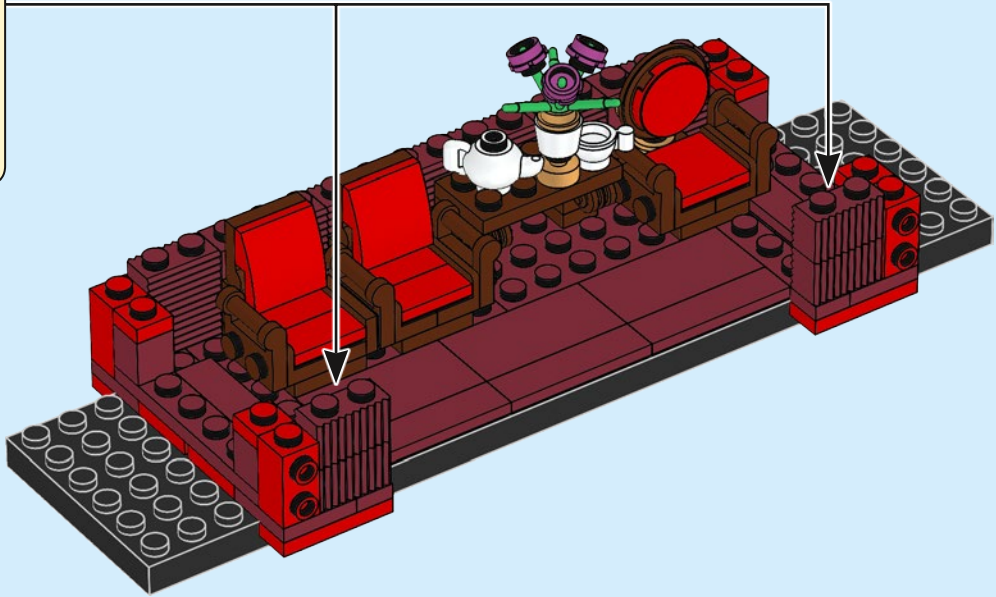
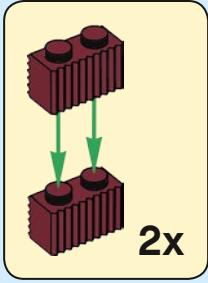

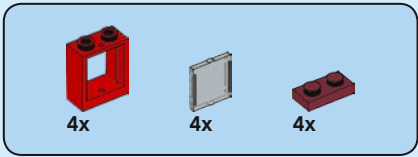

33

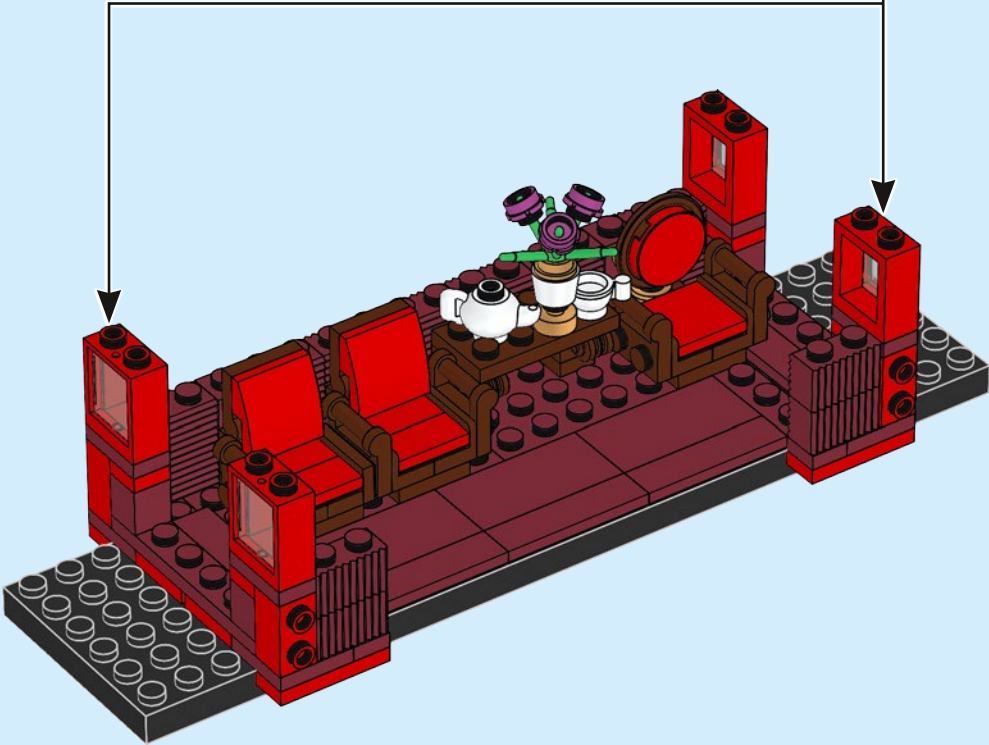
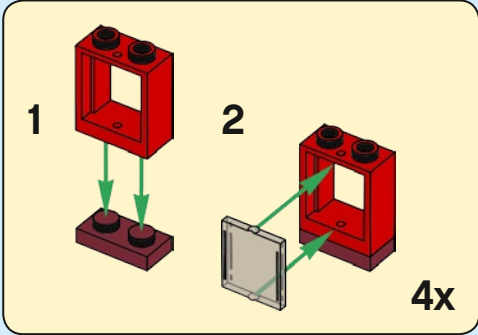

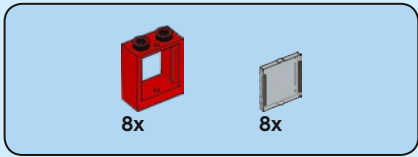

34

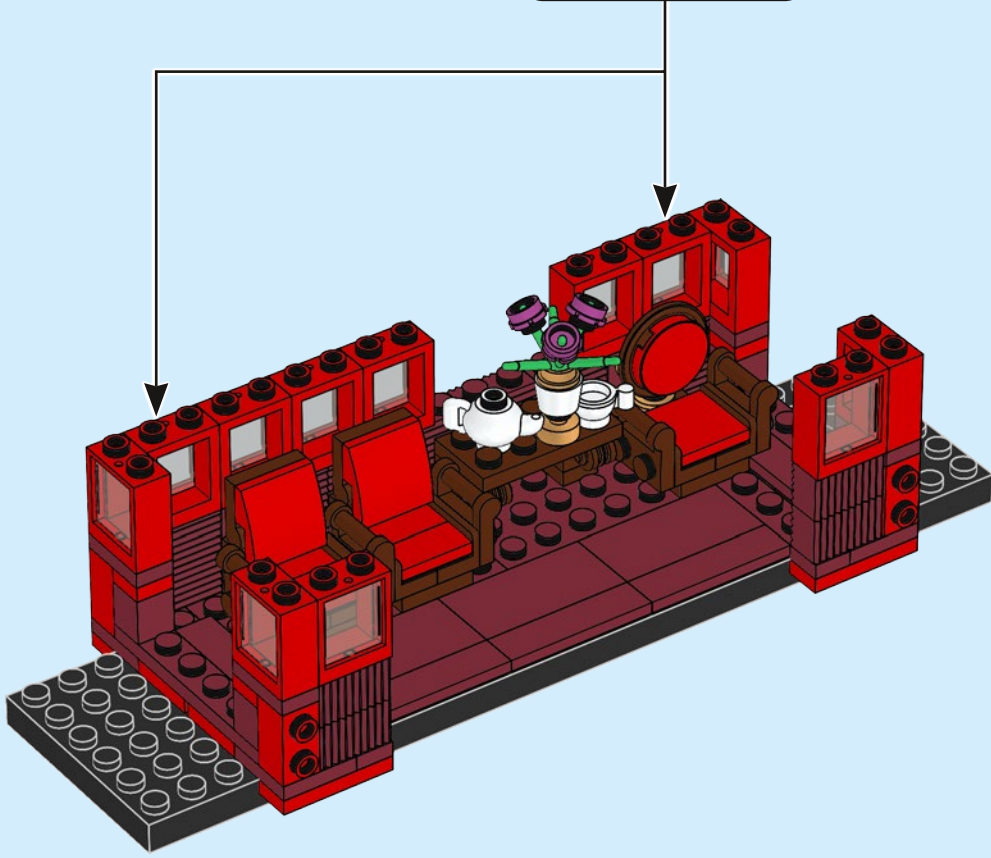
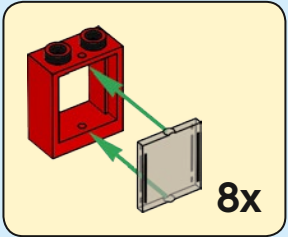

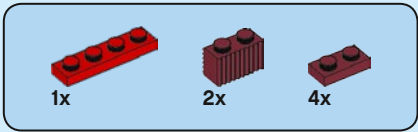

# 35

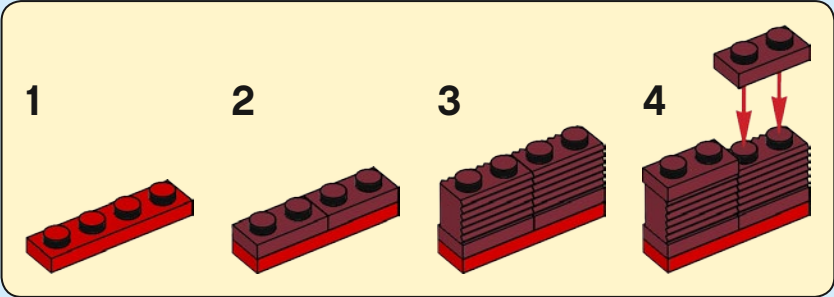

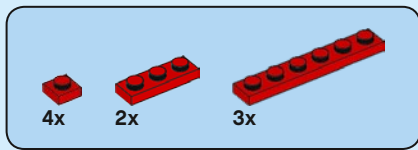

36

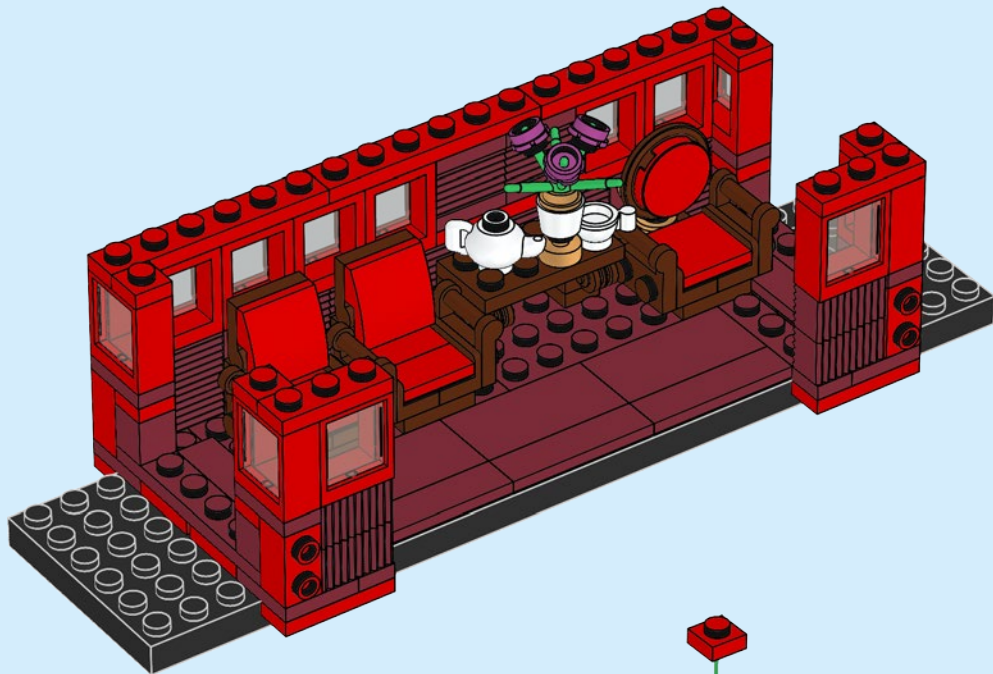

37



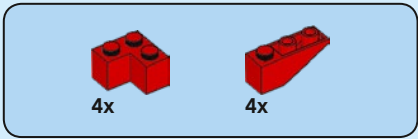

# 38

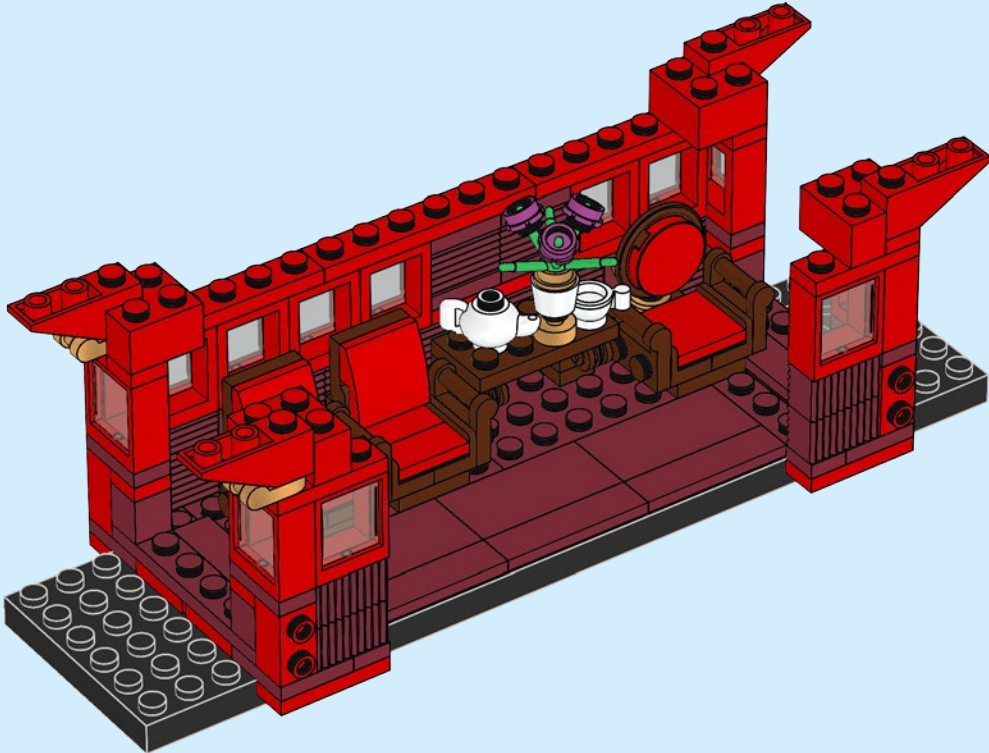

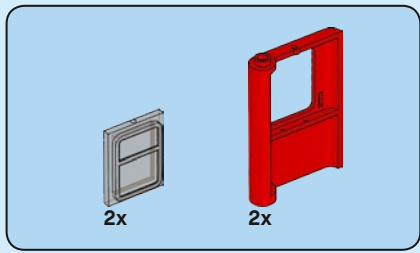

39

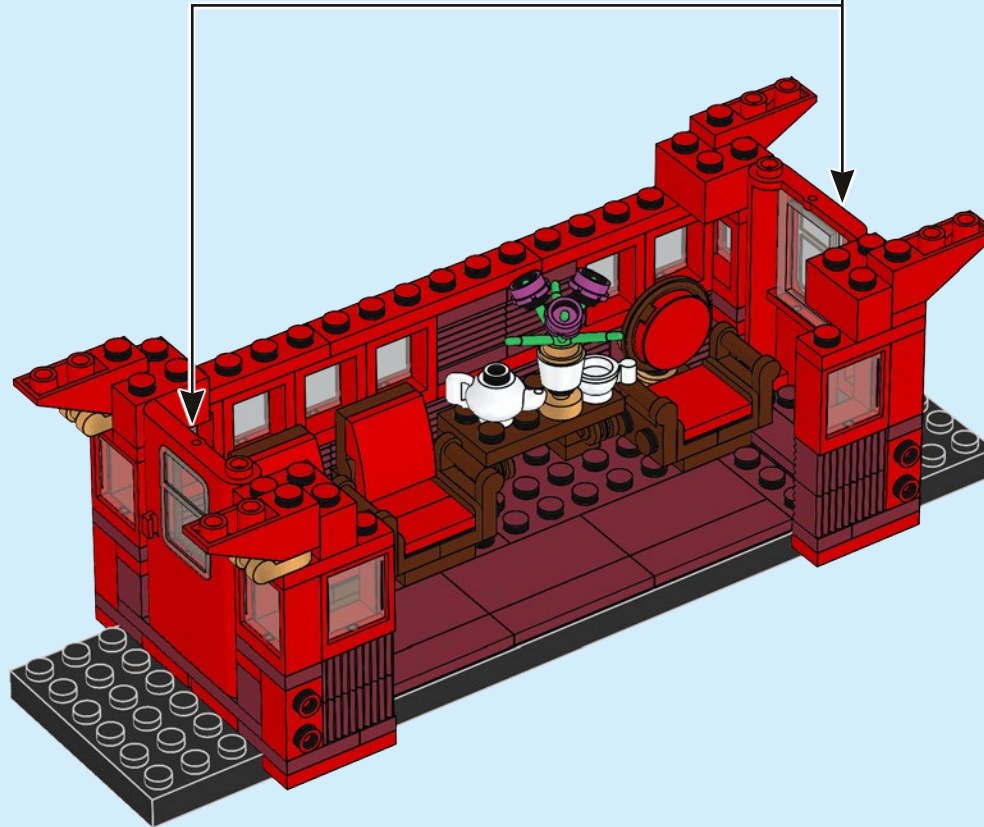
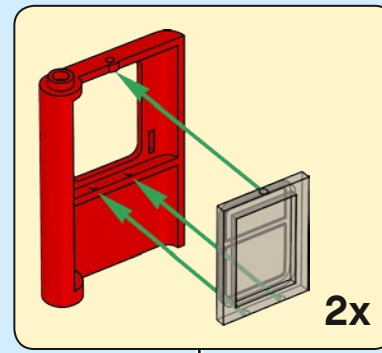

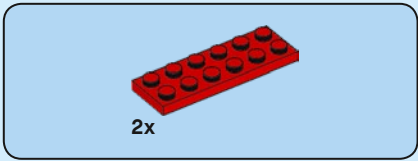

40

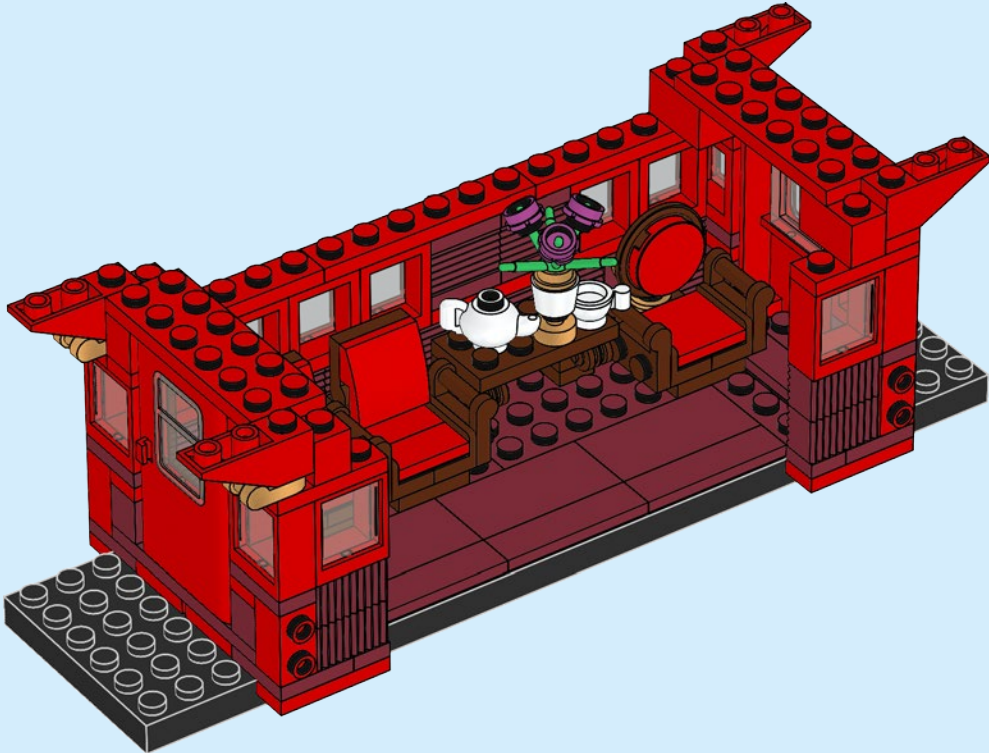



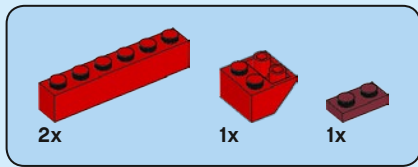

41

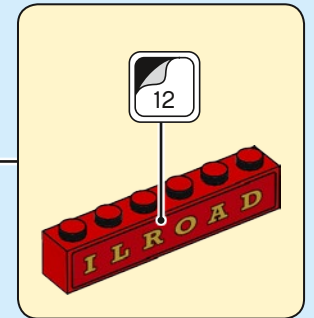
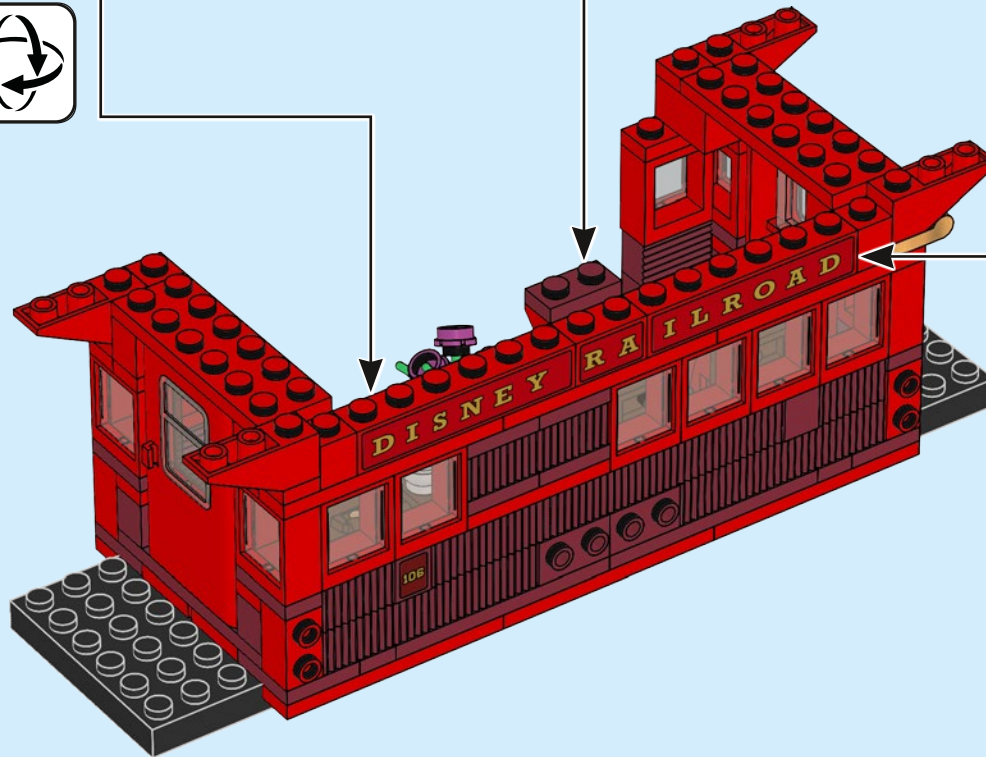
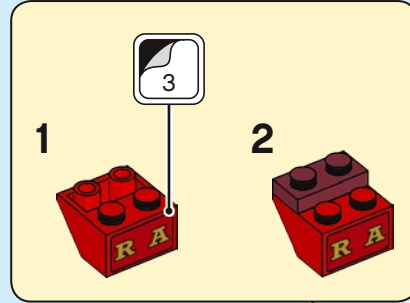
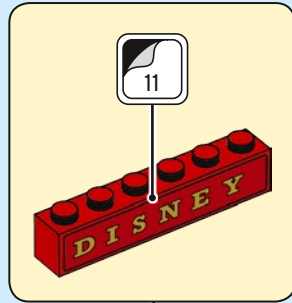

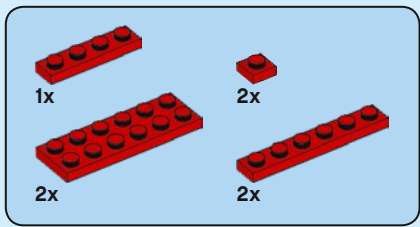

42

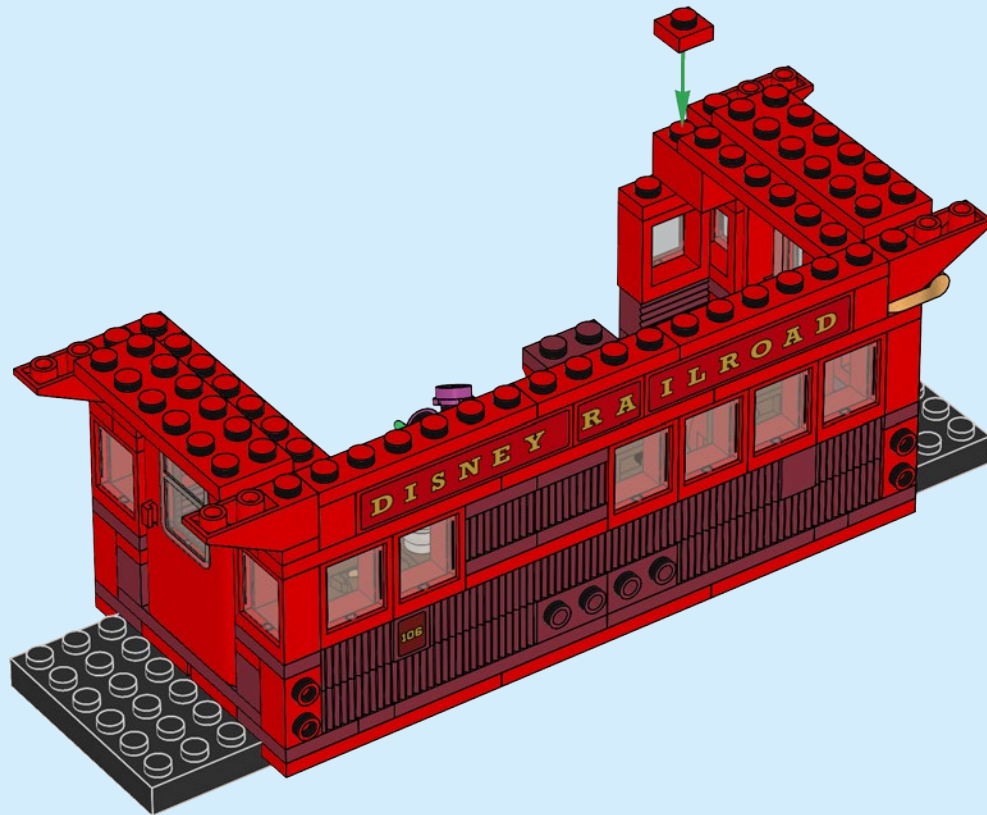

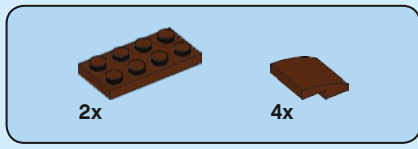

43

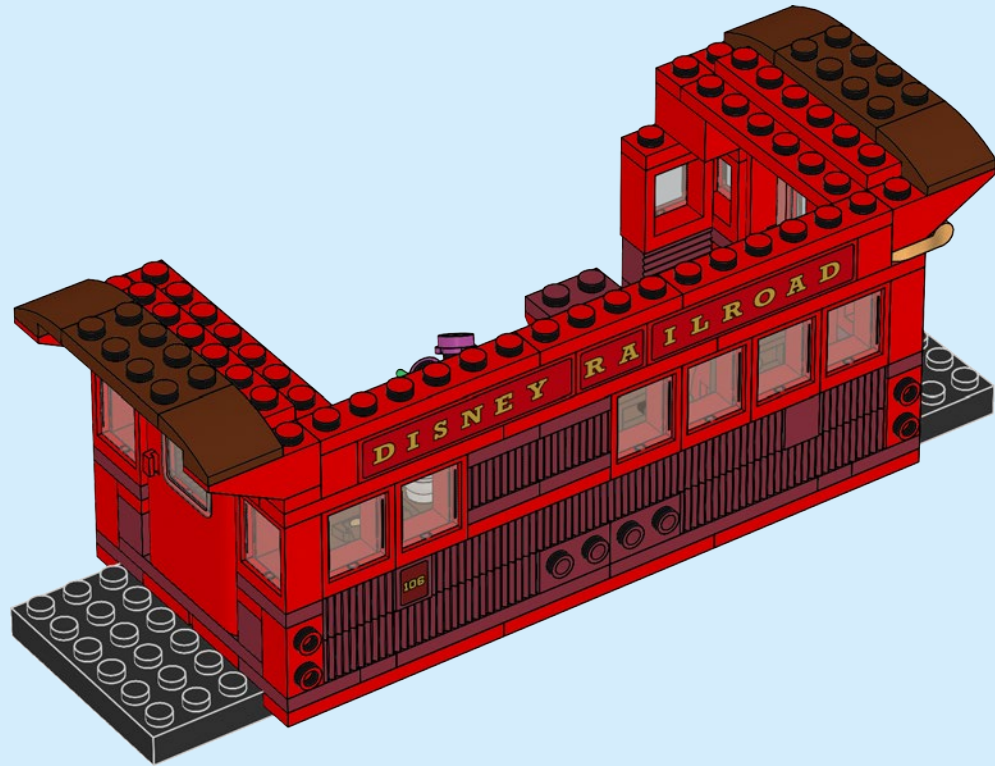



2x



2x



2x

# 44



1



2



2x

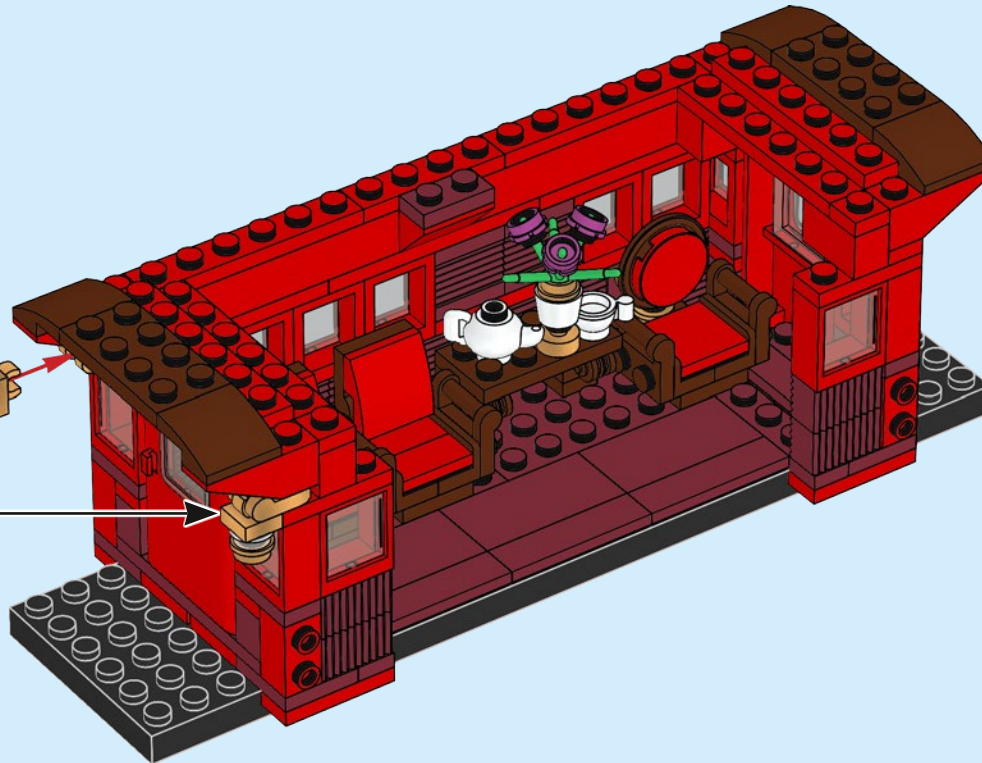

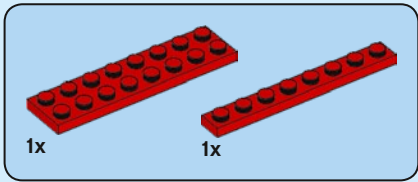
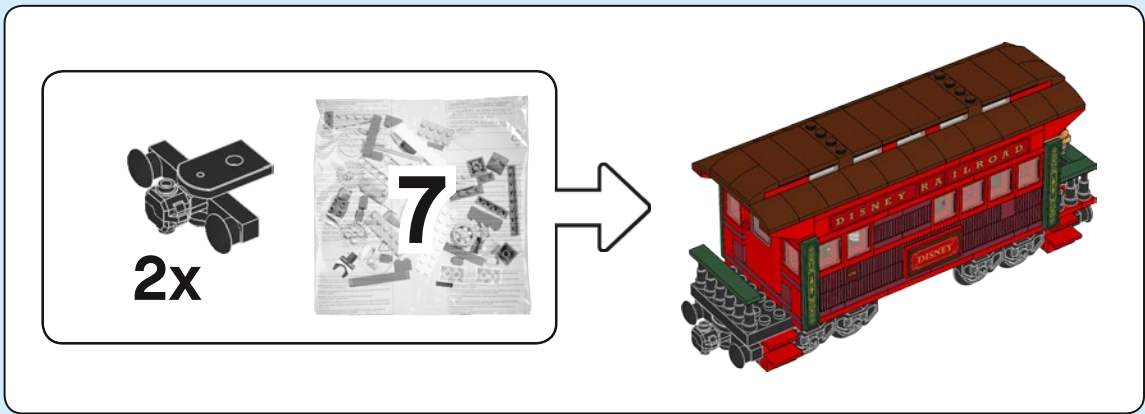

45

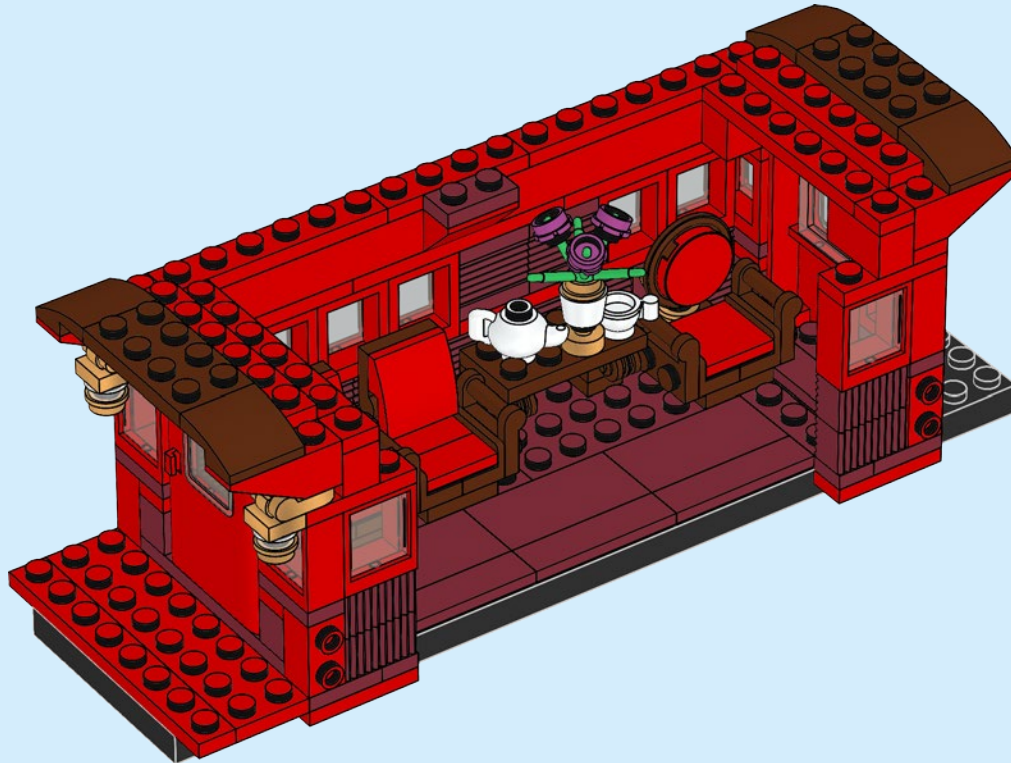

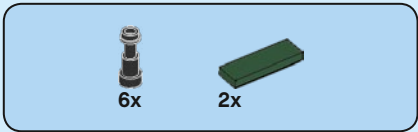

# 46

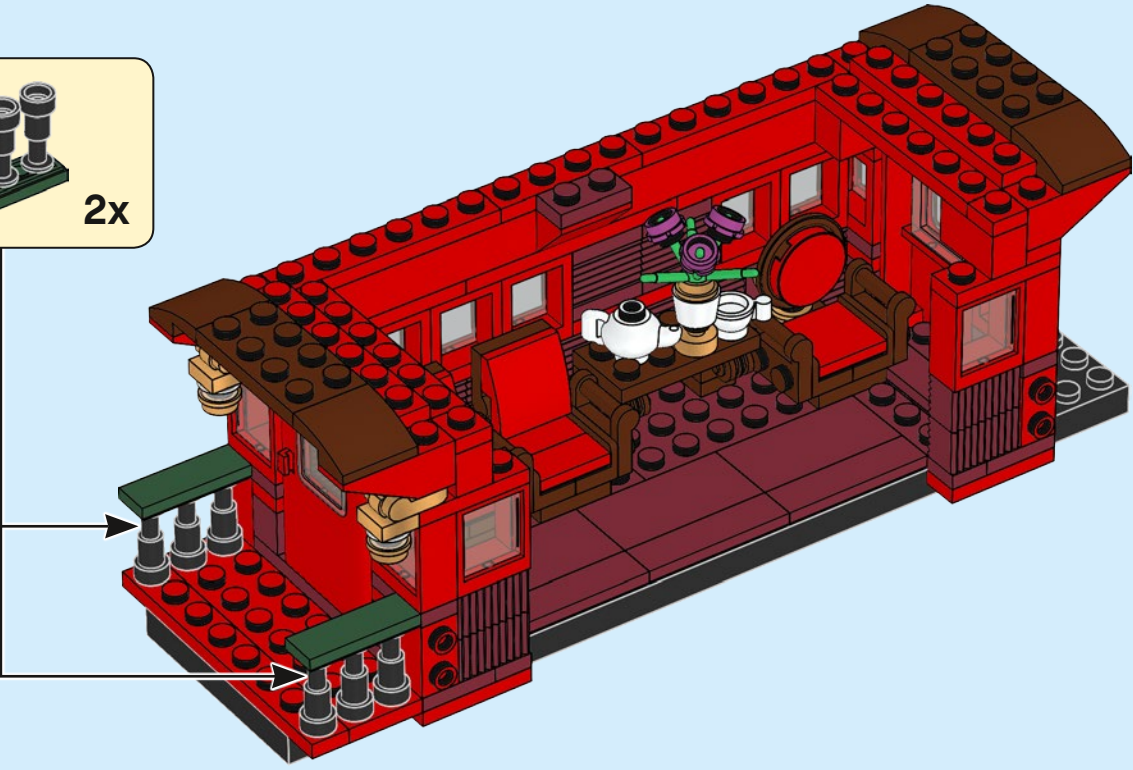
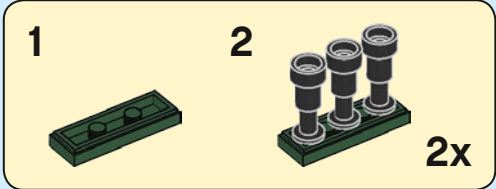

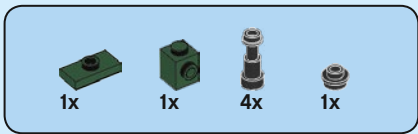

47

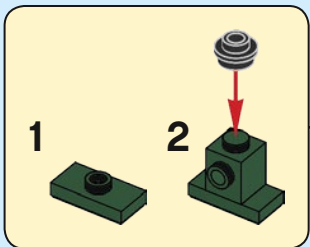
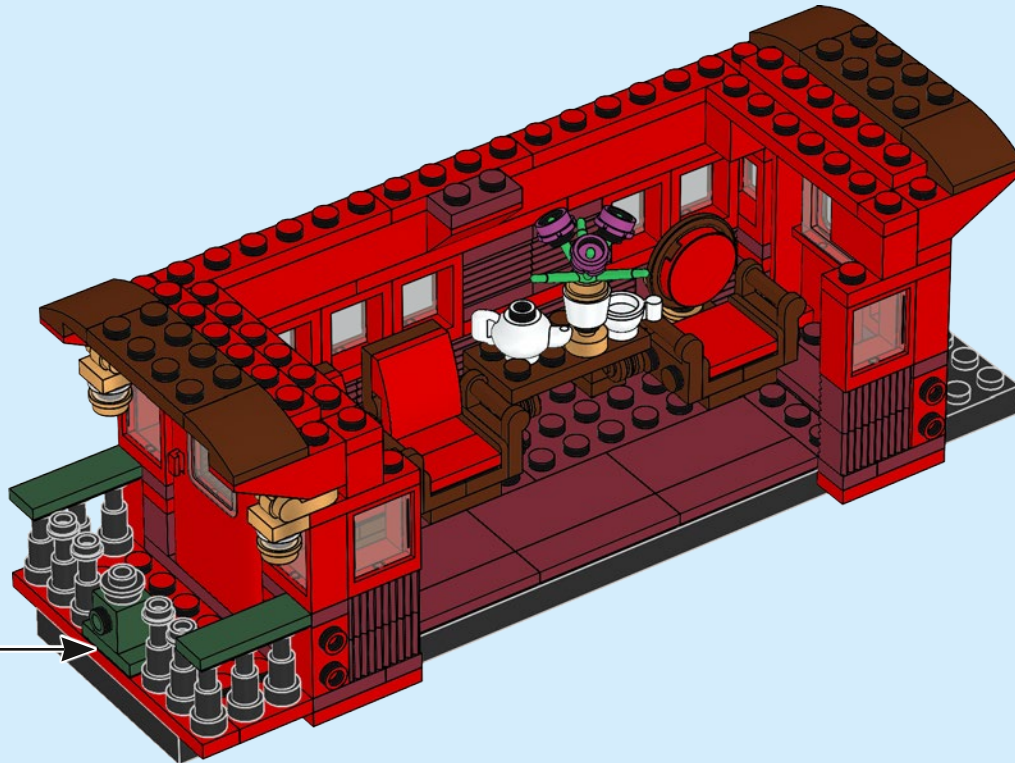

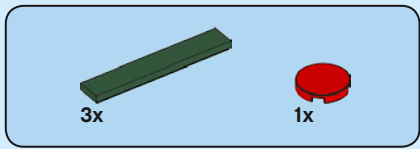

48

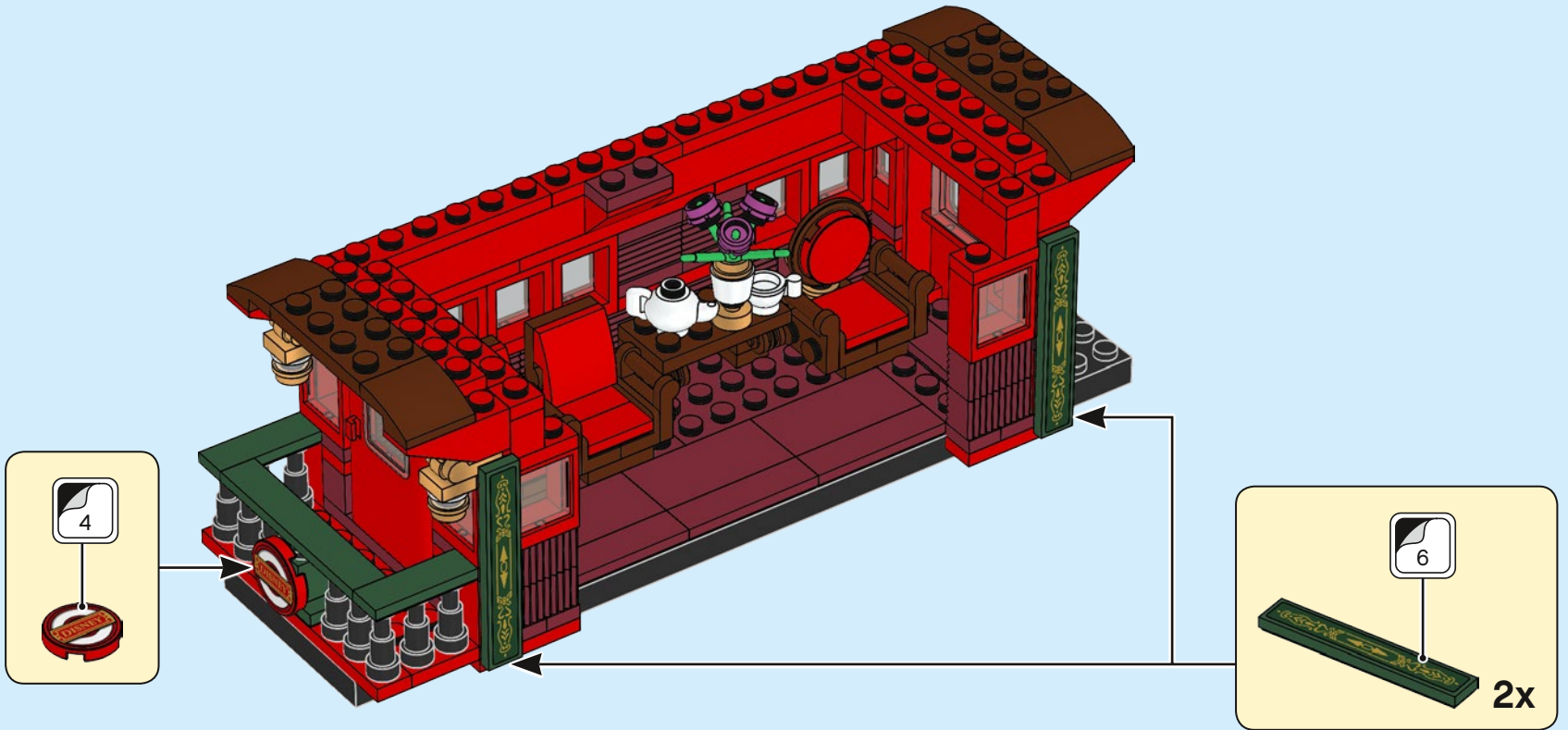



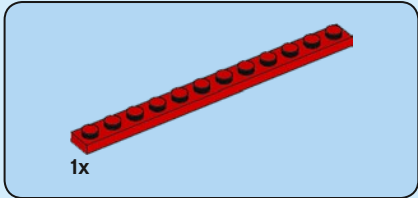

49

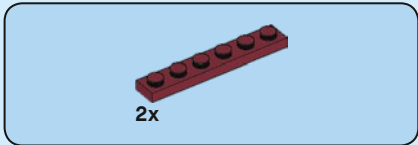
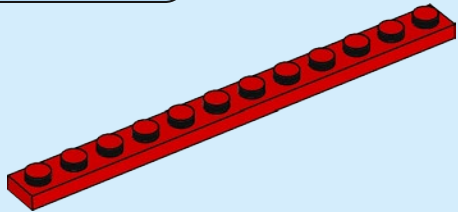

50

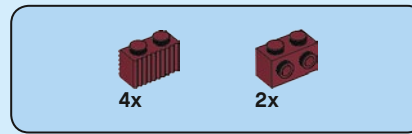
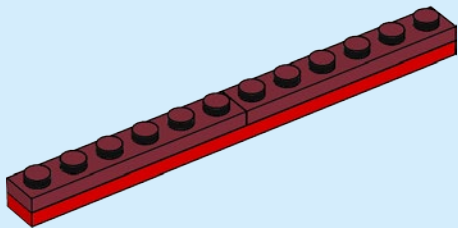

51

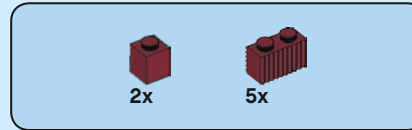
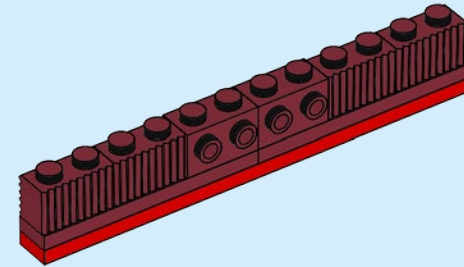

52

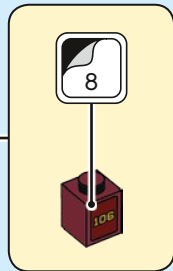
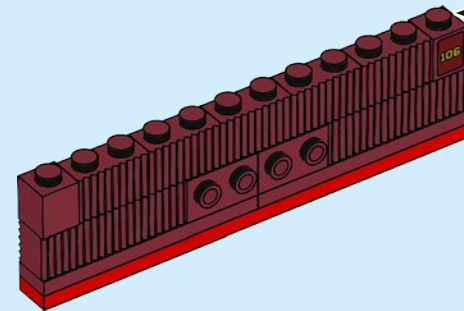

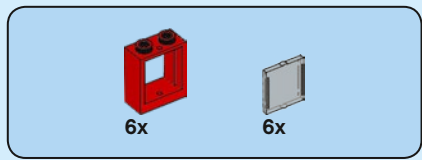

53

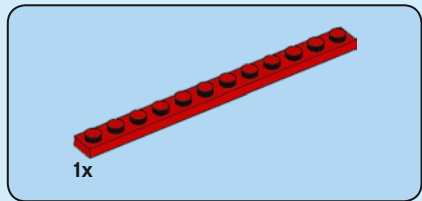
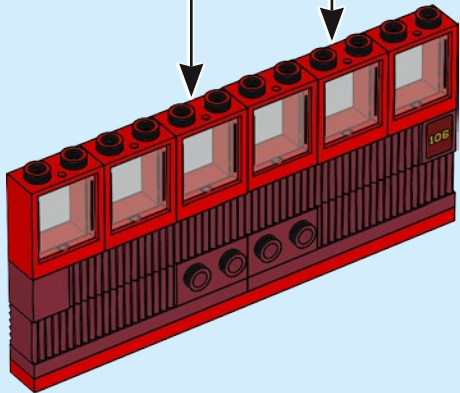
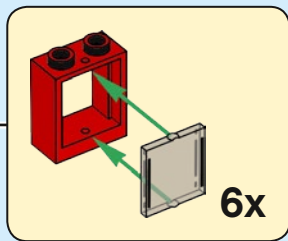

54

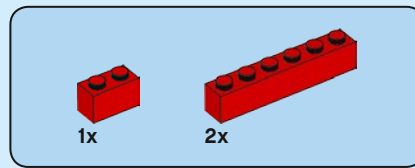
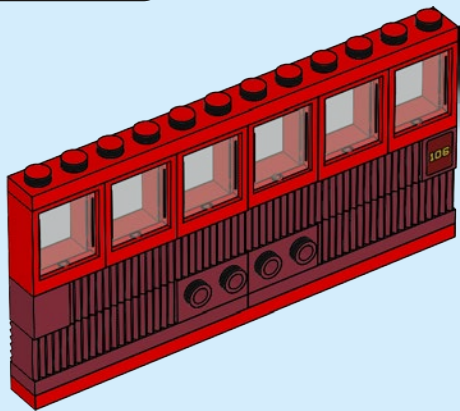

55

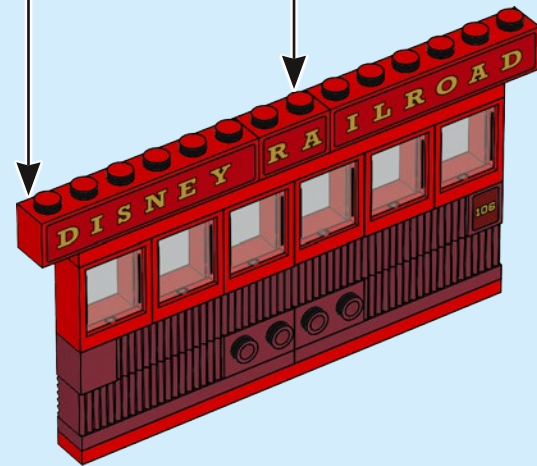
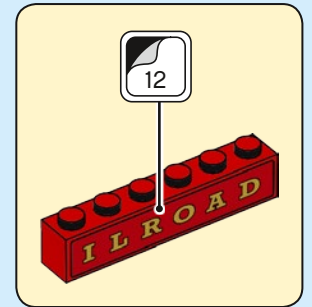
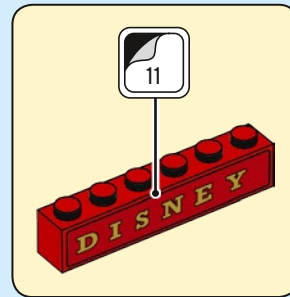

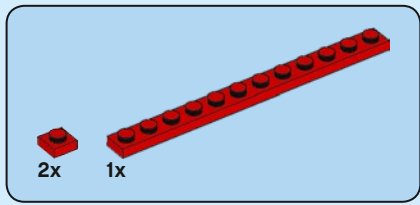

56

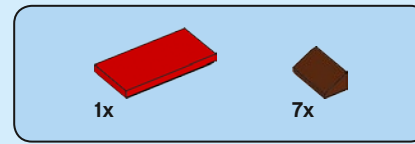
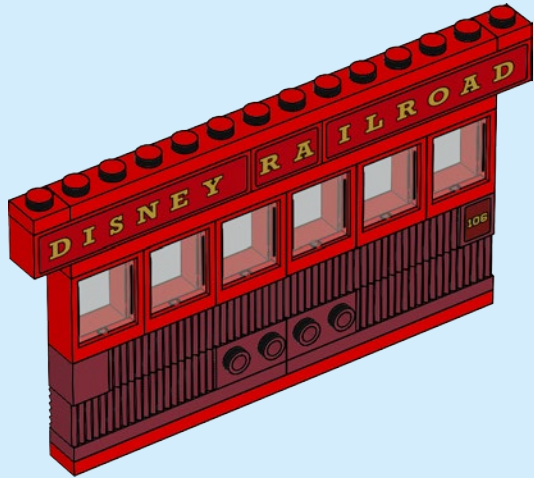

57

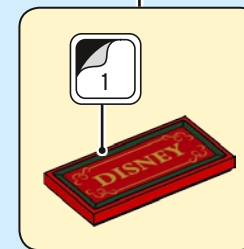
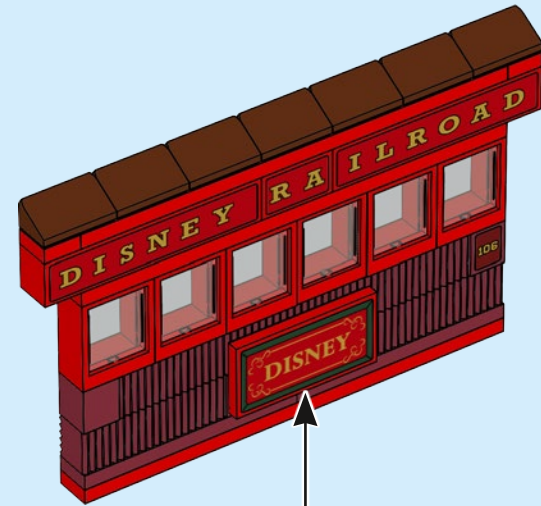

58

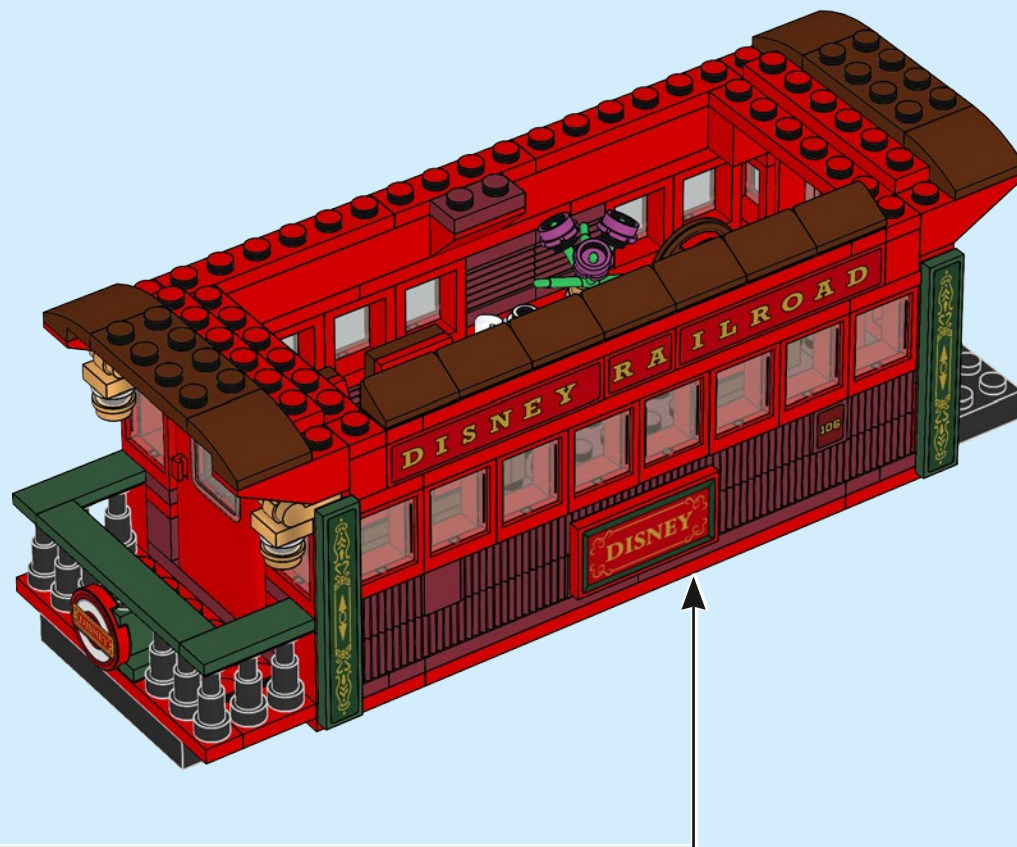

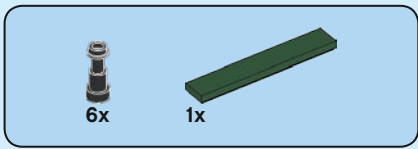

59

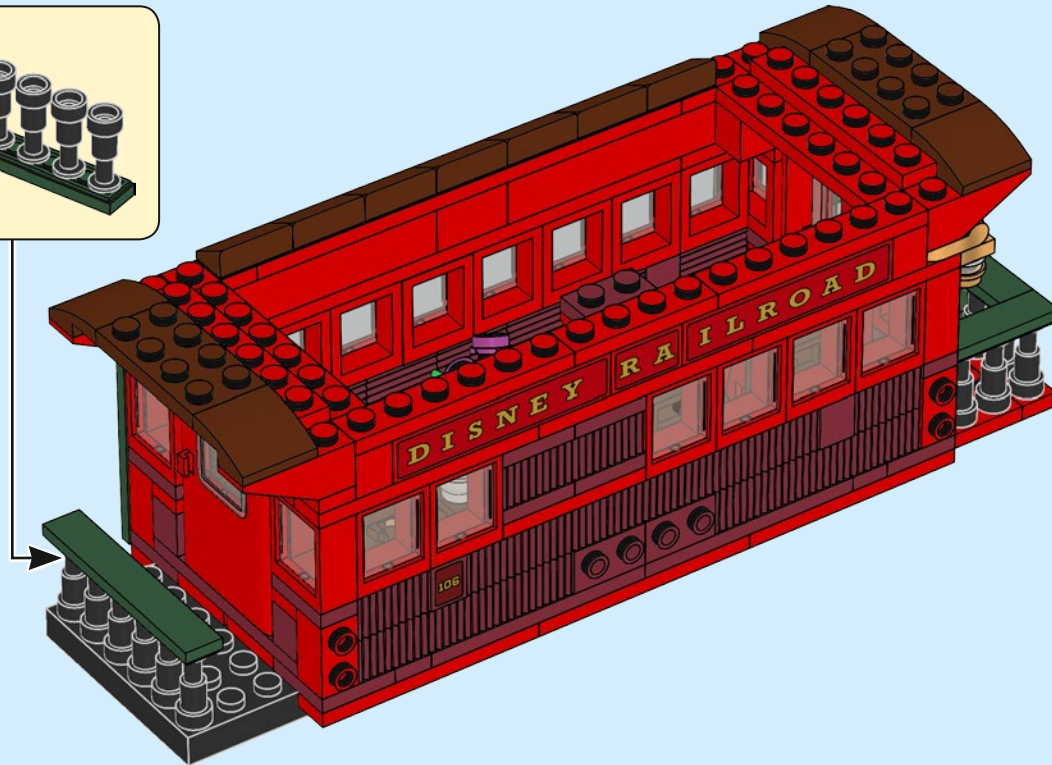
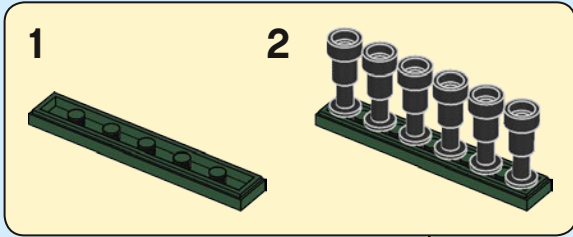

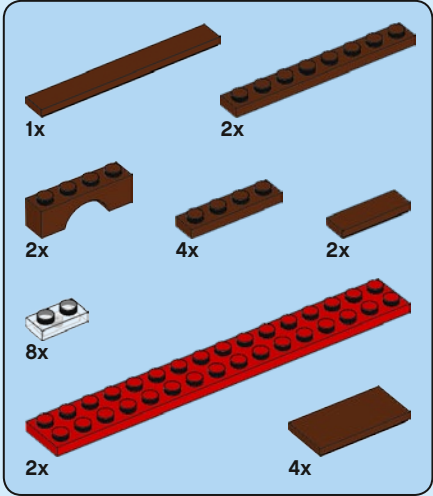
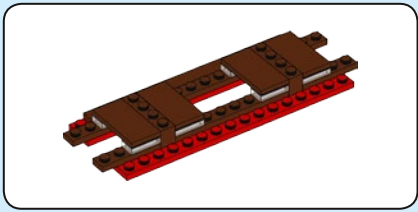

60

1

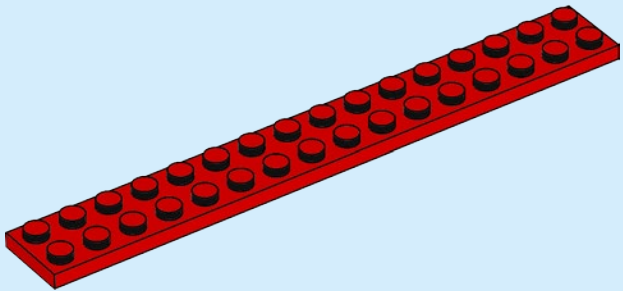

2

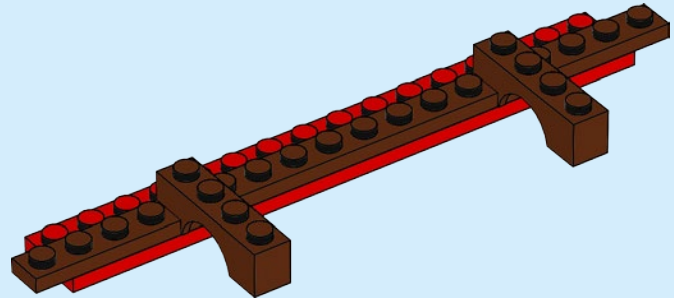

3

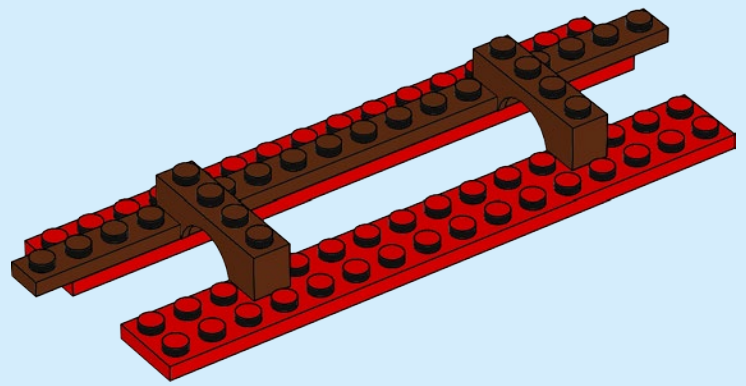

4

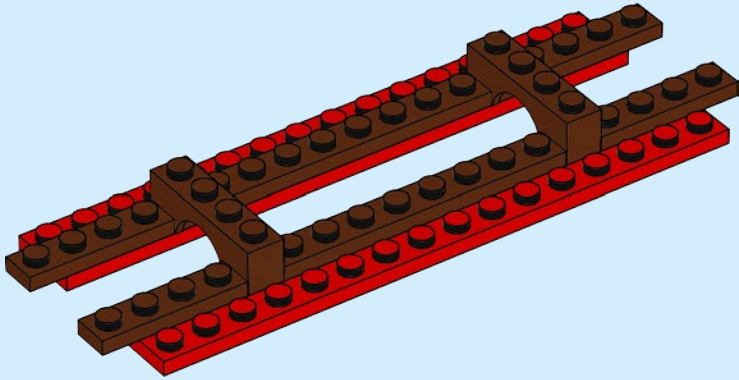

6

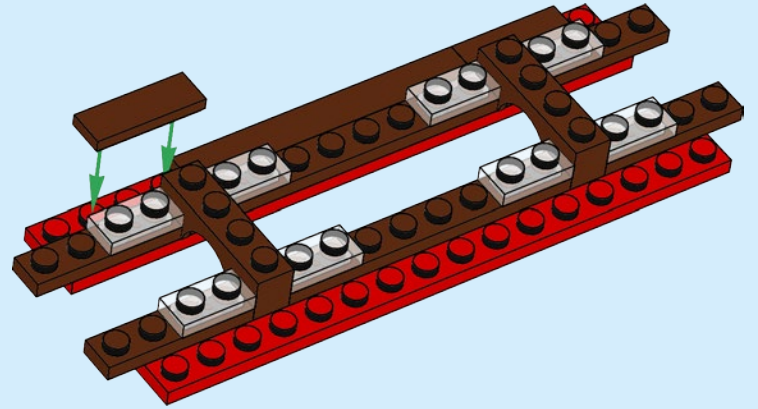

5

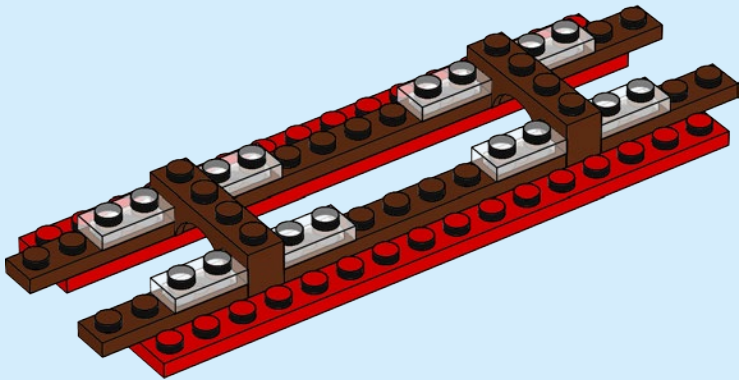

7

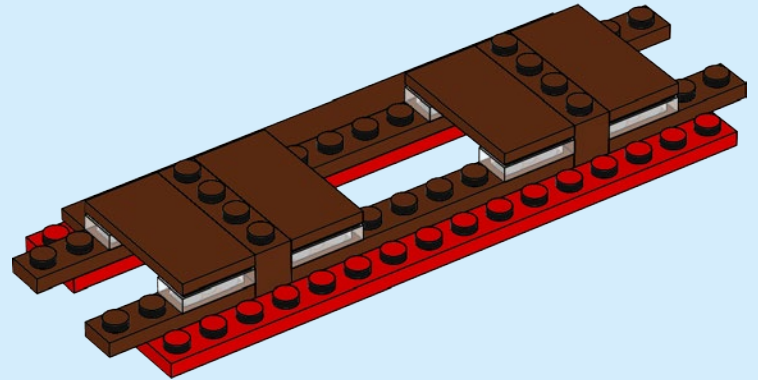

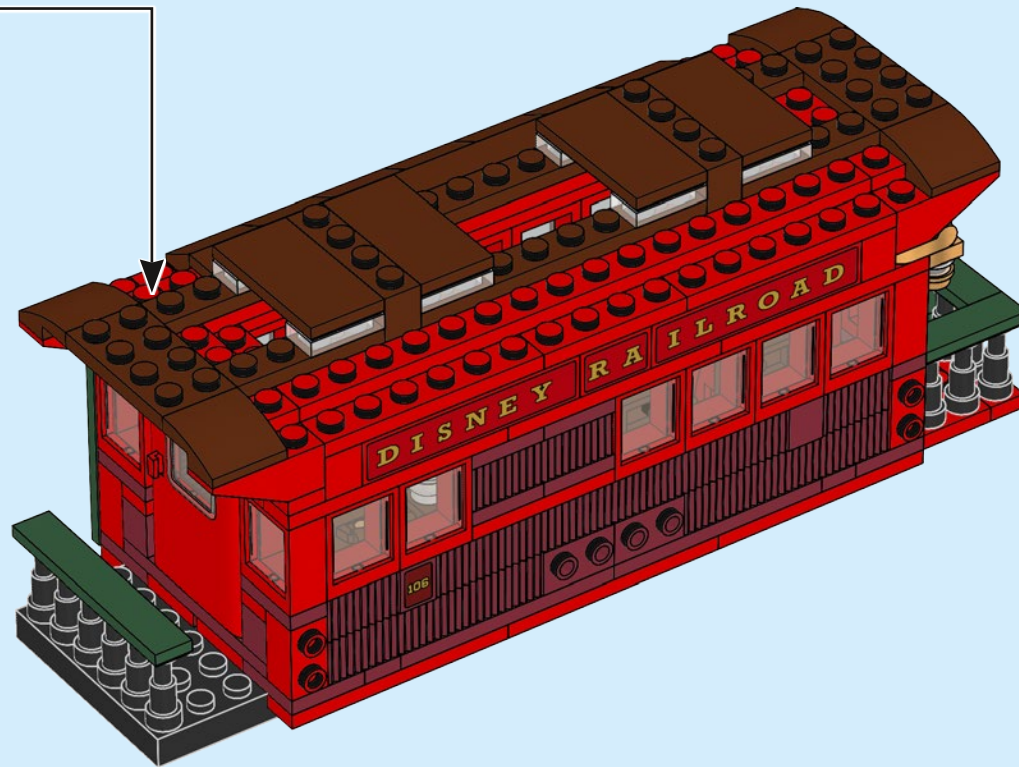



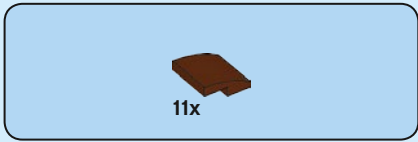

61

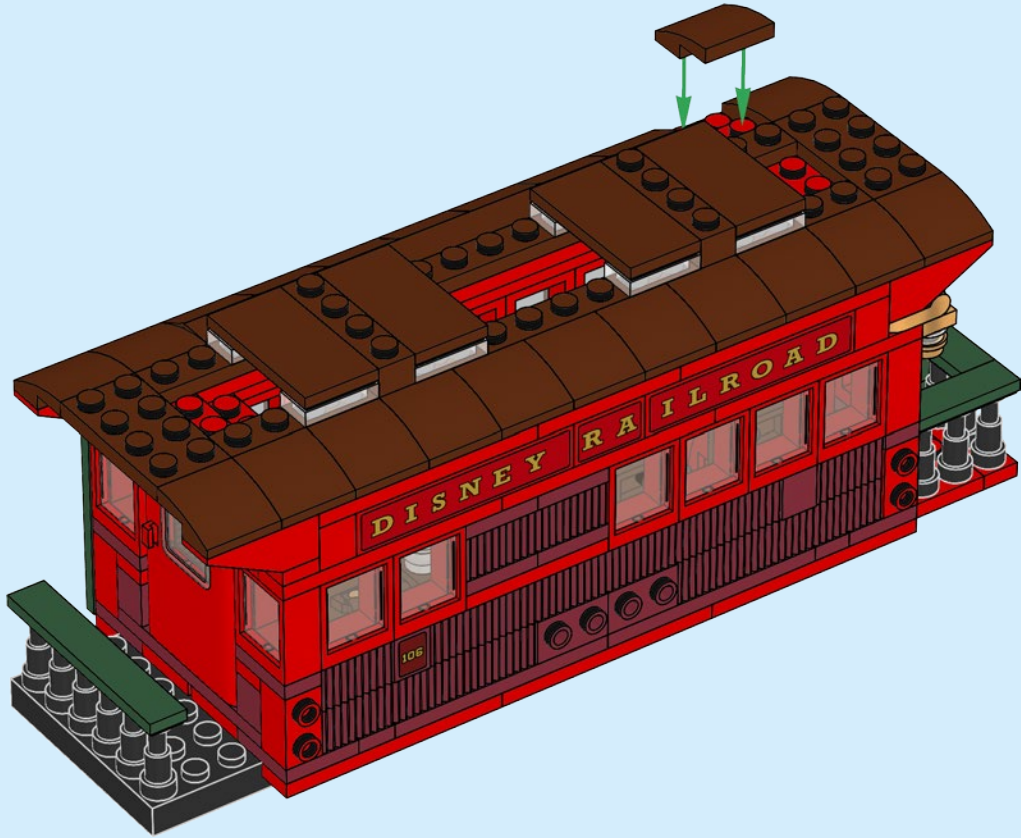

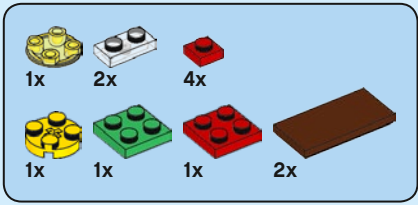

# 62

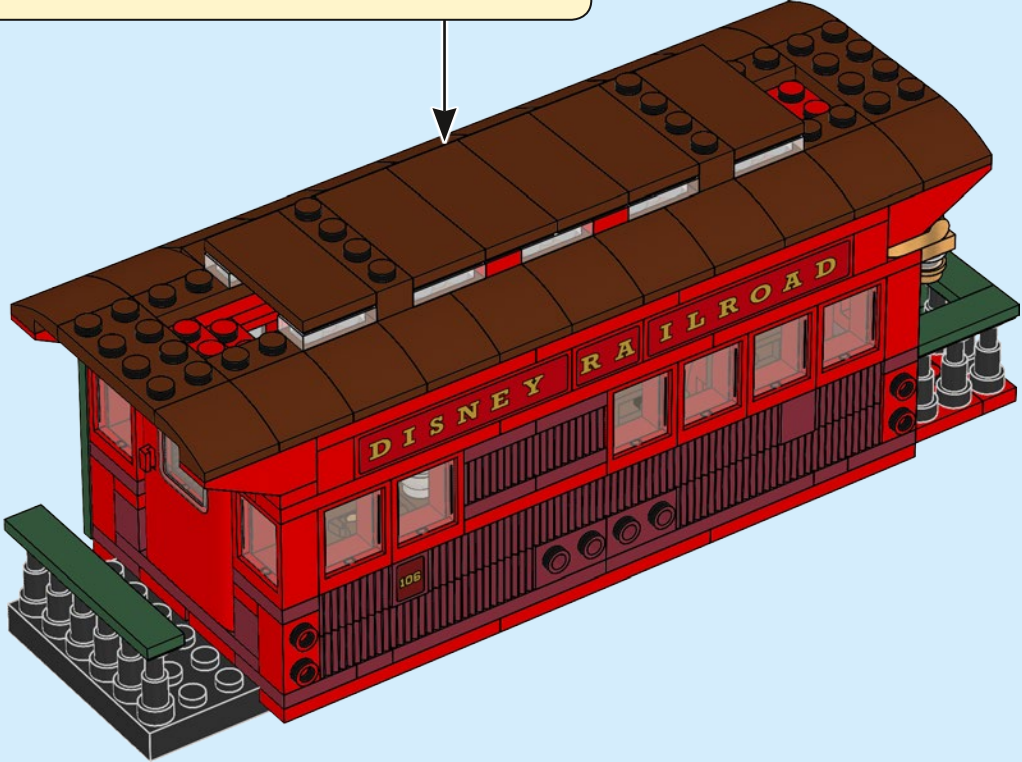
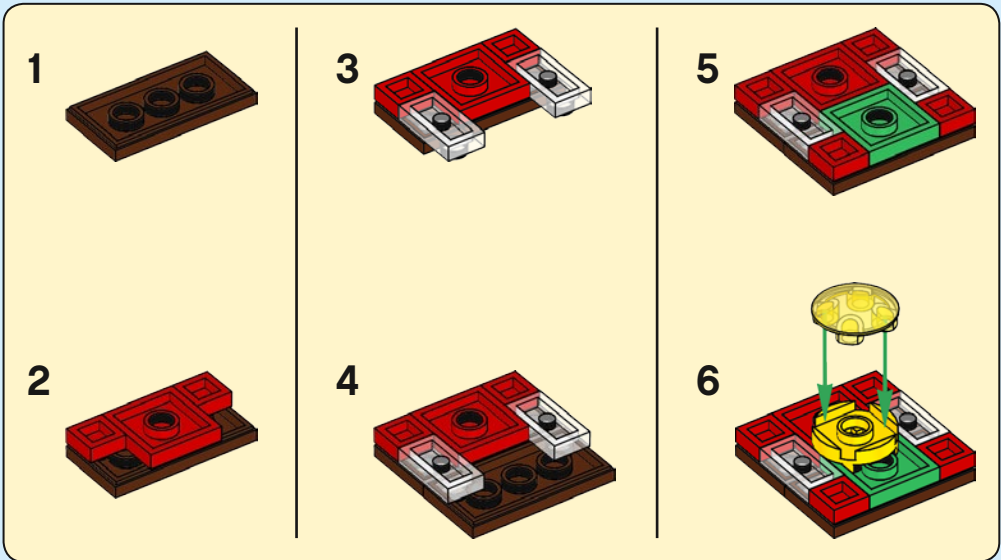

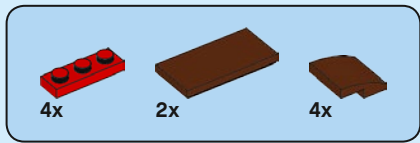

63

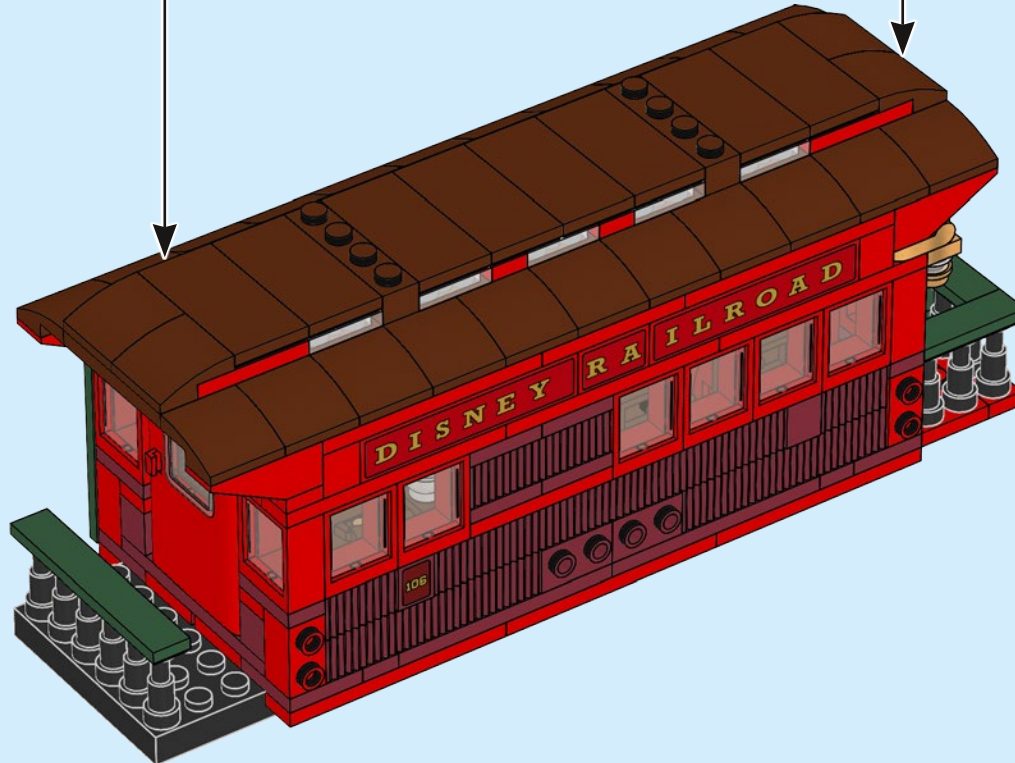
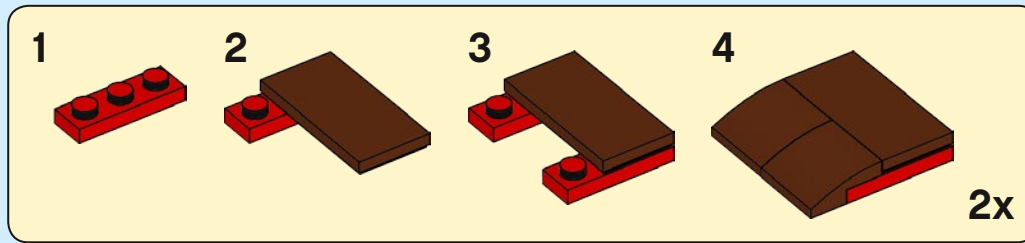

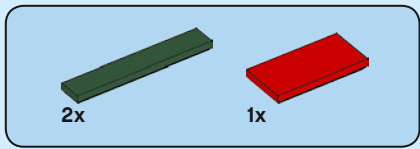

64

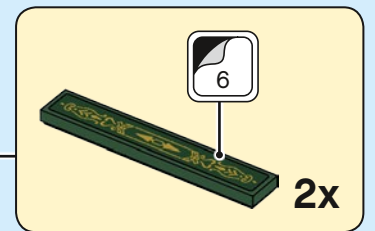
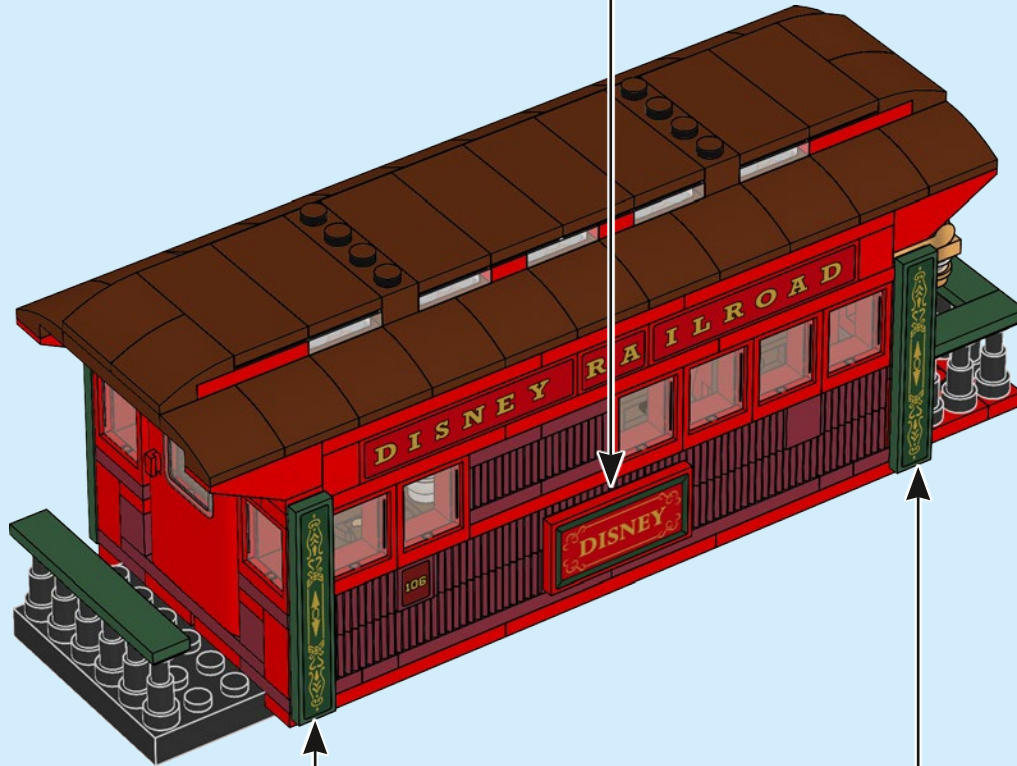
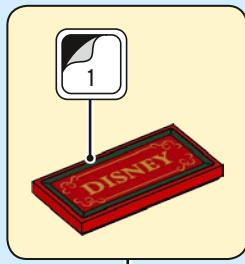

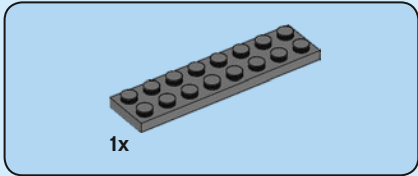
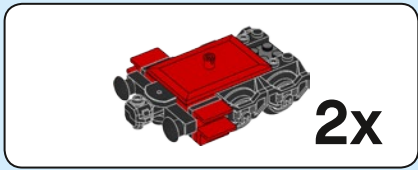

**65**

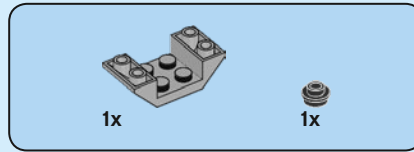
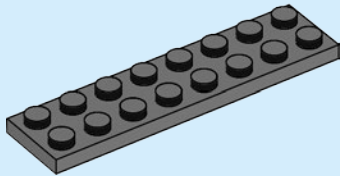

**66**

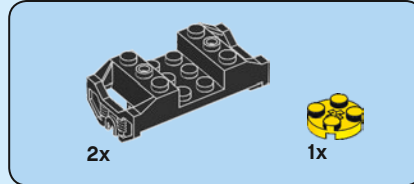
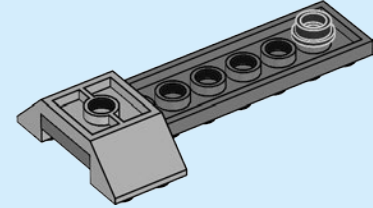

**67**

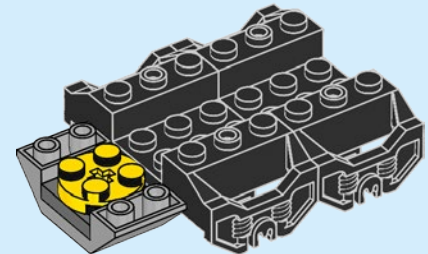

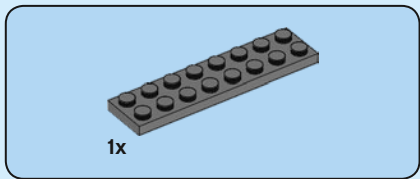

68

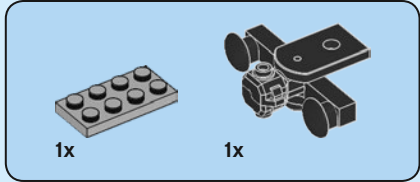
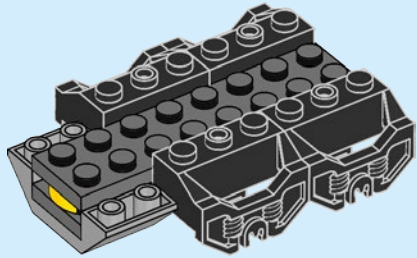

69

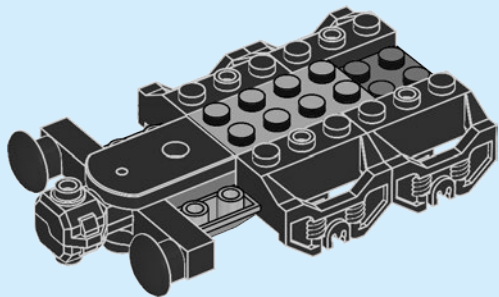

70

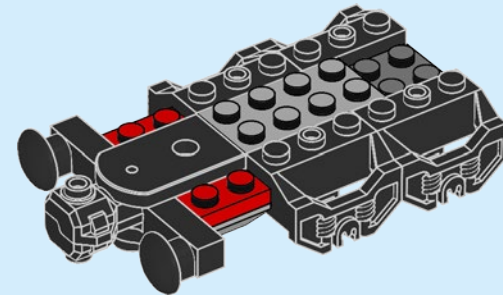



71

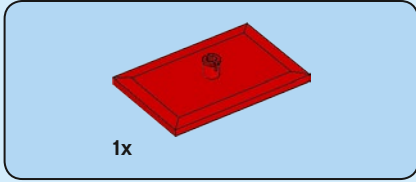
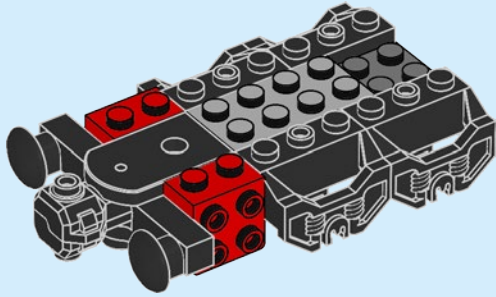

72

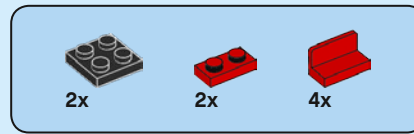
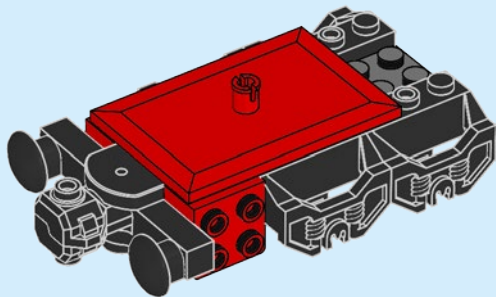

73

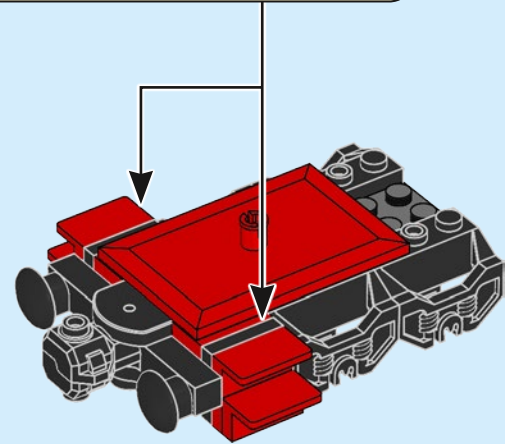
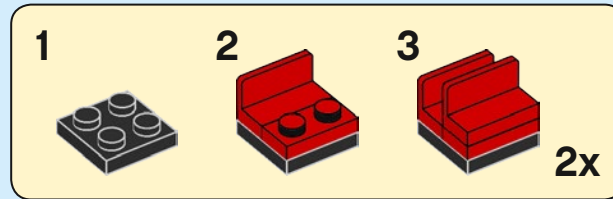



4x

74

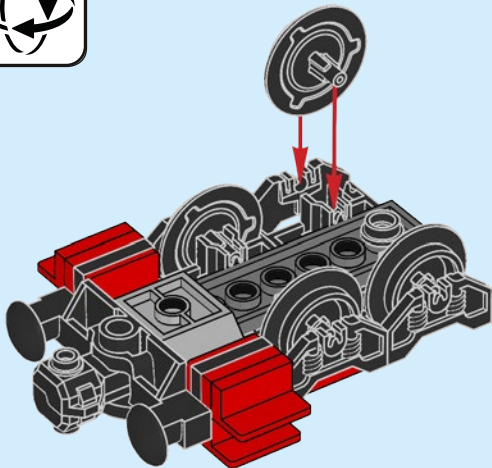

2x

75

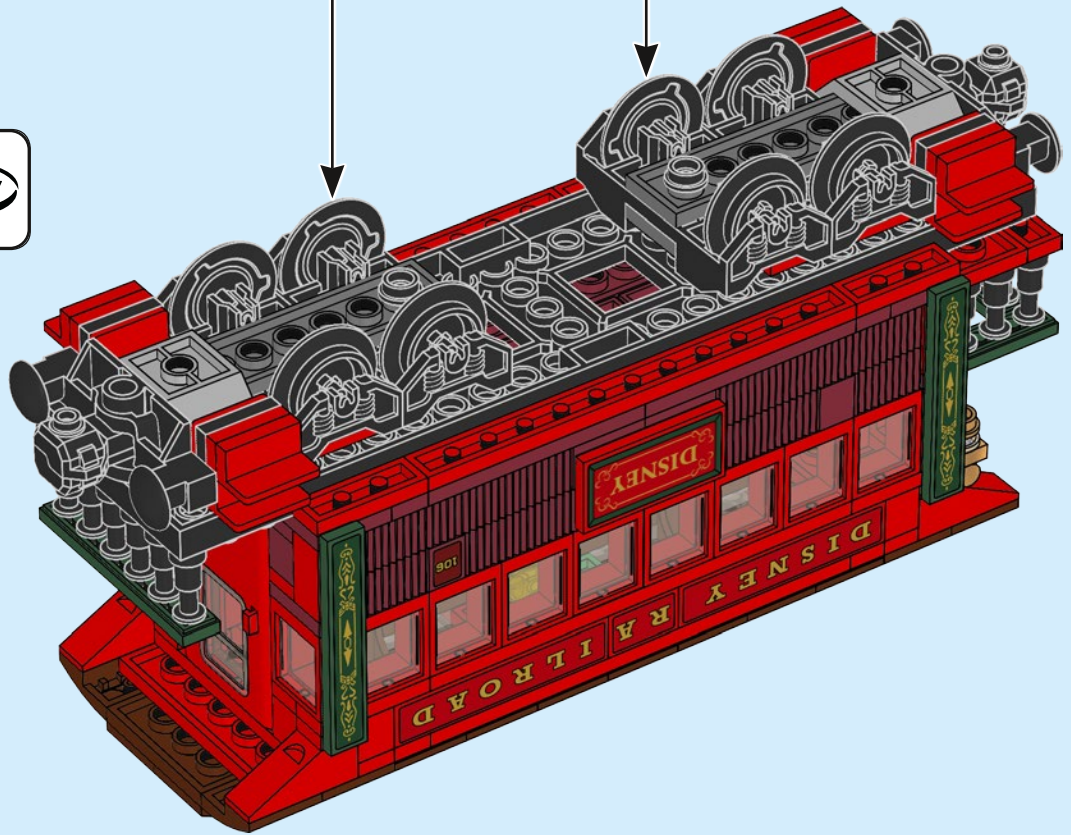
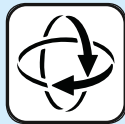



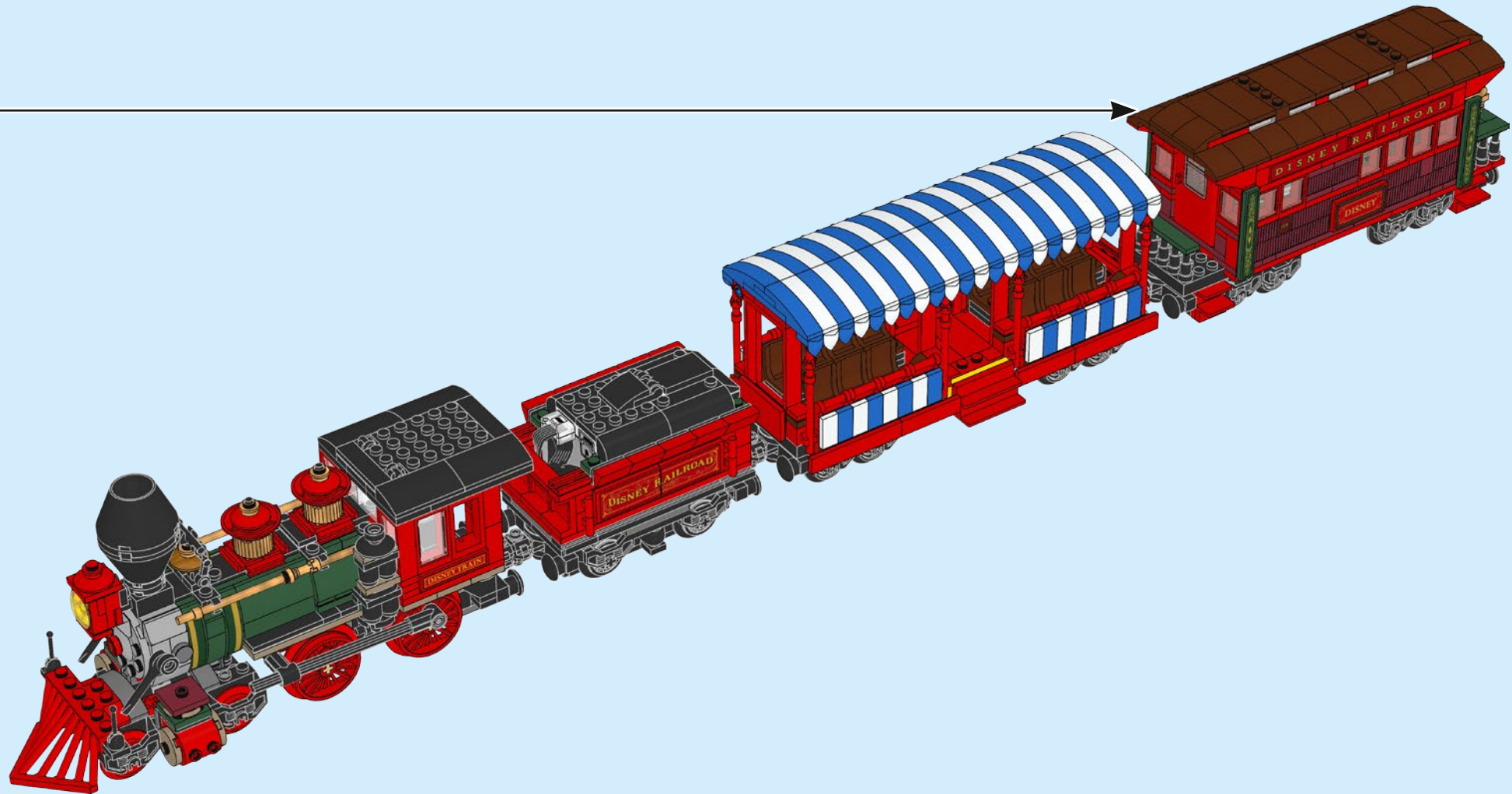

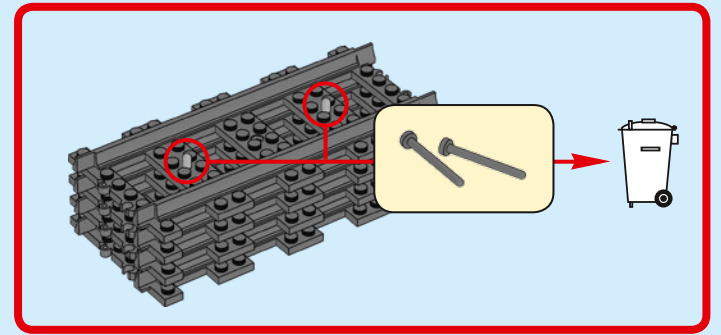
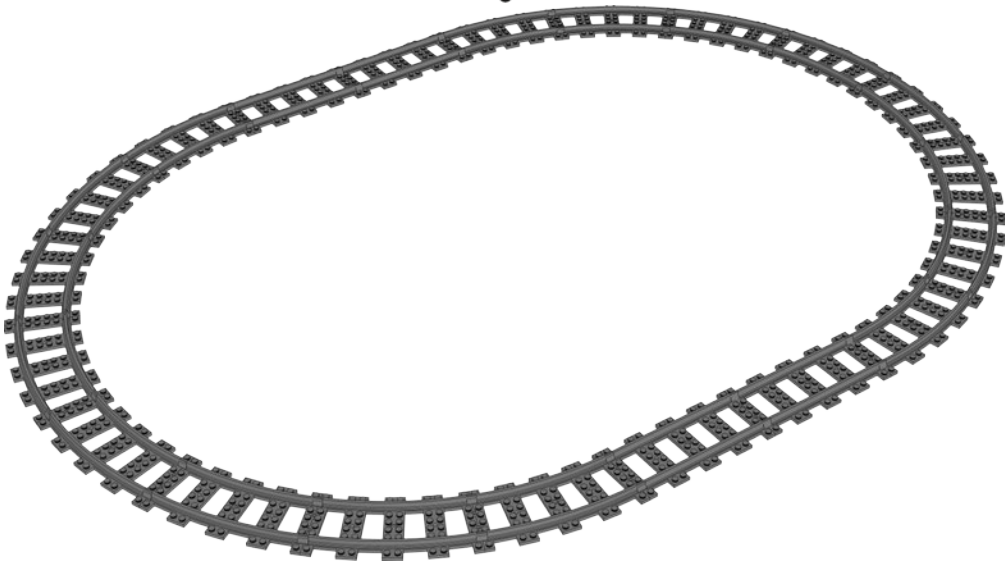
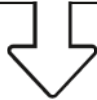
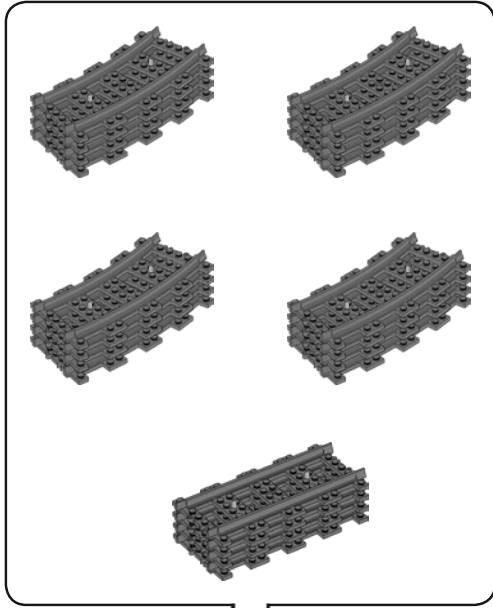

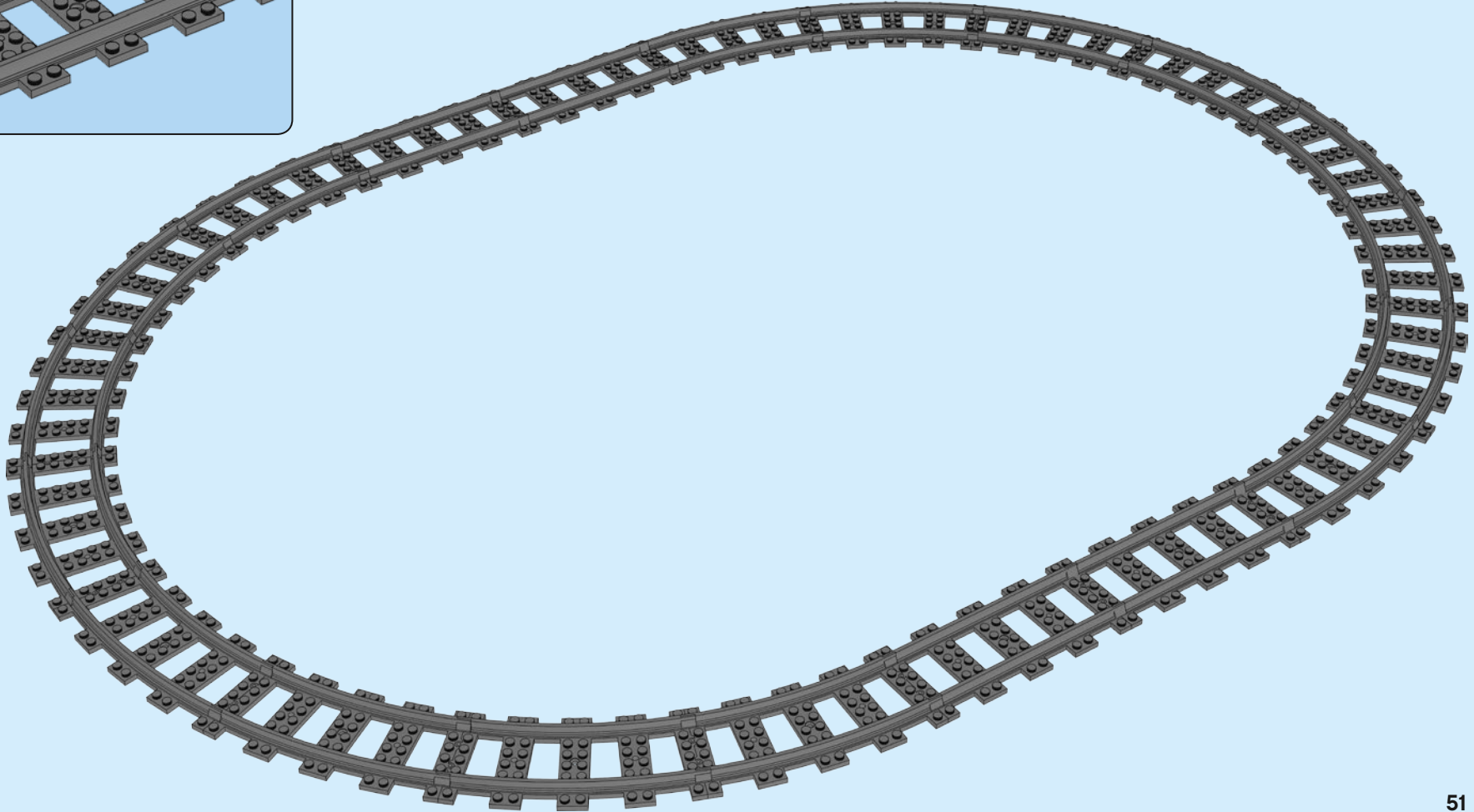
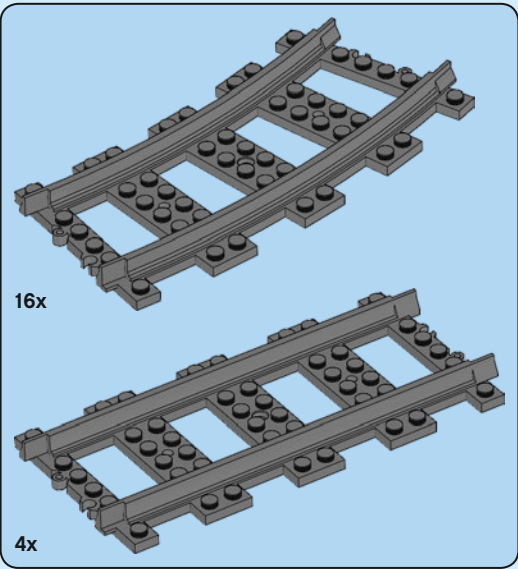



LEGO and the LEGO logo are trademarks of the/son des marques de commerce du/son marcas registradas de LEGO Group.  
©2019 The LEGO Group.

As to Disney Properties: ©Disney.  
Distributed by: Disney Theme Park Merchandise  
Lake Buena Vista, FL 32830

The Bluetooth® word mark and logos are registered trademarks owned by the Bluetooth SIG, Inc. and any use of such marks by The LEGO Group of companies is under license. Other trademarks and trade names are those of their respective owners.