

The LEGO logo is displayed in its characteristic white font with a black outline, set against a red rectangular background.

# BIONICLE

71312



**WARNING: CHOKING HAZARD.**  
Toy contains small parts and a small ball.  
Not for children under 3 years.



[LEGO.com/bionicle](http://LEGO.com/bionicle)



### AVERTISSEMENT :

RISQUE D'ÉTOUFFEMENT. Le jouet contient des petites pièces ainsi qu'une petite boule. Il ne convient pas aux enfants de moins de 3 ans.



### ADVERTENCIA: PELIGRO DE ASFIXIA.

Juguete que contiene partes pequeñas y una pelota pequeña. No recomendado para niños menores de 3 años.

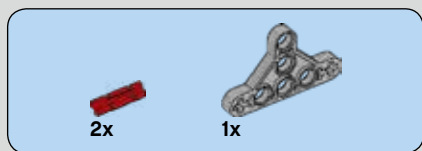

1

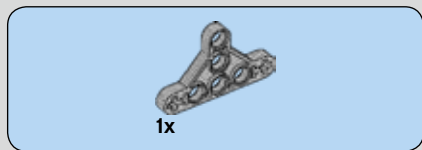
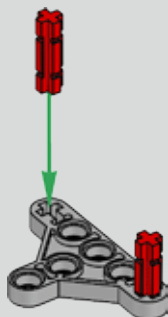

2

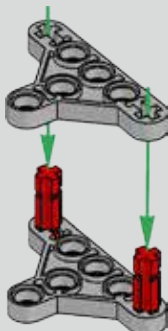



2x

3

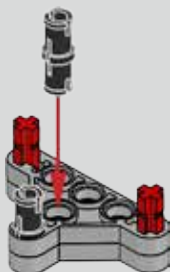

2x

4

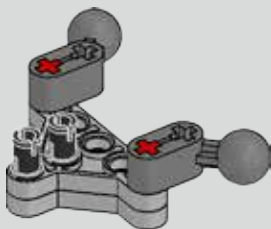



5

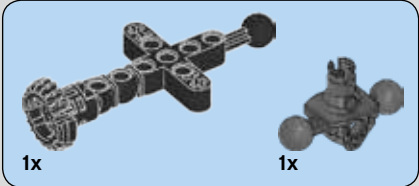
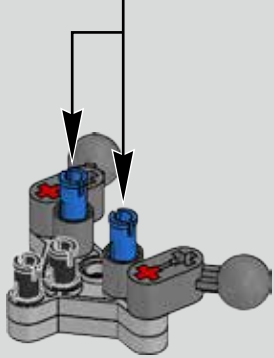
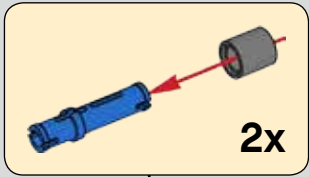

6

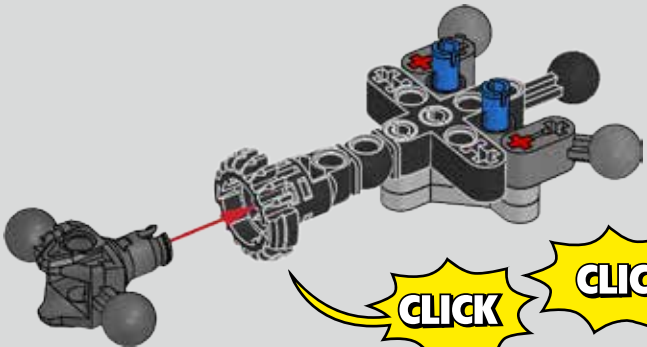



1x

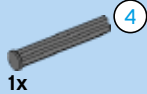

1x

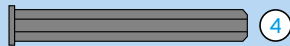

4

1:1

7

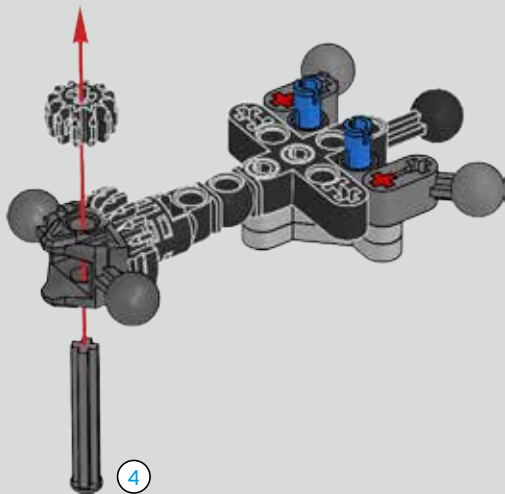

4



1x

8

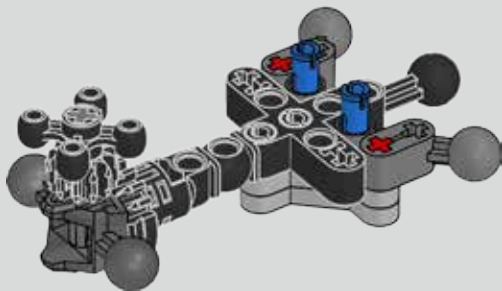

6

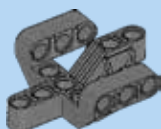

1x

# 9

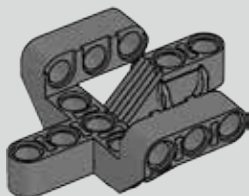

1x

# 10

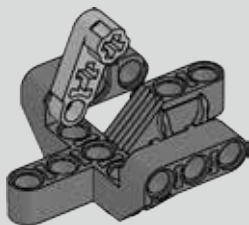

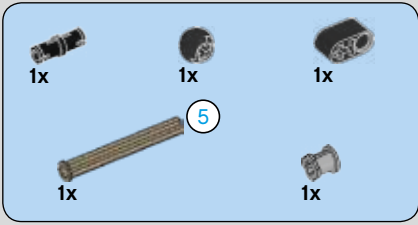

# 11

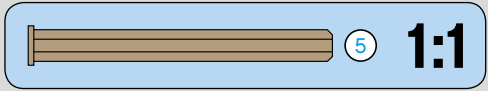
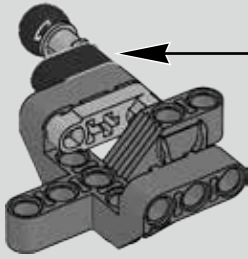
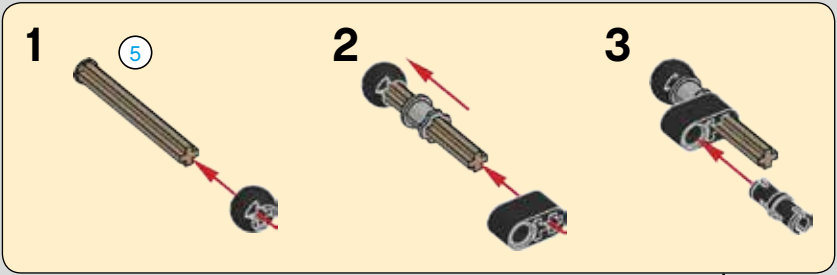





1x

# 12

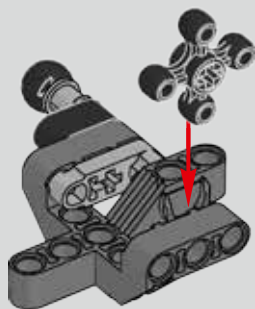

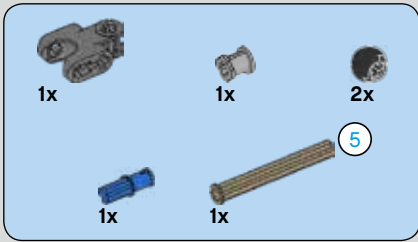

# 13

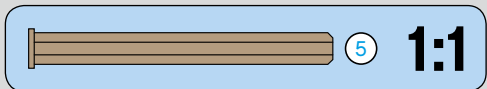
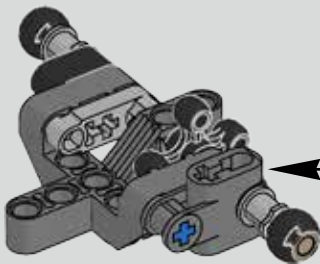
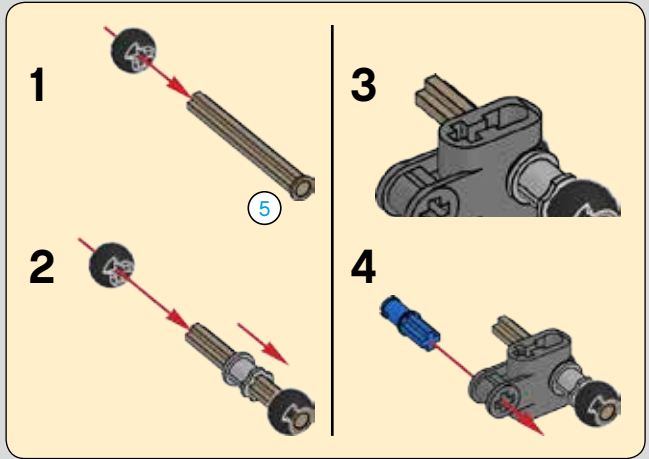



1x

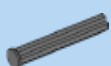

4

1x

# 14

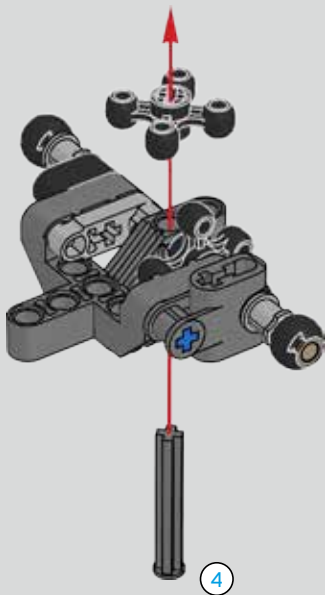

4

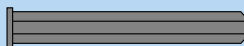

4

# 1:1



1x



1x

# 15

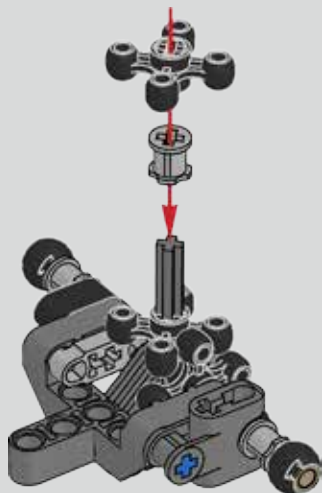

# 16

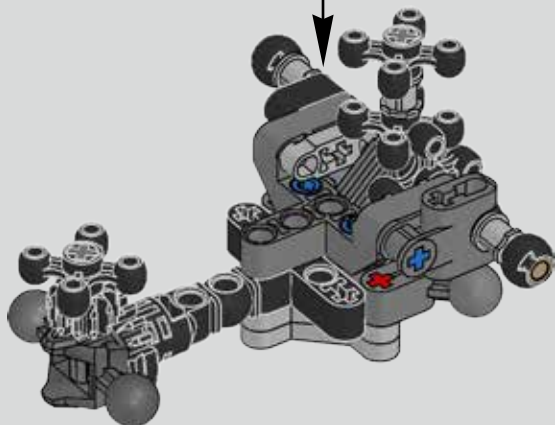



2x

# 17

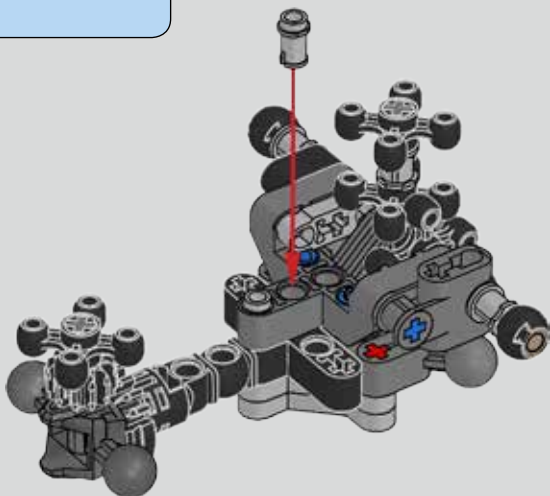

1x

# 18

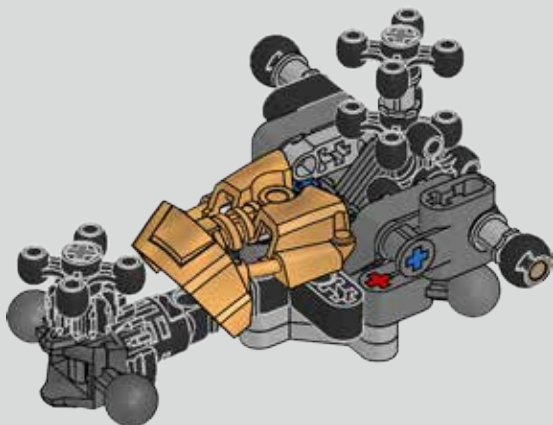



19

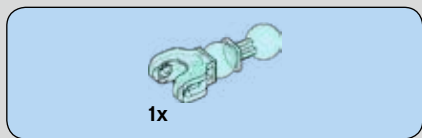

20

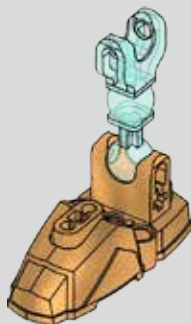

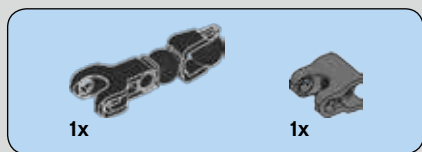

# 21

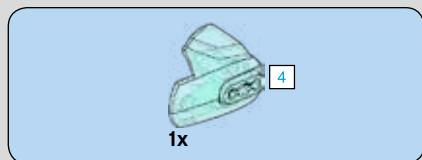
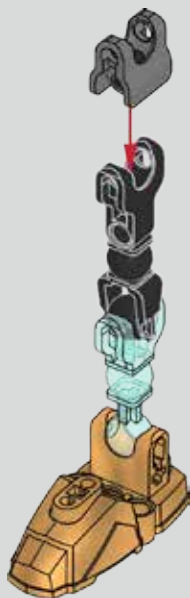

# 22

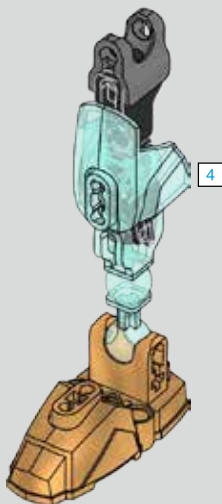



# 23

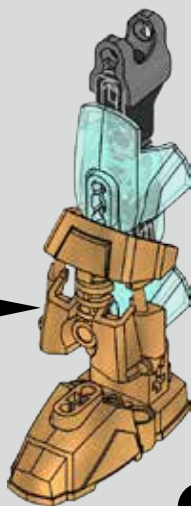

# 2x





24

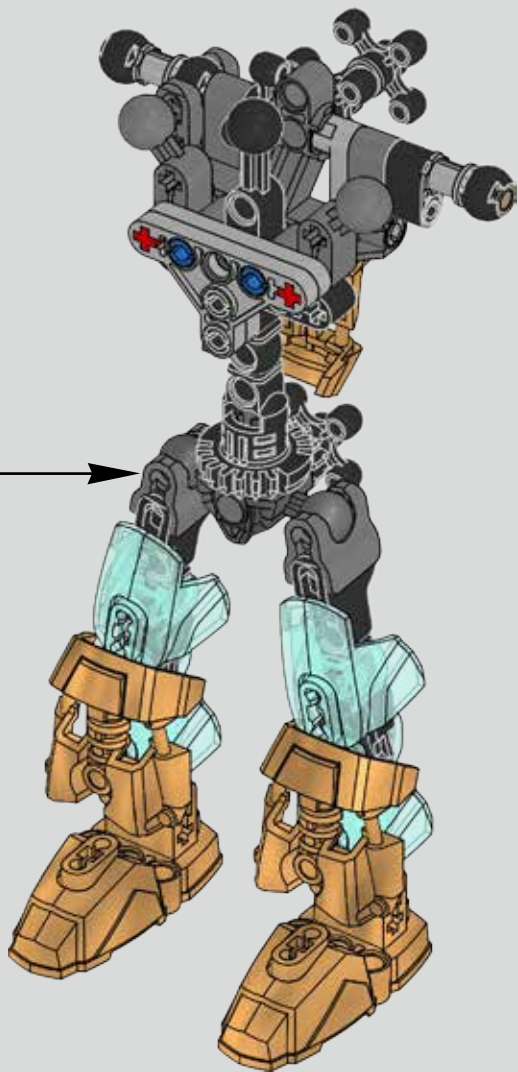

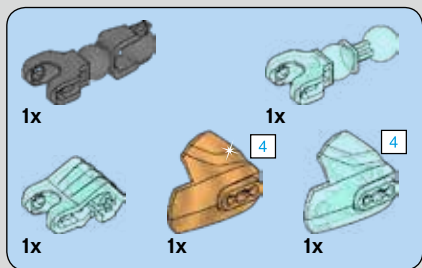

# 25

## 1

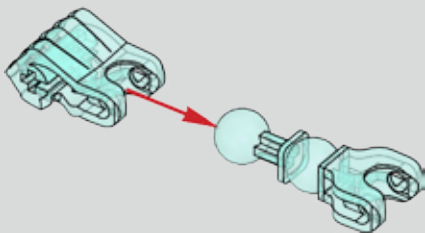

## 2

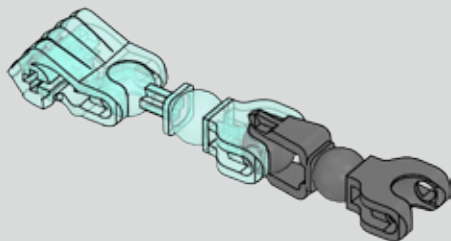

3

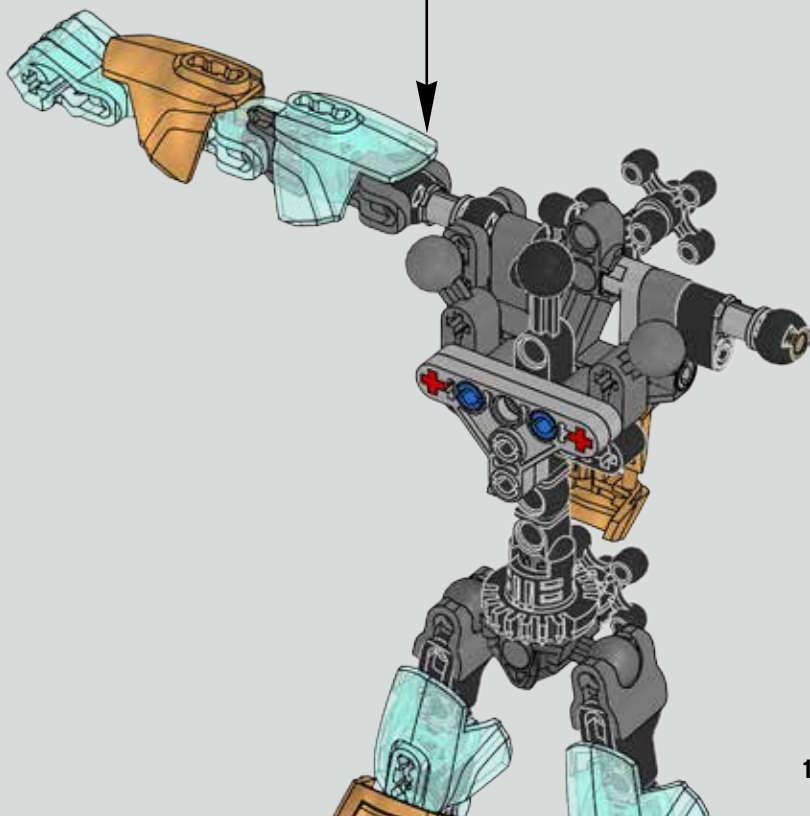
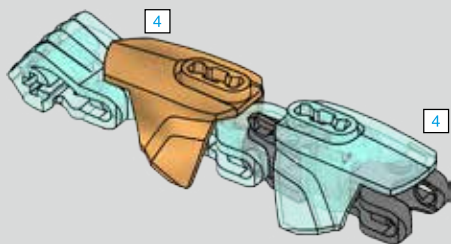

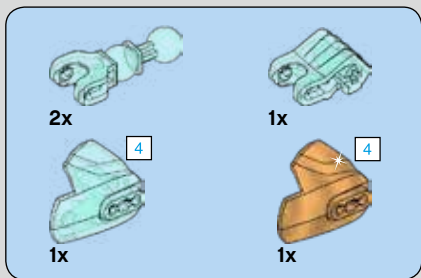
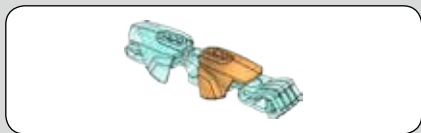

# 26

## 1

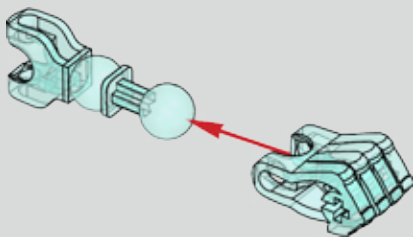

## 2

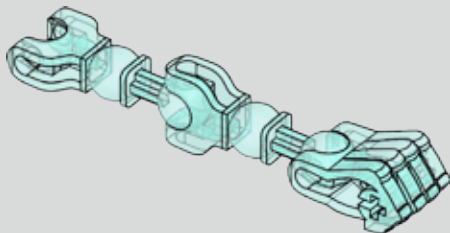

# 3

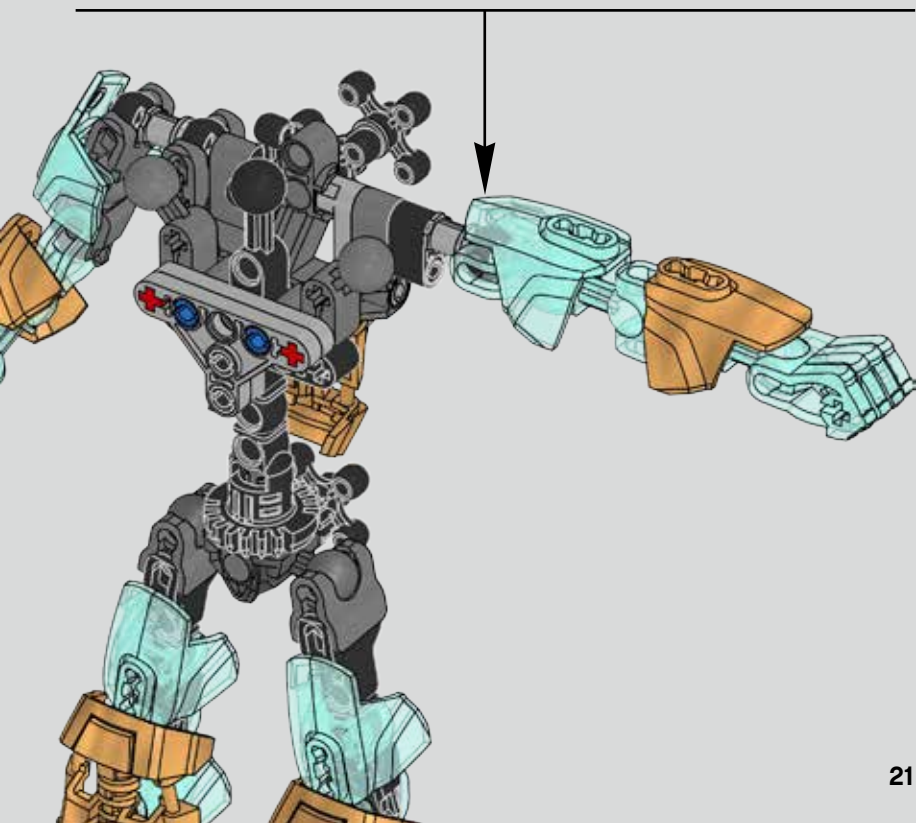
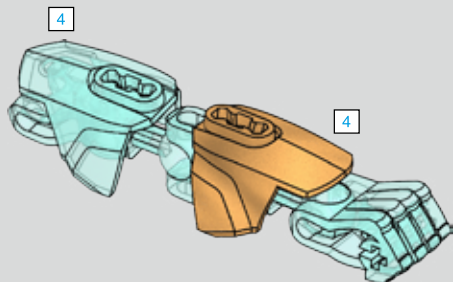



1x

# 27

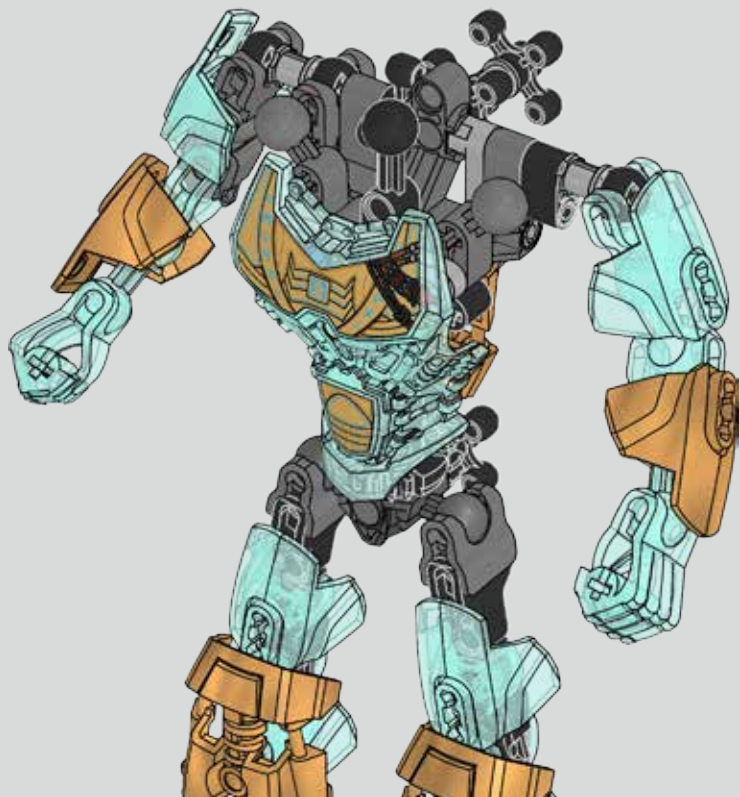

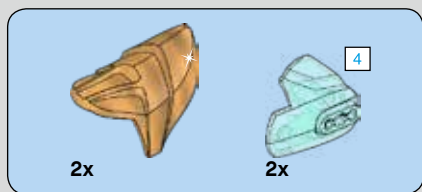

28

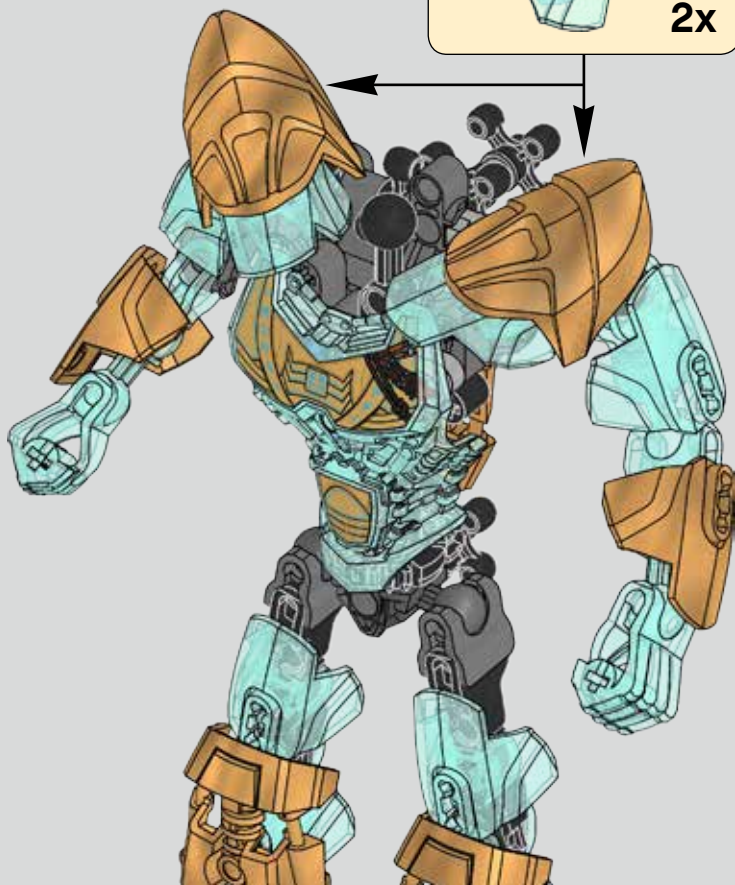
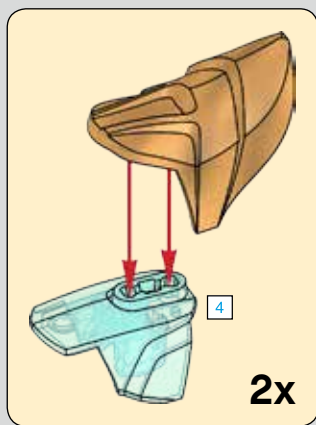

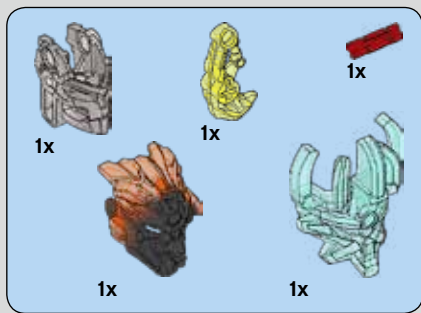

# 29

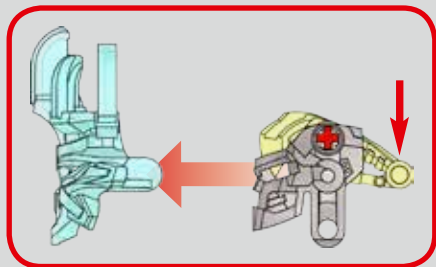
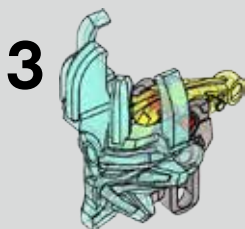
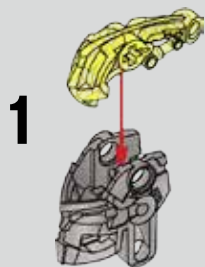



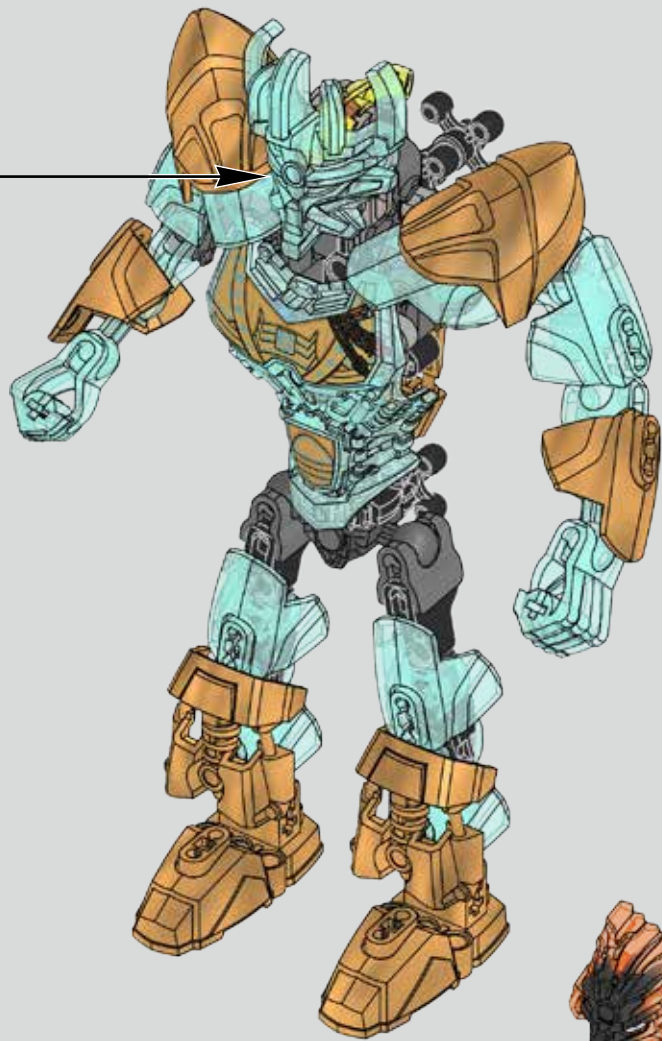

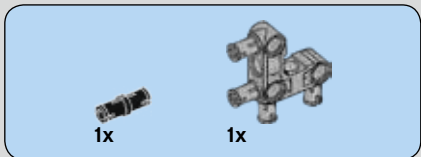

**30**

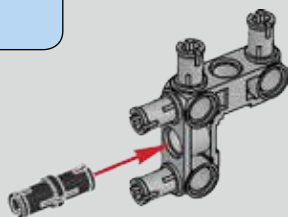

**31**

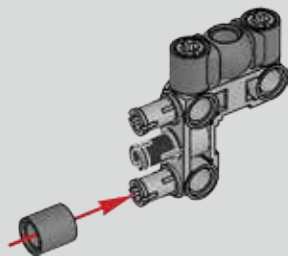

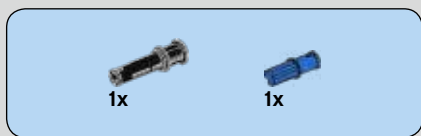

# 32

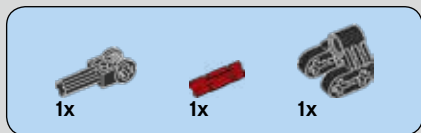
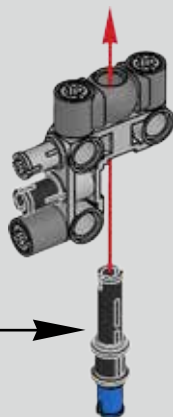
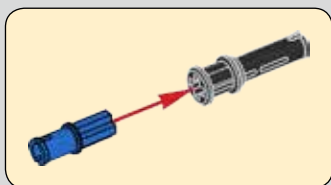

# 33

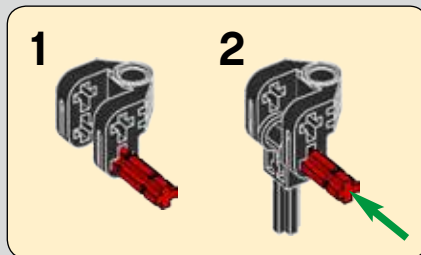



1x



1x

# 34

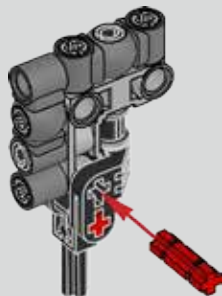

1x

# 35

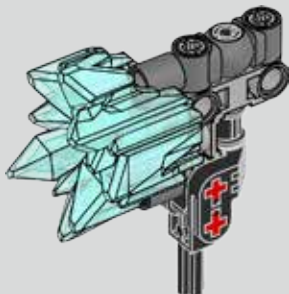



# 36

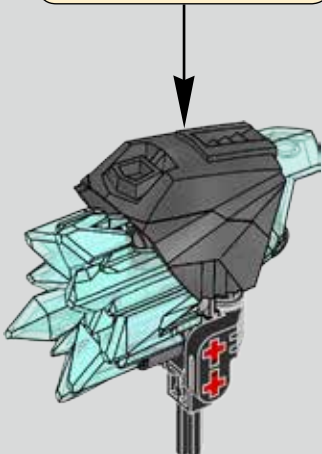
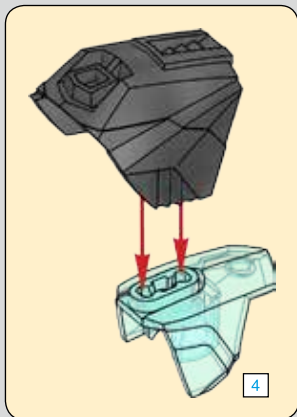

37

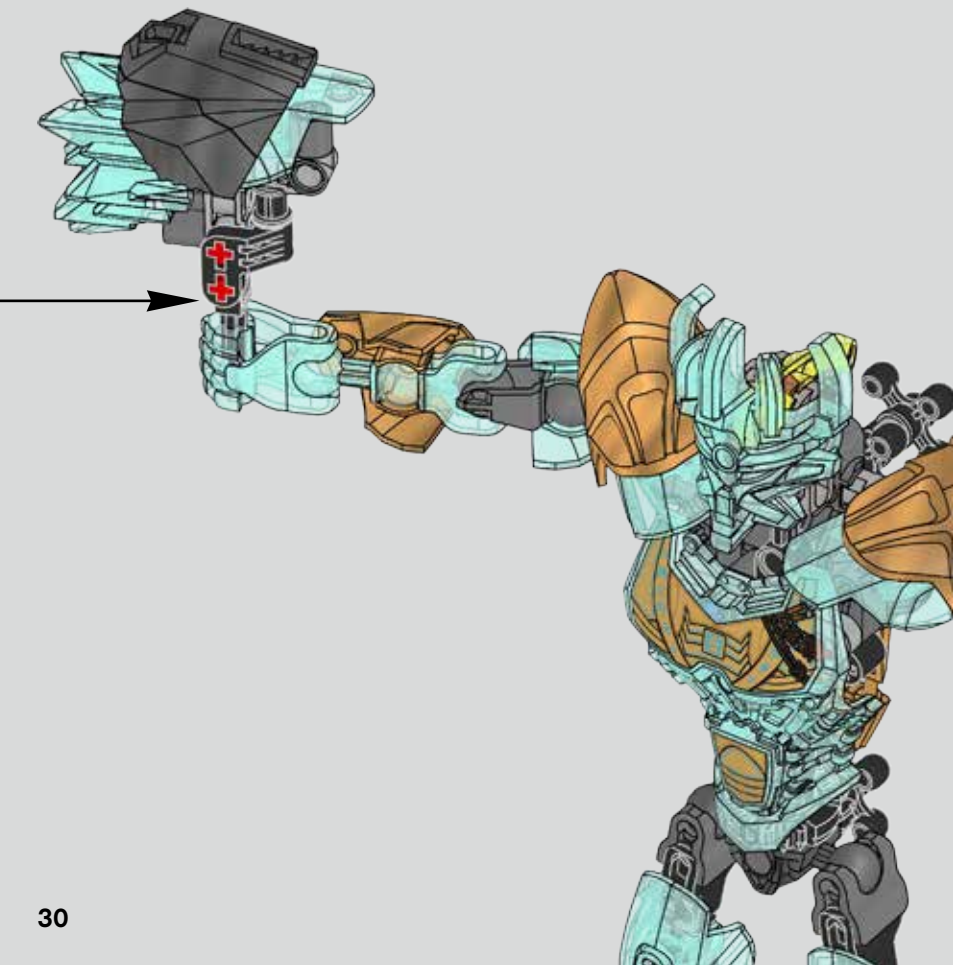

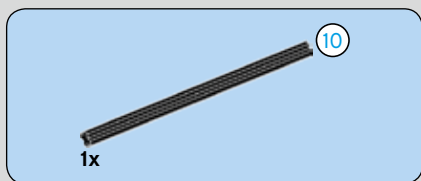

# 38

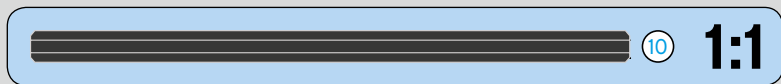
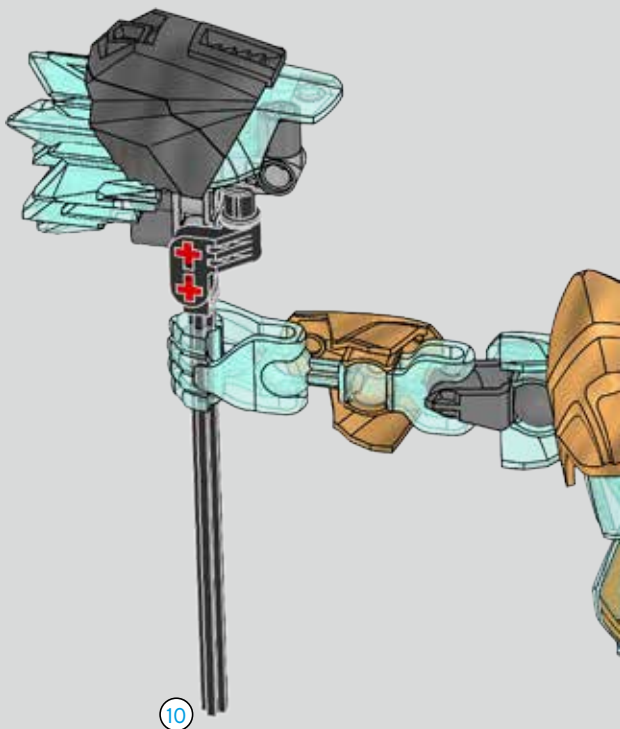

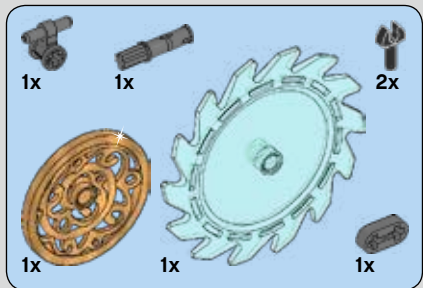
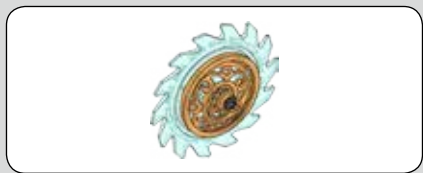

**39**

**1**

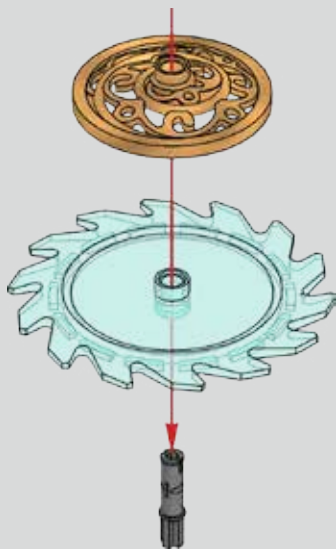





**2**

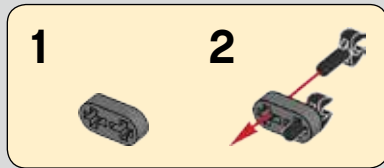
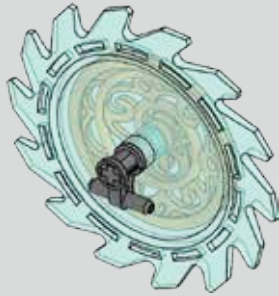

**3**

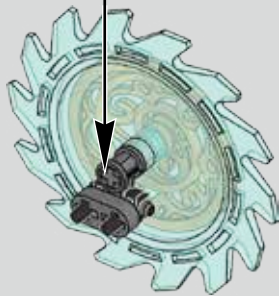

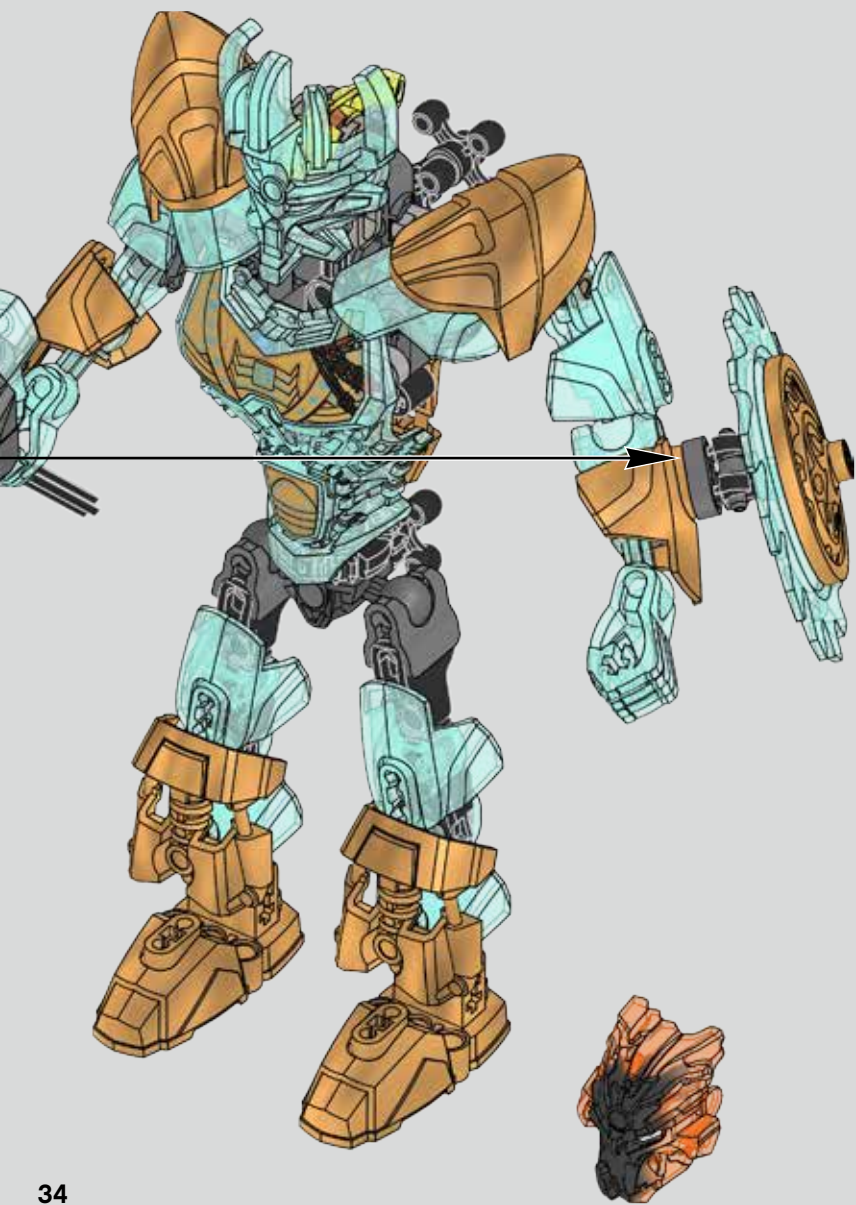

5x  
4142865



1x  
6102639



1x  
6139106



1x  
4667120



2x  
4206482



2x  
4514553

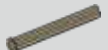

2x  
6055631



1x  
4563045



3x  
4211622



2x  
4211483



2x  
6009019



1x  
4296059

4x  
4121715



1x  
4177431



1x  
4107765



1x  
6006140



1x  
4610371



2x  
4593562



4x  
4248204



3x  
4286267



1x  
4140801



2x  
4289538



1x  
6135125



1x  
373726



2x  
6106472



1x  
4626667



2x  
6083620



1x  
4210980



3x  
6100030



1x  
4622903



1x  
6020189



1x  
6102645



1x  
6015356



2x  
6001085



2x  
4289258



5x  
6043679



1x  
6150073



1x  
6145448



9x  
6139209



1x  
6079018



2x  
6043685



1x  
6150182



1x  
6154810



3x  
6102792



2x  
6092885



1x  
6058138



2x  
6133770



2x  
6075042



1x  
6102606

Customer Service

Kundenservice

Service Consommateurs

Servicio Al Consumidor

LEGO.com/service or dial



: 00800 5346 5555

: 1-800-422-5346



# BIONICLE







71313



71315



LEGO.com/BIONICLE

Download App  
Télécharger  
l'application  
Descarga la App



Apple and the Apple logo are trademarks of Apple Inc., registered in the U.S. and other countries. App Store is a service mark of Apple Inc.

Google Play is a trademark of Google Inc.



71314



71316

71313 + 71314 + 71315 + 71316



Download on the  
App Store



GET IT ON  
Google play

NETFLIX



LEGO.com/BIONICLE/bi