

The LEGO logo is displayed in its characteristic white font with a black outline, set against a red rectangular background.

BIONICLE[®]

71315



WARNING: CHOKING HAZARD.
Toy contains small parts and a small ball.
Not for children under 3 years.



[LEGO.com/bionicle](https://www.LEGO.com/bionicle)



AVERTISSEMENT :

RISQUE D'ÉTOUFFEMENT. Le jouet contient des petites pièces ainsi qu'une petite boule. Il ne convient pas aux enfants de moins de 3 ans.



ADVERTENCIA:

PELIGRO DE ASFIXIA. Juguete que contiene partes pequeñas y una pelota pequeña. No recomendado para niños menores de 3 años.

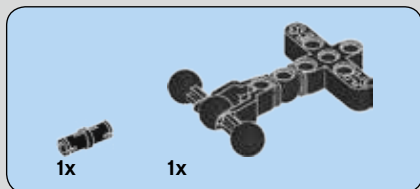

1

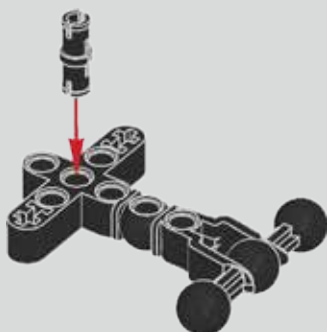

2

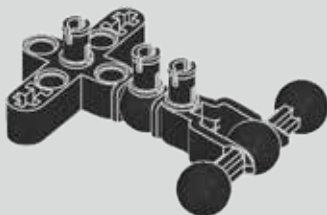



1x



1x

3

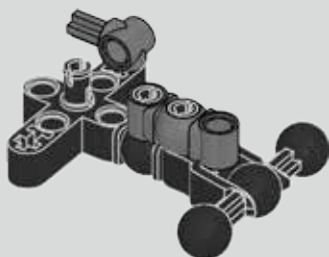

1x

4

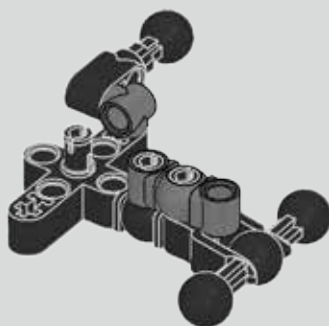

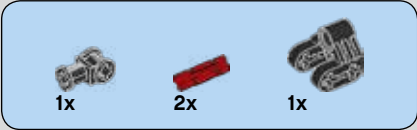

5

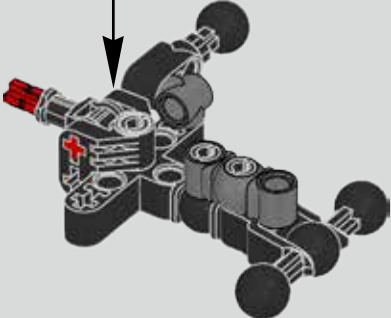
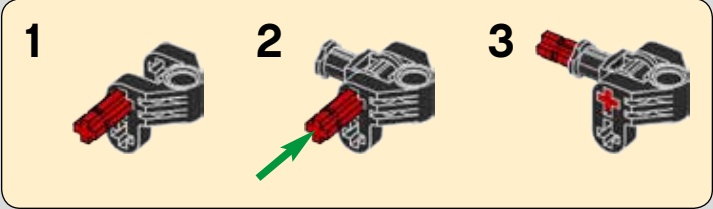



6

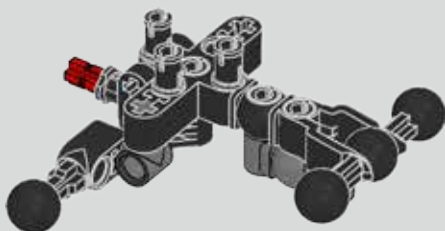
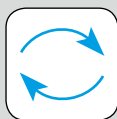

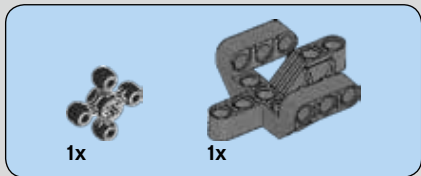

7

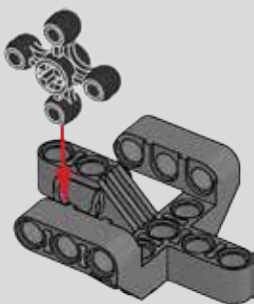



8

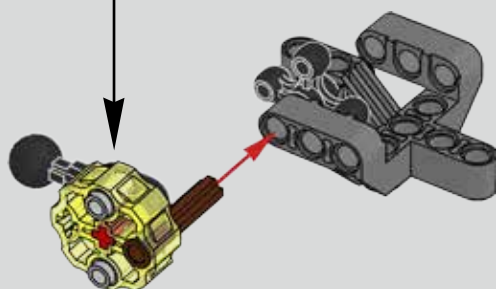
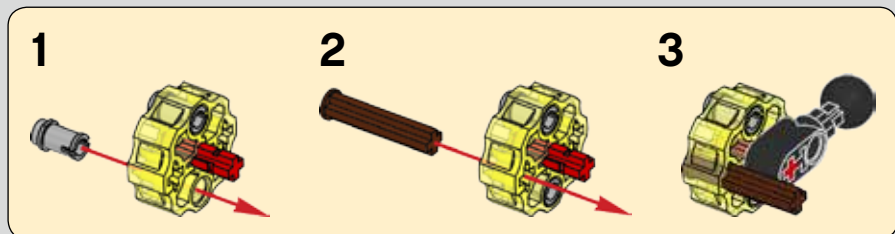

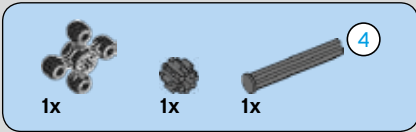

9

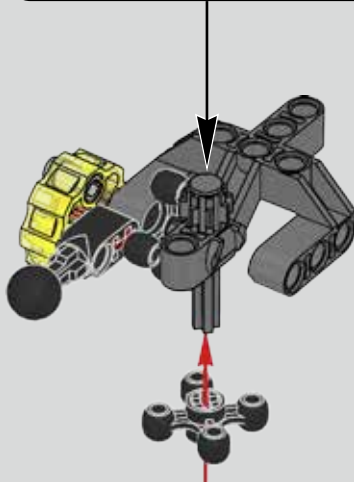
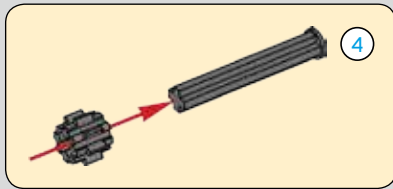



1x



1x

10

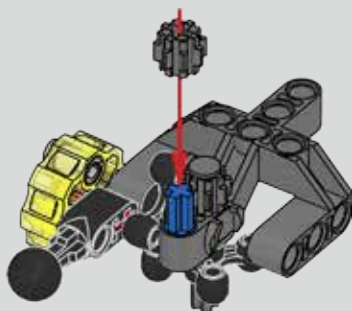

1x



1x

11

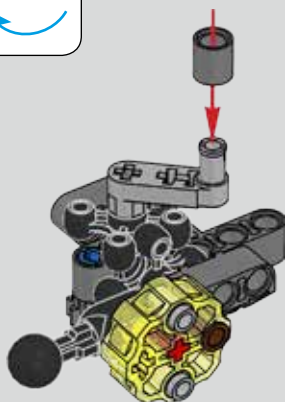
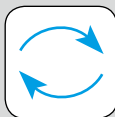

12

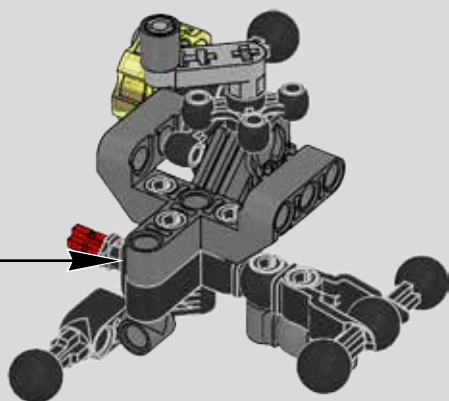

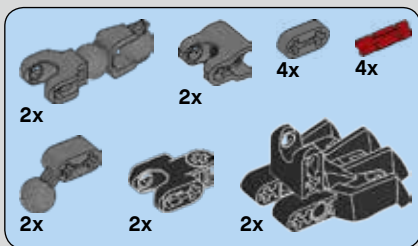
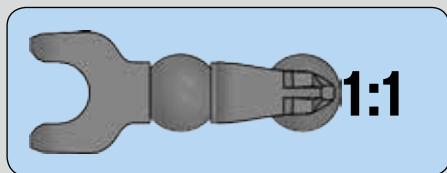

13

1



2

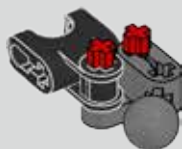

3

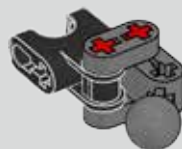

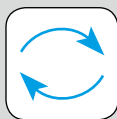

4

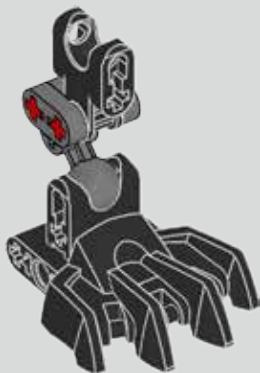

5

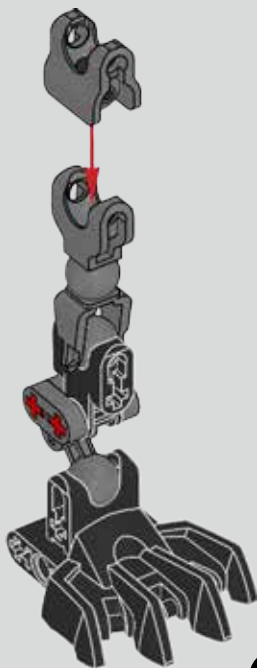

2x

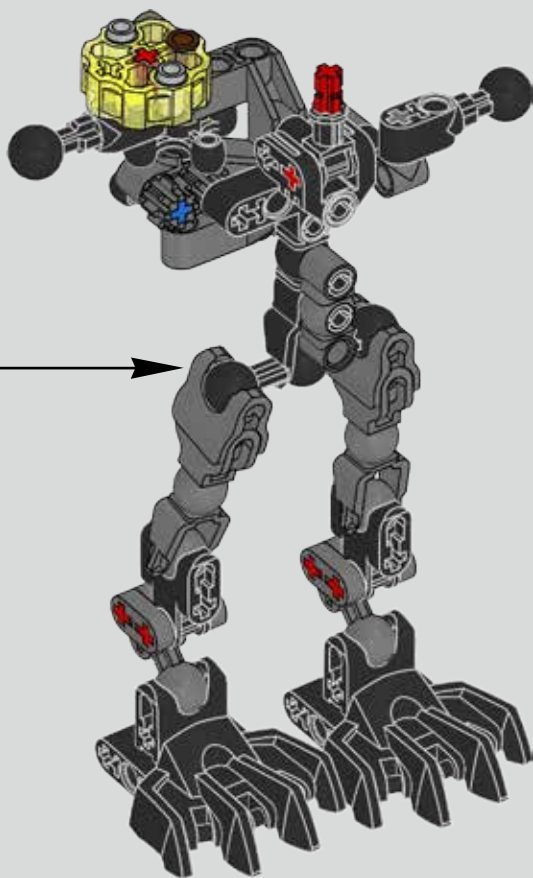
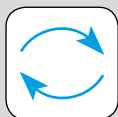

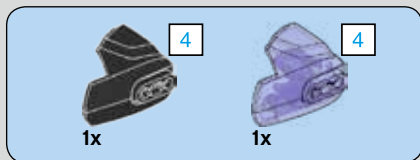

14

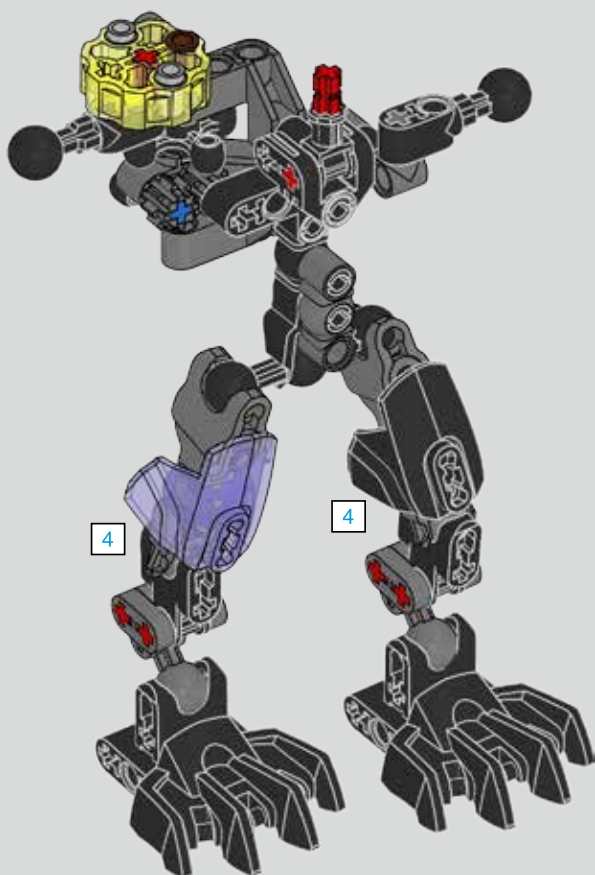



1x



1x

15

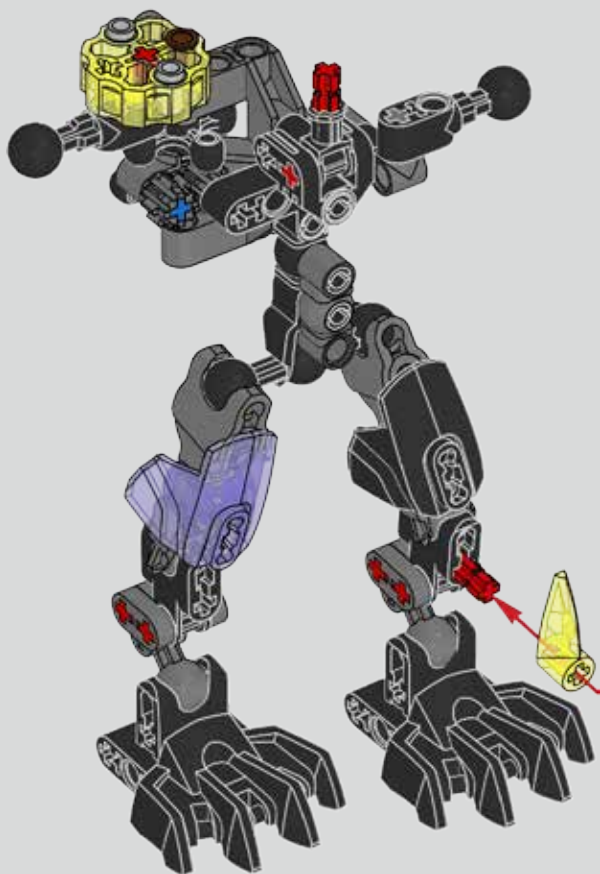

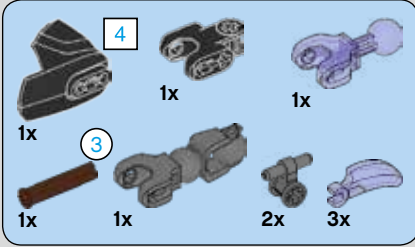
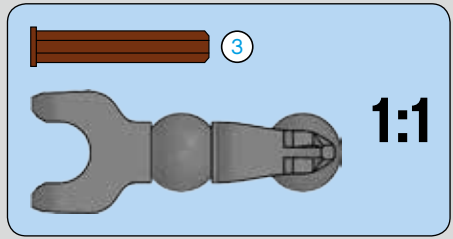

16

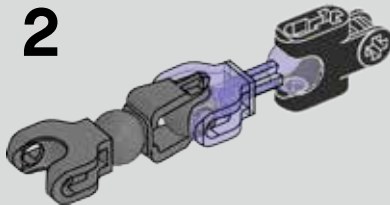
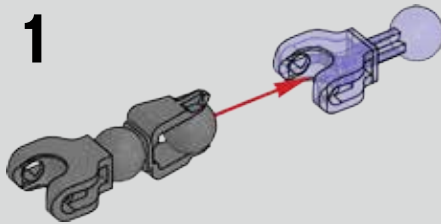

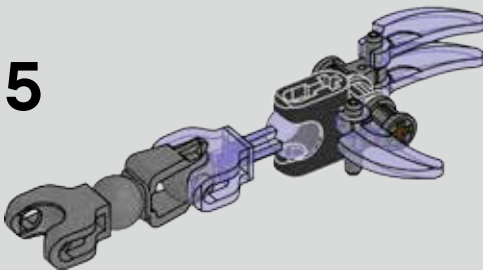
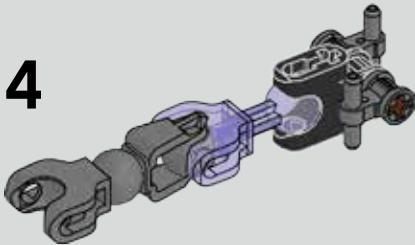
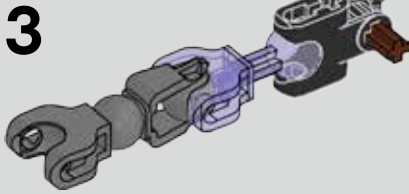
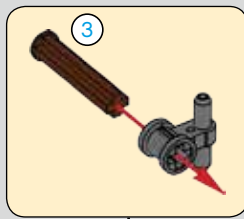

6

4

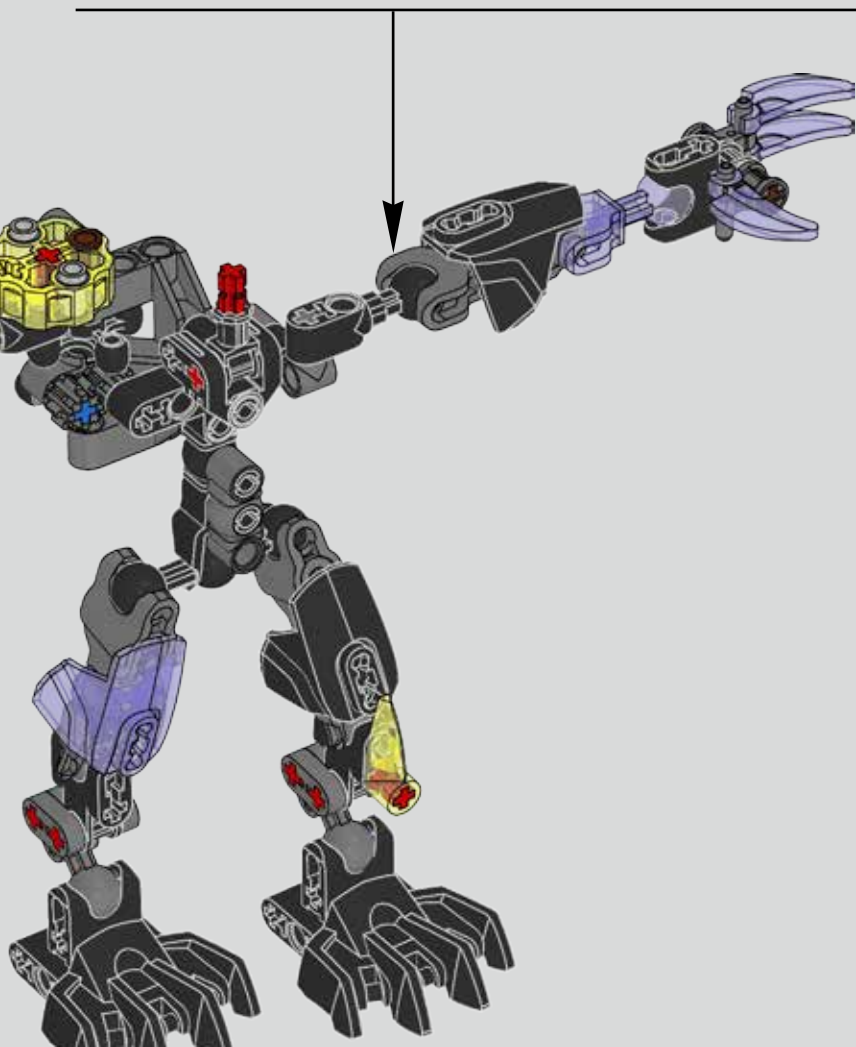
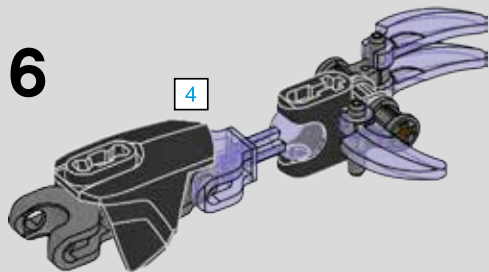

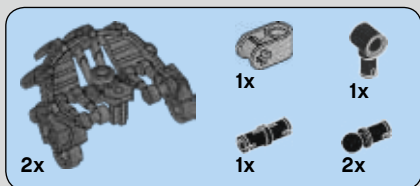

17

1

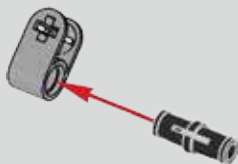

2

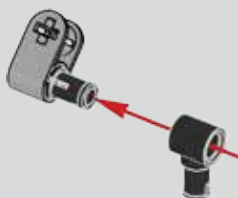

3

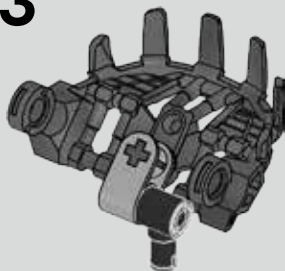

4

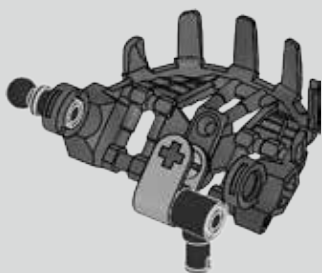

5

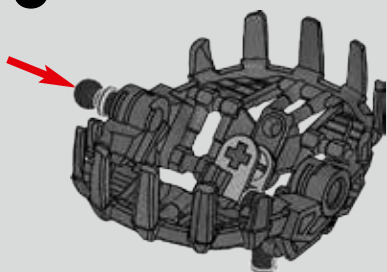

6

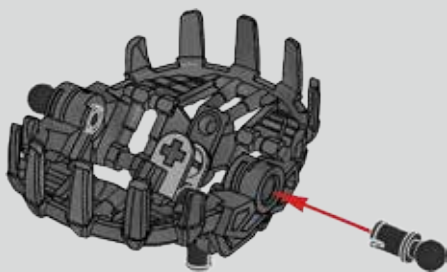

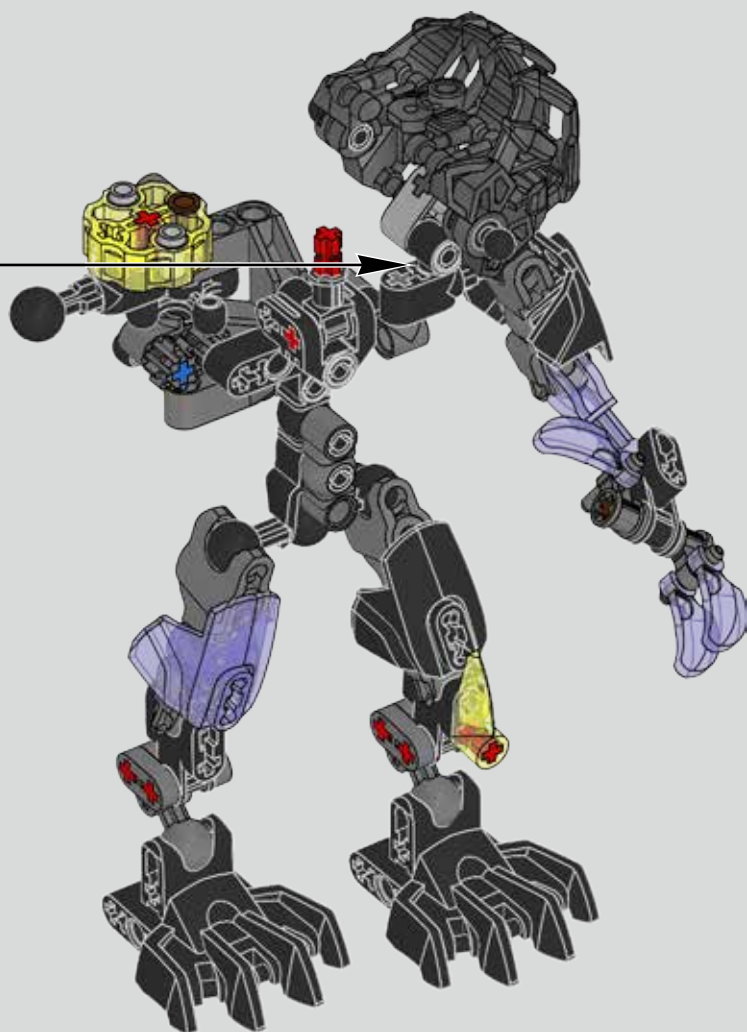

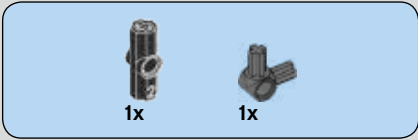
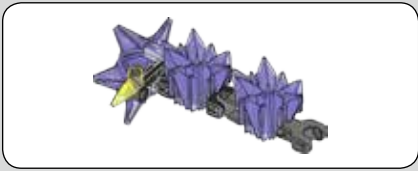

18

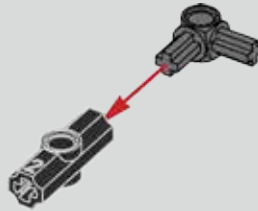

19

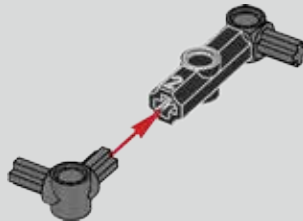



20

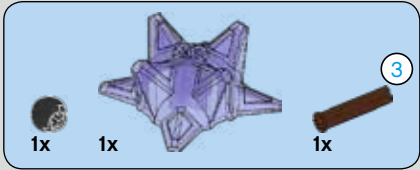
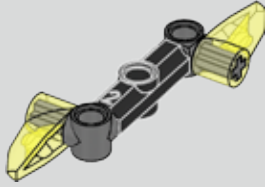

21

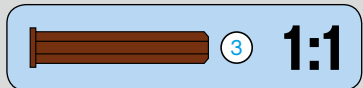
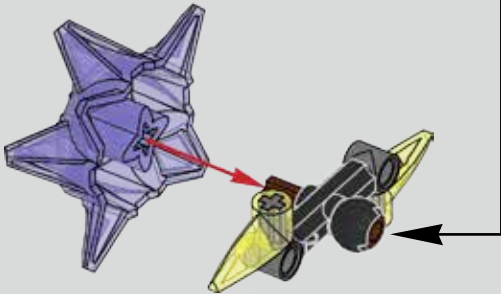
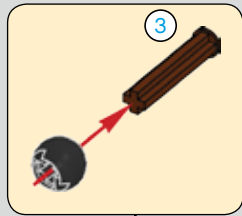

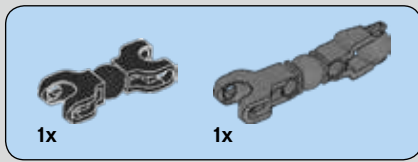

22

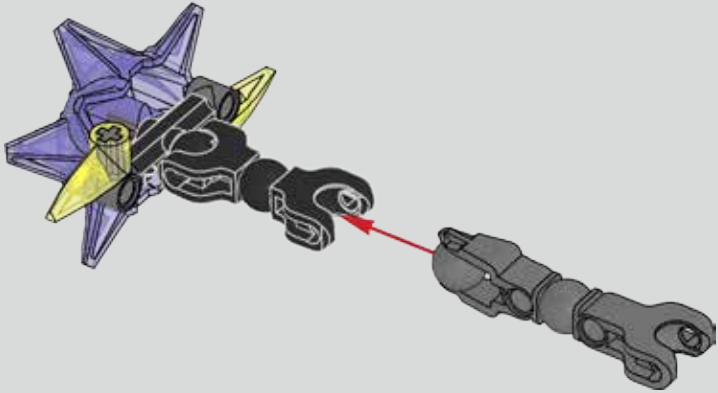

23

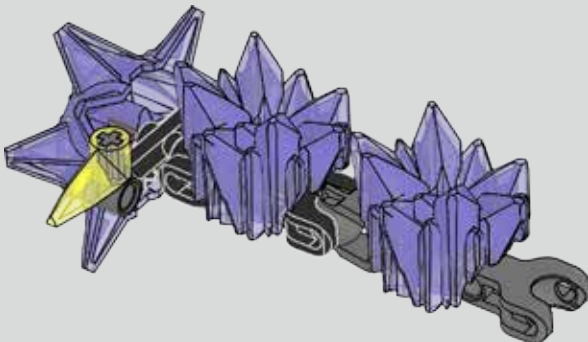

24

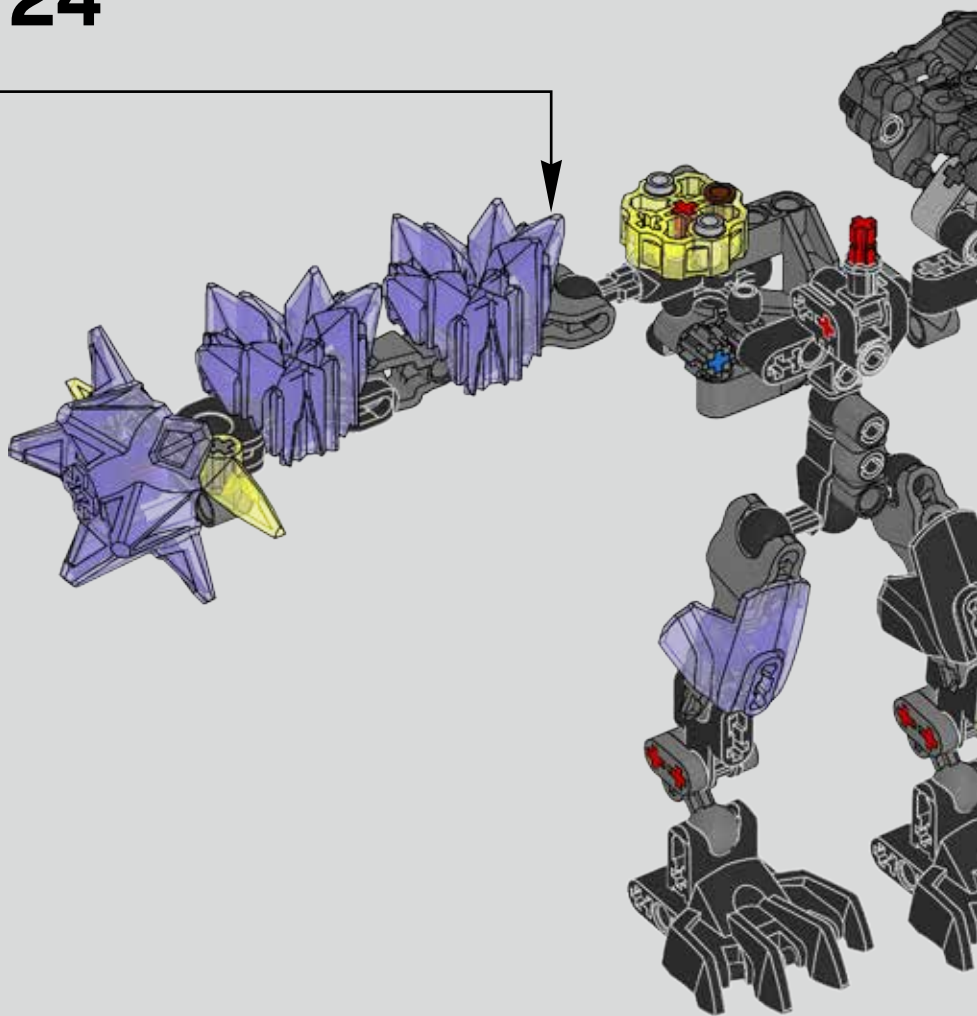

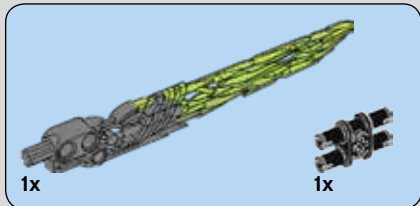

25

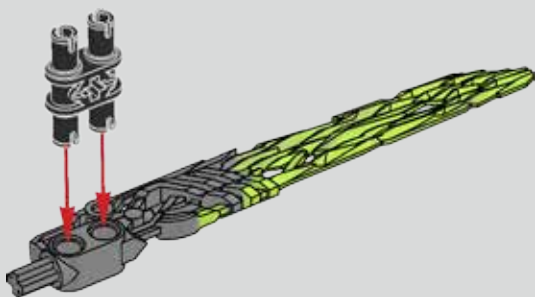

26

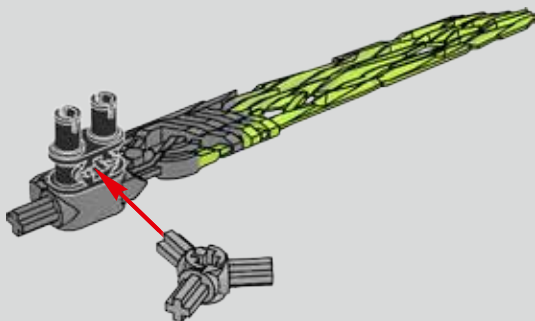



27

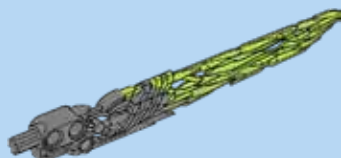
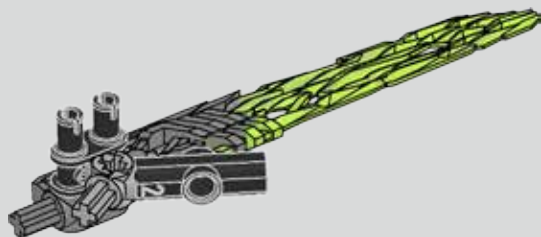

28

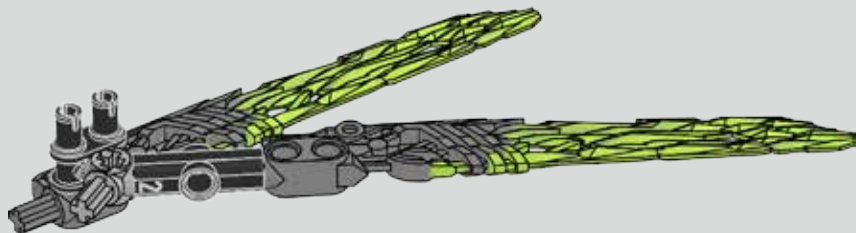



1x

29

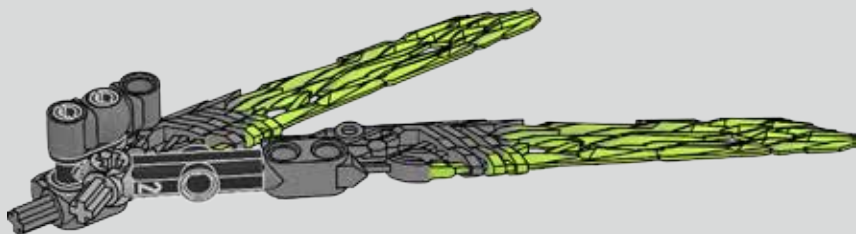

1x

30

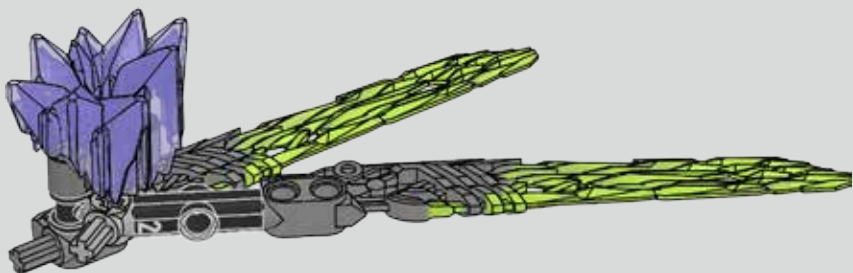

31

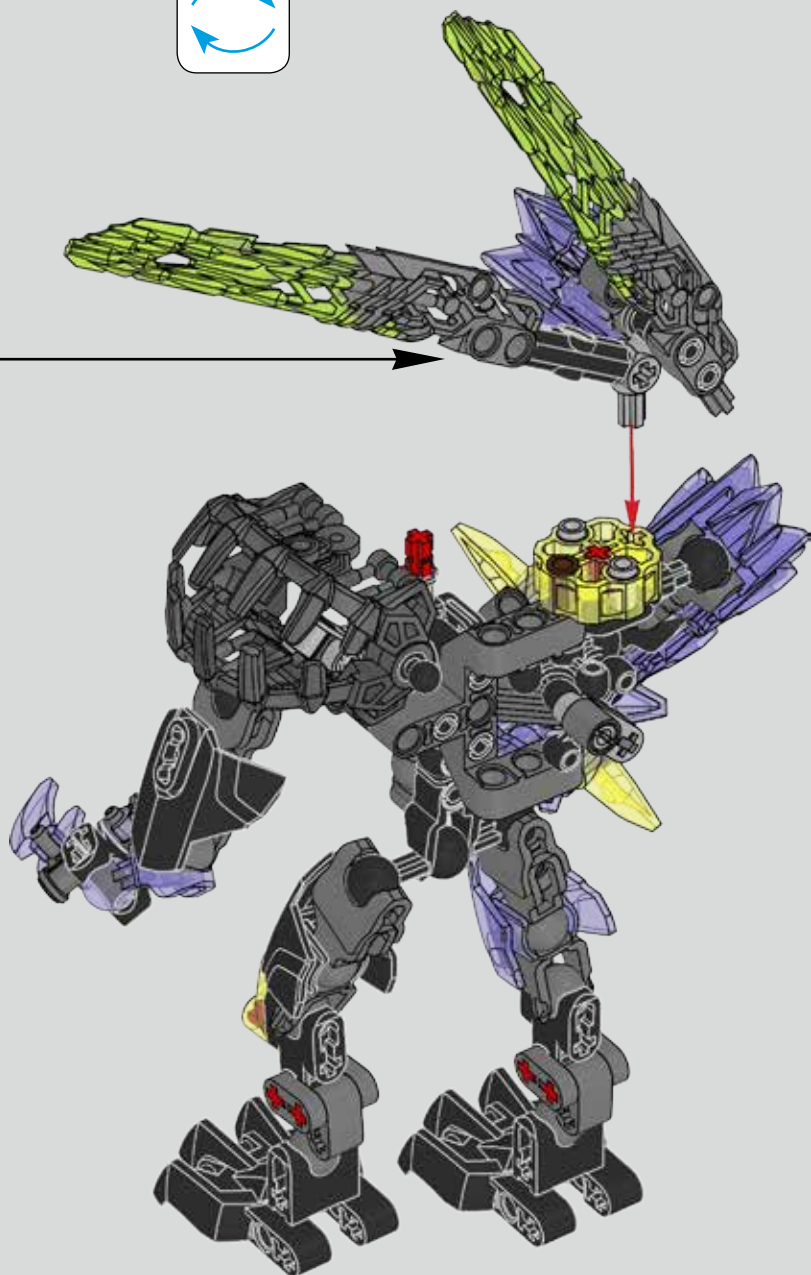
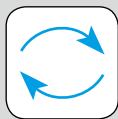

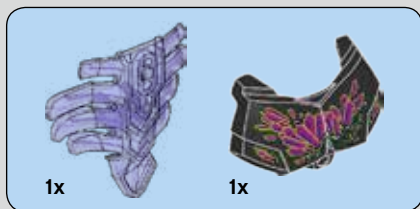

32

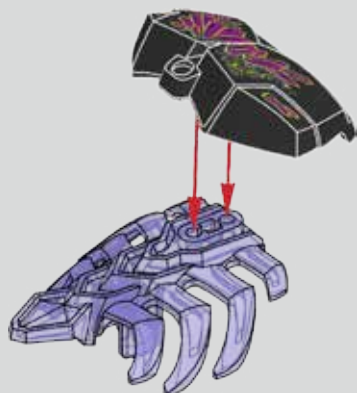

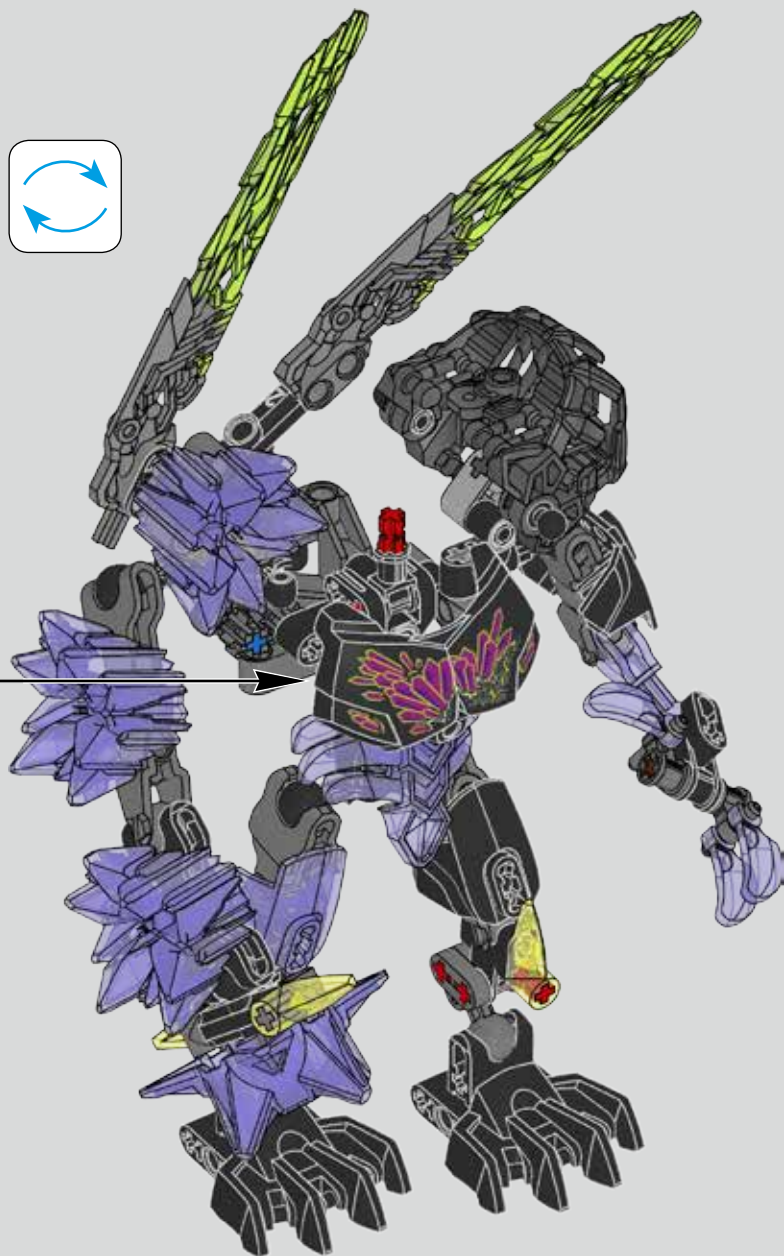
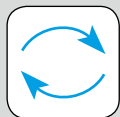

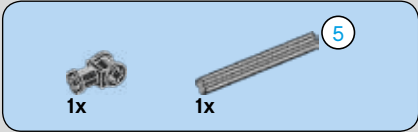

33

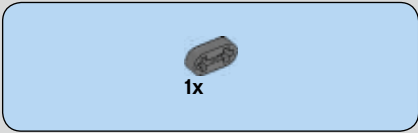
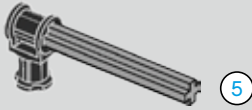

34

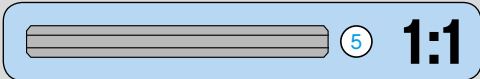
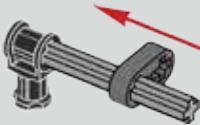

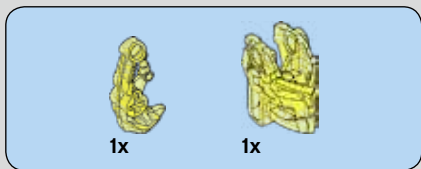

35

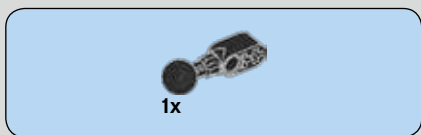
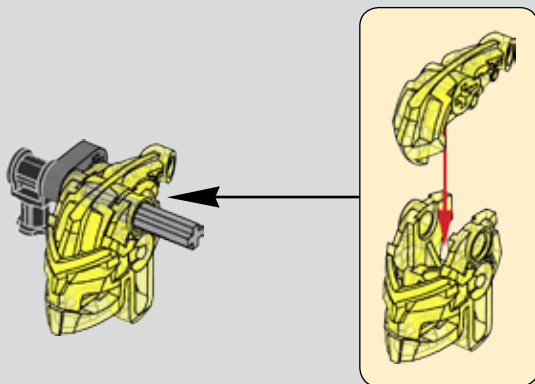

36

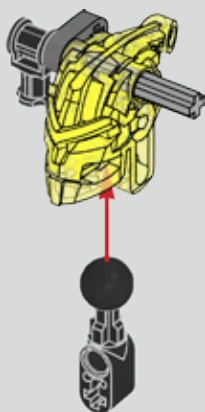



1x

37

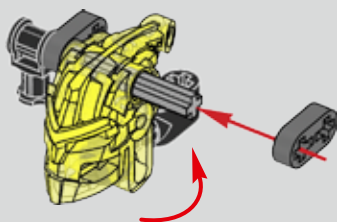

1x

38

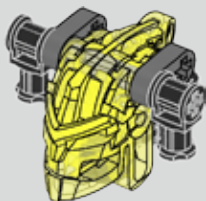



2x

39

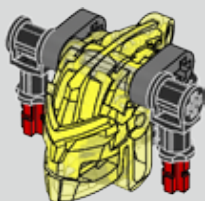

1x

40

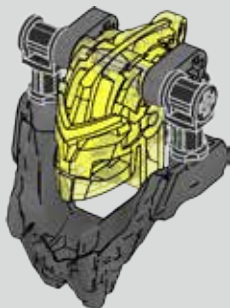

41

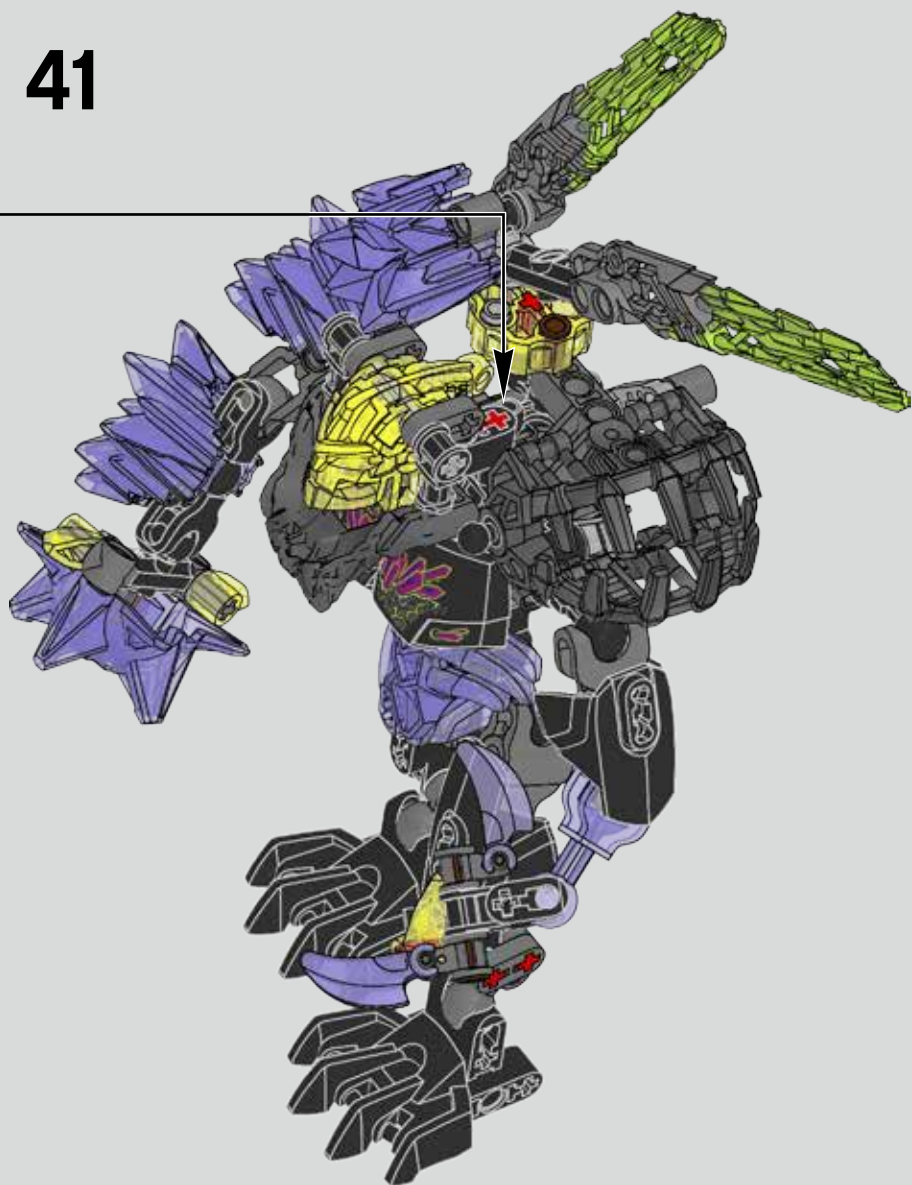

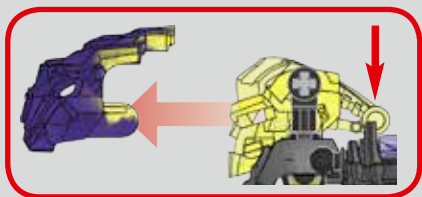
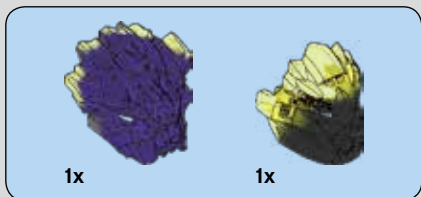

42

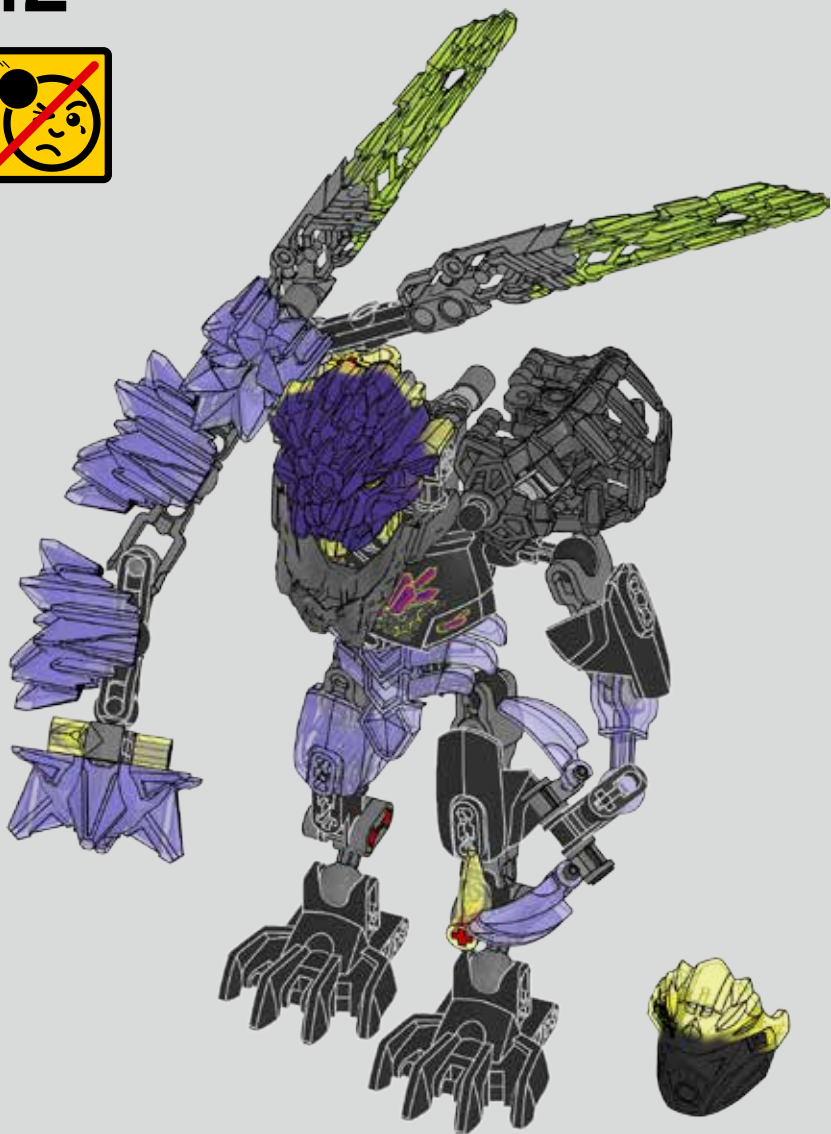



3x
4163577



1x
4651747



1x
6145450



1x
6102639



2x
6135124



1x
6150531



1x
4211639



1x
4211775



1x
4502595



2x
4211483



1x
4563045



2x
6056379



7x
4121715



2x
4107783



1x
6135323



2x
4184169



1x
4119589



1x
6073231



2x
6044720



3x
4610948



2x
4248204



1x
4286267



1x
4610371



1x
4593567



3x
4560108



2x
6106472



1x
6102645



3x
4622903



6x
4210980



1x
6100030



1x
6083620



2x
6020189



2x
6001085



2x
6012451



3x
6005331



2x
4289258



1x
6121358



1x
6139221



1x
6102835



1x
6114323



3x
6133713



1x
6106242



3x
6150584

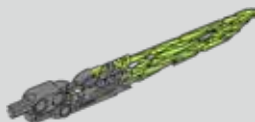

2x
6150660



3x
6135494



1x
6151175



3x
4107081

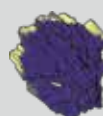

1x
6151227



1x
6158054



10x
4142865



1x
4206482

4

3

4

4

5

Customer Service
Kundenservice
Service Consommateurs
Servicio Al Consumidor

LEGO.com/service or dial



: 00800 5346 5555

: 1-800-422-5346



BIONICLE







71313

+



=



71315



 LEGO.com/BIONICLE

71313 + 71314 + 71315 + 71316

Download App
Télécharger l'application
Descarga la App



Apple and the Apple logo are trademarks of Apple Inc., registered in the U.S. and other countries.

App Store is a service mark of Apple Inc.

Google Play is a trademark of Google Inc.



71314



71316

