

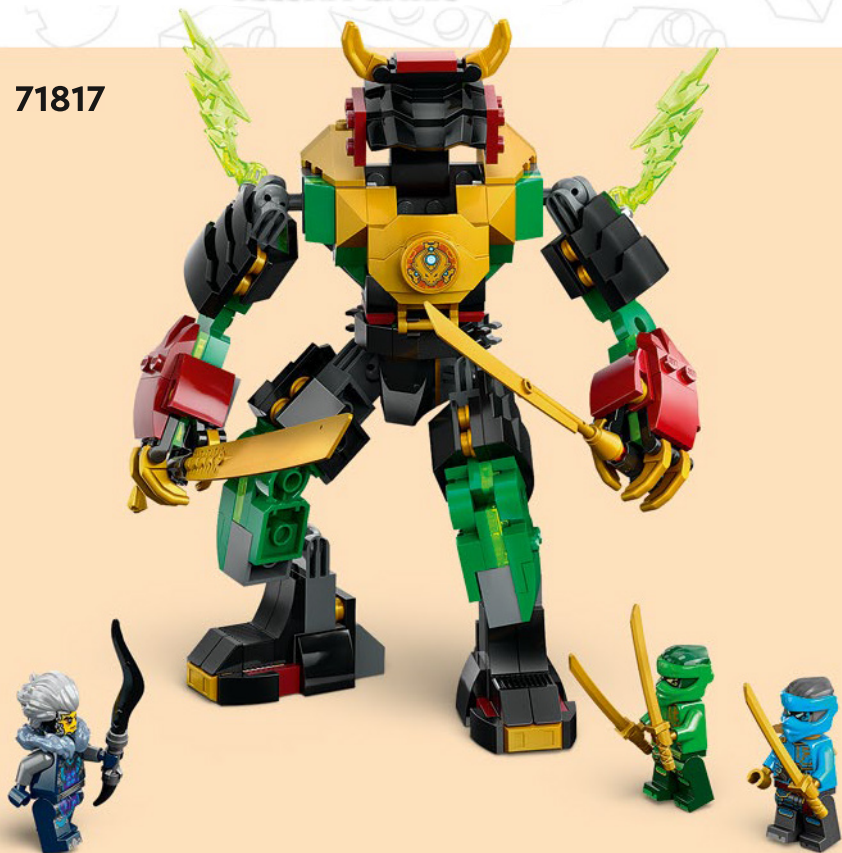

# NINJAGO

DRAGONS RISING

71817



Q LEGO® Builder



### **Get excited about our new packaging!**

We're switching from plastic to paper-based packaging. That's why you might find a mix of paper and plastic in our boxes!

### **Nos nouveaux emballages vous emballeront !**

Nous passons des emballages en plastique aux emballages à base de papier. C'est pourquoi vous pourriez trouver un mélange de papier et de plastique dans nos boîtes !

### **¡Te presentamos nuestros nuevos empaques!**

Estamos sustituyendo las bolsas de plástico por bolsas con base de papel. ¡Por eso, puedes encontrar una mezcla de papel y de plástico en nuestras cajas!

**[LEGO.com/sustainable-packaging](https://www.lego.com/sustainable-packaging)**

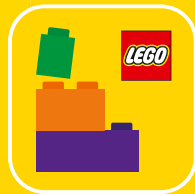

LEGO® Builder

# BUILDER



Apple and the Apple logo are trademarks of Apple Inc., registered in the U.S. and other countries and regions. App Store is a service mark of Apple Inc. Google Play and the Google Play logo are trademarks of Google LLC. Tencent and the Tencent logo are trademarks of Tencent Inc.

LEGO.com/devicecheck

**EN** Ask parents' permission before going online | **DE** Eltern um Erlaubnis bitten, bevor du online gehst | **FR** Demande l'autorisation d'un parent avant d'aller en ligne | **IT** Chiedi il permesso ai tuoi genitori prima di andare online | **ES** Pídeles permiso a tus papás antes de conectarte a Internet | **PT** Peça autorização aos pais antes de acederes online | **ZH** 上网前应先征得父母的同意 | **PL** Poproś rodziców o zgodę, zanim wejdiesz do Internetu | **CS** Než půjdeš na internet, požádej rodiče o svolení | **SK** Skôr než pôjdeš na internet, vypýtaj si povolenie od rodičov | **HU** Kérj szülői engedélyt, mielőtt online csatlakoznál! | **RO** Cere permisiunea părinților înainte de a te conecta online | **BG** Попискайте разрешение от родител, преди да влезете онлайн | **LV** Pirms došanās tiešsaistē palūdz atļauju vecākiem | **ET** Enne Interneti kasutamist küsi vanematelt luba | **LT** Prieš prisijungdami prie interneto, atsiklauskite tėvų



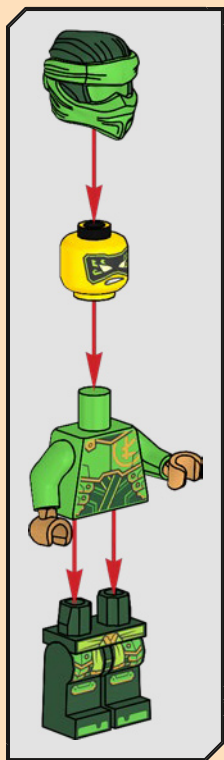

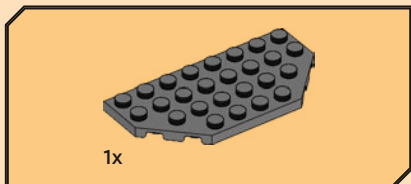
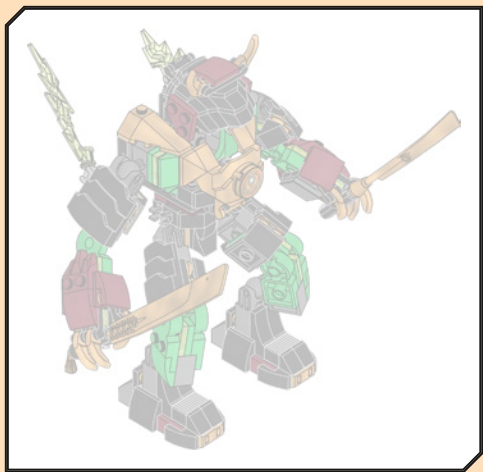

1

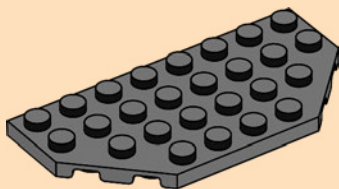

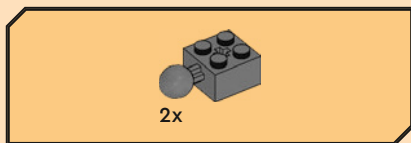

2

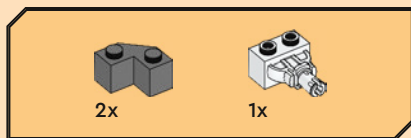
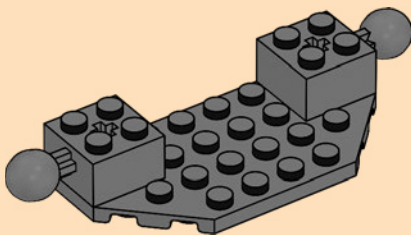

3

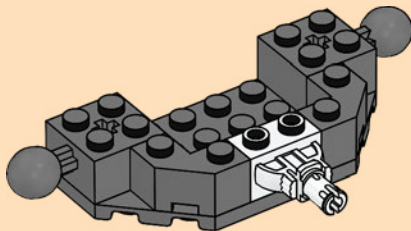



2x



2x

4

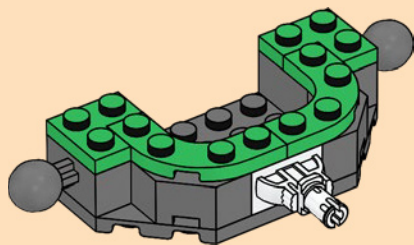



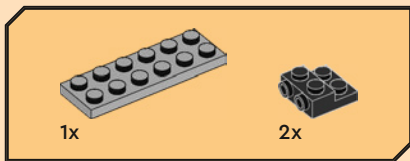

5

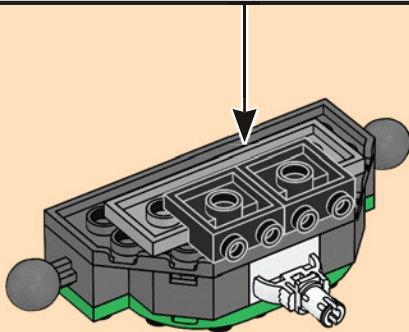
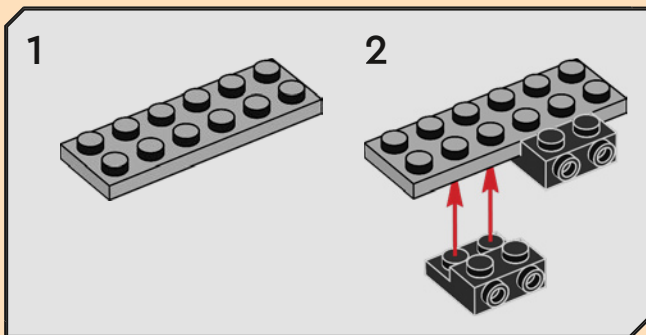



2x

6

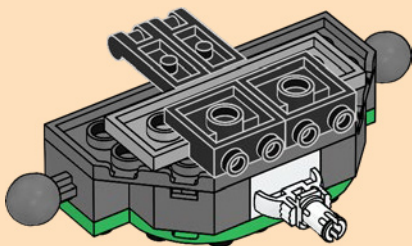

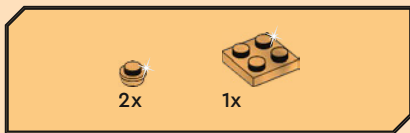

7

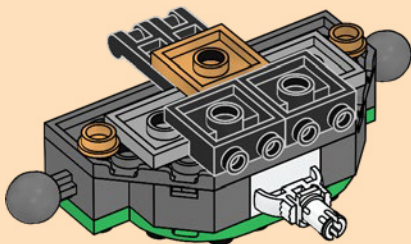

8

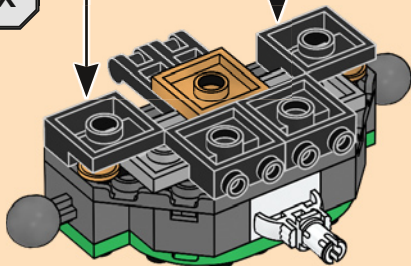



1x

9

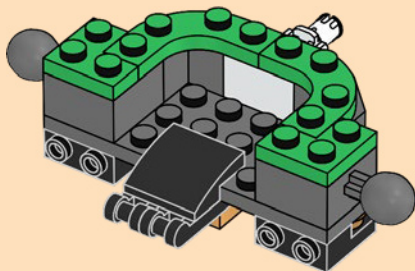

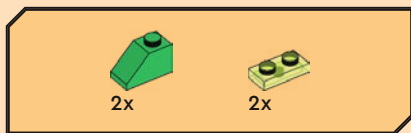

10

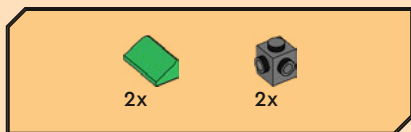
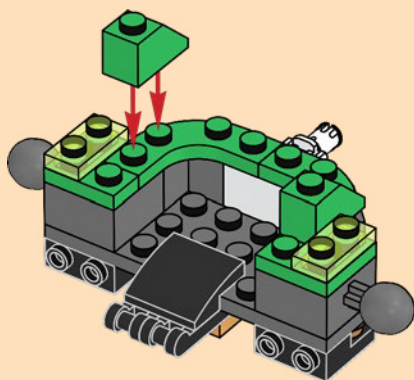

11

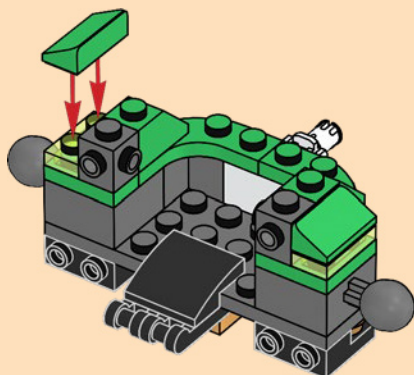



2x

12

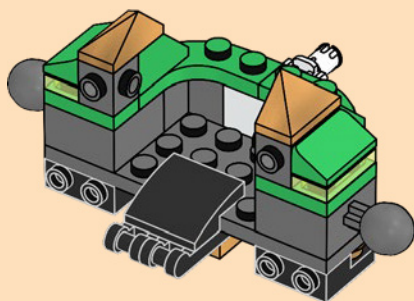

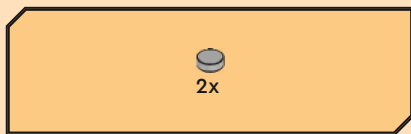

13

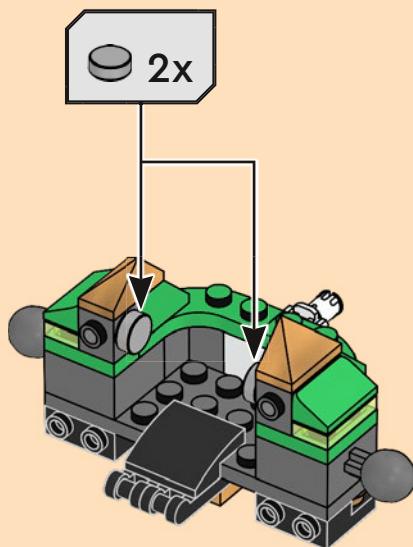

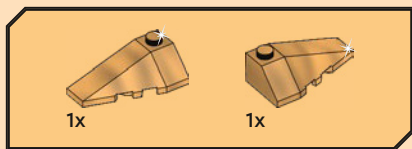

14

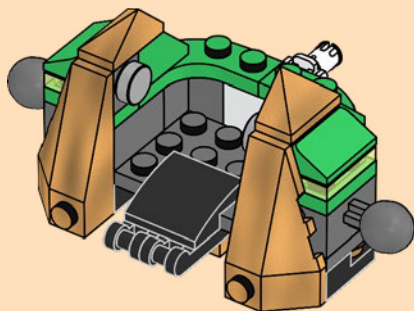





2x

15

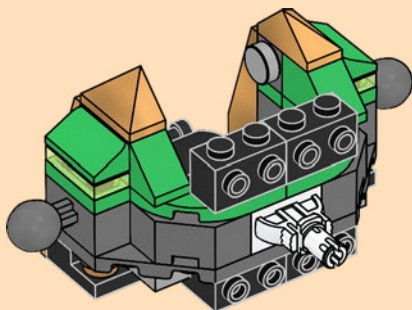



16

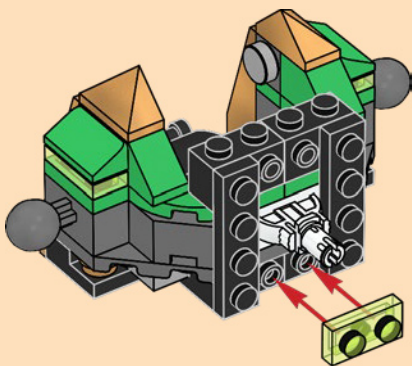



17

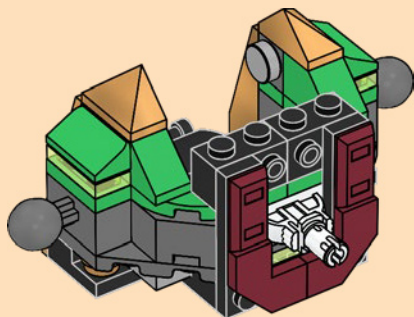



2x

18

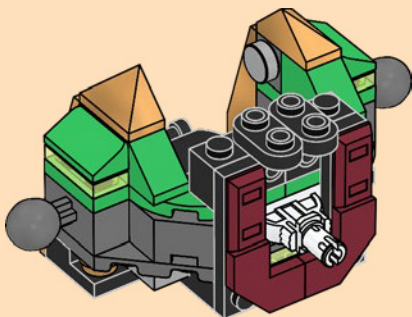



19

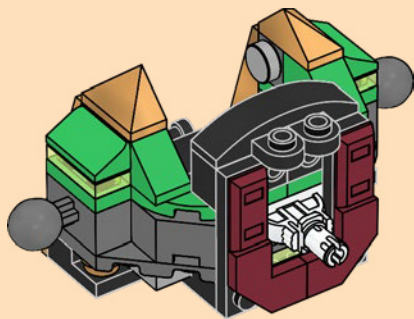



20

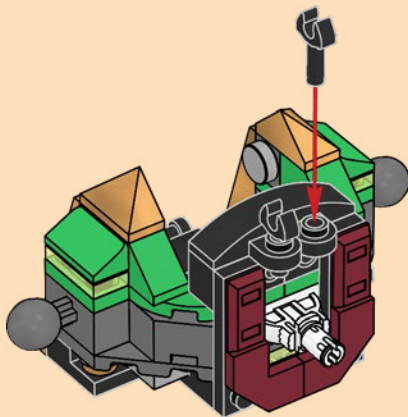



21

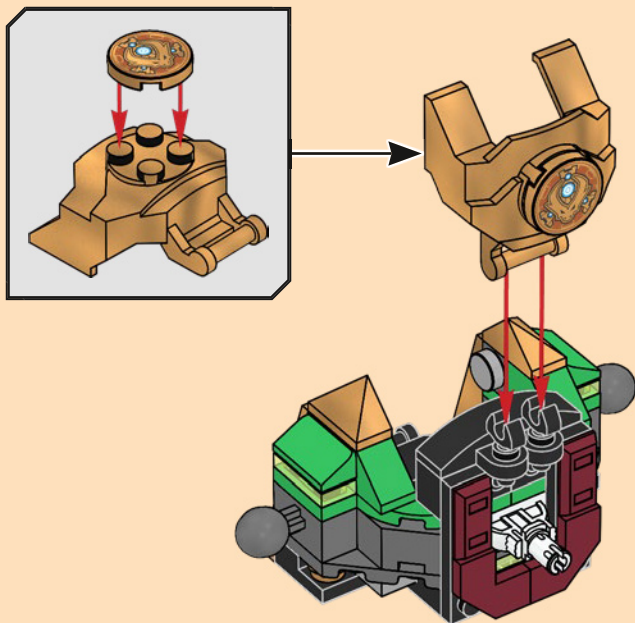

22

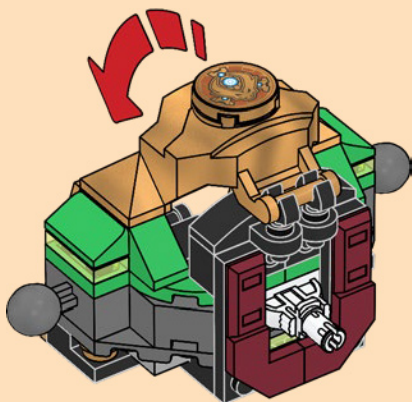





23

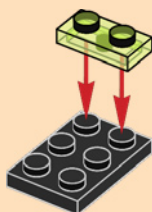

24

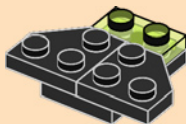

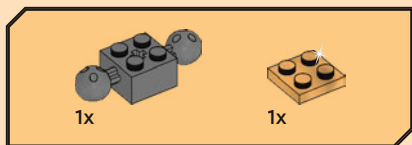

25

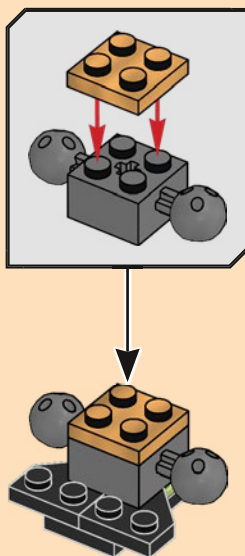





1x

28

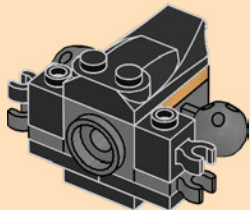

2x

29

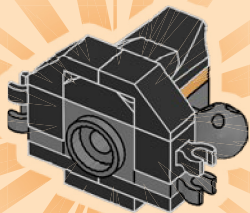

30

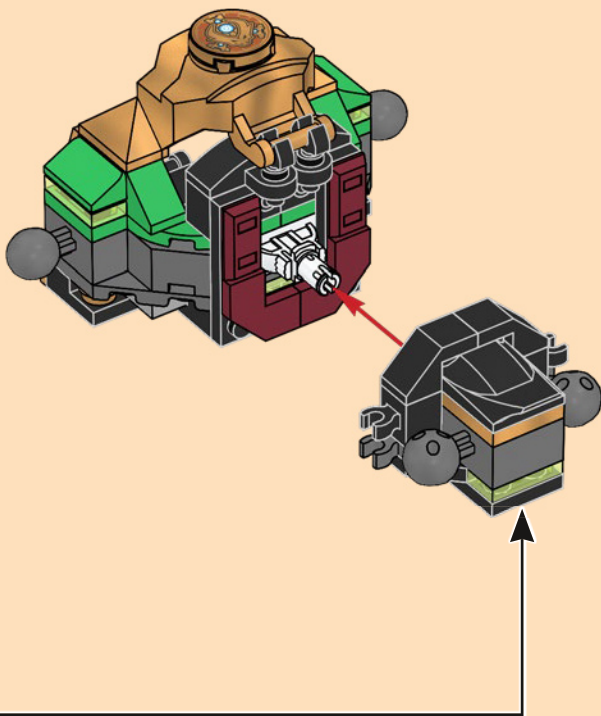



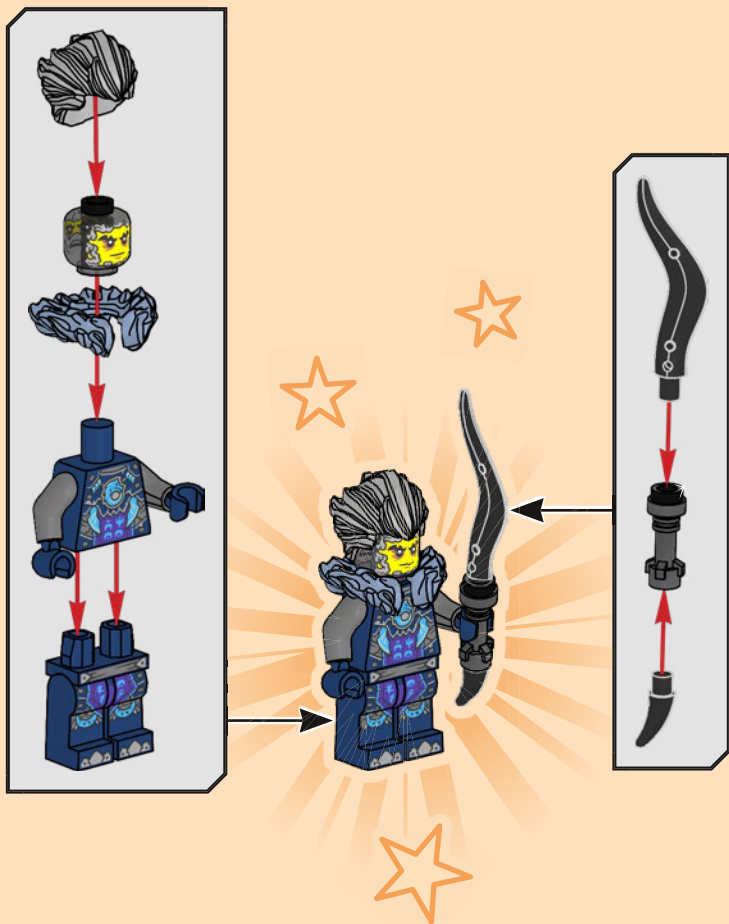

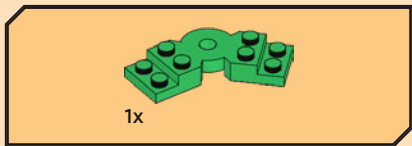
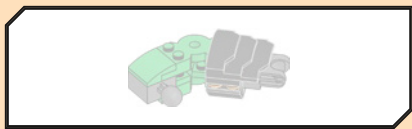

31

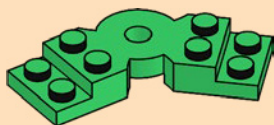

32

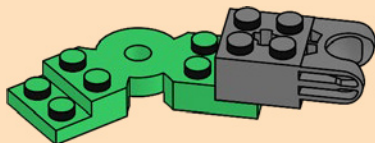



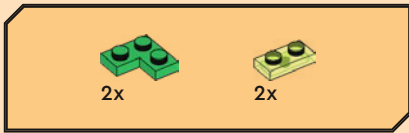

33

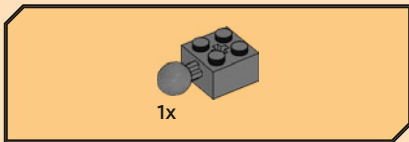
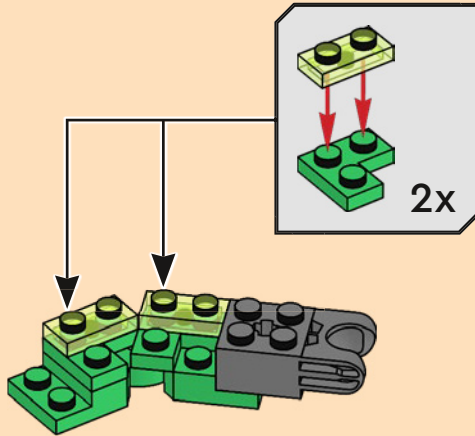

34

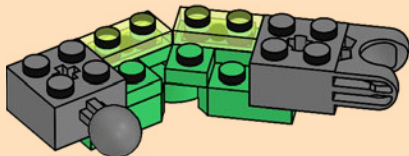

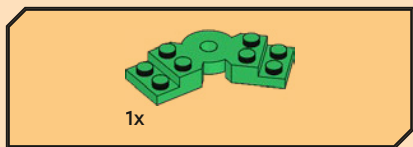

35

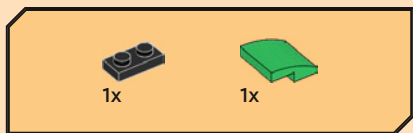
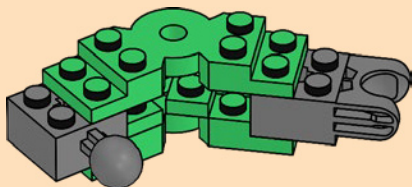

36

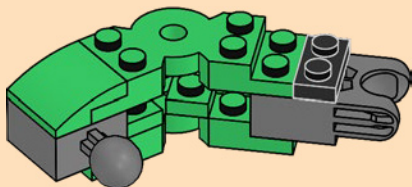

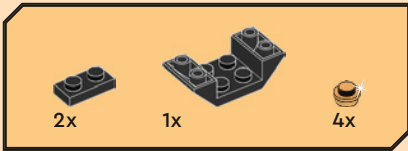

37

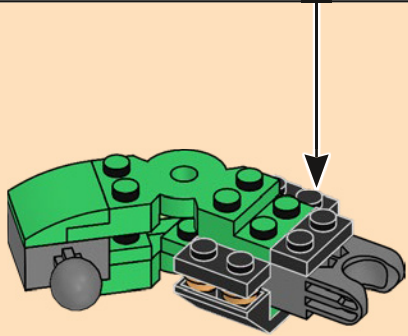
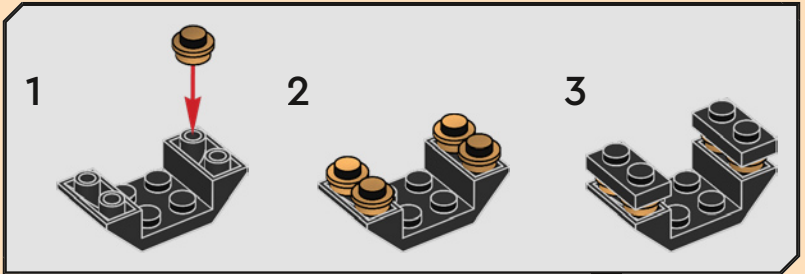

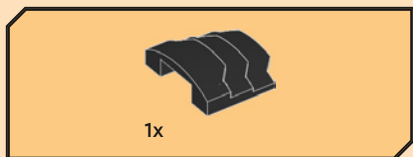

38

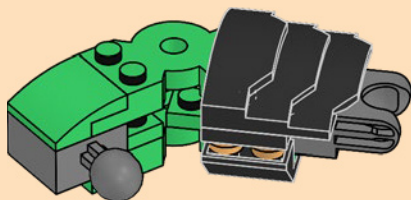

39

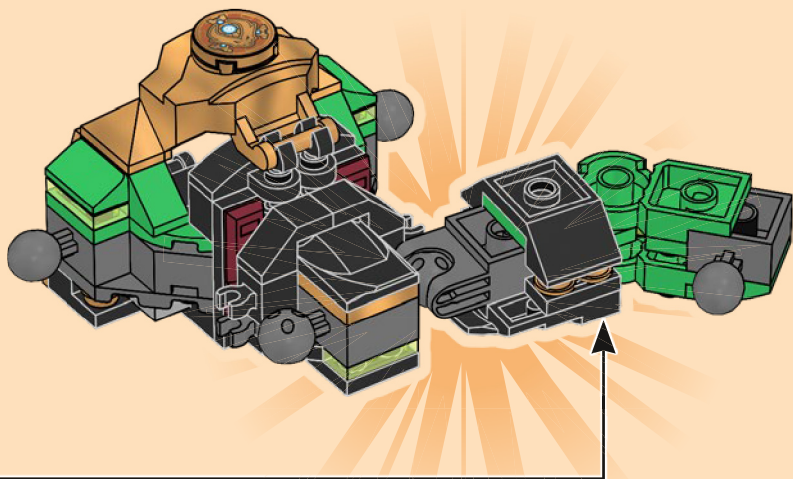

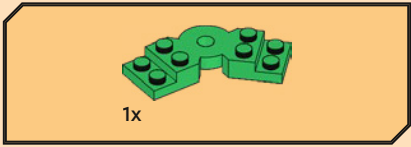
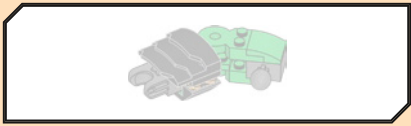

40

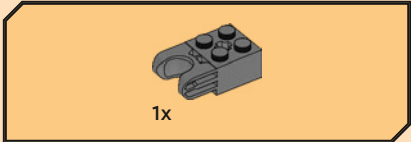

41

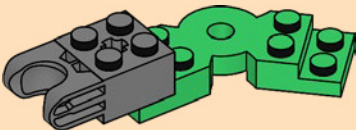

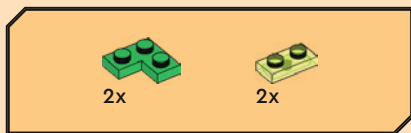

42

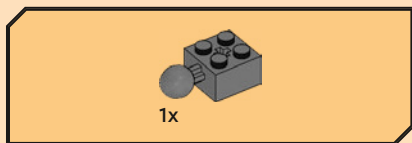
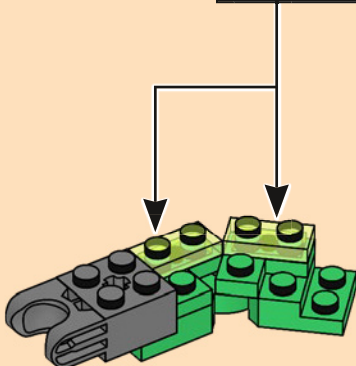
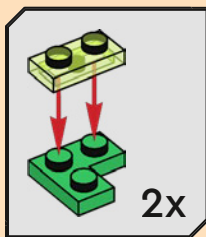

43

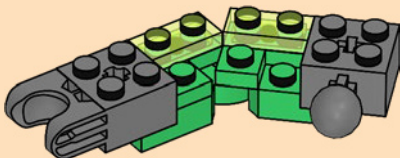

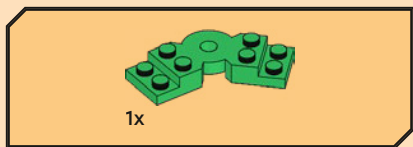

44

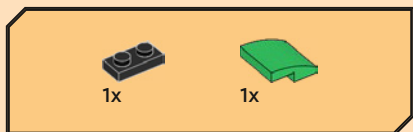
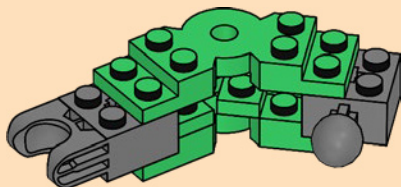

45

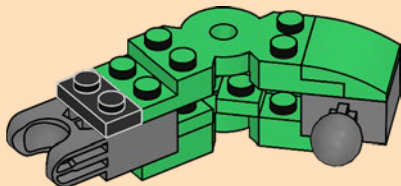



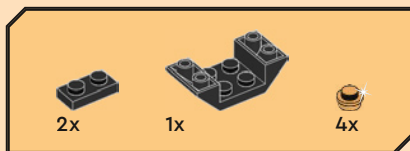

# 46

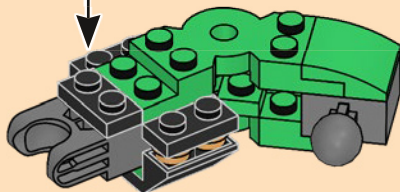
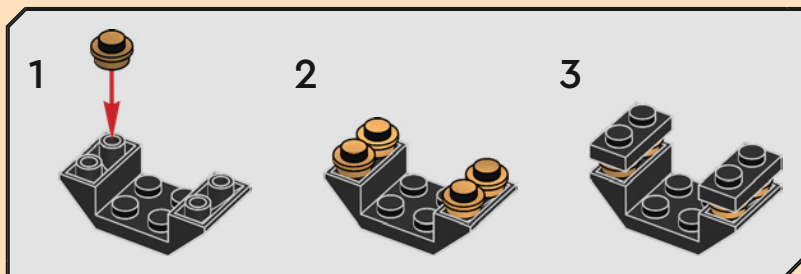

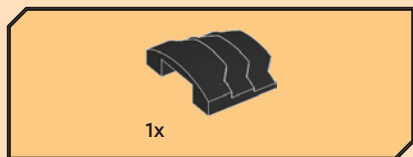

47

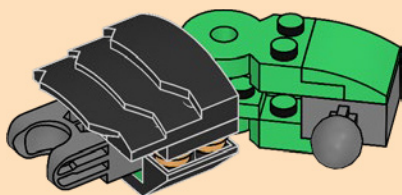

48

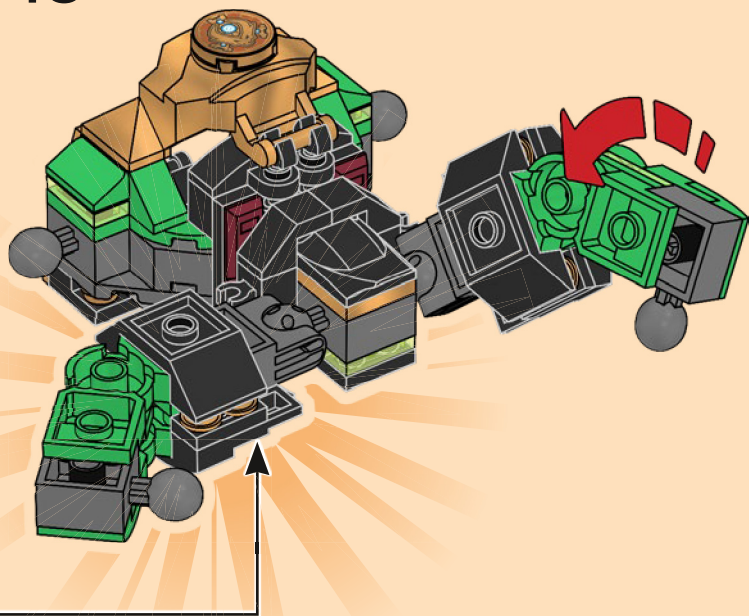



2x



1x



2x

49

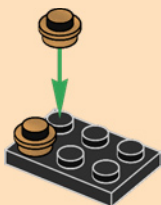

2x

50

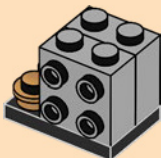



1x

# 51

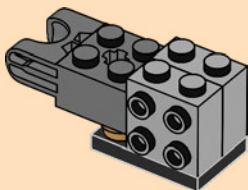

2x

# 52

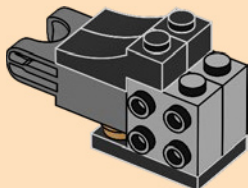



53

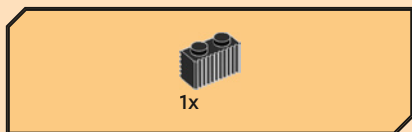
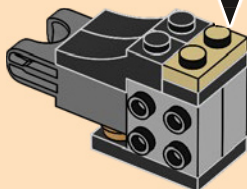
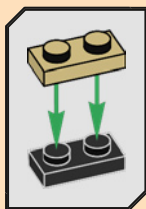

54

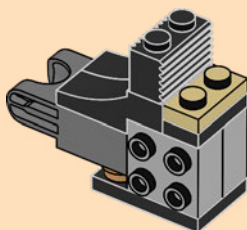



2x

# 55

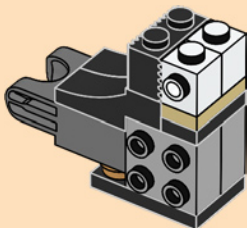

2x

# 56

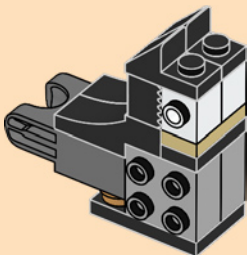

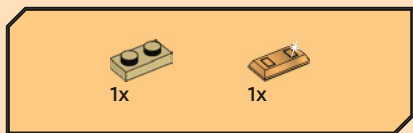

57

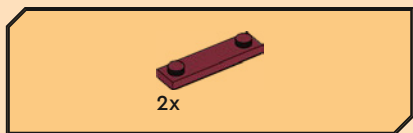
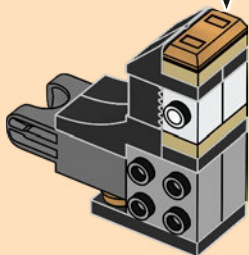
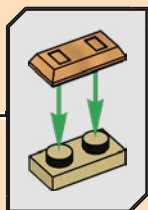

58

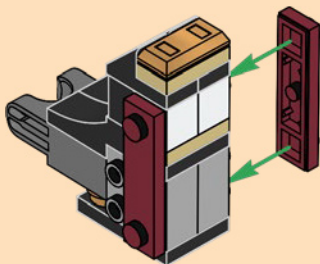





59

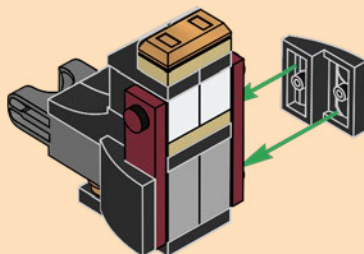

60

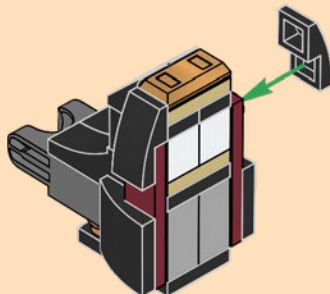



1x

61

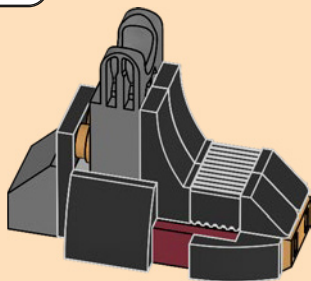

2x

62

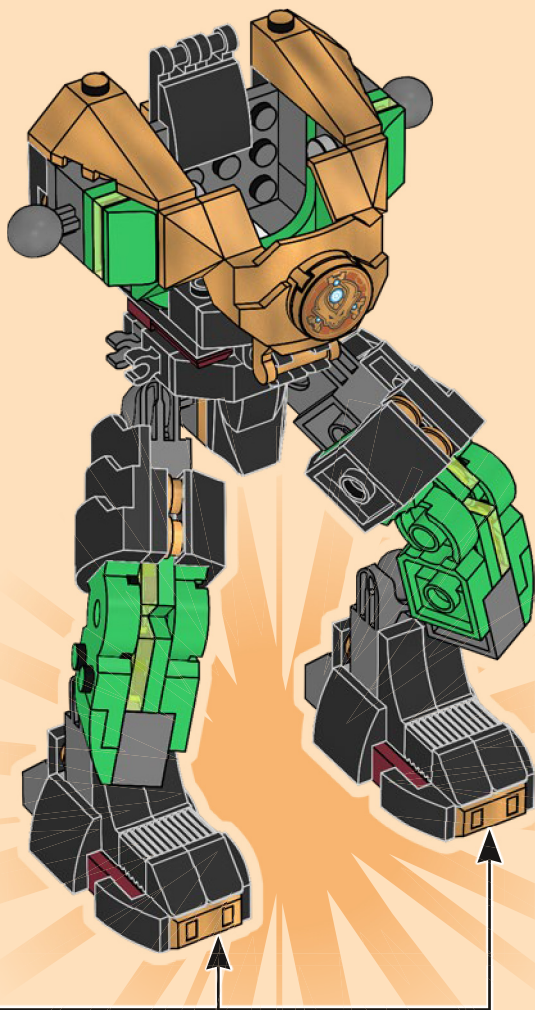



2x

63

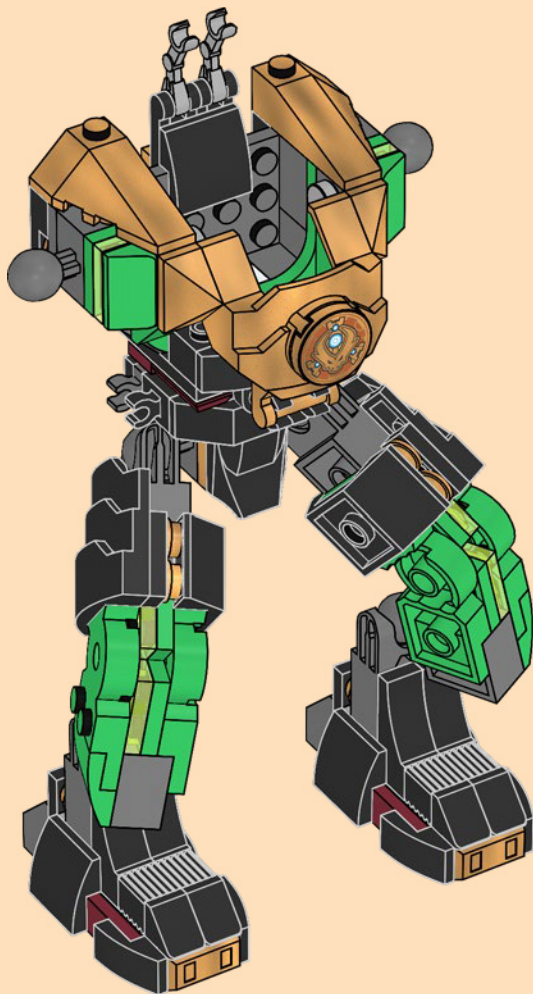

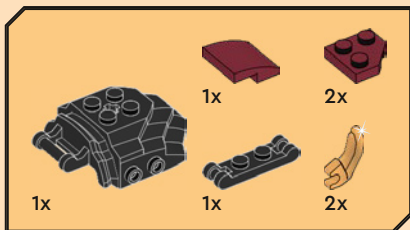

64

1

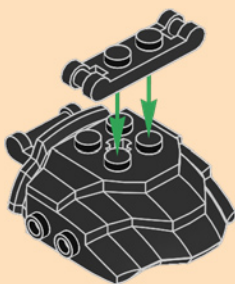

2

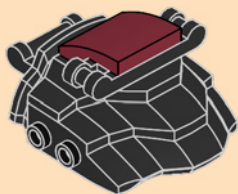

3

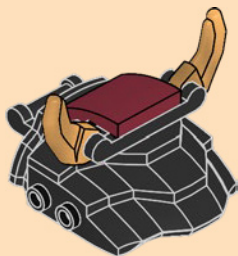

4

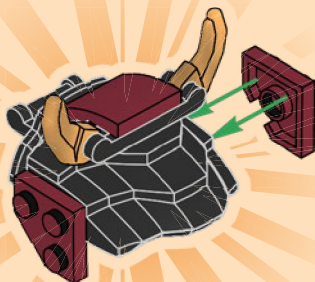

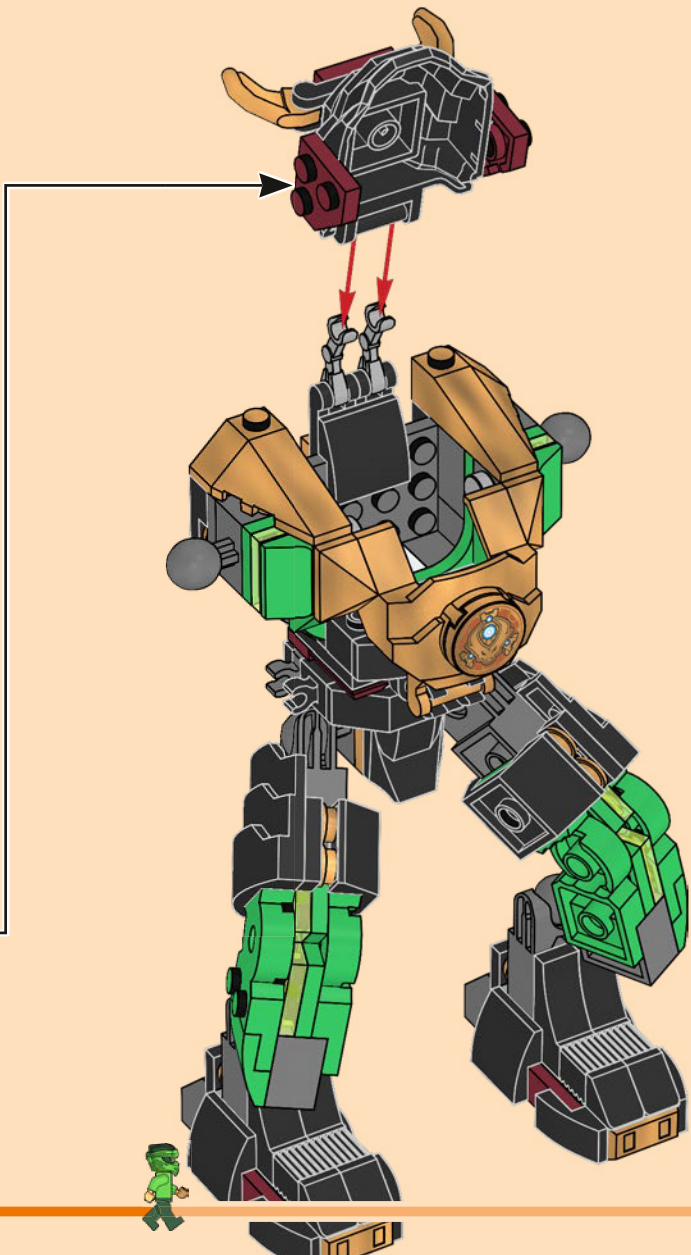





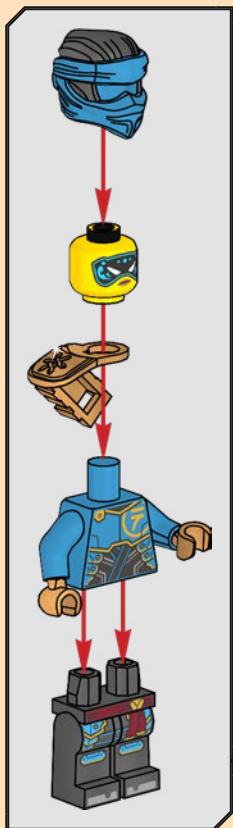

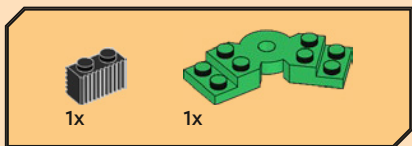
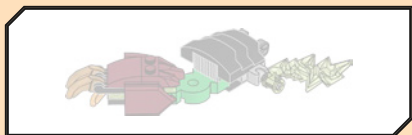

65

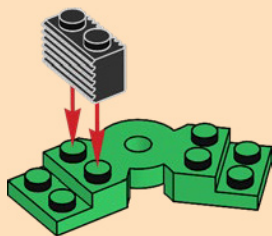

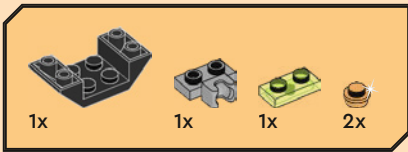

66

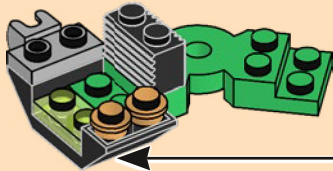
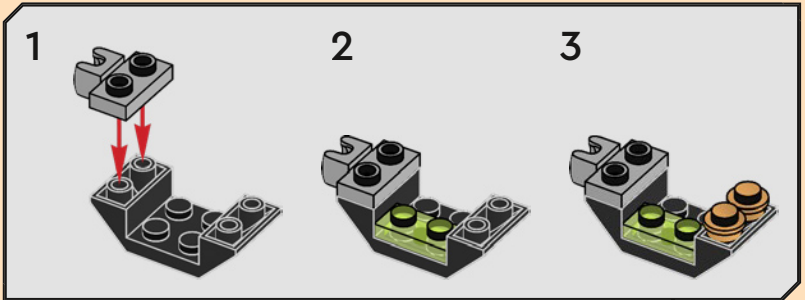

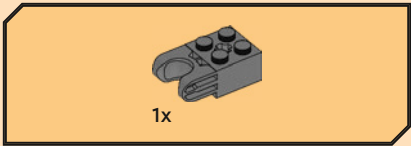

67

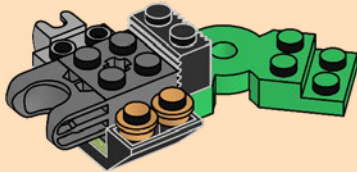

68

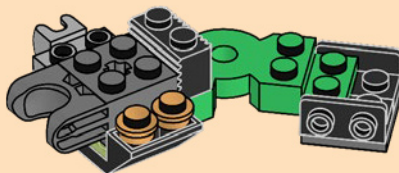
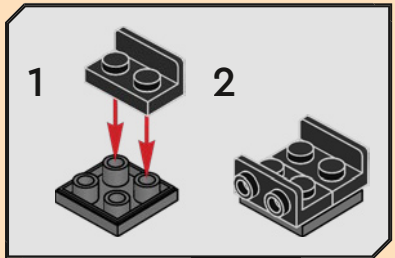

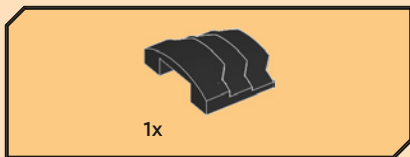

69

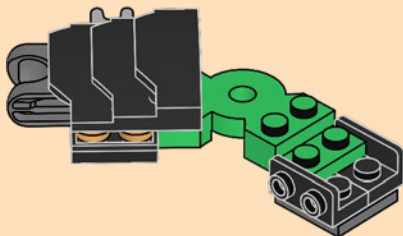

70

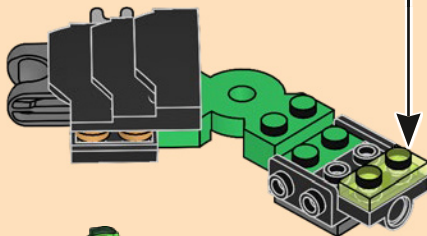
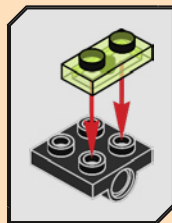

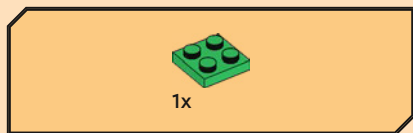

71

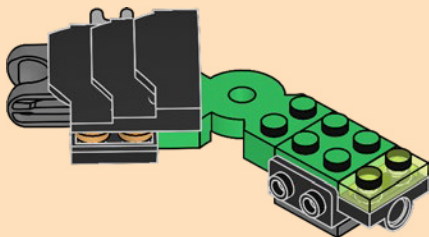

72

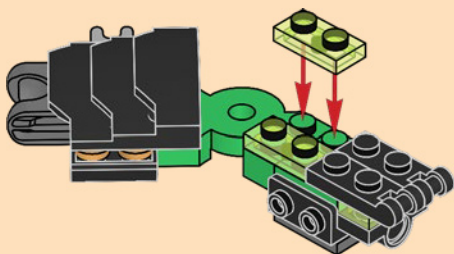



73

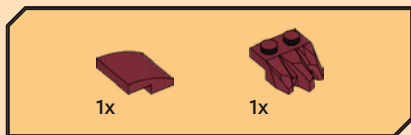
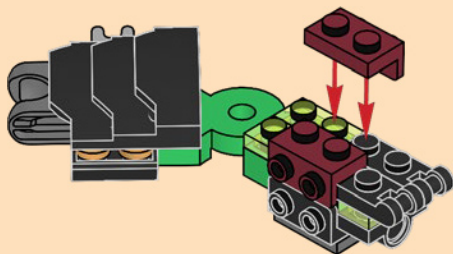

74

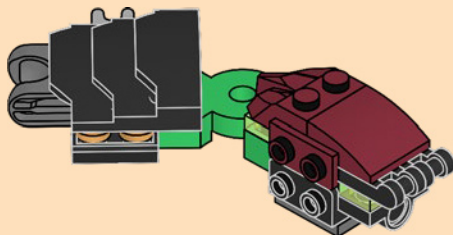

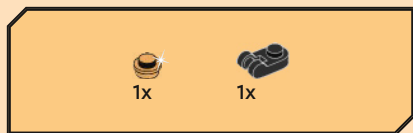

75

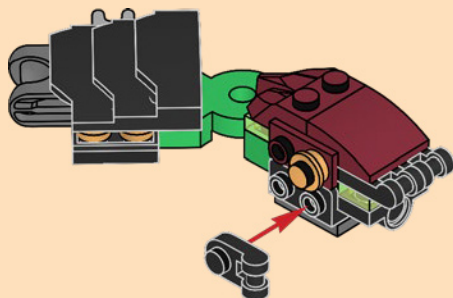

76

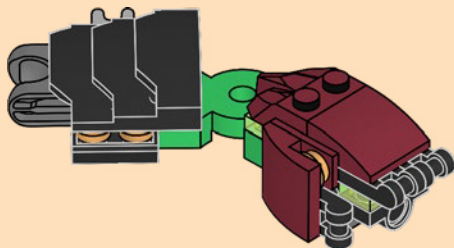





77

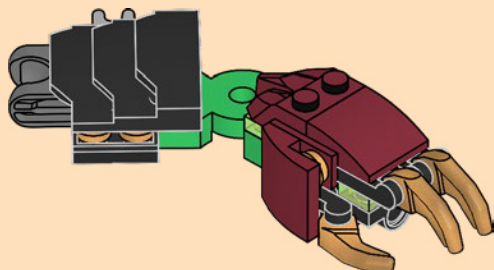

78

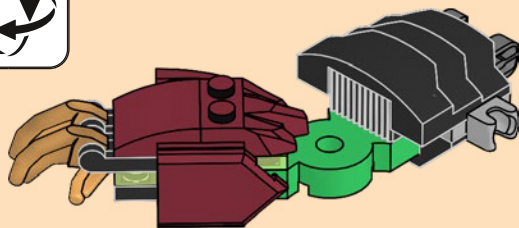

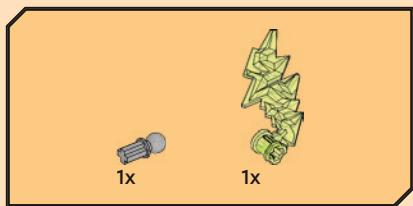

79

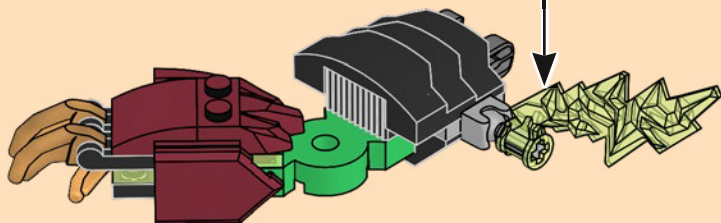

80

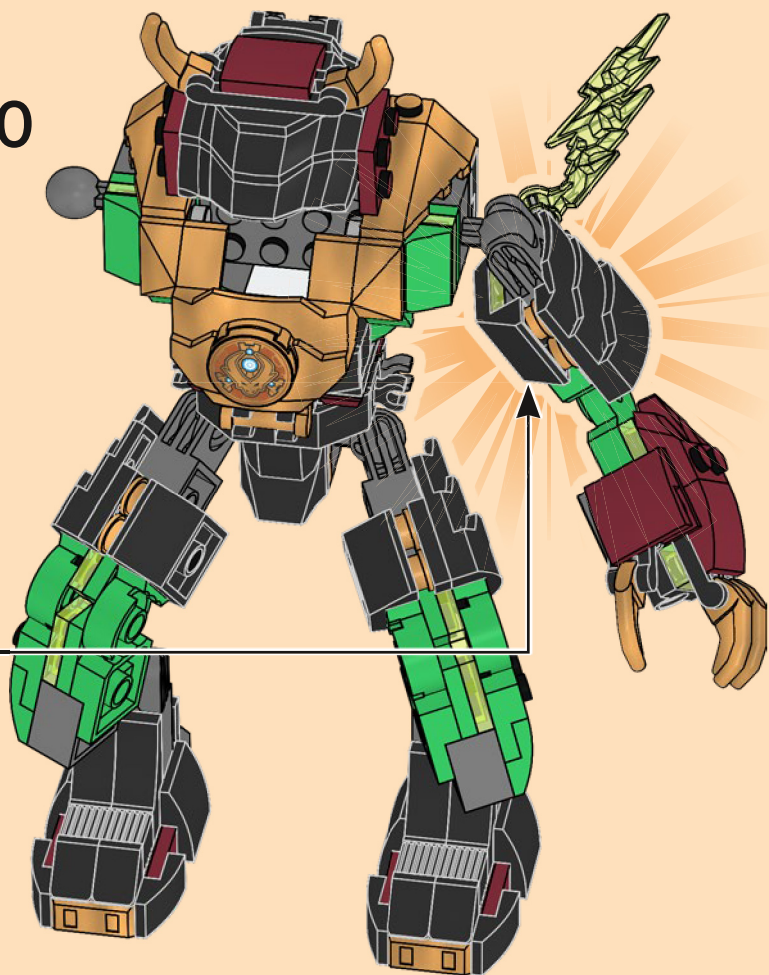

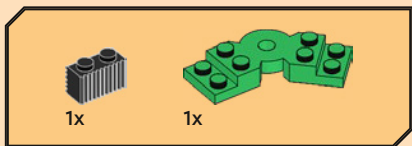
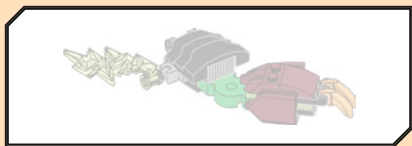

81

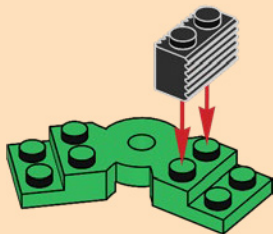

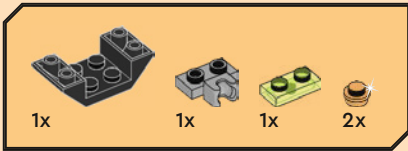

82

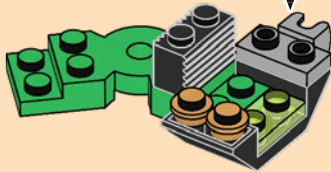
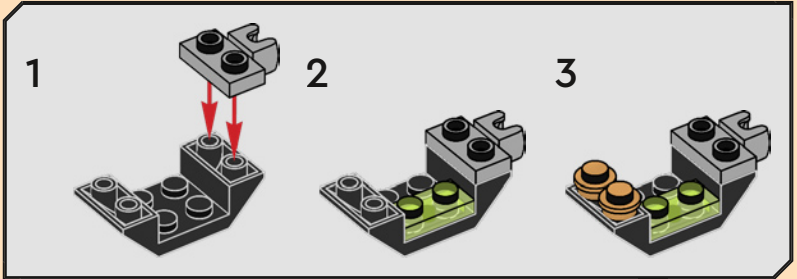

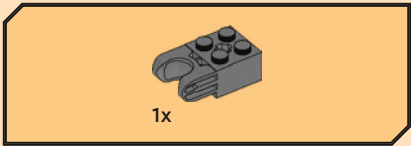

83

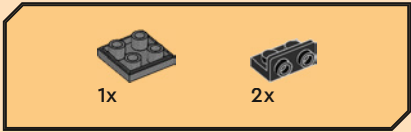
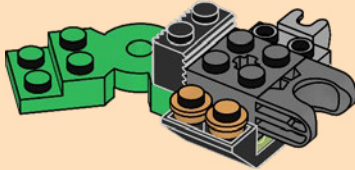

84

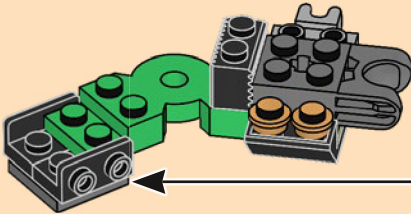
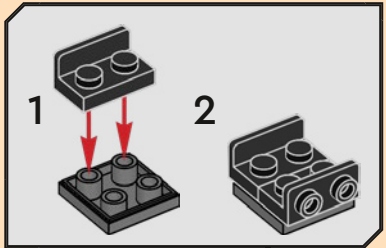

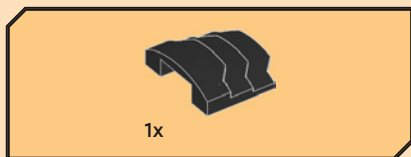

85

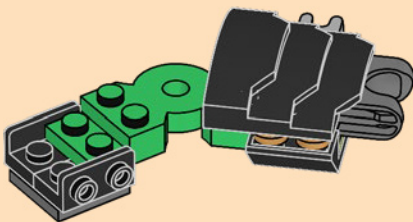

86

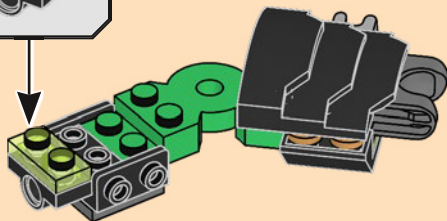
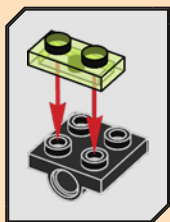

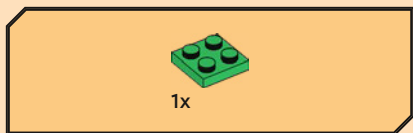

87

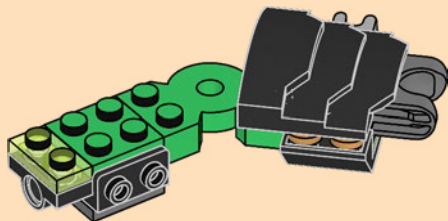

88

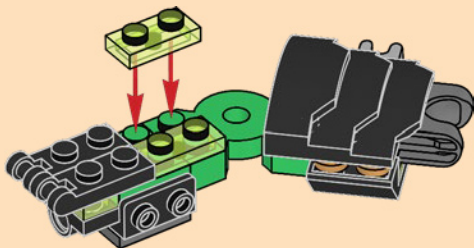







91

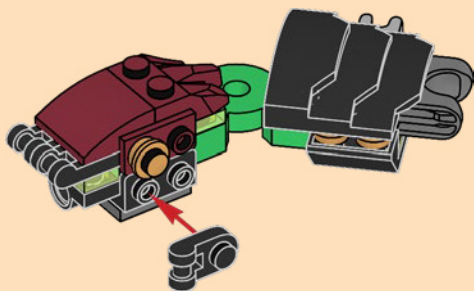

92

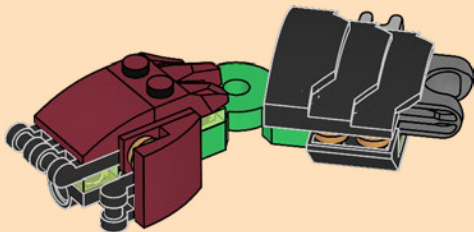



93

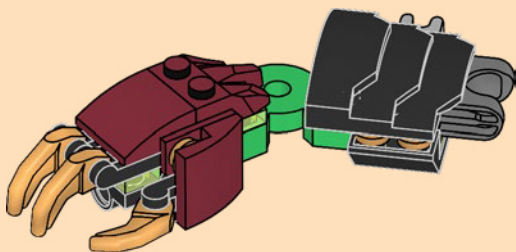

94

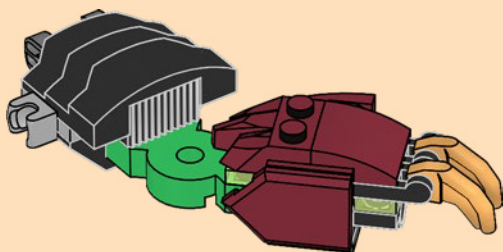

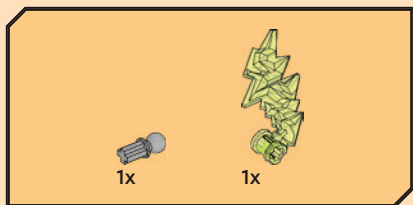

95

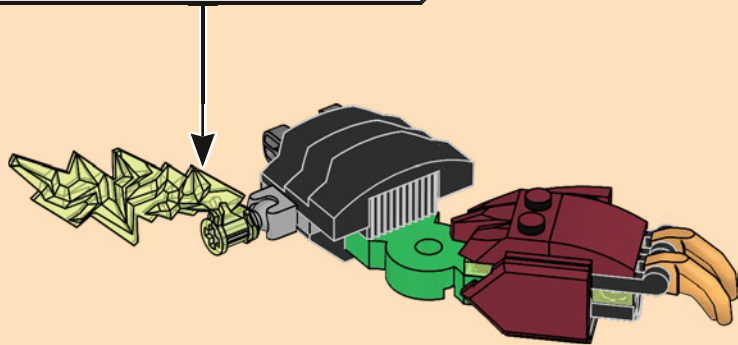
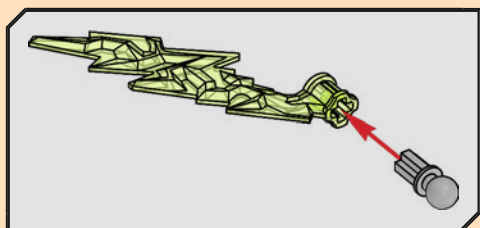

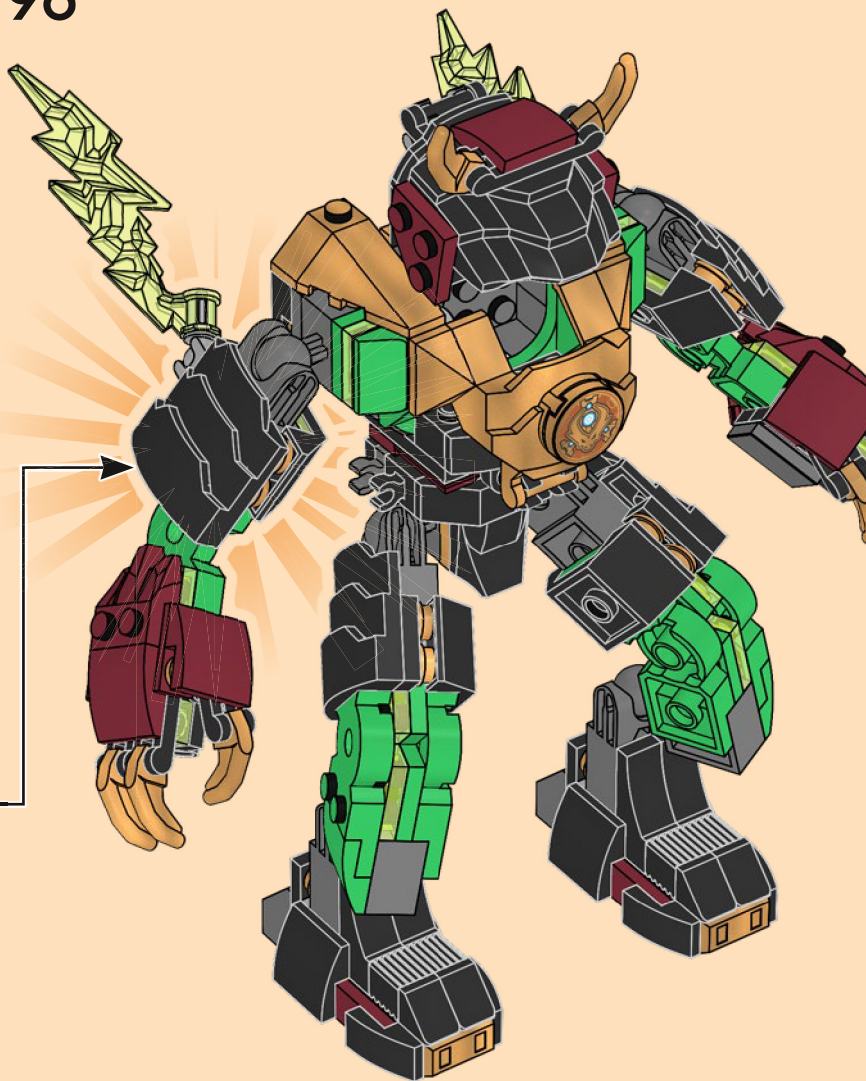

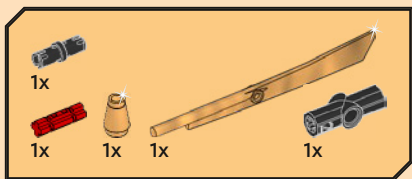

97

1

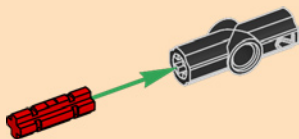

2

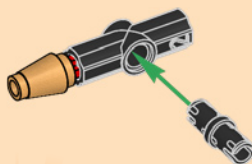

3



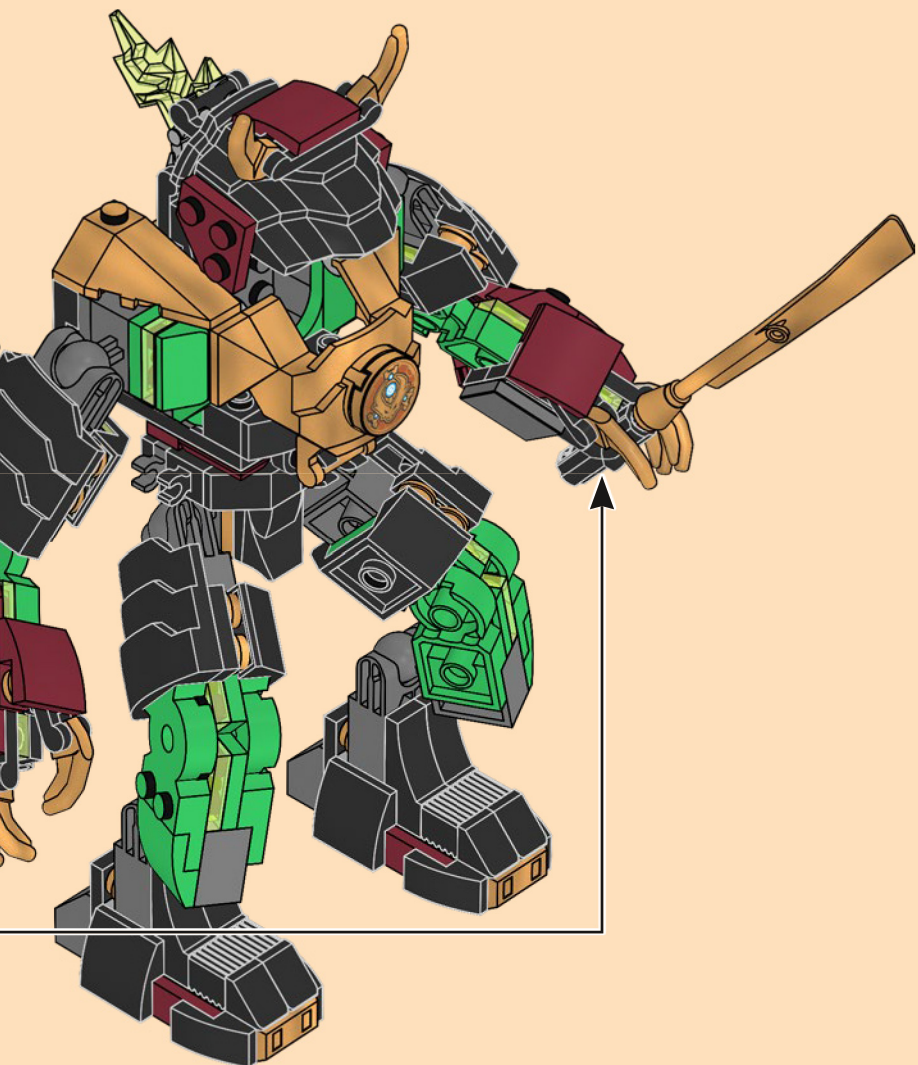





2

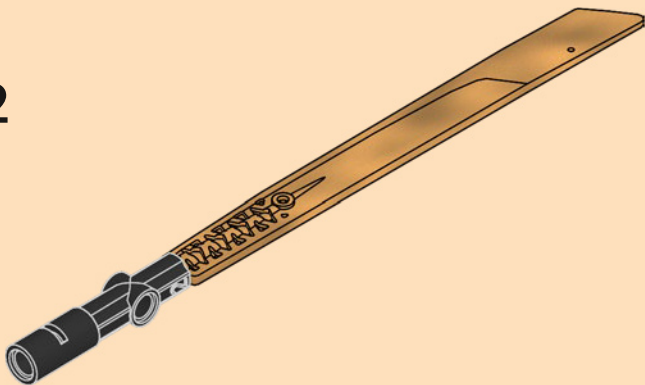

3

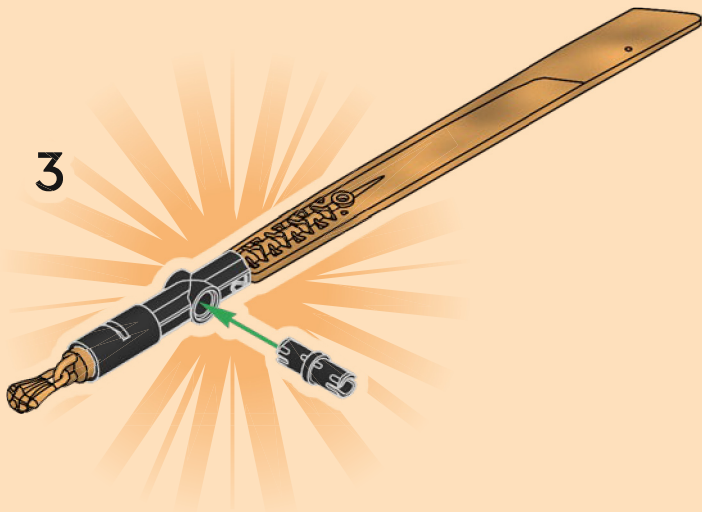

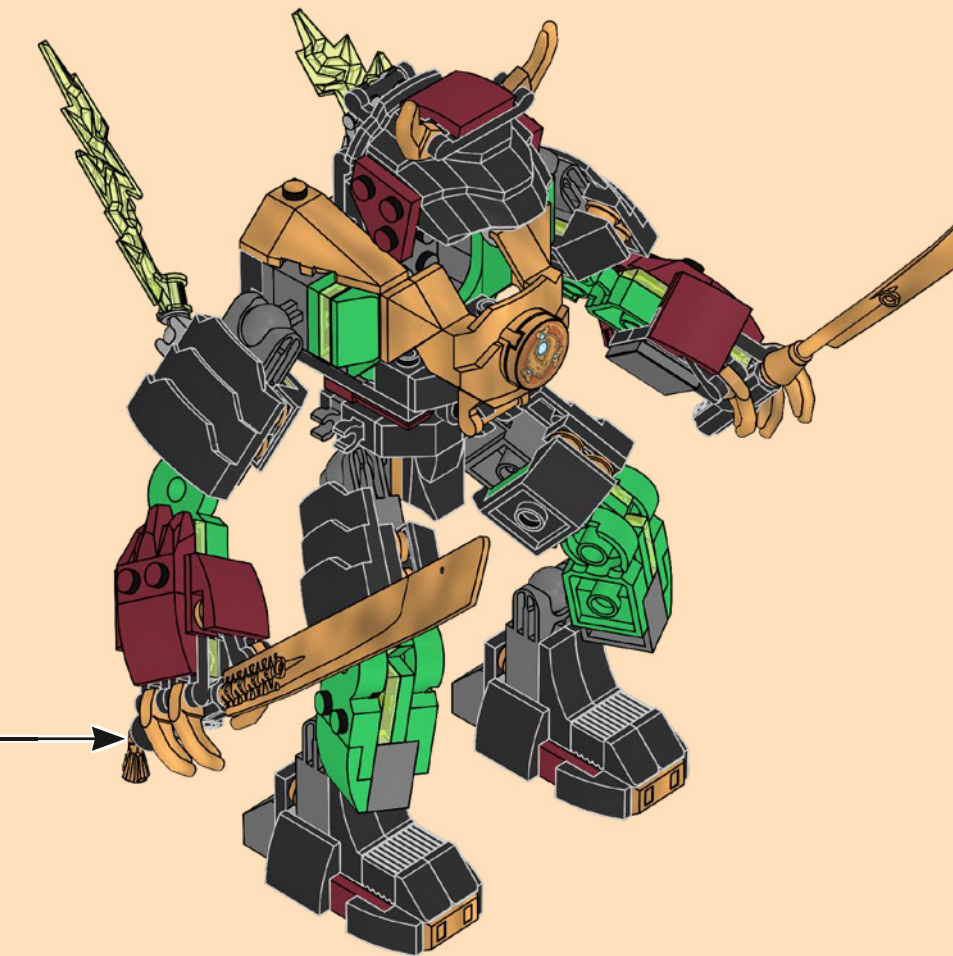

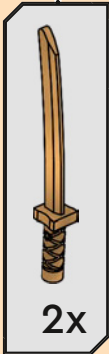
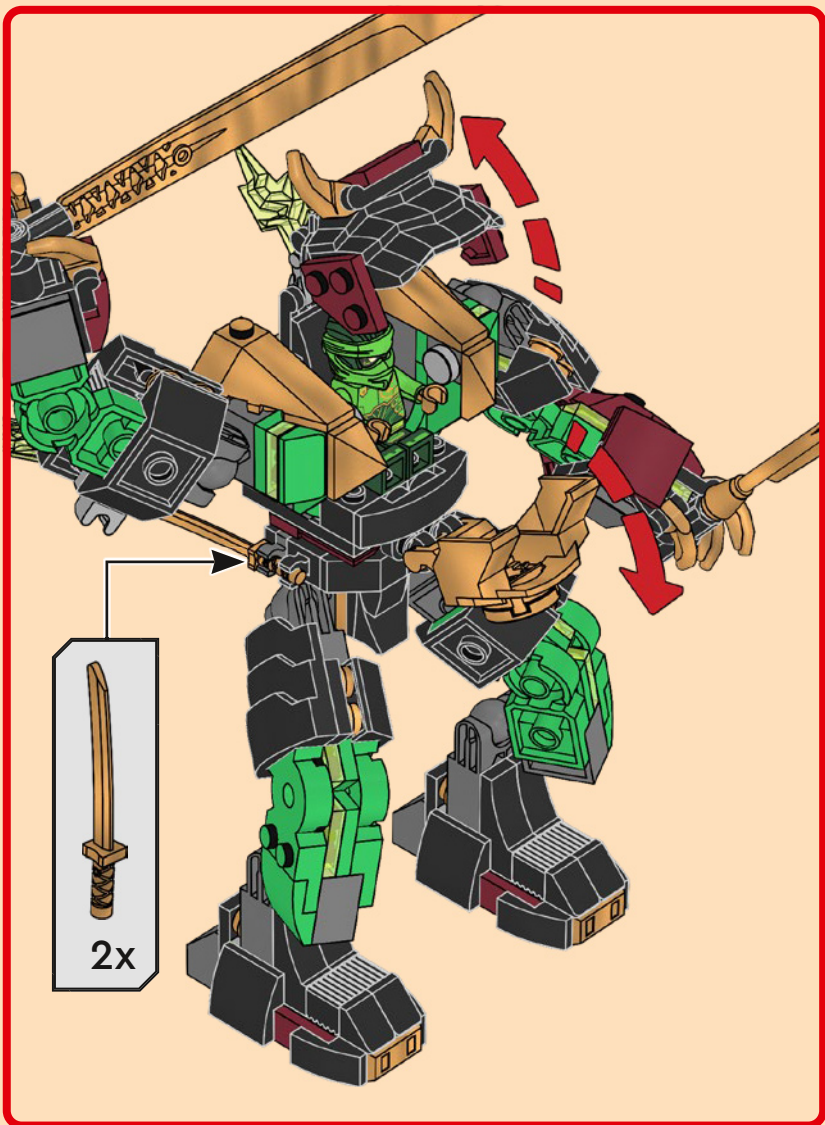



**LEGO**

**CUSTOMIZE YOUR MECH**  
**PERSONNALISEZ VOTRE ROBOT**  
**PERSONALIZA TU MECH**

71817



A

71807

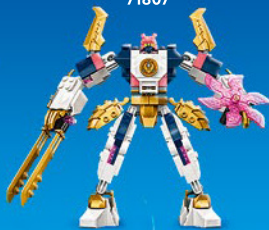

71808

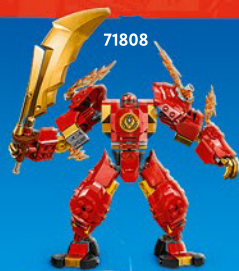

B



C



 4x 4558952	 2x 6174243	 4x 287726	 2x 6116259	 4x 6264026
 1x 6472887	 2x 6267487	 3x 302126	 2x 6403179	 2x 6329652
 1x 4142865	 8x 302326	 1x 4285883	 6x 6372712	 2x 6364638
 1x 4206482	 4x 6069000	 2x 371026	 1x 6470051	 5x 6107758
 1x 6434431	 4x 6047276	 1x 4613153	 1x 6468880	 2x 6291066
 1x 6434435	 1x 6173119	 1x 6332453	 1x 6464359	 4x 6257594
 1x 6270103	 4x 6020193	 4x 4188534	 1x 6469005	 2x 6284071
 2x 6439039	 5x 6053077	 4x 6301371	 1x 6469029	 2x 6443149
 2x 6336977	 2x 6061032	 1x 6466417	 1x 6469029	 1x 6472254
 2x 6210270	 4x 6469445	 2x 6000071	 1x 6464363	 2x 6043656
 2x 6157554	 6x 4515368	 2x 4121969	 2x 6448315	 4x 6123809
 2x 6279875	 2x 6271869	 6x 4157120	 2x 6210310	 2x 6319333
 2x 4253815	 4x 6328095	 2x 302228		 1x 4211452
	 1x 6099483			

2x  
6332045

2x  
6296892

1x  
6398662

2x  
6013082

2x  
4211000

2x  
4624186

4x  
4497253

6x  
6338291

1x  
6065816

1x  
6311001

1x  
6270129

2x  
6075079

1x  
6467216

1x  
6294344

2x  
6207933

2x  
6347982

1x  
6394216

1x  
6394215

3x  
6116596

1x  
6270131

1x  
6371693

1x  
6274711

20x  
4523159

1x  
4529247

8x  
6426622

2x  
6484809

16x  
6484811

4x  
4113917

1x  
6464345

1x  
6469466

1x  
6464366

1x  
6122727

1x  
6476483

 [LEGO.com/service](https://www.lego.com/service)

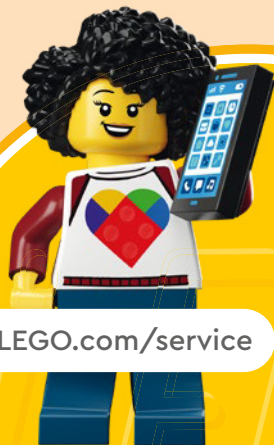

YOU COULD

# WIN



Scan this QR code or go to  
**LEGO.COM/PRODUCTFEEDBACK**  
and give us your short feedback  
about this LEGO® set for a chance  
to win a cool LEGO prize.

Terms and Conditions apply\*



**EN: YOU COULD WIN.** Terms and Conditions apply\* **DE: Du könntest GEWINNEN.** Es gelten die Teilnahmebedingungen\* **FR: Tu pourrais GAGNER.** Des conditions s'appliquent\* **IT: Potresti VINCERE tu.** Termini e condizioni sono applicabili\* **ES: Puedes GANAR.** Aplican términos y condiciones\* **PT: Poderá GANHAR.** Aplicam-se termos e condições\* **ZH: 轻松获奖. 条款和条件适用\*** **PL: Szansa na WYGRANĄ.** Obowiązują warunki korzystania\* **CS: Máte šanci VYHRÁT.** Platí všeobecné smluvní podmínky\* **SK: Máte šancu VYHRAŤ.** Platia všeobecné zmluvné podmienky\* **HU: TE IS NYERHETSZ.** Felhasználási feltételek érvényesek\* **RO: Ai putea CÂȘTIGA.** Se aplică termenii și condiții\* **BG: Можете да СПЕЧЕЛИТЕ.** Има определени правила и условия\* **LV: Tu vari LAIMĒT.** Ir spēkā noteikumi un nosacījumi.\* **ET: Sul on võimalus VÕITA.** Kehtivad tingimused\* **LT: Jūs galite LAIMĖTI.** Taikomos sąlygos\*

\*[LEGO.com/productfeedback-terms](https://www.lego.com/productfeedback-terms)

LEGO, the LEGO logo, NINJAGO and the NINJAGO logo are trademarks of the/  
sont des marques de commerce du/son marcas registradas de LEGO Group.  
©2024 The LEGO Group.