



STAR WARS

75072



SERIES 2

MICROFIGHTERS

MICRO VAISSEAUX

MICRONAVES

2^E SÉRIE

SERIE 2

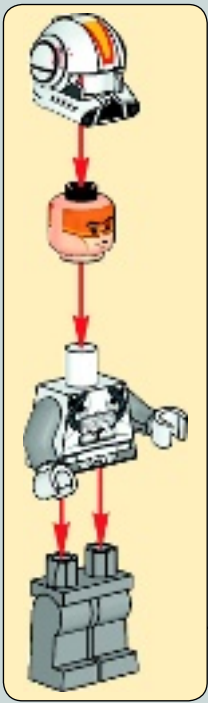

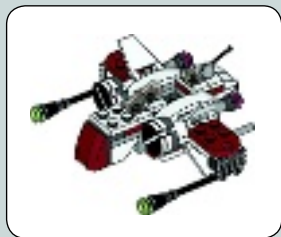

1

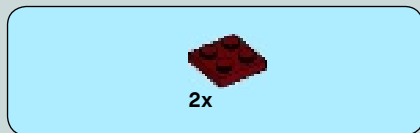

2

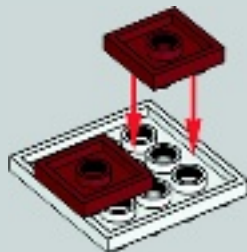

3



2x



2x

3

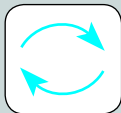

4



1x



2x

4



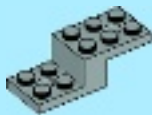

1x

5

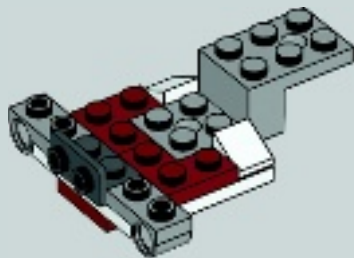



1x

6

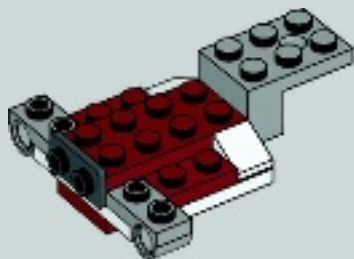

6



2x



2x

7





1x



2x

8

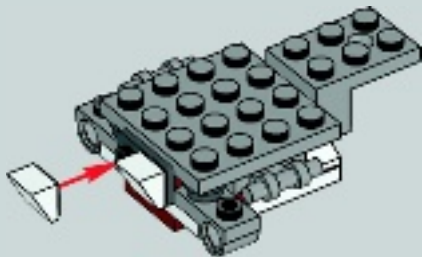



1x



2x



1x

9

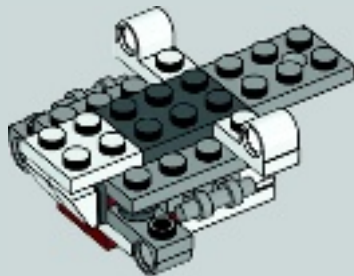



1x



1x



2x

10

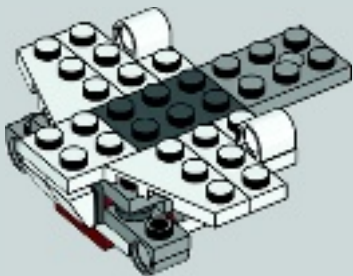

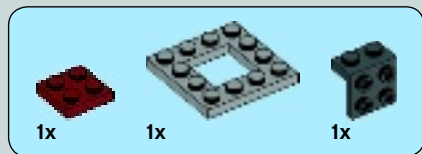

11

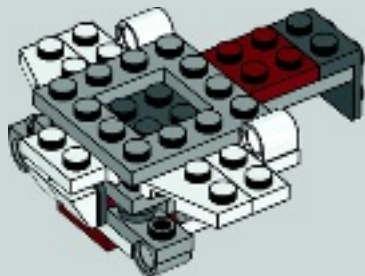



1x

12

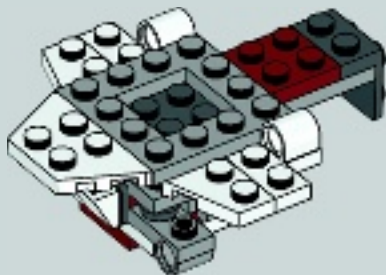



2x

13

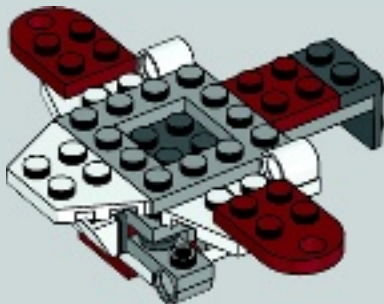



2x



2x



2x



2x

14

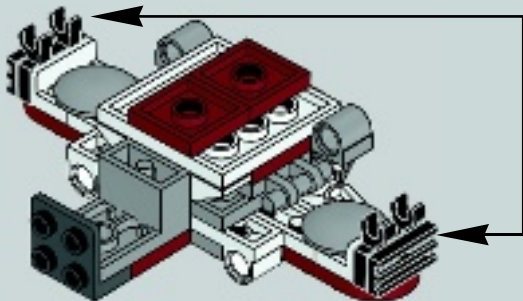
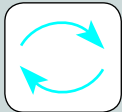

1



2



3



2x



2x



2x

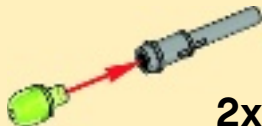

2x



16

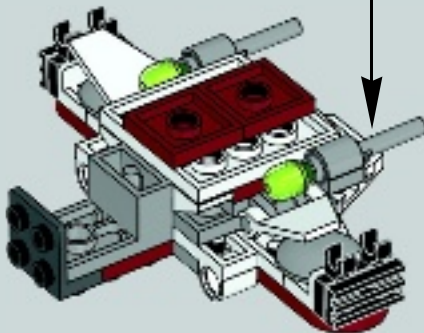



2x

17

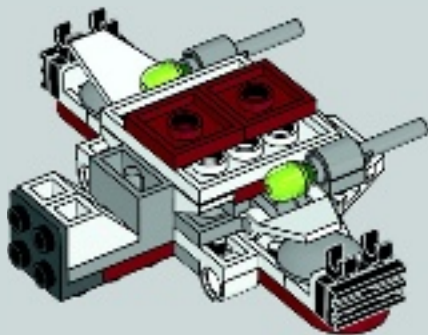



1x



1x

18

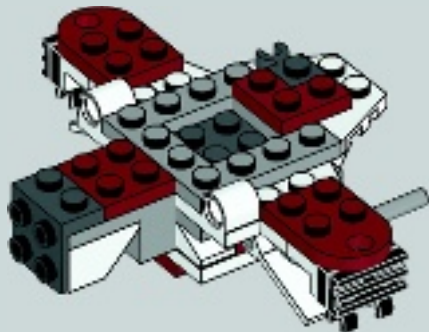
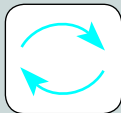



2x



2x

19

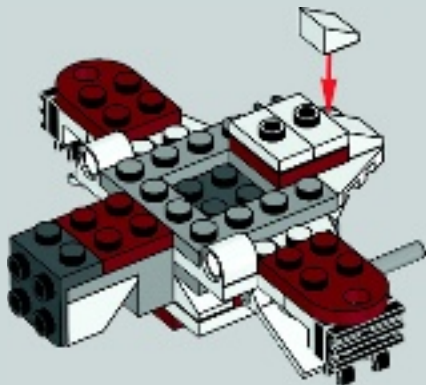



2x



1x

20

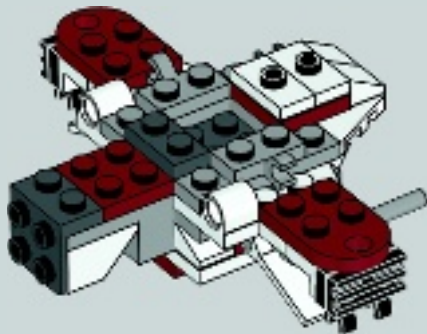



2x

21

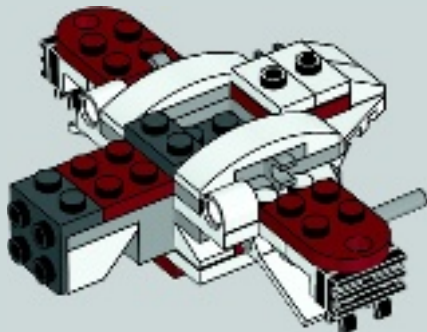



1x



2x

22

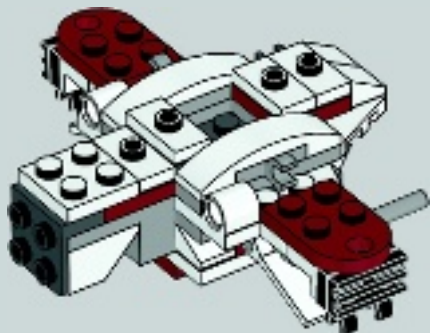



1x



3x

23

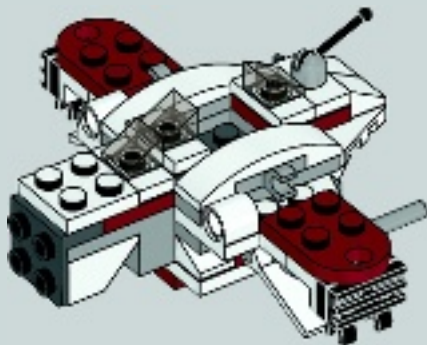



2x



1x

24

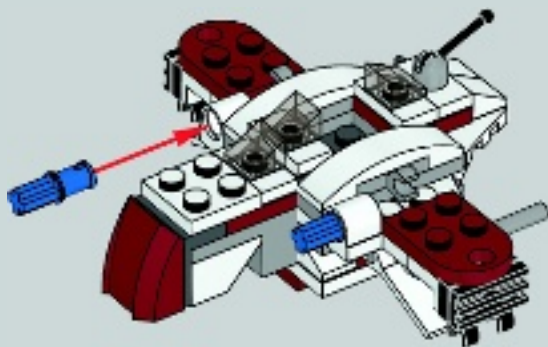



2x



2x



2x

25

1



2



2x

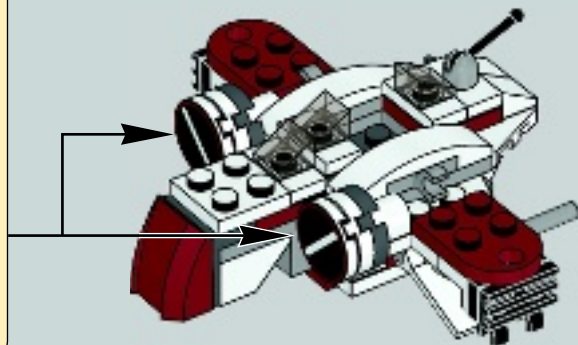

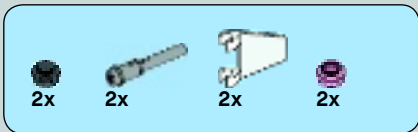

26

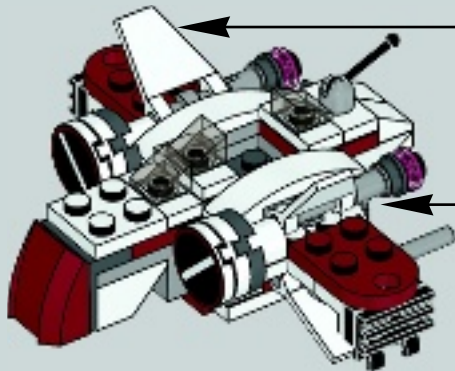
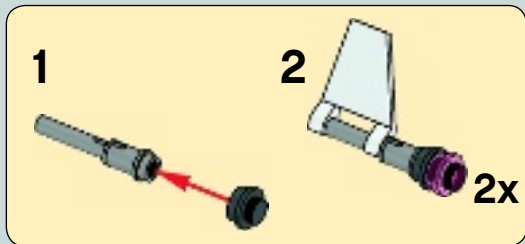

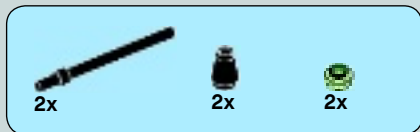

27

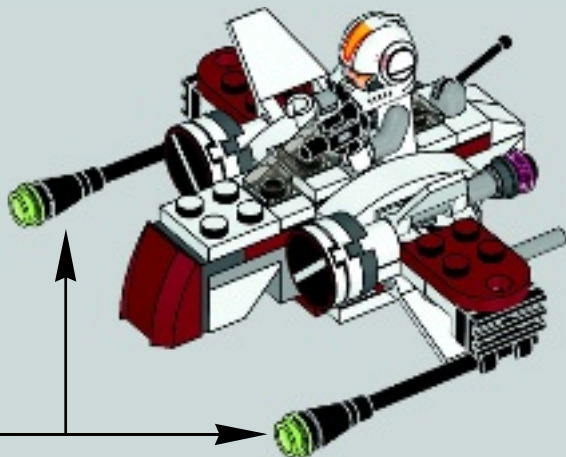
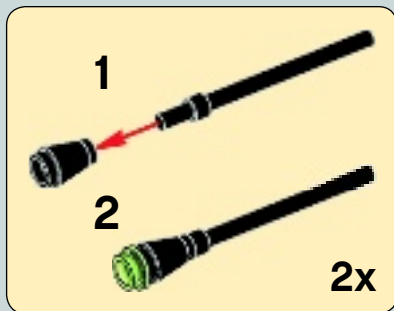

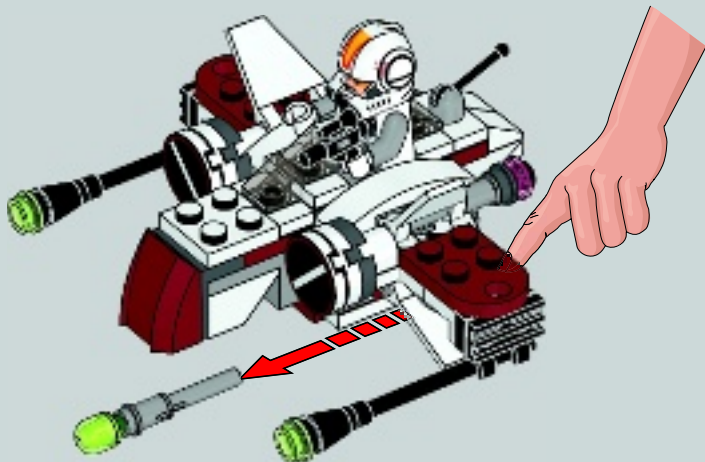

6x 4504369	1x 4243812	4x 6023099	1x 4609050	1x 6028811	1x 4221775	1x 4587212	2x 4211042
2x 366501	1x 4249506	1x 6063556	3x 4244368	1x 4612621	1x 4227657	1x 4211063	1x 6096721
2x 6023806	2x 6018774	1x 6097106	2x 4599535	1x 462621	4x 4520320	1x 6117972	2x 6057034
4x 6051511	1x 4179875	2x 4206482	3x 4585751	1x 4243797	2x 6089147	1x 6000606	2x 4570481
2x 302201	1x 4179874	2x 4529236	3x 4585479	2x 6028812	1x 4211043	4x 4210633	
2x 362301	2x 403201	2x 241226	1x 4539071	2x 4211632			
2x 6057414	2x 6096585	2x 4556158	2x 4568753	2x 4278273			
		2x 6081988	1x 6039200				



Customer Service
Kundenservice
Service Consommateurs
Servicio Al Consumidor
LEGO.com/service or dial



: 00800 5346 5555

: 1-800-422-5346



LEGO



STAR
WARS



MICROFIGHTERS

Apple, the Apple logo, iPad, iPhone and iPod touch are trademarks of Apple Inc., registered in the U.S. and other countries. App Store is a service mark of Apple Inc.

Apple, le logo Apple, iPad, iPhone et iPod touch sont des marques de commerce d'Apple Inc., déposées aux États-Unis et dans d'autres pays. App Store est une marque de service d'Apple Inc.

Apple, el logotipo de Apple, iPad, iPhone e iPod touch son marcas comerciales de Apple Inc. registradas en EE. UU. y otros países. App Store es una marca de servicio de Apple Inc.

STAR WARS © & ™ 2015 Lucasfilm Ltd.
© 2015 The LEGO Group. ™ & © WBEI.

Google Play is a trademark of Google Inc.
Google Play est une marque de commerce de Google Inc.
Google Play es una marca comercial de Google Inc.

MICROFIGHTERS



LEGO STAR WARS

Download the Microfighters App!
Téléchargez l'appli Micro vaisseaux !
Descarga la app de las Micronaves!



Available on the
 **App Store**

GET IT ON
 **Google play**

