



AVATAR

75575





Get excited about our new packaging!

We're switching from plastic to paper-based packaging. That's why you might find a mix of paper and plastic in our boxes!

Nos nouveaux emballages vous emballeront !

Nous passons des emballages en plastique aux emballages à base de papier. C'est pourquoi vous pourriez trouver un mélange de papier et de plastique dans nos boîtes !

¡Te presentamos nuestros nuevos empaques!

Estamos sustituyendo las bolsas de plástico por bolsas con base de papel. ¡Por eso, puedes encontrar una mezcla de papel y de plástico en nuestras cajas!

[LEGO.com/sustainable-packaging](https://www.lego.com/sustainable-packaging)



BUILDER



Apple and the Apple logo are trademarks of Apple Inc., registered in the U.S. and other countries and regions. App Store is a service mark of Apple Inc. Google Play and the Google Play logo are trademarks of Google LLC. Tencent and the Tencent logo are trademarks of Tencent Inc.

EN Ask parents' permission before going online | **DE** Eltern um Erlaubnis bitten, bevor du online gehst | **FR** Demande l'autorisation d'un parent avant d'aller en ligne | **IT** Chiedi il permesso ai tuoi genitori prima di andare online | **ES** Pídeles permiso a tus papás antes de conectarte a Internet | **PT** Pede autorização aos pais antes de acederes online | **JA** オンラインになる前に ほか者の方のきよかをもらおう | **ZH** 上网前应先征得父母的同意 | **KO** 온라인 접속 전에 보호자 동의가 필요합니다 | **RU** Спроси разрешения у родителей, прежде чем заходить в интернет | **PL** Poproś rodziców o zgodę, zanim wejdiesz do Internetu | **CS** Než půjdeš na internet, požádej rodiče o svolení | **SK** Skôr než pôjdeš na internet, vypýtaj si povolenie od rodičov | **HU** Kérj szülői engedélyt, mielőtt online csatlakoznál! | **RO** Cere permisiunea părinților înainte de a te conecta online | **BG** Поискайте разрешение от родител, преди да влезете онлайн | **LV** Pirms došanās tiešsaistē palūdz atļauju vecākiem | **ET** Enne Interneti kasutamist küsi vanematelt luba | **LT** Prieš prisijungdami prie interneto, atsklauskite tėvų

Q [LEGO.com/devicecheck](https://www.lego.com/devicecheck)

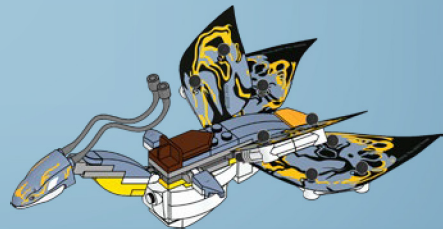
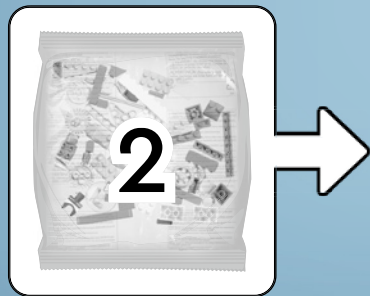
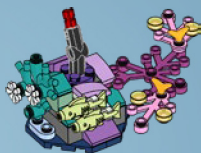
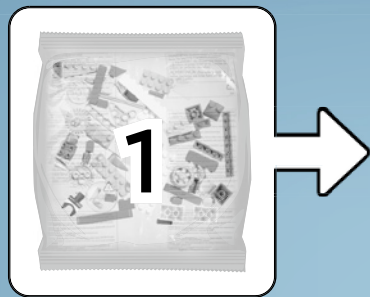



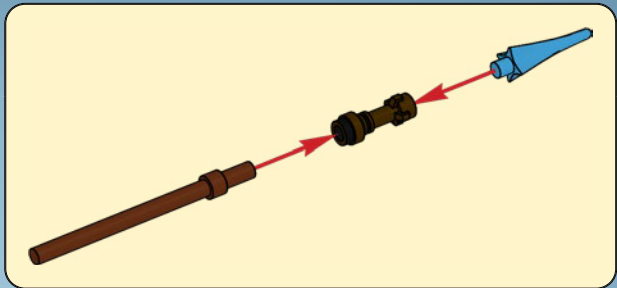

1

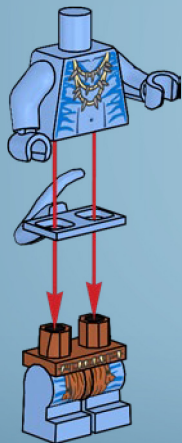

2

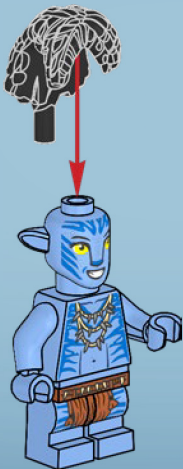

3





2x

1

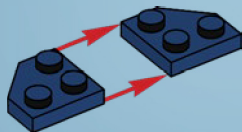

1x

2

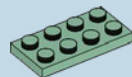
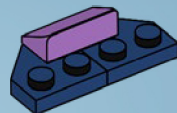

1x

3

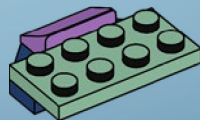



2x

4

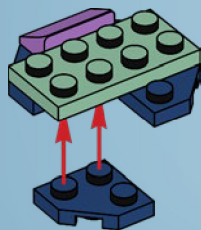

2x

5

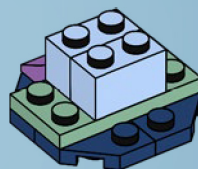



1x



1x



1x

6

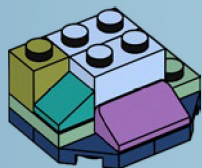

1x



1x



1x

7

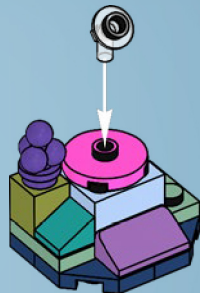

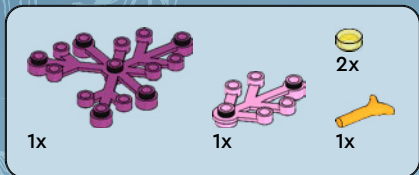

8

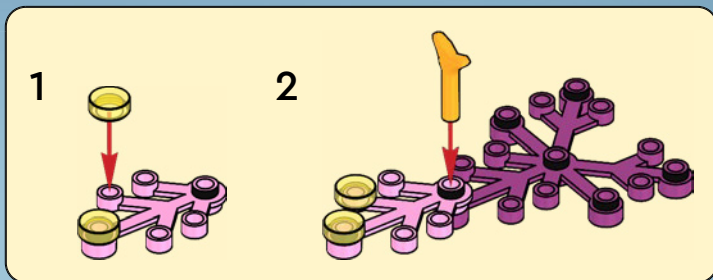



1x

9

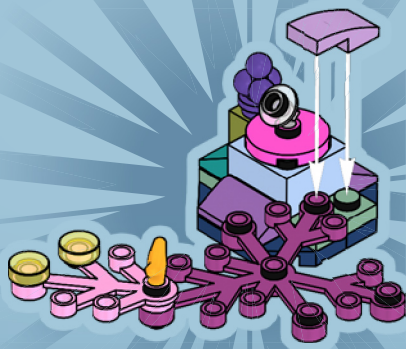





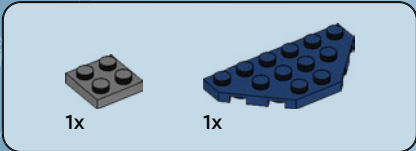
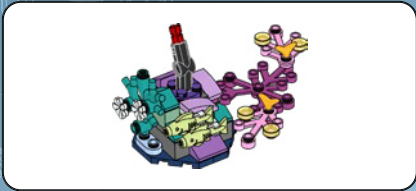

1

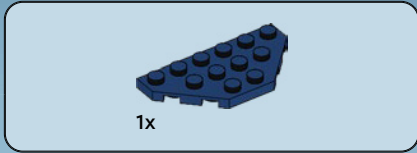
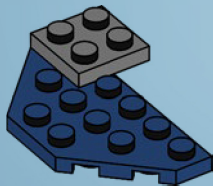

2

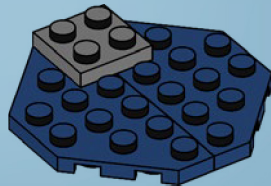



2x

3

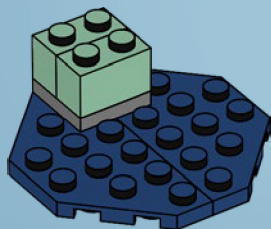

1x



1x

4

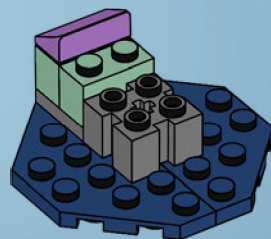

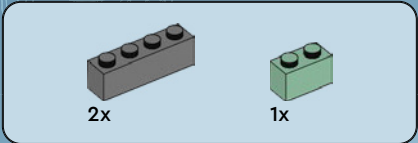

5

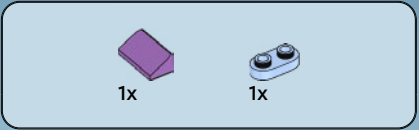
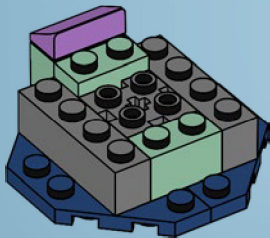

6

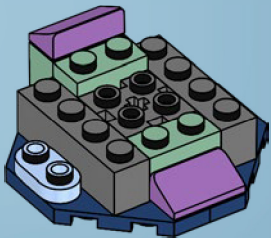

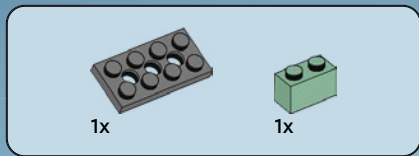

7

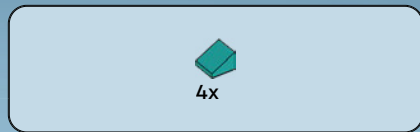
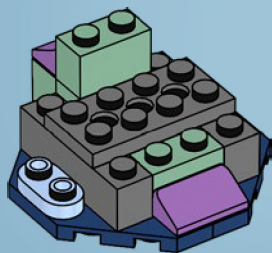

8

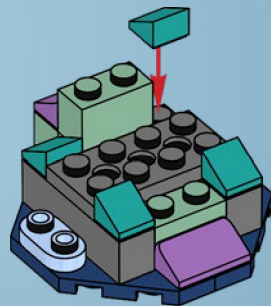



1x



1x

9

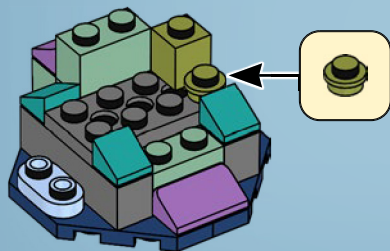

1x



1x

10

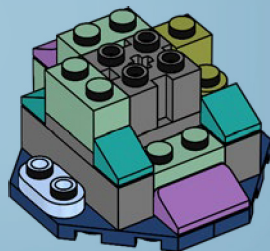



1x



1x

11

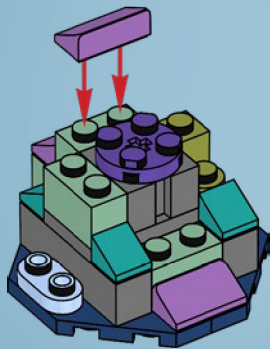

2x



1x

12

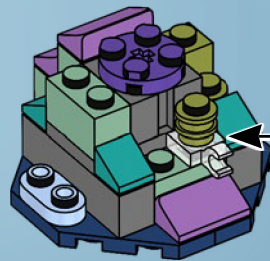



1x



1x

13

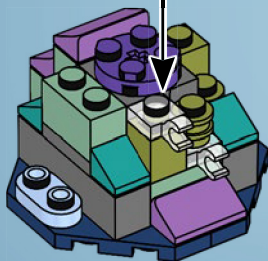
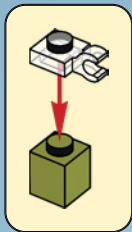

1x



2x

14

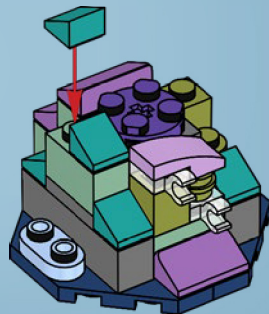



1x



2x

15

1



2

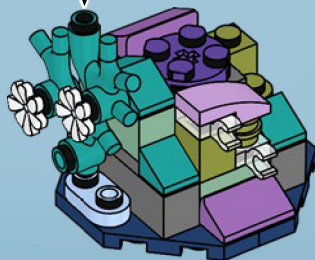
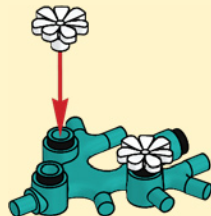



2x

16

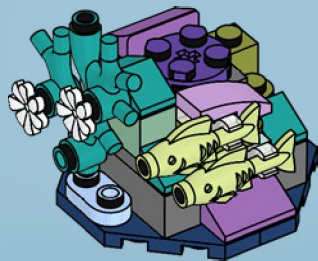

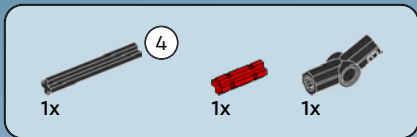

17

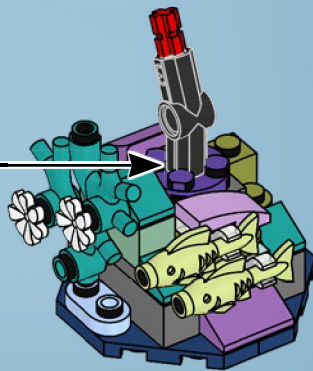
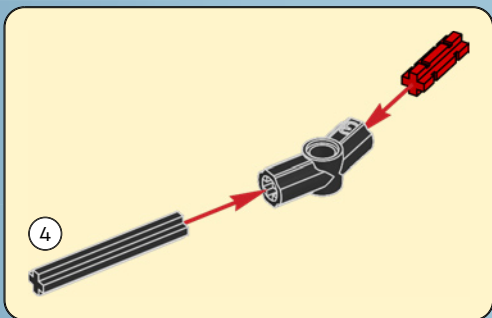



1x

18

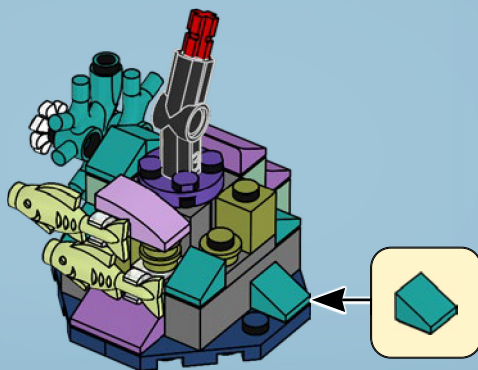

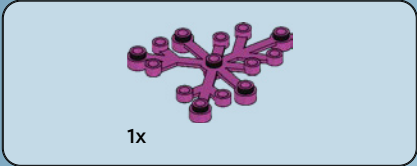

19

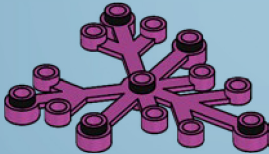

20

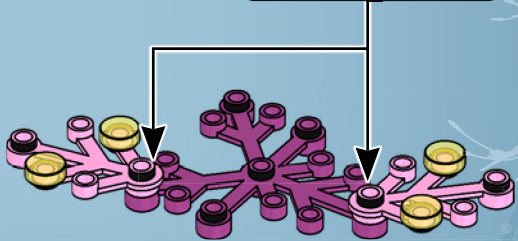
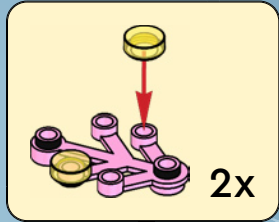



2x

21

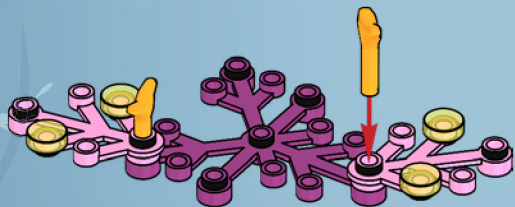

22

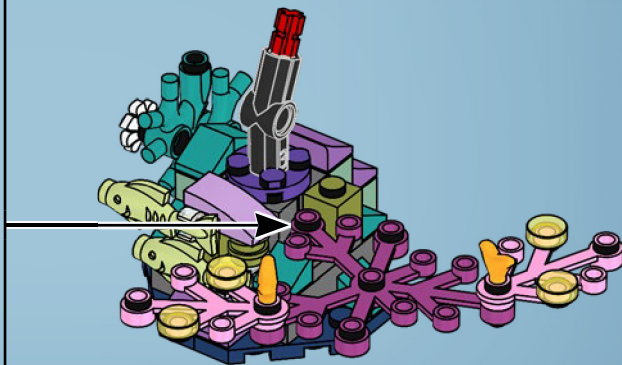



1x

23

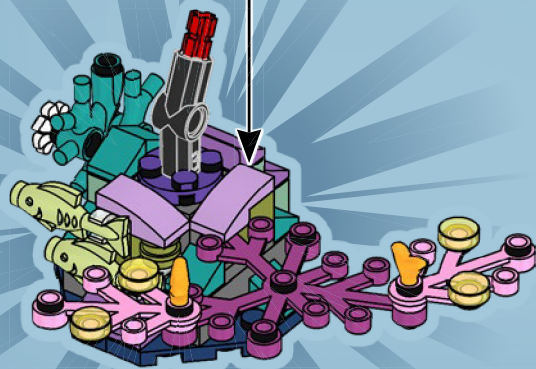







1

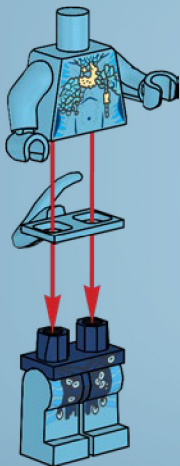

2

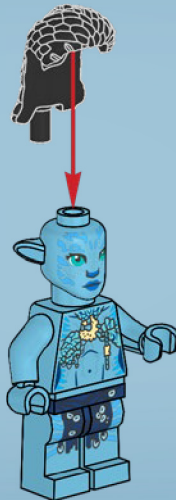

3



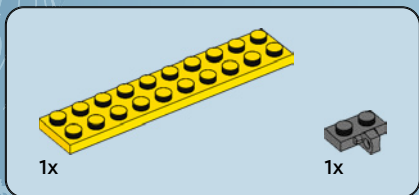
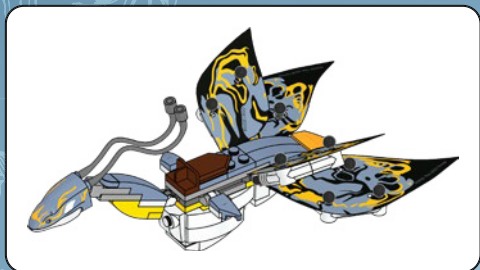

1

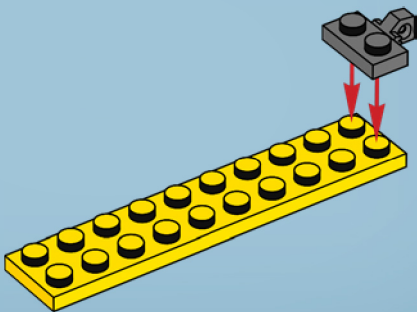

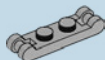

1x

2

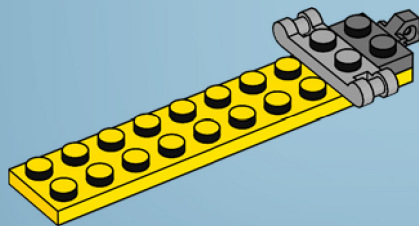

2x

3

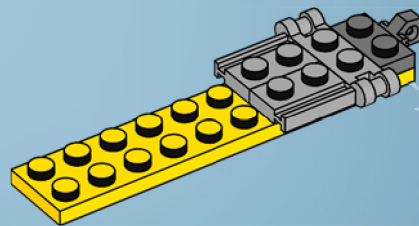



2x

4

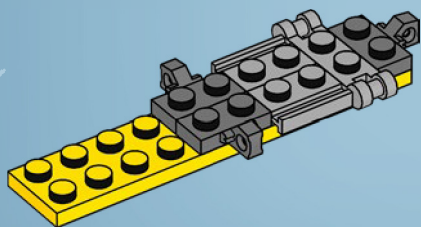

1x

5

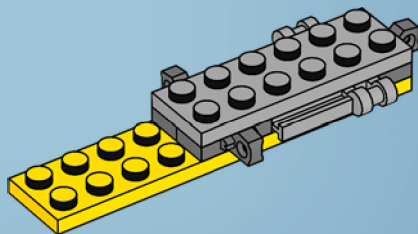



2x



1x

6

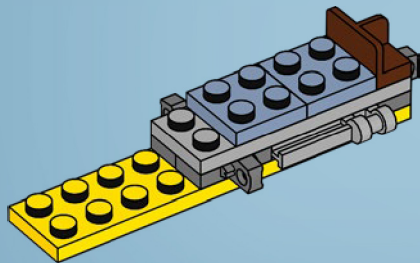

1x

7

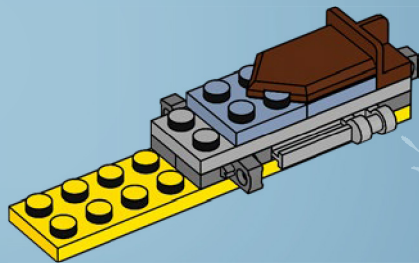



1x

8

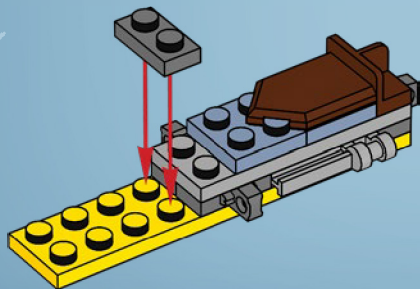

1x



2x

9

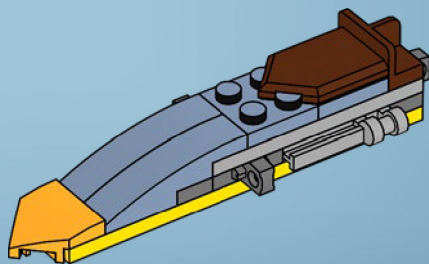

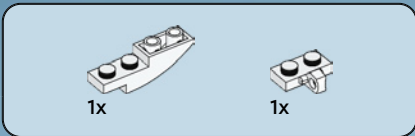

10

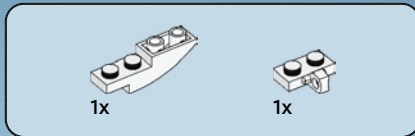
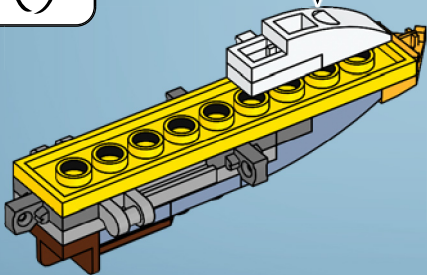
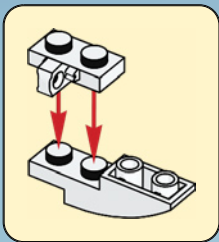

11

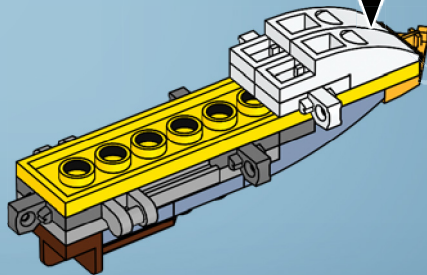
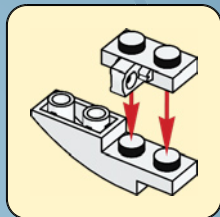



1x

12

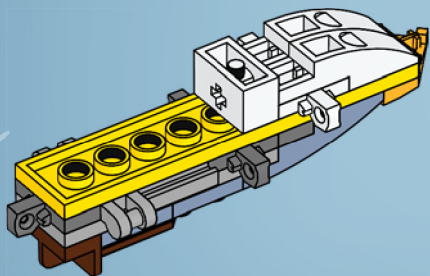

1x

13

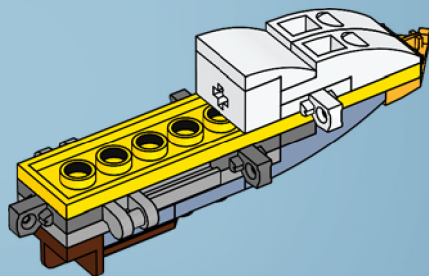



1x

14

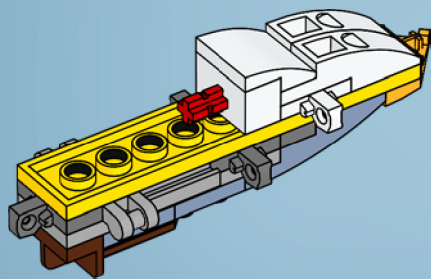

1x

15

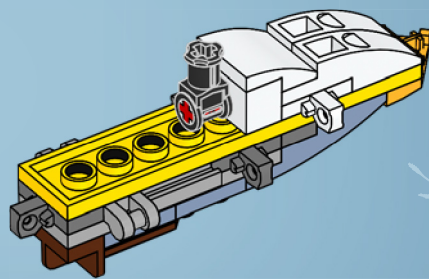



2x

16

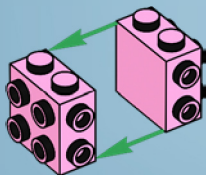

1x

17





1x

18

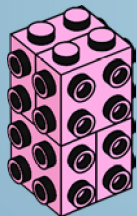

1x

19





1x



1x



1x

20

1

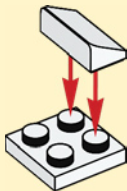

2

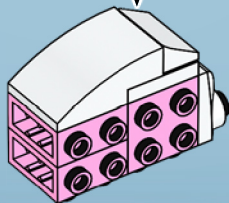
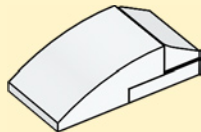

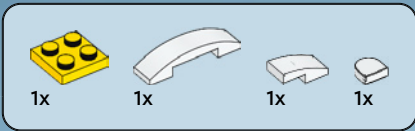

21

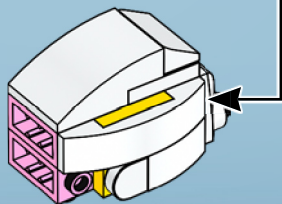
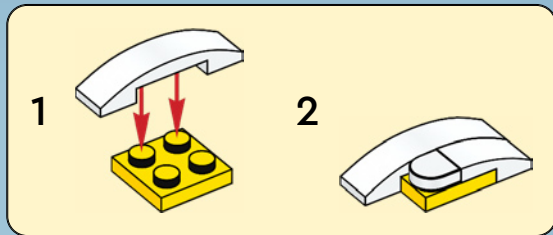



1x

22

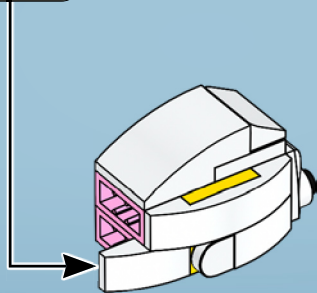

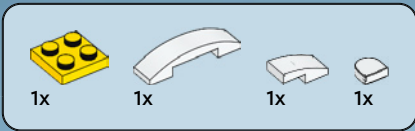

23

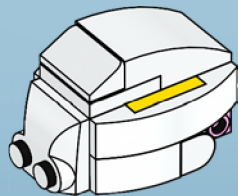
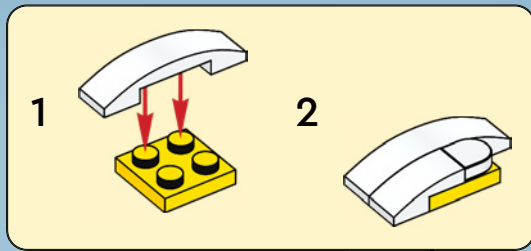



1x

24

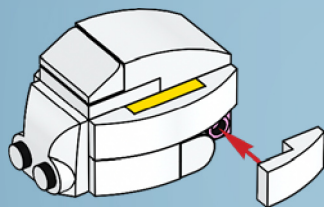

25

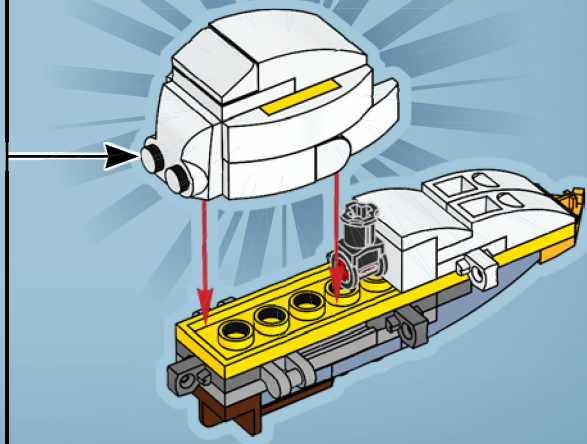



1x



1x



2x

26

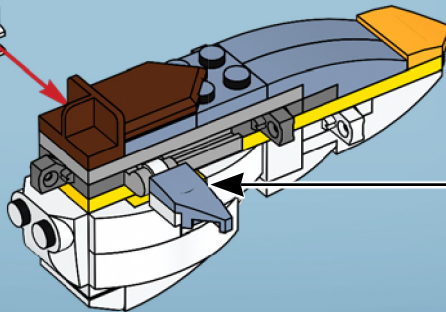
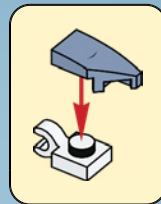
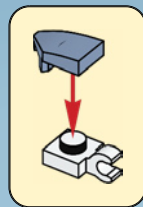



2x



2x



2x



4x



2x



4x



2x

3

27

1

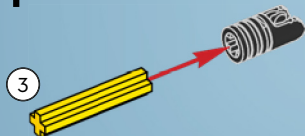

2

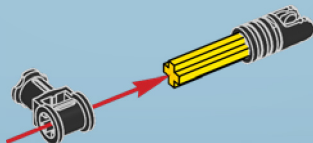

3

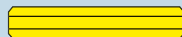

3

1:1

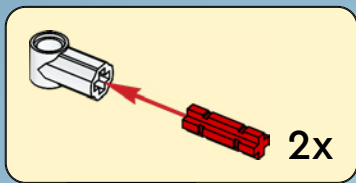

4

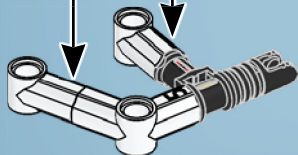

2x

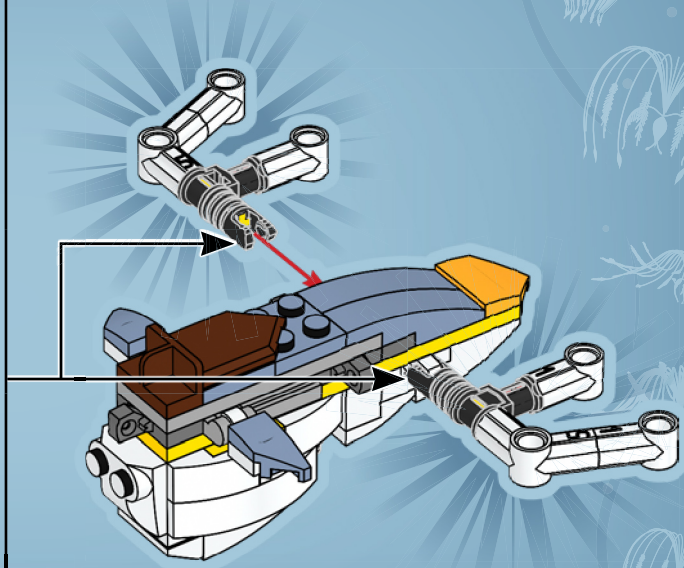



6x

28

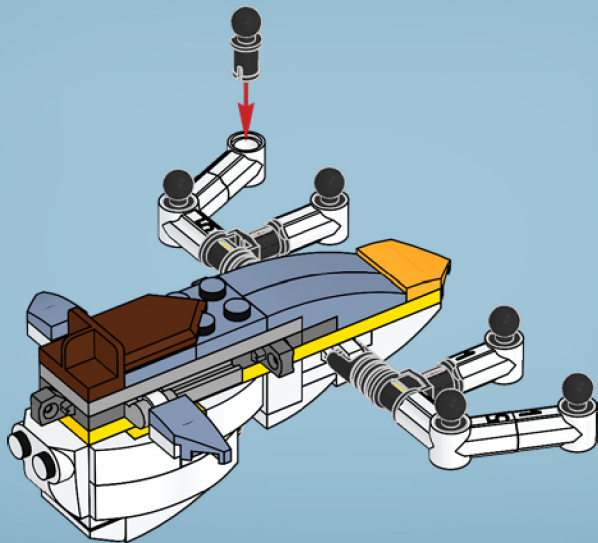

29

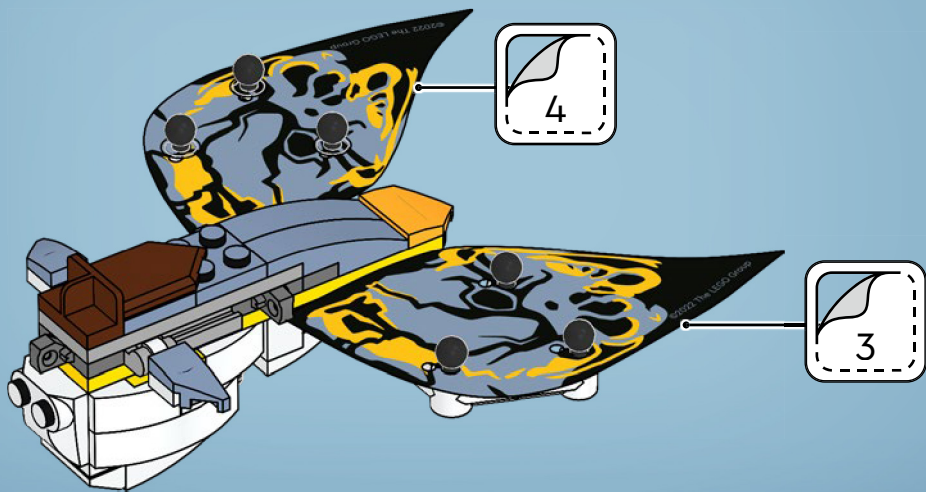
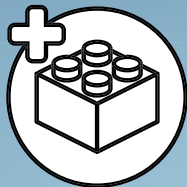

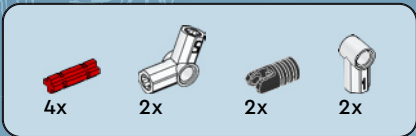

30

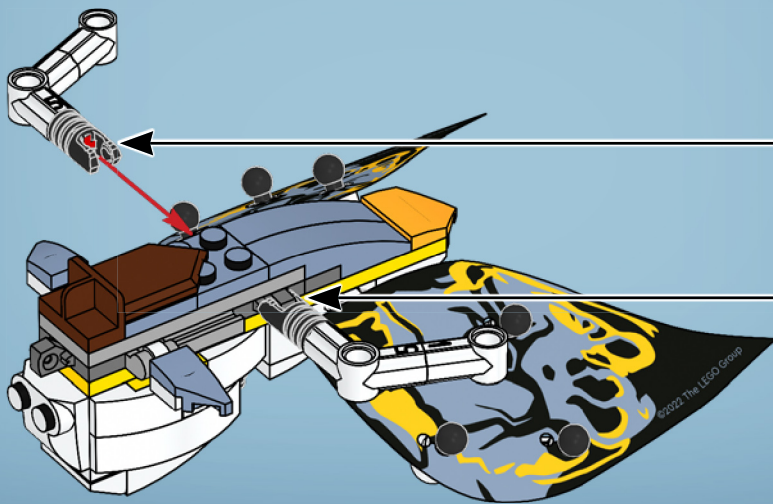
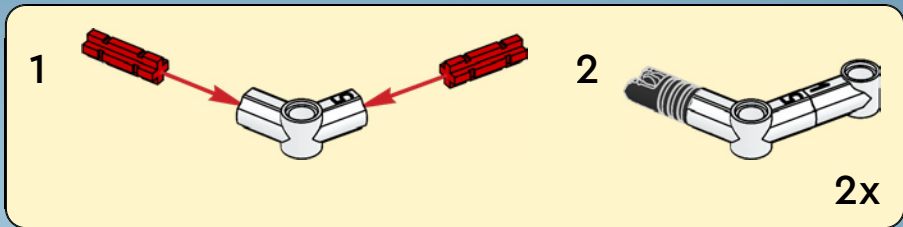



4x

31

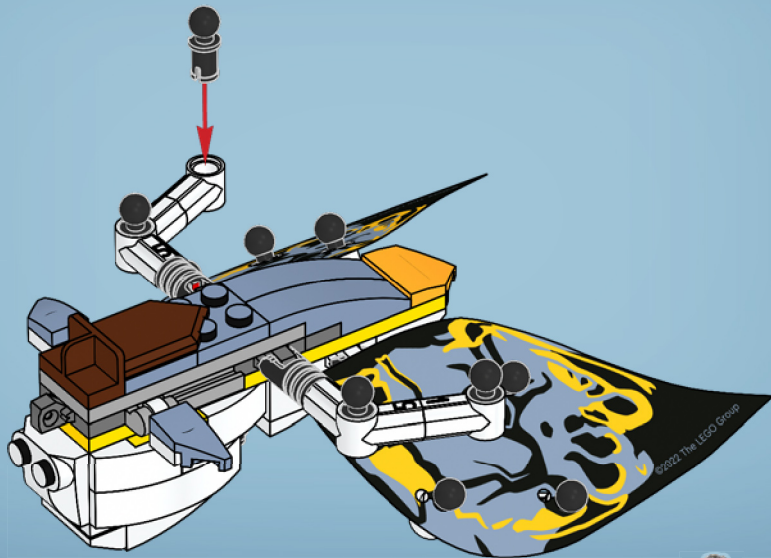

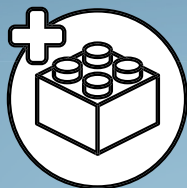

32

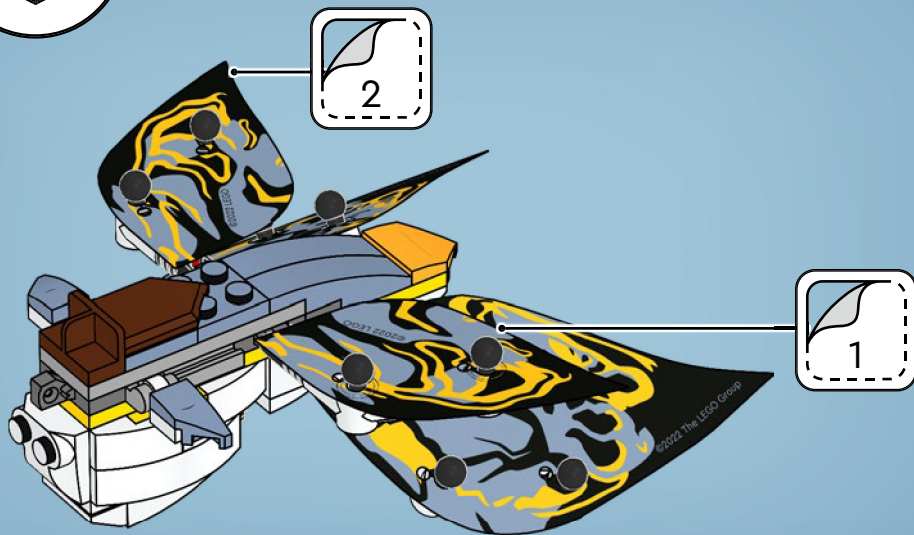

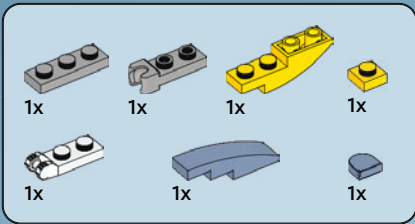

33

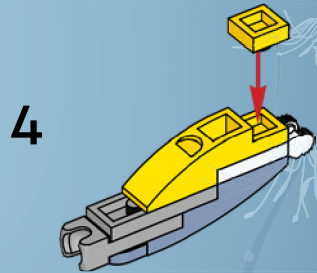
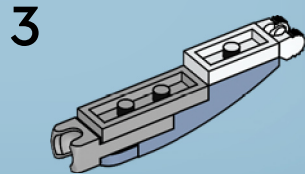
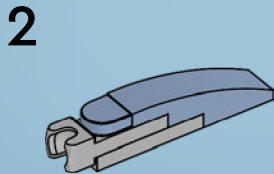
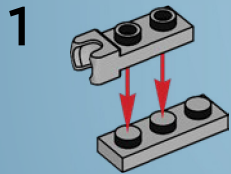

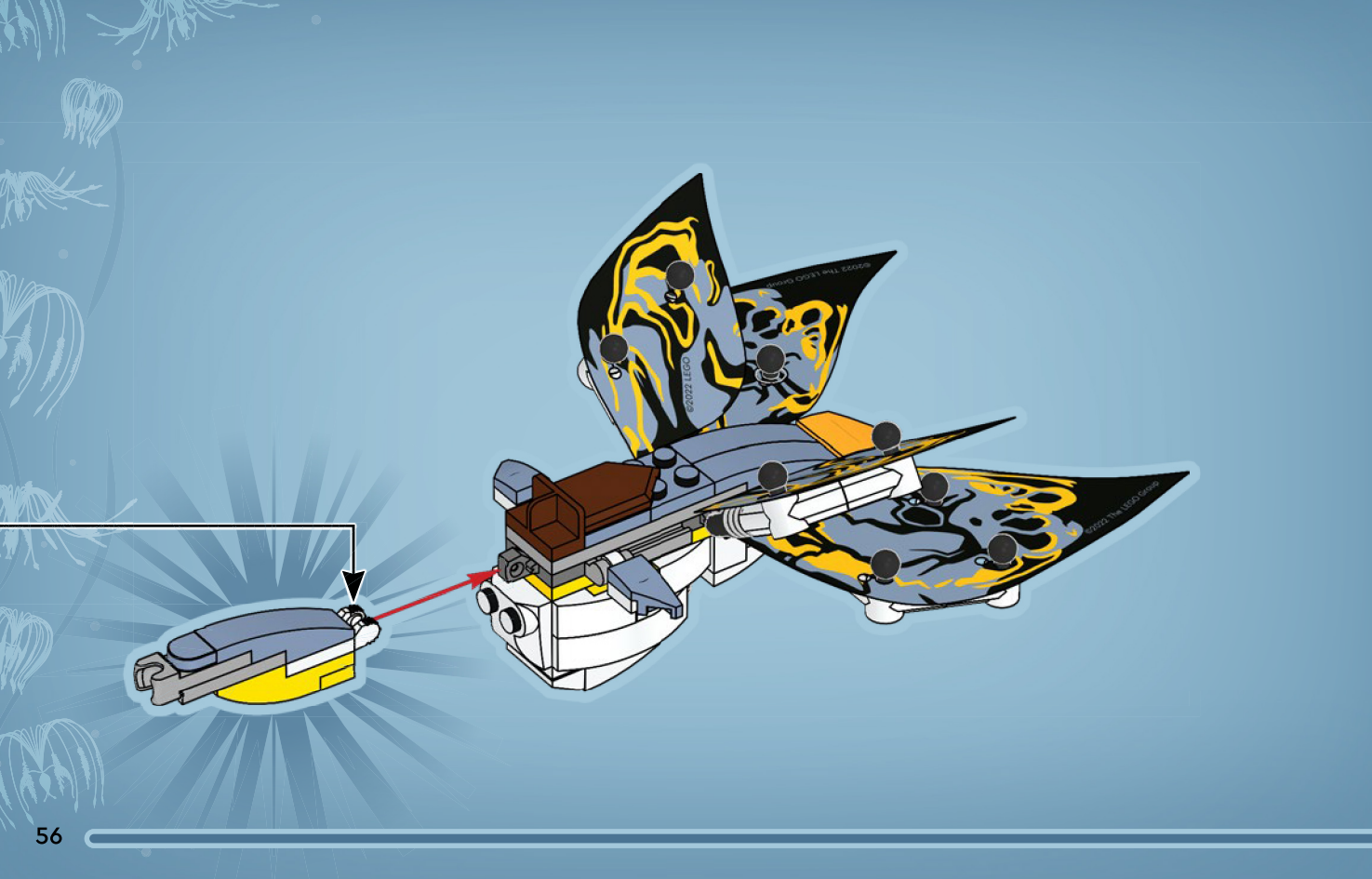

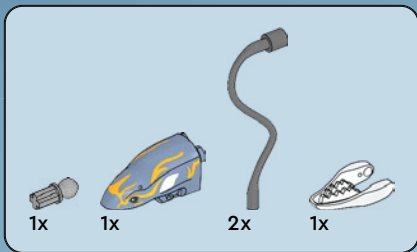

34

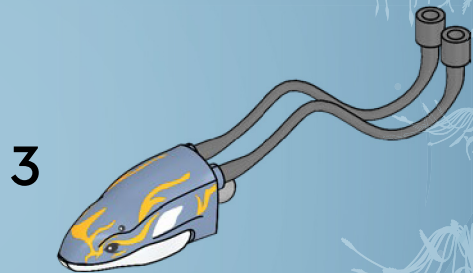
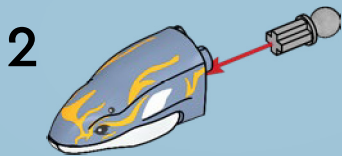
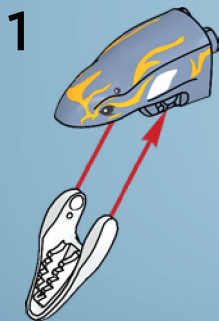

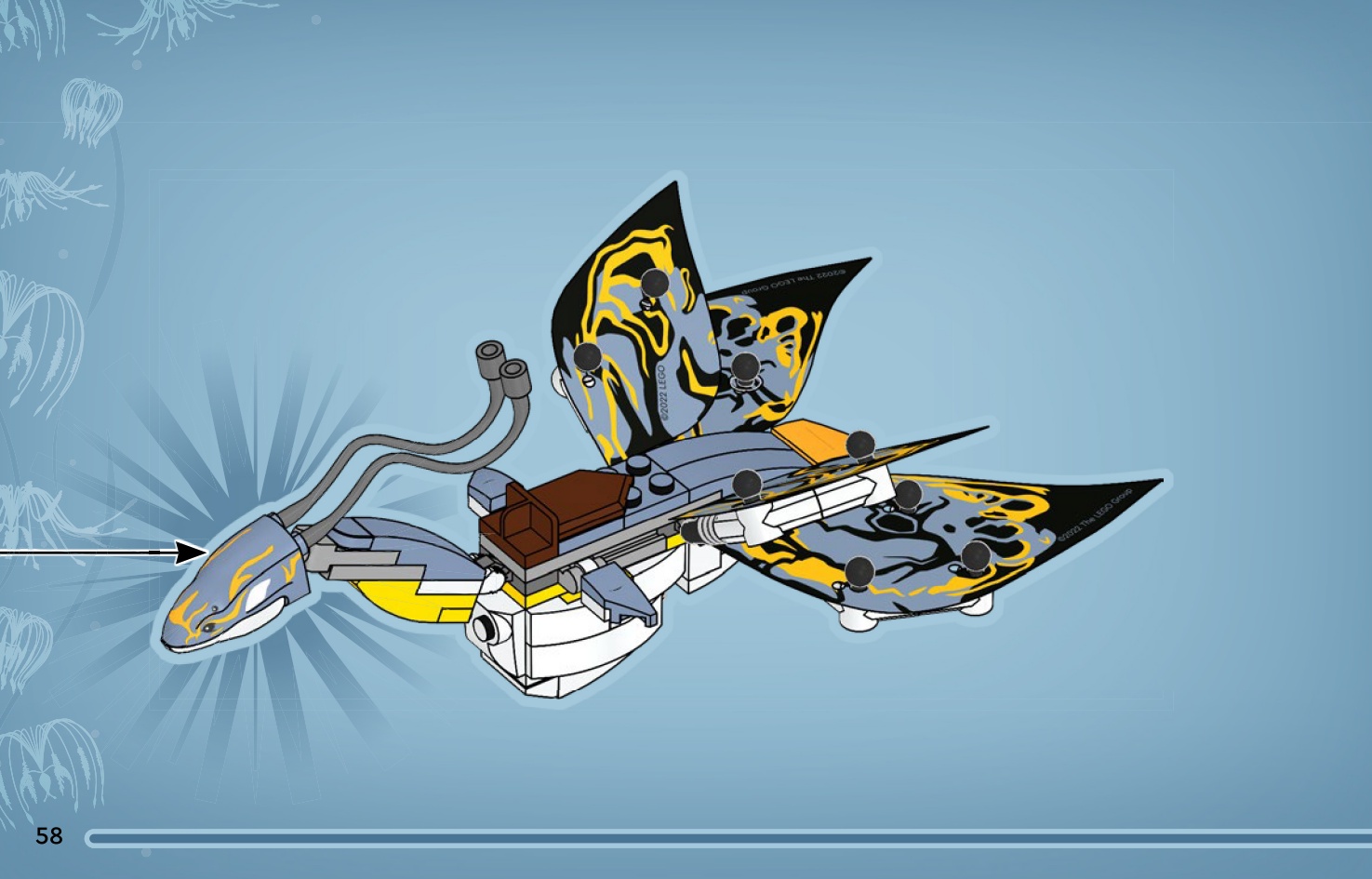



LEGO

AVATAR



75571



75572



75573



75574



75575



75576



75577



75578



75579





2x
6250591



2x
6338913



6x
6332573



2x
6347293



1x
4547489



1x
6178921



2x
6266253



4x
6034044



4x
6271349



1x
6210385



1x
302201



1x
4494474



1x
6267044



1x
6429607



1x
6132212



2x
6034675



2x
6023806



10x
6344752



1x
6388512



4x
6271535



3x
6331716



1x
6412296



1x
6261386

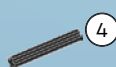

1x
370526



3x
6096682



1x
6339302



1x
6285587



2x
6429708



6x
6274740



1x
6421764



1x
6385602



1x
6430040



8x
6278172



1x
6262134



1x
6430055



1x
6429608



1x
6257109



1x
6257108



2x
6062089



1x
6421683



3x
6431757



1x
6421763



4x
6164071



2x
6127326



5x
4616581



1x
6249817



1x
4211375



2x
4211568



1x
6043639



1x
4211429



1x
6093058



1x
4211452



1x
6133860



1x
6245259



1x
6170468



2x
6425976



3x
6266248



1x
4211063



2x
6236949



1x
4211094



2x
4211103



1x
4227398



1x
6372122



2x
6100322



1x
6432085



1x
6421761



1x
6420861



1x
6430009



1x
6133832



2x
6291414



3x
6258990



3x
6058242



5x
6335182



3x
6097647



4x
6345505



3x
6329957



10x
4142865



1x
6223767



1x
6278447



1x
6030534



2x
6266974



1x
302424



2x
302224



2x
6130007



1x
6146298



1x
383224

1x
383224



1x
6427947

3



 [LEGO.com/service](https://www.lego.com/service)

YOU COULD **WIN**



Scan this QR code or go to **LEGO.COM/PRODUCTFEEDBACK** and give us your short feedback about this LEGO® set for a chance to win a cool LEGO prize.

Terms and Conditions apply*



DE: Du könntest GEWINNEN. Es gelten die Teilnahmebedingungen* **FR: Tu pourrais GAGNER.** Des conditions s'appliquent* **IT: Potresti VINCERE tu.** Termini e condizioni sono applicabili* **ES: Puedes GANAR.** Aplican términos y condiciones* **PT: Poderá GANHAR.** Aplicam-se termos e condições* **JA: プレゼント付き! 利用規約が適用されます*** **ZH: 轻松获奖. 条款和条件适用*** **KO: 상품의 주인이 되어보세요. 소정의 약관이 적용됩니다*** **RU: Вы можете ВЫИГРАТЬ.** Действуют положения и условия* **PL: Szansa na WYGRANĄ.** Obowiązują warunki korzystania* **CS: Máte šanci VYHRÁT.** Platí všeobecné smluvní podmínky* **SK: Máte šancu VYHRAŤ.** Platia všeobecné zmluvné podmienky* **HU: TE IS NYERHETSZ.** Felhasználási feltételek érvényesek* **RO: Ai putea CÂȘTIGA.** Se aplică termeni și condiții* **BG: Можете да СПЕЧЕЛИТЕ.** Има определени правила и условия* **LV: Tu vari LAIMĒT.** Ir spēkā noteikumi un nosacījumi.* **ET: Sul on võimalus VÕITA.** Kehtivad tingimused* **LT: Jūs galite LAIMĖTI.** Taikomos sąlygos*
*LEGO.com/productfeedback-terms

LEGO and the LEGO logo are trademarks of the/sont des marques de commerce du/son marcas registradas de LEGO Group. ©2023 The LEGO Group.

TM & © 20th Century Studios

6449464