

LEGO

GH**OS**TBUSTERS

75828



ABBY

A passionate scientist who's always believed in the paranormal.



CONFIDENTIAL



ERIN

A highly respected theoretical particle physicist.



CONFIDENTIAL



PATTY

A former MTA employee turned ghost-trapper and metaphysical commando.

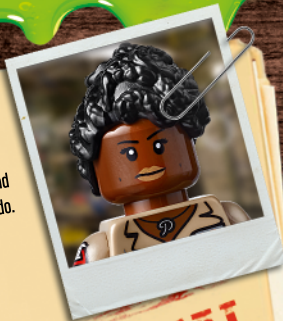

CONFIDENTIAL



HOLTZMANN

An oddball engineer who likes putting stuff together and inventing things.



CONFIDENTIAL



KEVIN

An unemployed actor from a small town outside of Sydney.



CONFIDENTIAL



MAYHEM

An entity from another dimension who likes to have fun.



DANGER



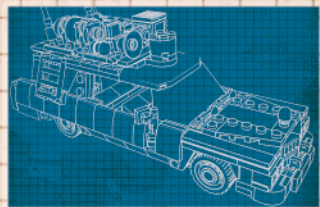

ECTO-1

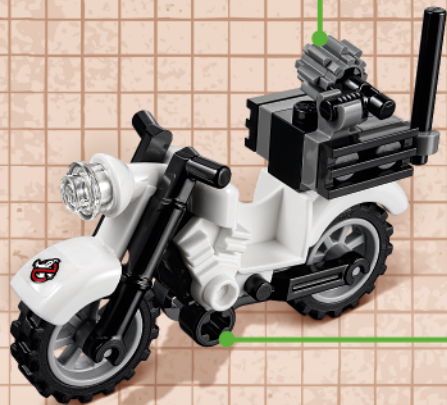

ECTO-2



ABBY

A passionate scientist who's always believed in the paranormal.
Eine leidenschaftliche Wissenschaftlerin, die an paranormale Phänomene glaubt.
Une scientifique passionnée qui a toujours cru au paranormal.
Una apasionada científica que siempre ha creído en los seres paranormales.
Uma cientista apaixonada que sempre acreditou no paranormal.
Szenvedélyes tudós, aki mindig is hitt a paranormális jelenségekben.
一位充满激情的科学家，始终相信超自然现象。

ERIN

A highly respected theoretical particle physicist.
Eine höchst angesehene theoretische Teilchenphysikerin.
Une physicienne des particules hautement respectée.
Una respetada física teórica especializada en partículas.
Uma física teórica de partículas altamente respeitada.
Nagy tekintélyű elméleti részecskefizikus.
一位备受尊敬的理论粒子物理学家。

HOLTZMANN

An oddball engineer who likes putting stuff together and inventing things.
Ein seltsamer Vogel, der gerne Teile zusammenbaut und Dinge erfindet.
Une originale qui aime assembler et inventer des choses.
Una excéntrica ingeniera aficionada a juntar cosas e inventar aparatos.
Uma engenheira excêntrica que gosta de juntar e inventar coisas.
Egy mérnök csodabogár, aki szeret összeszerelni és feltalálni dolgokat.
一个古怪的工程师，喜欢把所有东西放在一起，捣鼓出一些新玩意儿。

PATTY

A former MTA employee turned ghost-trapper and metaphysical commando.
Früher MTA-Mitarbeiterin, heute Geisterjägerin und metaphysische Kommandantin.
Une ancienne employée du métro qui est devenue chasseuse de fantômes et commando métaphysique.
Una antigua empleada de la MTA convertida en cazadora de fantasmas y comando metafísico.
Uma antiga empregada da Autoridade Metropolitana de Transportes tornou-se uma caçadora de fantasmas e membro de um comando metafísico.
A közlekedési vállalat korábbi alkalmazottja, akiből szellemet csapdába ejtő, metafizikus kommandós lett.
前MTA员工，如今的捉妖人、超自然突击队员。

MAYHEM

An entity from another dimension who likes to have fun.
Ein Wesen aus einer anderen Dimension, das Spaß haben will.
Une entité d'une autre dimension qui aime s'amuser.
Una entidad de otra dimensión a la que le gusta la diversión.
Uma entidade de outra dimensão que adora divertir-se.
Lény egy másik dimenzióból, aki kedveli a tréfát.
一个来自另一维度的人，喜欢乐趣。

KEVIN

An unemployed actor from a small town outside of Sydney.
Ein arbeitsloser Schauspieler aus einer Kleinstadt außerhalb Sydneys.
Un acteur au chômage venu d'une petite ville près de Sydney.
Un actor sin empleo procedente de una pequeña ciudad a las afueras de Sidney.
Um ator desempregado de uma pequena cidade dos arredores de Sydney.
Egy munka nélküli színész, aki egy Sydneyhez közeli városkából származik.
一个失业演员，来自悉尼城外的小镇。

CONFIDENTIAL

VERTRAULICH
CONFIDENTIEL
CONFIDENCIAL
BIZALMAS
机密

DANGER
VORSICHT
DANGER !
PELIGRO
PERIGO
VIGYÁZAT!
危险

1



2



3



4



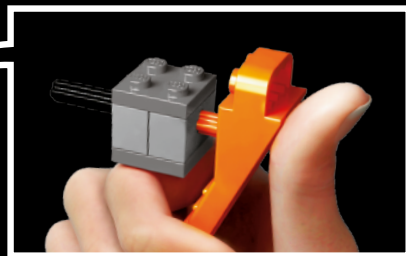
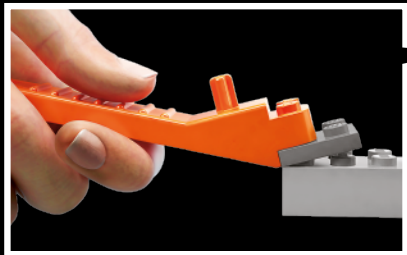
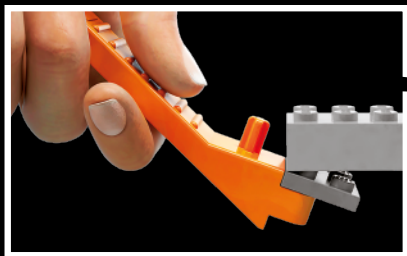

LEGO.com/brickseparator

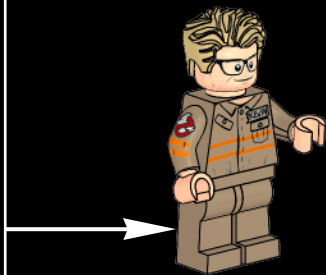
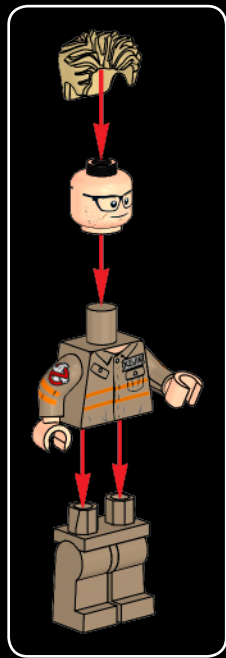
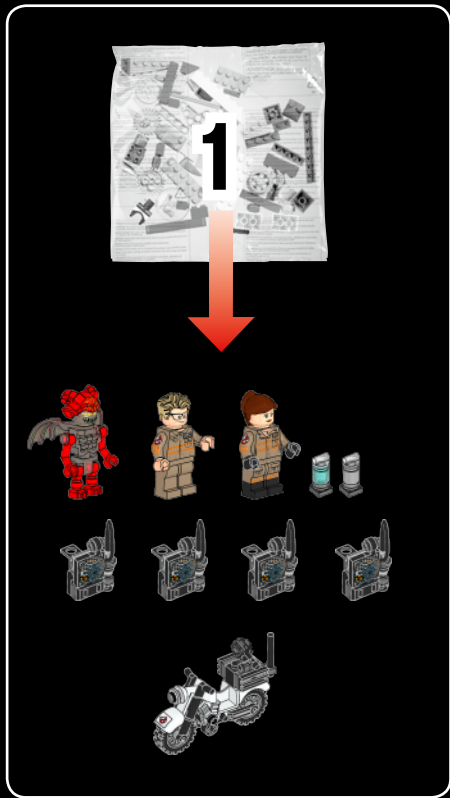

1

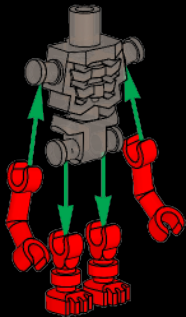

2

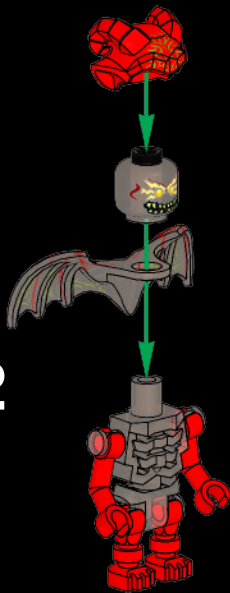

3





4x



1x



1x

1

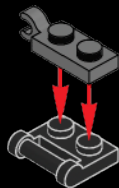

1x

2

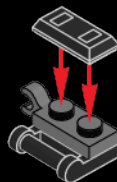



3

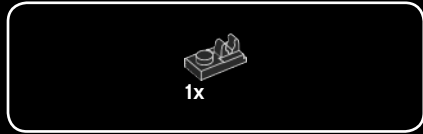
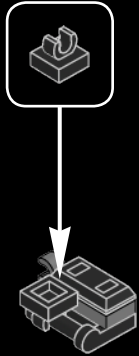

4

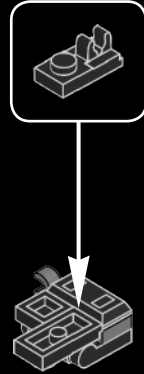



1x

5



1x

6

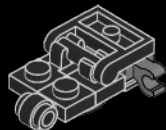



7

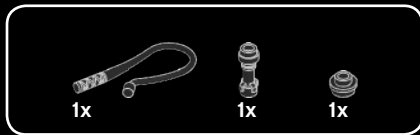
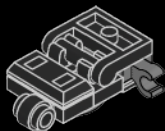

8

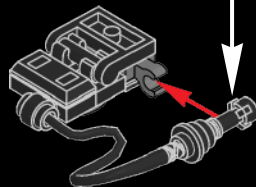
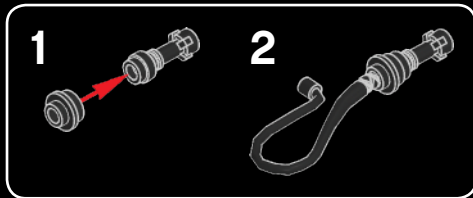



1x



1x

9

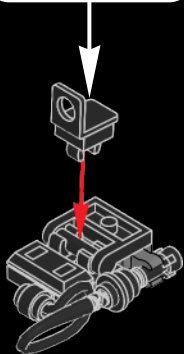
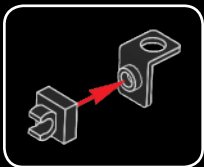

4x



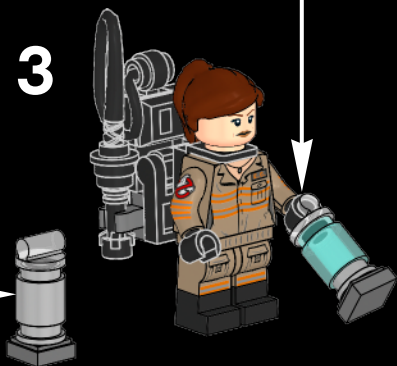
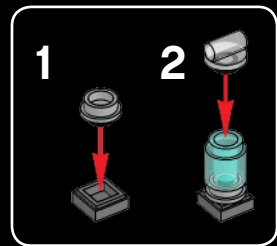
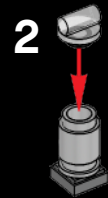
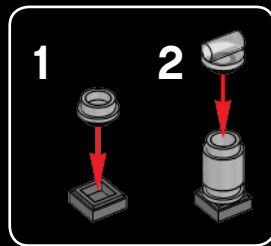
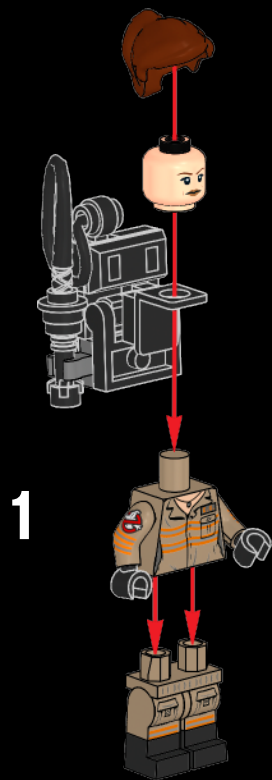

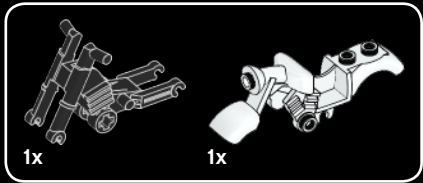
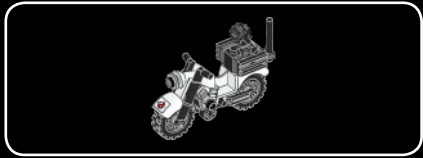

1

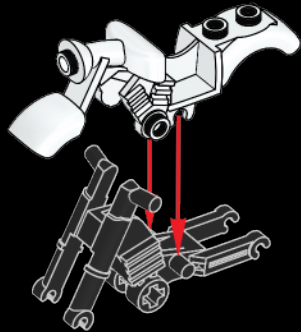

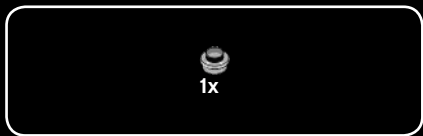

2

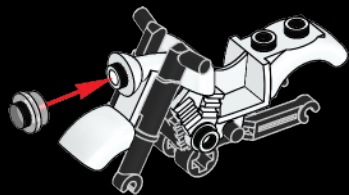

3

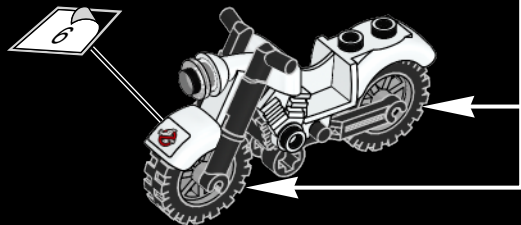

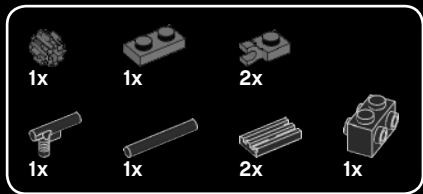

4

1

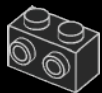

2

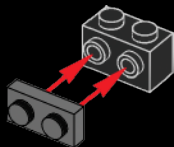

3

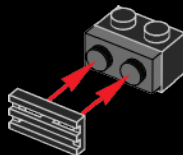

4

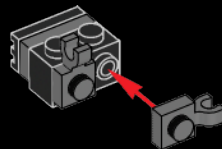

5

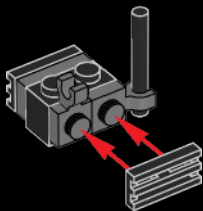

6

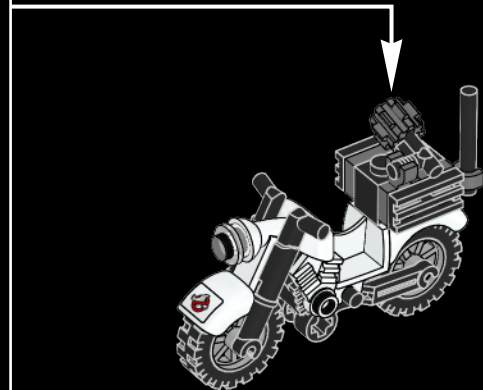
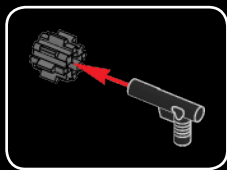
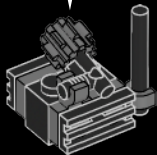

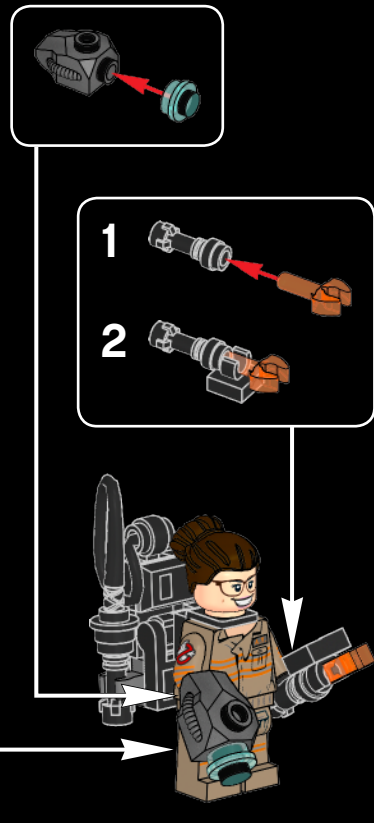
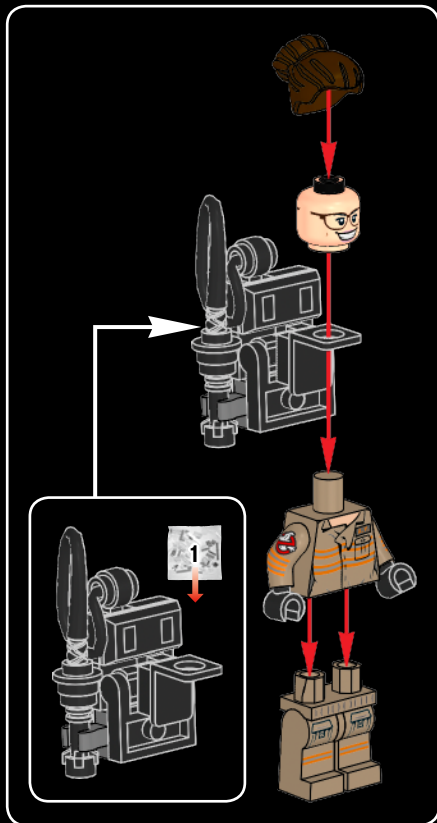
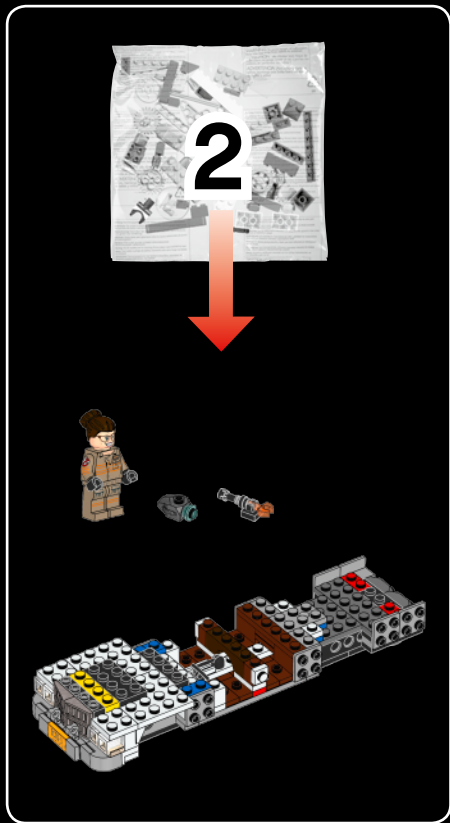

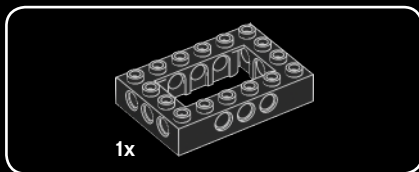
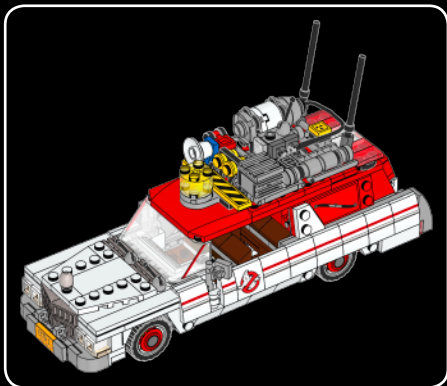

1

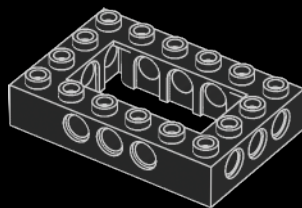



2x

2

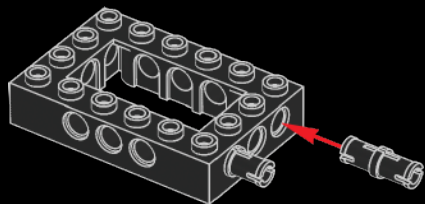

1x

3

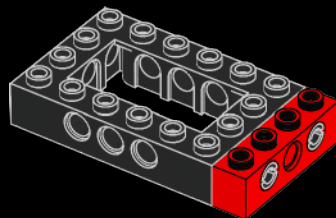

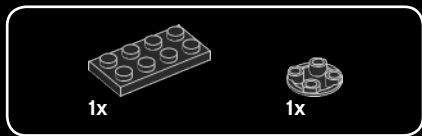

4

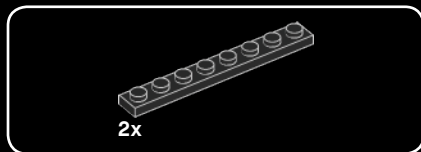
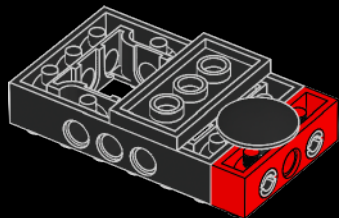
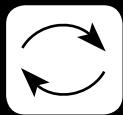

5

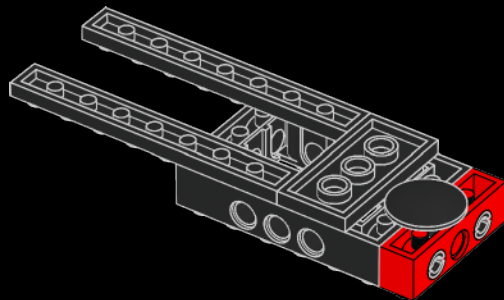



2x

6

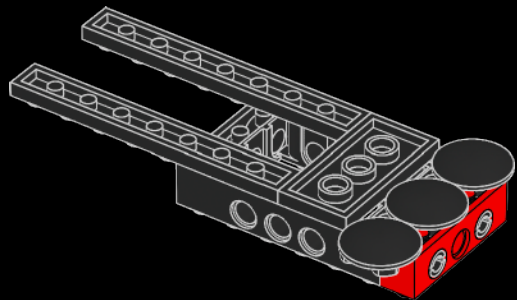

1x

7

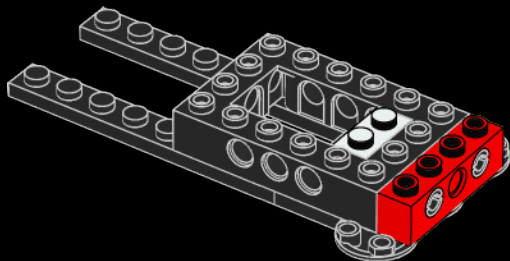

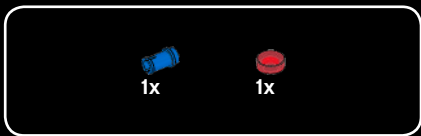

8

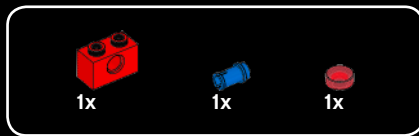
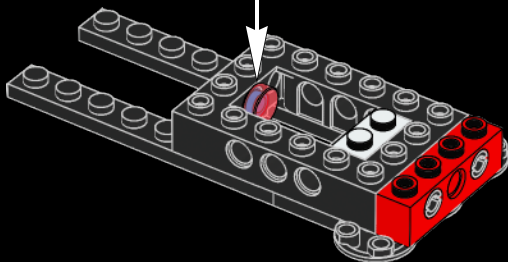
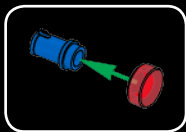

9

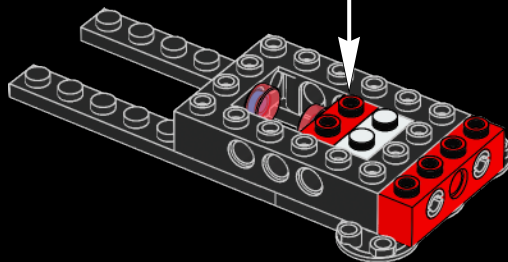
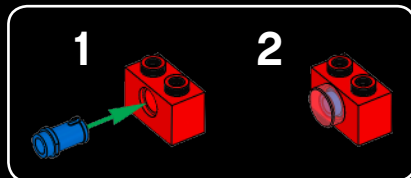



1x

10

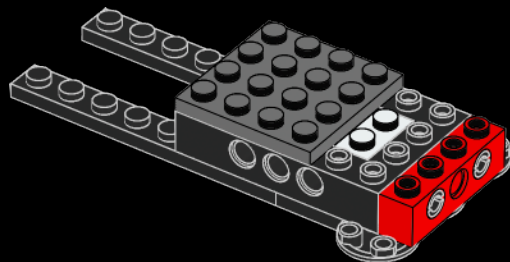

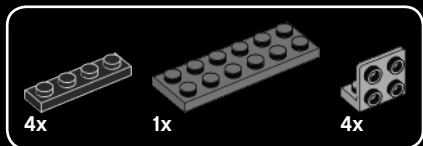

11

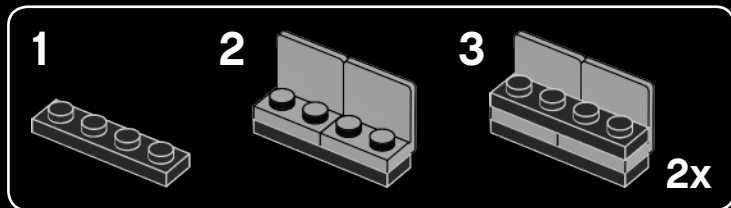

1

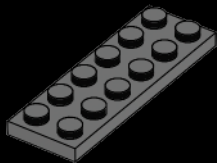

2

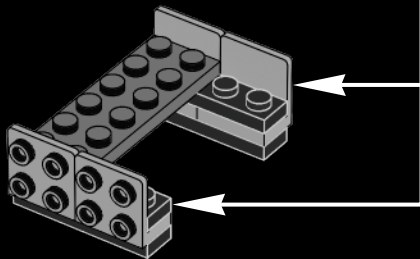

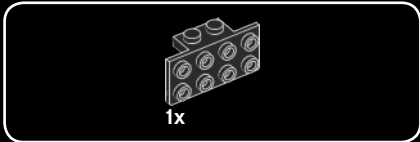

12

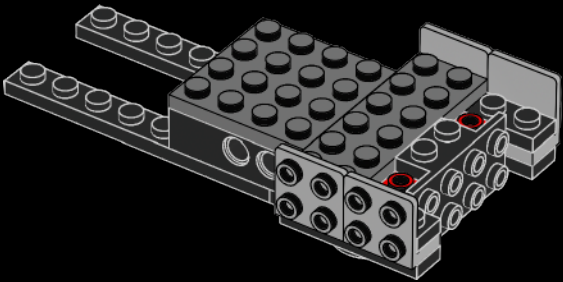
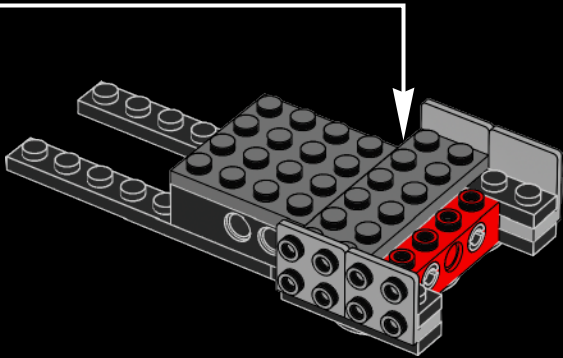



2x



2x

13

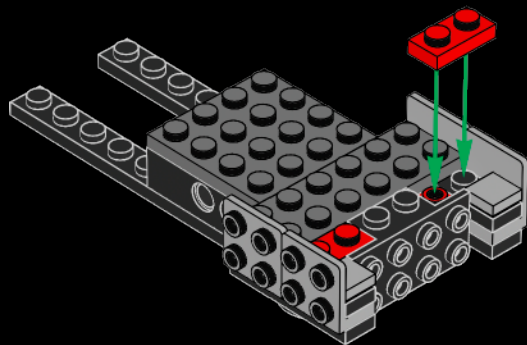

2x

14

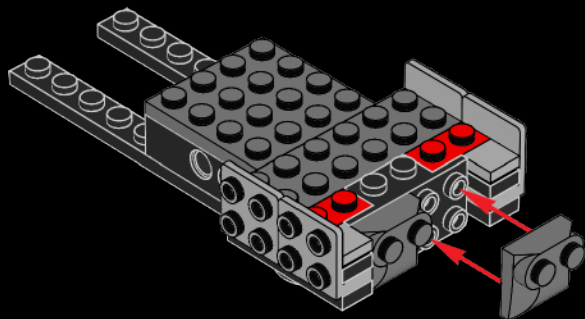



2x

15

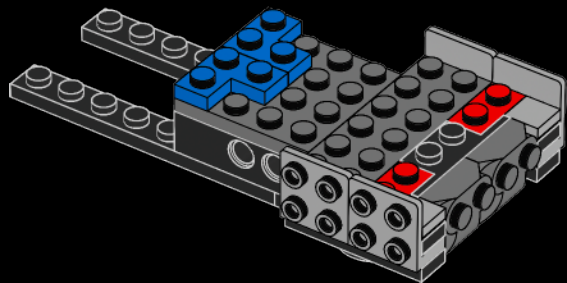

2x

16

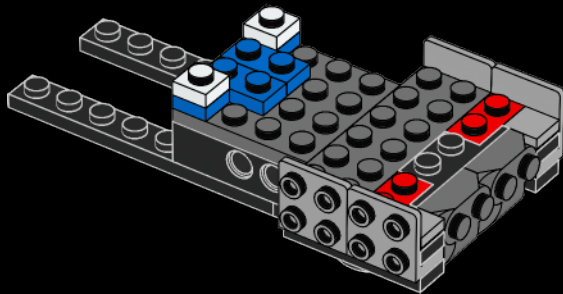

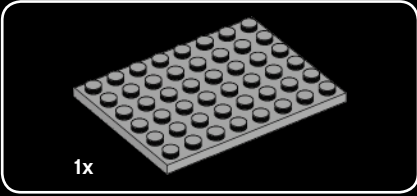
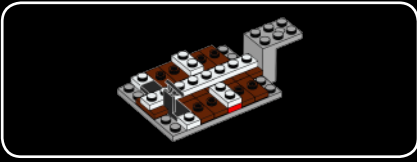

17

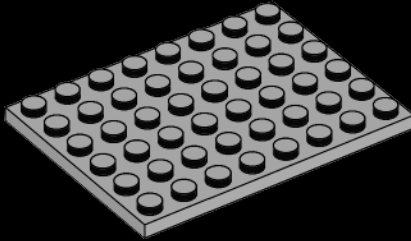

18

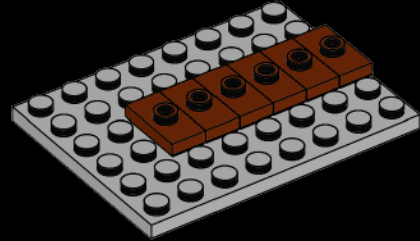



2x



4x

19

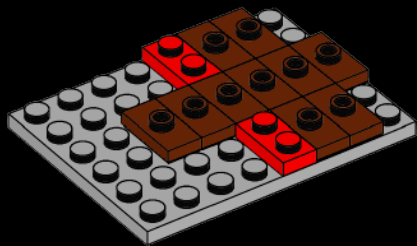

2x



4x

20

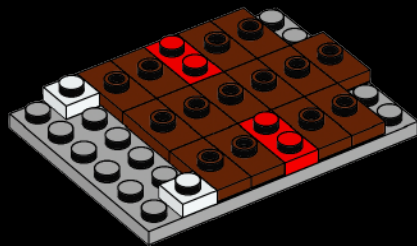

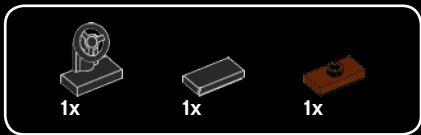

21

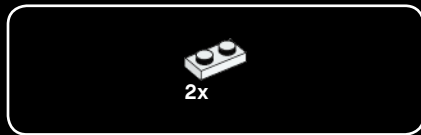
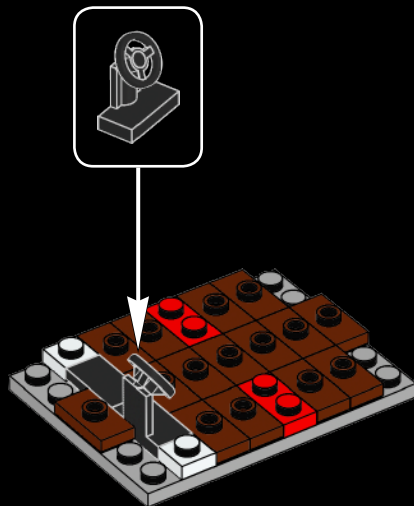

22

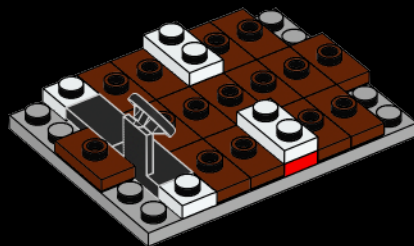

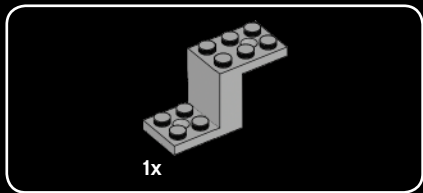

23

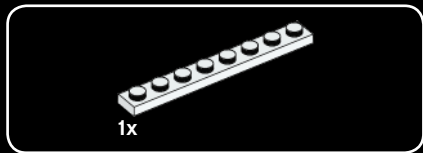
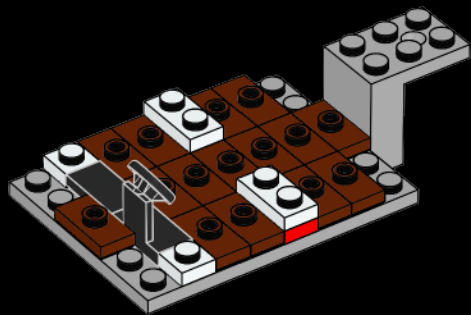

24

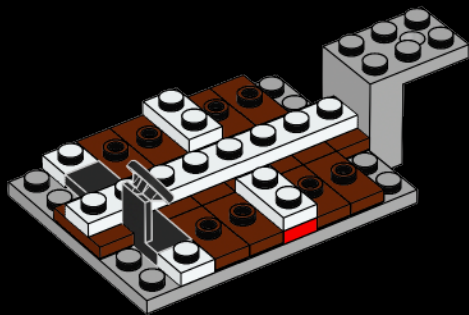

25

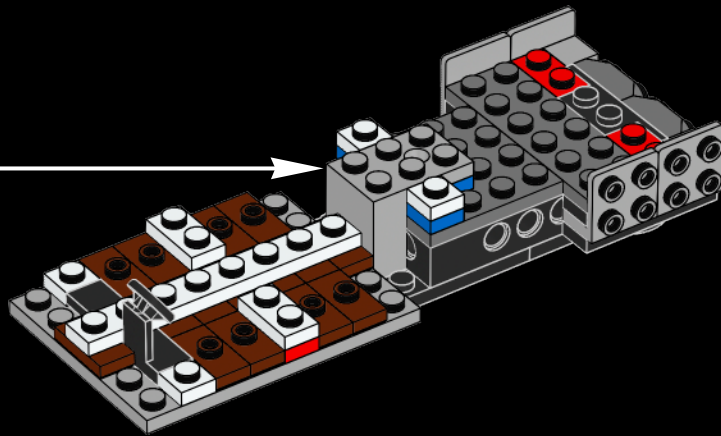



2x

26

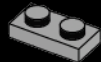

2x

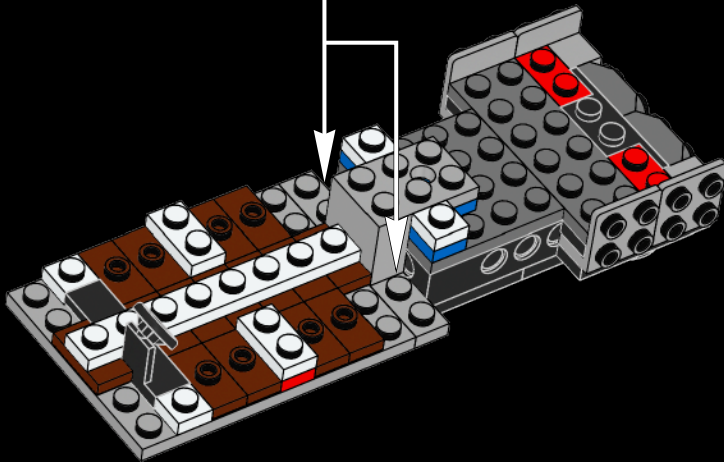



27

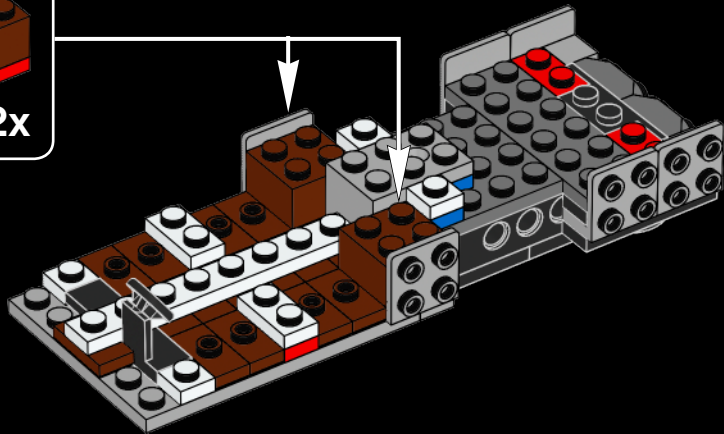
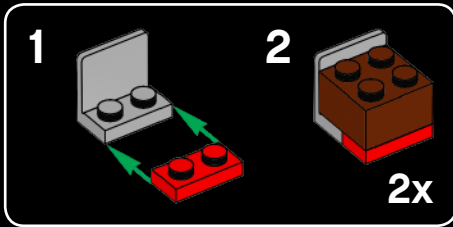



2x

28

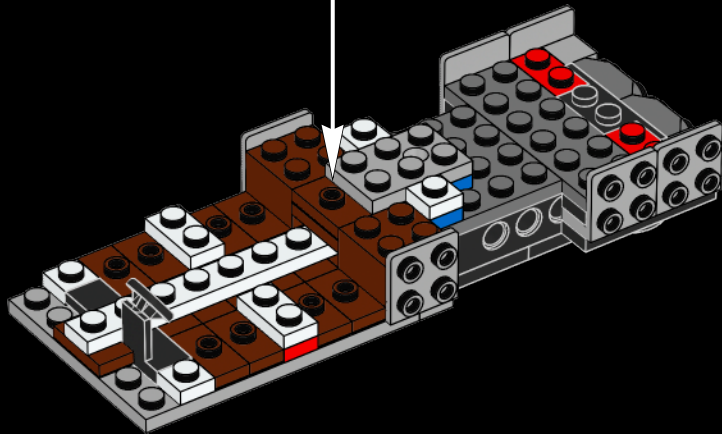
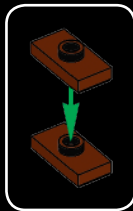

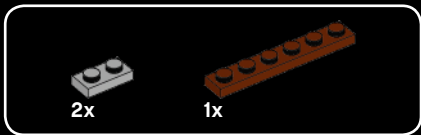

29

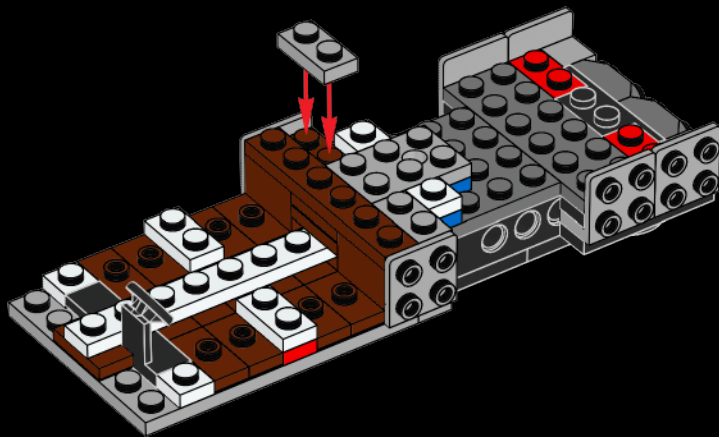



4x

31

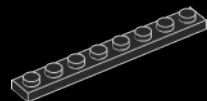
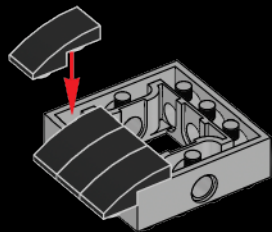

2x

32

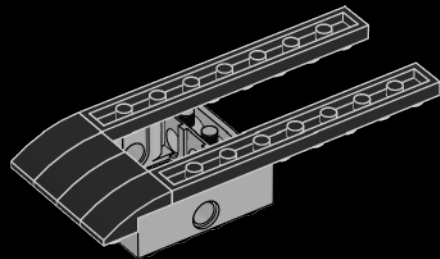

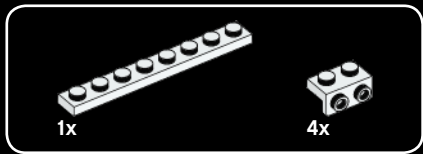

33

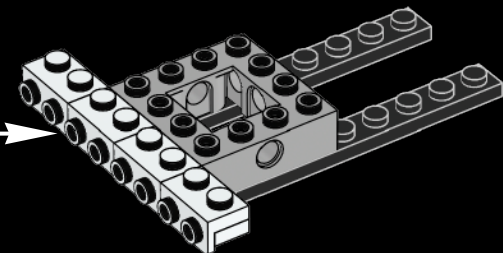
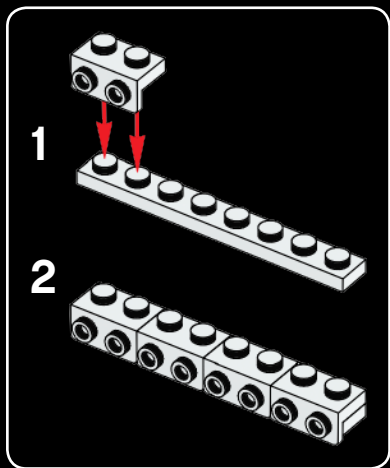



34

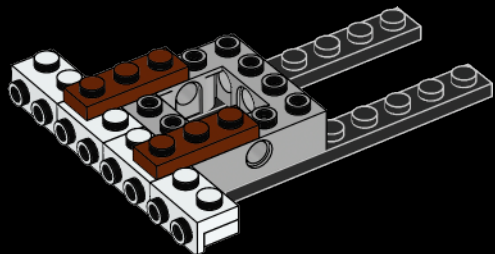

35

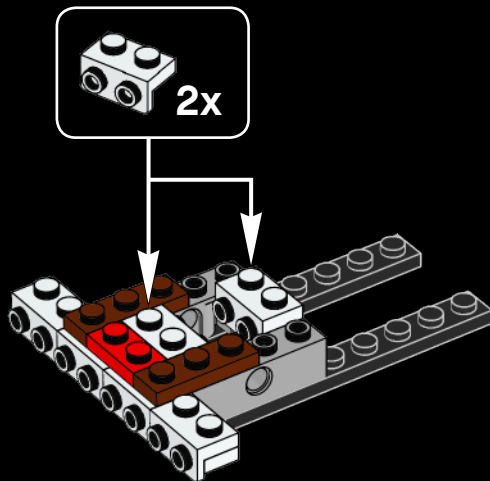



1x

36

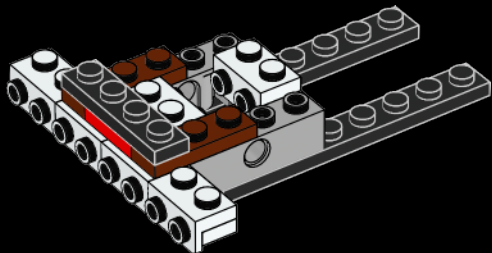

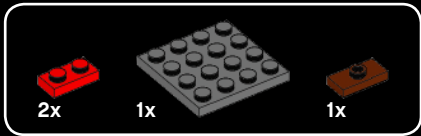

37

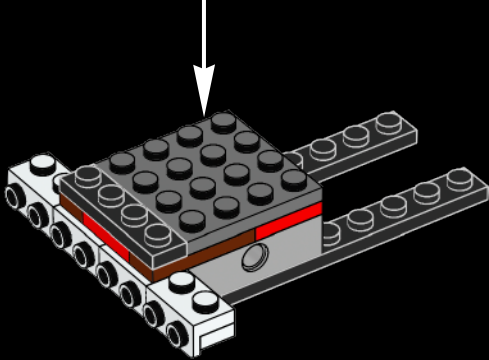
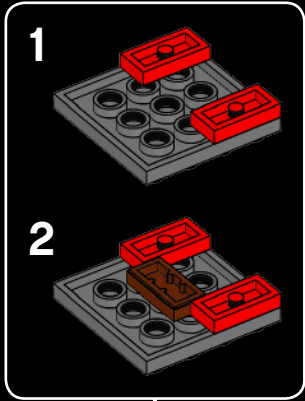

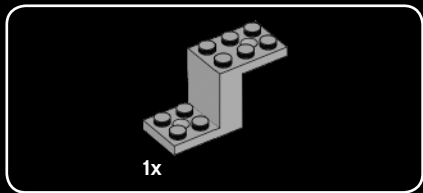

38

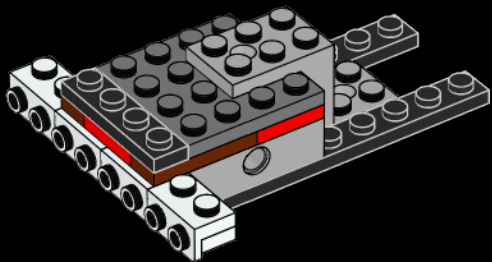



39

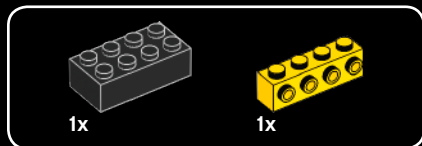
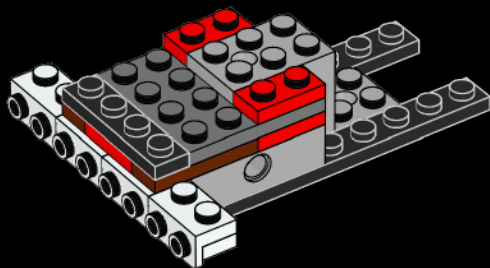

40

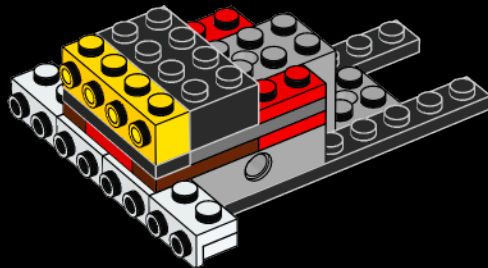

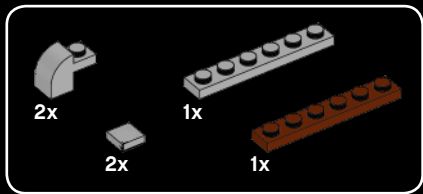

41

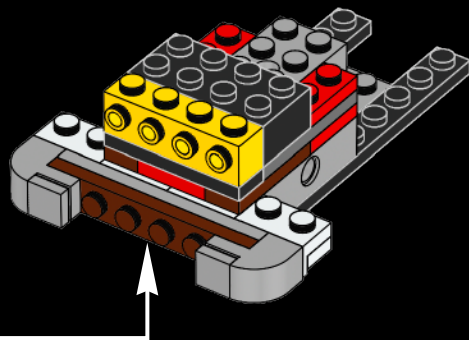
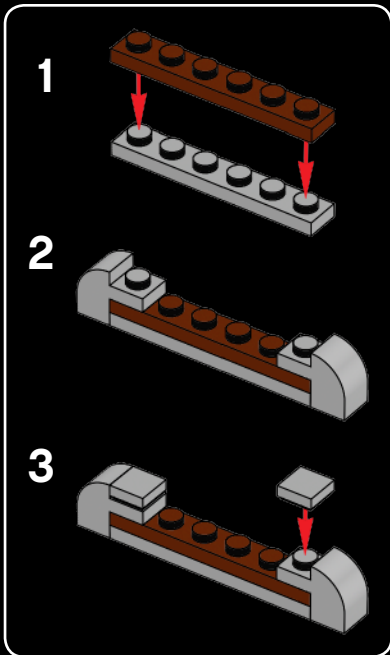



1x



2x



4x

42

1

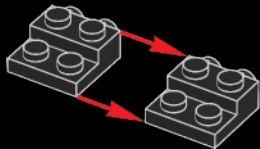

2

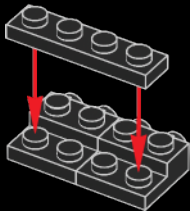

3

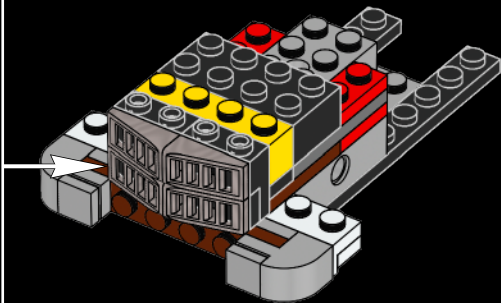
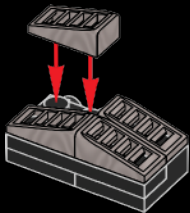

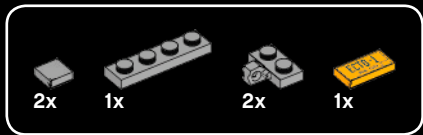

43

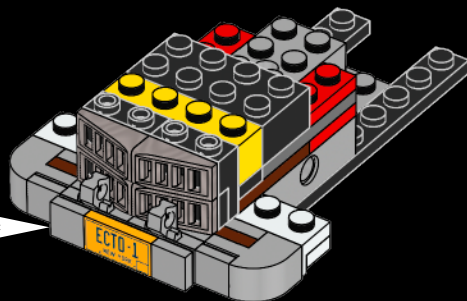
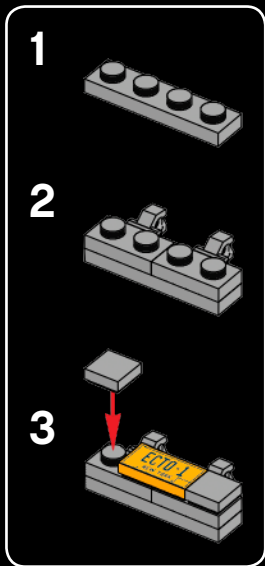

44

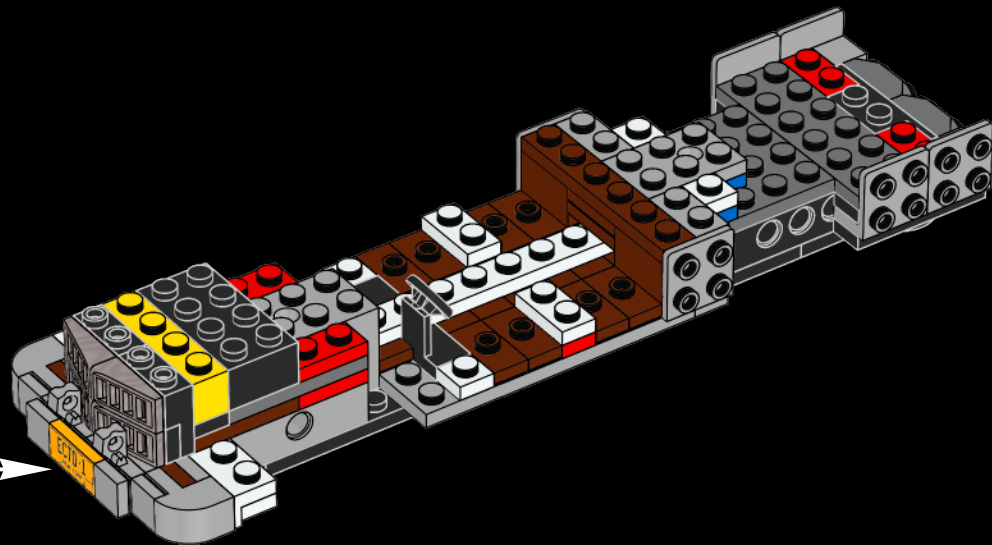



2x

45



2x

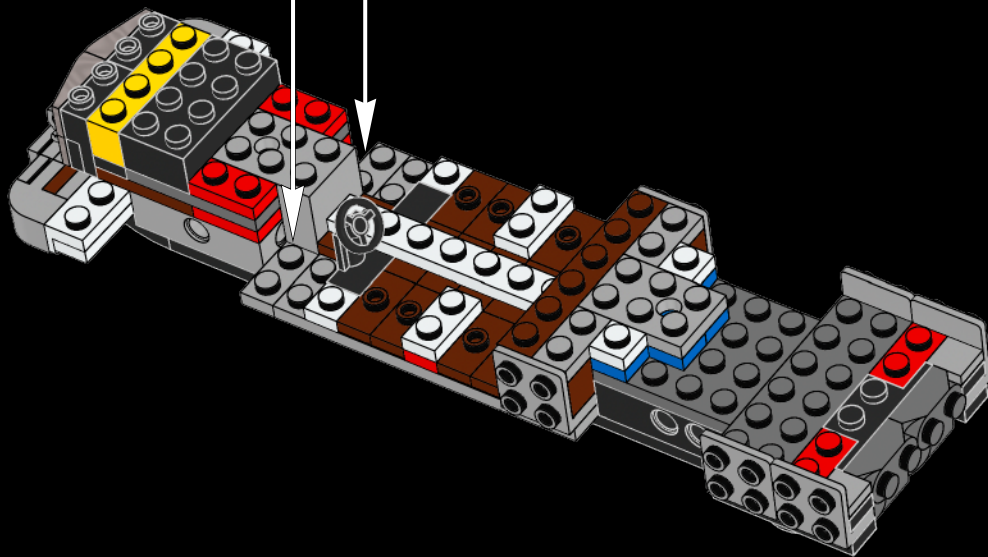



2x

46

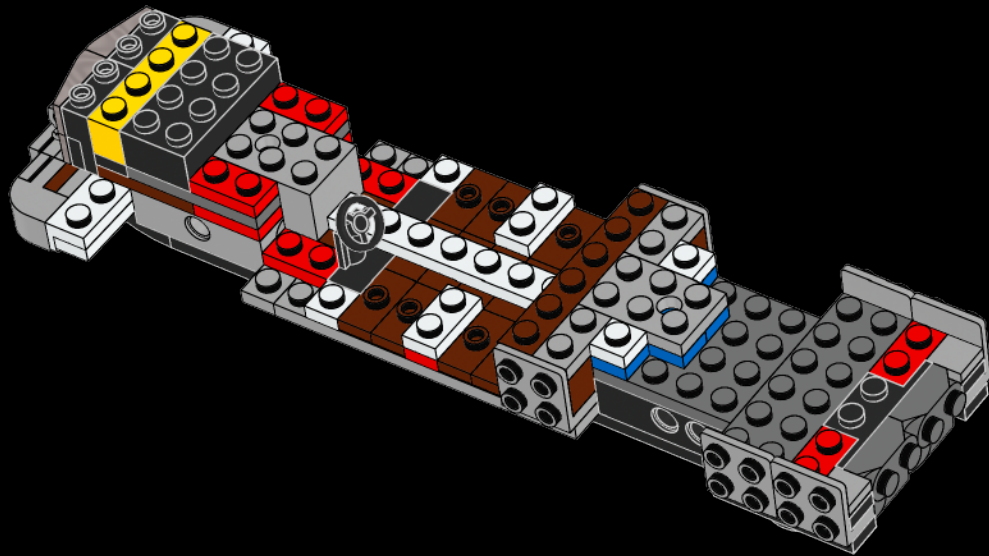



2x

47

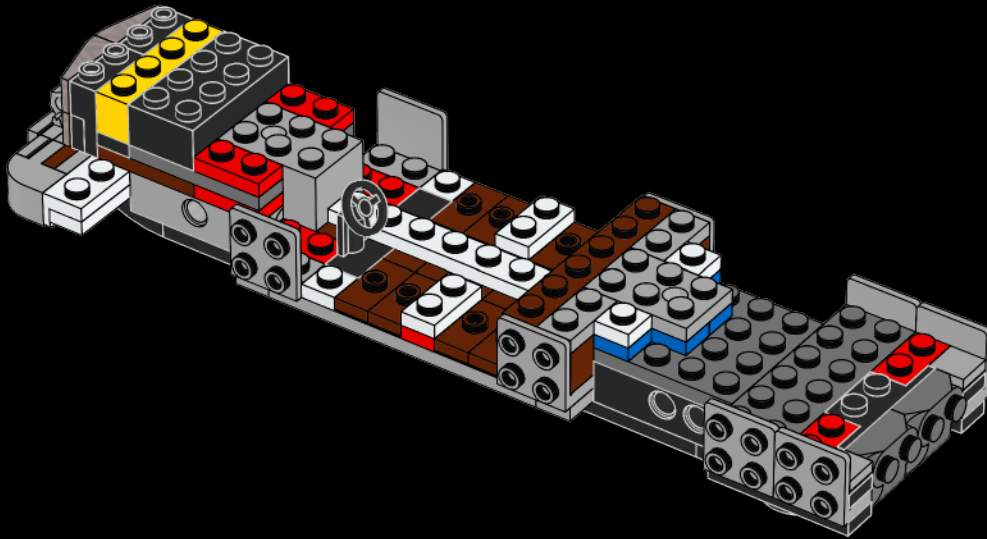



2x



2x

48

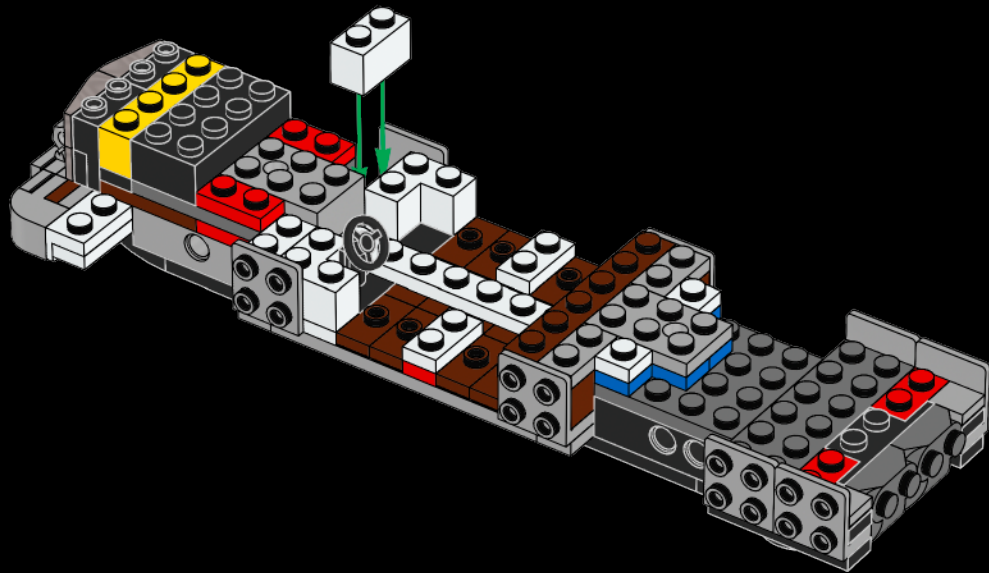



2x

49

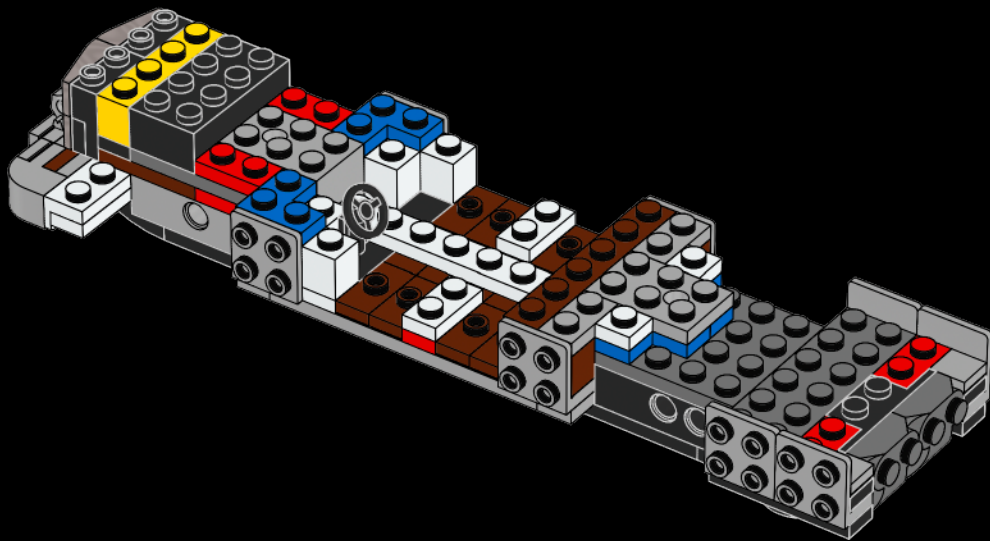



1x



1x

50

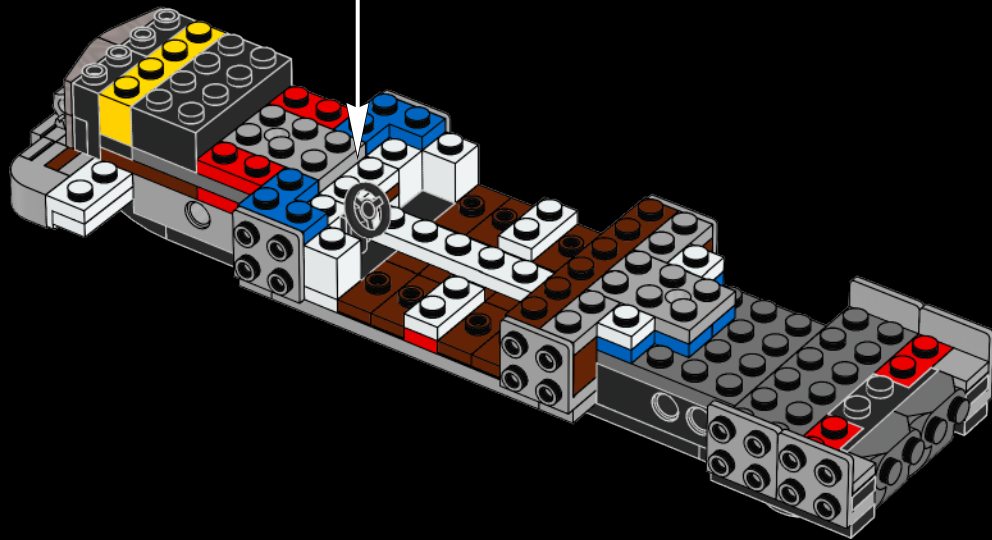
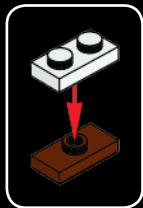



1x



1x

51

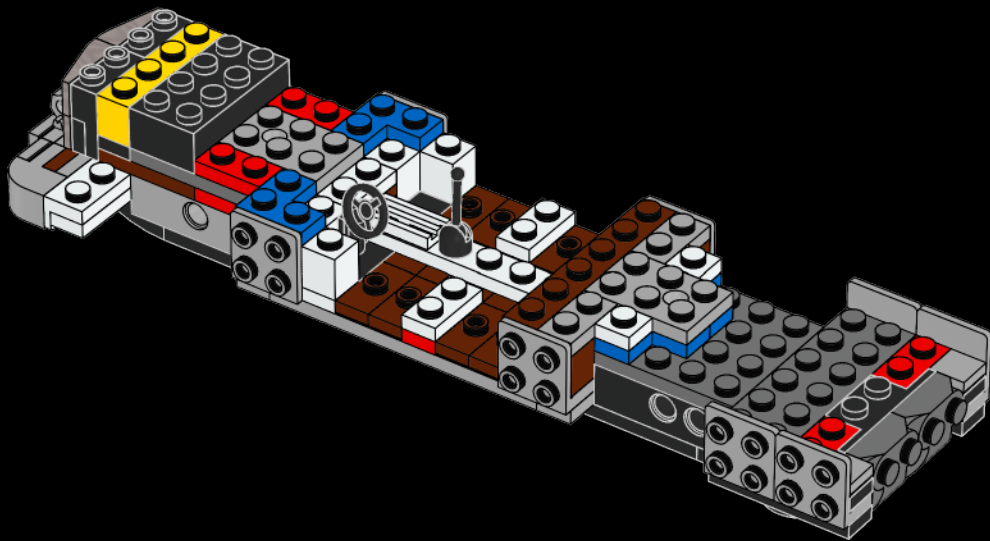



52

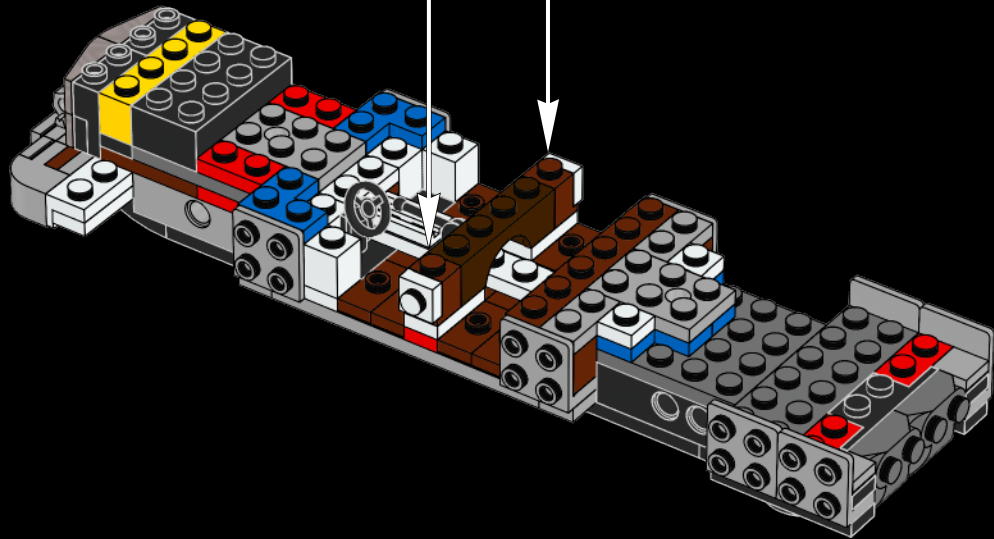
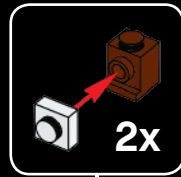



2x



2x



4x



4x



2x



2x

53

1

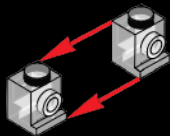

2

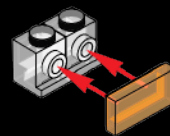

3



1

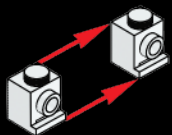

2

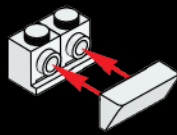

3

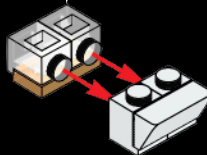

4

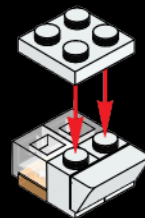

2x

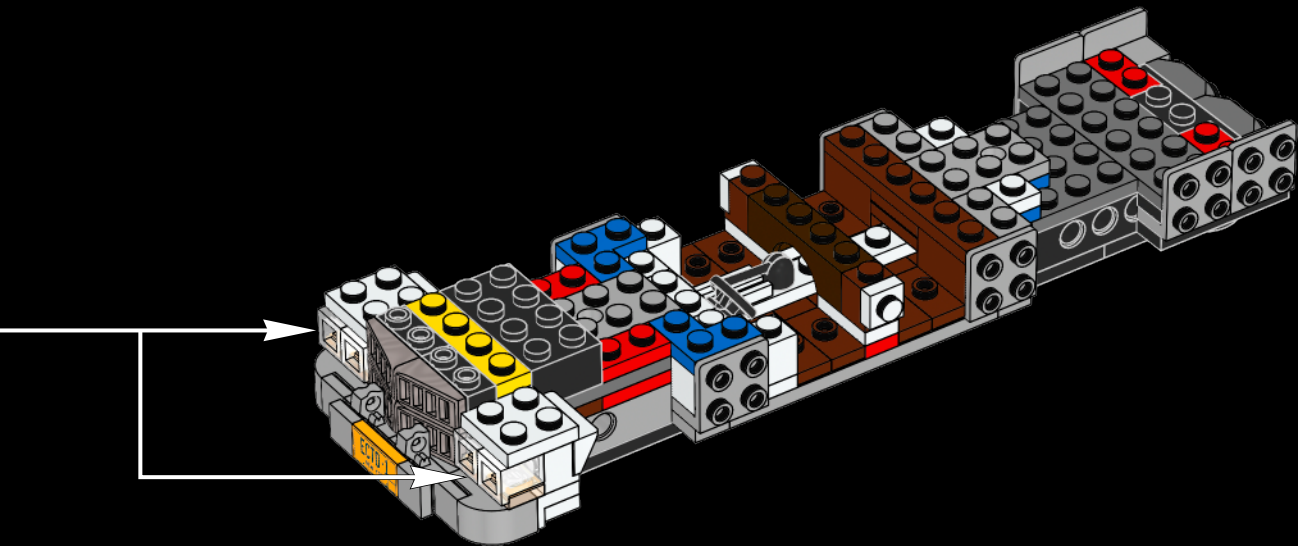



1x



2x

54

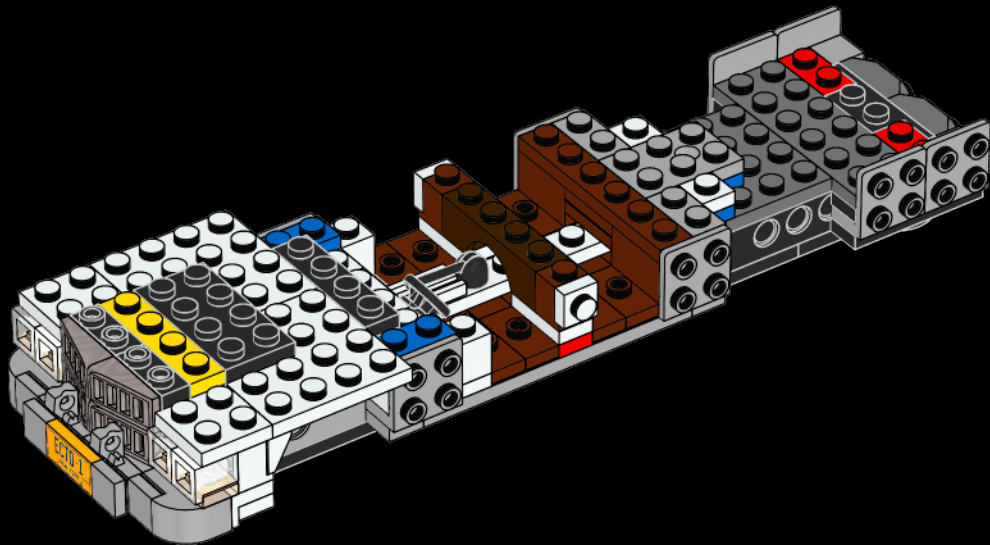

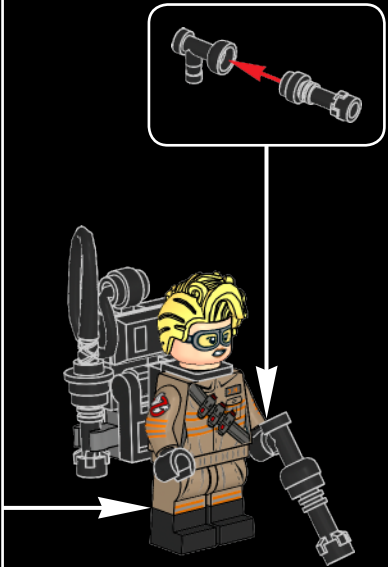
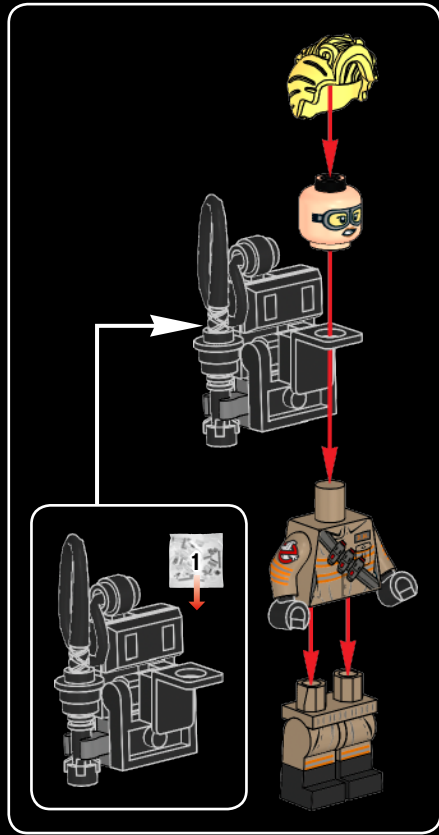
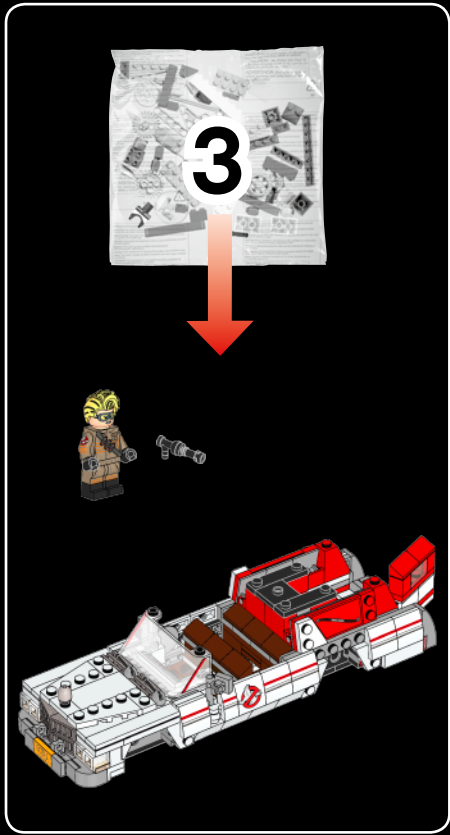



2x

55

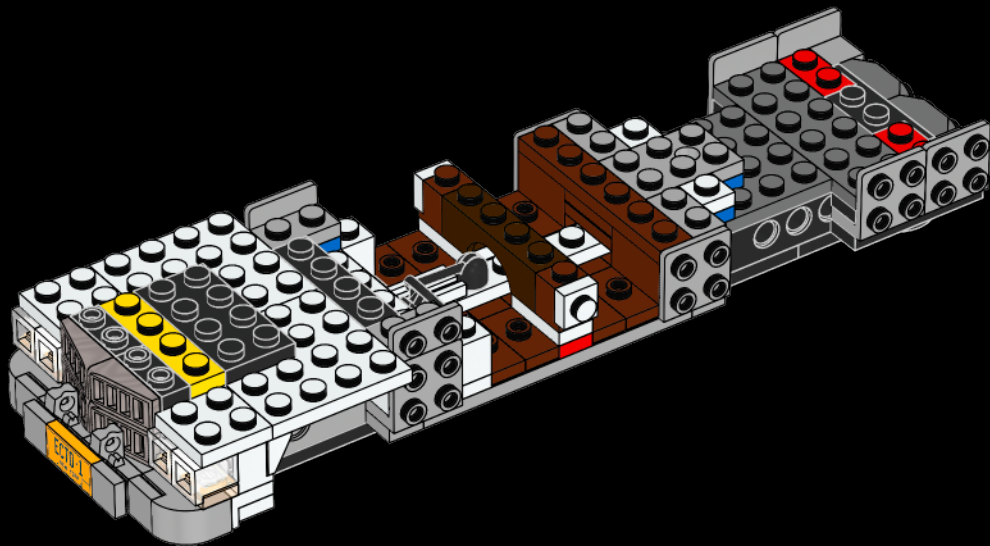



2x



2x

56

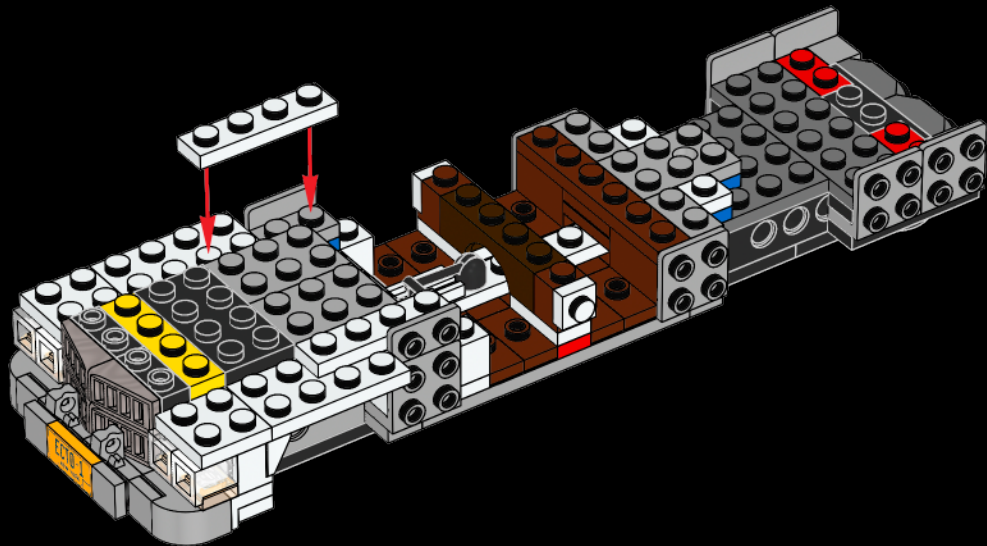

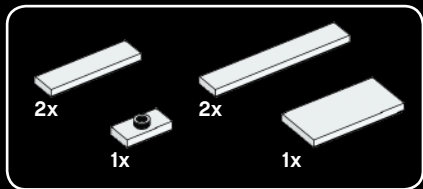

57

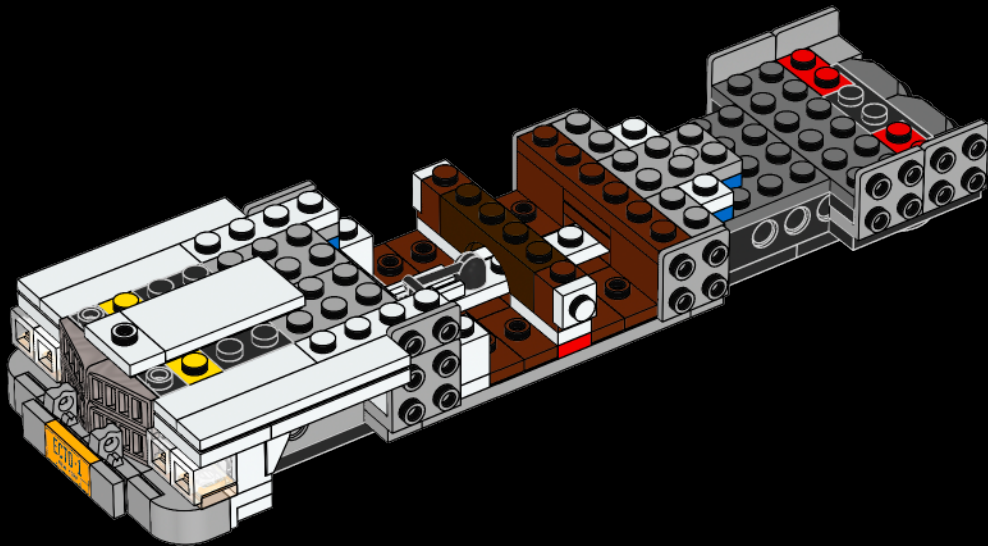

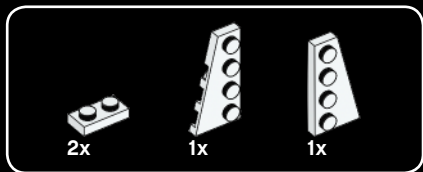

58

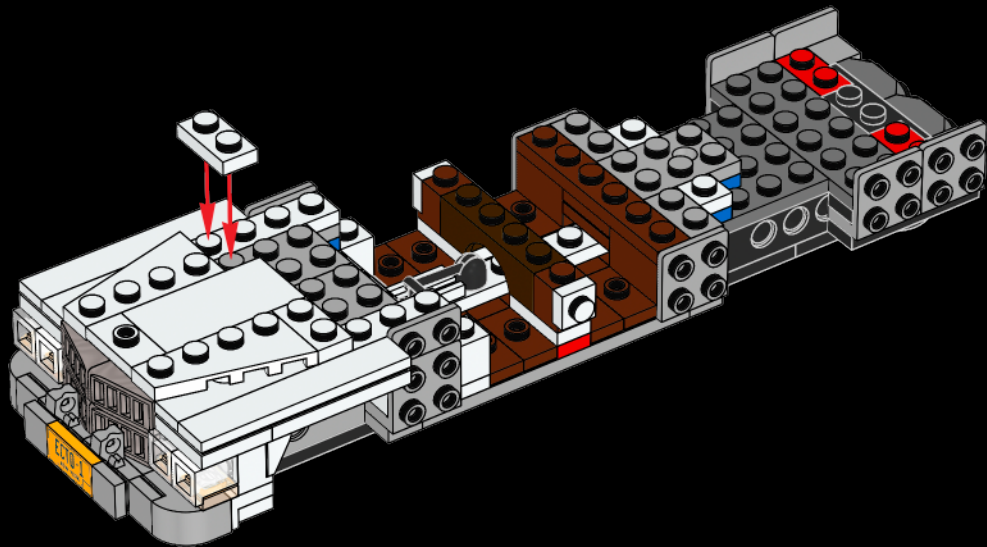



2x



1x



2x

59

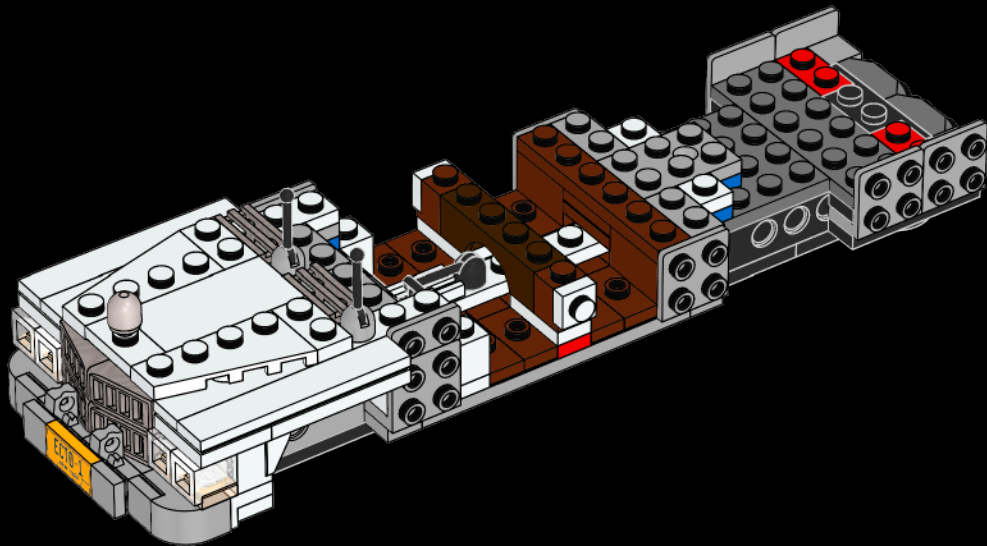

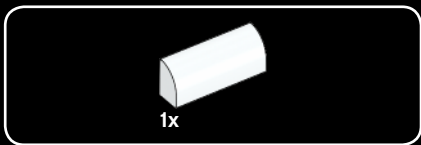

60

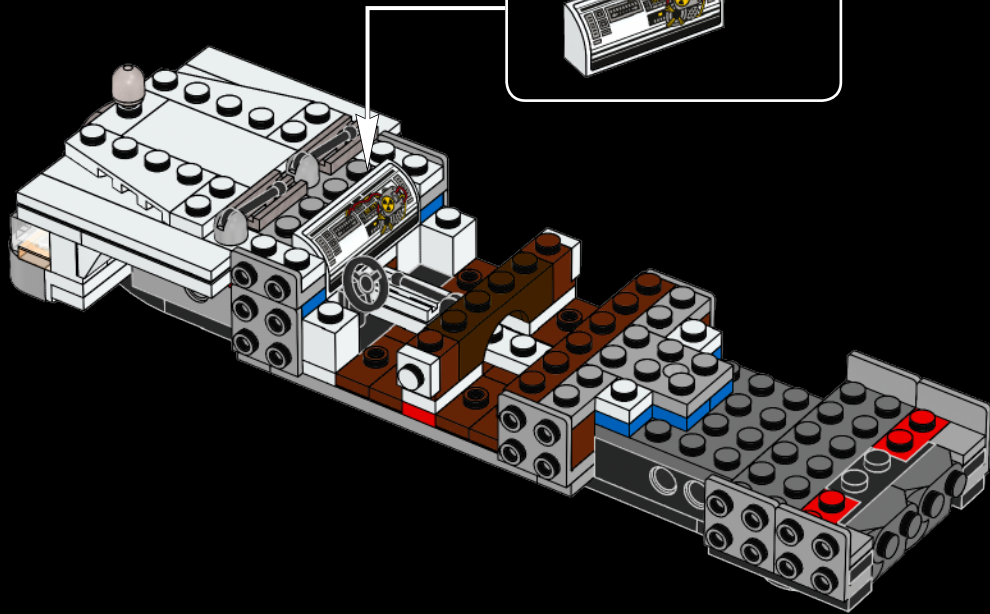
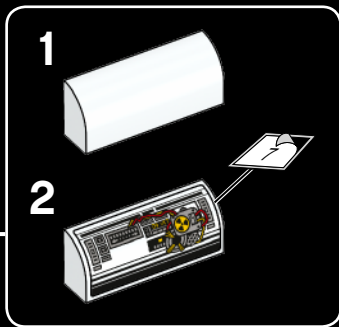

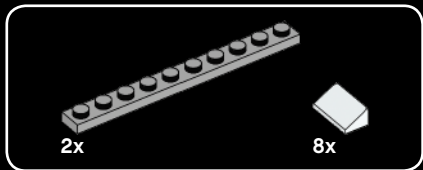

61

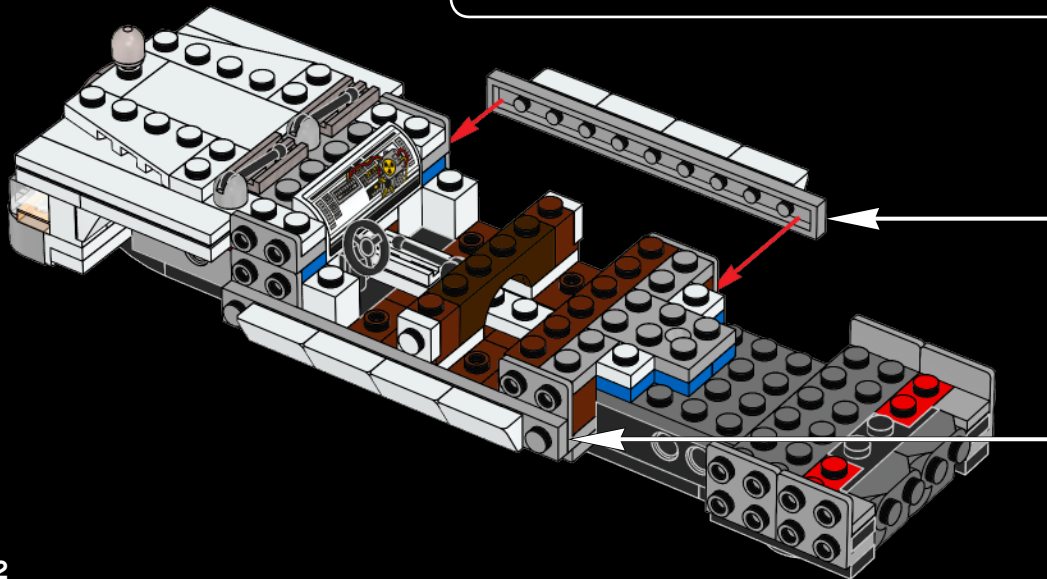
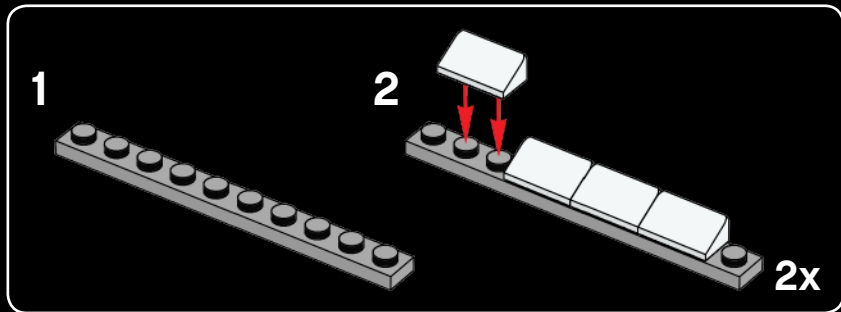

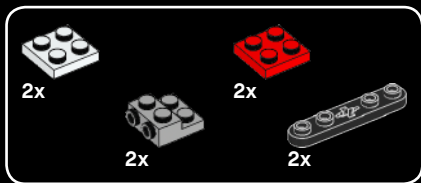

62

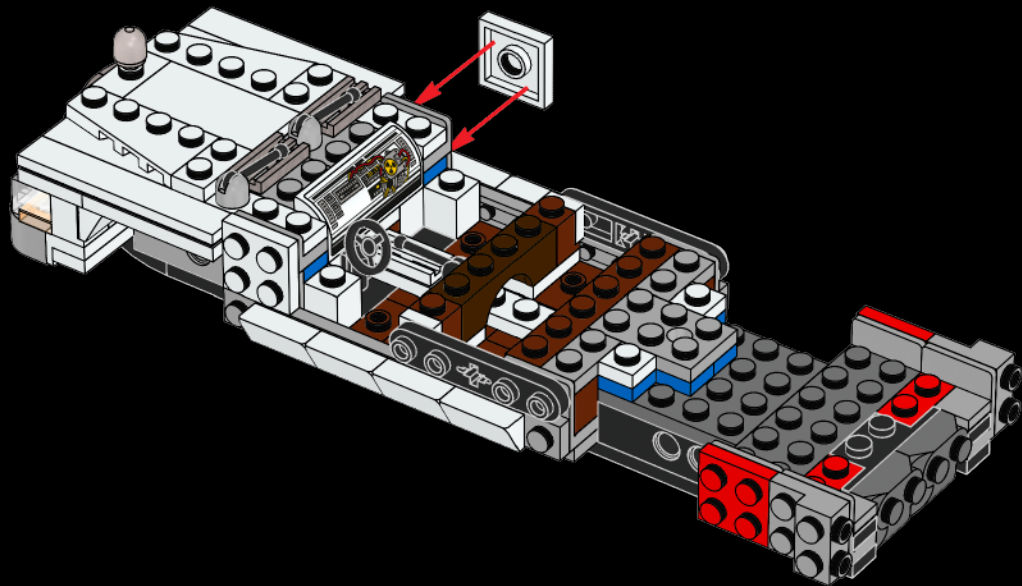

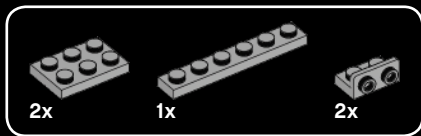

63

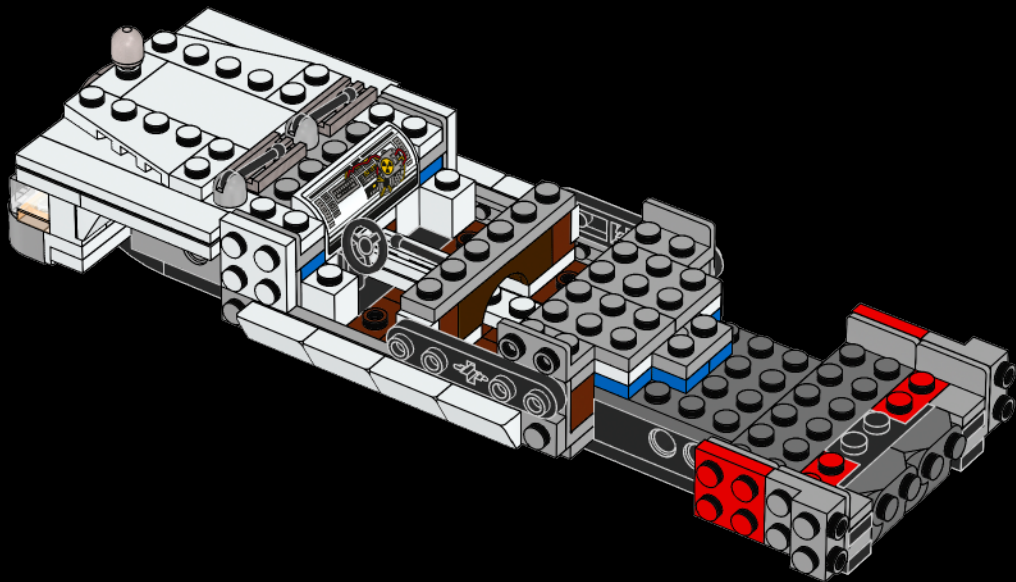

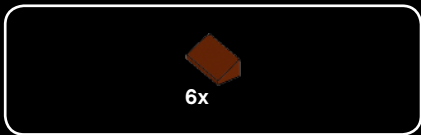

64

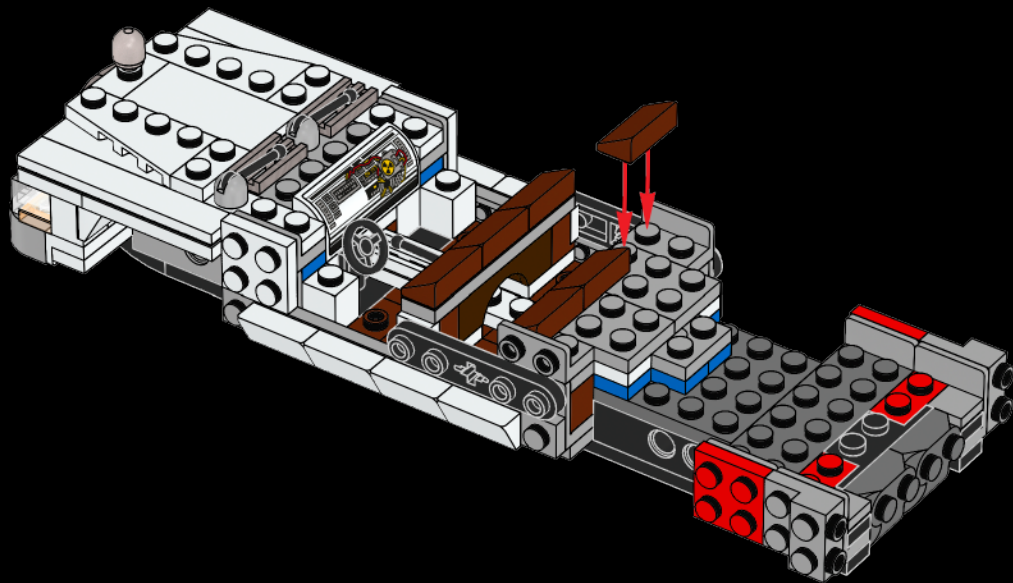



2x

65

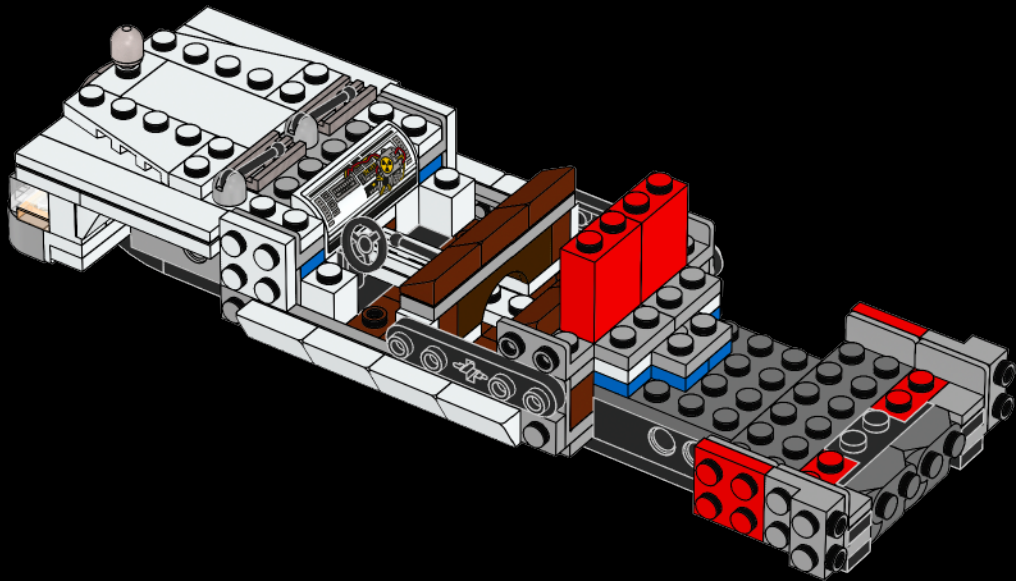

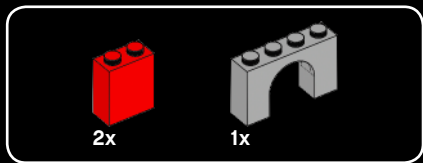

66

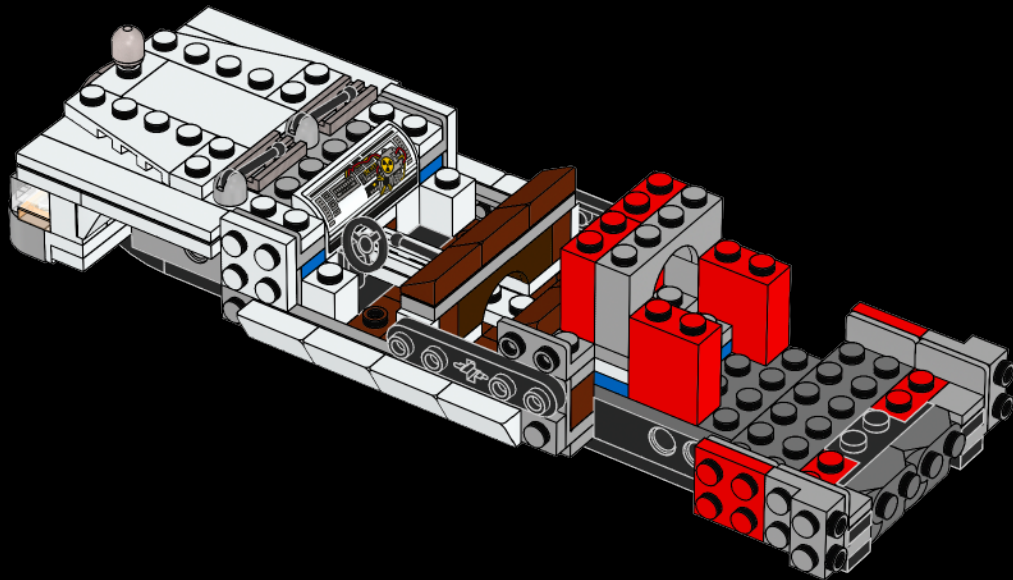

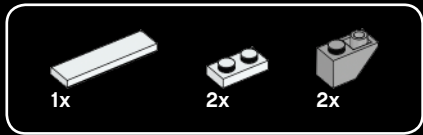

67

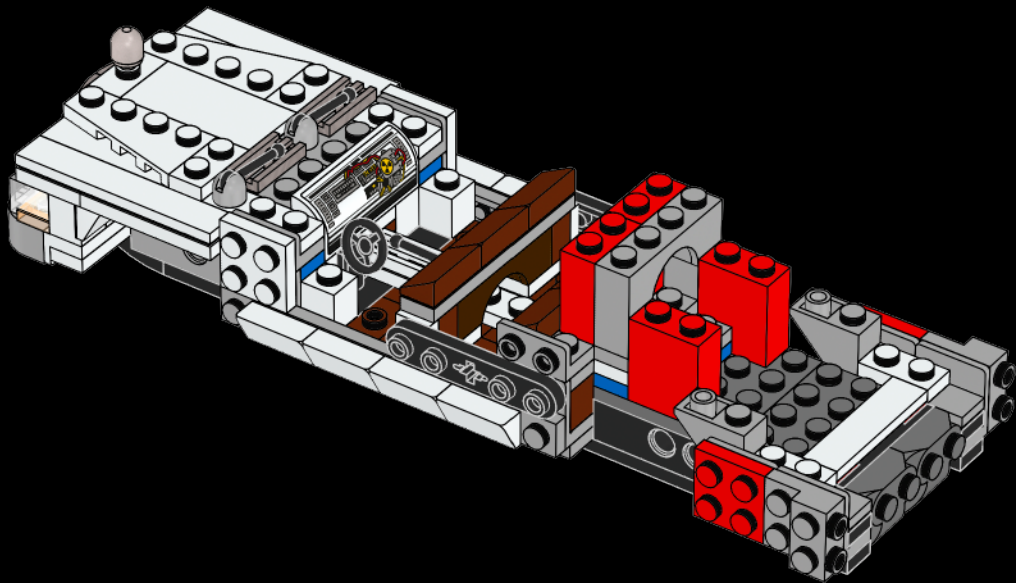



68

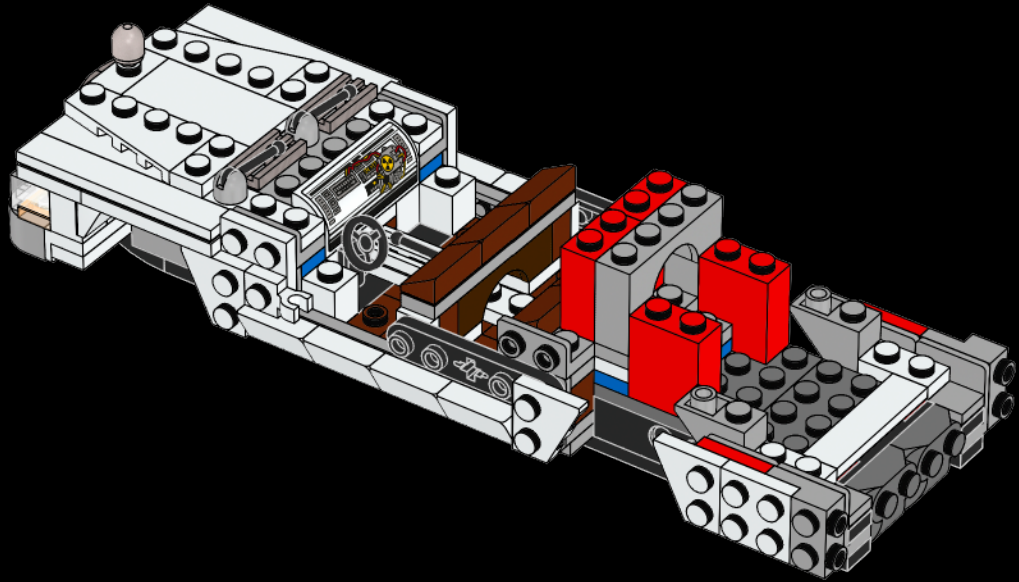

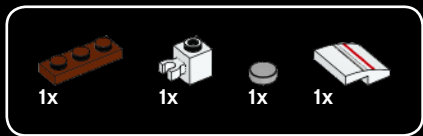

69

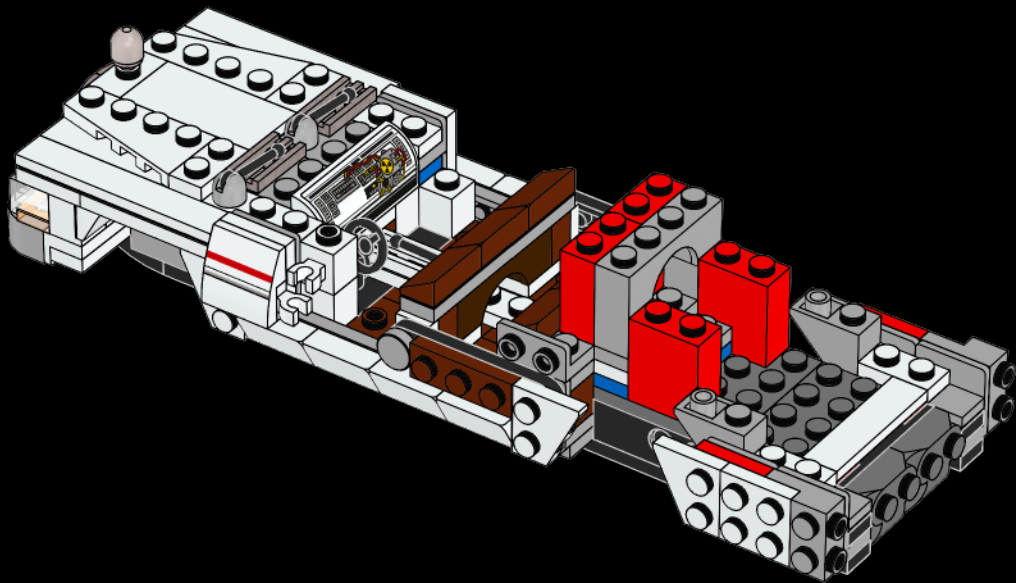



1x



1x

70

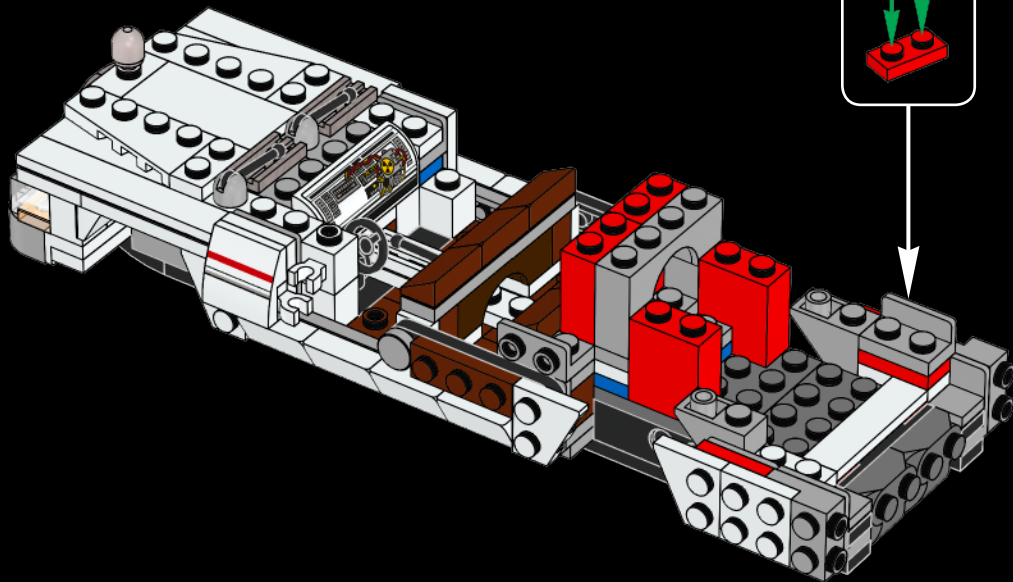

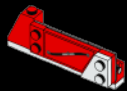

1x

71

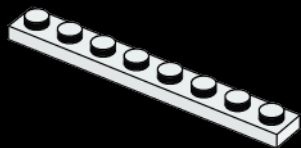

3x

72

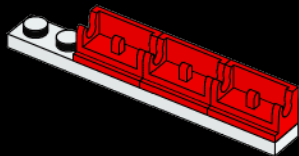



1x

75

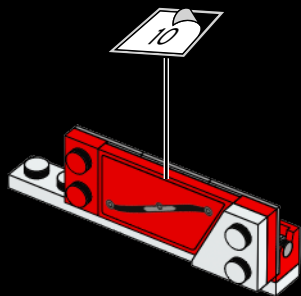

1x

76

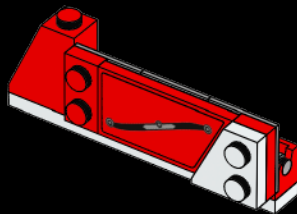

77

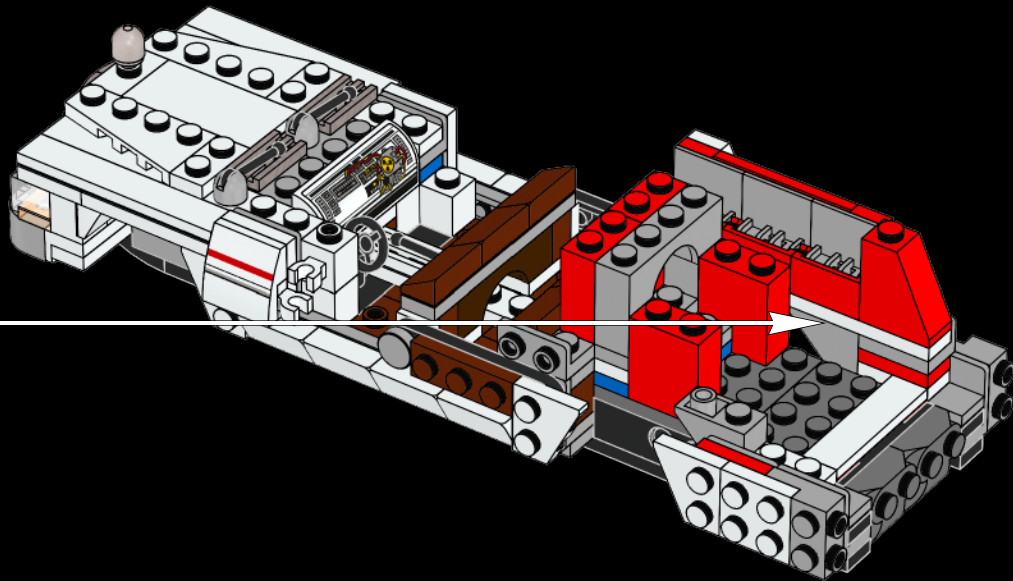



1x

78

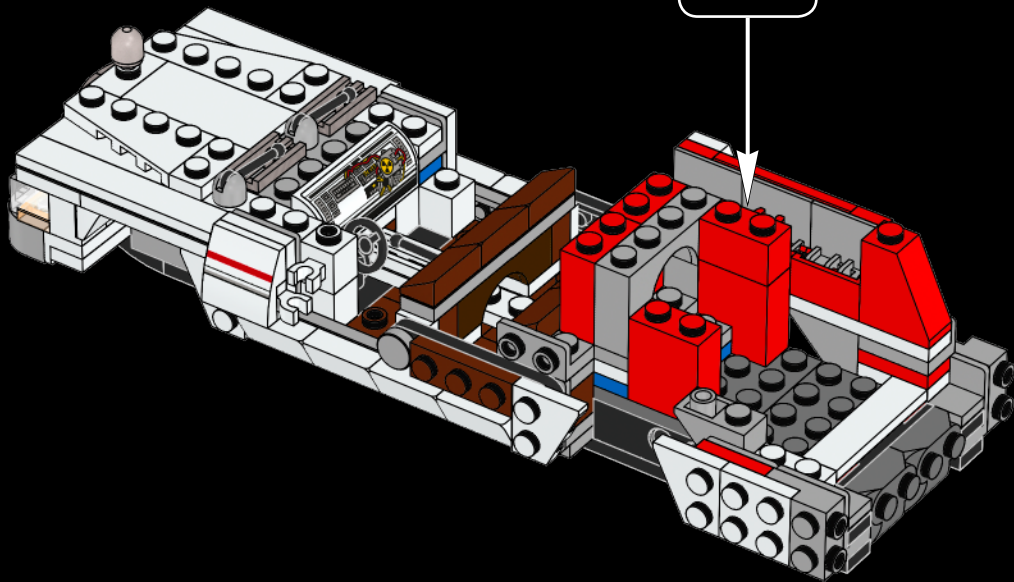

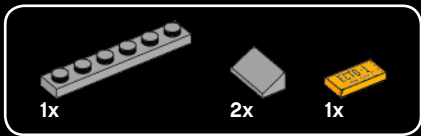

79

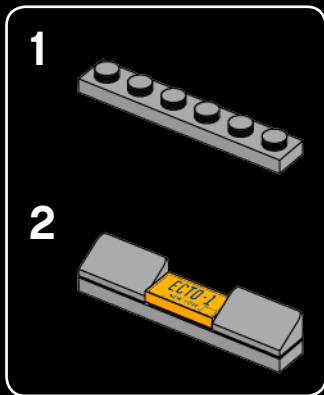
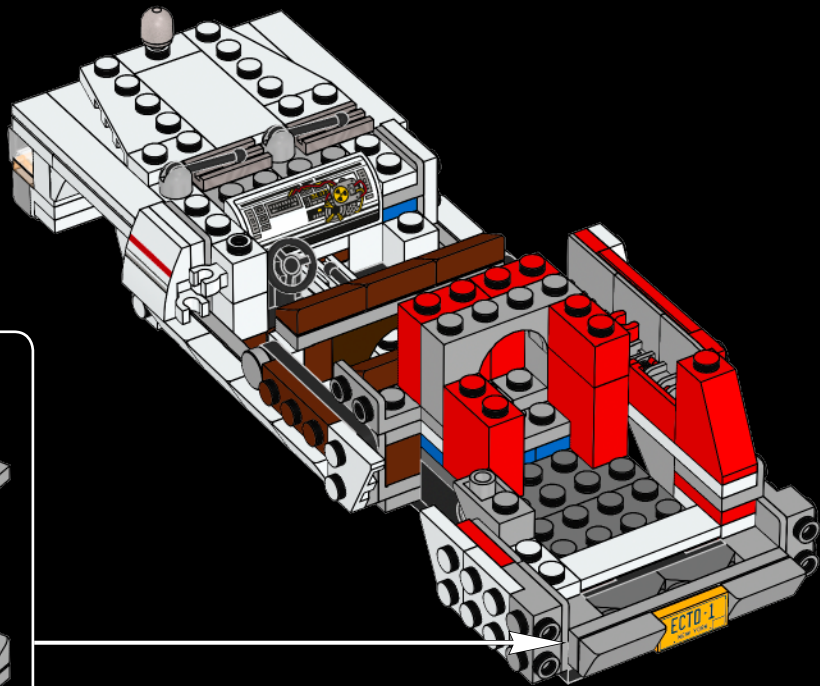



2x



2x

80

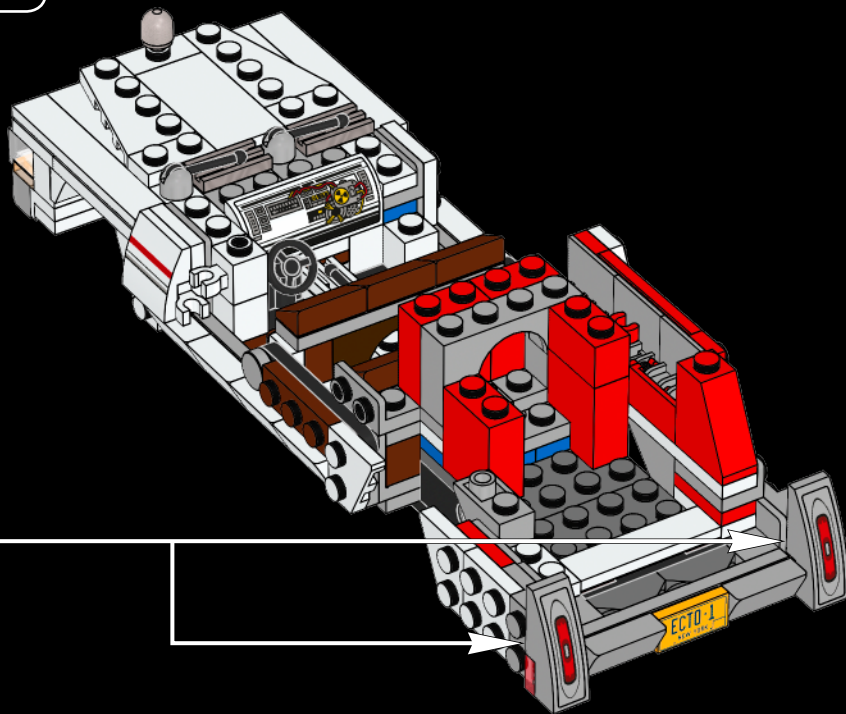

1

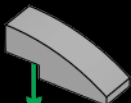

2

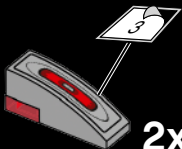

2x

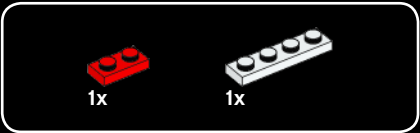

81

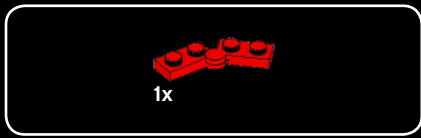
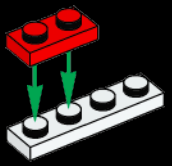

1x

82





2x

83

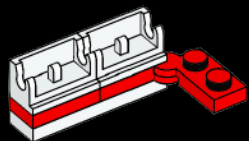

2x

84

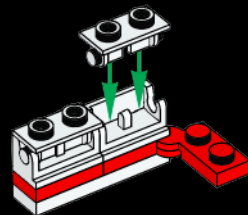



1x



1x

85

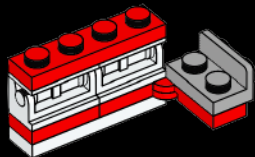

2x



1x

86

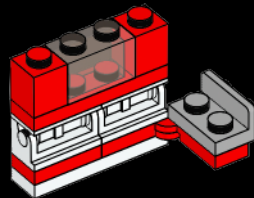



2x

87

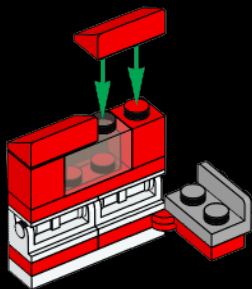

88

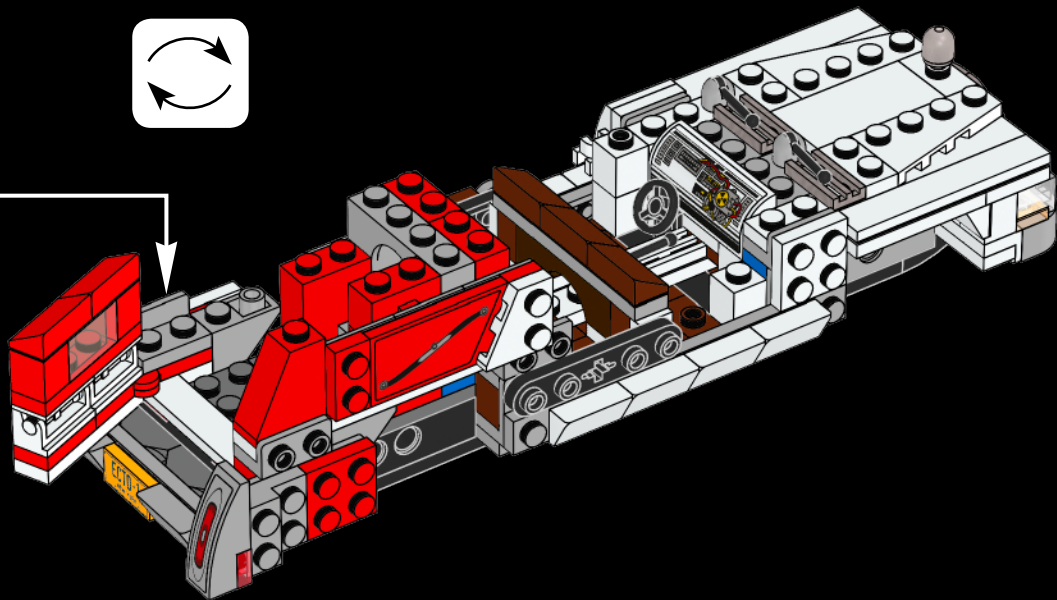



1x

89

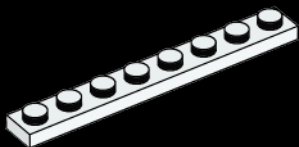

3x

90

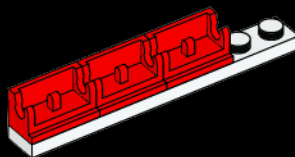



91

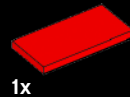
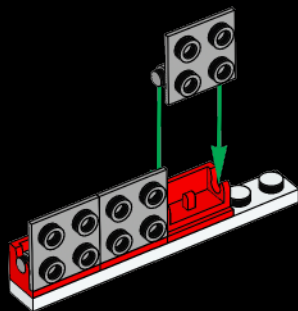

92

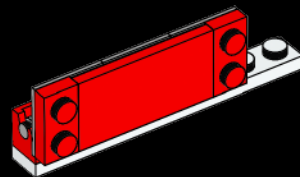



1x

93

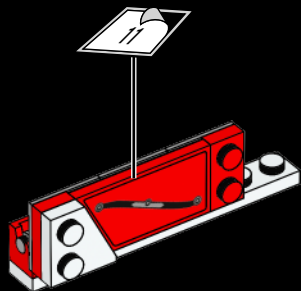

96



1x

94

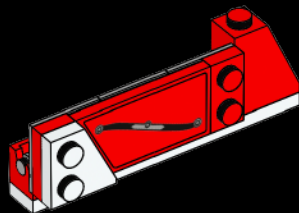

95

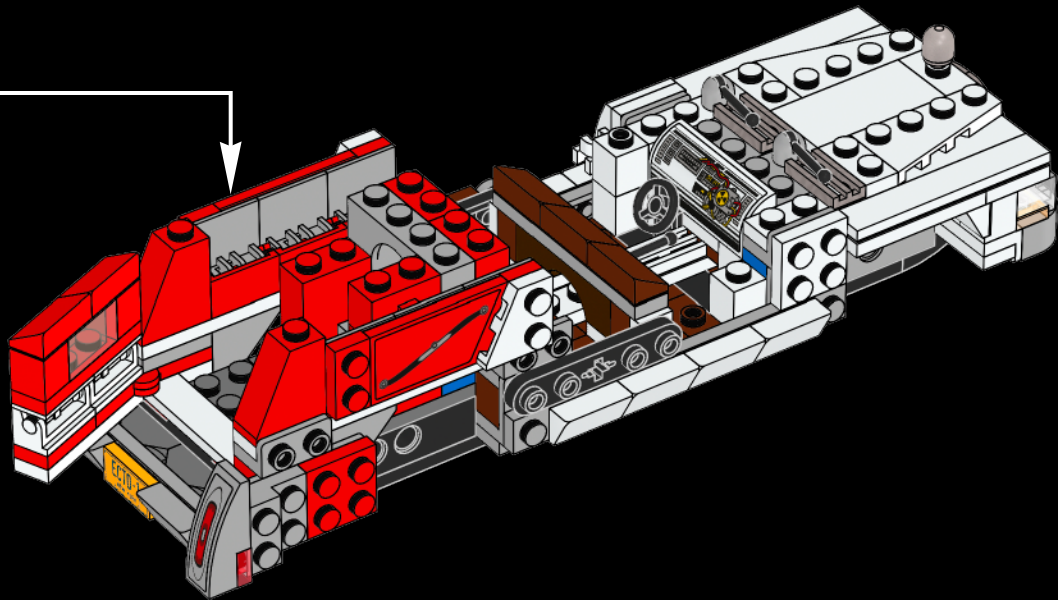



1x

96

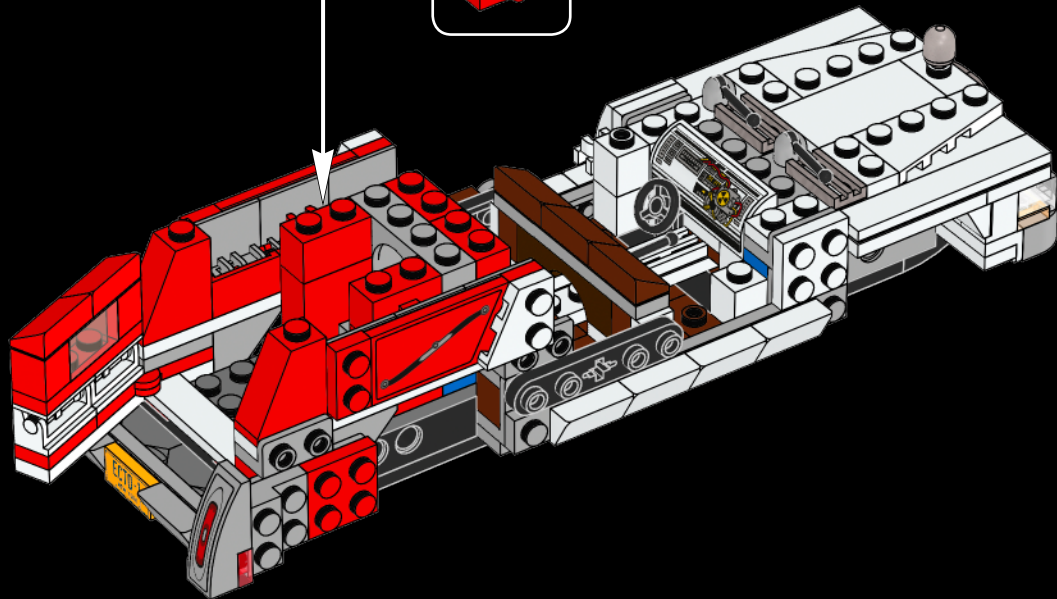



1x



2x

97

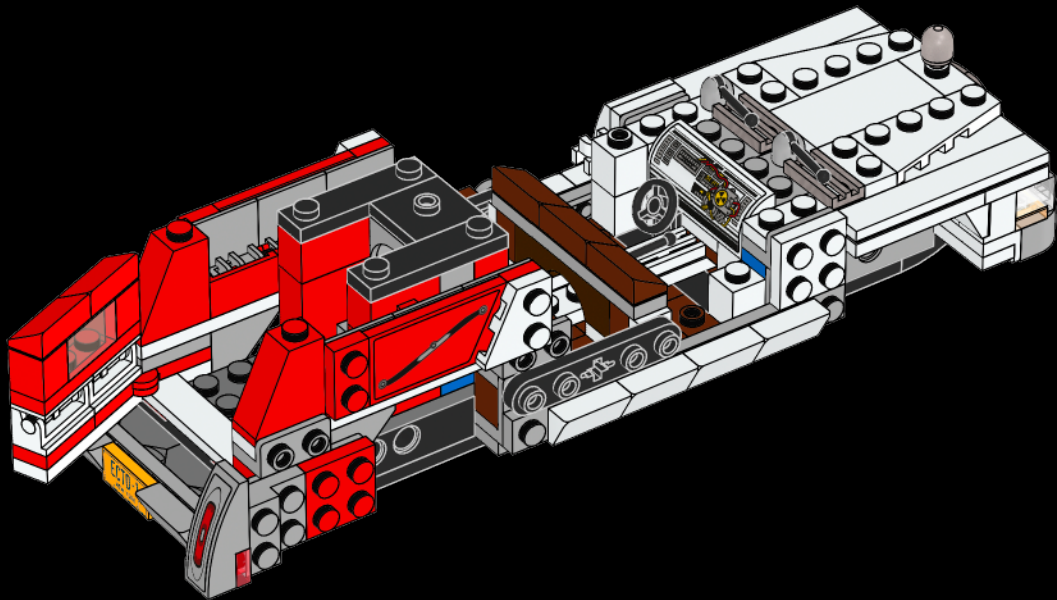



98

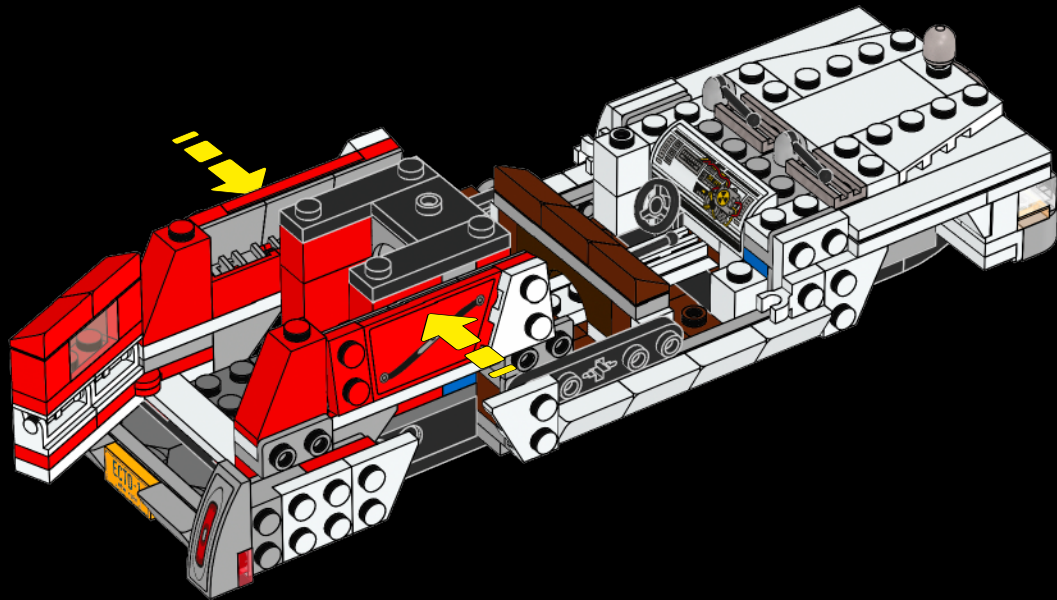



1x



1x



1x



1x

99

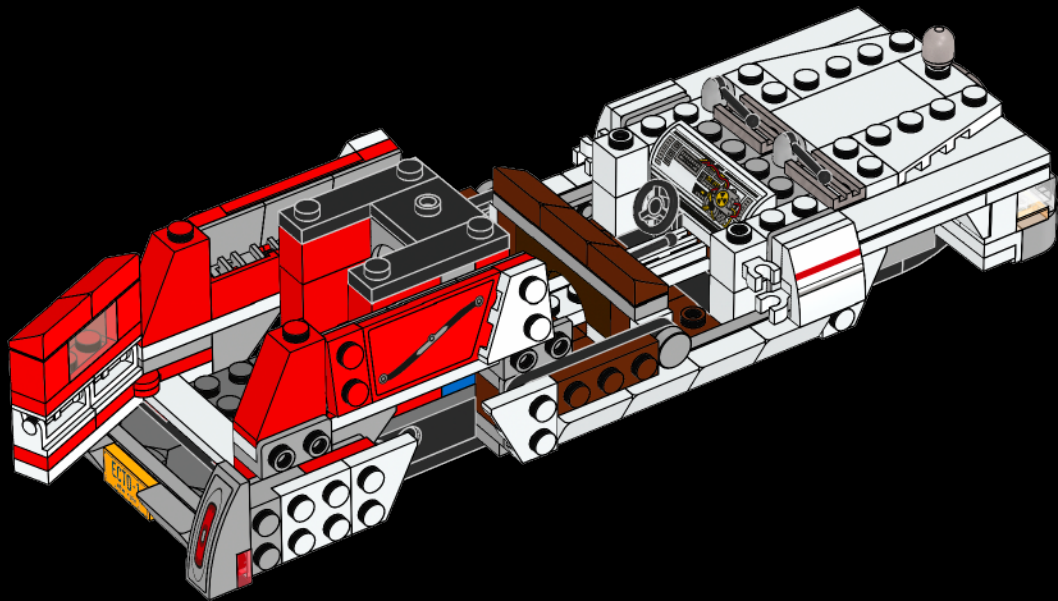

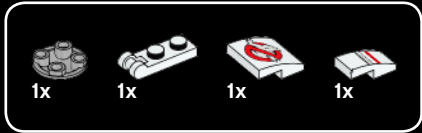

100

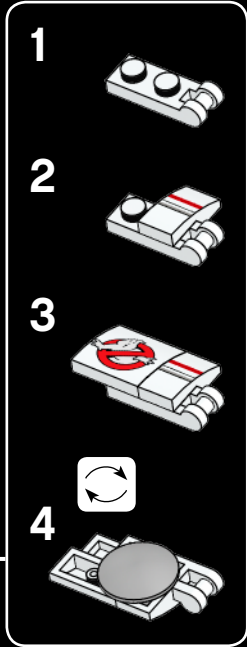
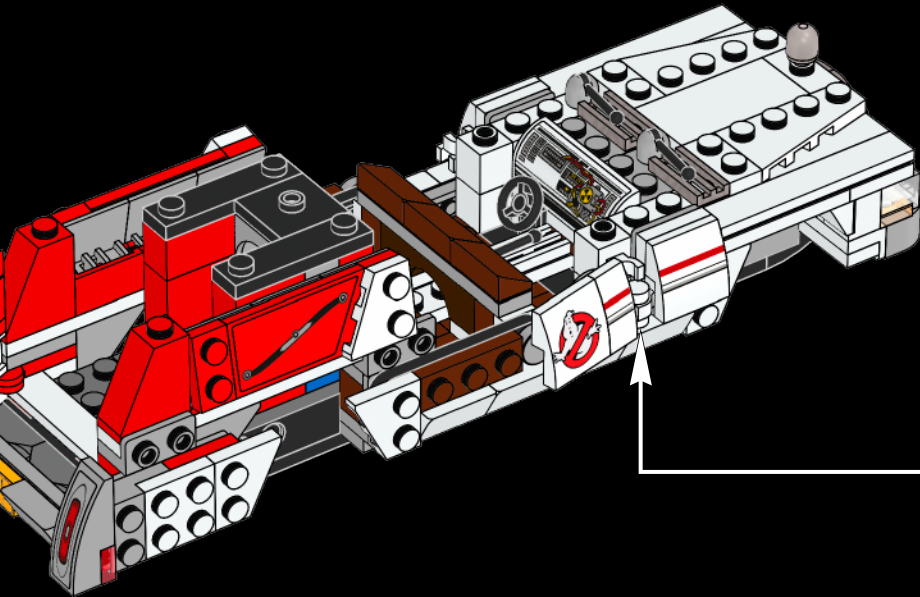

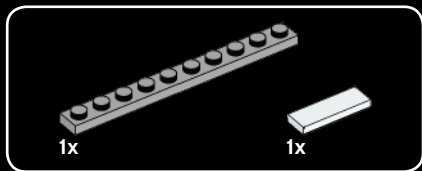

101

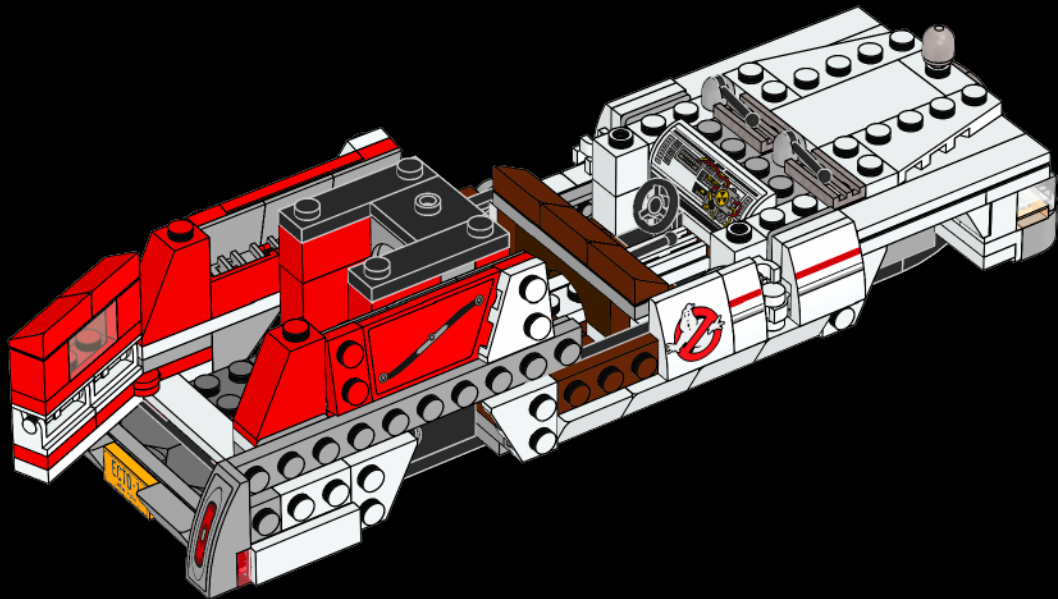



4x

102

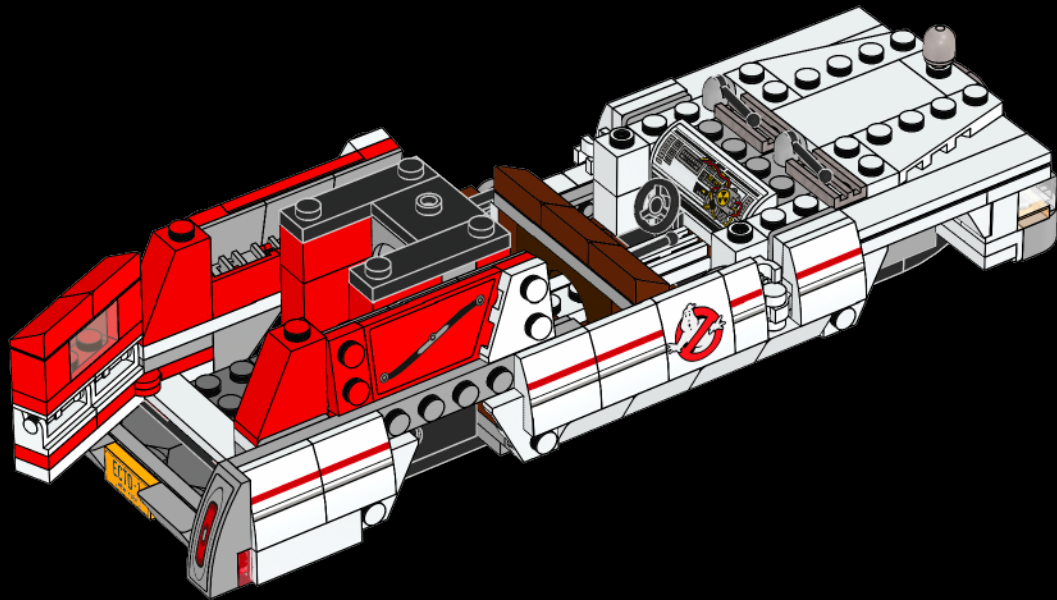



1x



1x



1x



1x



103

1



2



3



4

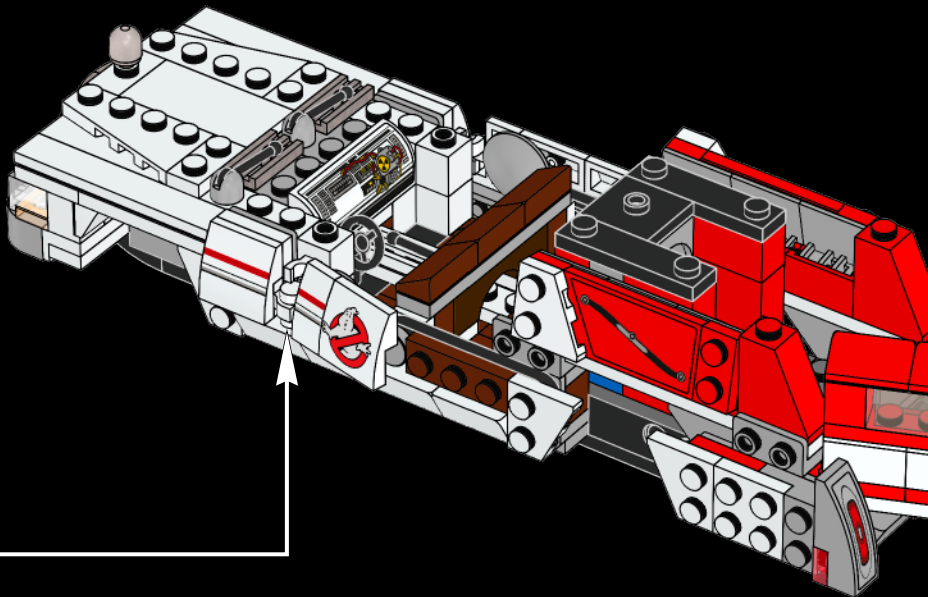

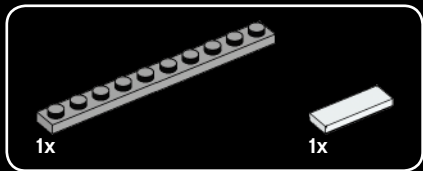

104

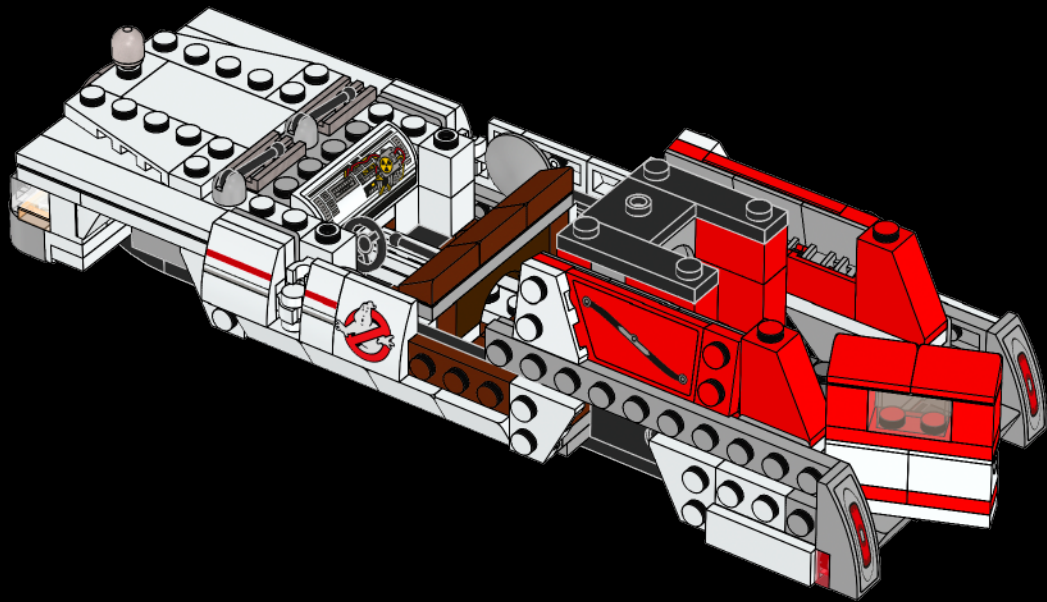



4x

105

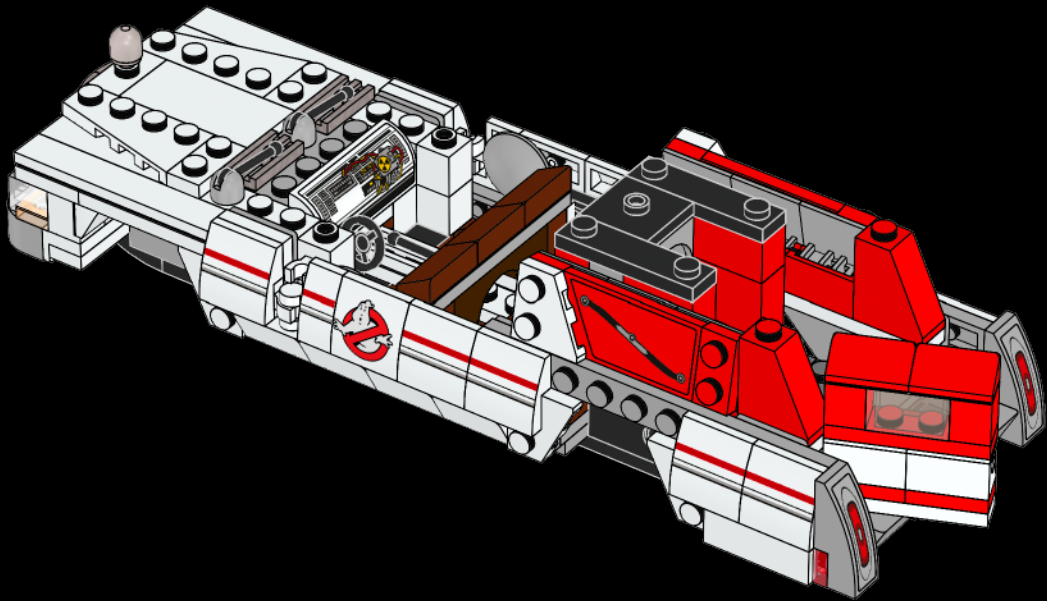

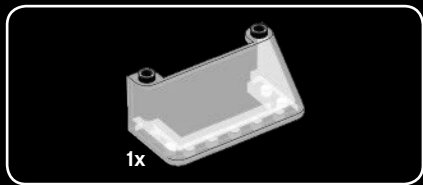

106

1

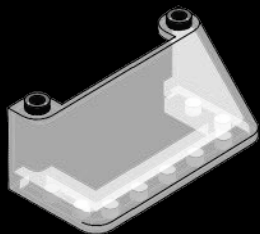

2

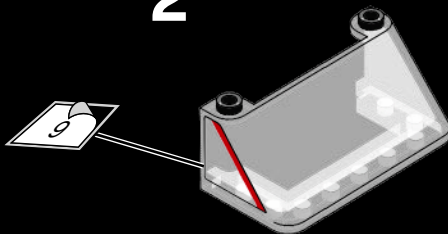

3

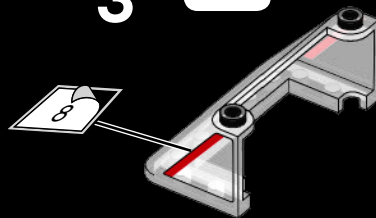

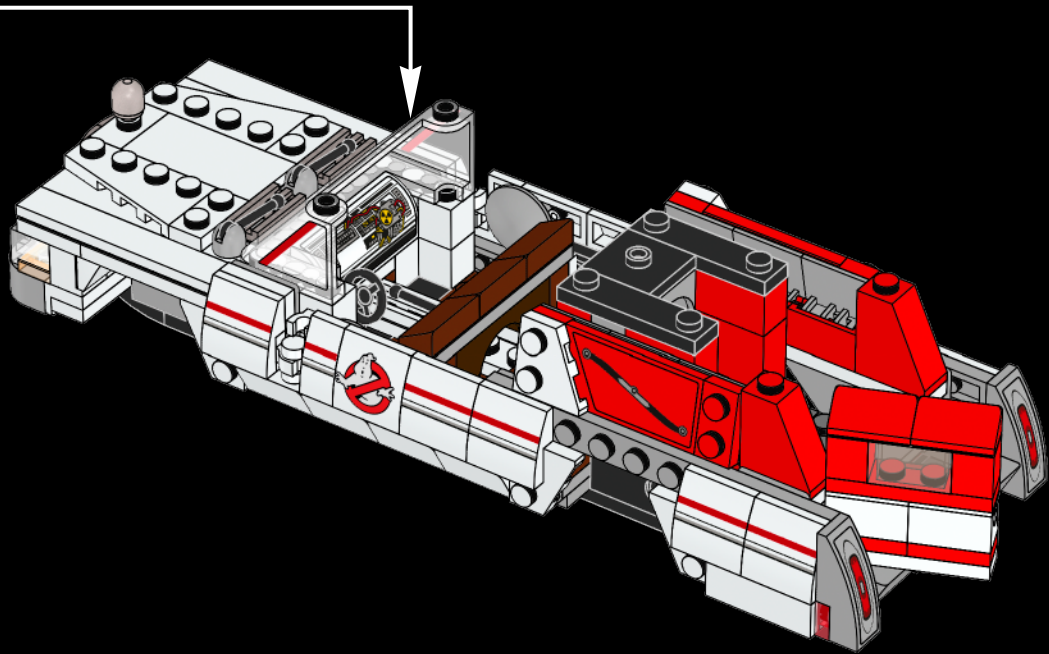



2x



2x

107

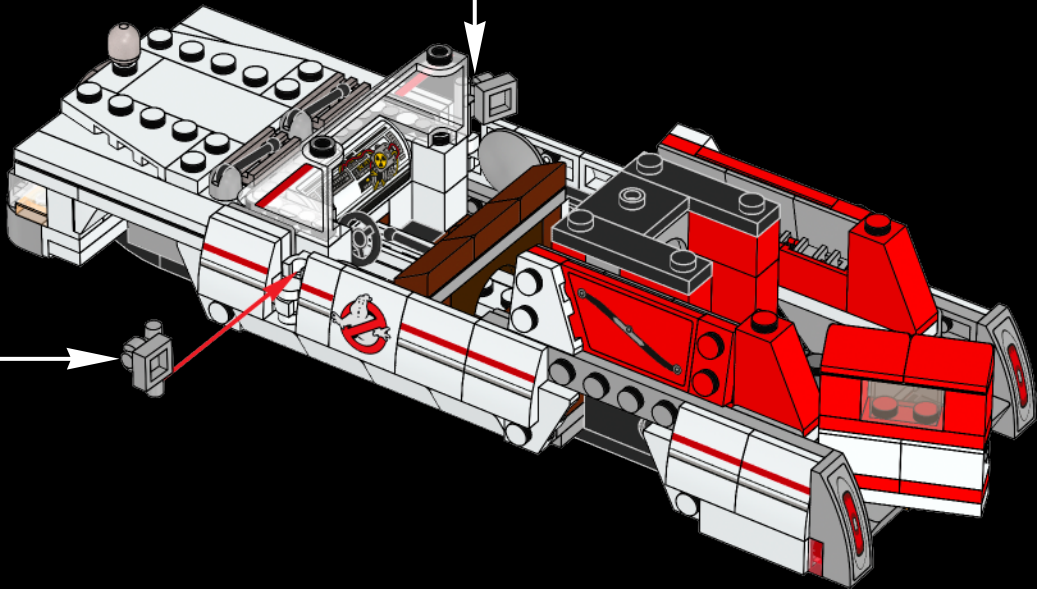
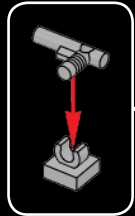
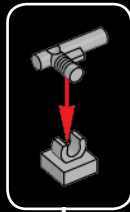

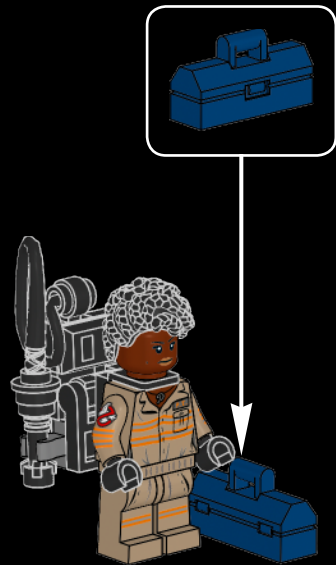
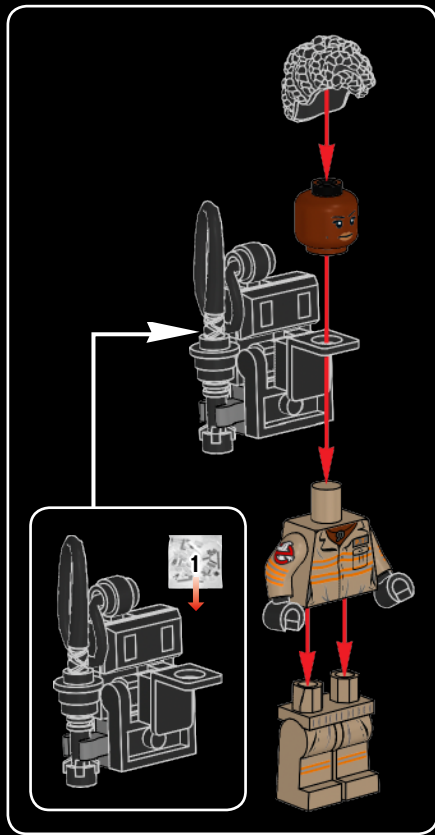
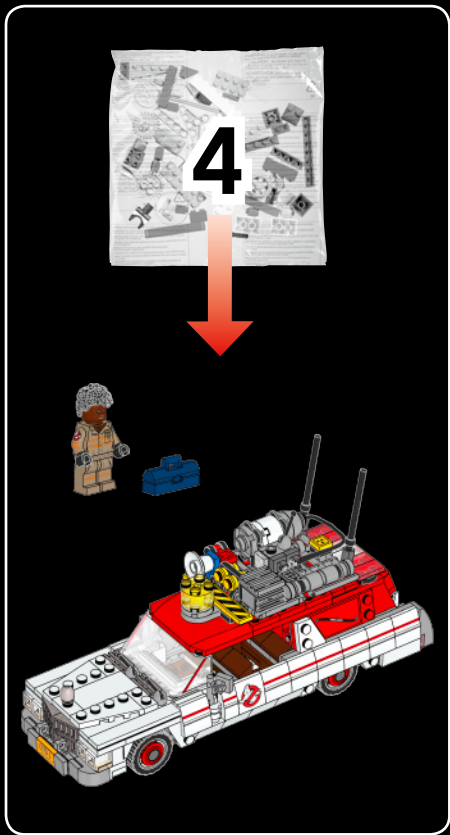



2x

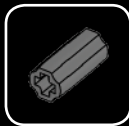

108

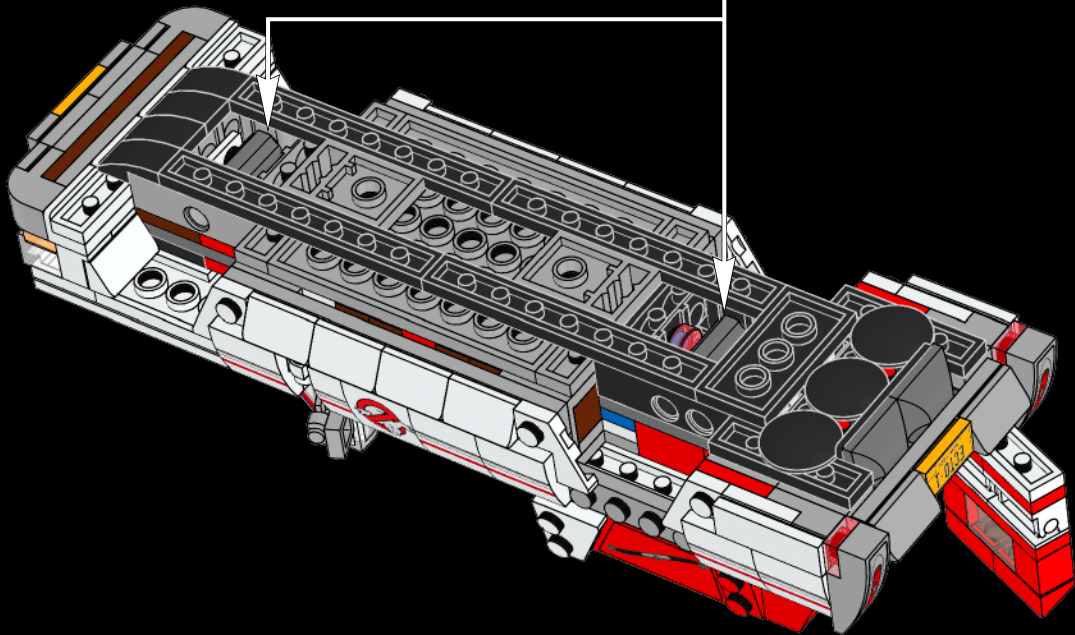

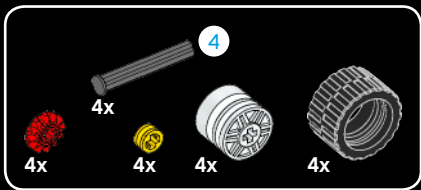

109

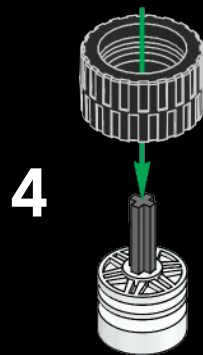
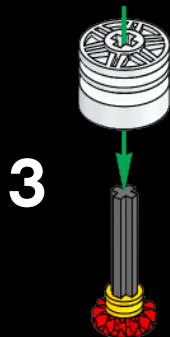
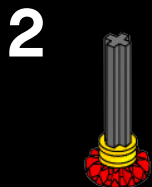
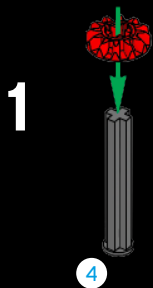

4x

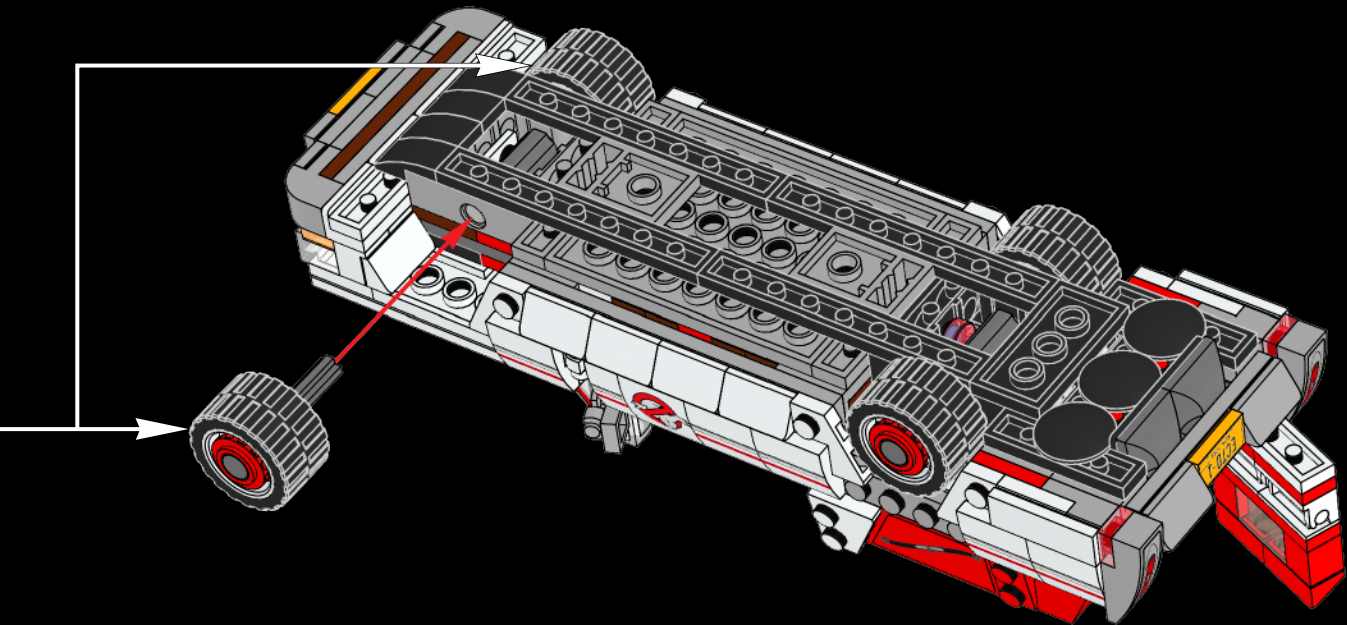

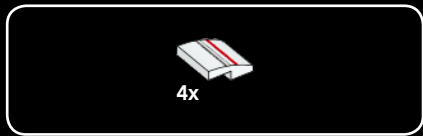

110

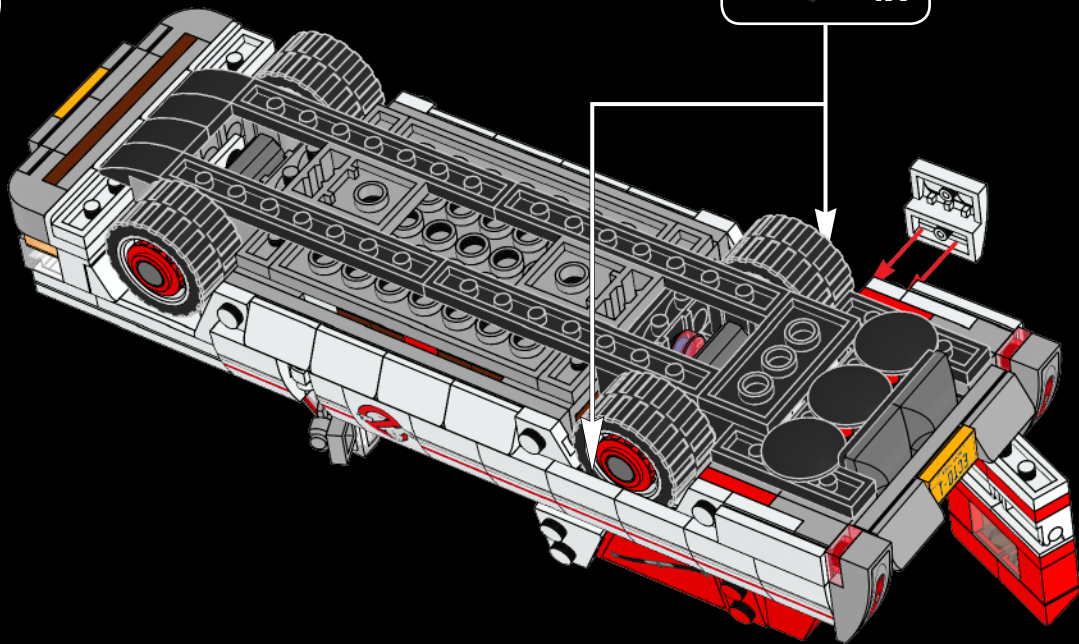

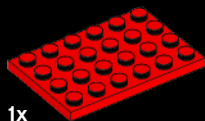

1x

111

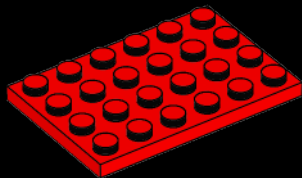

1x



2x



112

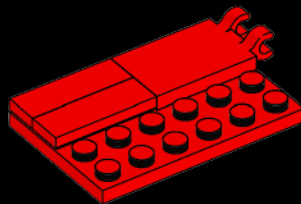



2x



2x

113

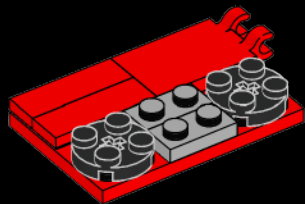

4x



2x

114

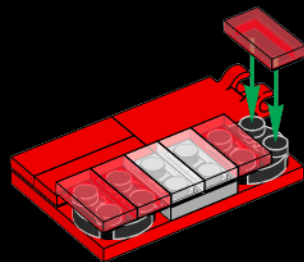

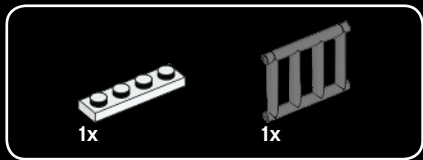

115

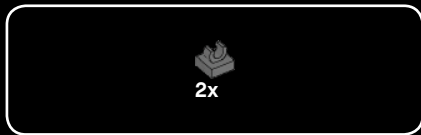
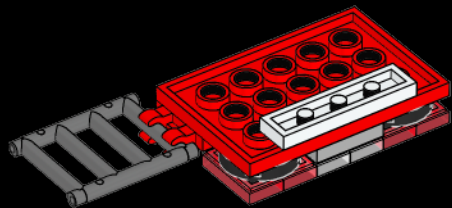
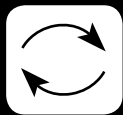

116

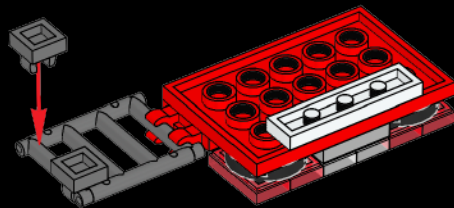

117

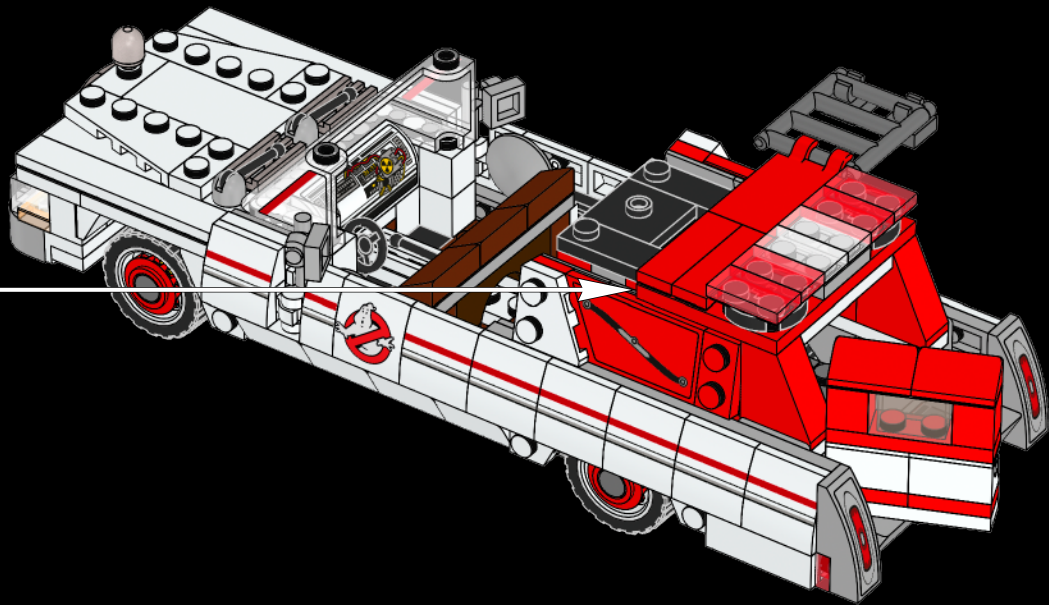

118

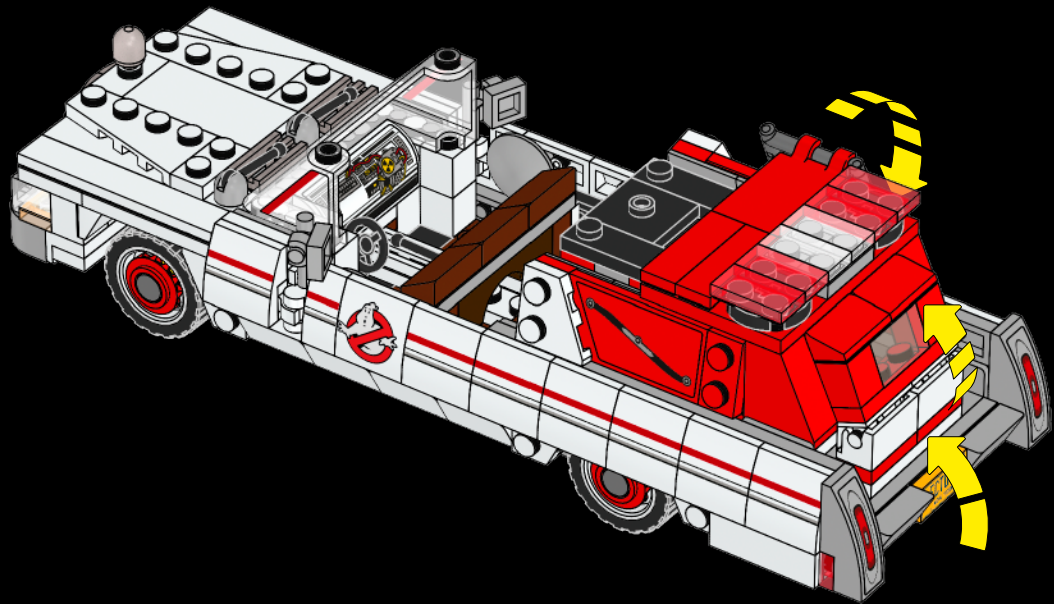

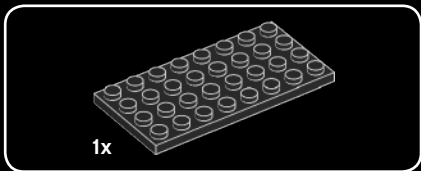
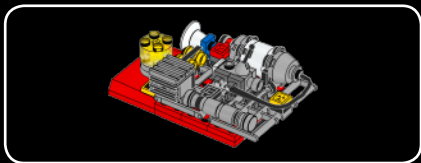

1x

119

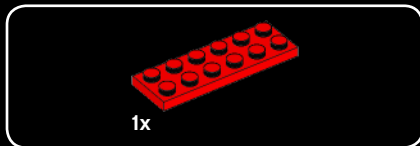
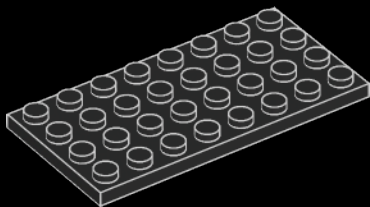

1x

120

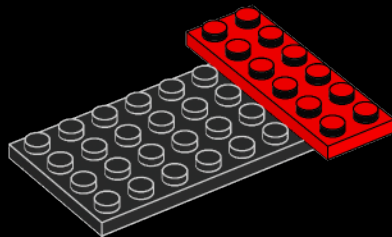



2x

121

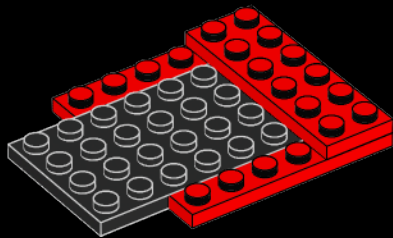



122

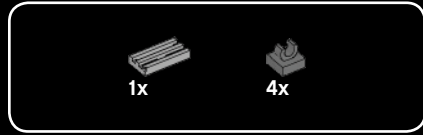
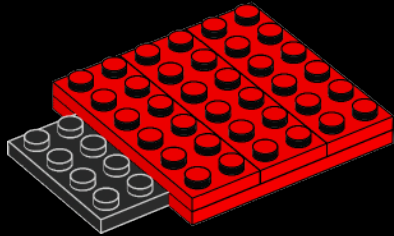

123

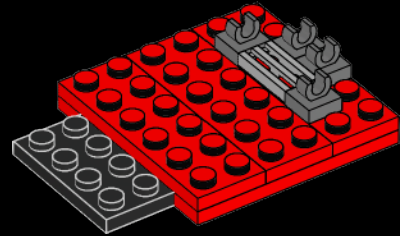

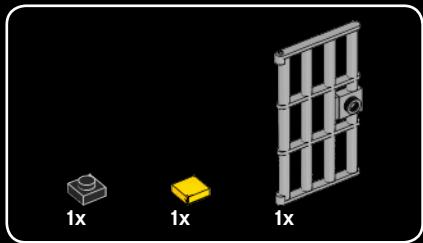

124

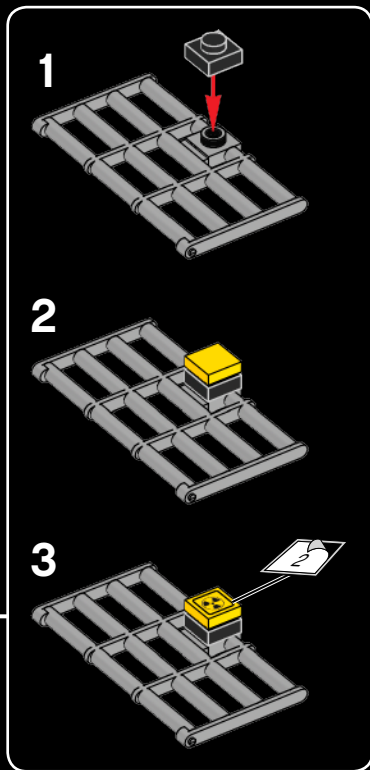
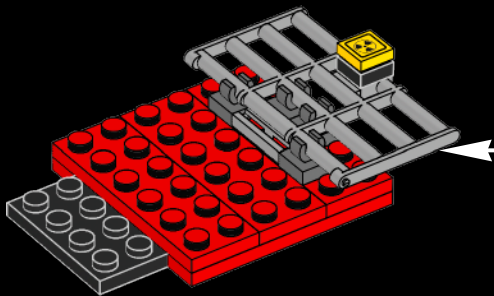



2x



4x

125

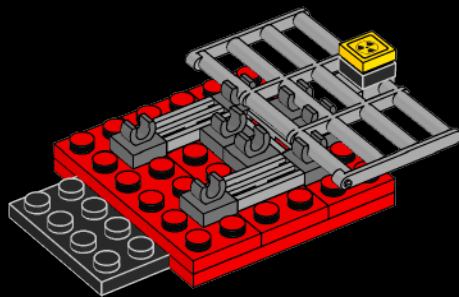

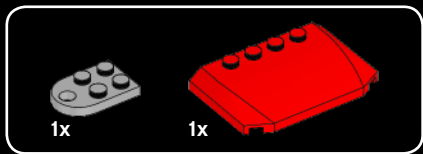

126

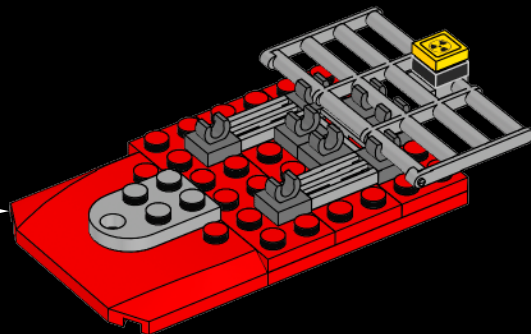
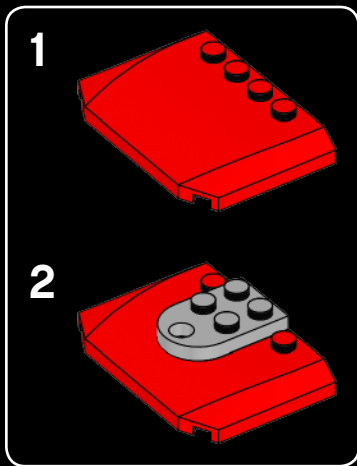



2x

127

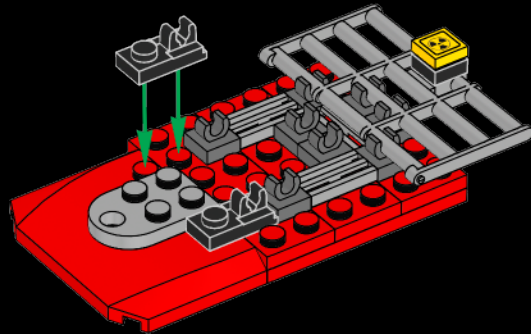

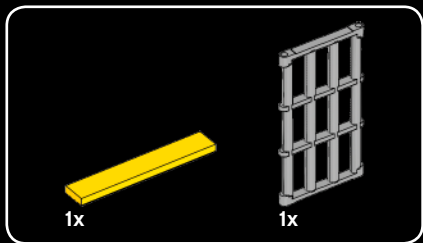

128

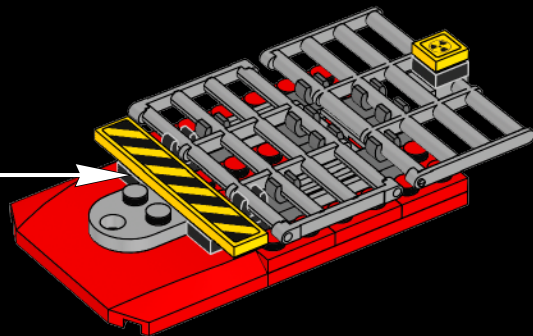
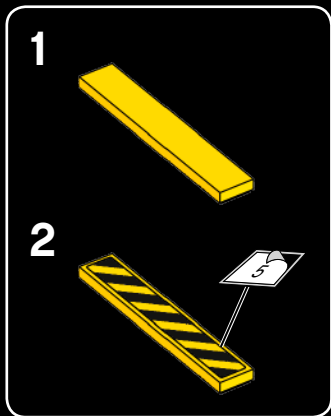



1x



1x

129

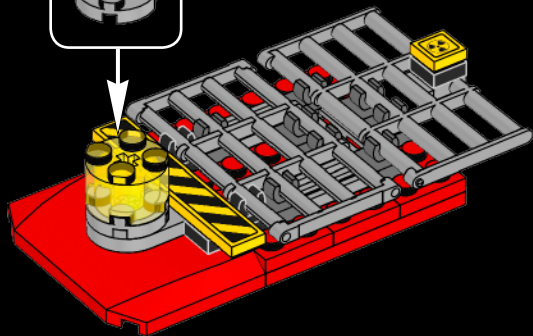
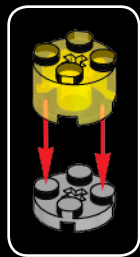

1x



1x



1x

130

1

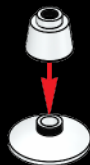

2

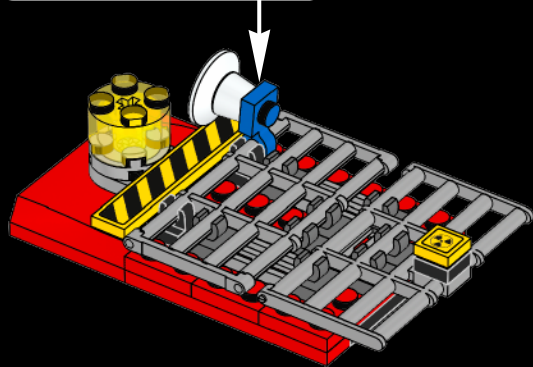



1x



1x



2x

131

1

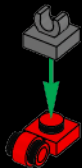

2

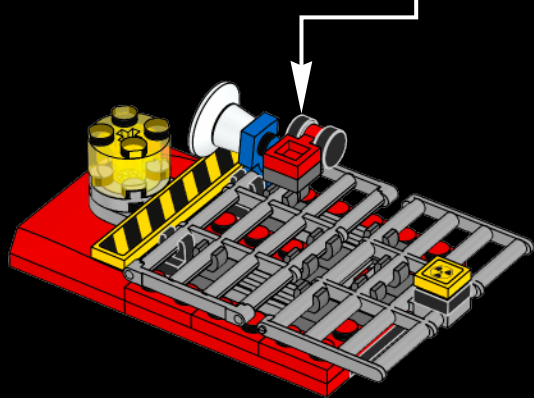
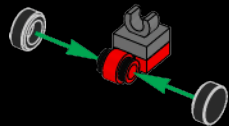

4x



1x

132

1



2

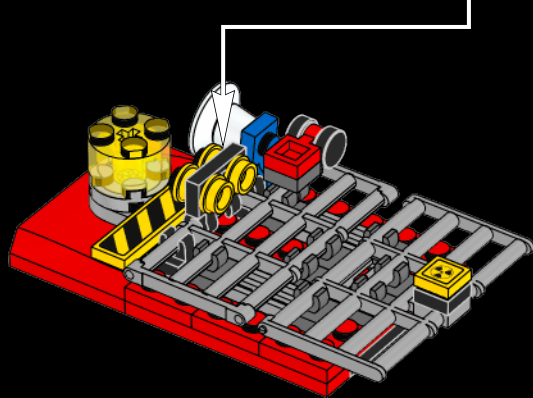

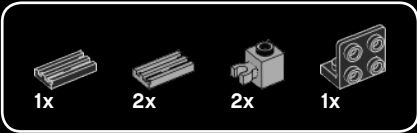

133

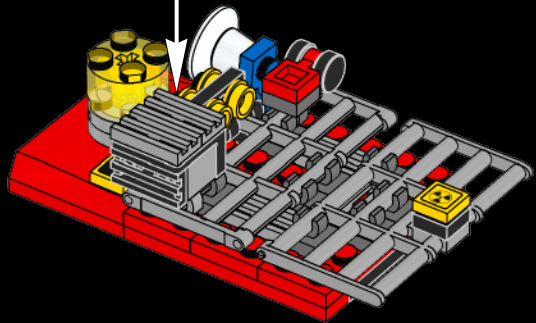
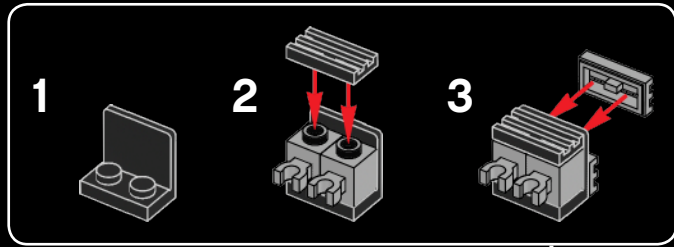



134

1



2

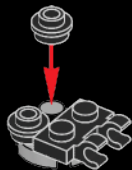

3

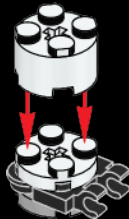

4

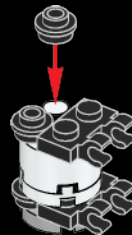

5

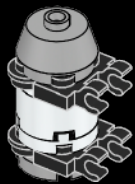

6

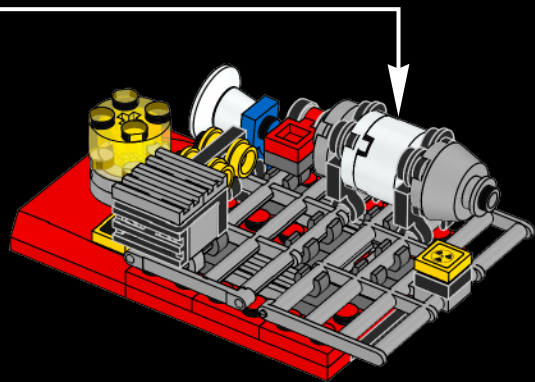
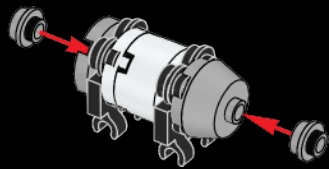

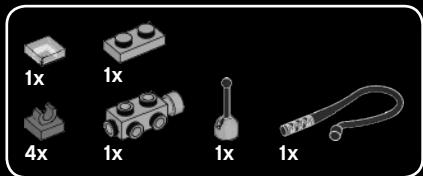

135

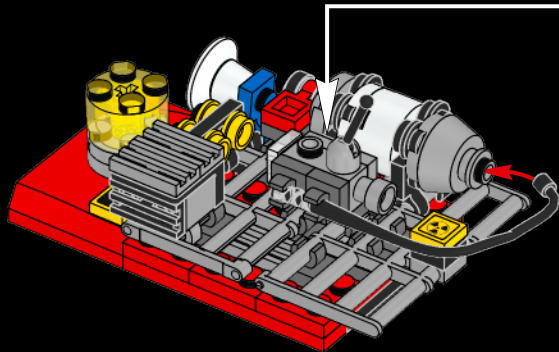
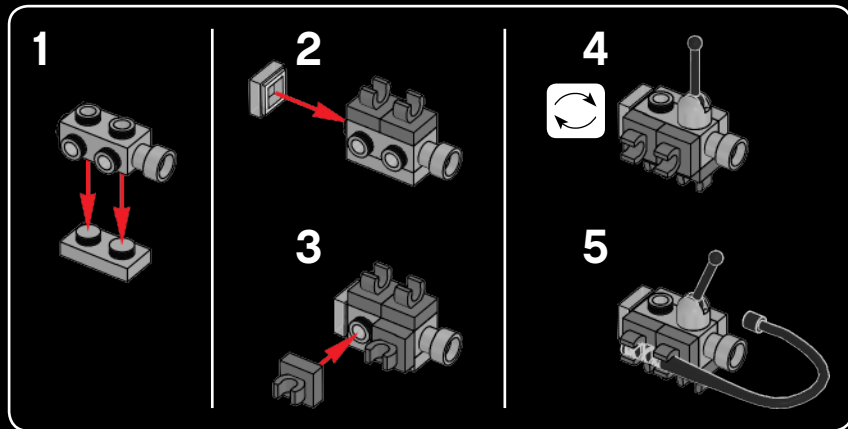



136

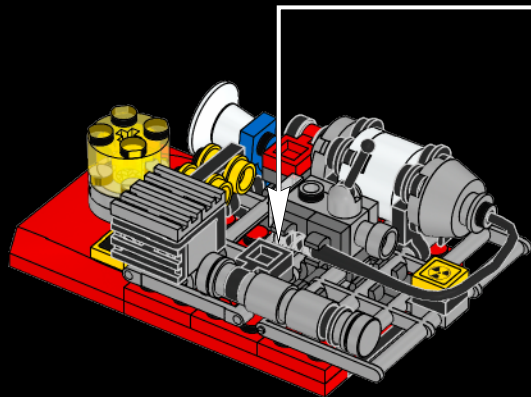
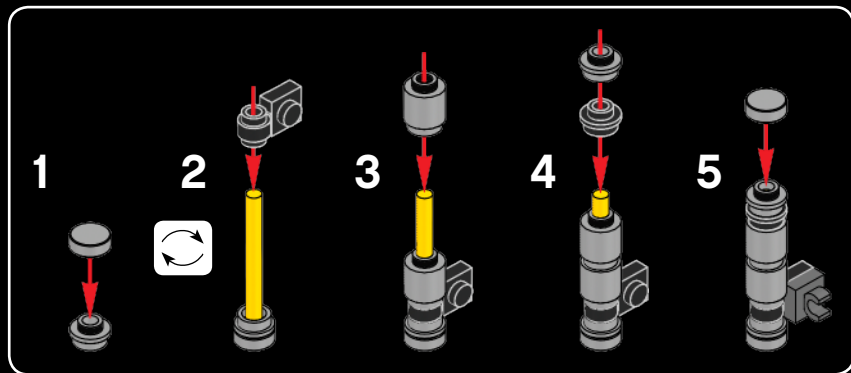

137

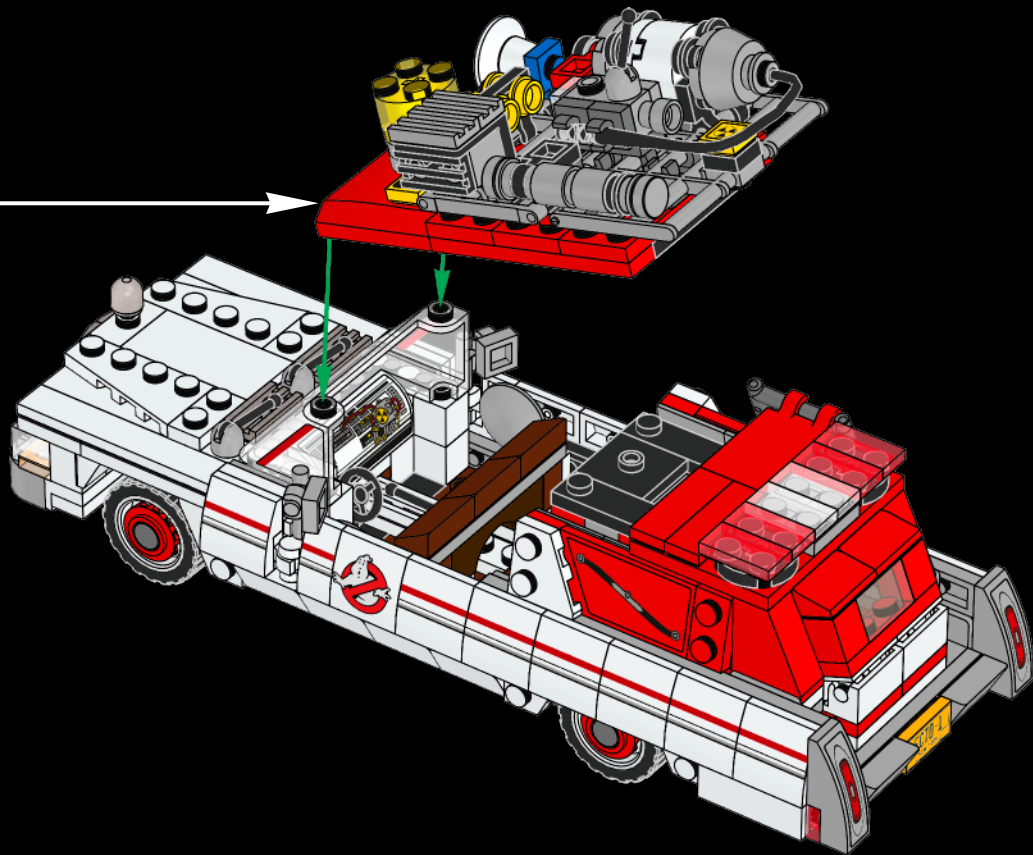

136

138

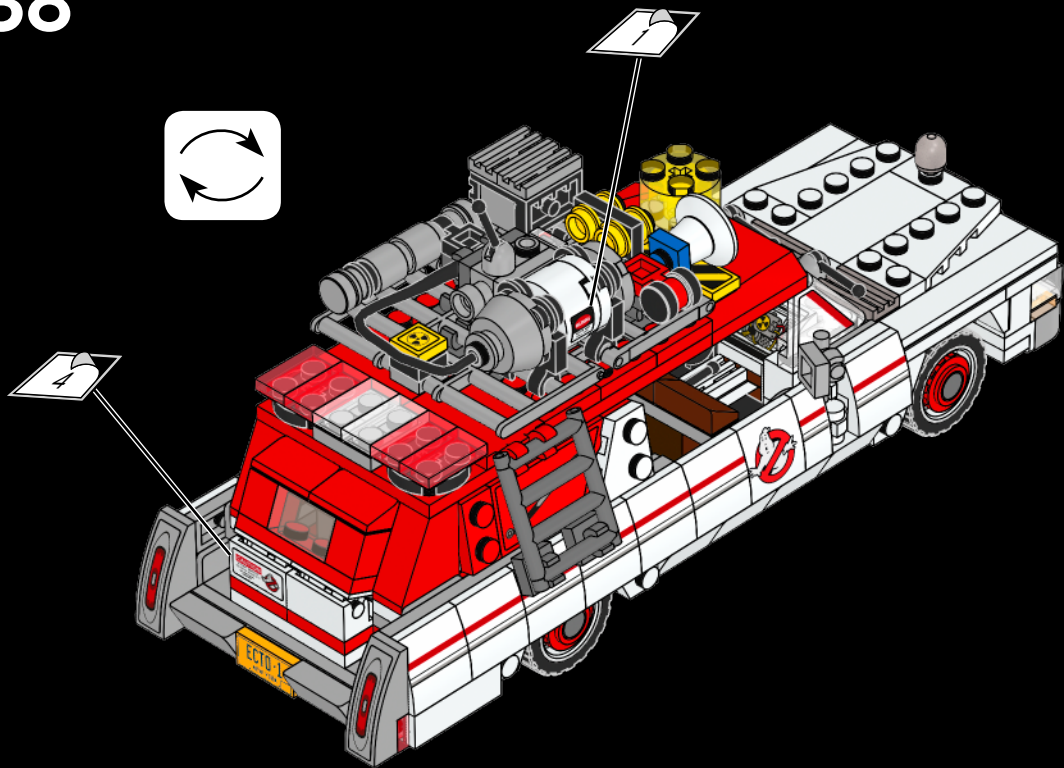

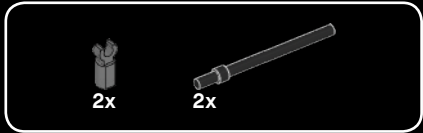

139

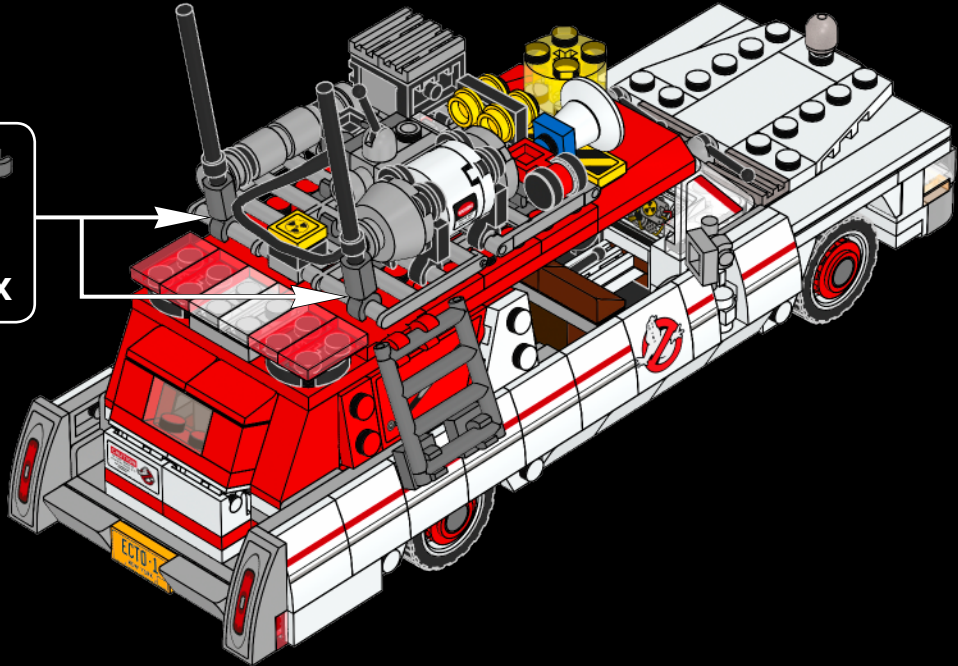
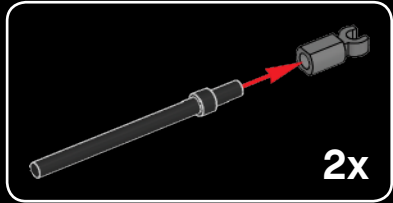

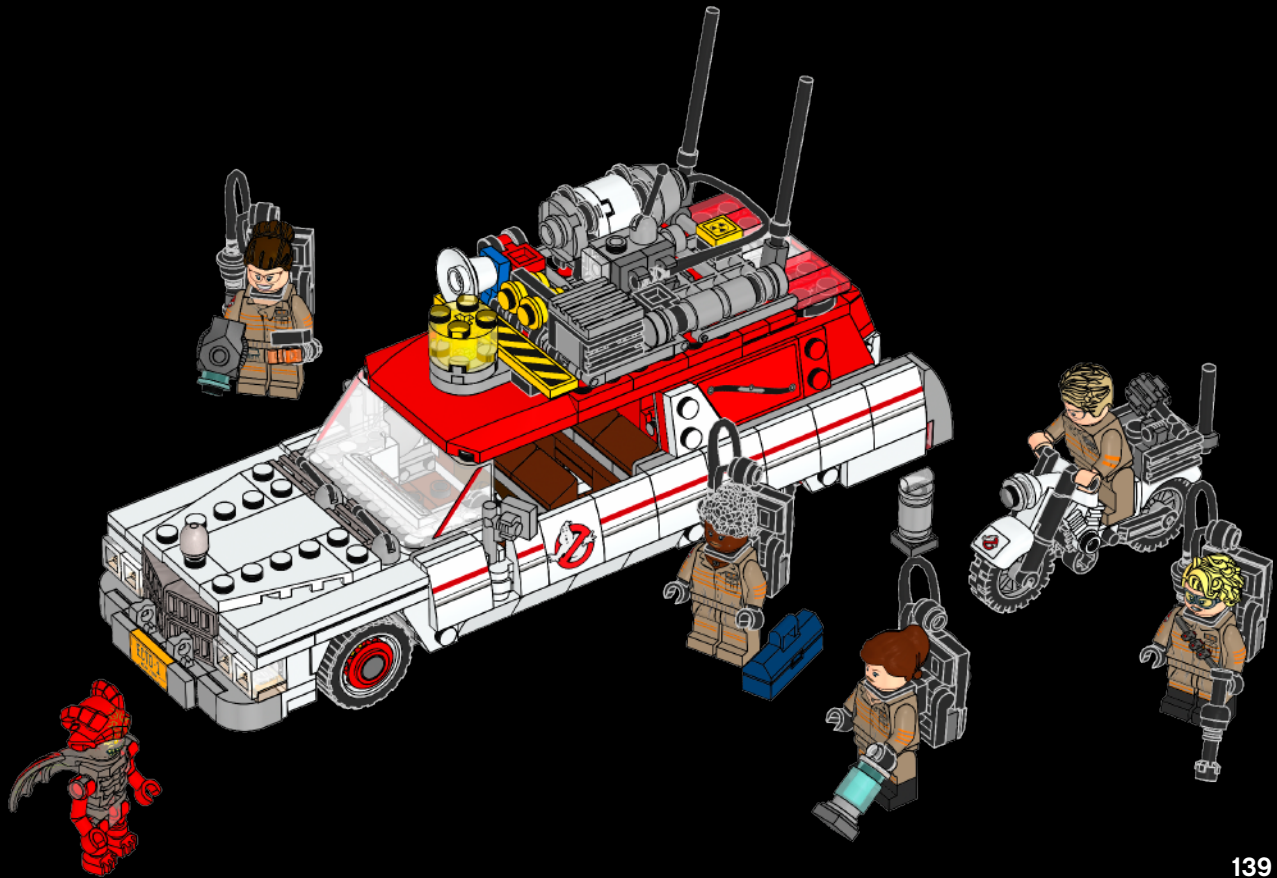



1x
6028323



4x
407001



6x
302401



4x
6132204



4x
6132203



2x
4538353



1x
4161326



1x
4160857



2x
4533763

140



1x
403201



10x
4547489



1x
474001



1x
614301



2x
6158475



3x
300401



1x
241201



1x
6051511



2x
393801



7x
302301



2x
393701



6x
6018774



14x
6156951



2x
6092268



6x
302201



2x
235701



4x
6092256



2x
4515364



2x
4558168



1x
6019727



3x
243101



4x
371001



1x
4560178



2x
663601



2x
4508662



4x
346001



1x
6117018



2x
6160091



2x
300521



4x
6157503



2x
4651524



1x
4632572



1x
6160094



2x
6127728



2x
4515371



4x
4143832



1x
370021



19x
302321



6x
393721



2x
302221



2x
4533742



2x
6161433



1x
370121



1x
4530734



1x
6102786



2x
4560179



1x
371021



2x
366621



3x
379521



1x
4259903



1x
303221



1x
73587



2x
403226



1x
73081



2x
6064174



2x
4114689



2x
4541710



2x
4646864



2x
6139403



3x
4278359



1x
6000650



4x
4639695



2x
4599499



2x
6092269



2x
3000841



9x
6100627



2x
4121715



3x
4556158



5x
6092878



7x
371026



2x
6153264



4x
4189801



1x
459926



5x
4632571



4x
4225201



1x
6159506



1x
302026



1x
3005740



1x
6151873



9x
6066102



6x
4598528



1x
6093525



1x
6118829



1x
300126



4x
4215618



1x
6159727



1x
302426



3x
241226



1x
4565323



2x
6081988

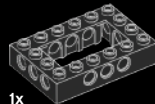

1x
4144025



1x
6047501



1x
4226179



4x
6020192



8x
6156991



2x
6052126



1x
4530673



4x
346026



2x
4569297



1x
6157723



1x
4253815



1x
306926



6x
4598897

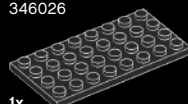

1x
303526



1x
6089694



1x
6160090



3x
4221775



2x
4514195



2x
4211437



1x
4211502



1x
4211445



4x
614124



1x
6159378



3x
4211412



2x
4533772



5x
4211350



2x
4251163



1x
6031056



4x
4239601



2x
4225469



4x
4650260



1x
6028324



2x
4211519



1x
4211419



2x
6012653



1x
6116606



1x
6093515



4x
6124825



2x
4568637



9x
4211398



4x
4211396

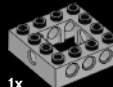

1x
4211640



1x
4164073



6x
6035291



2x
4211525



2x
4568637



8x
4654580



1x
4599496



3x
4211438



1x
663624



19x
6092590



2x
6071229



2x
4211475



6x
6004990



1x
4599496



4x
4251149

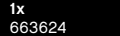

1x
663624



2x
4211210



6x
4211415



2x
4278273



6x
4211881



1x
4610149



4x
4251149

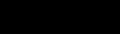

1x
663624



4x
4211152



2x
4590443



2x
4211814



2x
4654577



1x
4610149



1x
4211408

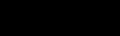

1x
663624



2x
4221590

2x
4143005

1x
4520946

4x
242023

1x
6161518

1x
4524098

1x
6161543

1x
6158191

1x
6158209

1x
6161300

1x
6158143

1x
6158152

1x
6158044

1x
6159781

1x
4183544

1x
4163917

16x
6071226

2x
4210848

2x
4579354

4x
6158294

2x
4516546

1x
4211063

4x
4581225

2x
4218696

2x
6015890

1x
6012451

4x
6083620

1x
4521886

2x
4243831

1x
4211002

1x
4654448

1x
611644

1x
6104199

1x
6135159

4x
6092115

2x
6051422

1x
6131726

1x
6030198

1x
6158321

1x
6158322

1x
4623775

1x
6159642

1x
6161252

1x
6159381

1x
6159382



Customer Service

Kundenservice

Service Consommateurs

Servicio Al Consumidor

LEGO.com/service or dial



: 00800 5346 5555

: 1-800-422-5346