



Harry Potter™

75950



 [LEGO.com/harrypotter](https://www.LEGO.com/harrypotter)

WIZARDING
WORLD

1



2



3



4



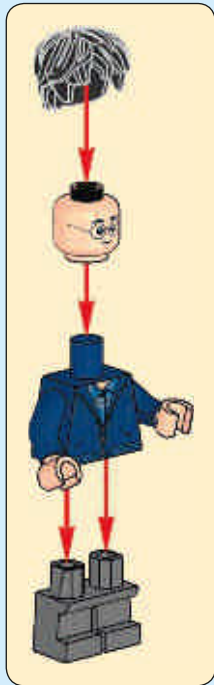



1



4



2x



1x

2



1x



1x

3

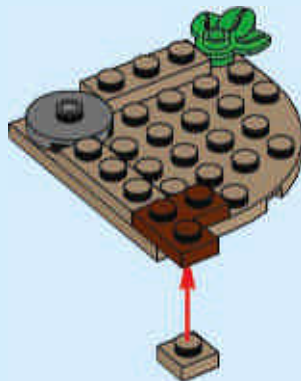



6

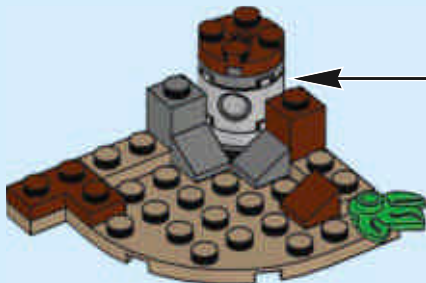
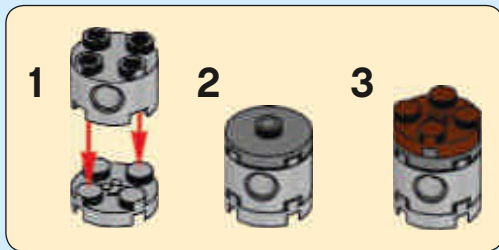
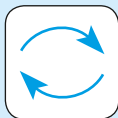



7



8

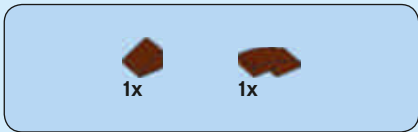

8





1x



1x

9

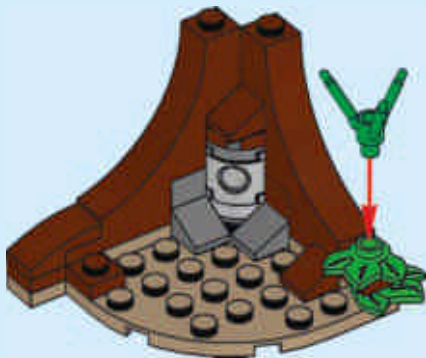

10



1x



1x

10





11



12



12





1x

13



14

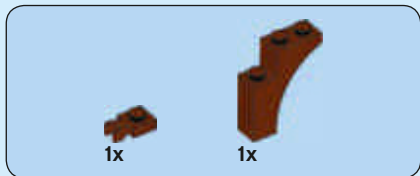

14

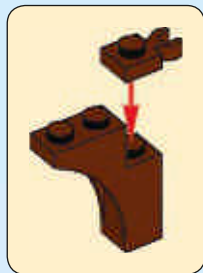



1x

15



16



1x



1x

16





2x



1x

17



18



2x

18





2x

19



20



1x

20



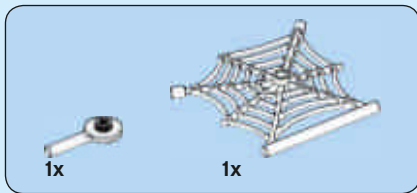

21

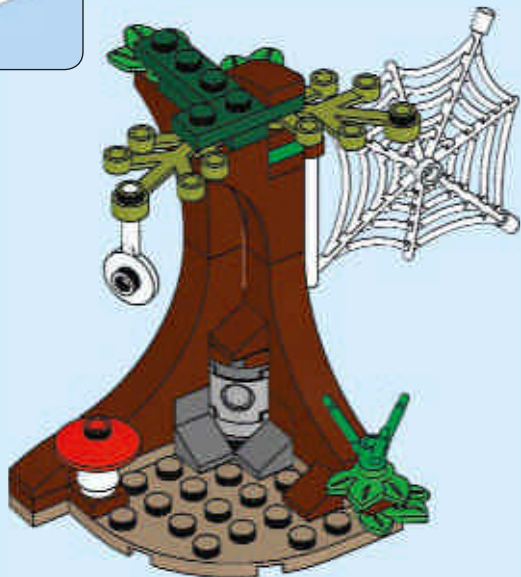

22



1x



1x

22





1x



1x

23

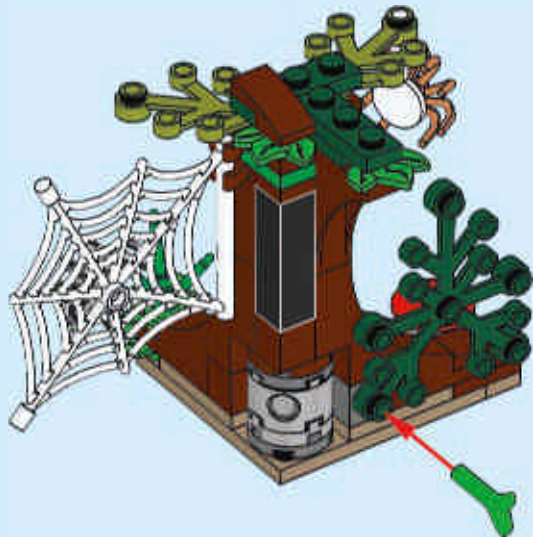
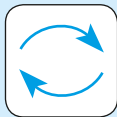

24

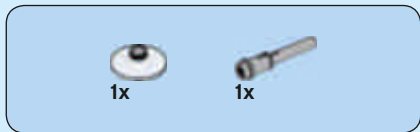

24

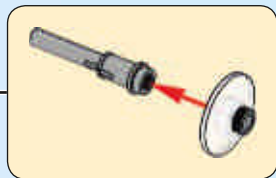
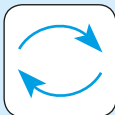

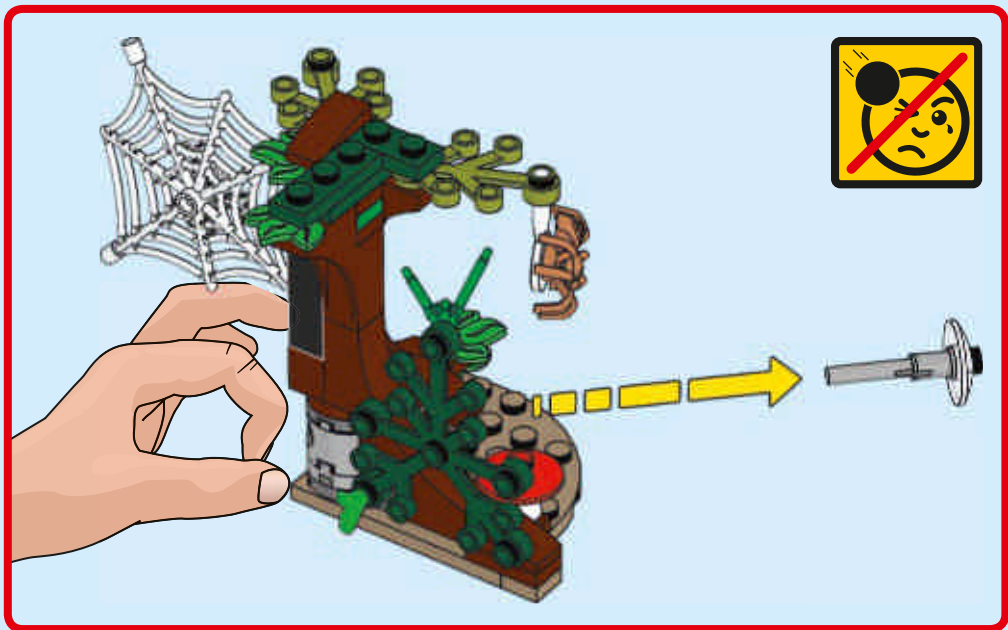



1x

1

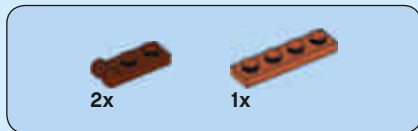

2x

1x

2





4x

3



28



2x



2x

4





2x



1x

5



2x



2x

6

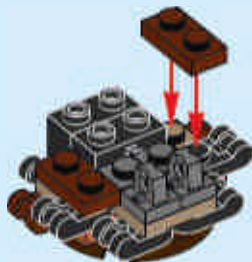



2x

7



30



1x

8





1x



2x

9

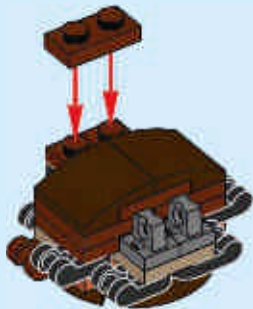

1x

10

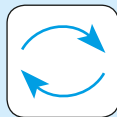



1x



1x

11

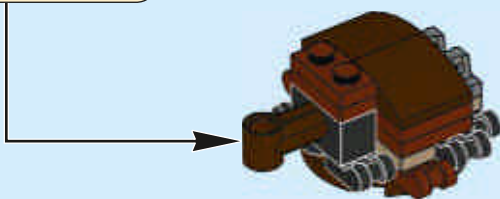
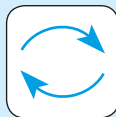
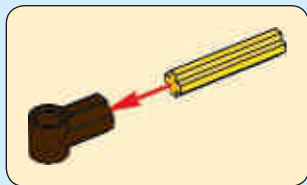



12

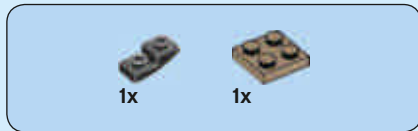

13





1x

14



34



1x

15





1x



2x

16



2x

17





2x



1x

18

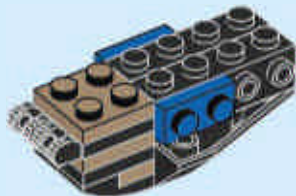

36



4x

19

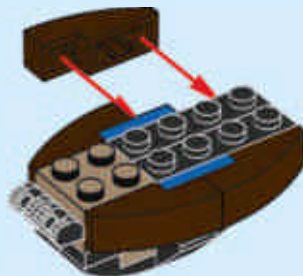



1x

20



2x

21



22

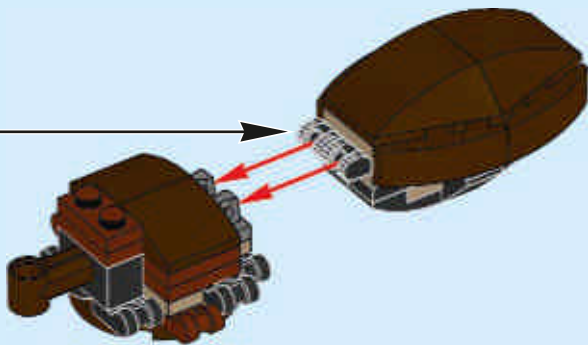



1x



1x

23



1x

24





1x



1x

25



40



1x



1x

26

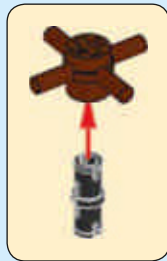

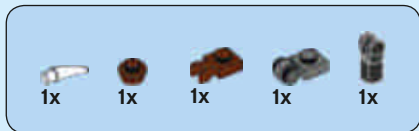

27

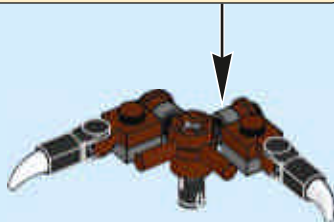
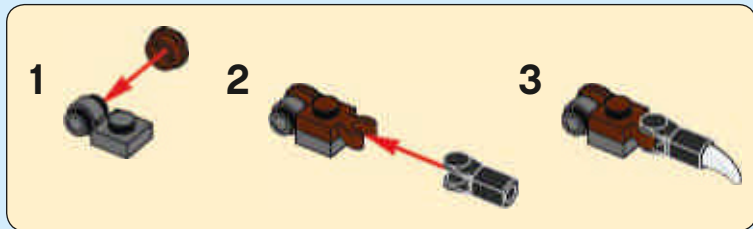

28

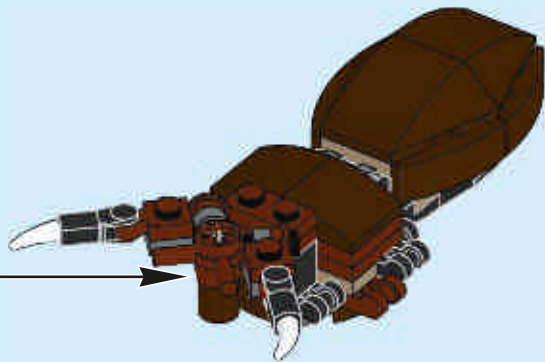

42



2x



2x



2x

29

1



2



2x

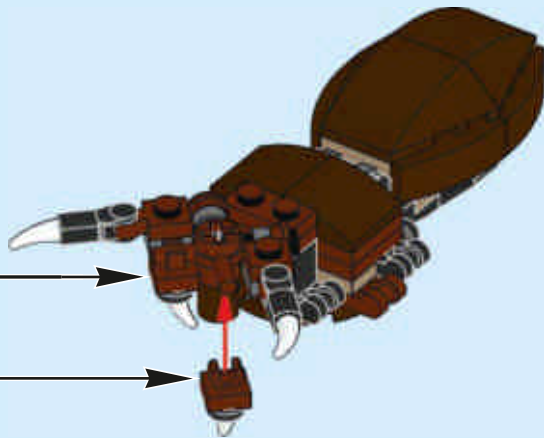



1x



1x

30



44



2x

31





1x

32



4x

33



34

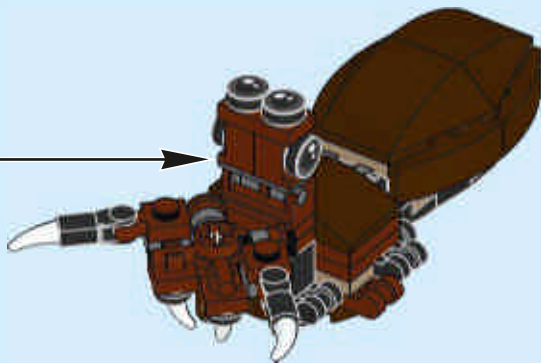

35

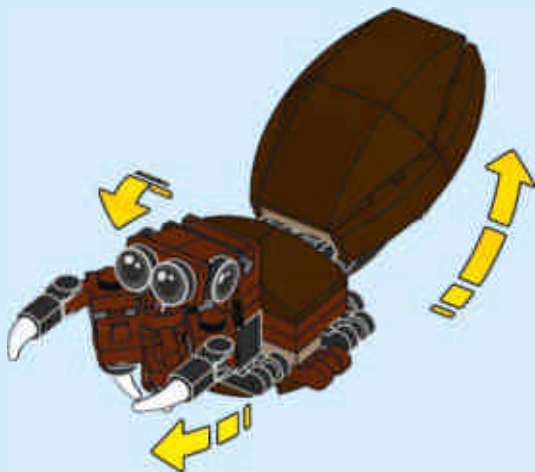



36

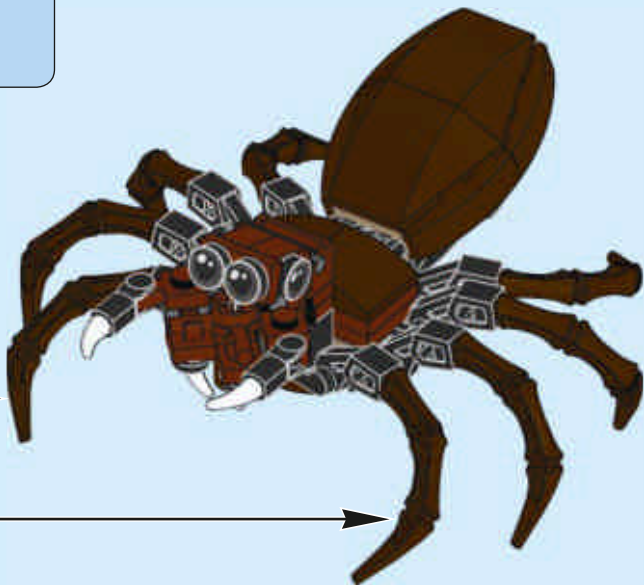
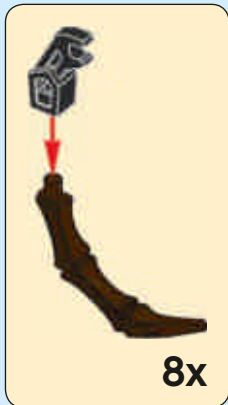





Harry Potter™



75950

+

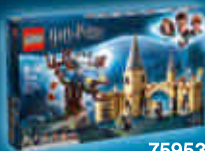

75953

+

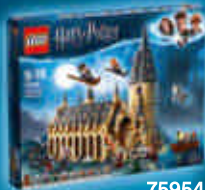

75954





FANTASTIC BEASTS™



75951



75952





FANTASTIC
BEASTS™



Harry Potter™



75952



75950



75953



75951



75954





1x
4585146



1x
6234807



1x
4518400



4x
4568387



1x
390001



1x
6245432



1x
6006221

54



1x
4211475



1x
6078985



1x
4520320



1x
6233975



1x
6236437



1x
6233913



1x
6233910



3x
6234805



1x
6135278



4x
6182261



1x
4119479



1x
4157120



1x
4537937



2x
6006425



3x
6013975



1x
4505066



4x
6236565



2x
6168646



2x
6143318



8x
6006739



1x
6233922



6x
6157554



1x
6065496



2x
6234806



1x
4121715



2x
6147050



2x
4183060



2x
6178922



2x
4162443



1x
302026



1x
6092952



1x
6167932



1x
6235076



2x
6047037



4x
6022199



8x
6051523



1x
6005030



2x
6234804

2x
4504378



1x
4558955

2x
4632574

2x
6115080

2x
4210726

1x
6176400

1x
6234116

1x
6233908

1x
6238674

1x
6130007

2x
302323

2x
6215659

2x
4211242

2x
6071274

2x
4504376

4x
6066142

3

6x
4211150

1x
6232210

1x
6037289

1x
4211159

2x
6069984

1x
6186045

2x
4225469

1x
4252456

3x
4211257

2x
6102975

1x
4211189

2x
6055086

2x
6097417

1x
6233966

1x
4530129

1x
6125719

1x
6074892

3x
4549436

4x
6047415

2x
6132768

1x
6022043

Customer Service

Kundenservice

Service Consommateurs

Servicio Al Consumidor

LEGO.com/service or dial



WIN

GO TO WWW.LEGO.COM/PRODUCTFEEDBACK AND
GIVE US YOUR SHORT **FEEDBACK** ABOUT THIS
LEGO® SET FOR A CHANCE TO WIN
A COOL LEGO PRIZE.

Terms & Conditions apply

LEGO.com/productfeedback



GEWINNE

Erzähle uns auf
www.LEGO.com/productfeedback

etwas über die Erfahrungen, die du
mit diesem LEGO® Set gemacht hast,
und sichere dir die Chance auf einen
coolen LEGO Preis!

Es gelten die Teilnahmebedingungen

GAGNE

Rends-toi sur
www.LEGO.com/productfeedback

et donne-nous quelques commen-
taires sur ce produit LEGO® pour
avoir une chance de gagner un
prix LEGO !

Voir Conditions Générales

GANANA

Visita
www.LEGO.com/productfeedback

y envíanos tu opinión acerca de este
set LEGO®. ¡Participarás en el sorteo
de un premio LEGO!

Términos y Condiciones aplicables

获取奖品

登录
www.LEGO.com/productfeedback

给出关于此乐高®套装的简短反馈，
就有机会获得炫酷乐高奖品

《条款及条件》适用



LEGO and the LEGO logo are trademarks of the LEGO Group. ©2018 The LEGO Group.

Anglia is a trademark owned and licensed by Ford Motor Company.

HARRY POTTER, FANTASTIC BEASTS characters, names and related indicia are © & ™ Warner Bros.

Entertainment Inc. WB SHIELD: © & ™ WBEI. WIZARDING WORLD trademark and logo © & ™ Warner Bros.

Entertainment Inc. Publishing Rights © JKR. (s18)

6263111