

Harry Potter



WIZARDING  
WORLD





[LEGO.com/sustainable-packaging](https://LEGO.com/sustainable-packaging)

# LEGO® VIP

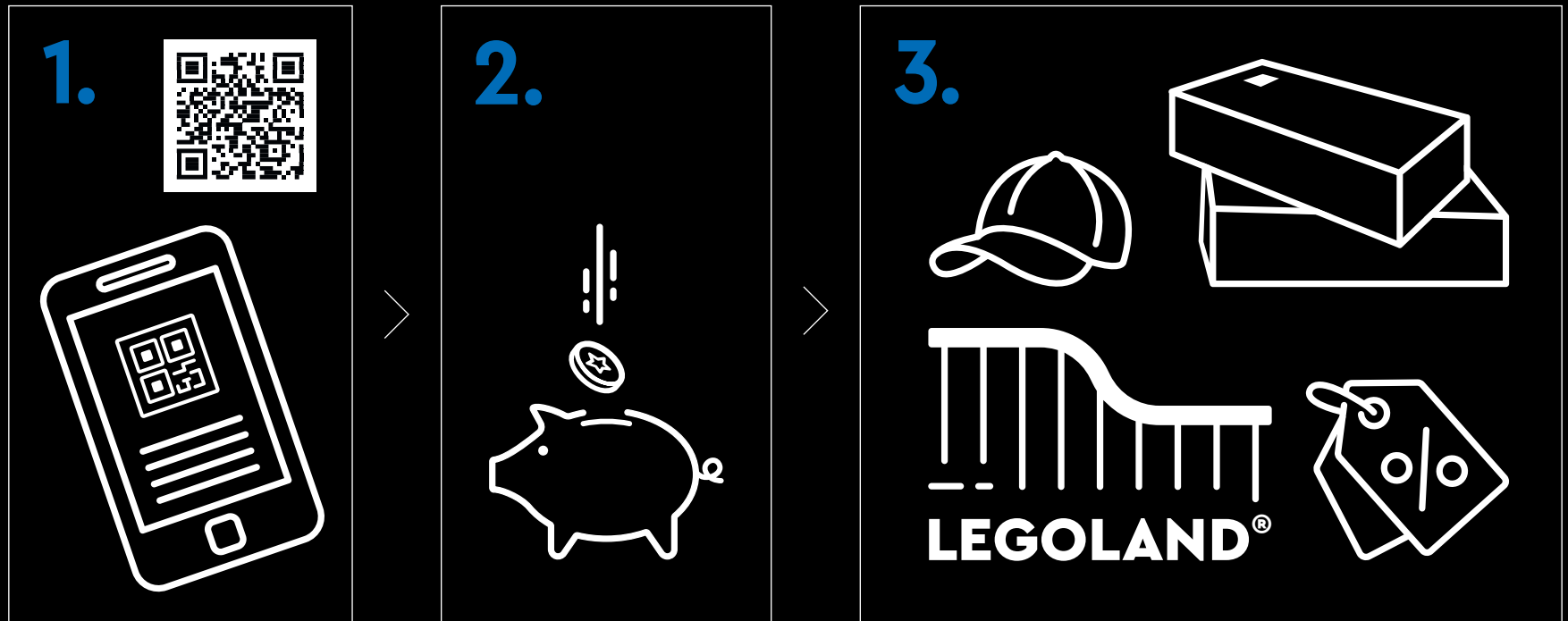

**1.** Sign up **2.** Earn points for purchases **3.** Redeem points for rewards, experiences, discounts & more | **1.** Melde dich an **2.** Sammle Punkte bei jedem Kauf **3.** Löse die Punkte für Belohnungen, Erlebnisse, Rabatte und Ähnliches ein | **1.** Inscrivez-vous **2.** Gagnez des points lors de vos achats **3.** Échangez vos points contre des récompenses, des expériences, des remises et bien plus encore | **1.** Iscriviti **2.** Guadagna punti con i tuoi acquisti **3.** Riscatta punti per premi, esperienze, sconti e altro ancora | **1.** Regístrate **2.** Gana puntos por tus compras **3.** Canjea puntos por recompensas, experiencias, descuentos y mucho más | **1.** Registe-se **2.** Ganhe pontos em compras **3.** Troque os pontos para prémios, experiências, descontos e muito mais | **1.** 注册 **2.** 购物赚积分 **3.** 用积分兑换奖励、体验、折扣等 | **1.** Zarejestruj się **2.** Zdobywaj punkty za zakupy **3.** Wymieniaj punkty na rabaty, przygody i inne nagrody | **1.** Zaregistrujte se **2.** Sbírejte body za nákupy **3.** Vyměňujte body za odměny, zážitky, slevy a spoustu dalšího | **1.** Zaregistrujte se **2.** Získavajte body za nákupy **3.** Uplatnite si body a získajte odmeny, rôzne zážitky, zľavy a ešte viac | **1.** Regisztrálj **2.** Szerezz pontokat minden vásárlással **3.** Váltsd be pontjaidat jutalmakra, élményekre, kedvezményekre és egyebekre | **1.** Înscric-te **2.** Câștigă puncte pentru achiziții **3.** Valorifică puncte pentru recompense, experiențe, reduceri și multe altele | **1.** Регистрируйте се **2.** Получайте точки за покупки **3.** Используйте точки за награды, услуги, отстъпки и т.н. | **1.** Reģistrējies **2.** Pelni punktus par pirkumiem **3.** Izmanto punktus, lai saņemtu balvas, izklaides iespējas, atlaides un daudz ko citu | **1.** Registreeru **2.** Teeni ostude eest punkte **3.** Lunasta punktide eest preemiad, elamused, allahindlused ja muu | **1.** Užsiregistruokite **2.** Pelnykite taškus už pirkinius **3.** Panaudokite taškus atlygiui, funkcijoms, nuolaidoms ir ne tik







## HOGWARTS™ – UNA STORIA (MOLTO BREVE)

Costruita più di 1.000 anni fa, in un'epoca in cui il nostro mondo Babbano non vedeva di buon occhio streghe e maghi, la Scuola di Magia e Stregoneria di Hogwarts™ divenne un punto di riferimento architettonico e storico, e accuratamente nascosto. I suoi fondatori, Godric Grifondoro, Priscilla Corvonero, Tosca Tassorosso e Salazar Serpeverde, condividevano la stessa sete di saggezza e di conoscenza e, con Hogwarts come base, desideravano educare le nuove generazioni di giovani streghe e maghi nella migliore scuola di magia del mondo.

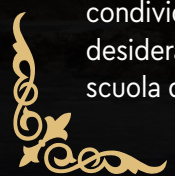

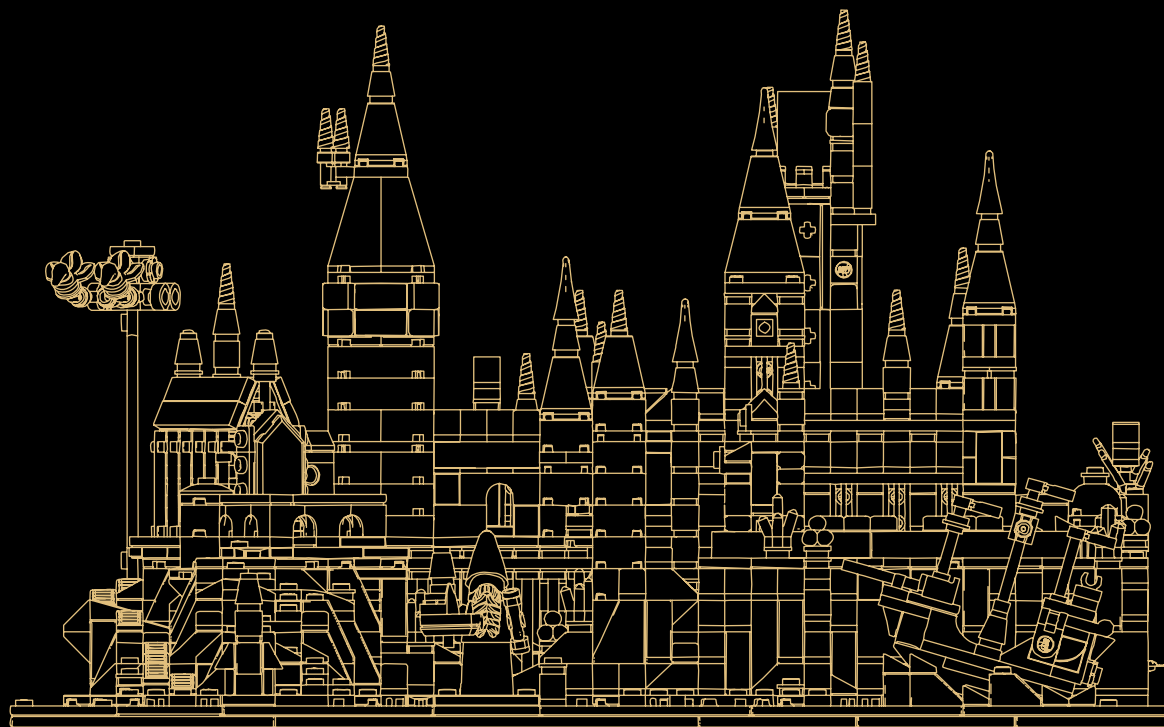

## L'ARCHITETTO DI HOGWARTS™

I fondatori chiesero l'aiuto del famoso Architetto di Hogwarts™ per costruire un castello nelle Highlands scozzesi, con quattro Case a rappresentare ciascuna i valori dei maghi. Nel corso dei secoli, il castello ha assunto una propria vita magica, con i suoi piani, le torri e le aule collegate da scale che si muovono, stanze segrete protette da incantesimi, e i fantasmi e i ritratti viventi di famosi ex occupanti, presidi e direttrici che ispirano, guidano e talvolta prendono in giro i giovani studenti!









## SCALA IN MINIATURA, MASSIMO LIVELLO DI DETTAGLI

"Prima di entrare a far parte del LEGO Group, ero un architetto, quindi per me è stato logico affrontare questo modello come un vero e proprio case study di architettura. Ho studiato disegni, bozzetti e un modello da studio in scala 1:24 del castello utilizzato in diversi film di Harry Potter™. Abbiamo quindi misurato tutte le proporzioni e tradotto il modello originale in una scala ricca di dettagli, ma non troppo grande. Incorporare il ponte e parti del paesaggio esterno ci ha permesso di presentare il castello nella sua magnifica ambientazione. Il modello contiene anche dettagli magici tratti da diverse storie e film, come i tre ostacoli che proteggono la Pietra Filosofale, la Camera dei Segreti, l'arrivo della Carrozza di Beauxbatons e della Nave di Durmstrang, e il brusco atterraggio della Ford Anglia volante dei Weasley nel Platano Picchiatore. Infine, ma cosa non meno importante, abbiamo la minifigure dell'Architetto del Castello di Hogwarts™: dopo aver costruito questo set, anche tu sarai un architetto di Hogwarts! Goditi il tuo soggiorno alla Scuola di Magia e Stregoneria di Hogwarts!"

*Yi-Chien Cheng, LEGO® Senior Designer*





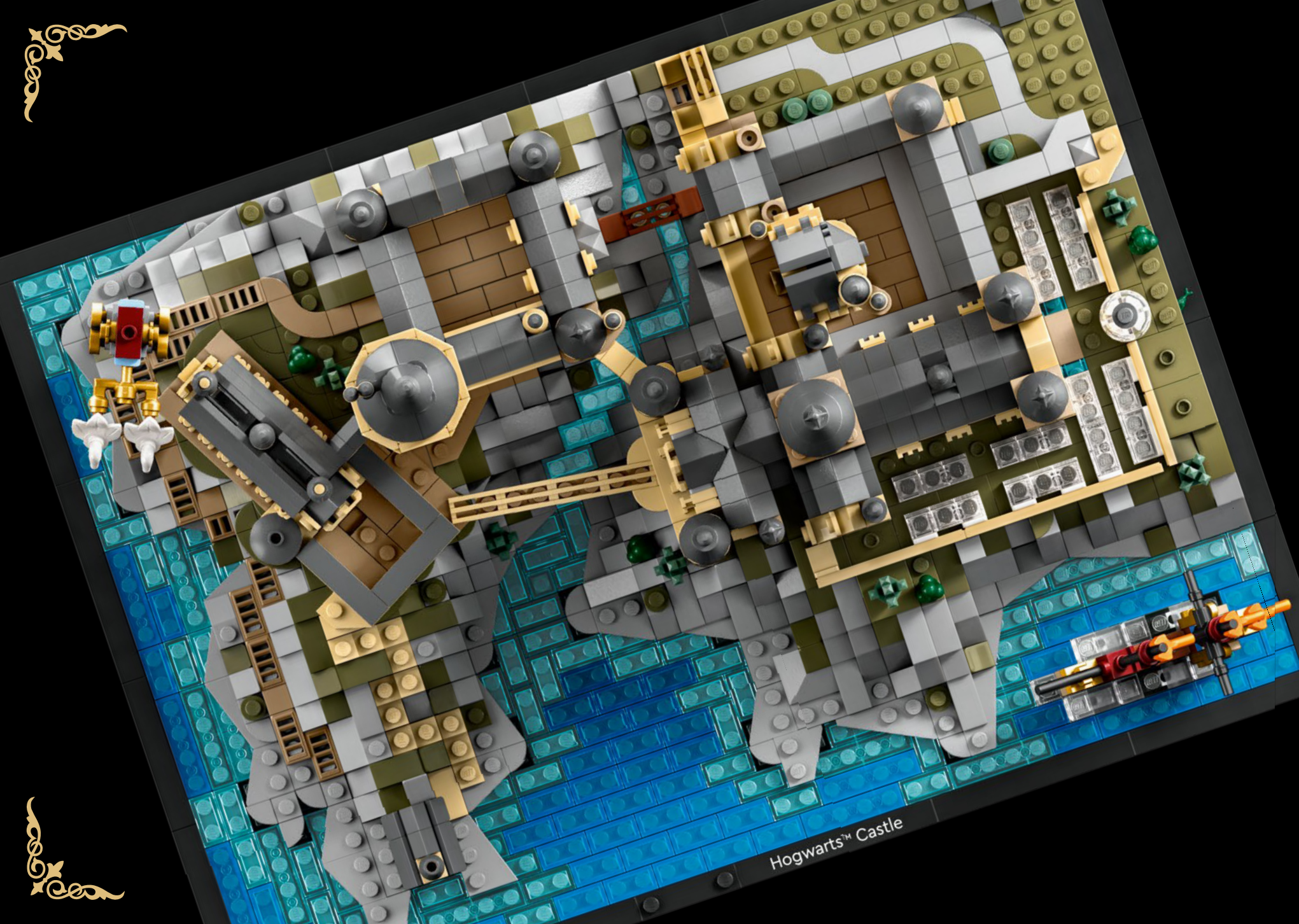

Hogwarts™ Castle







## UN TOUR DELLA TUA SCUOLA

Il Castello di Hogwarts™ svetta sulle sue fondamenta rocciose e si affaccia sul Lago Nero. È possibile visitare la Sala Grande, la Torre principale, il cortile, i ponti, la zona delle serre e la Torre astronomica. Nelle profondità dei sotterranei è custodito lo Specchio delle Emarb, ma non lasciarti tentare da sogni ad occhi aperti! Vai a lezione di Pozioni, tenta la fortuna con il Basilisco nella Camera dei Segreti o segui le orme di Harry Potter™, Hermione Granger™ e Ron Weasley™ nella Sala del Tranello del Diavolo, nella stanza della Chiave Alata e nella Sala della Scacchiera.

Salta sulla Carrozza di Beauxbatons per un volo panoramico, salva la Ford Anglia volante dei Weasley dalle grinfie del Platano Picchiatore o sali a bordo della Nave di Durmstrang che sorge dalle acque del Lago Nero.



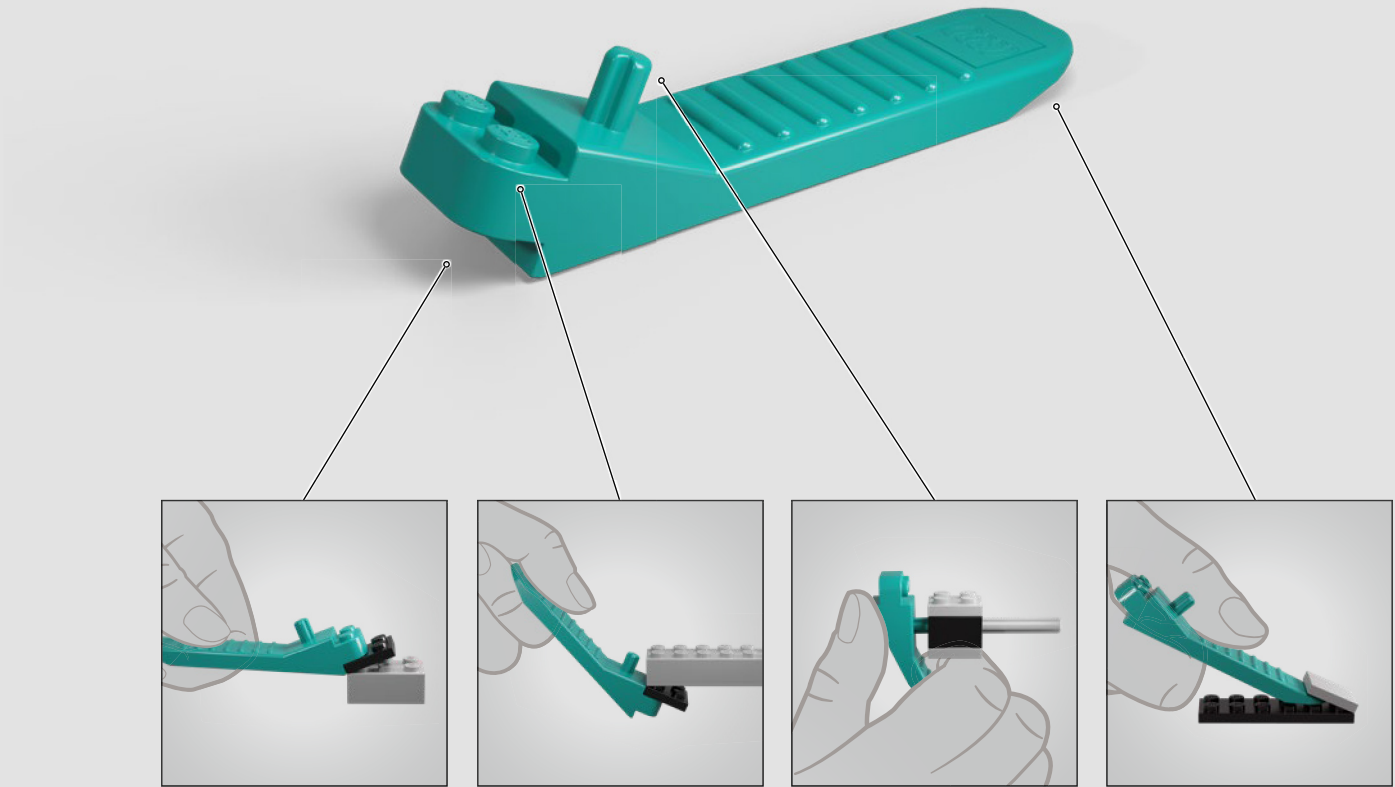

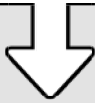





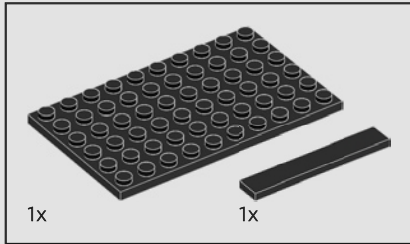
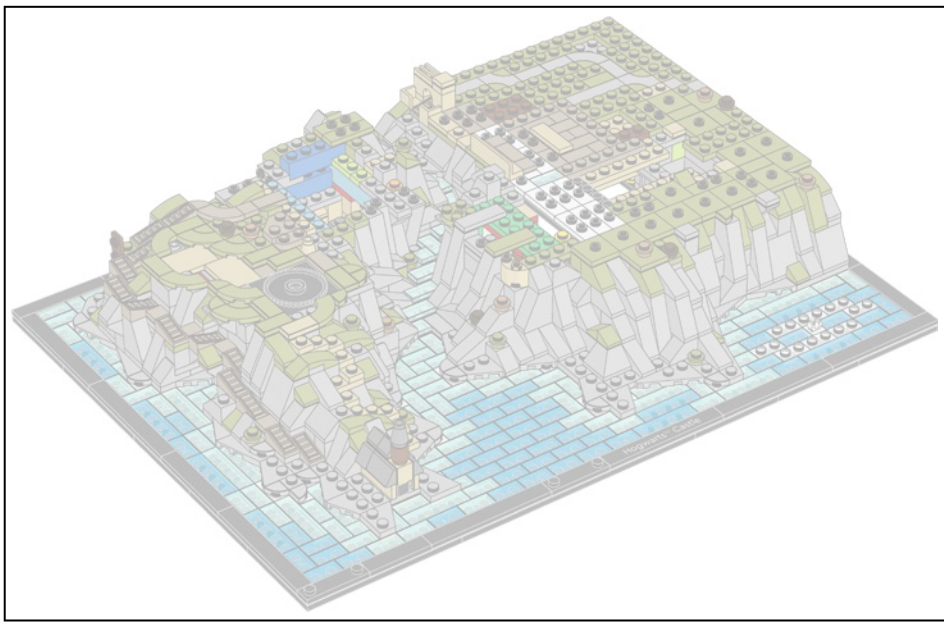

1

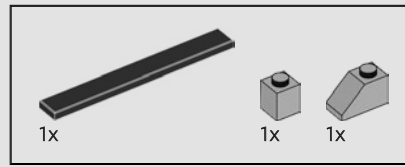
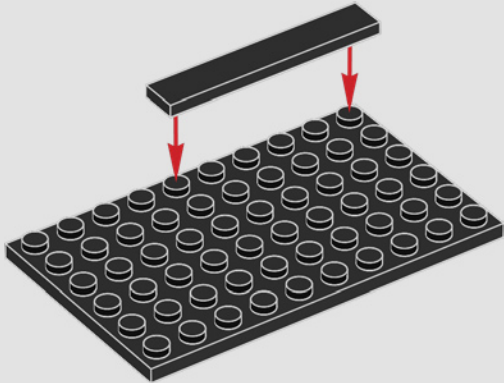

2

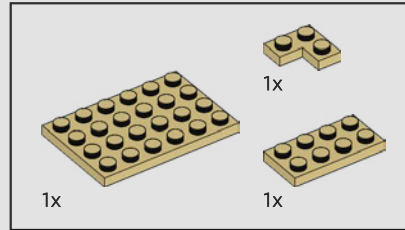
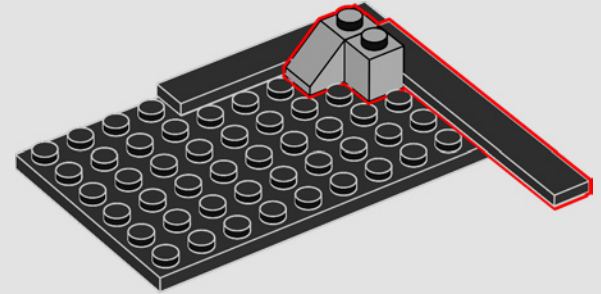

3

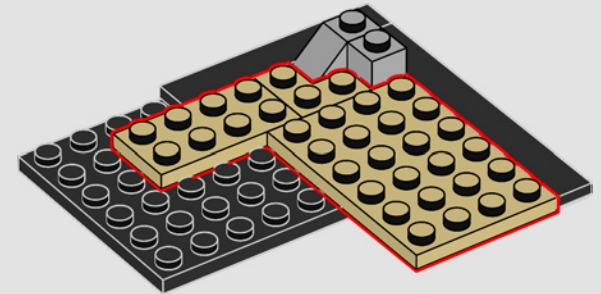

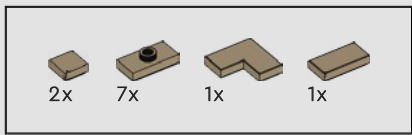

4

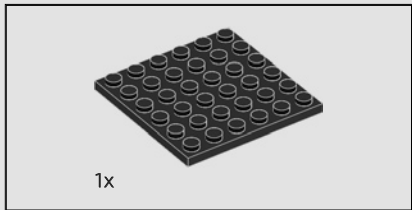
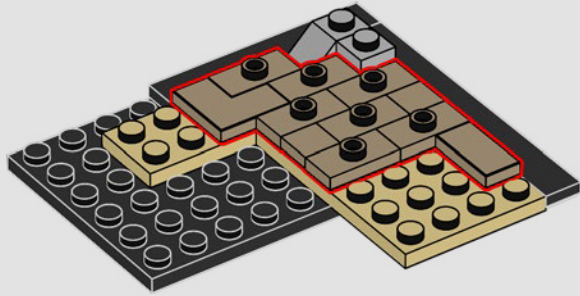

5

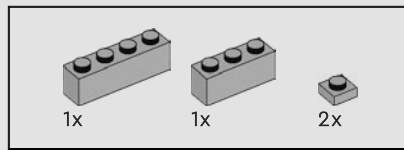
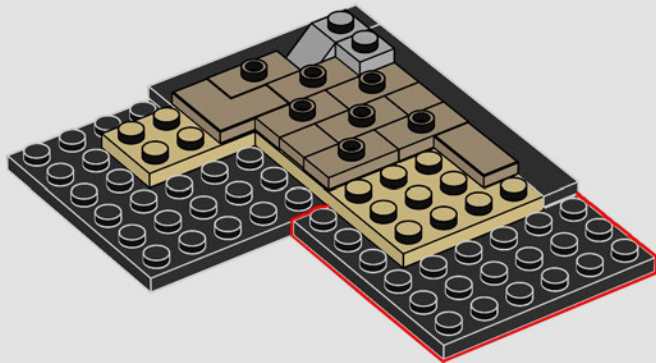

6

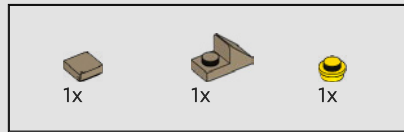
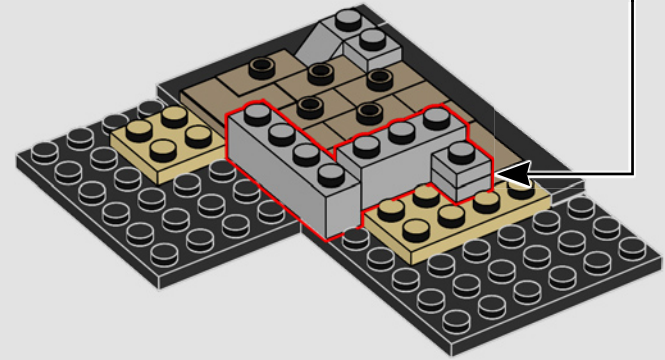

7

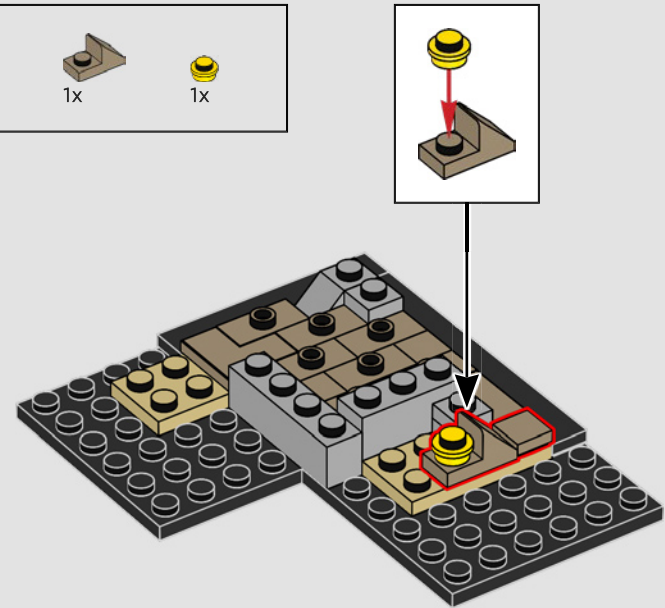



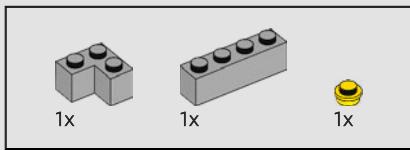

8

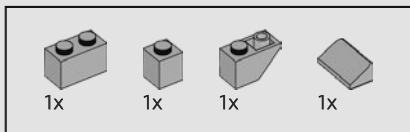
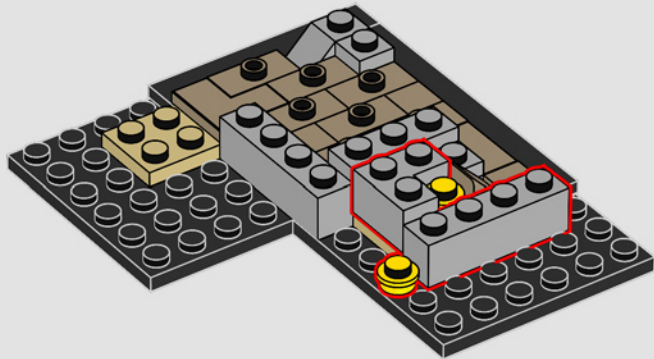

9

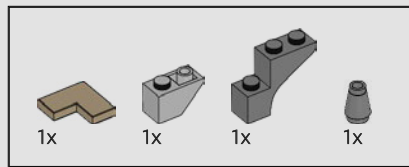
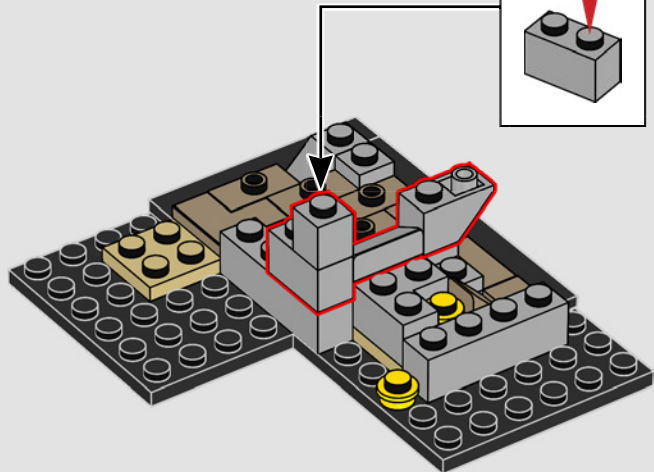

10

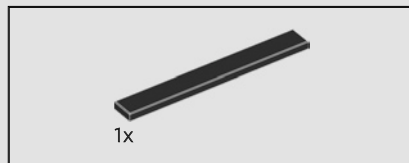
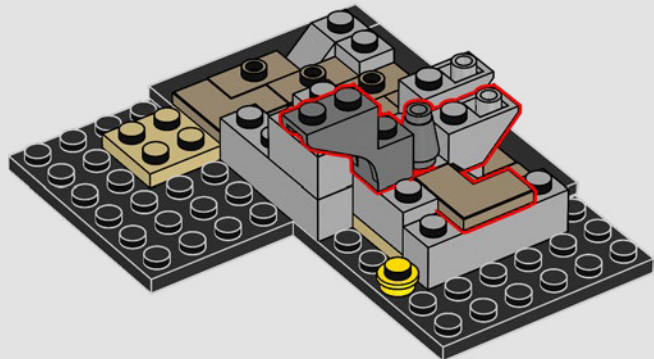

11

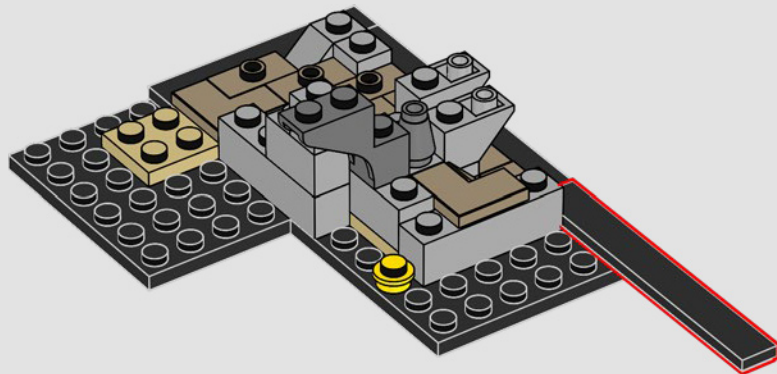

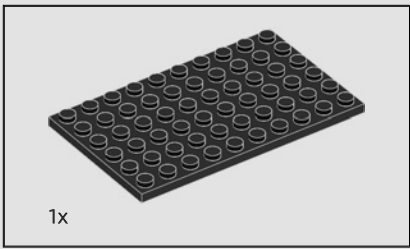

12

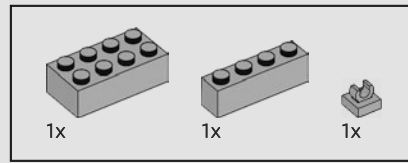
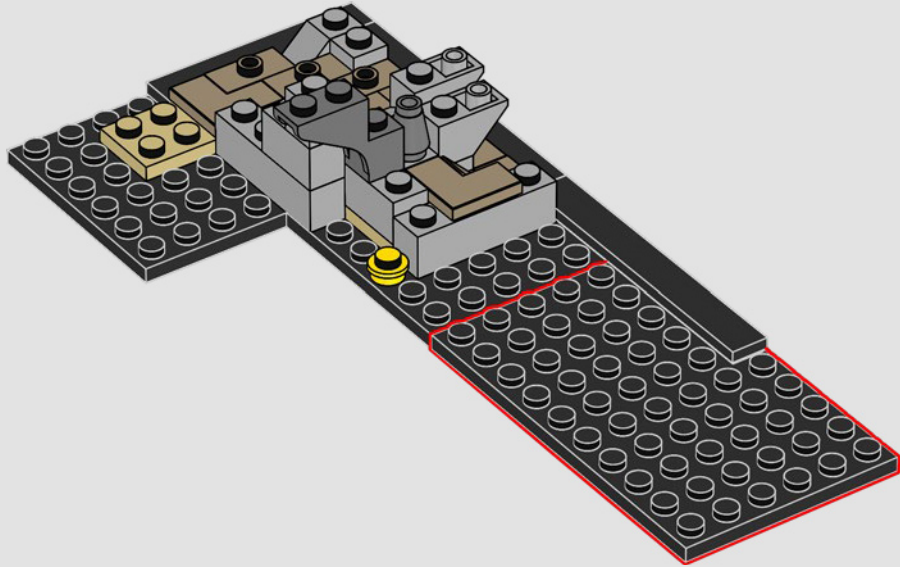

13

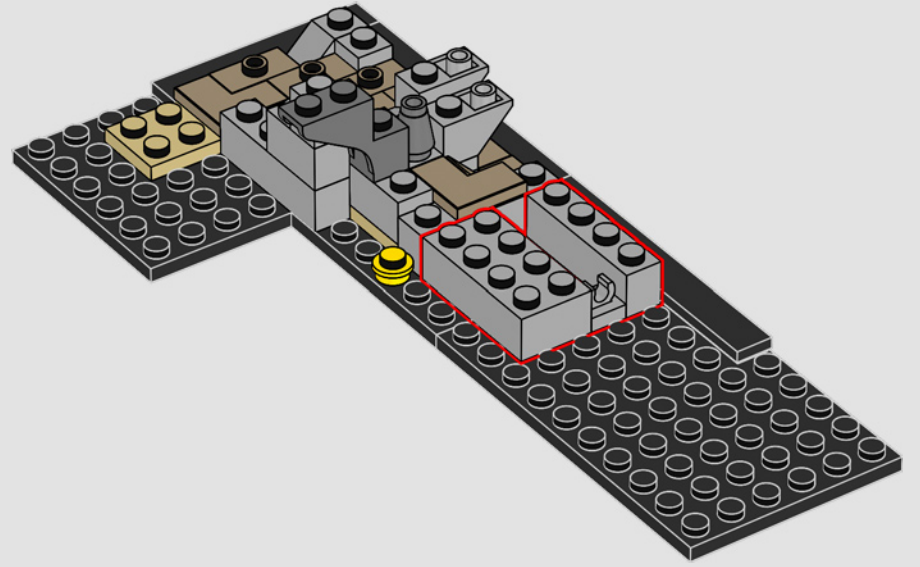



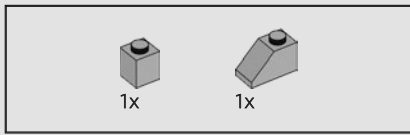

14

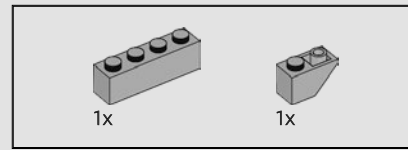
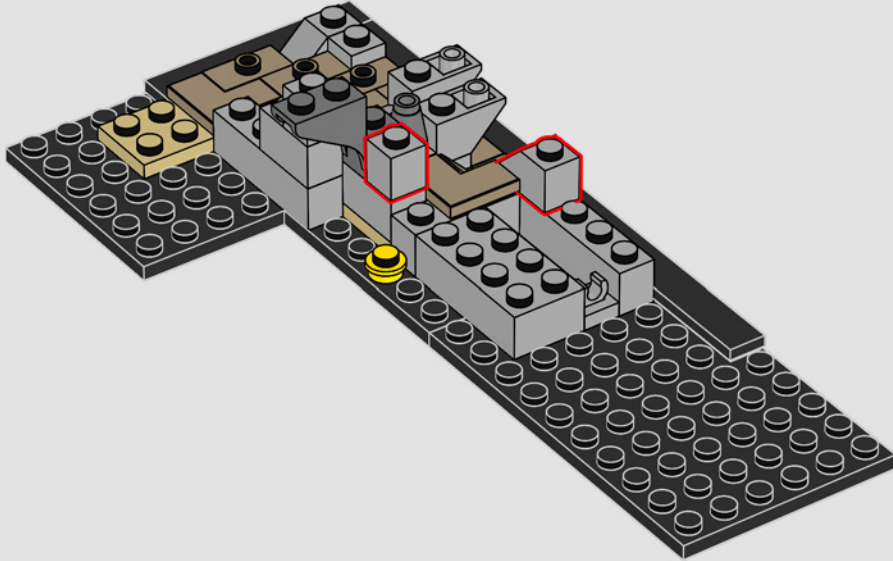

15

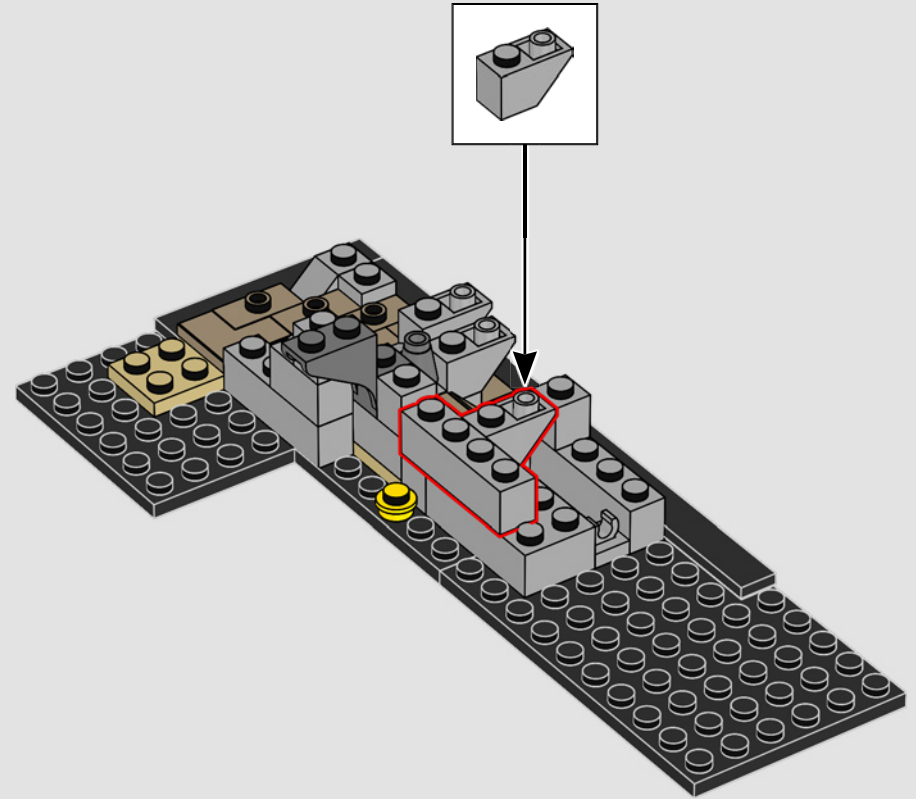

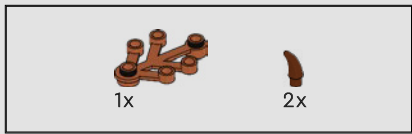

16

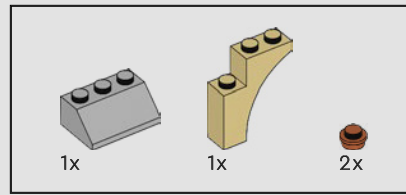
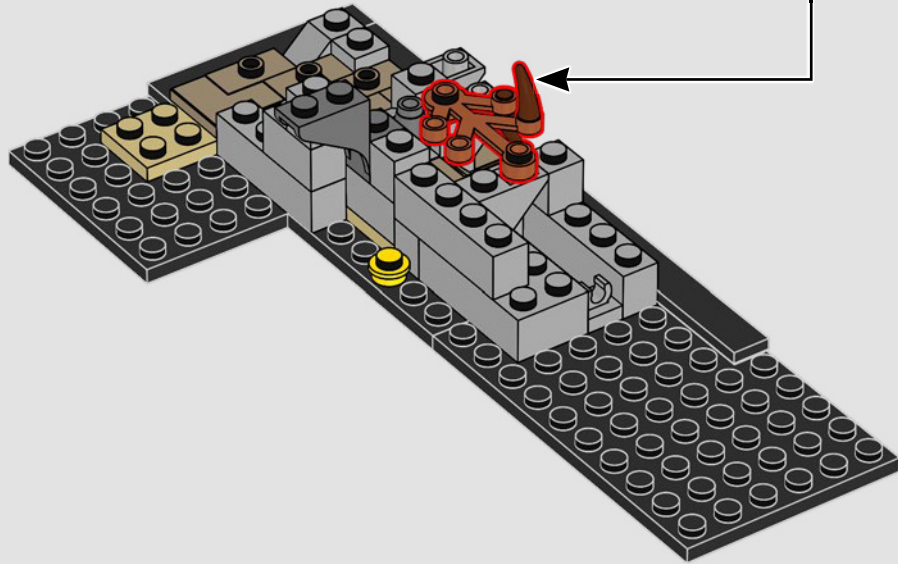
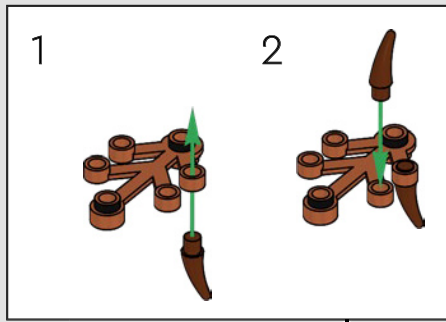

17

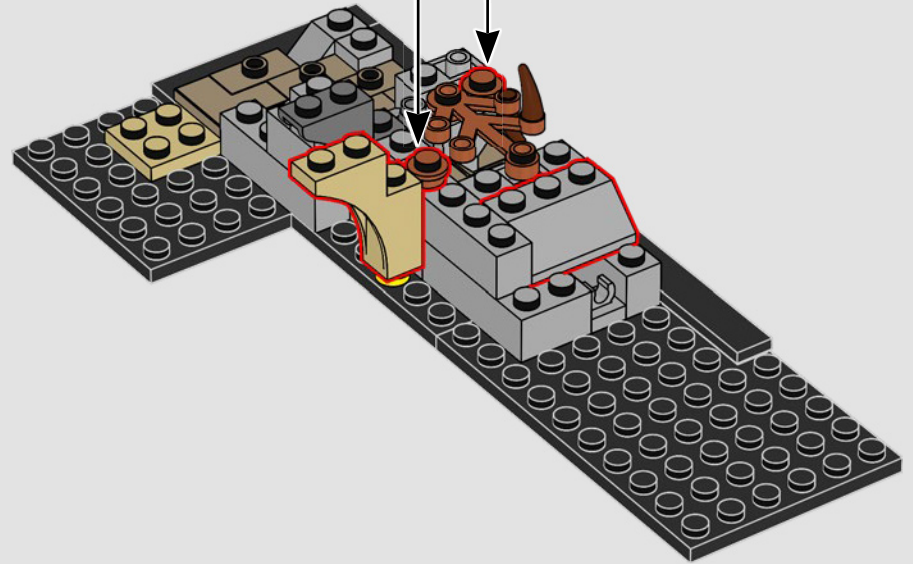



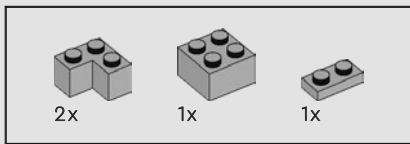

18

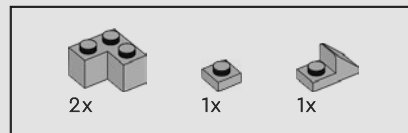
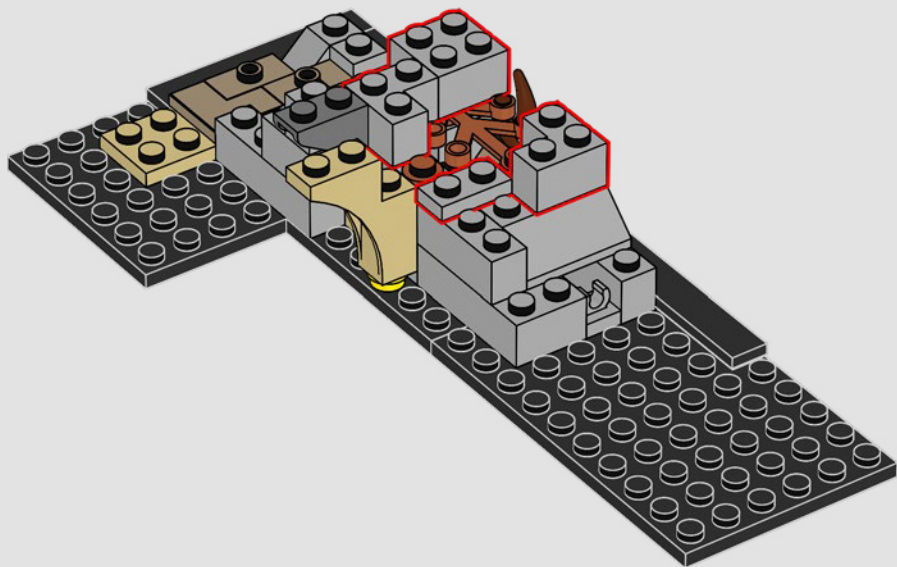

19

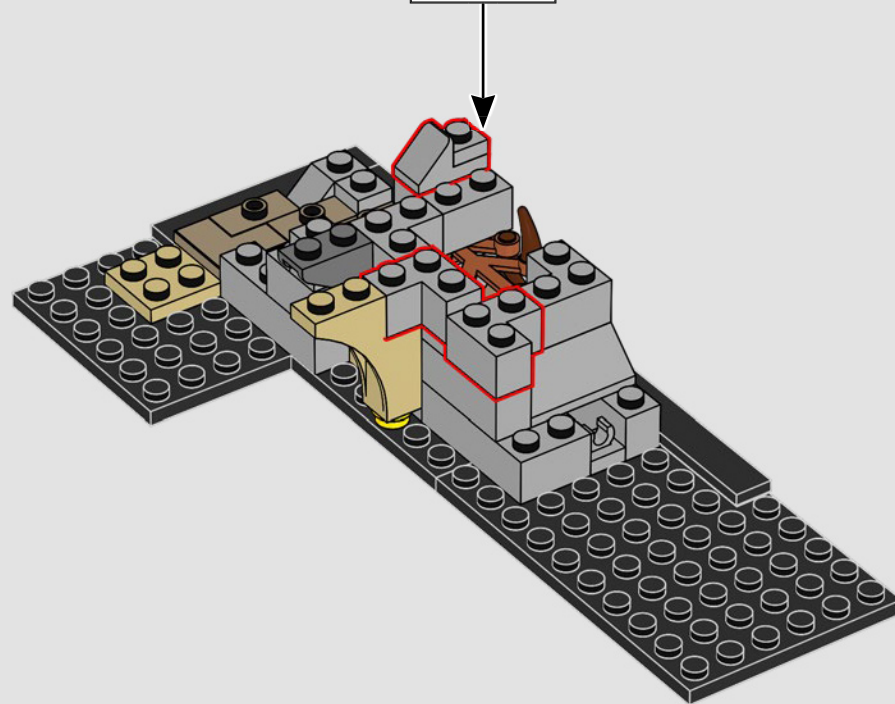
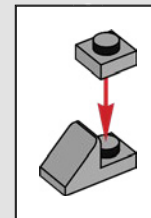

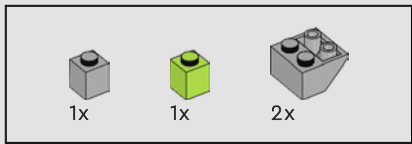

20

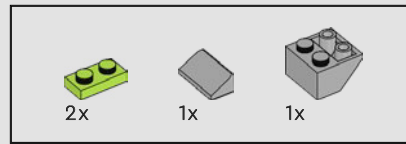
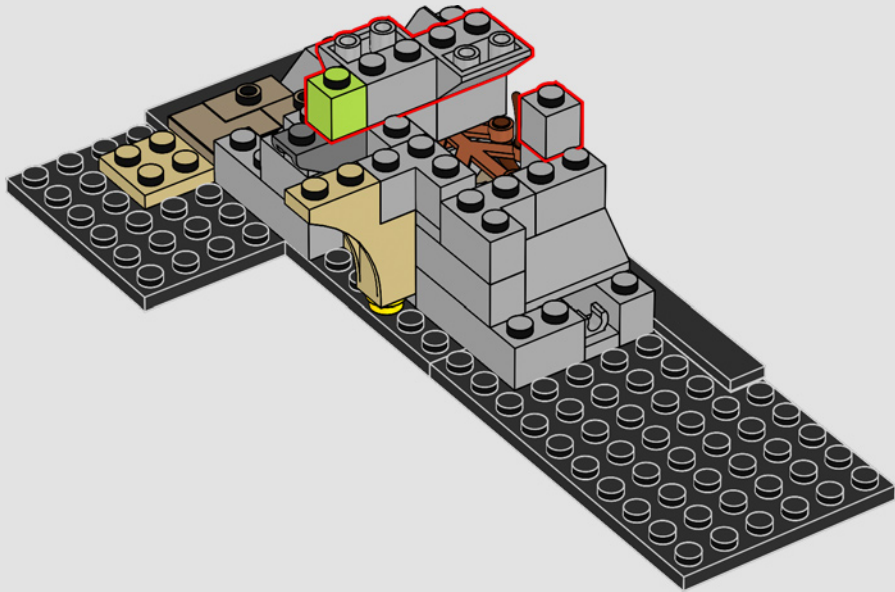

21

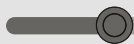
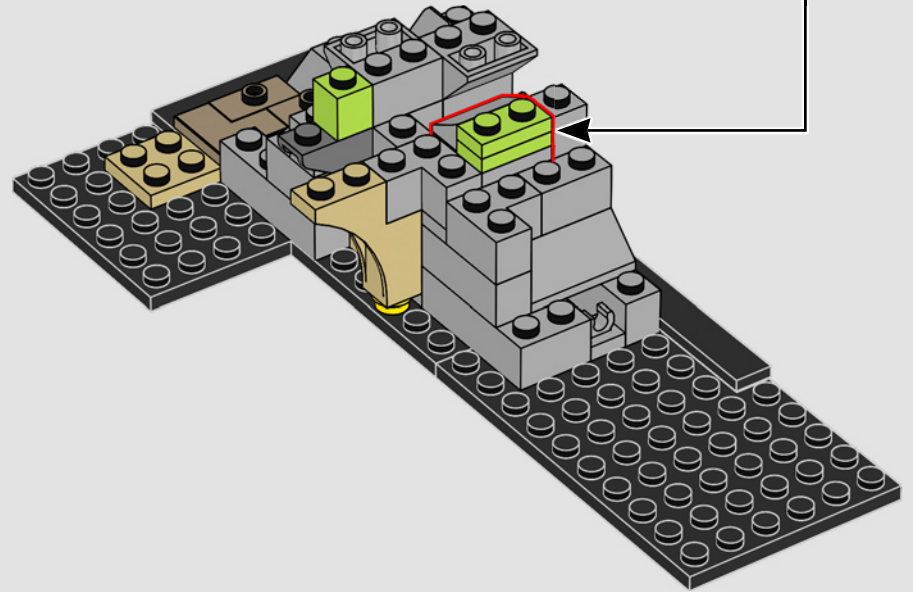
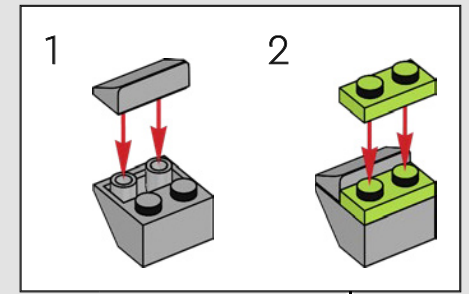



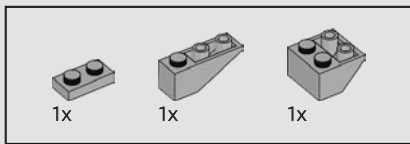

22

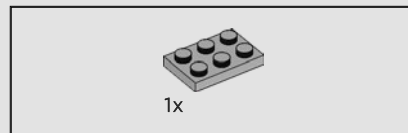
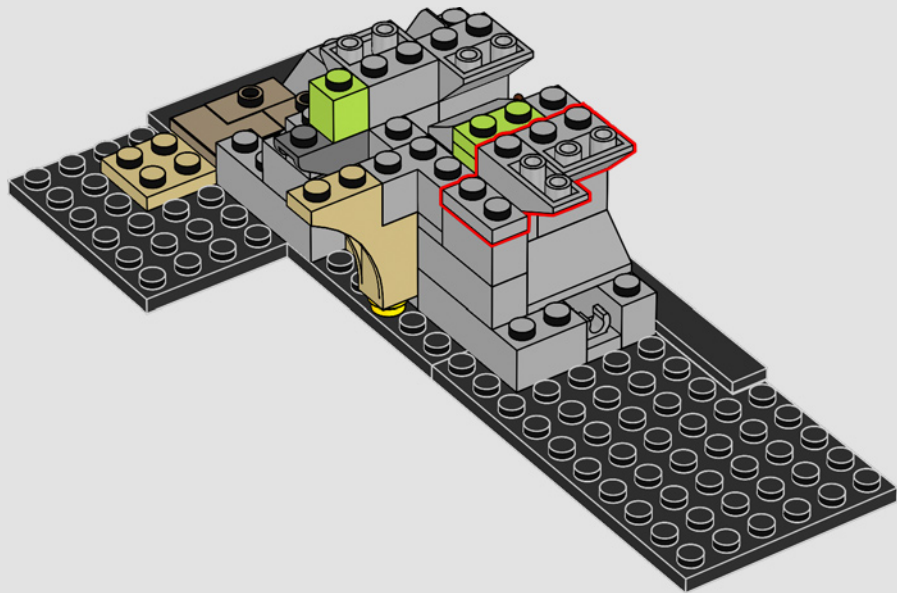

23

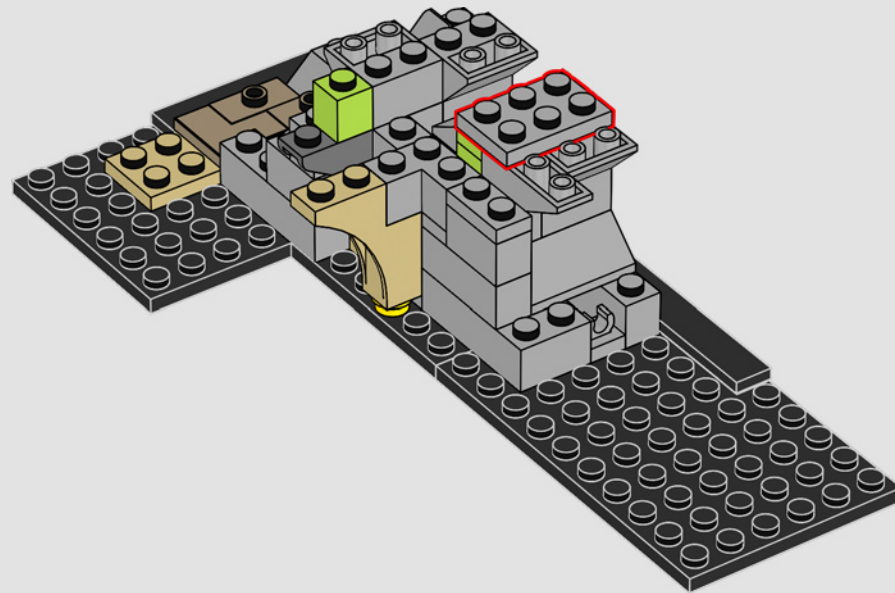

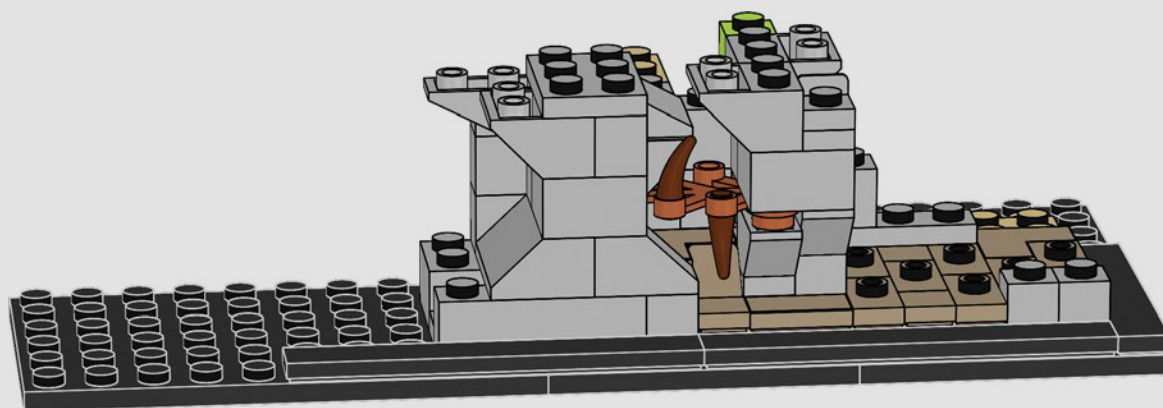

Il Tranello del Diavolo impedisce agli intrusi di raggiungere il nascondiglio segreto della Pietra Filosofale. Prospera nell'umidità e nell'oscurità. Se rimani intrappolato, mantieni la calma e apri le tende per far entrare il sole!



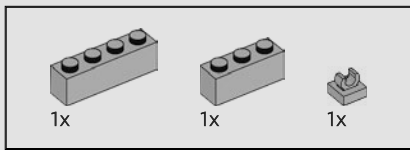

24

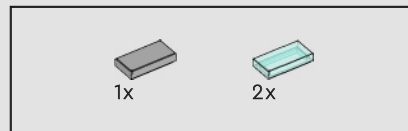
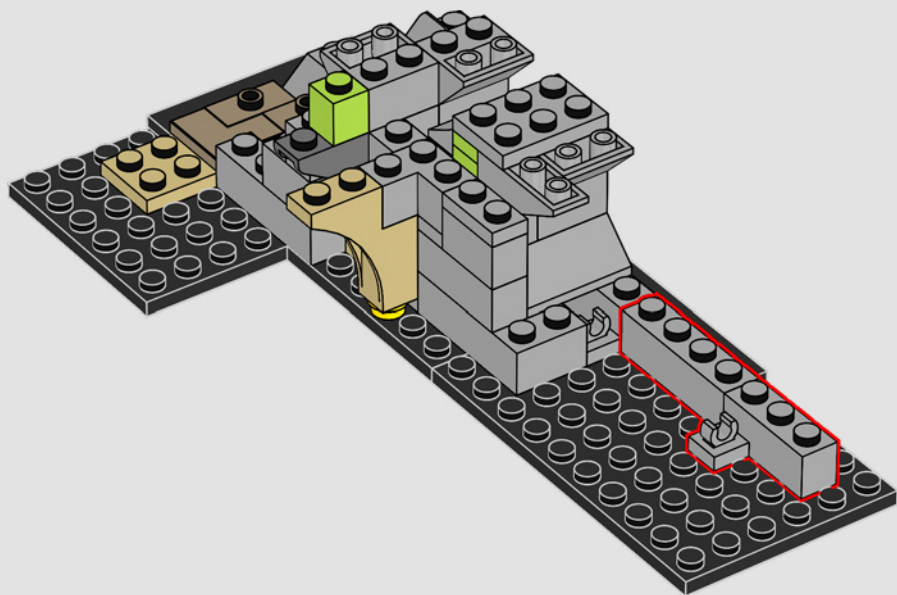

25

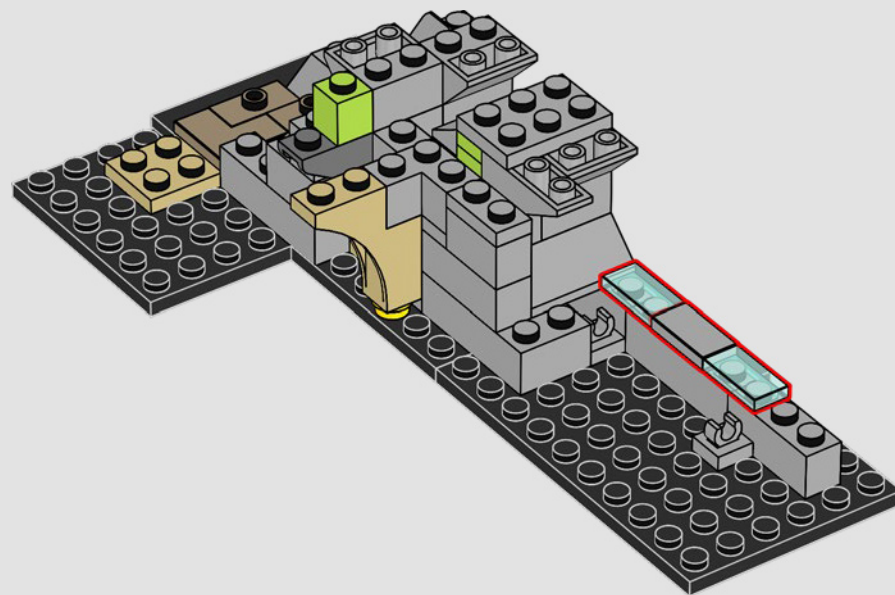



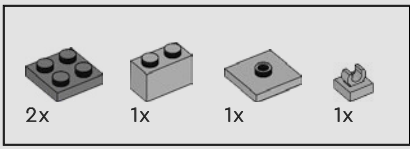

26

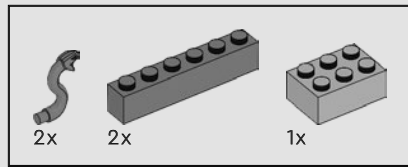
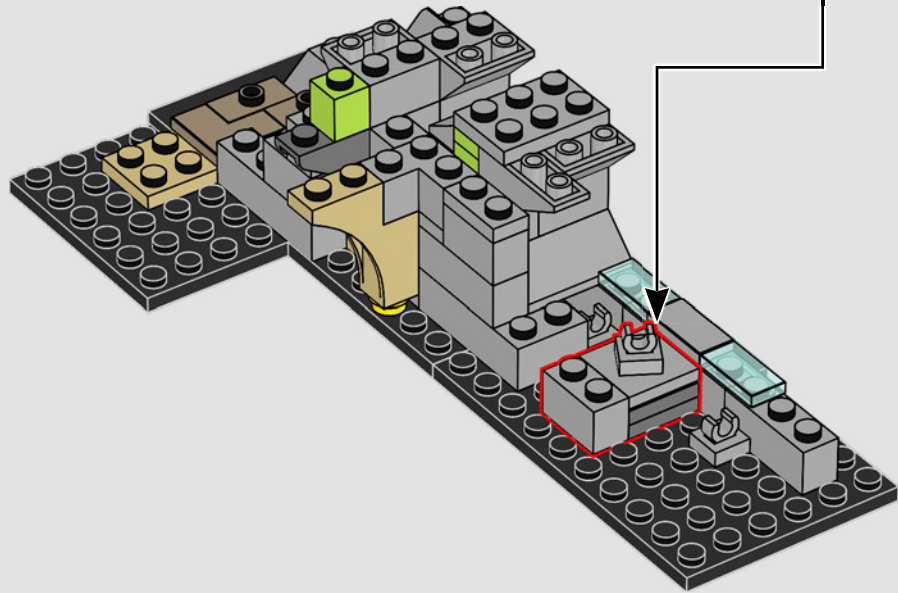
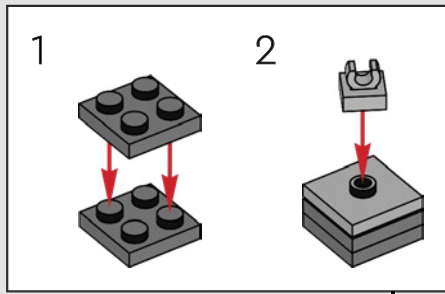

27

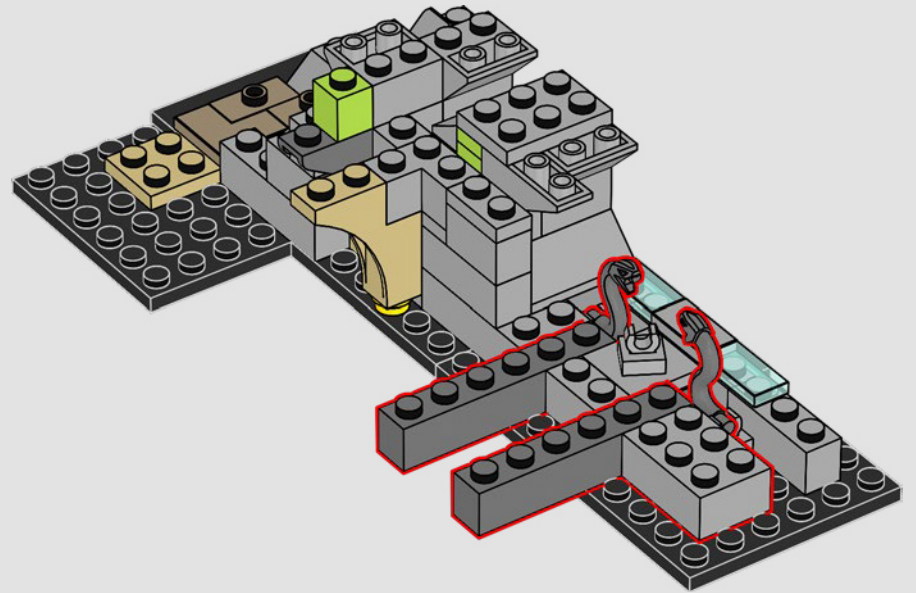

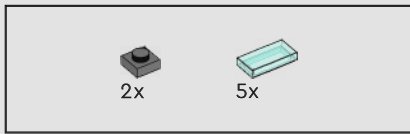

28

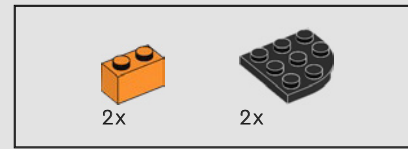
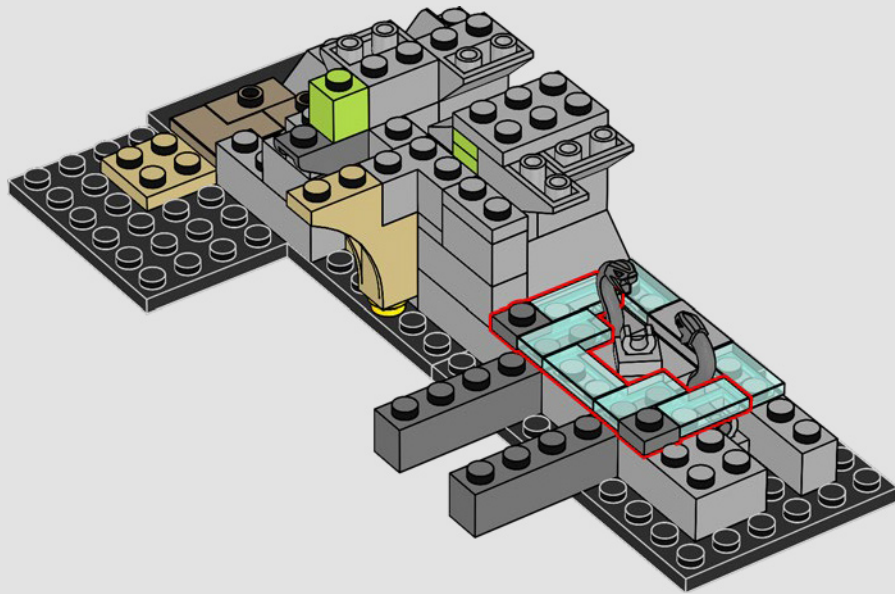

29

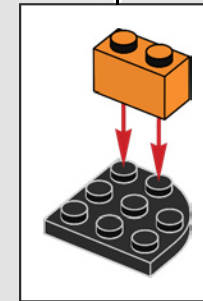
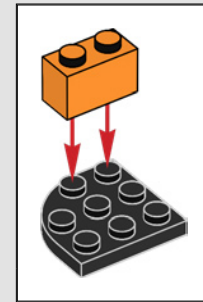
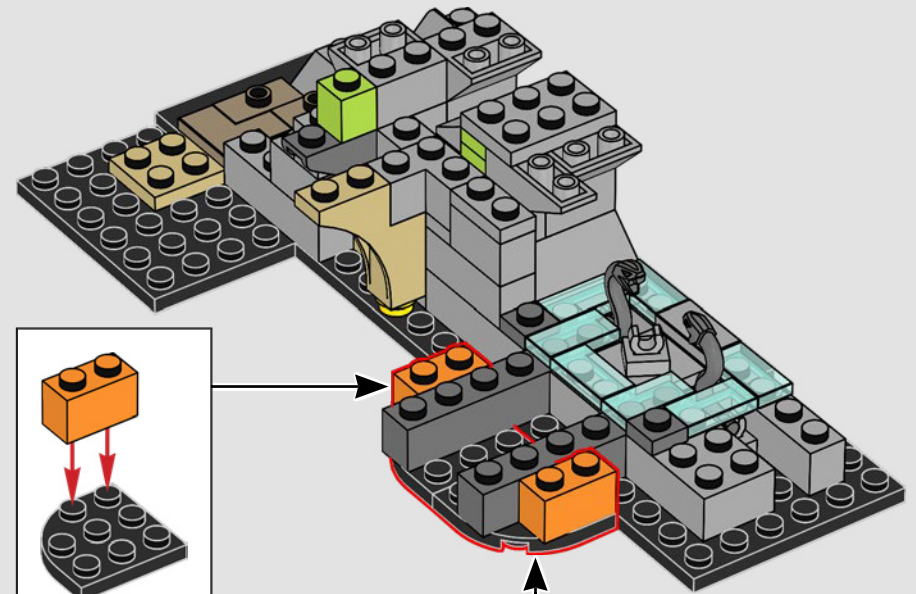

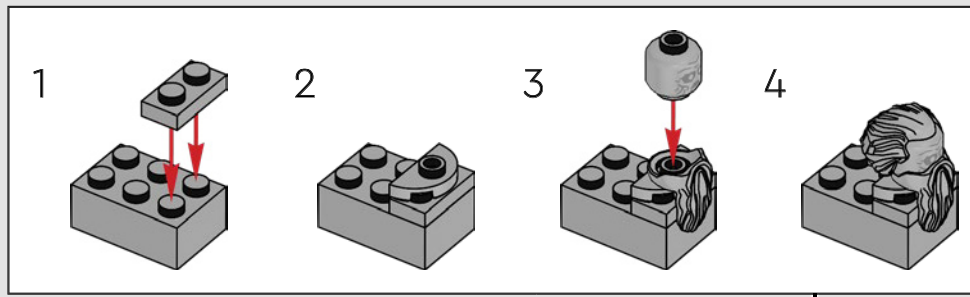
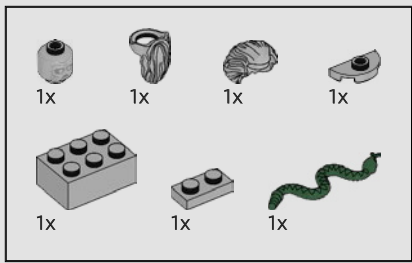

30

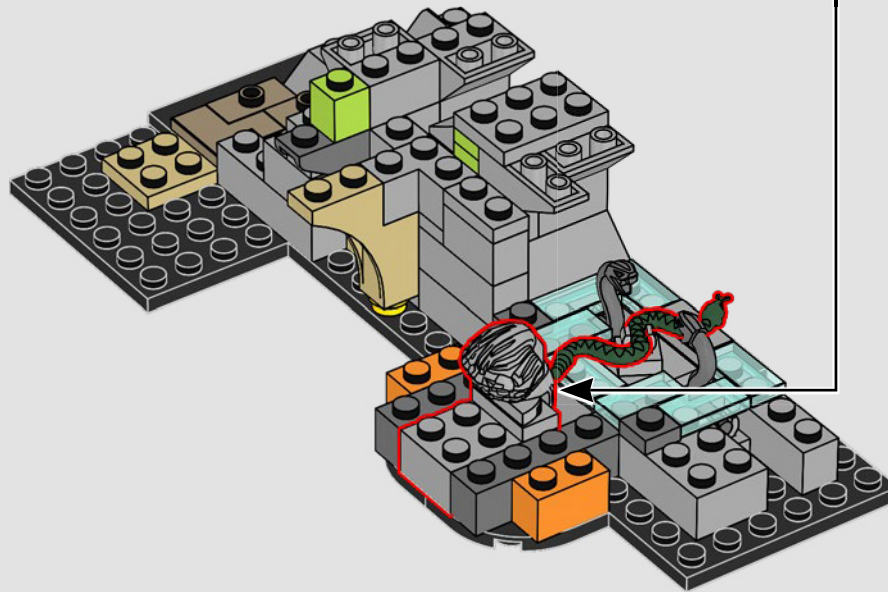



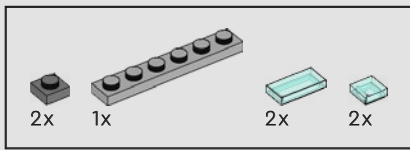

31

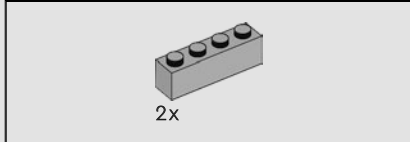
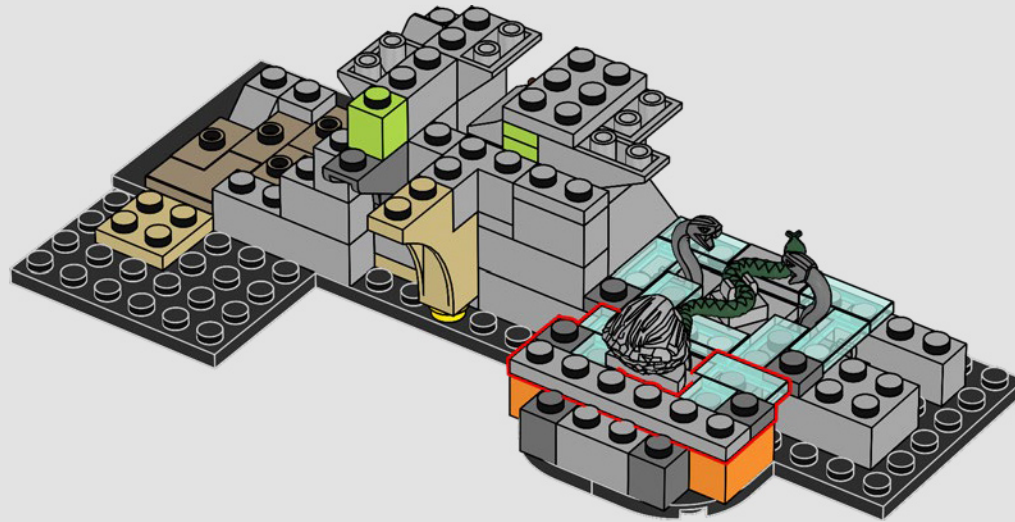

32

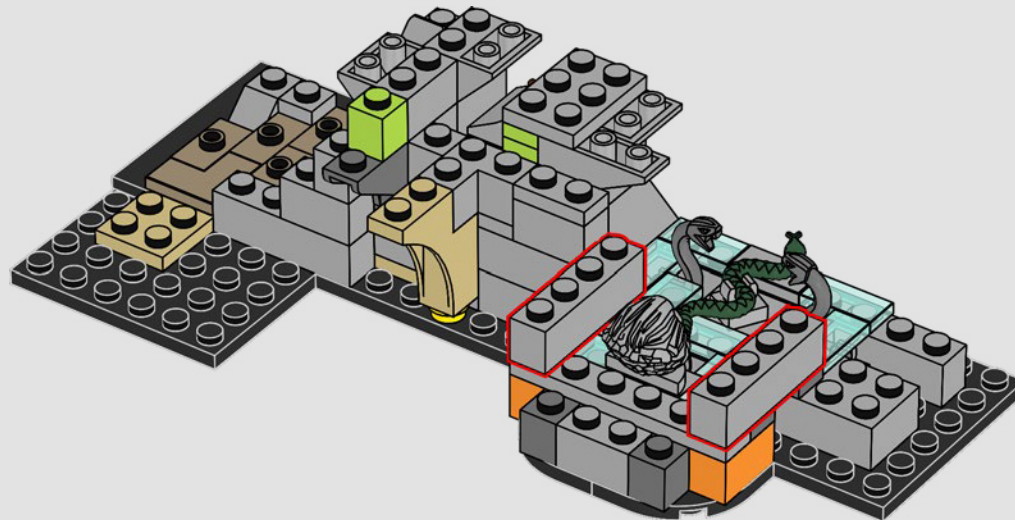

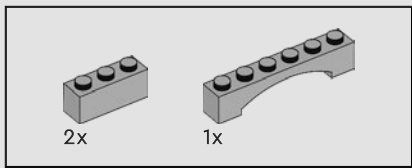

33

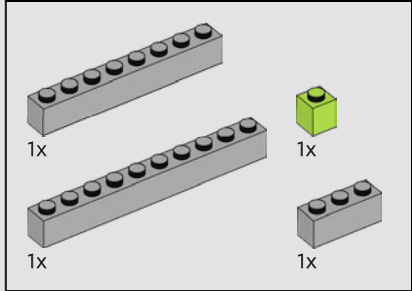
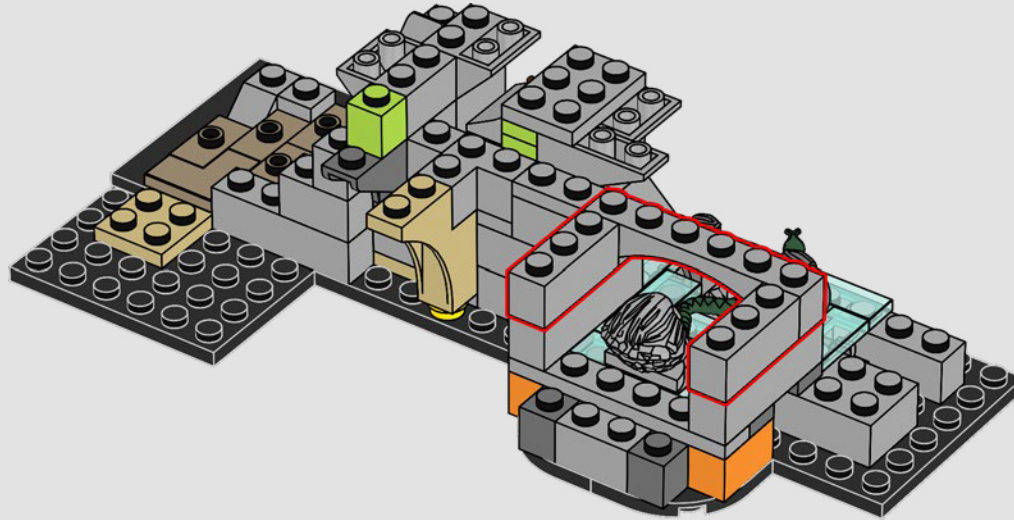

34

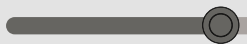
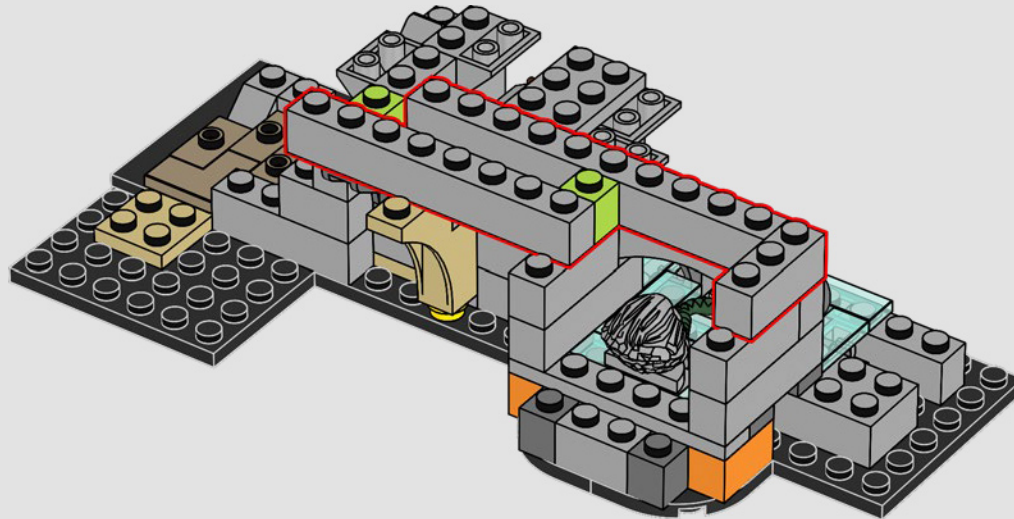

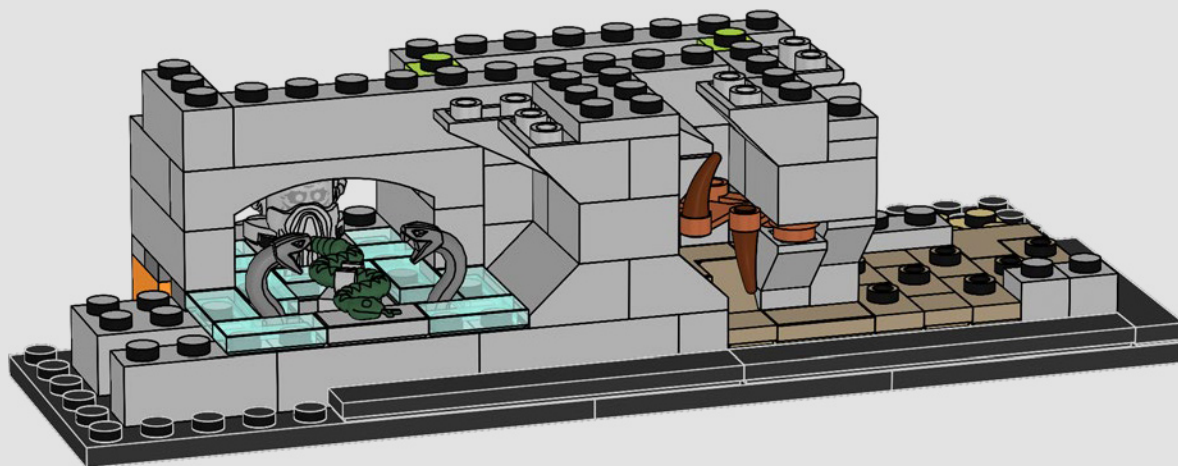

Come ultimo atto di sfida, Salazar Serpeverde costruì la Camera dei Segreti. Stregò un enorme Basilisco per onorare il suo "vero erede" e distruggere spietatamente tutti i Babbani.





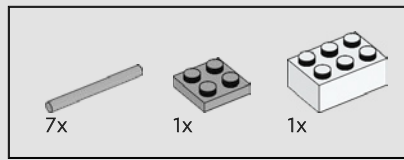

35

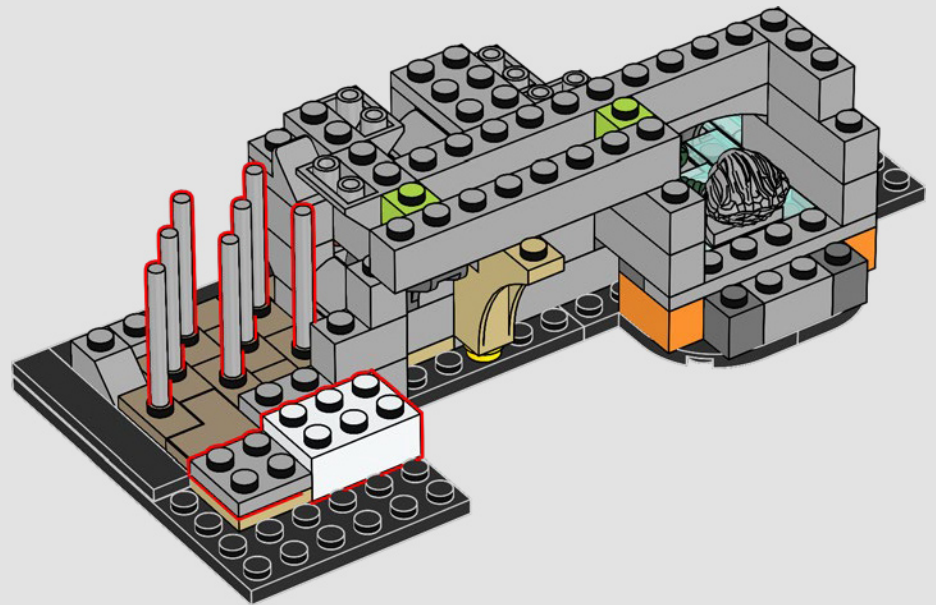

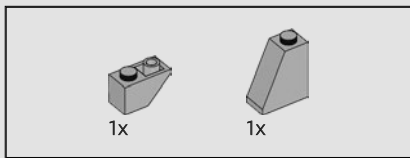

36

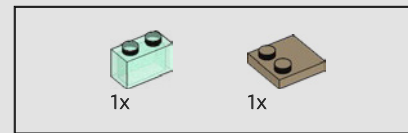
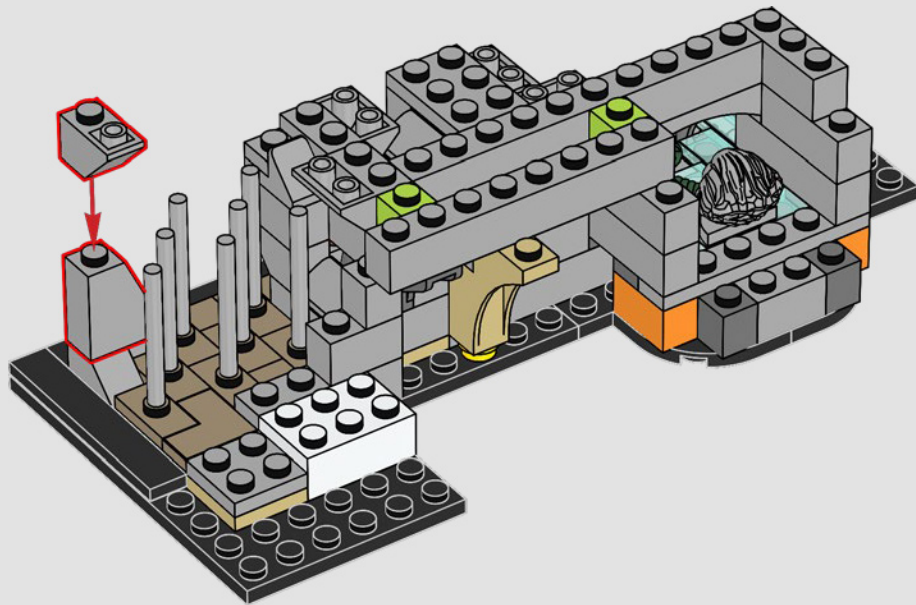

37

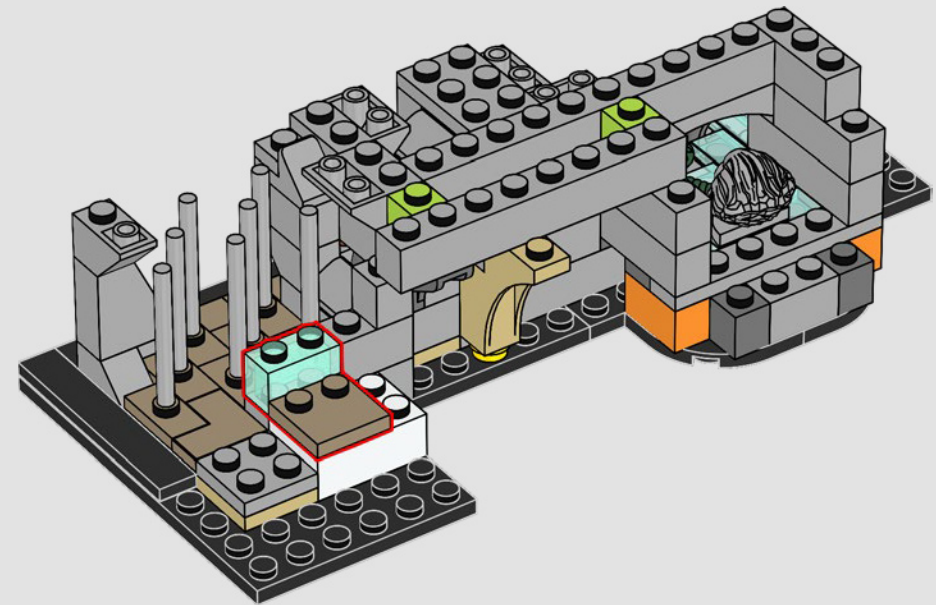

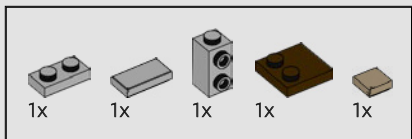

38

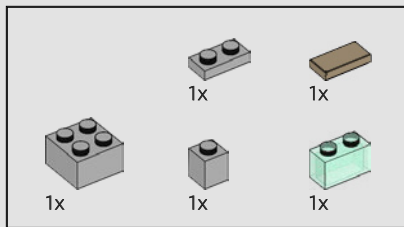
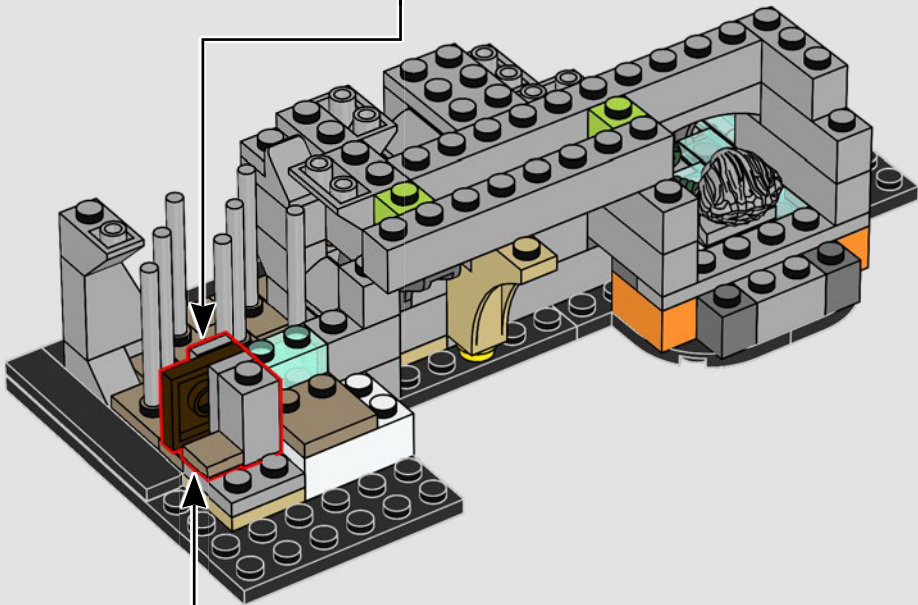
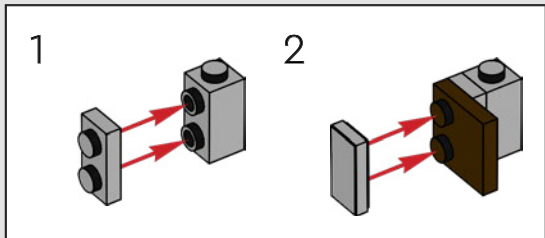

39

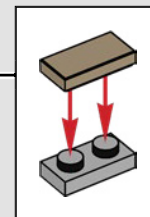
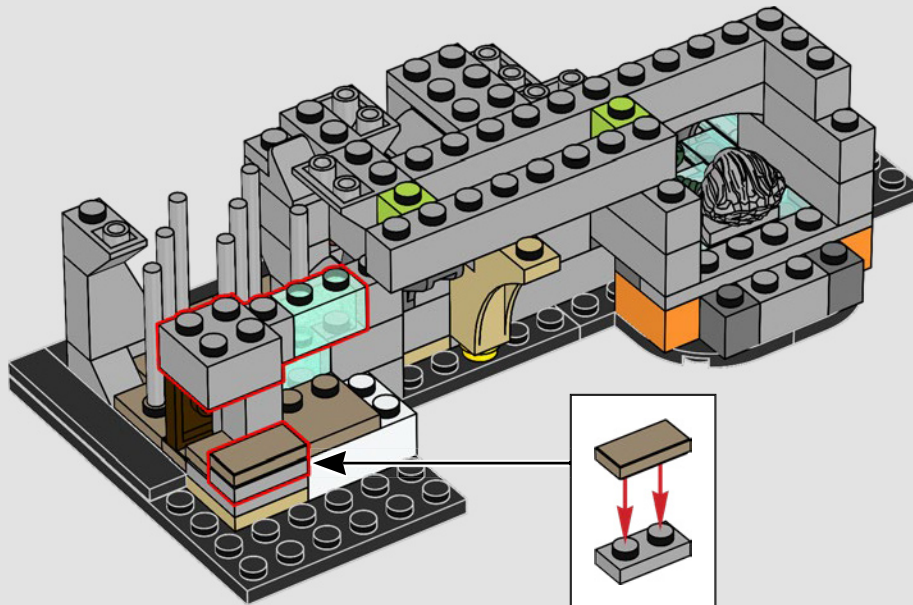



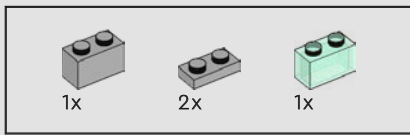

40

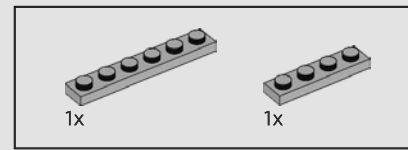
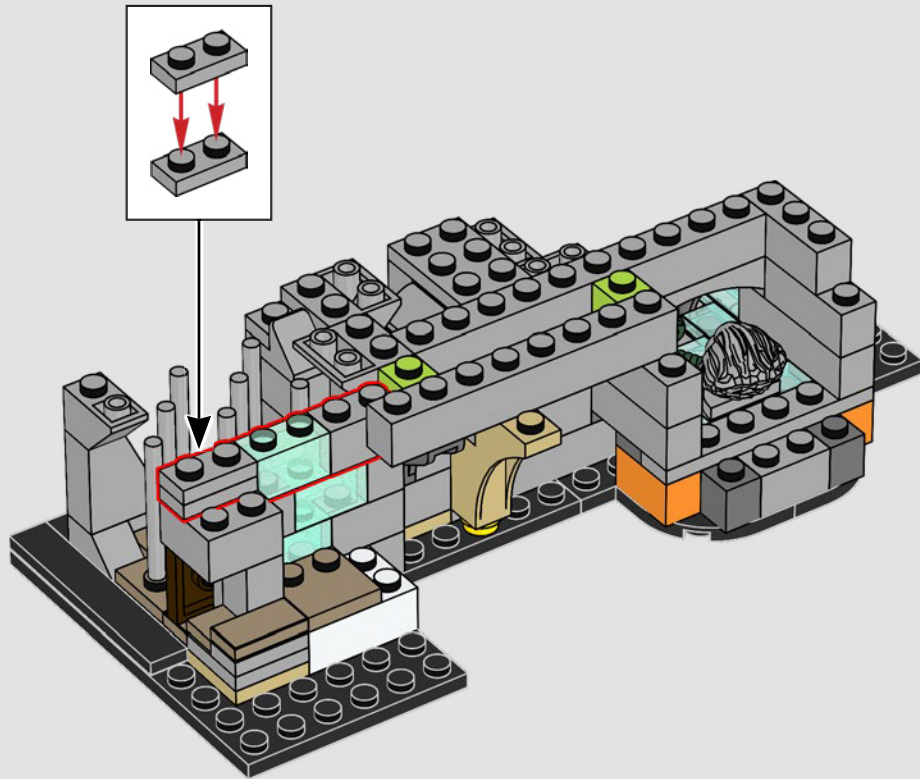

41

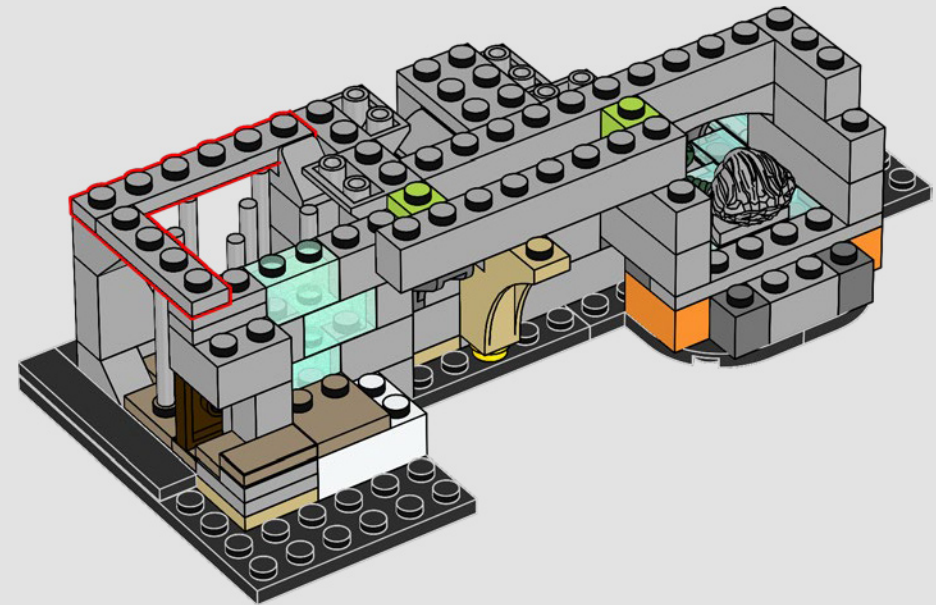

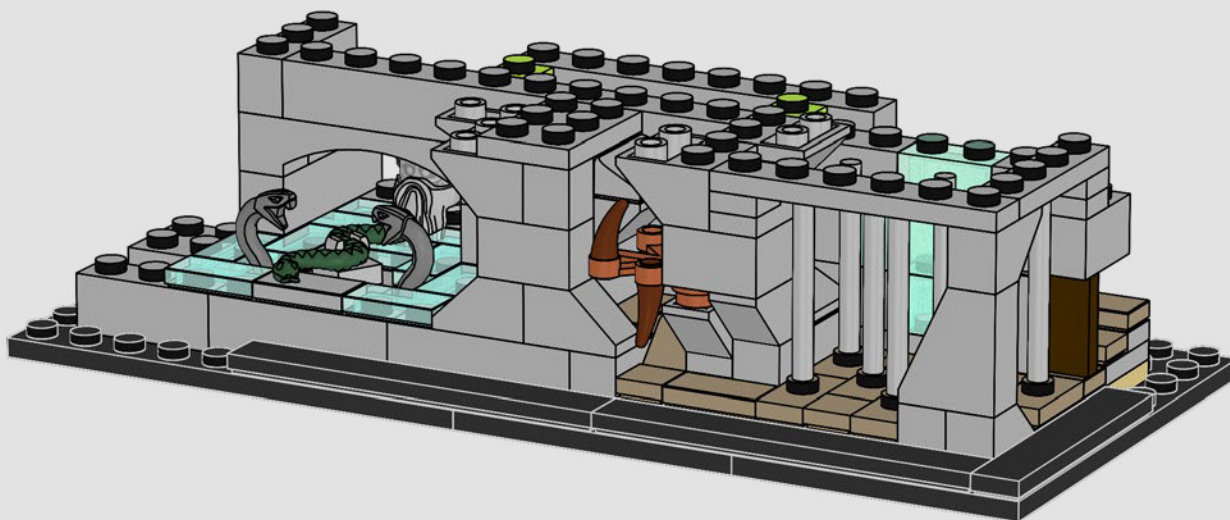

La stanza della Chiave Alata fu realizzata dall'ingegnoso Professor Vitious come uno degli ostacoli destinati a proteggere il nascondiglio segreto della Pietra Filosofale.

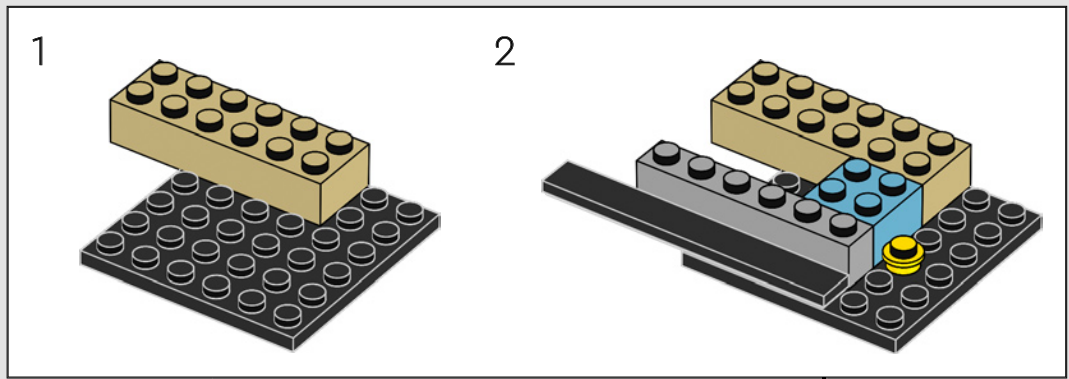
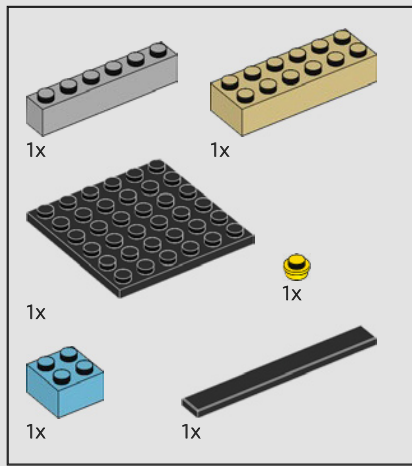

42

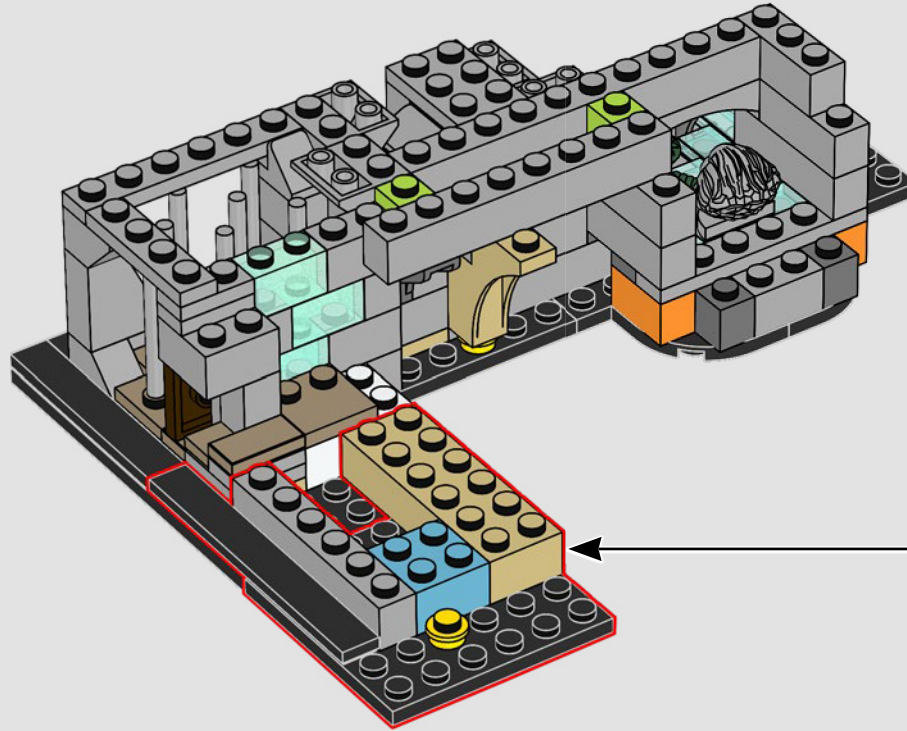



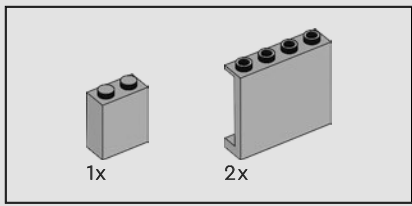

43

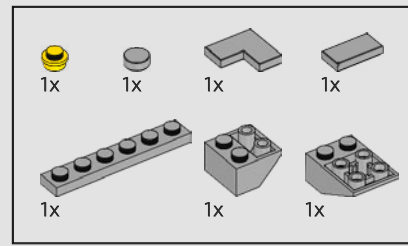
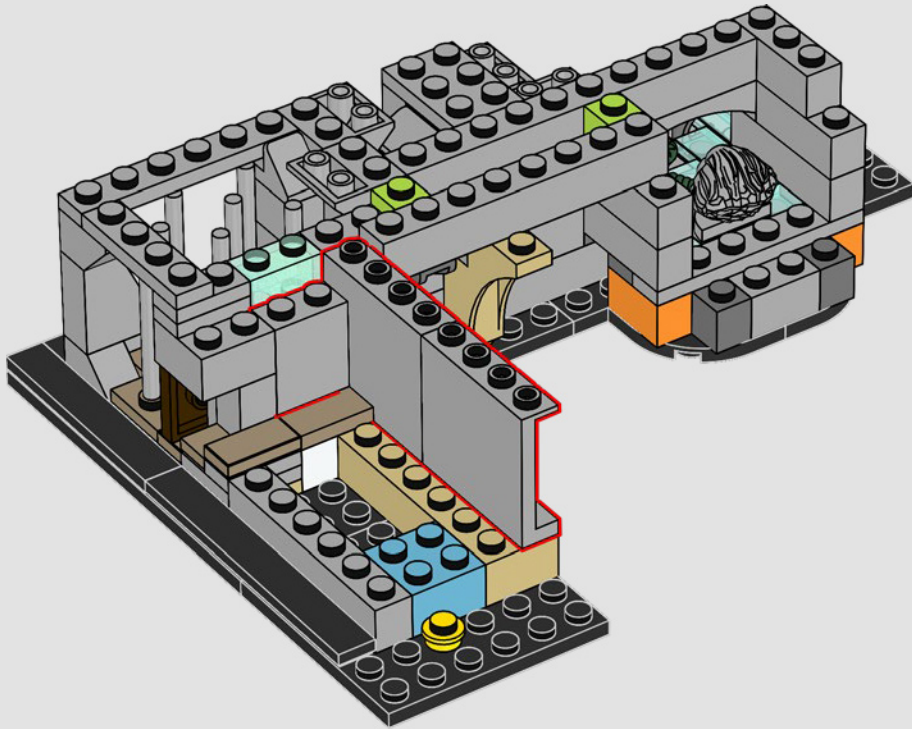

44

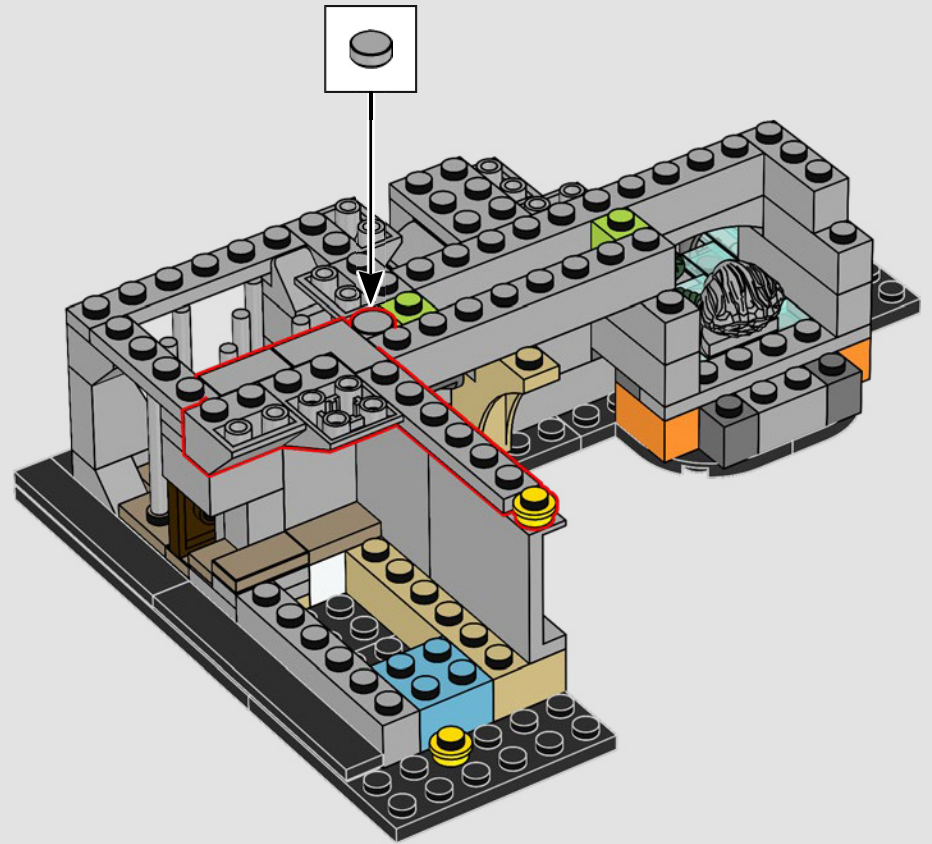

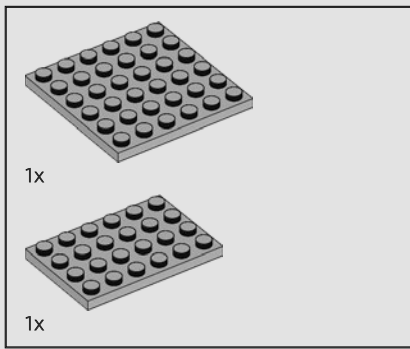

45

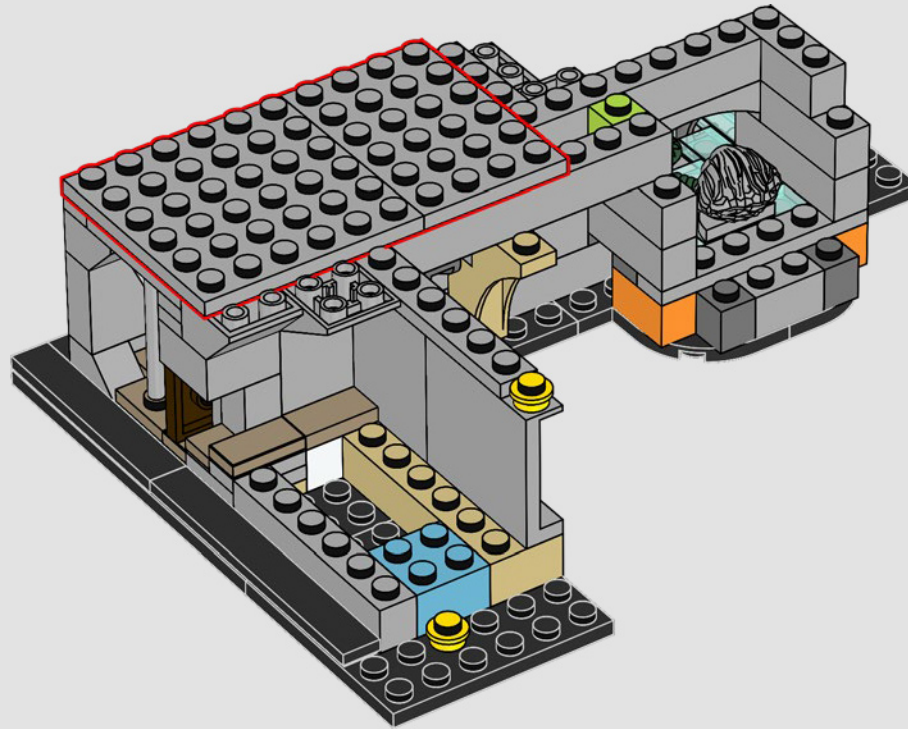

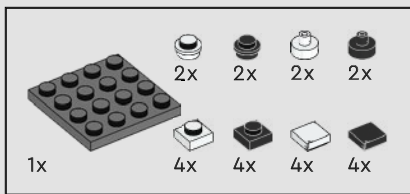

46

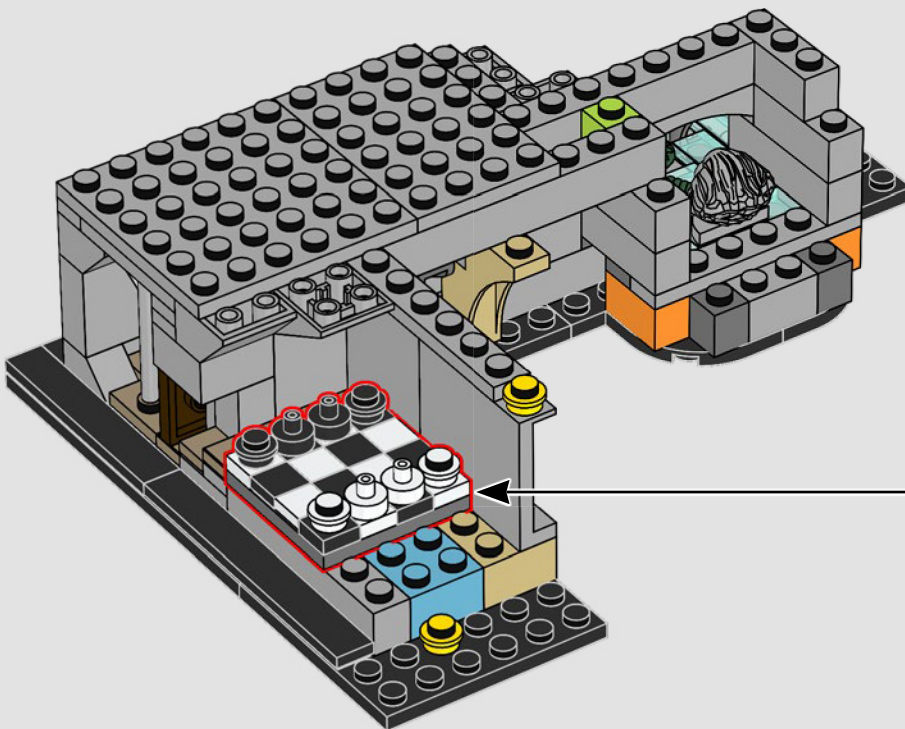
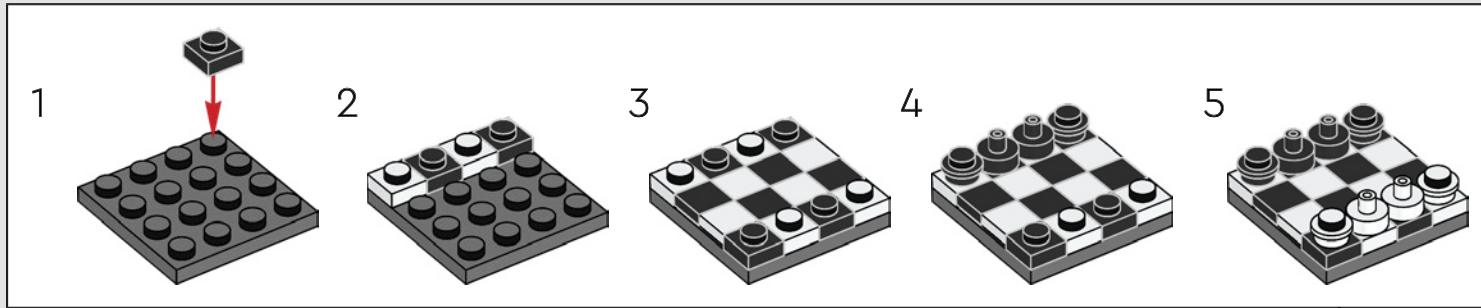



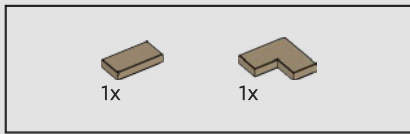

47

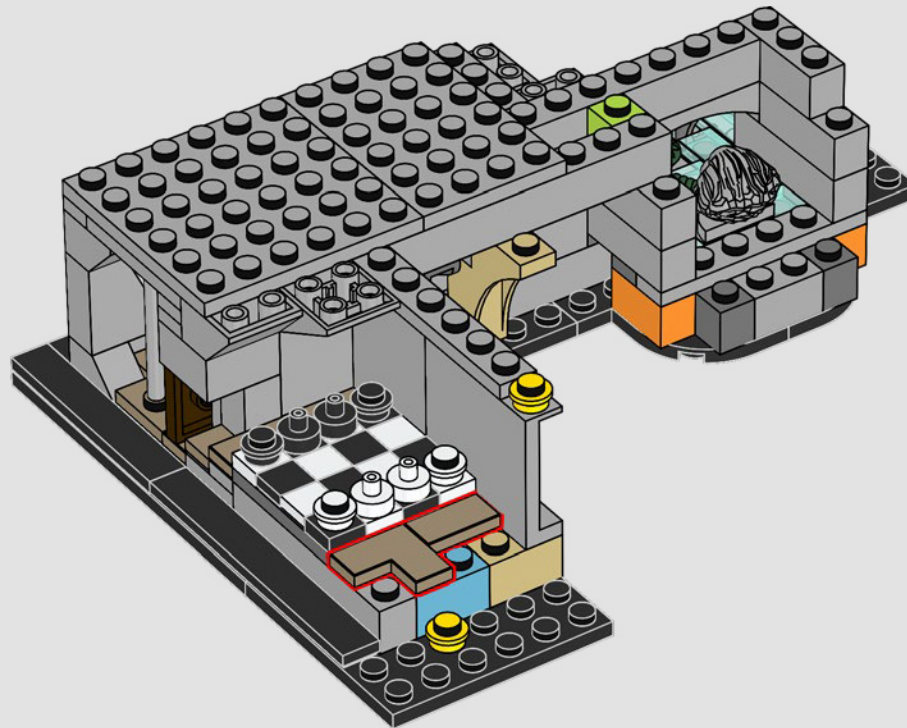

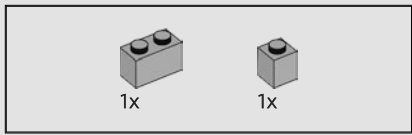

48

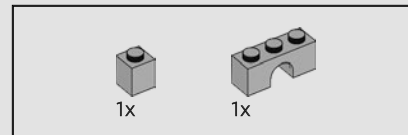
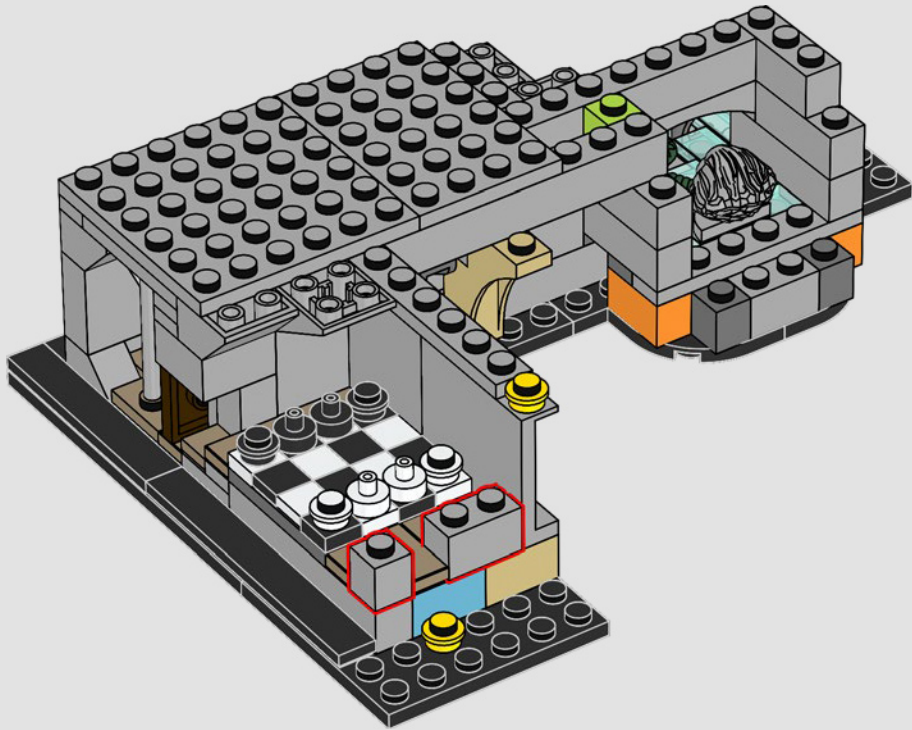

49

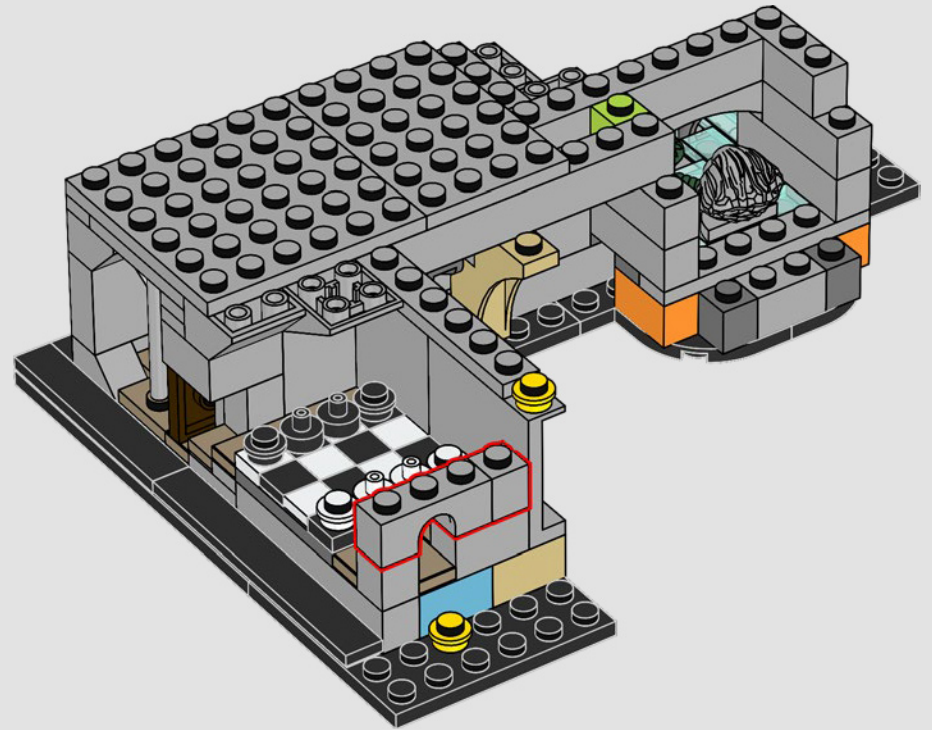

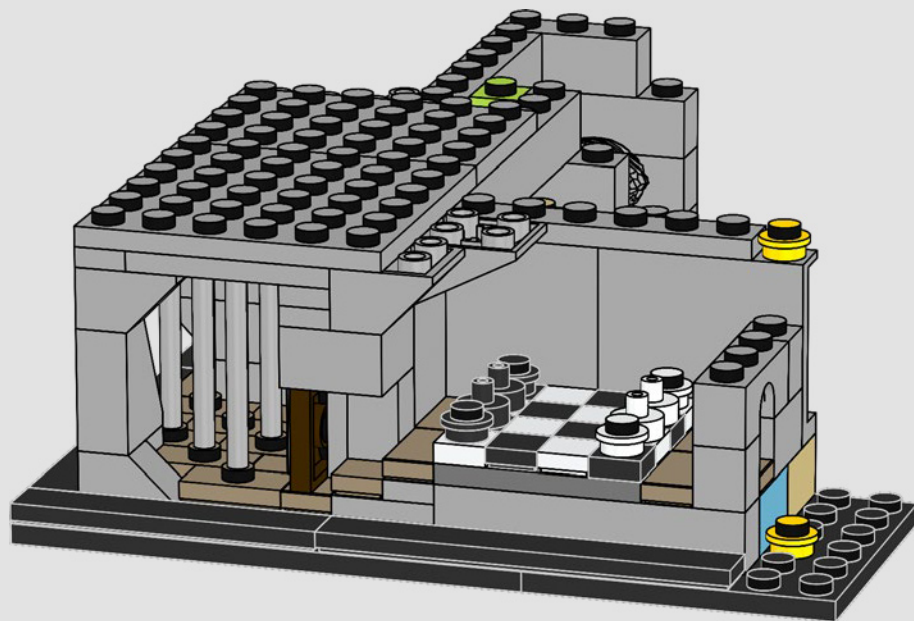

La Sala della  
Scacchiera era un  
altro ostacolo che  
protegeva la Pietra  
Filosofale e che  
richiedeva abilità  
strategiche, coraggio  
e sacrificio. Ron si  
meritò pienamente i  
50 punti conquistati  
per aver orchestrato  
la sua epica partita!



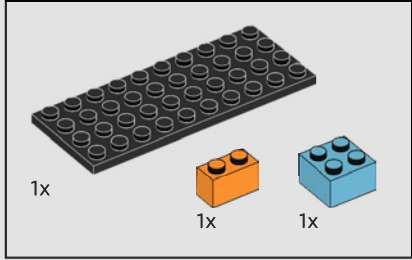
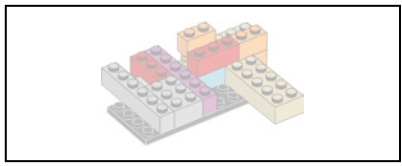

50

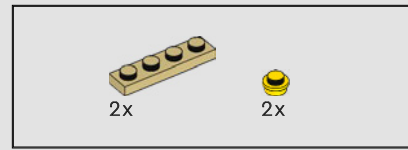
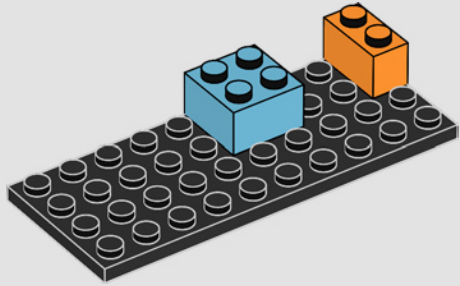

51

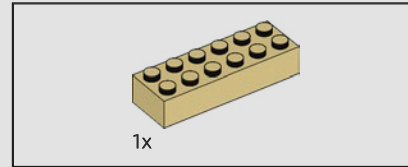
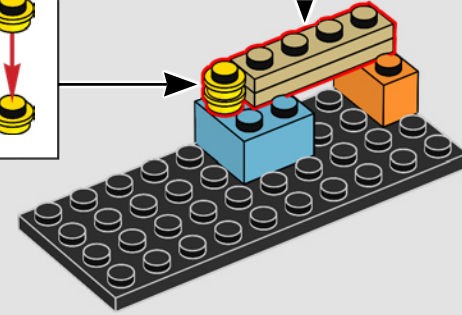
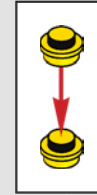
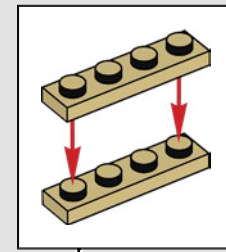

52

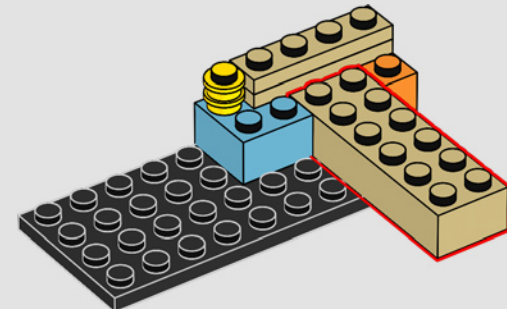

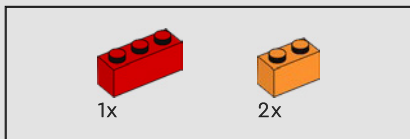

53

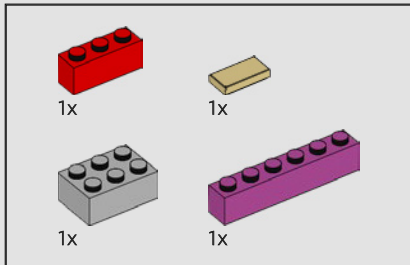
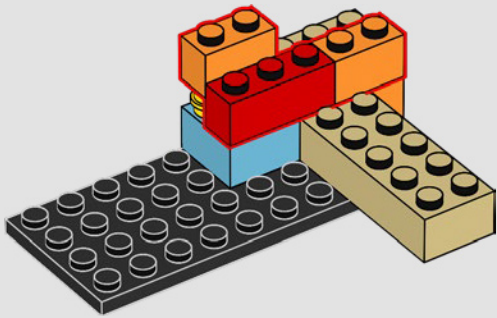

54

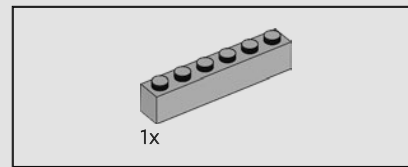
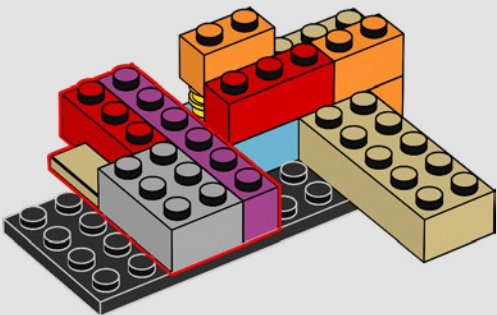

55

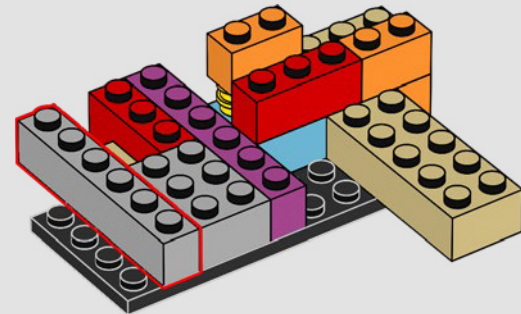

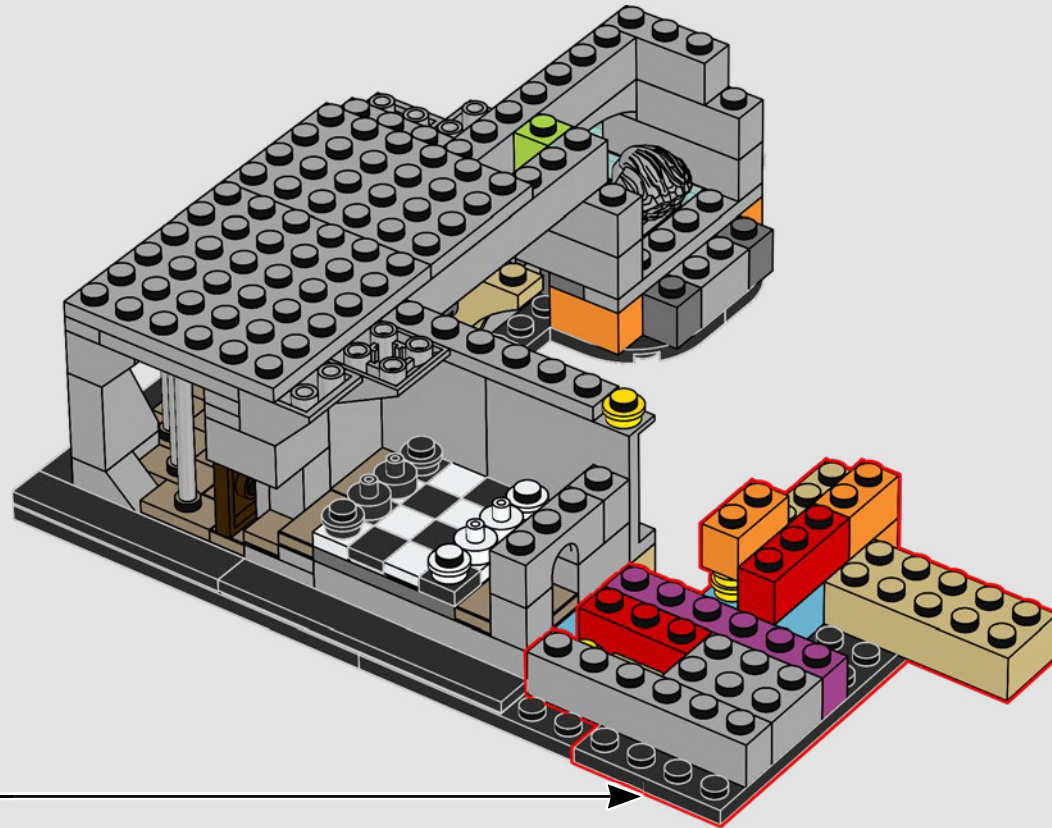



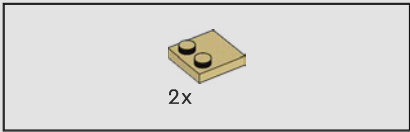

57

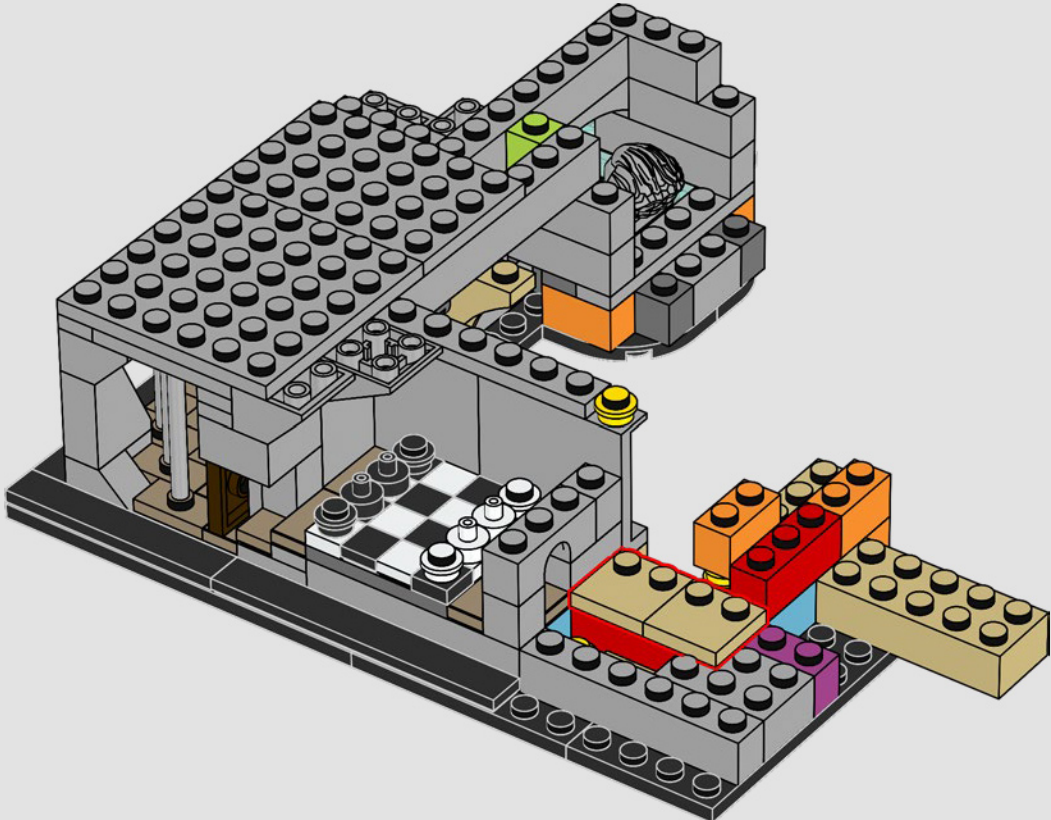

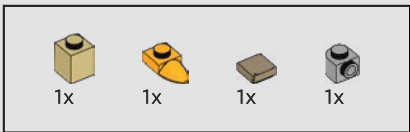

58

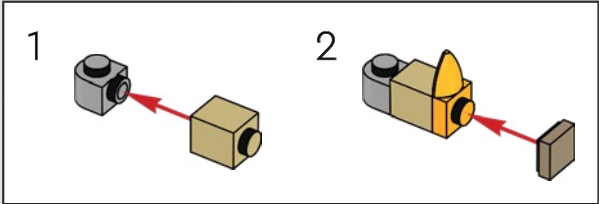
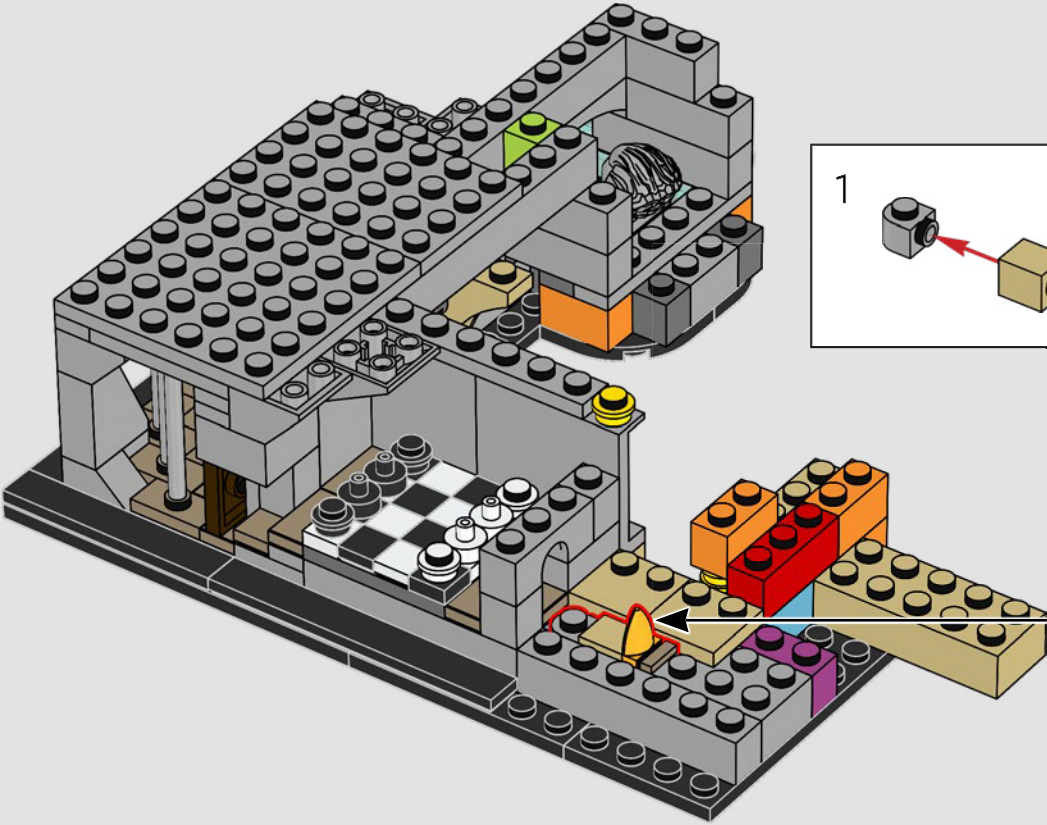

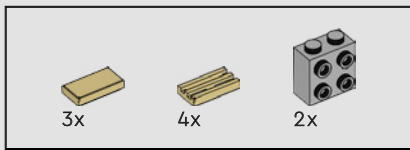

59

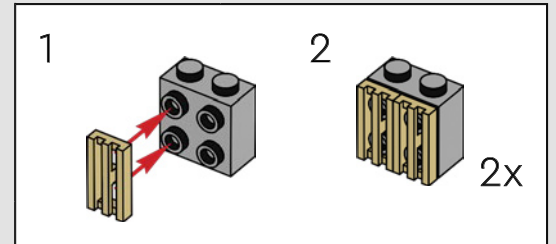
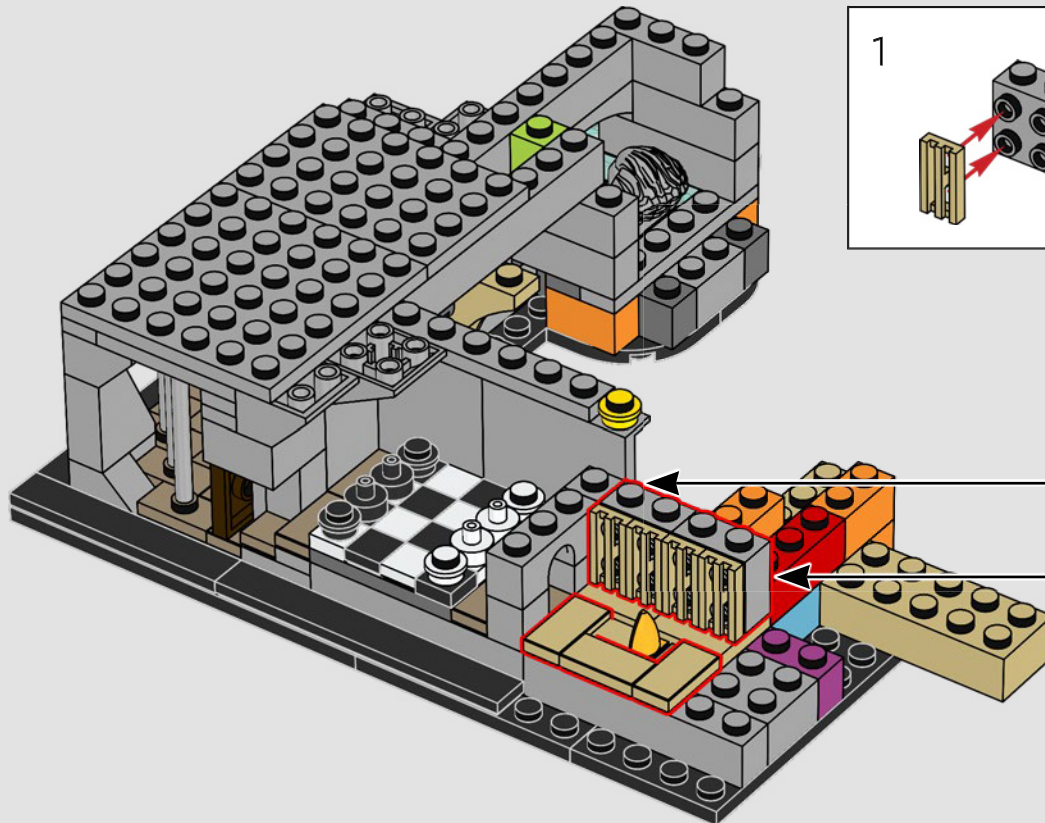



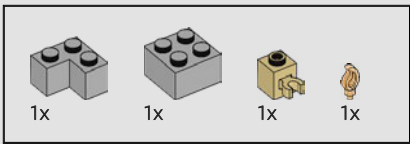

60

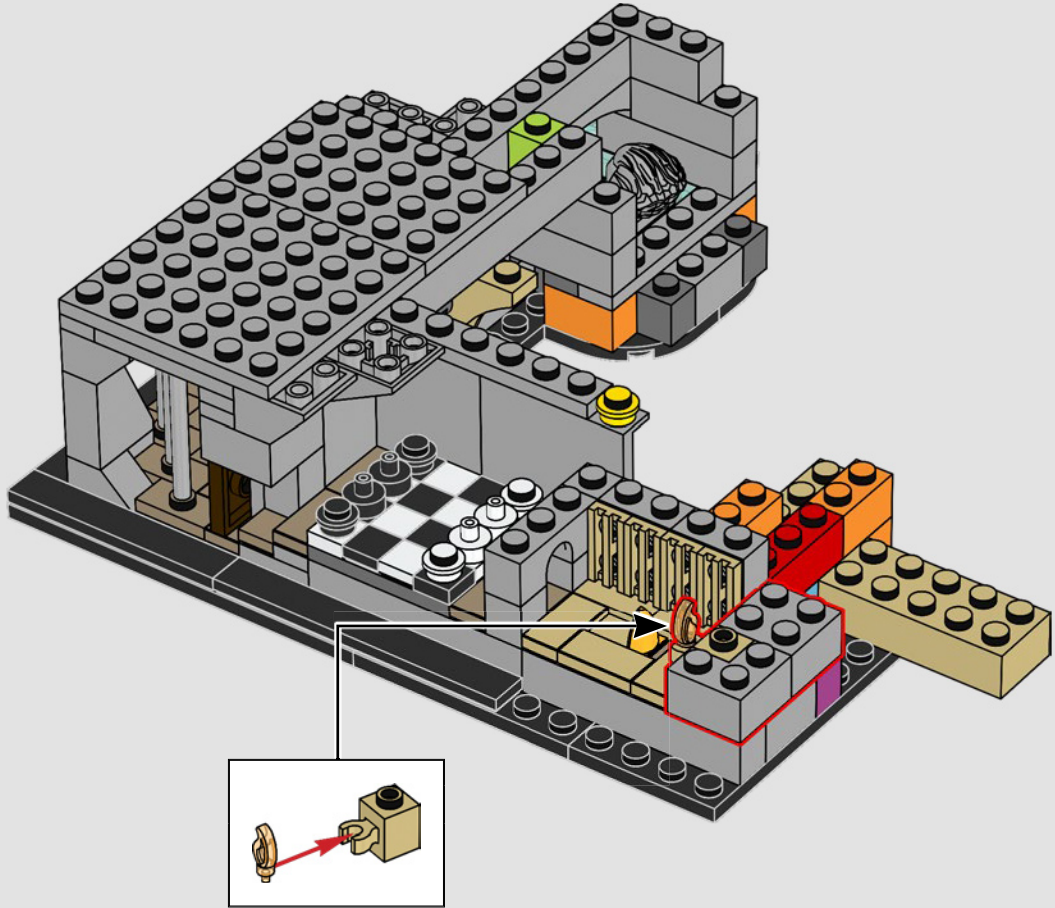

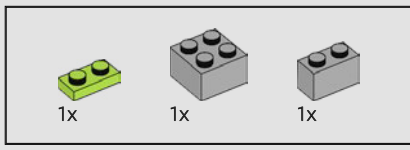

61

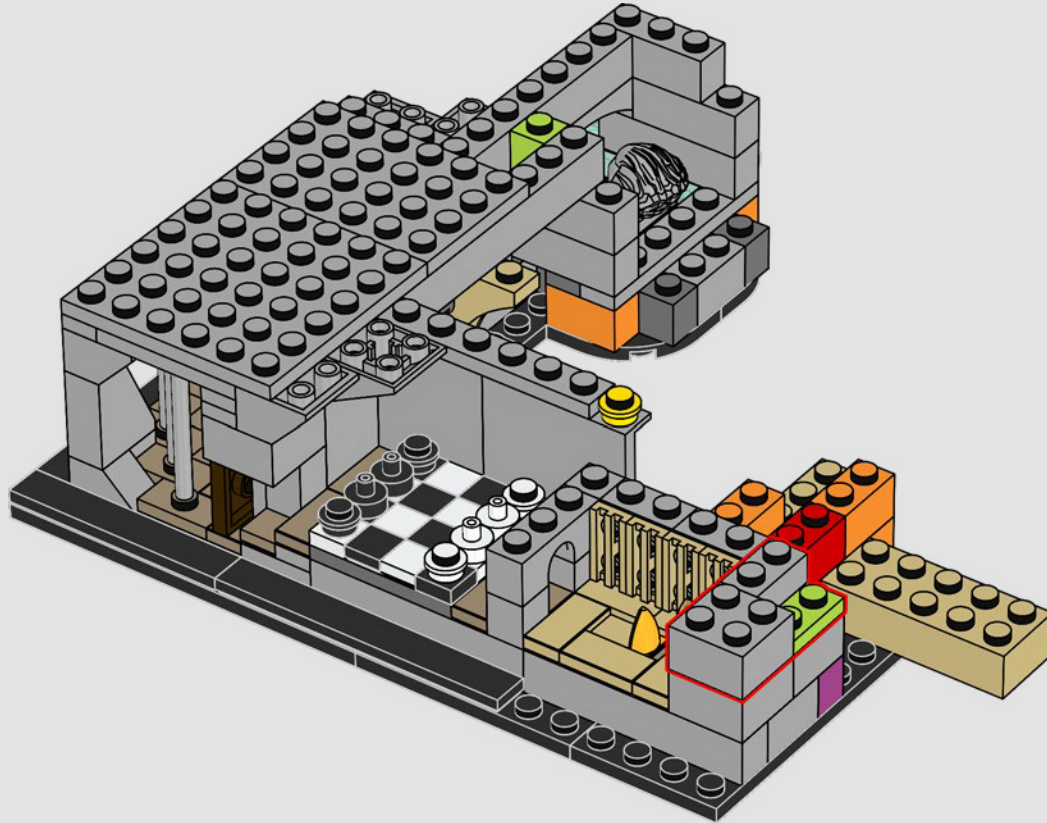

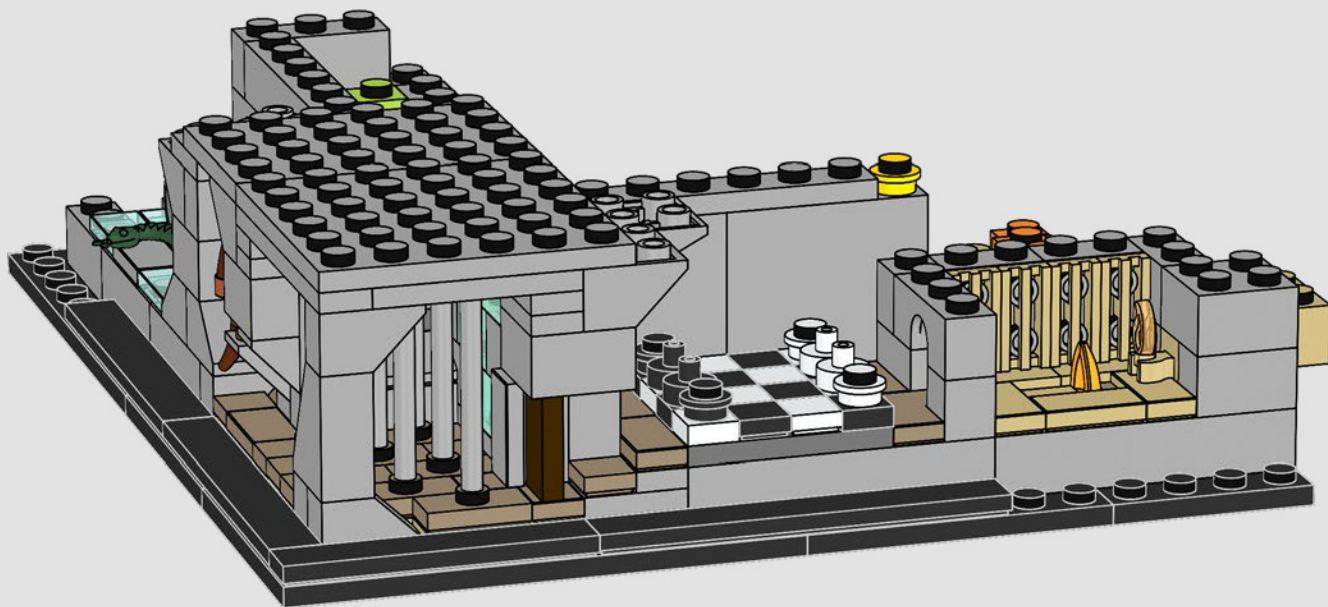

Per comprendere lo scopo dello Specchio delle Emarb, è necessario leggere la sua iscrizione al contrario: "Emarb eutel amosi vout linon ortsom". (Non dimenticare di eliminare e di aggiungere degli spazi!)





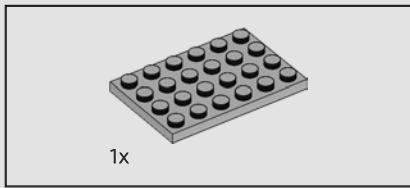

62

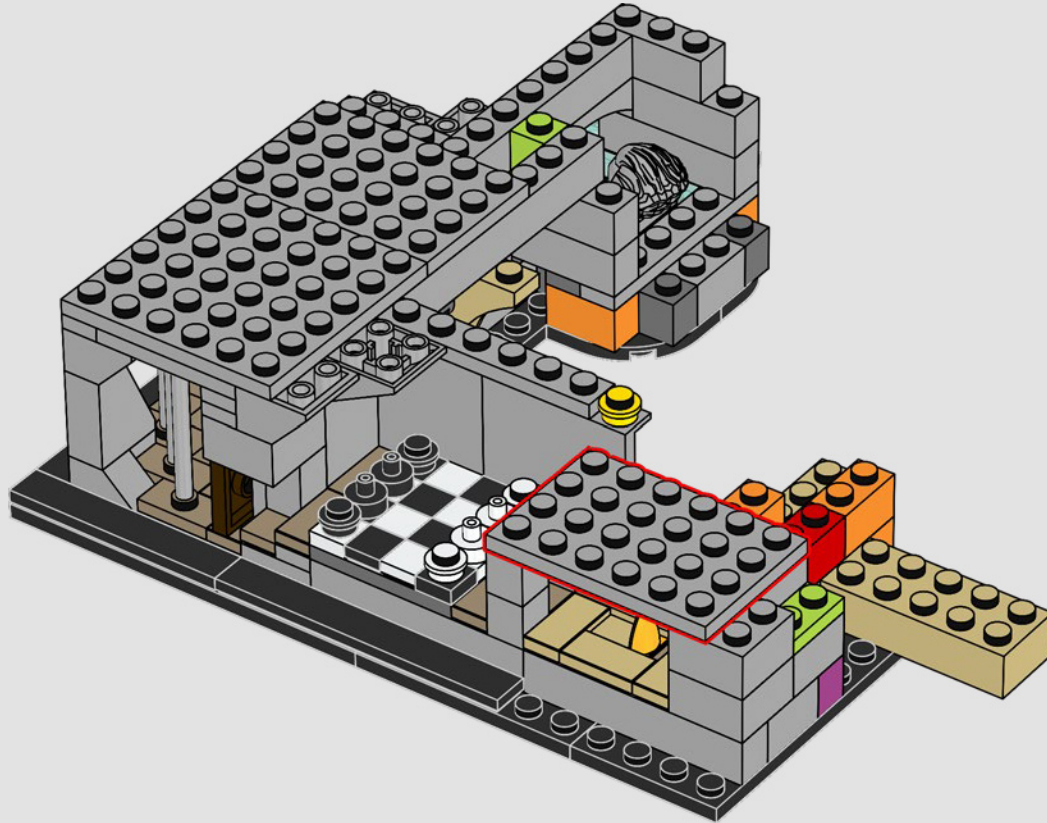



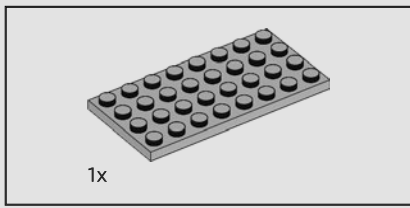

64

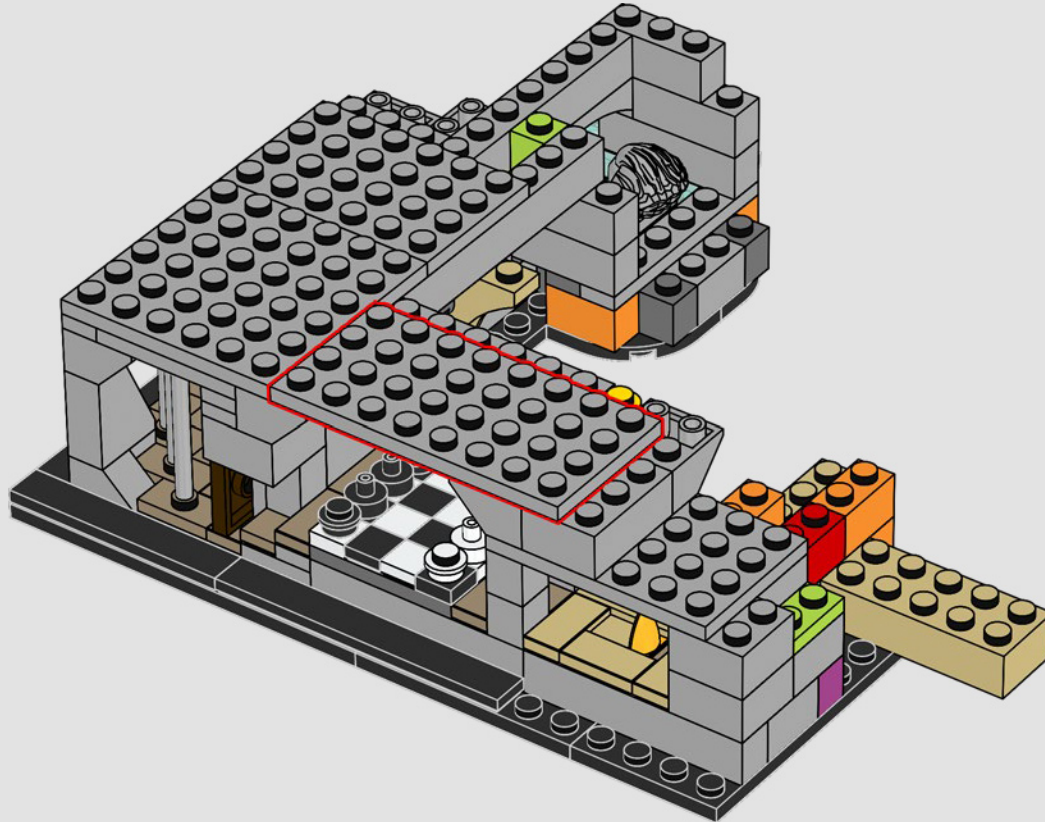

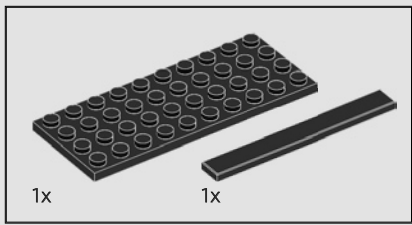

65

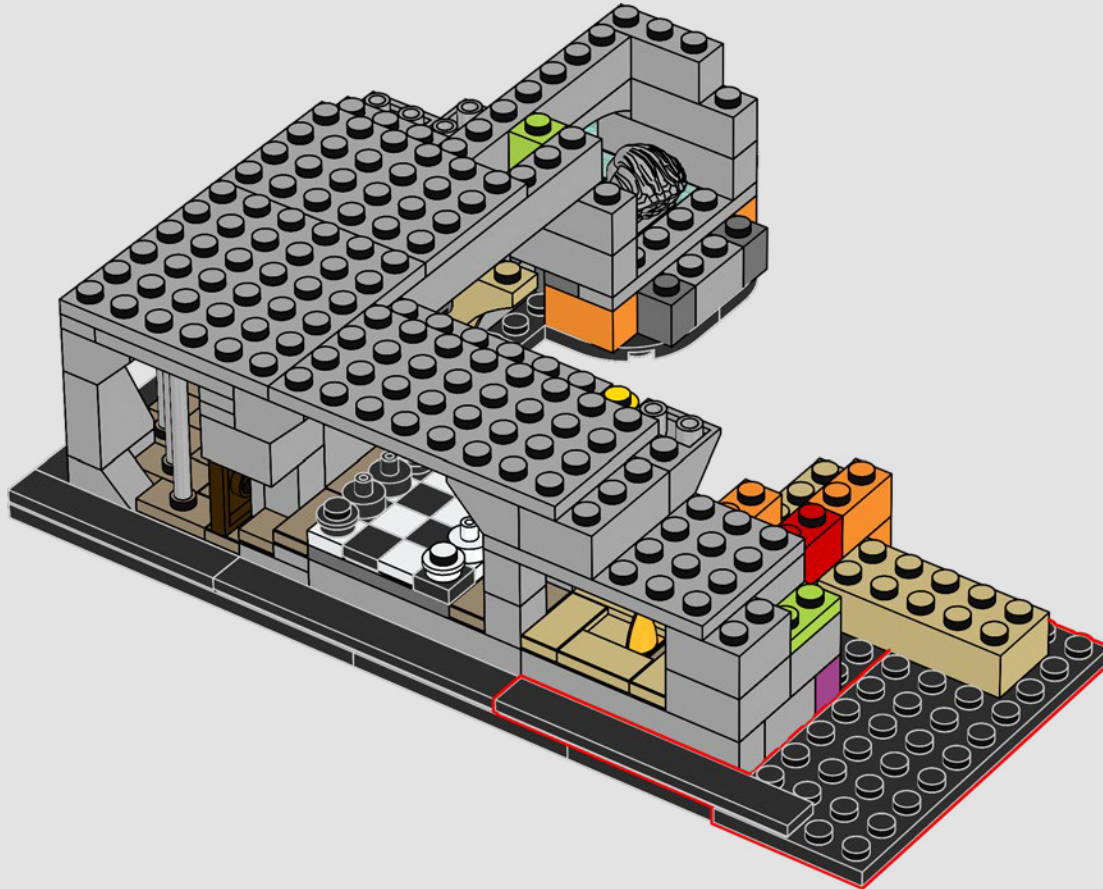



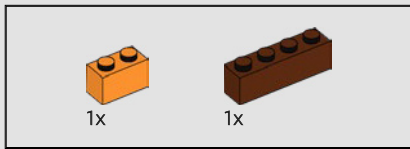

66

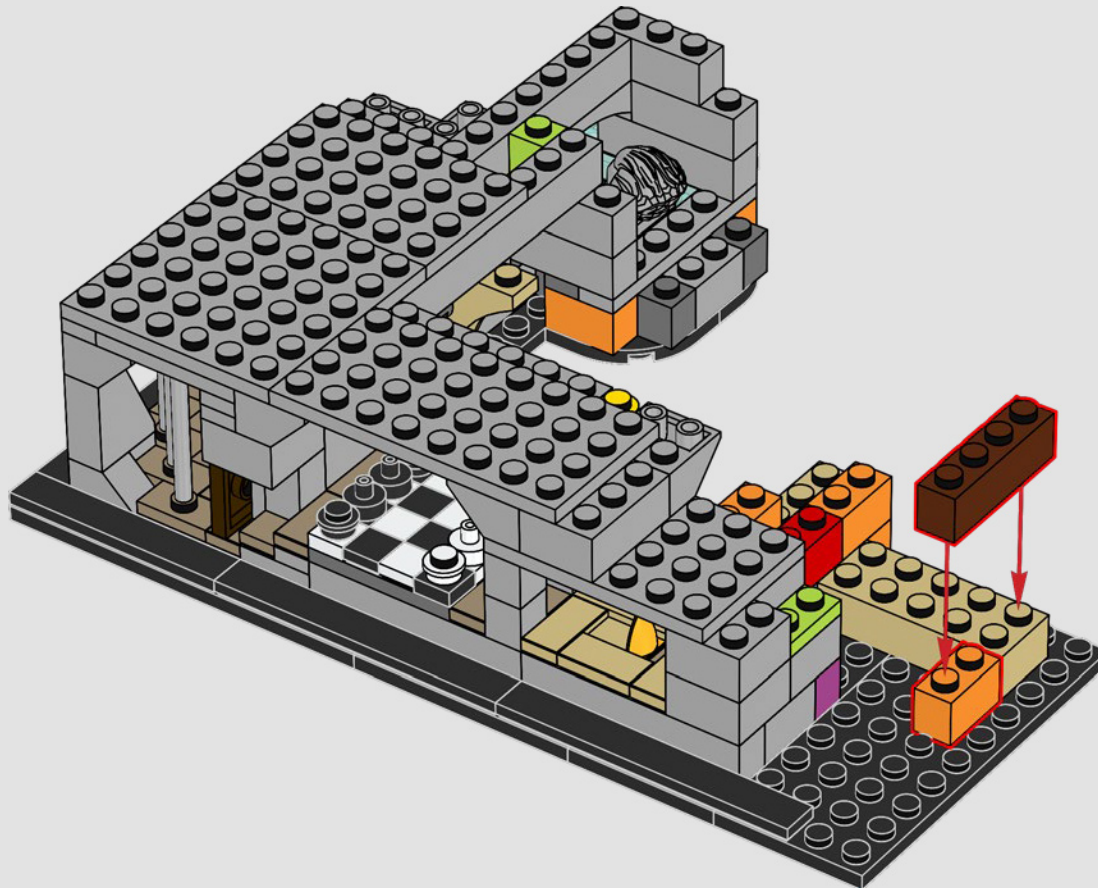

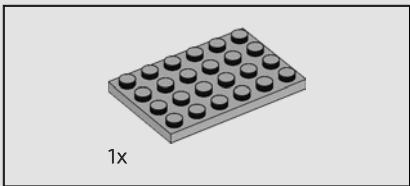

67

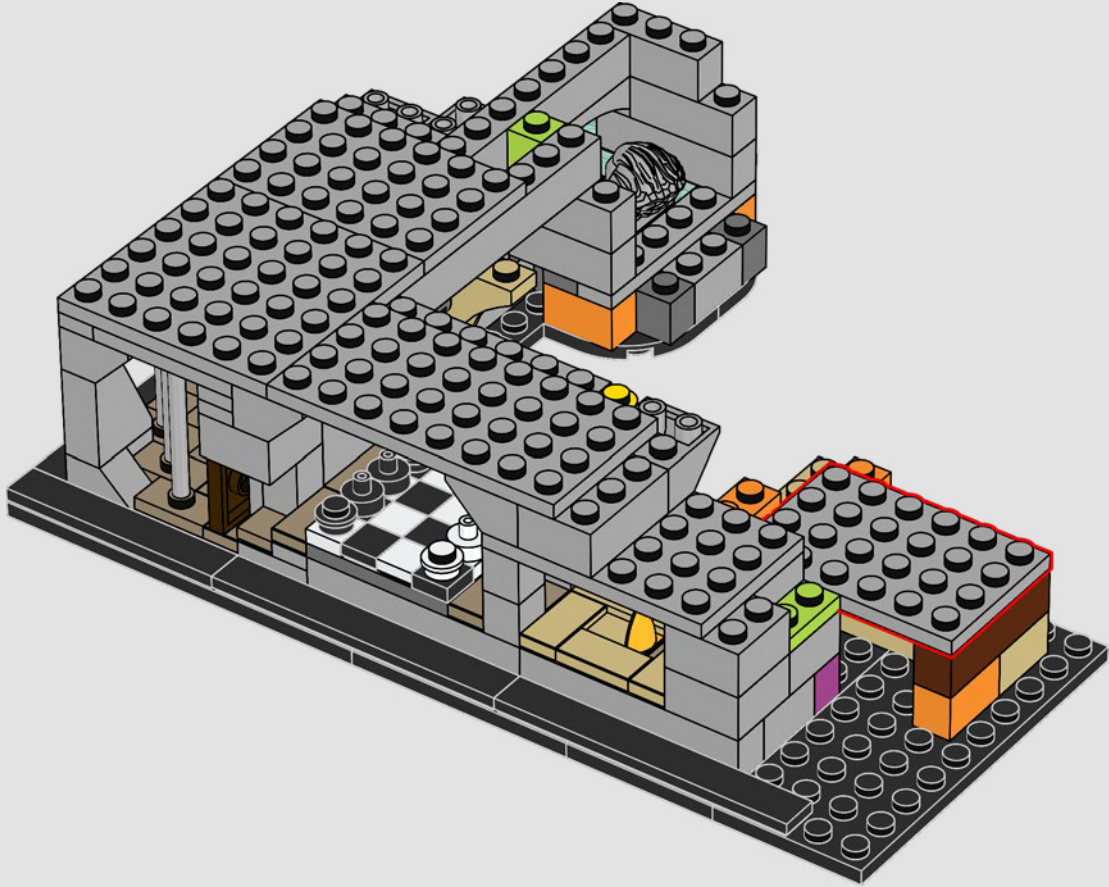



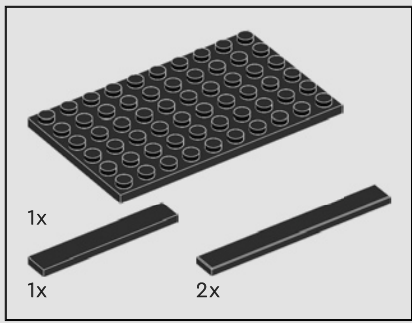

68

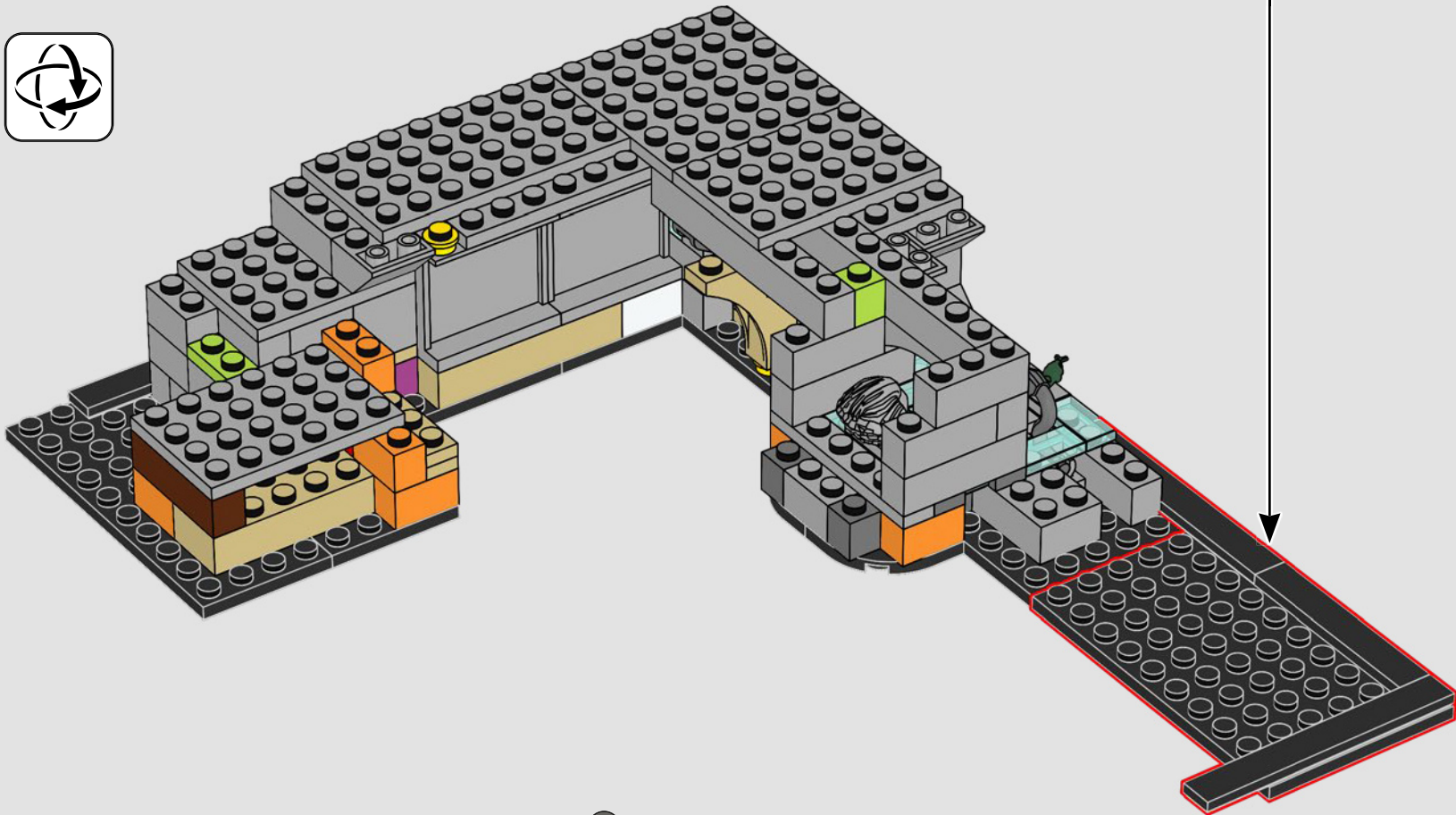
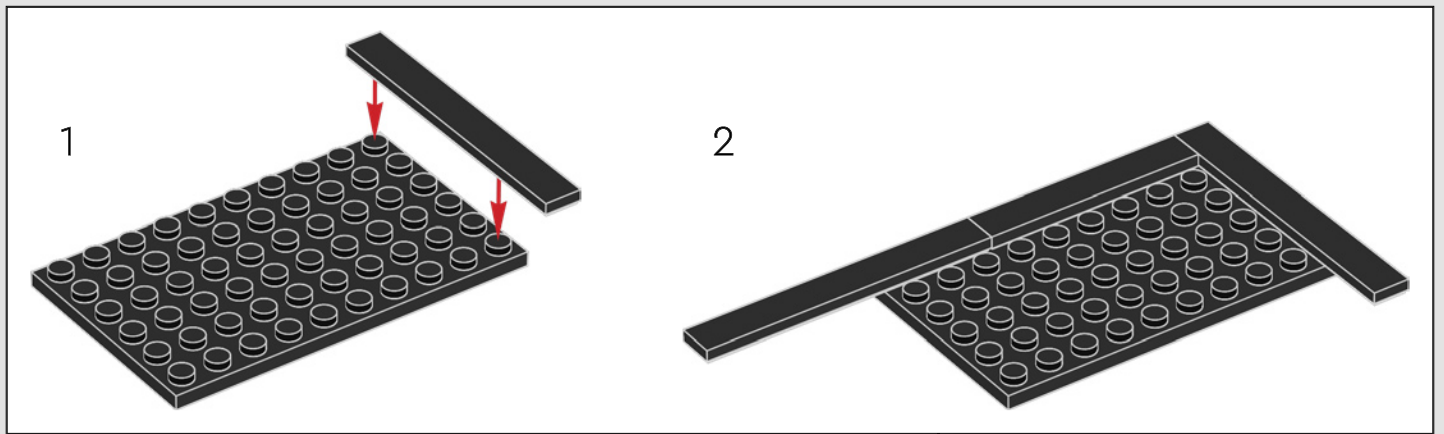



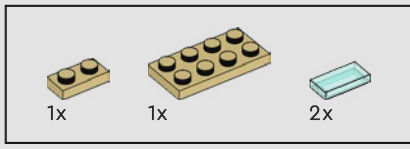

69

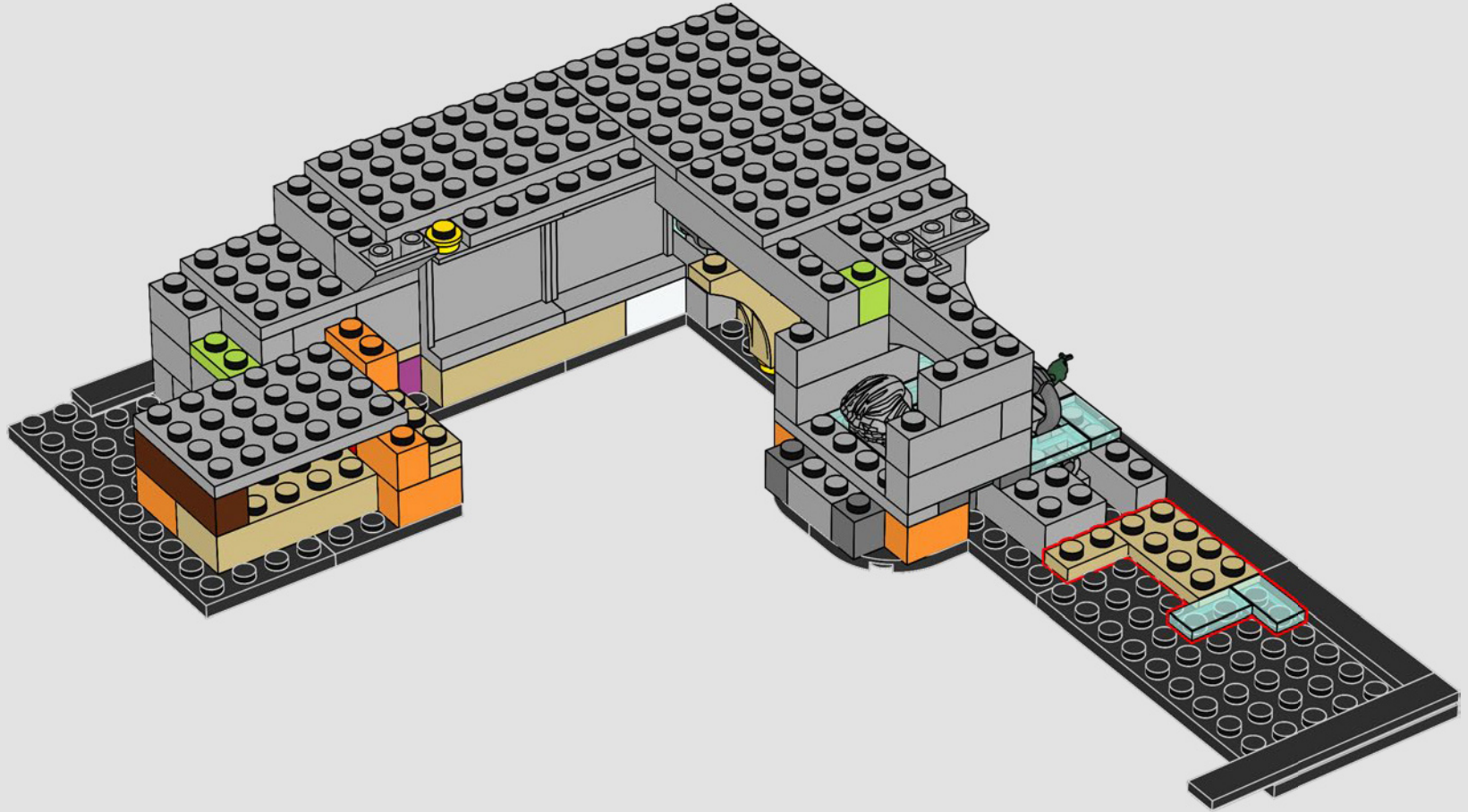

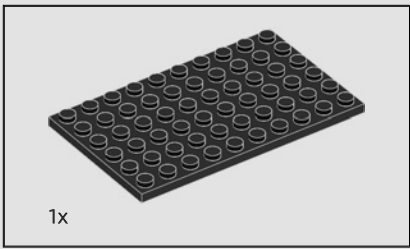

70

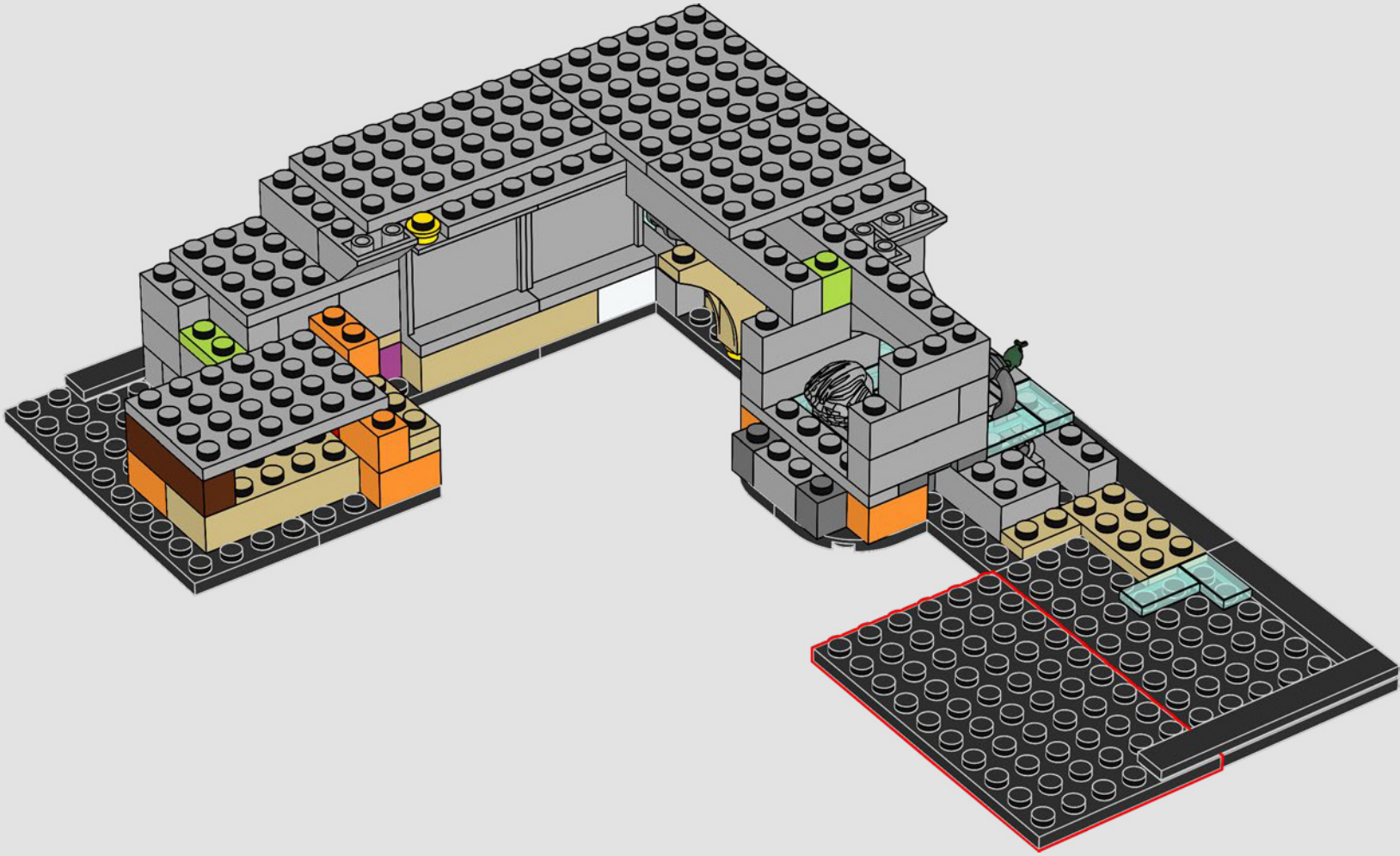

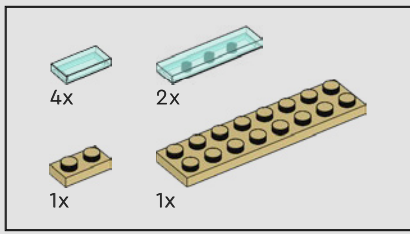

71

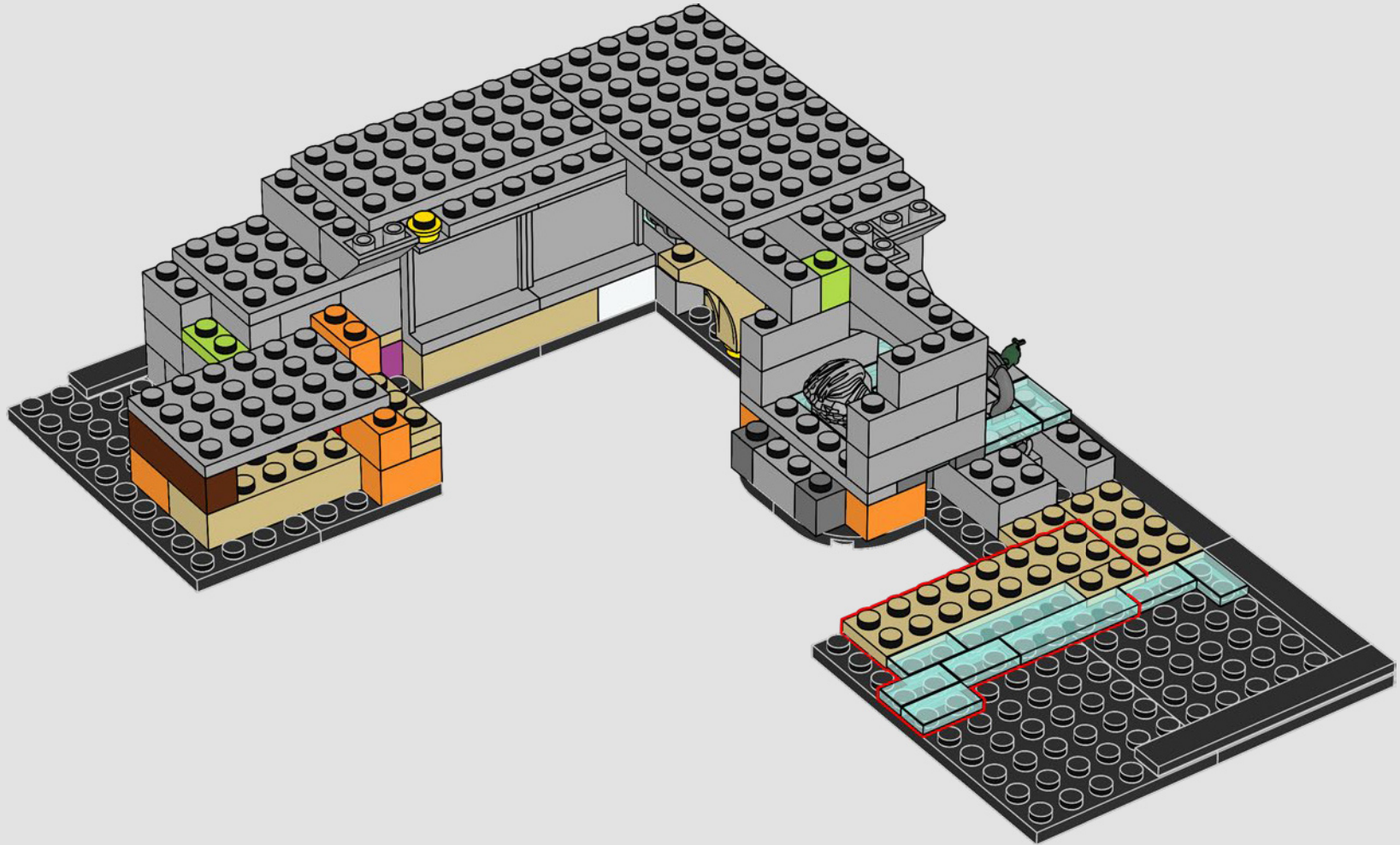



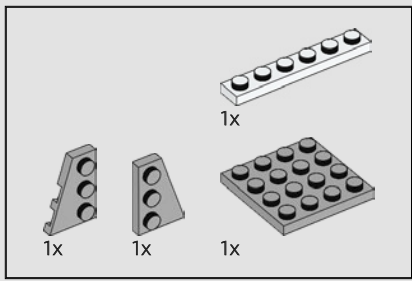

72

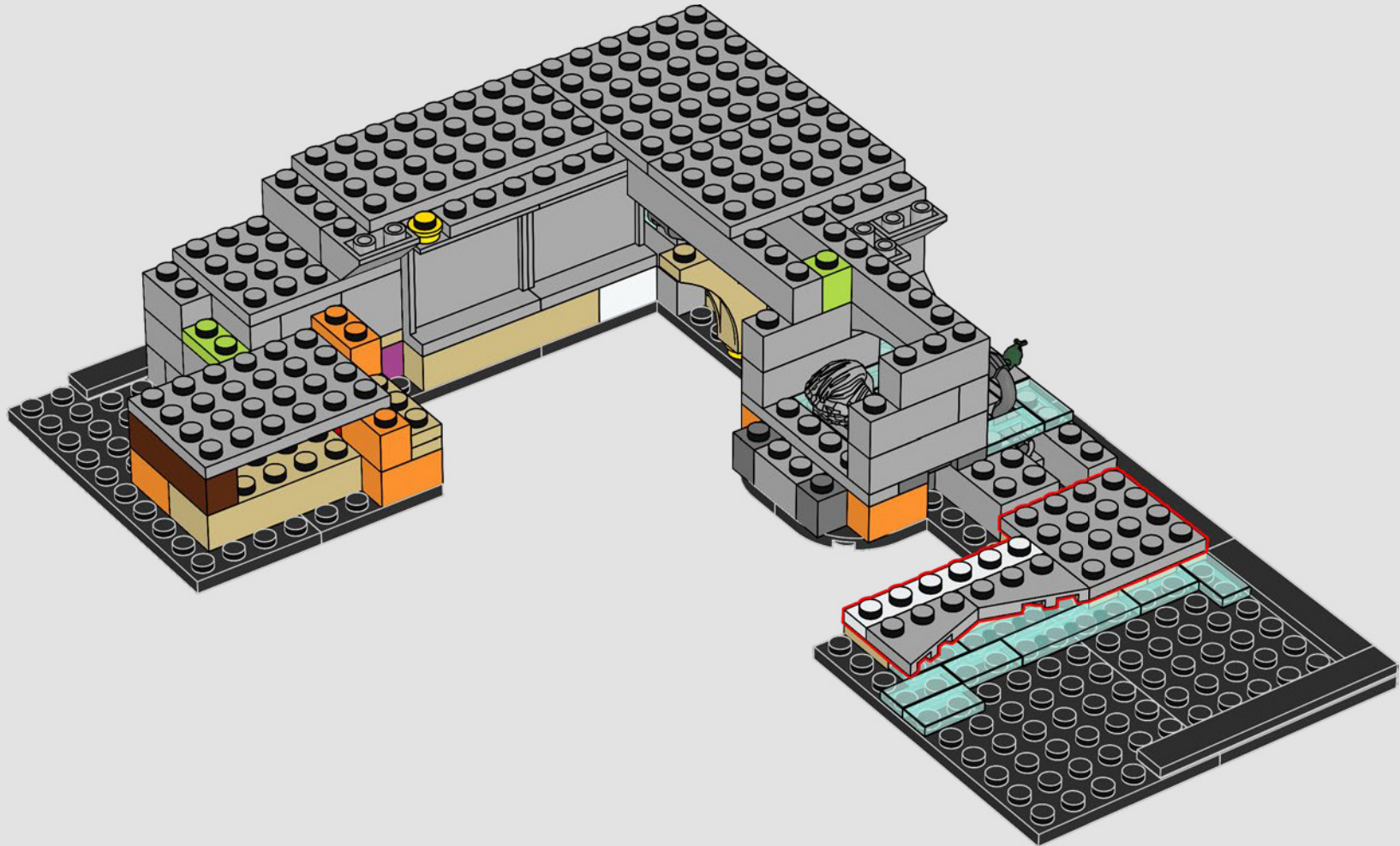



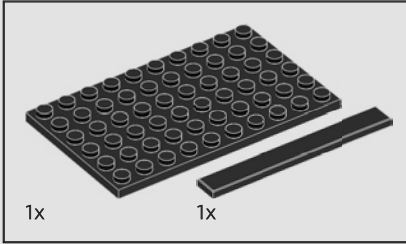
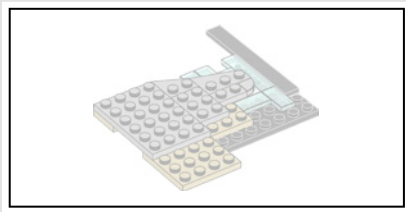

73

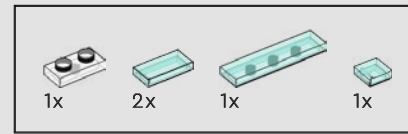
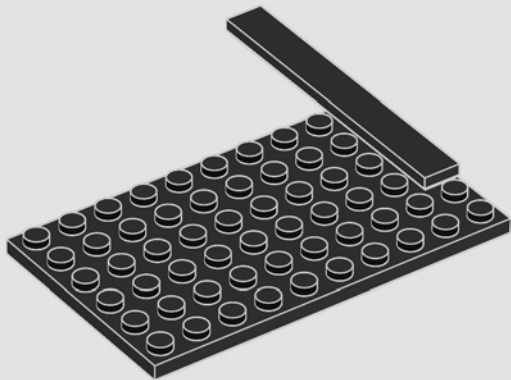

74

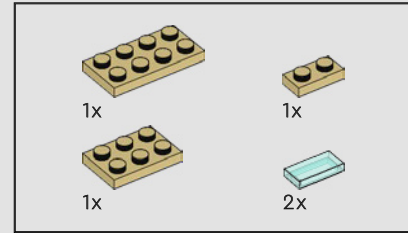
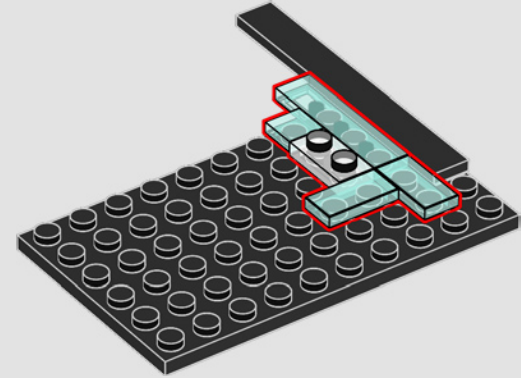

75

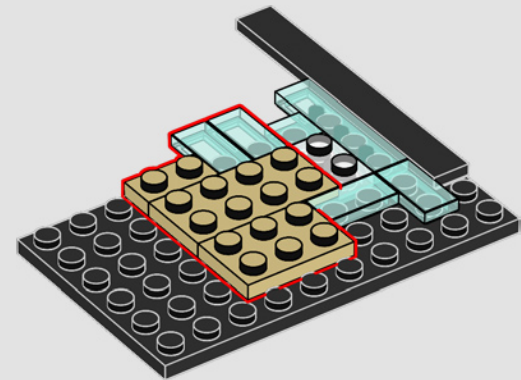

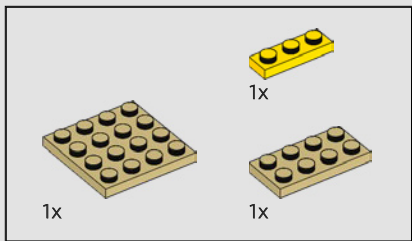

76

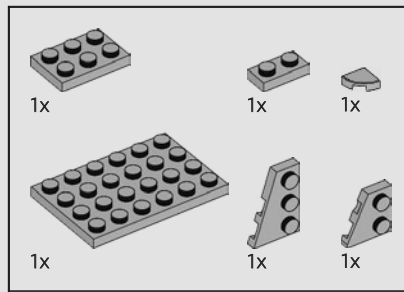
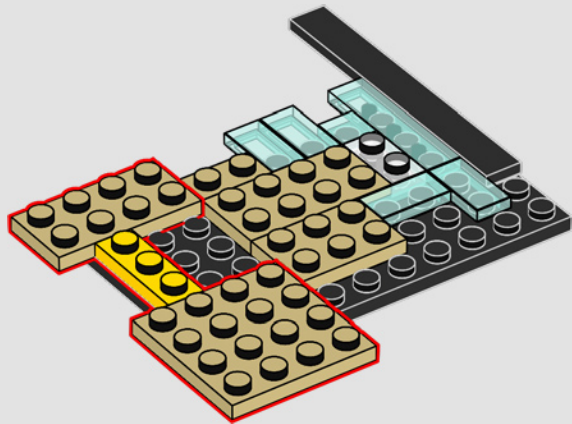

77

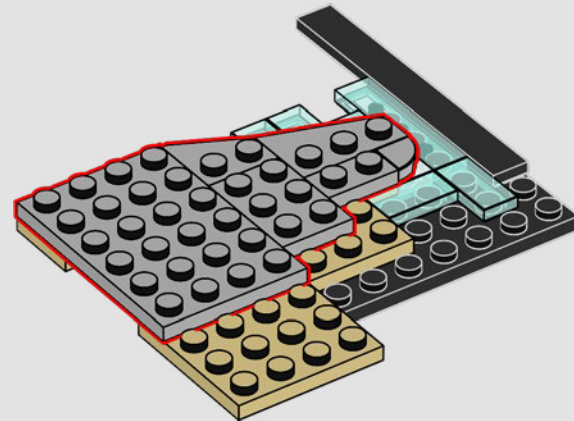

78

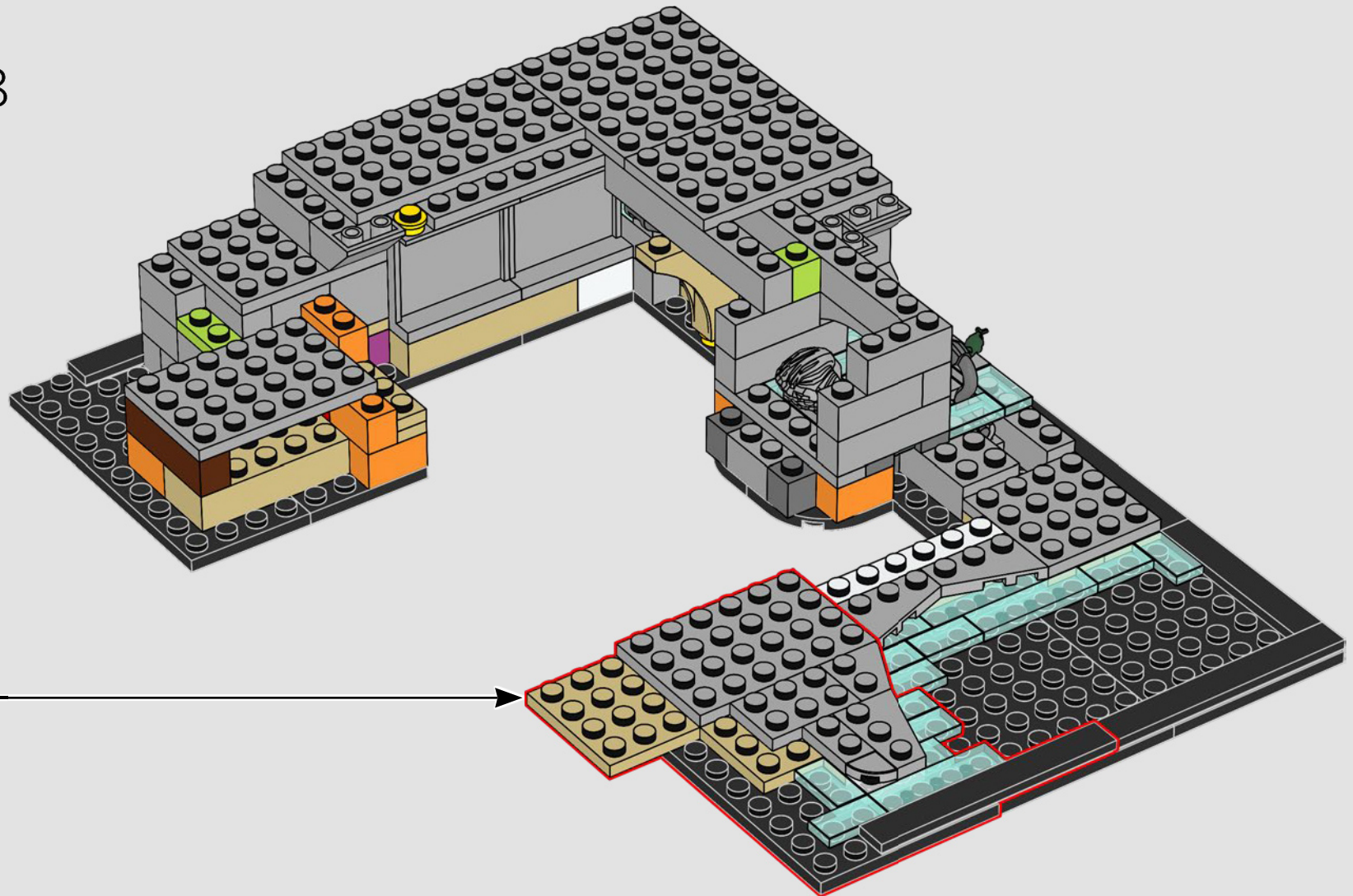

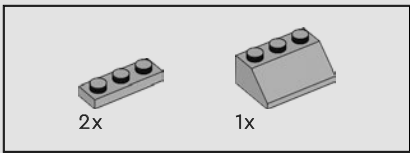

79

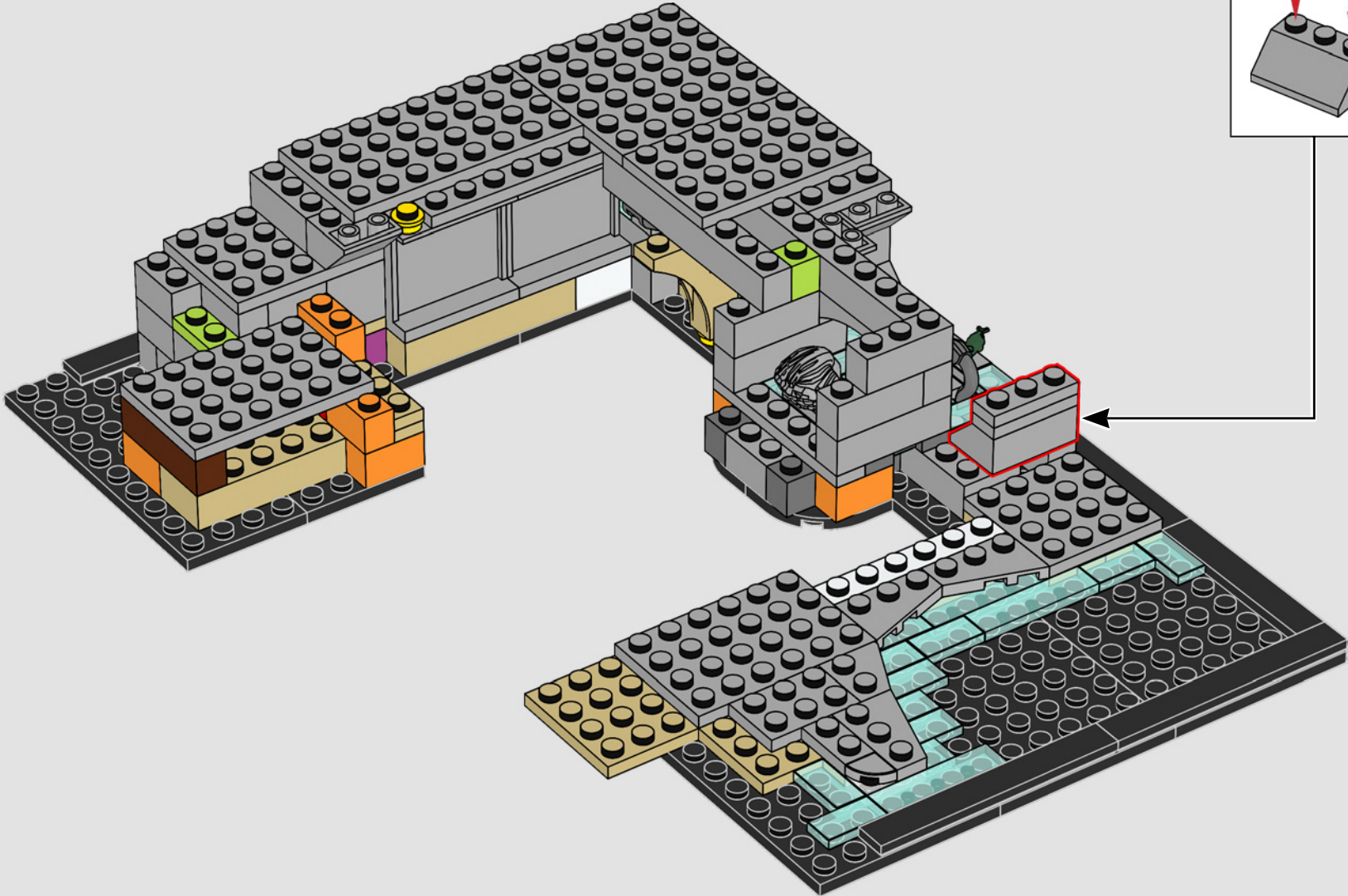
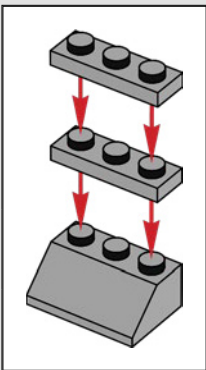





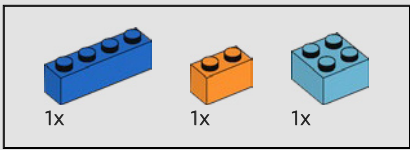

81

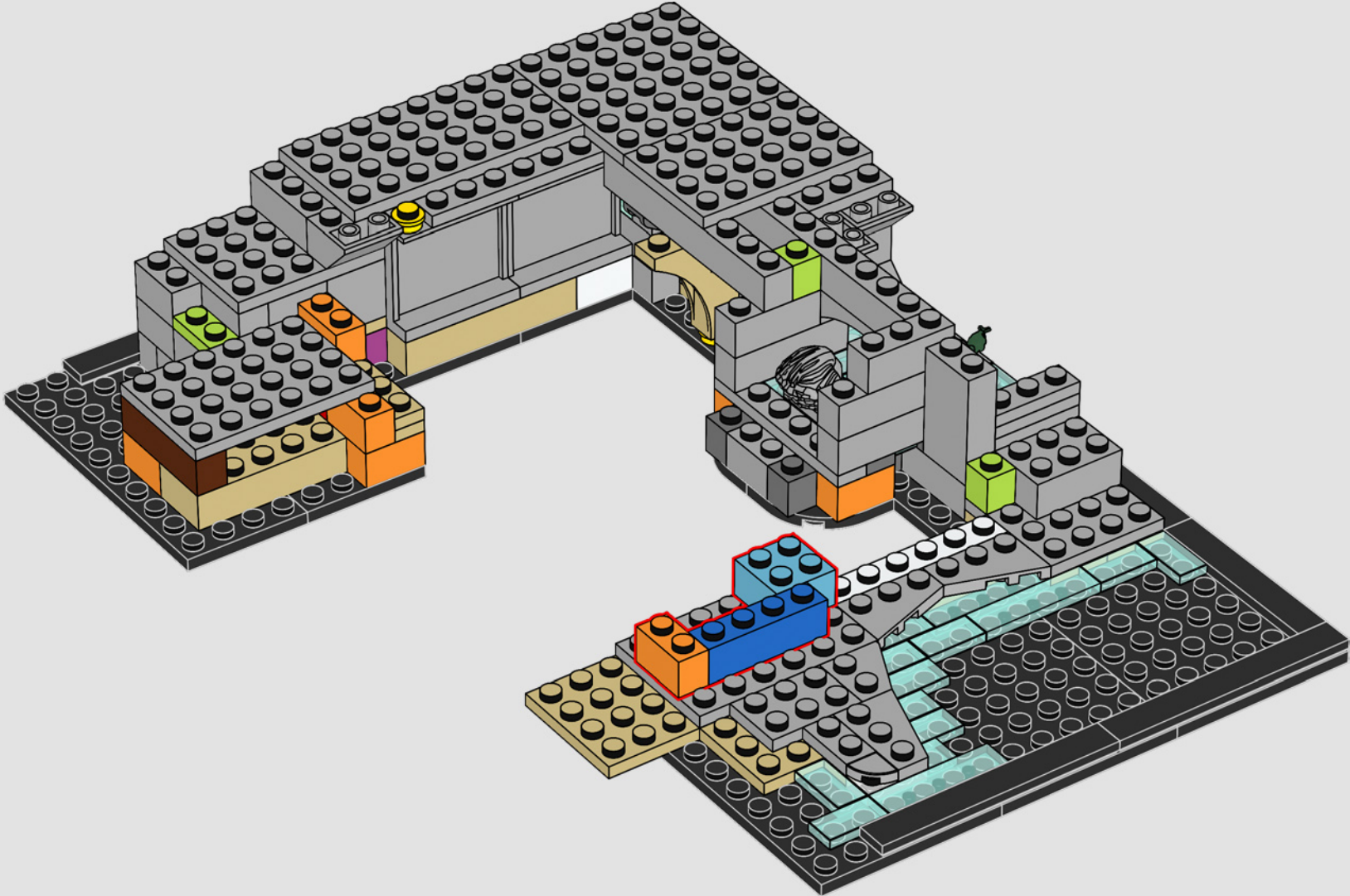

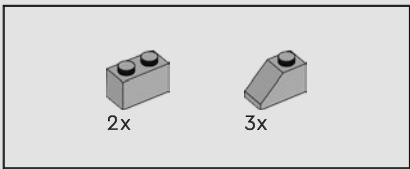

82

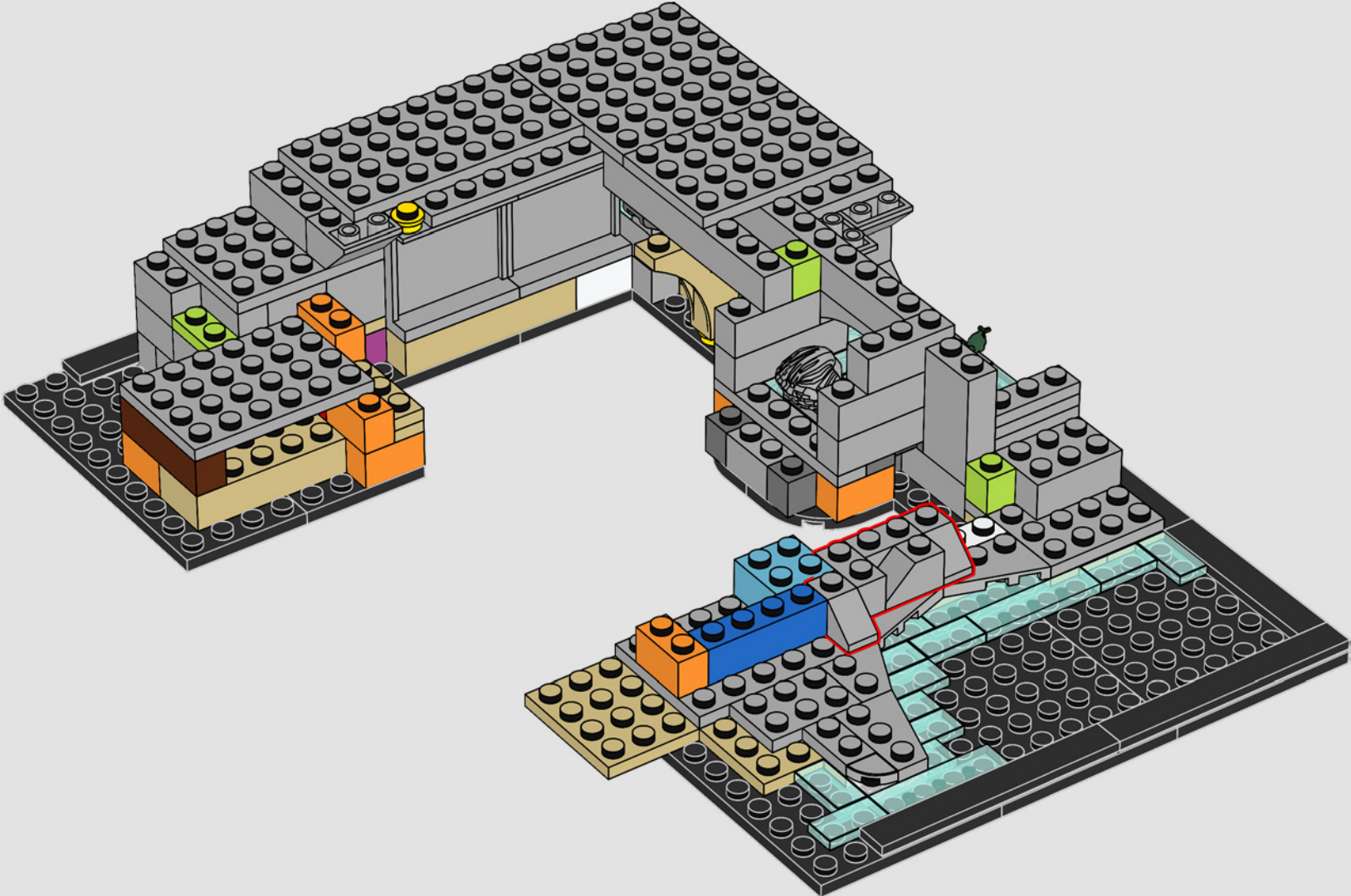



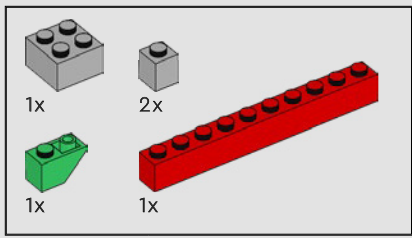

83

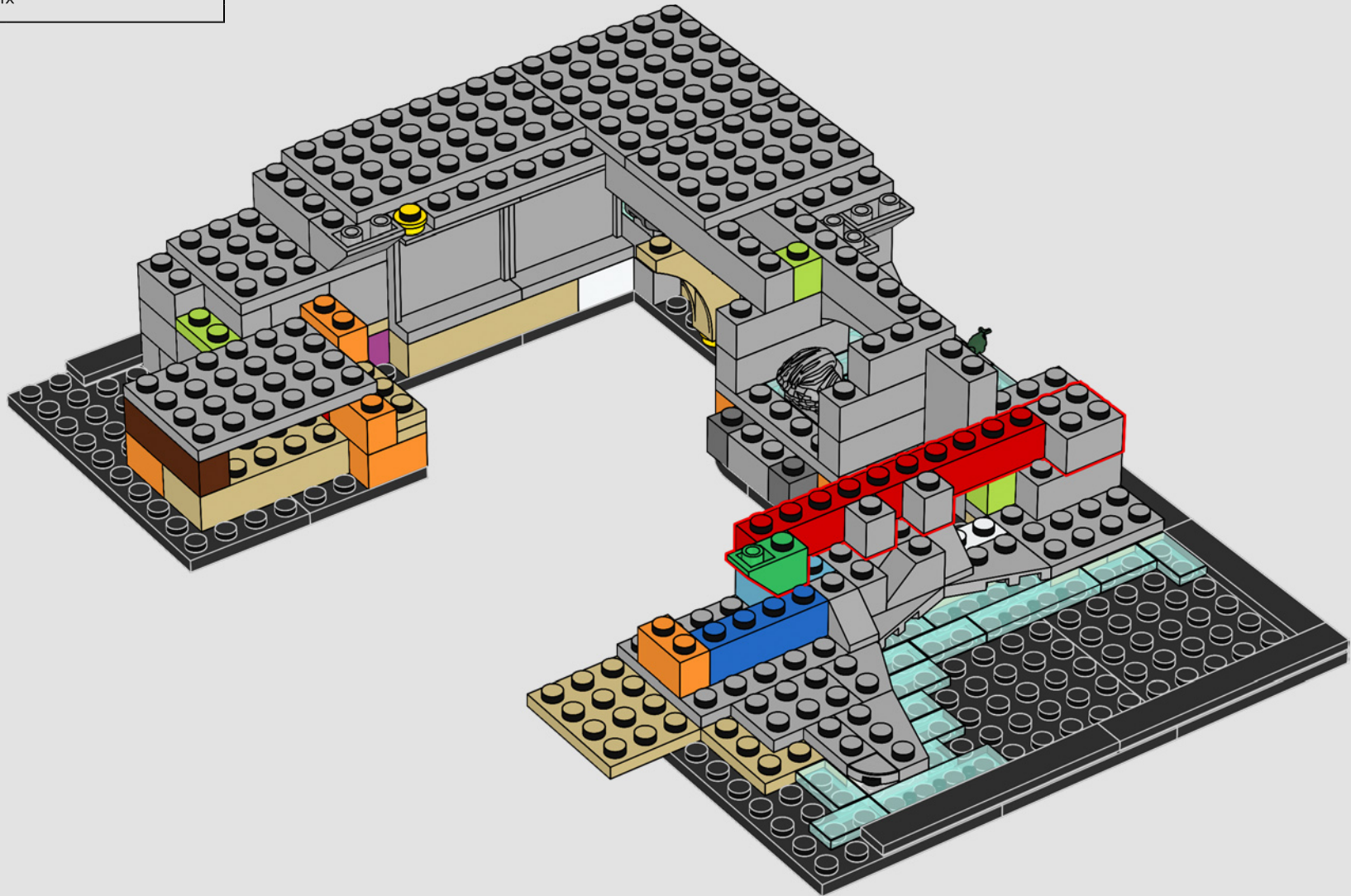



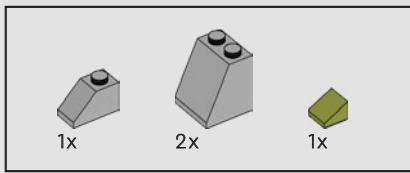

84

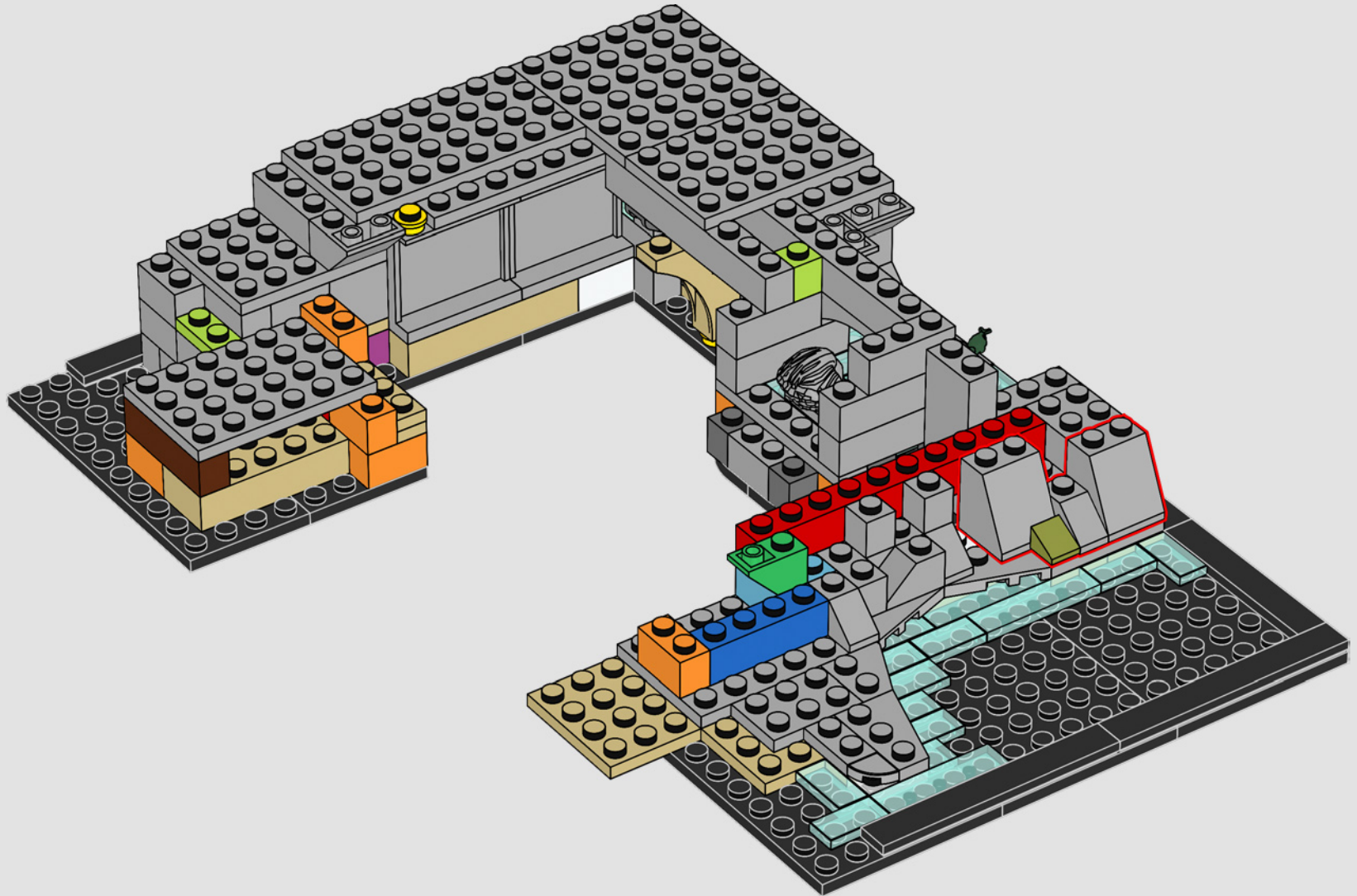

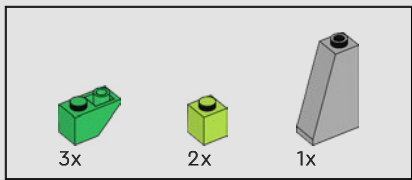

85

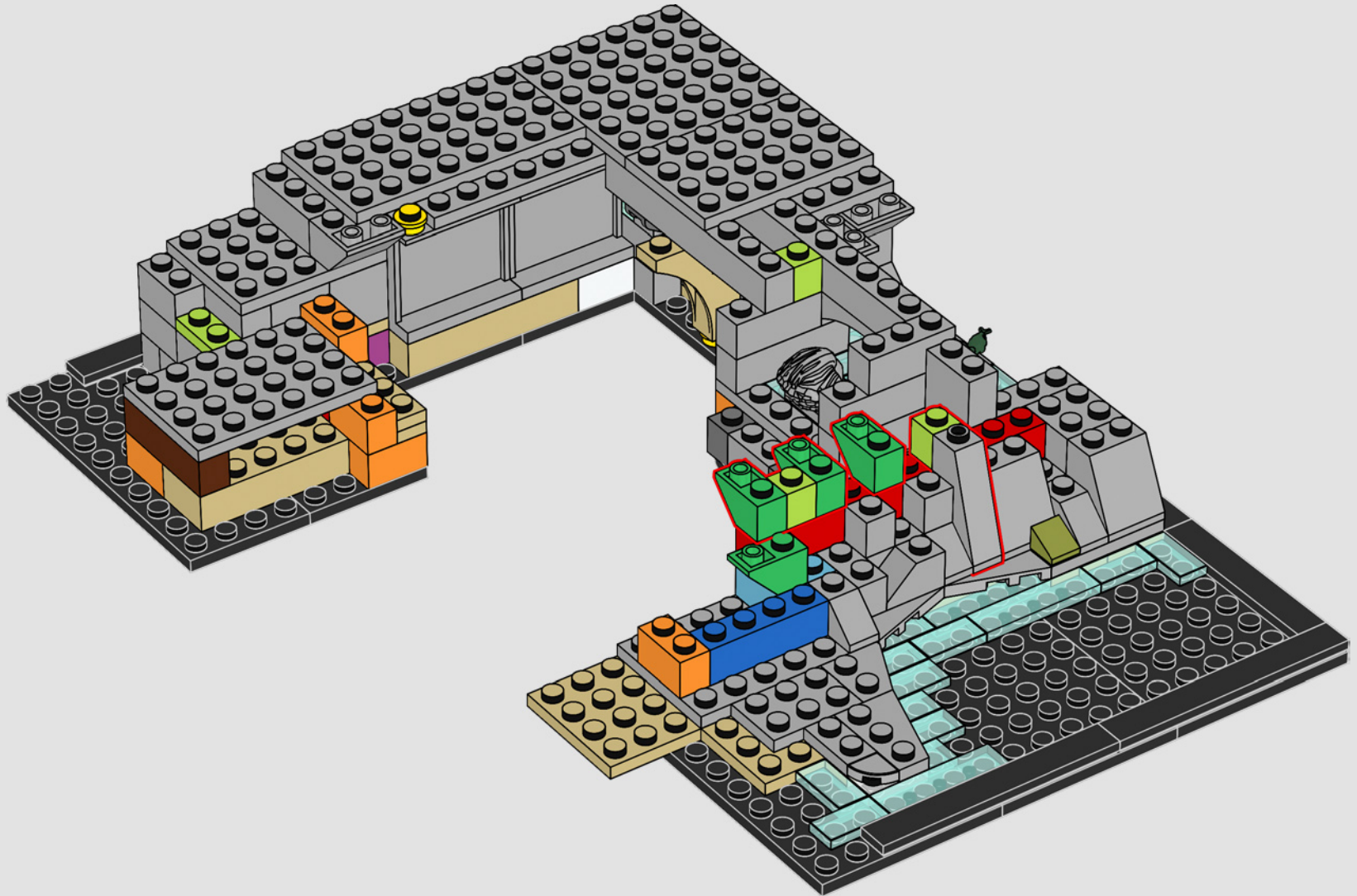

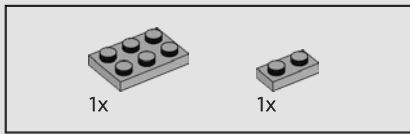

86

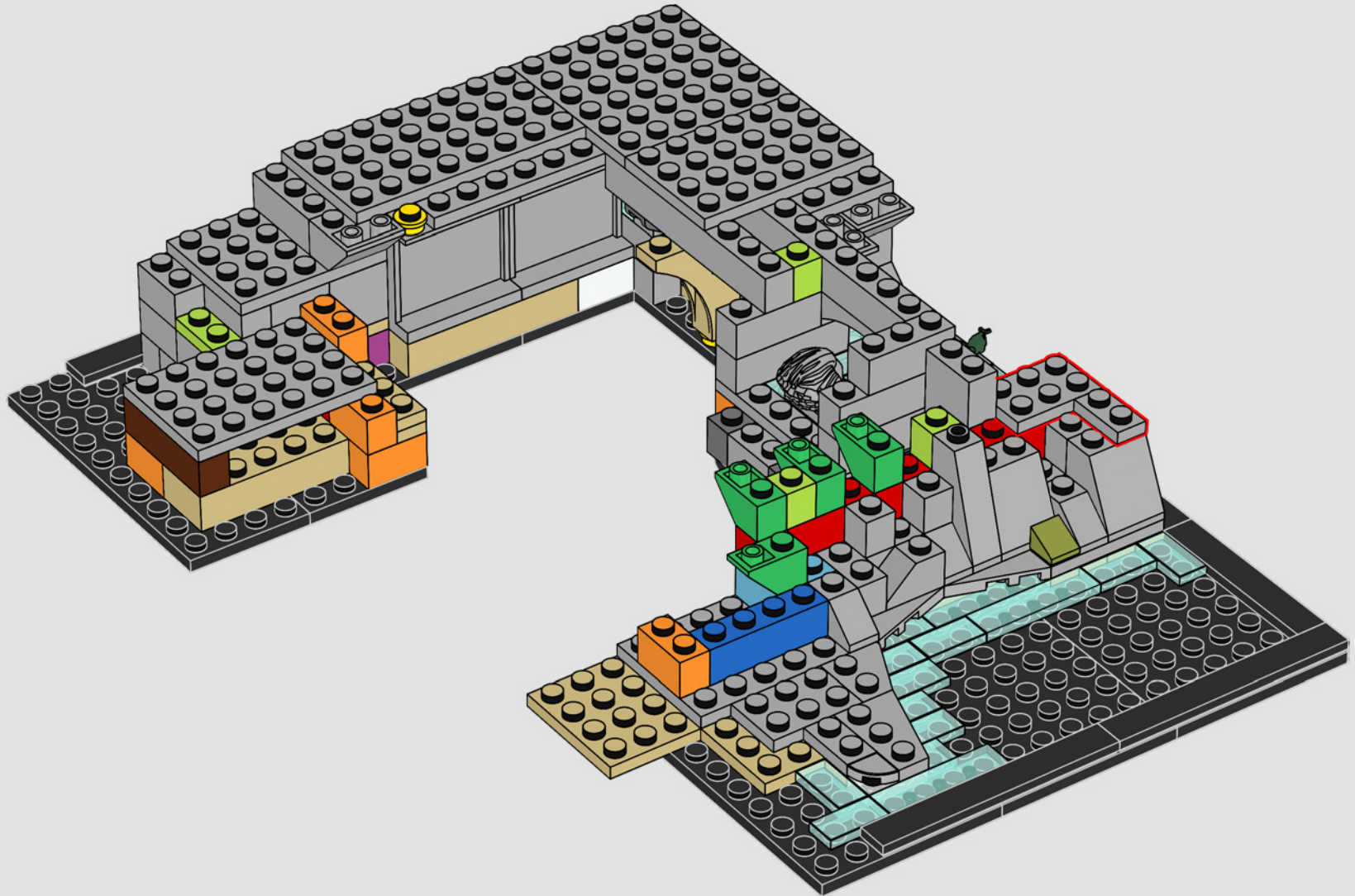



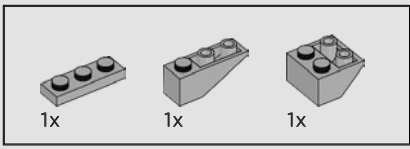

87

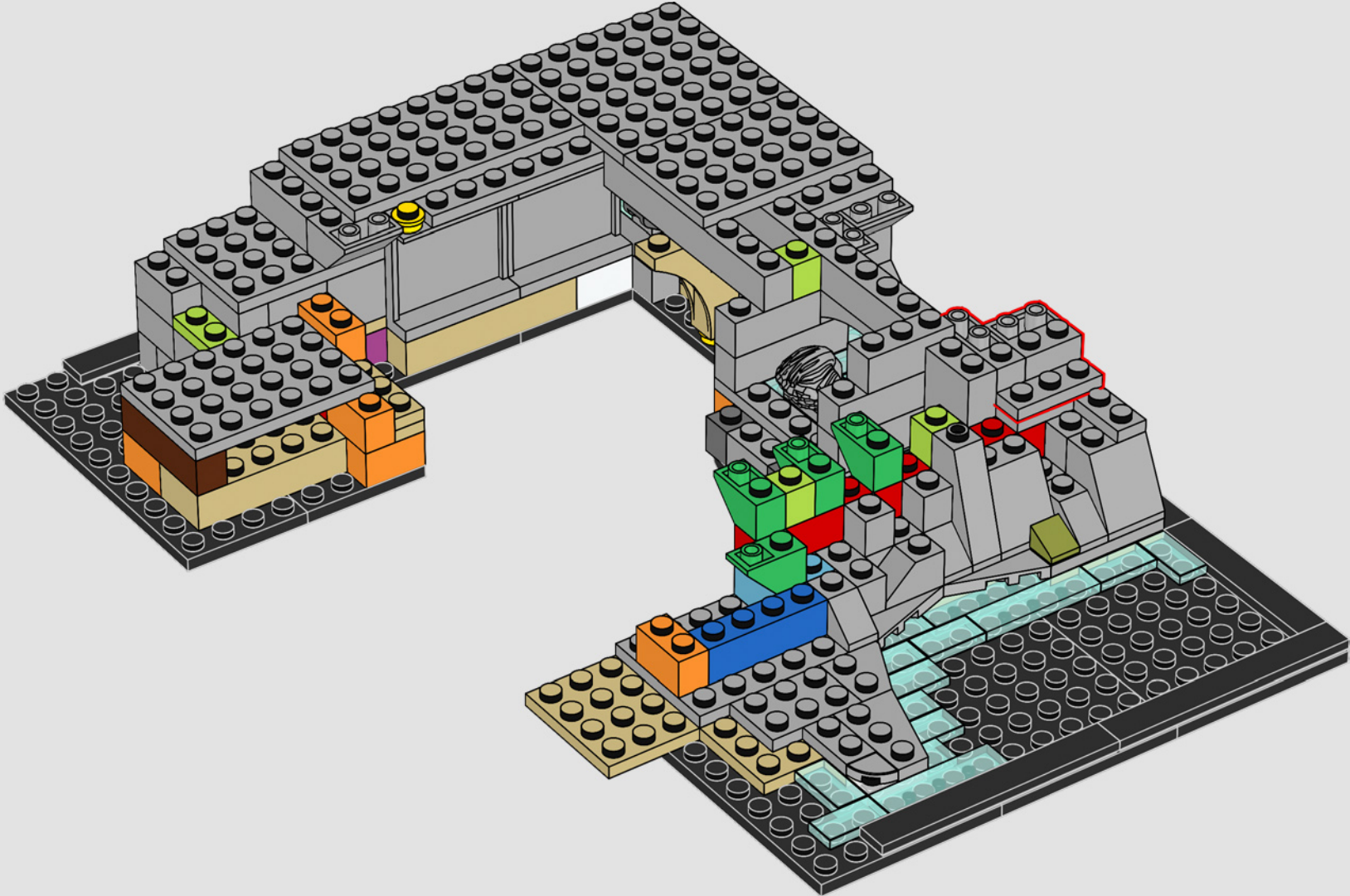



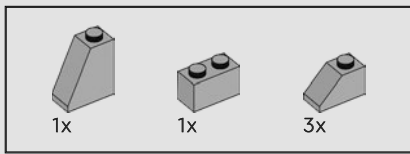

88

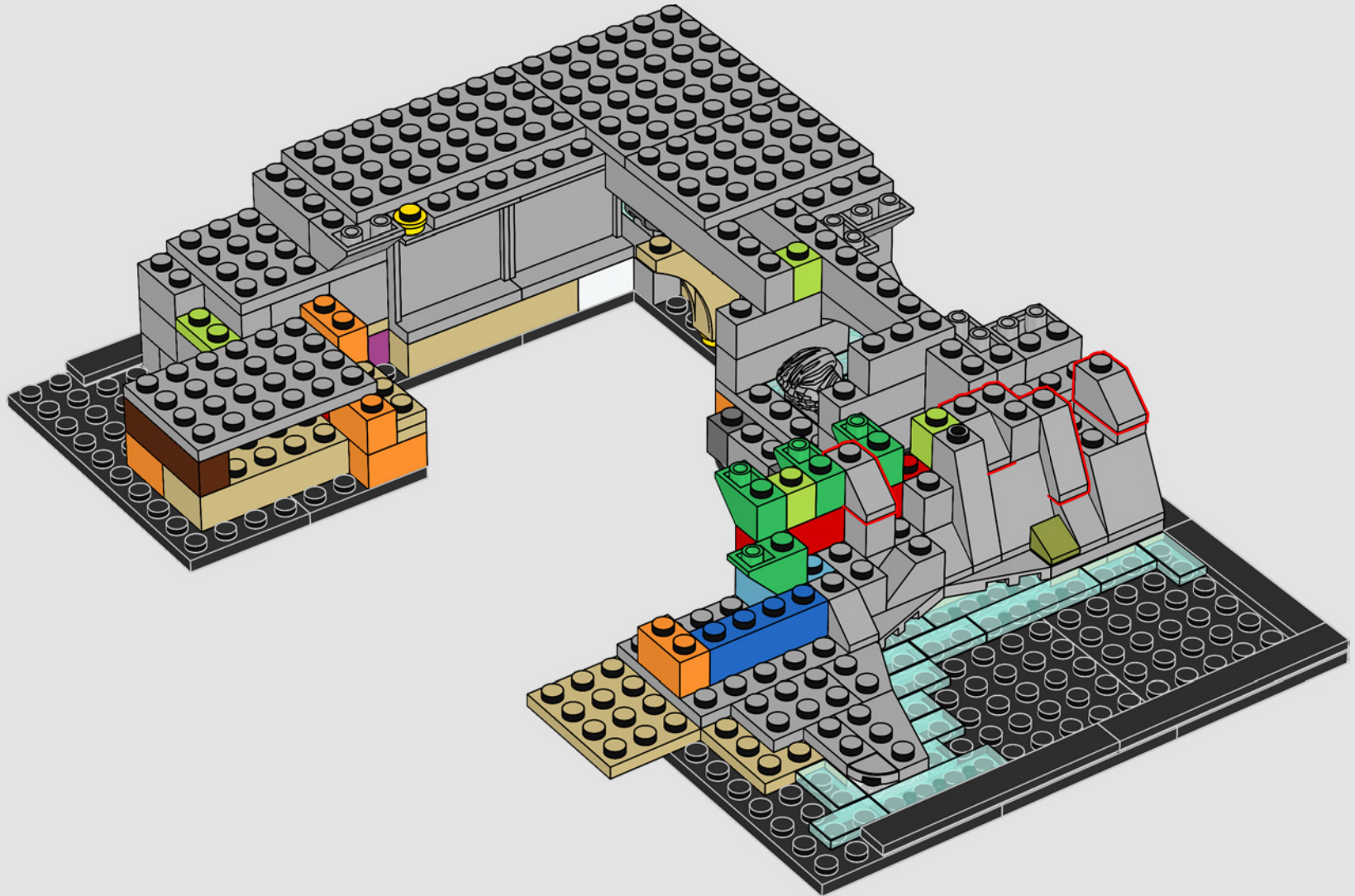

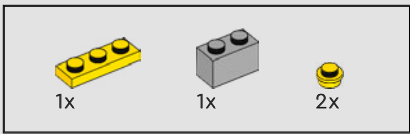

89

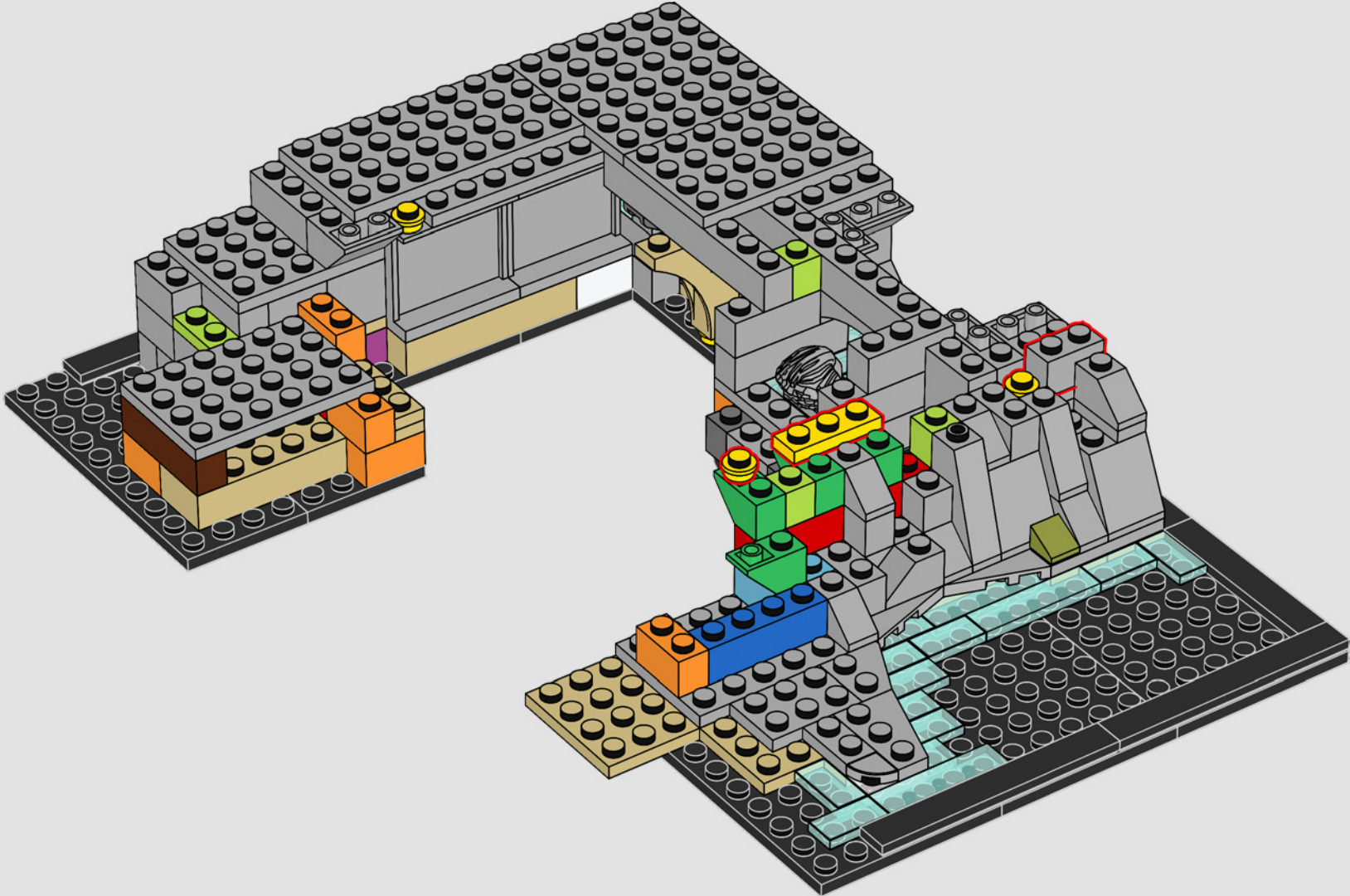

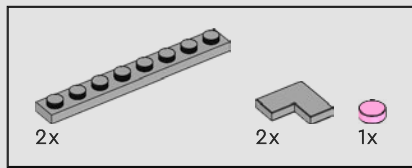

90

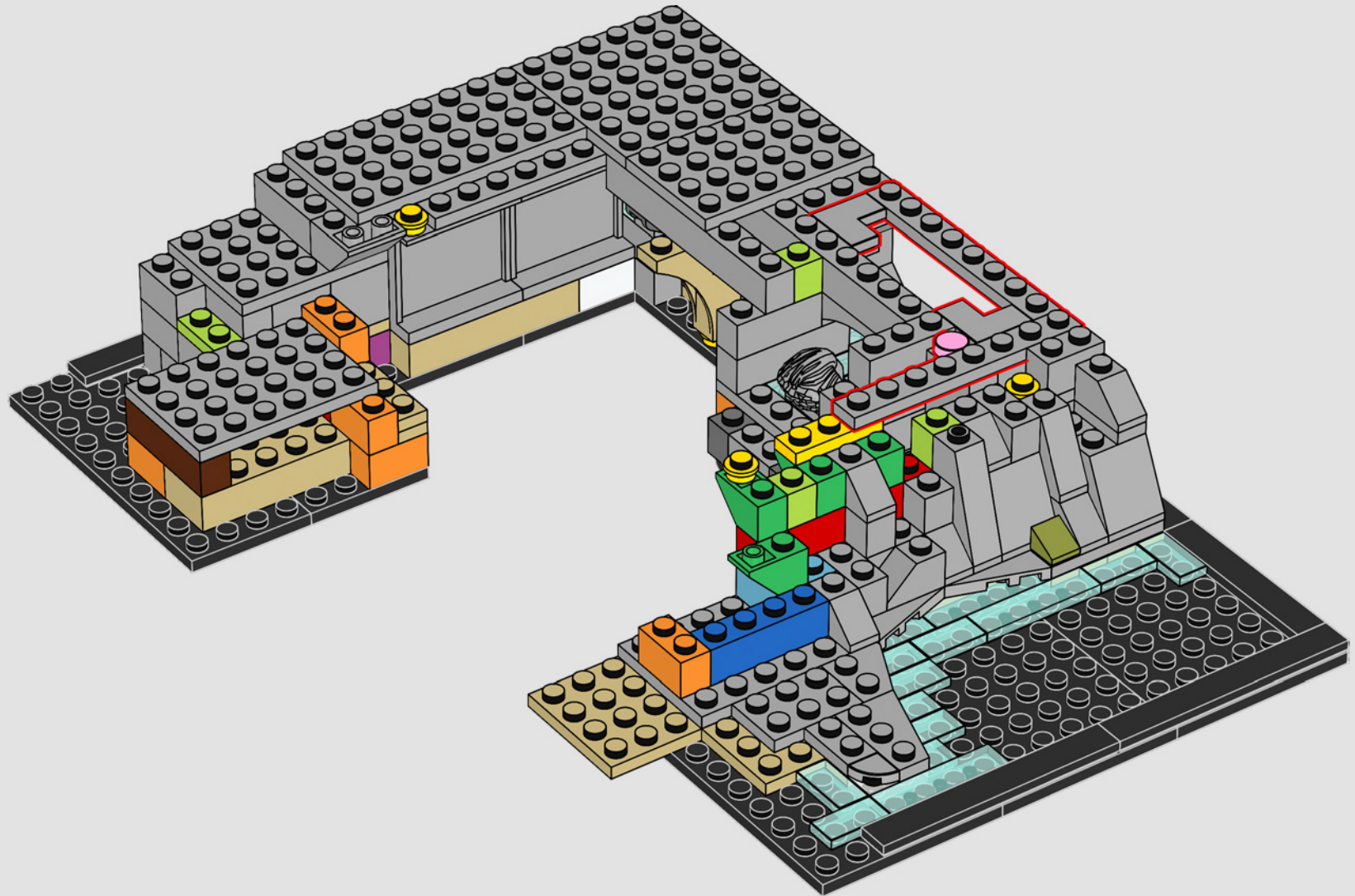



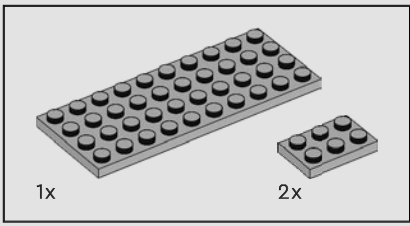

91

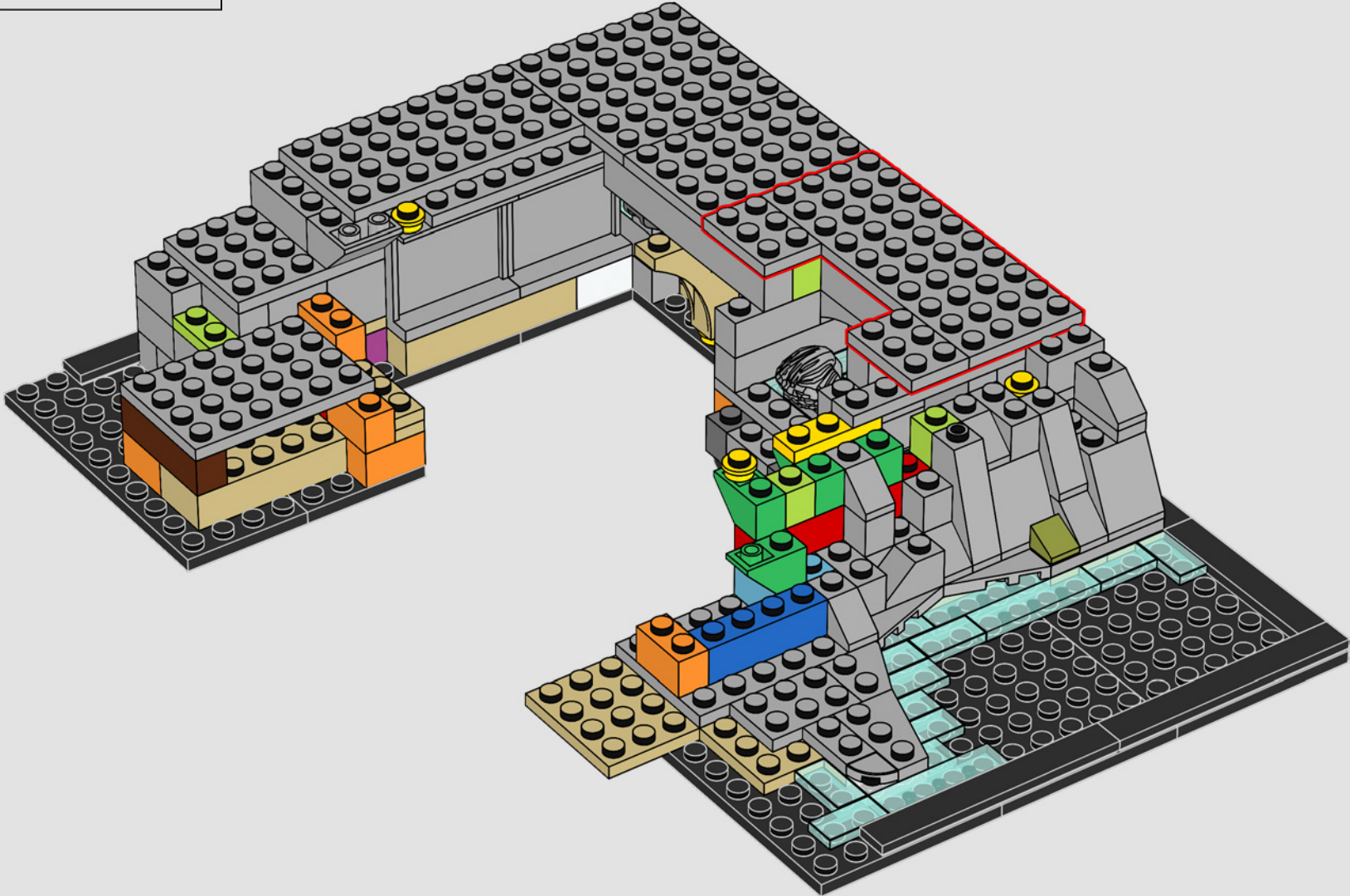



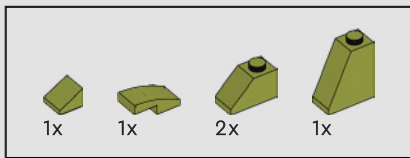

92

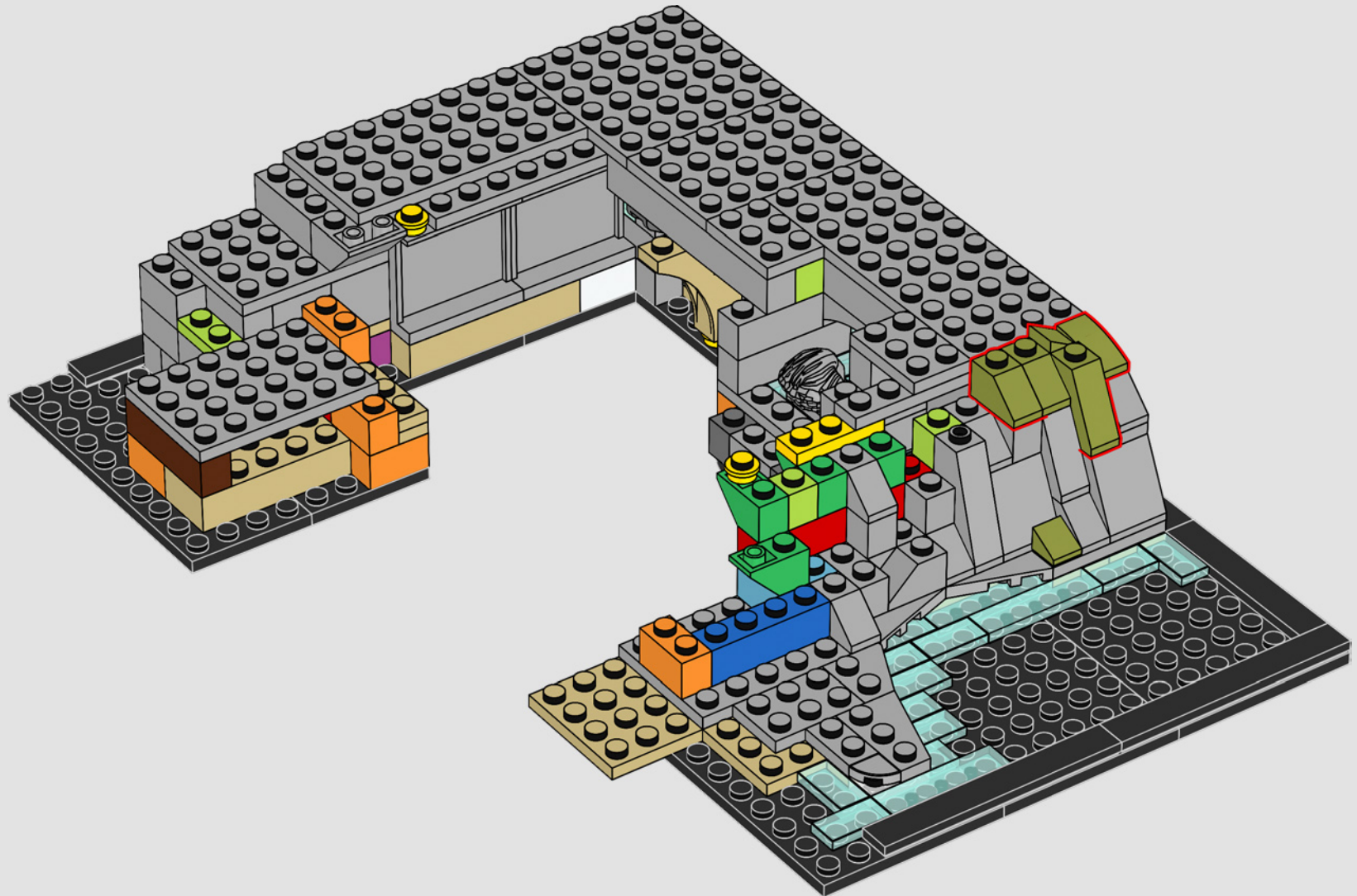

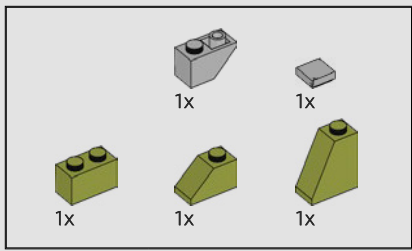

93

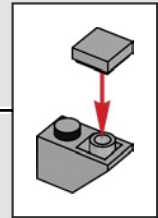
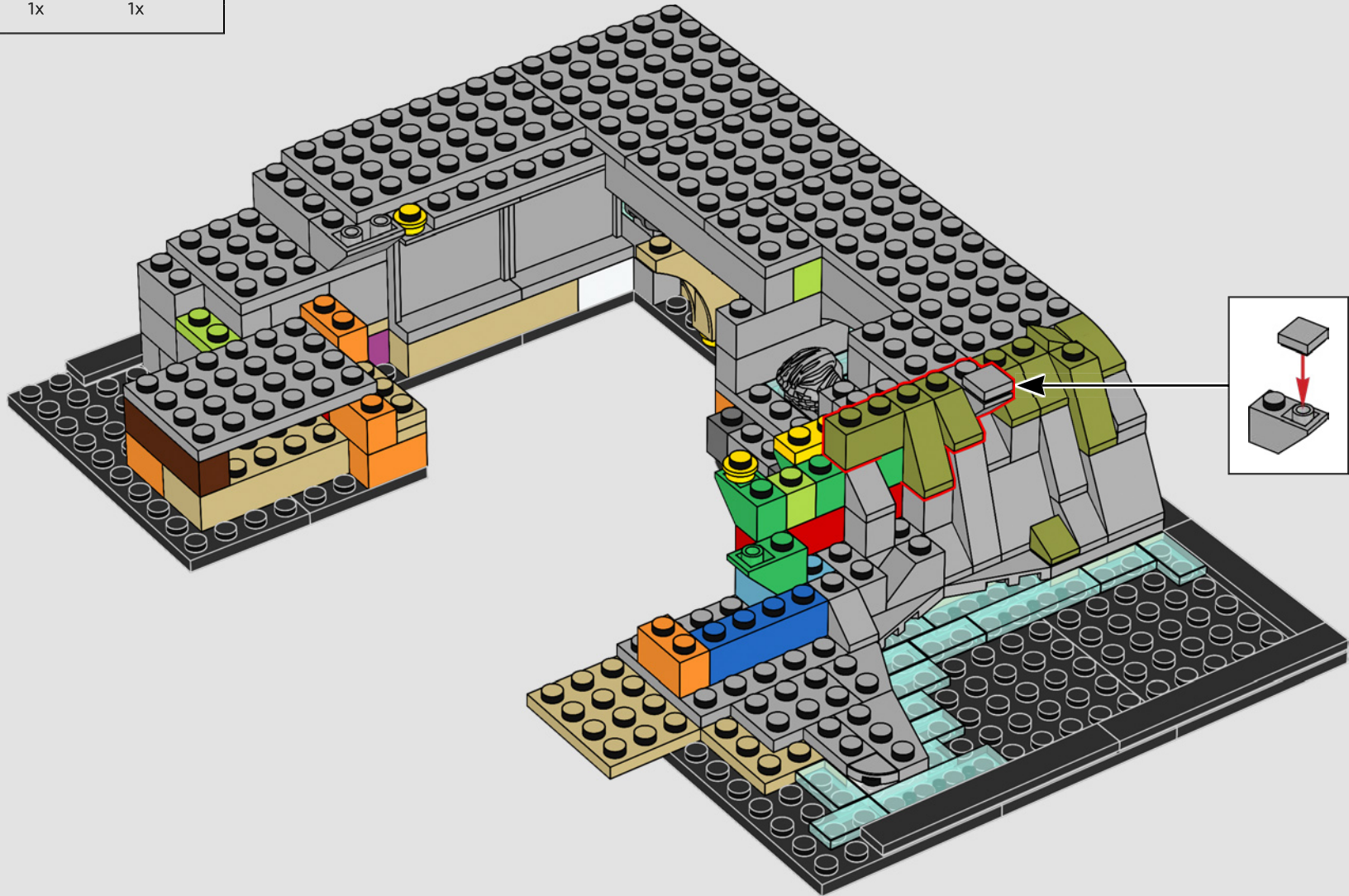

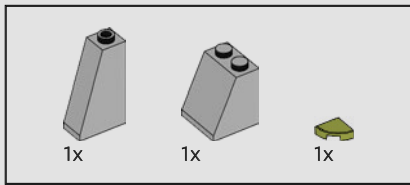

94

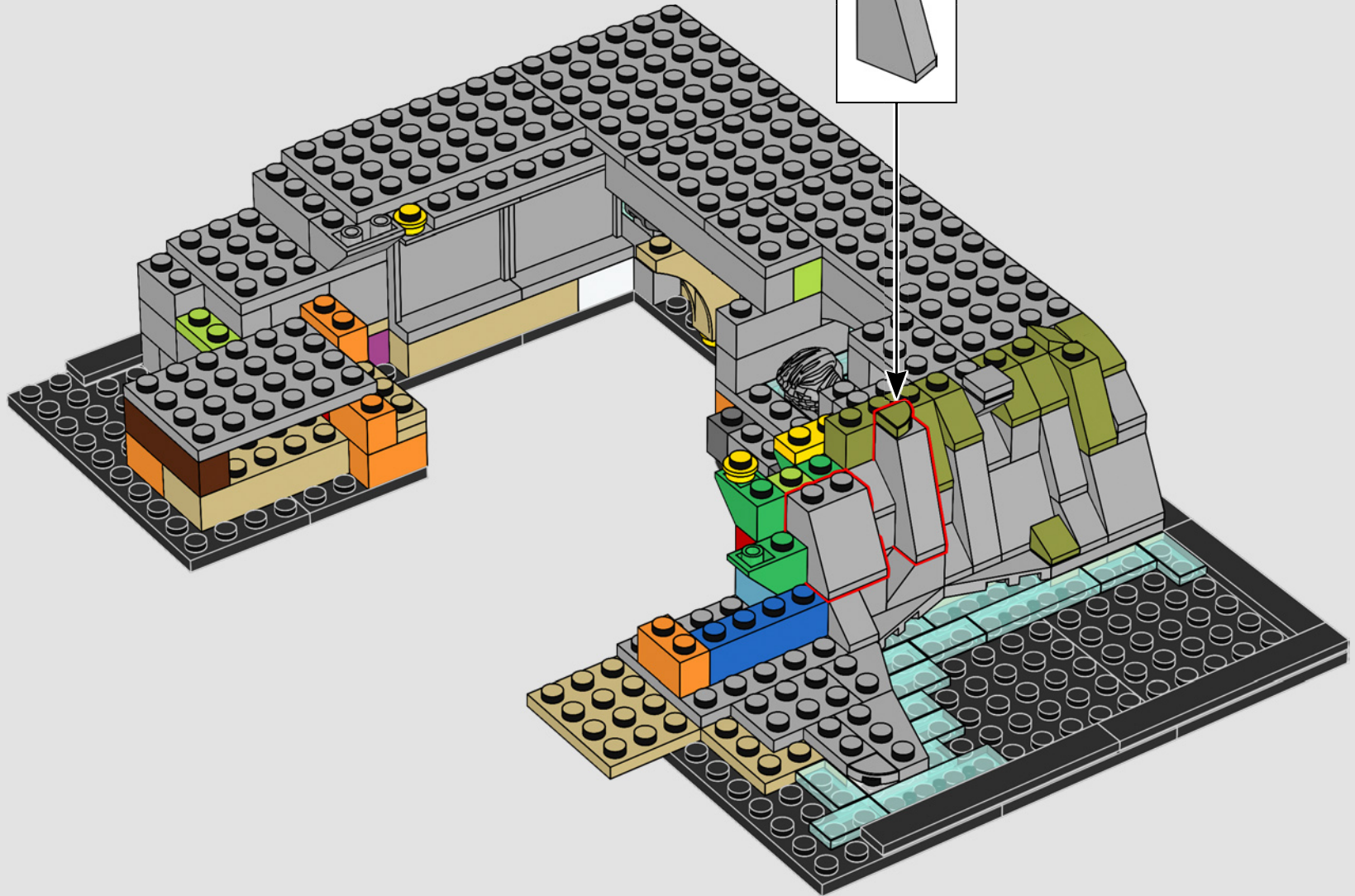
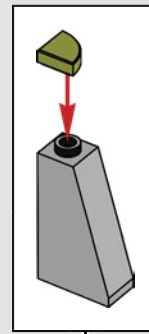



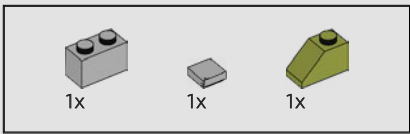

95

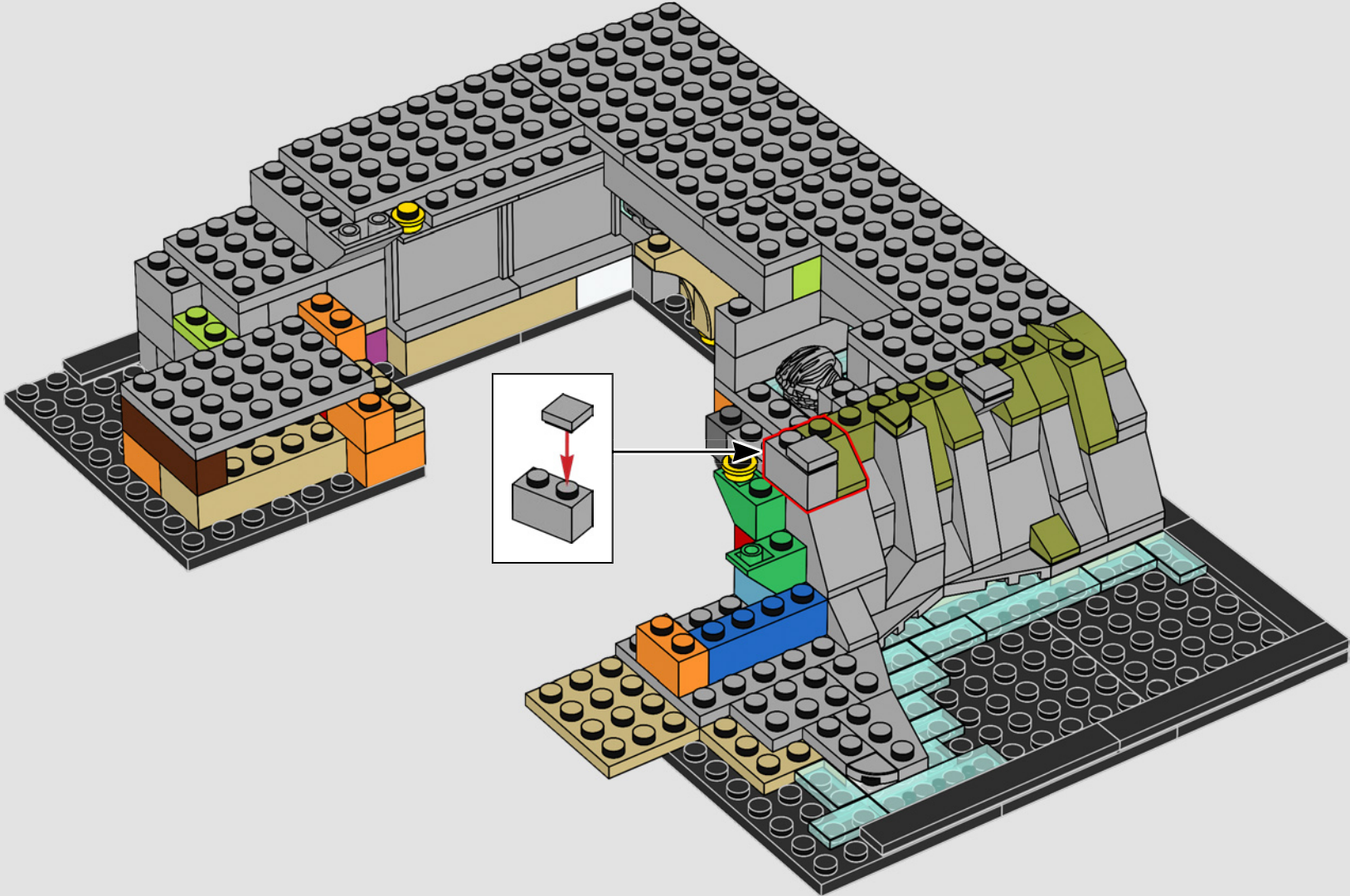



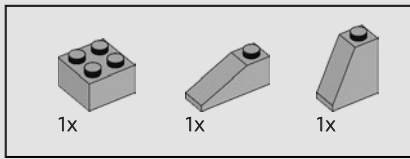

96

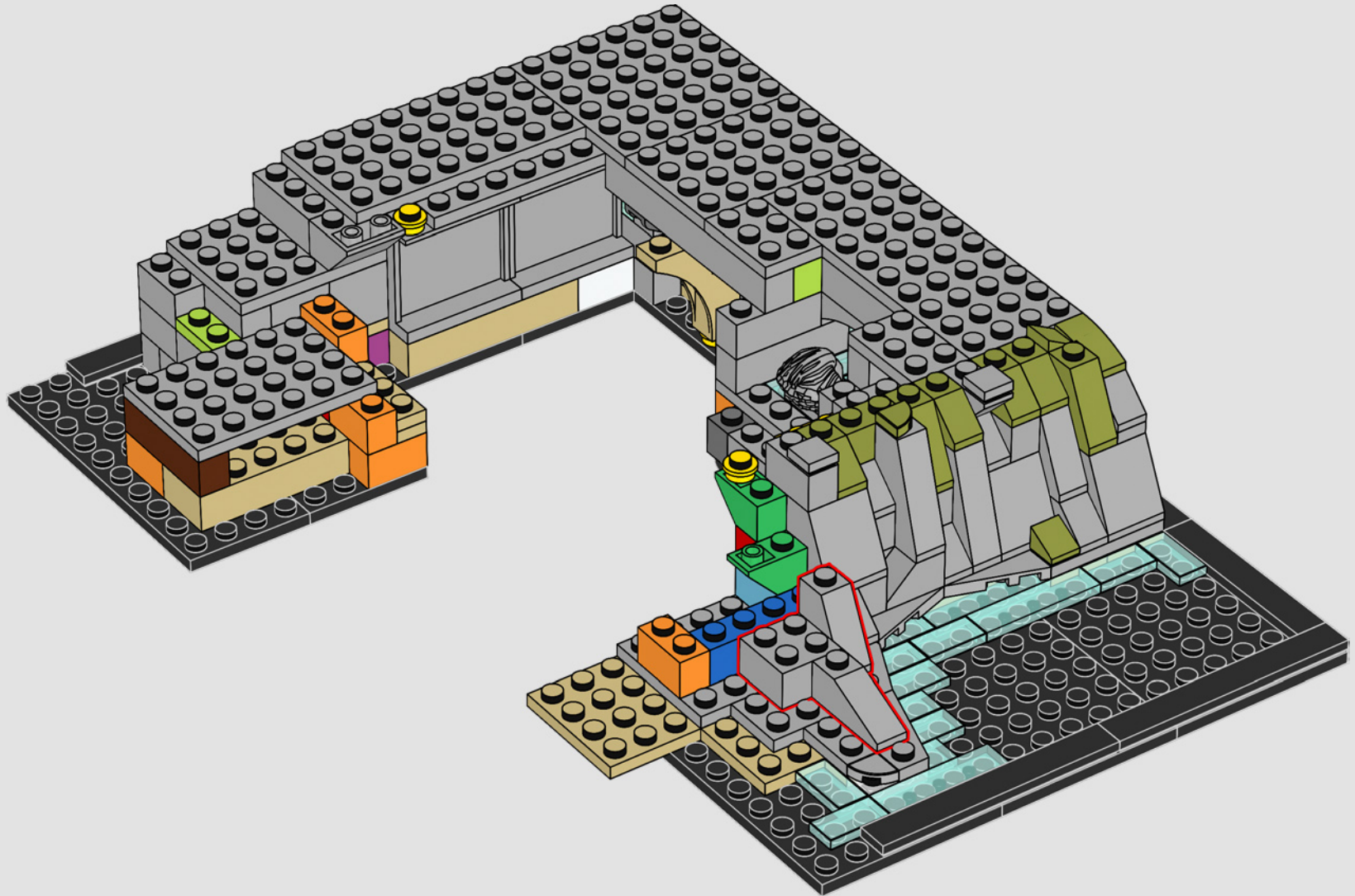

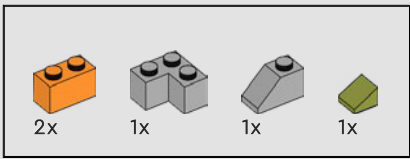

97

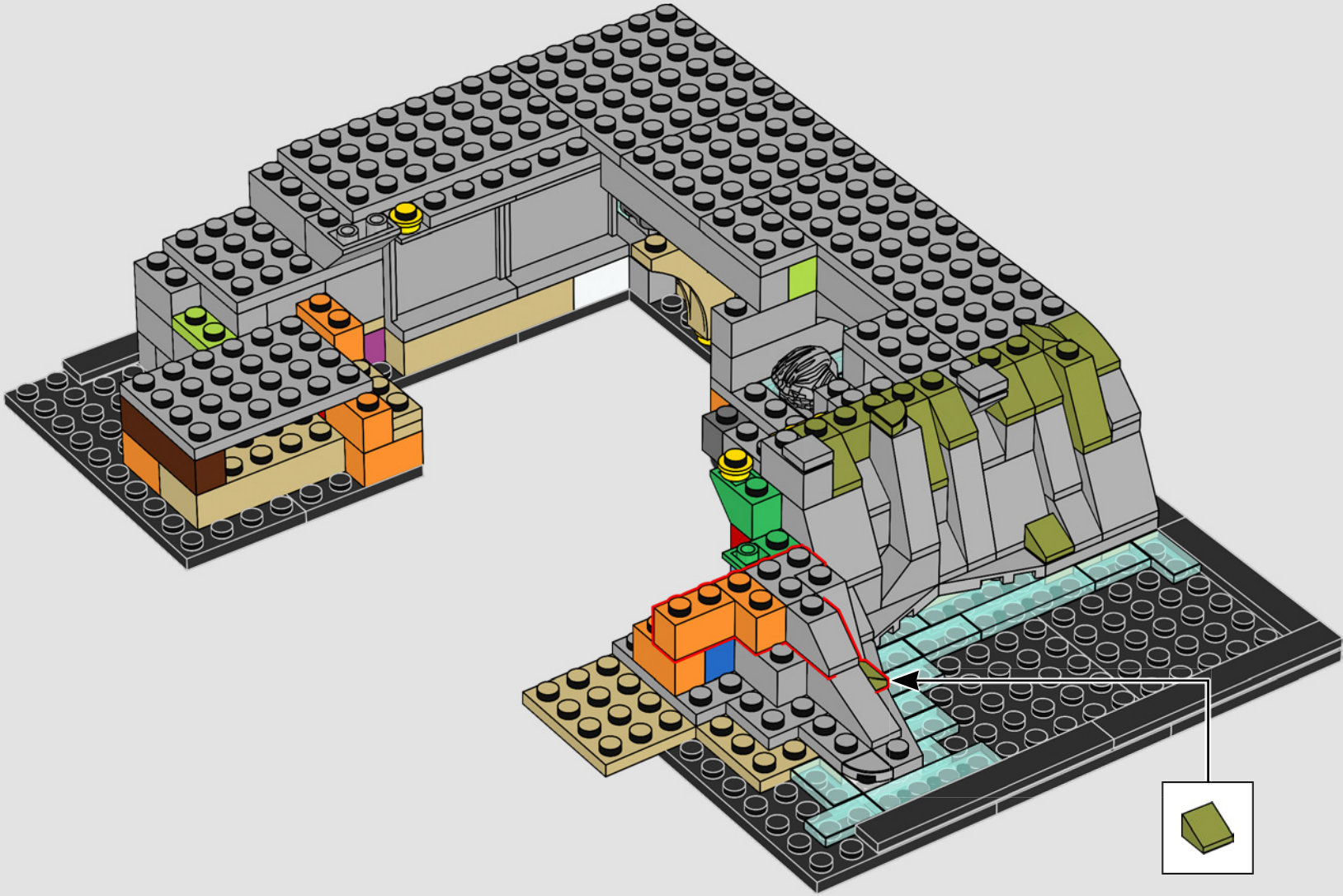

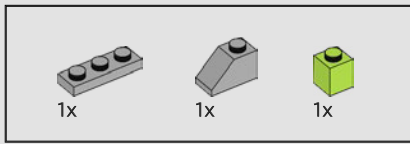

98

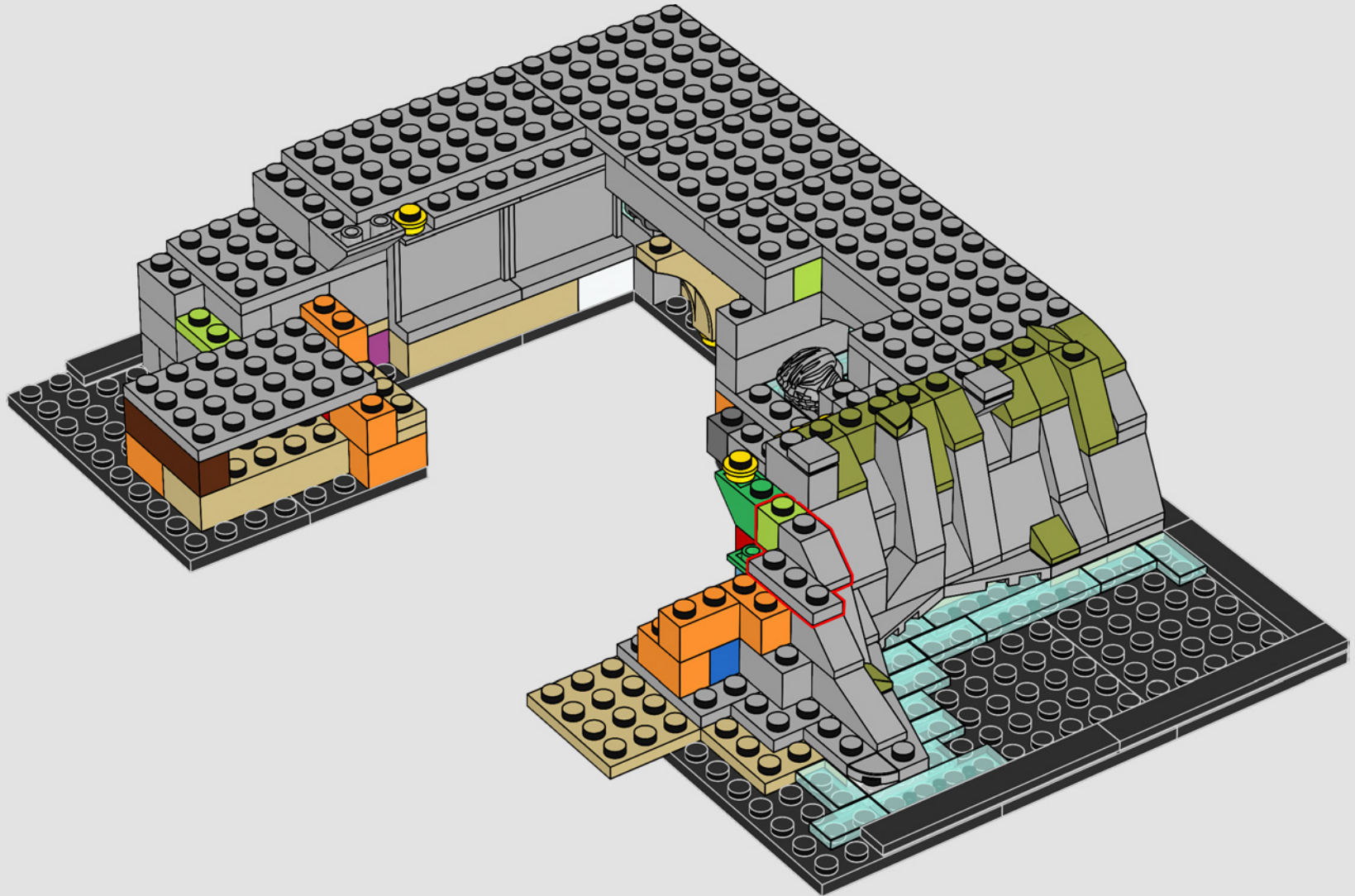



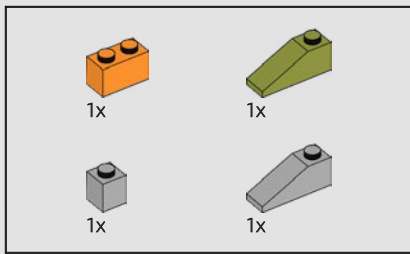

99

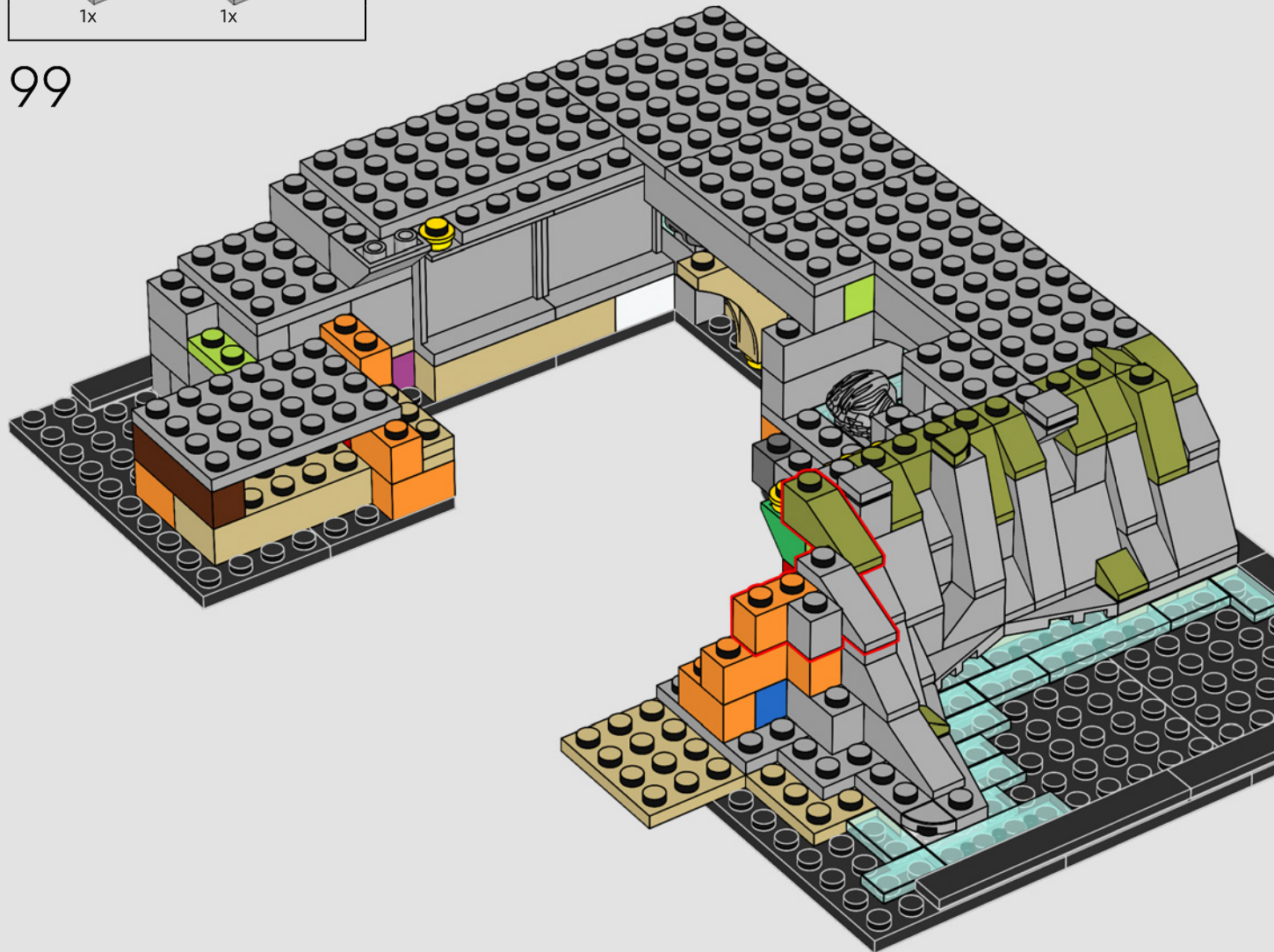

Se i Babbani dovessero imbattersi per caso nel parco di Hogwarts™, il castello sembrerà un rudere abbandonato e i cartelli di avvertimento li scoraggeranno dall'esplorare ulteriormente il sito.



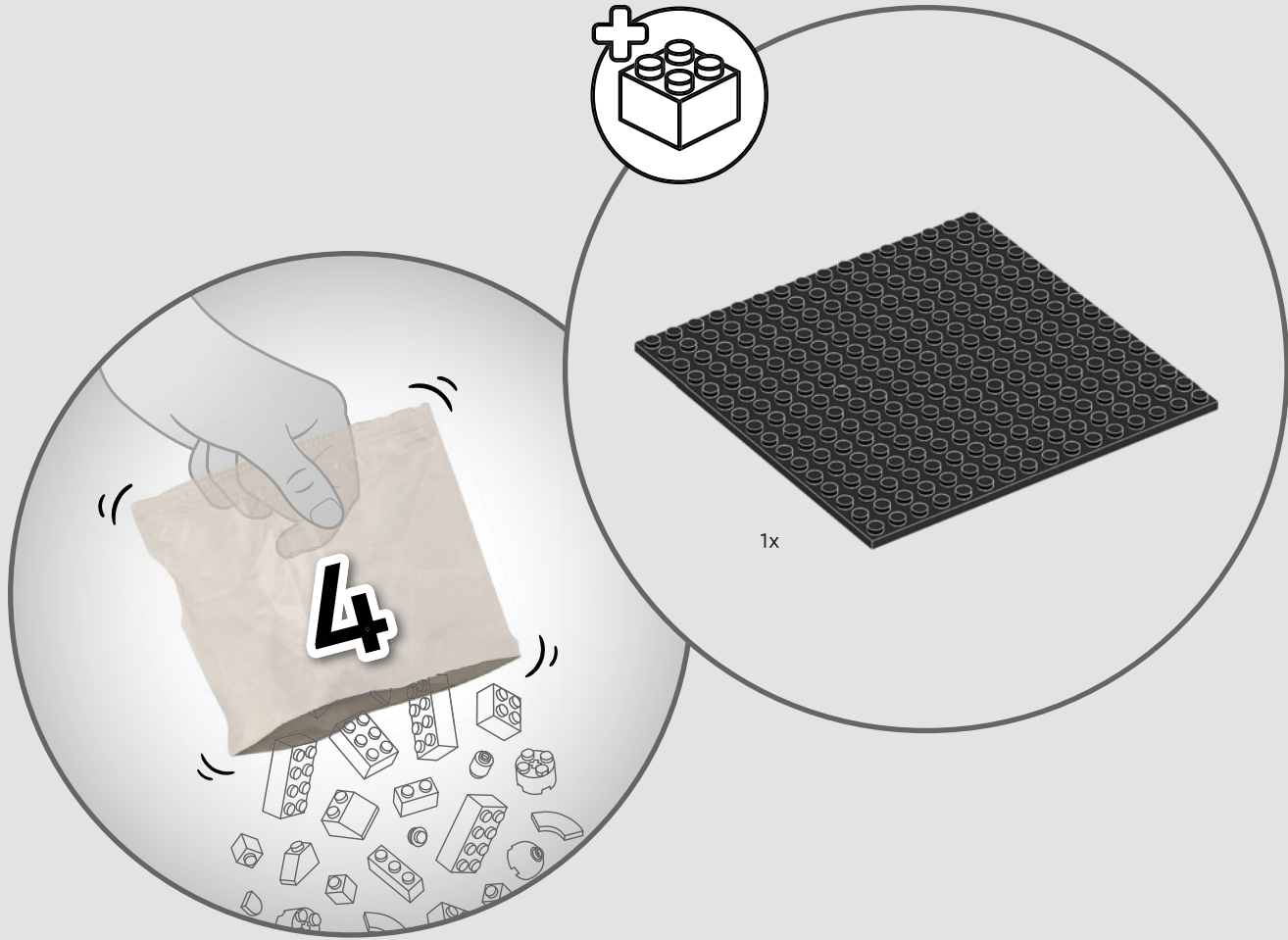

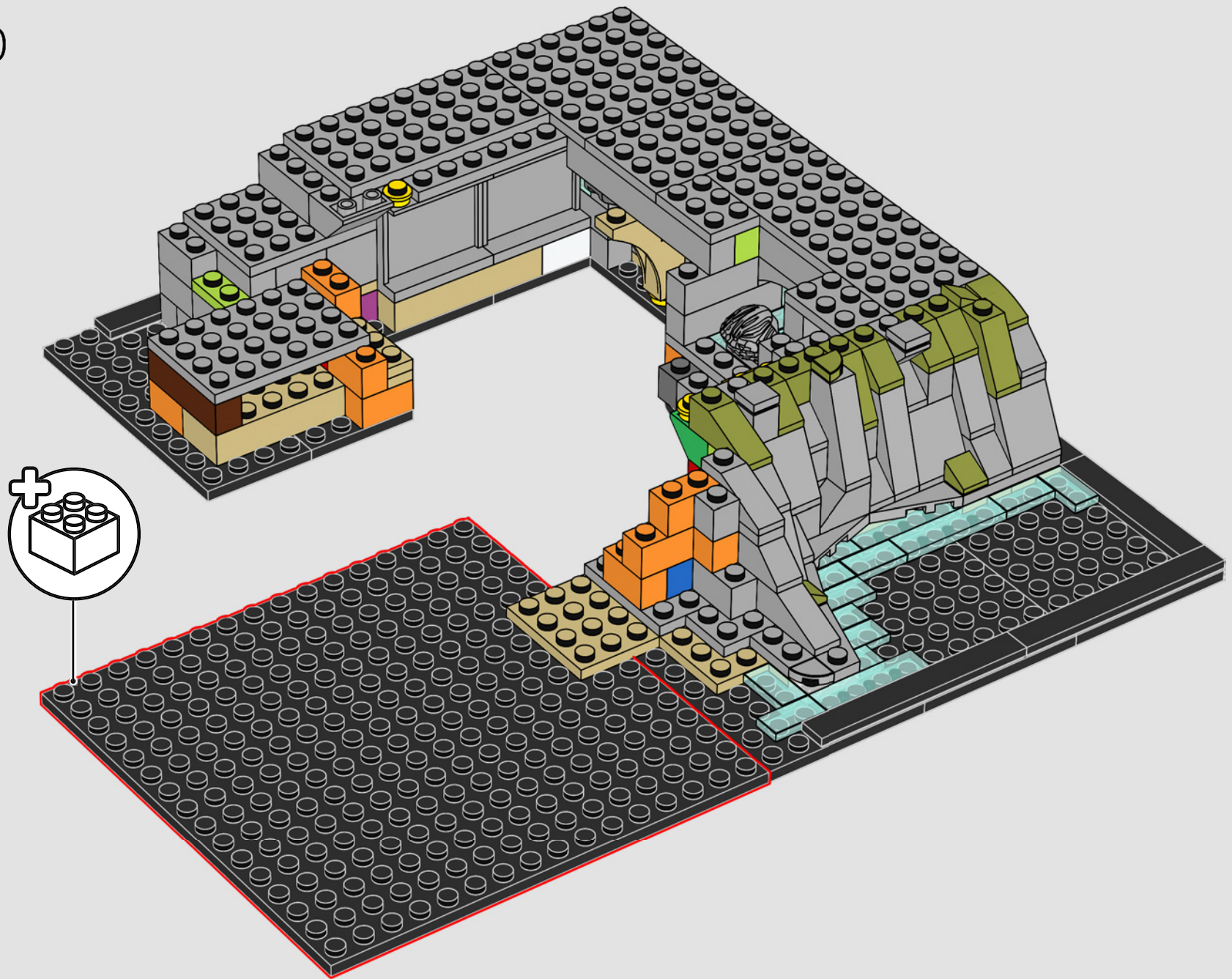

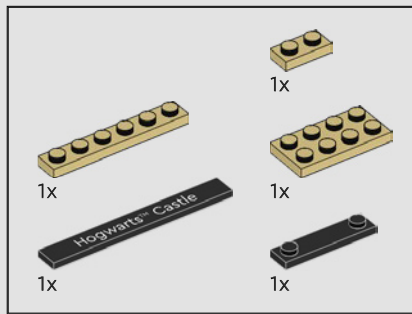

101

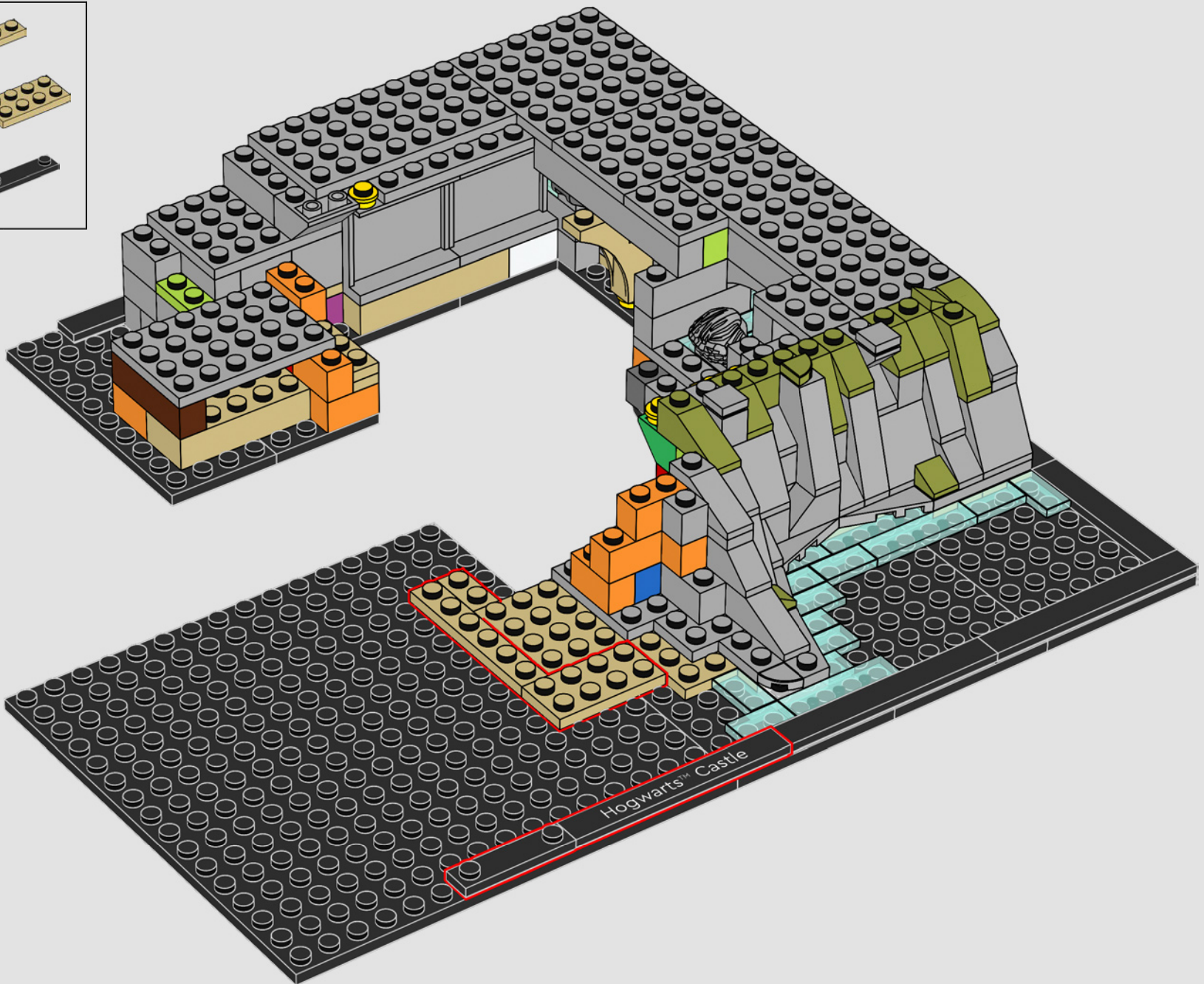



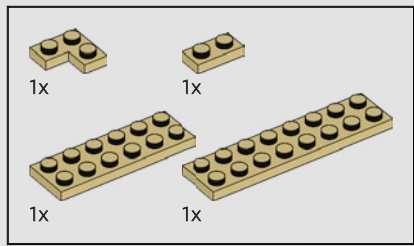

102

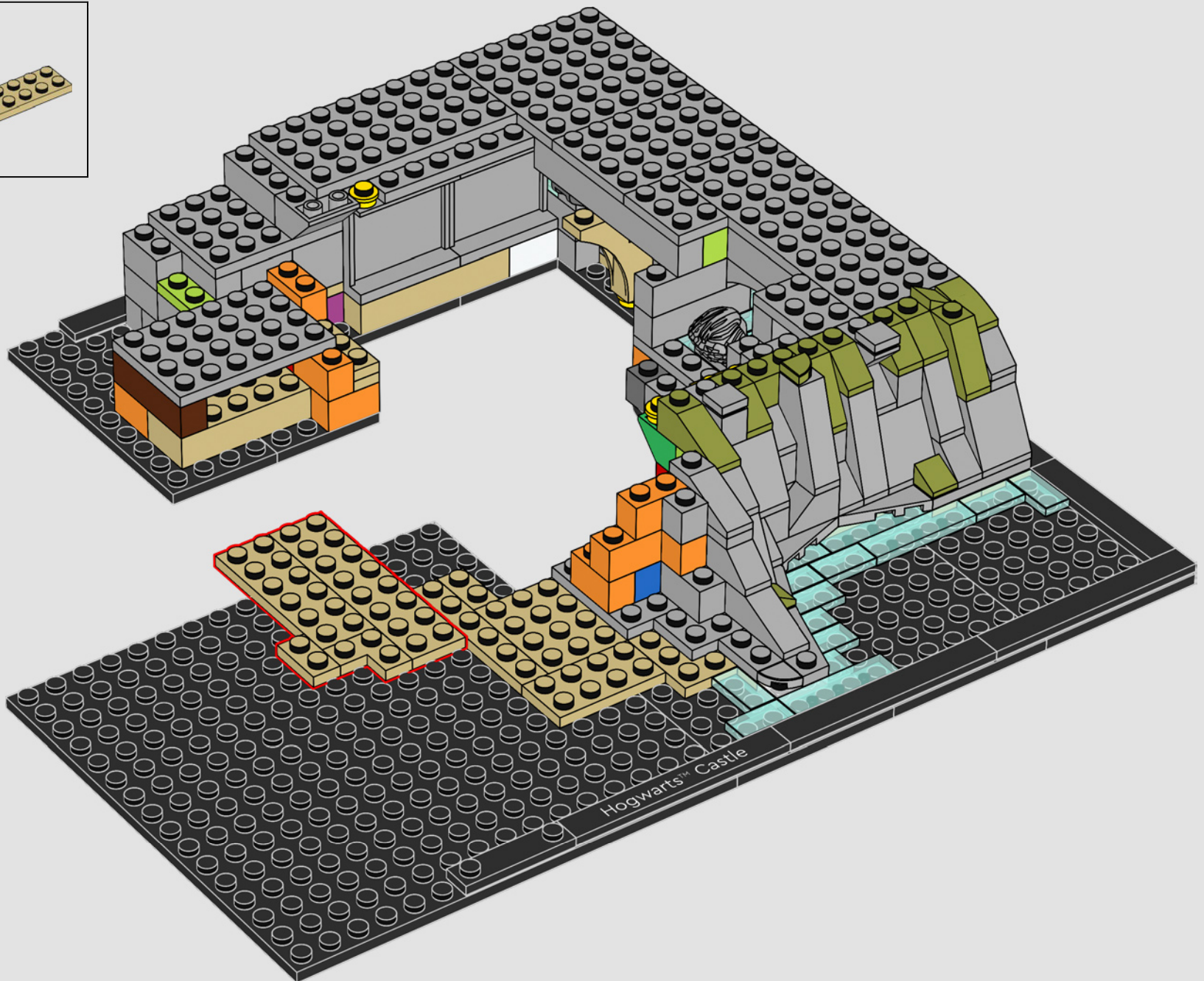



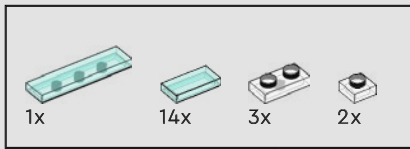

103

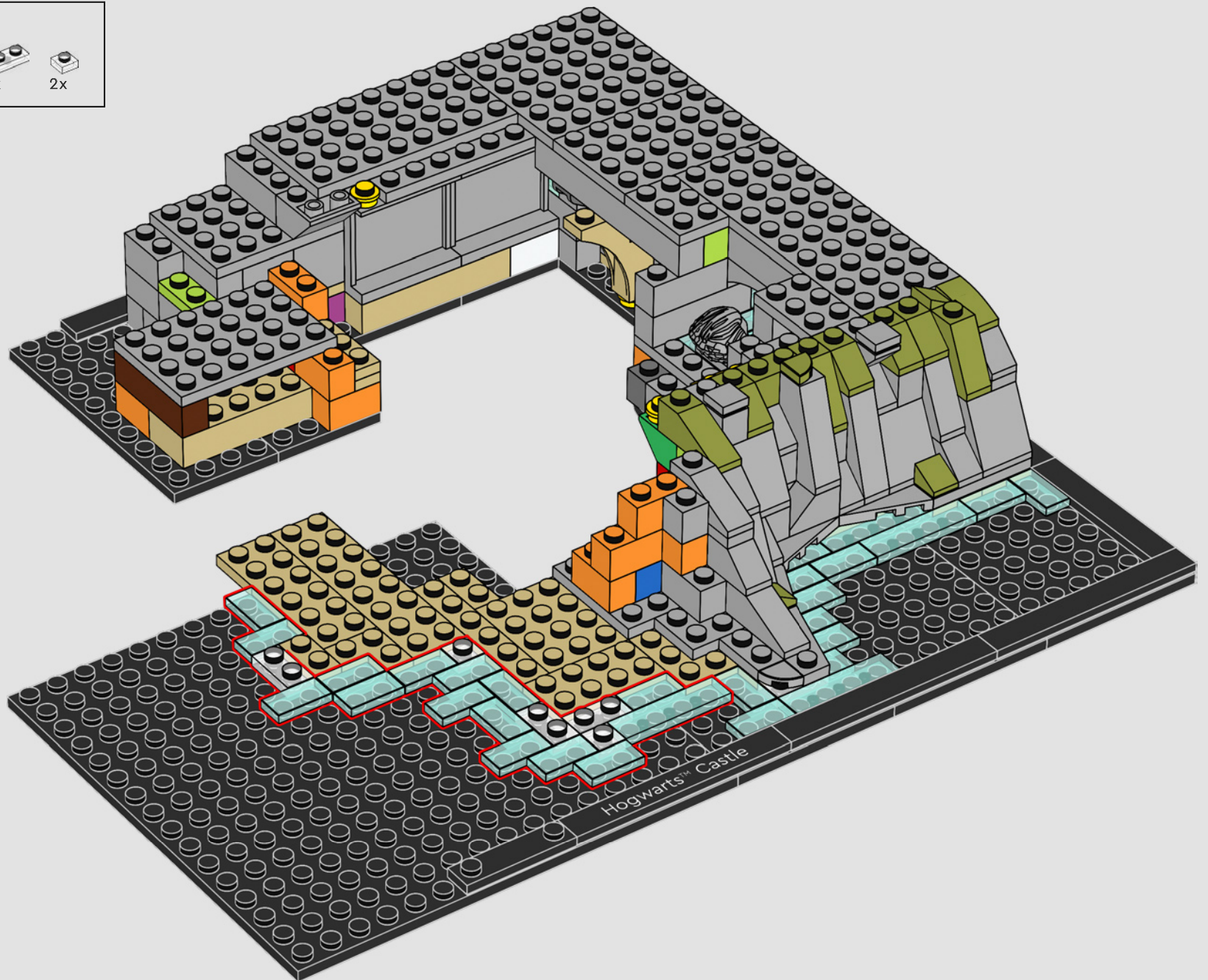

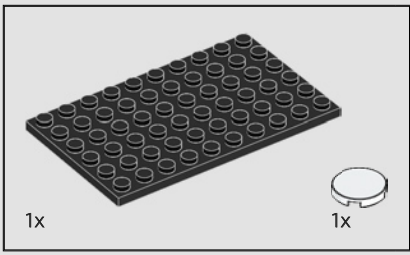

104

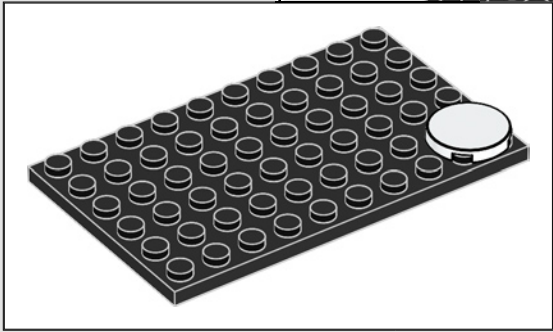
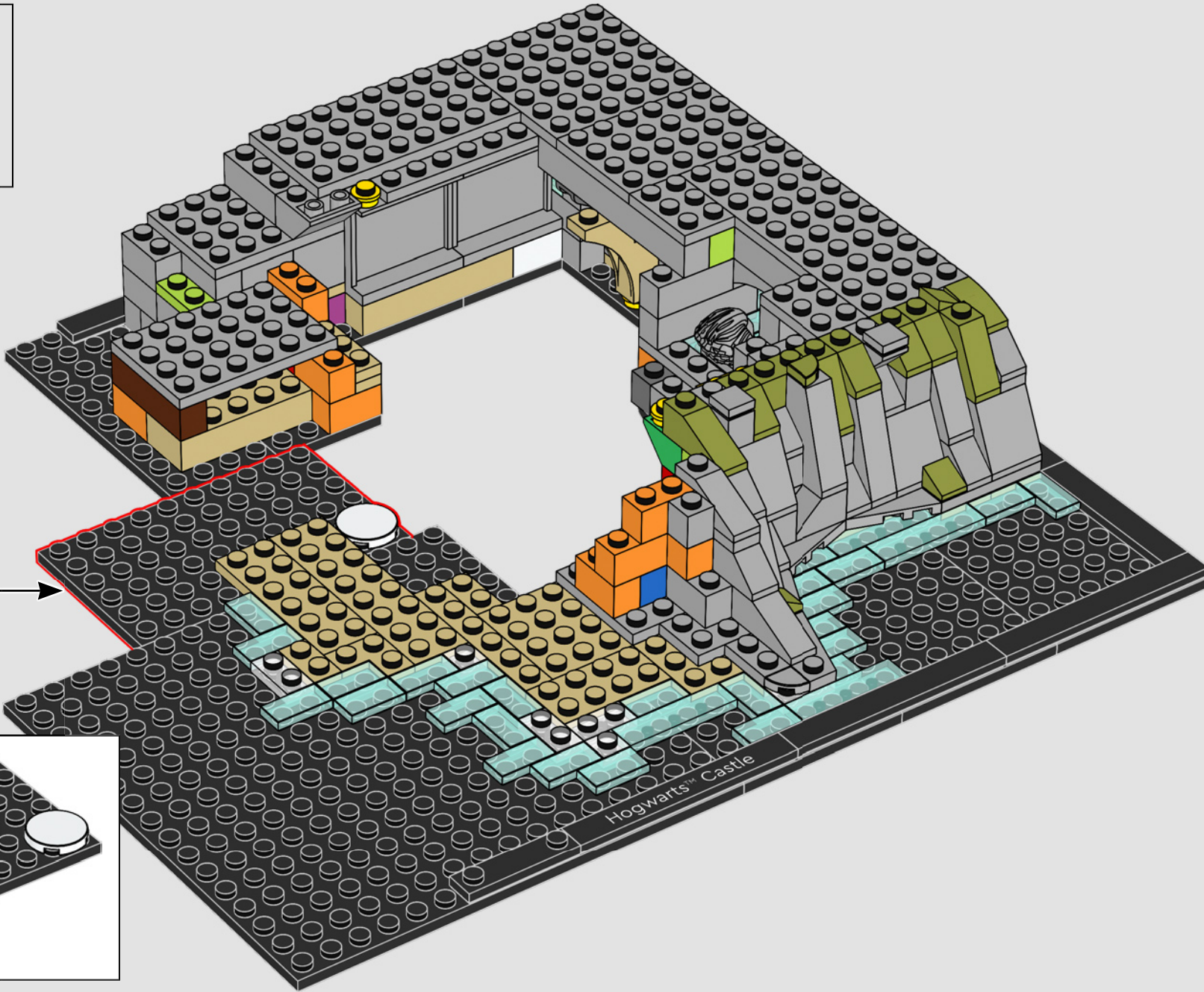



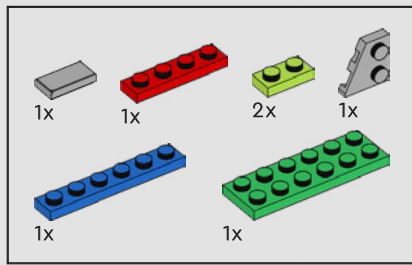

105

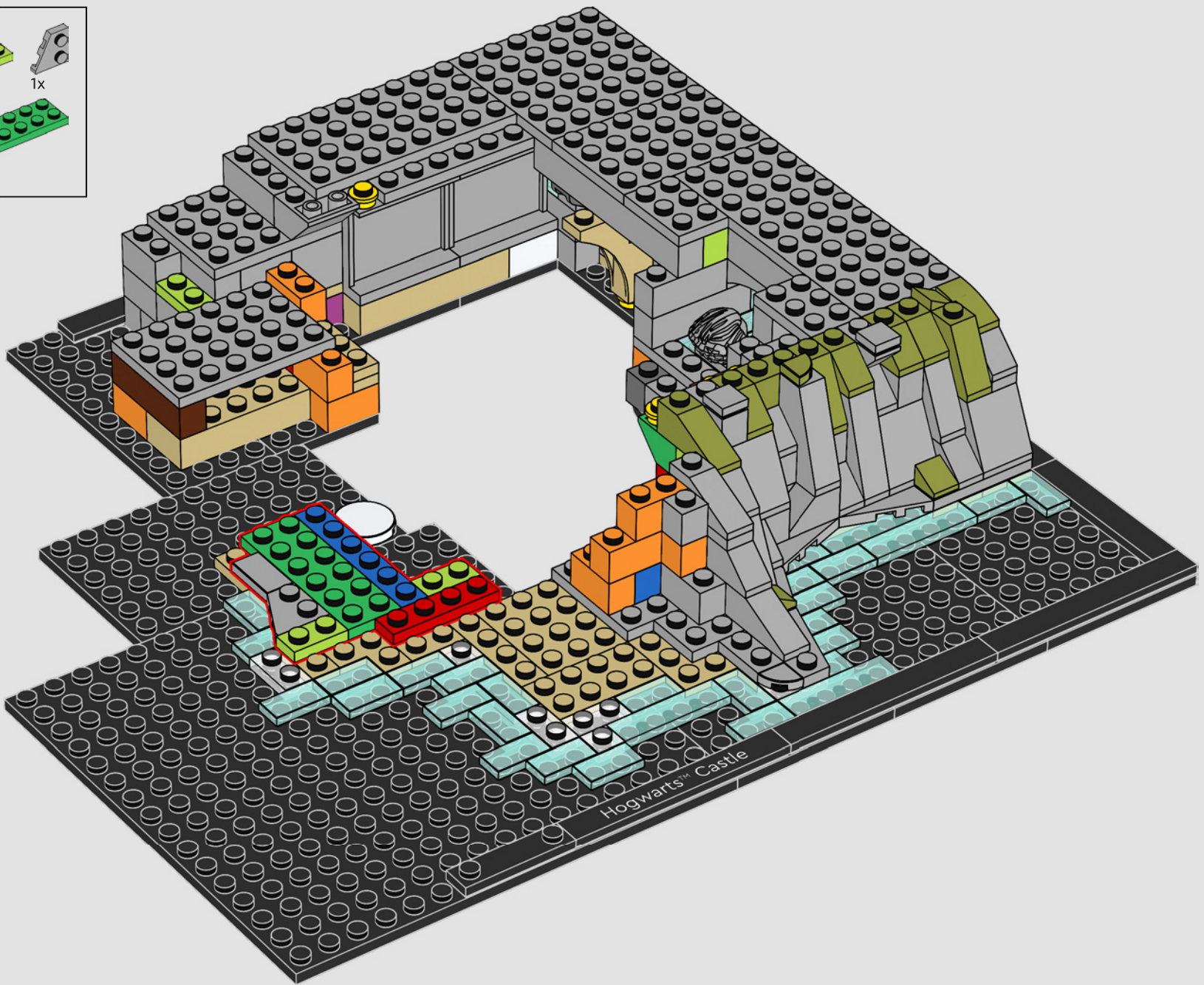



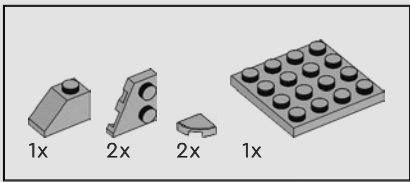

106

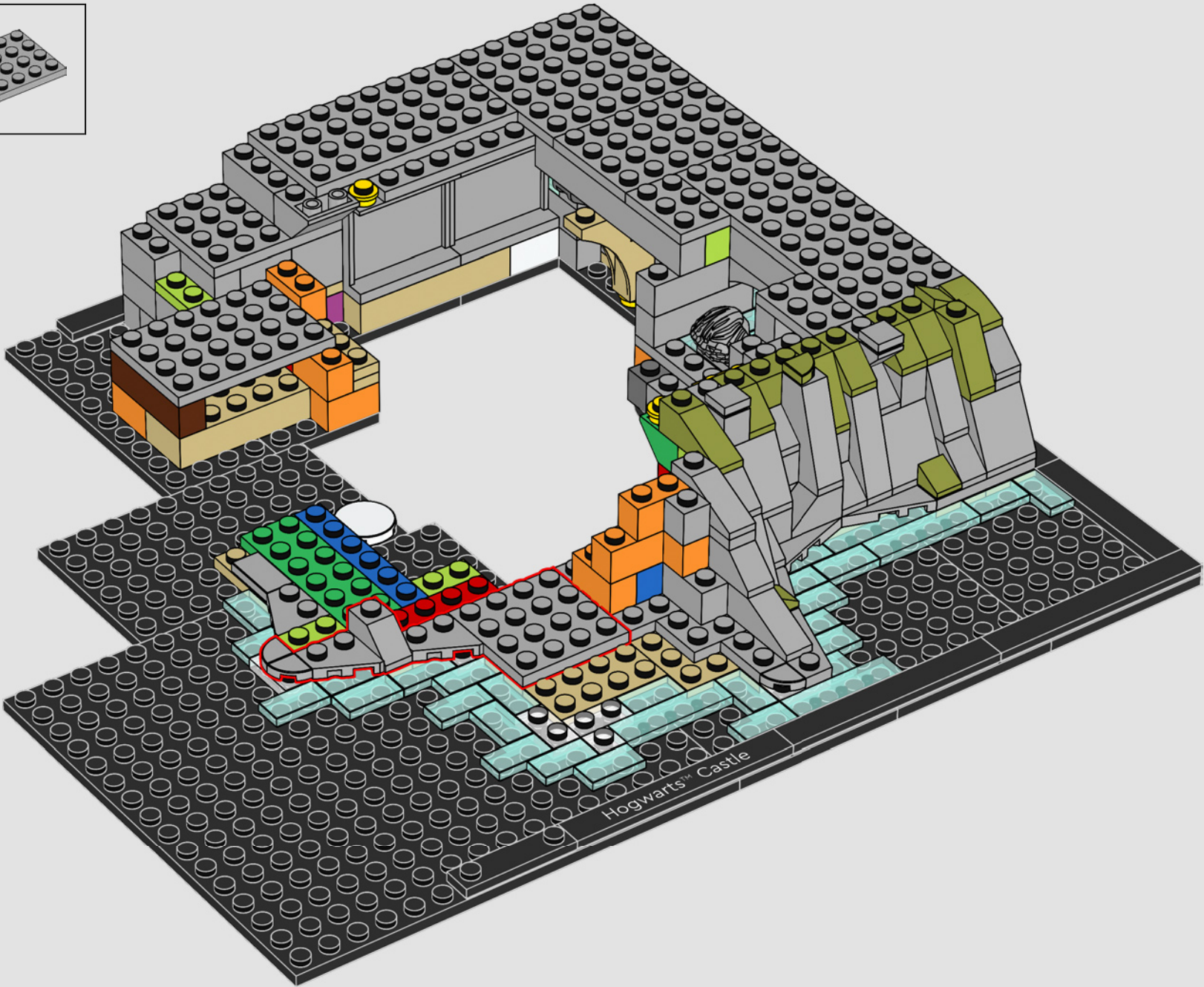

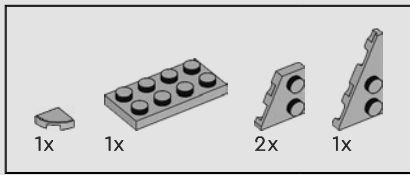

107

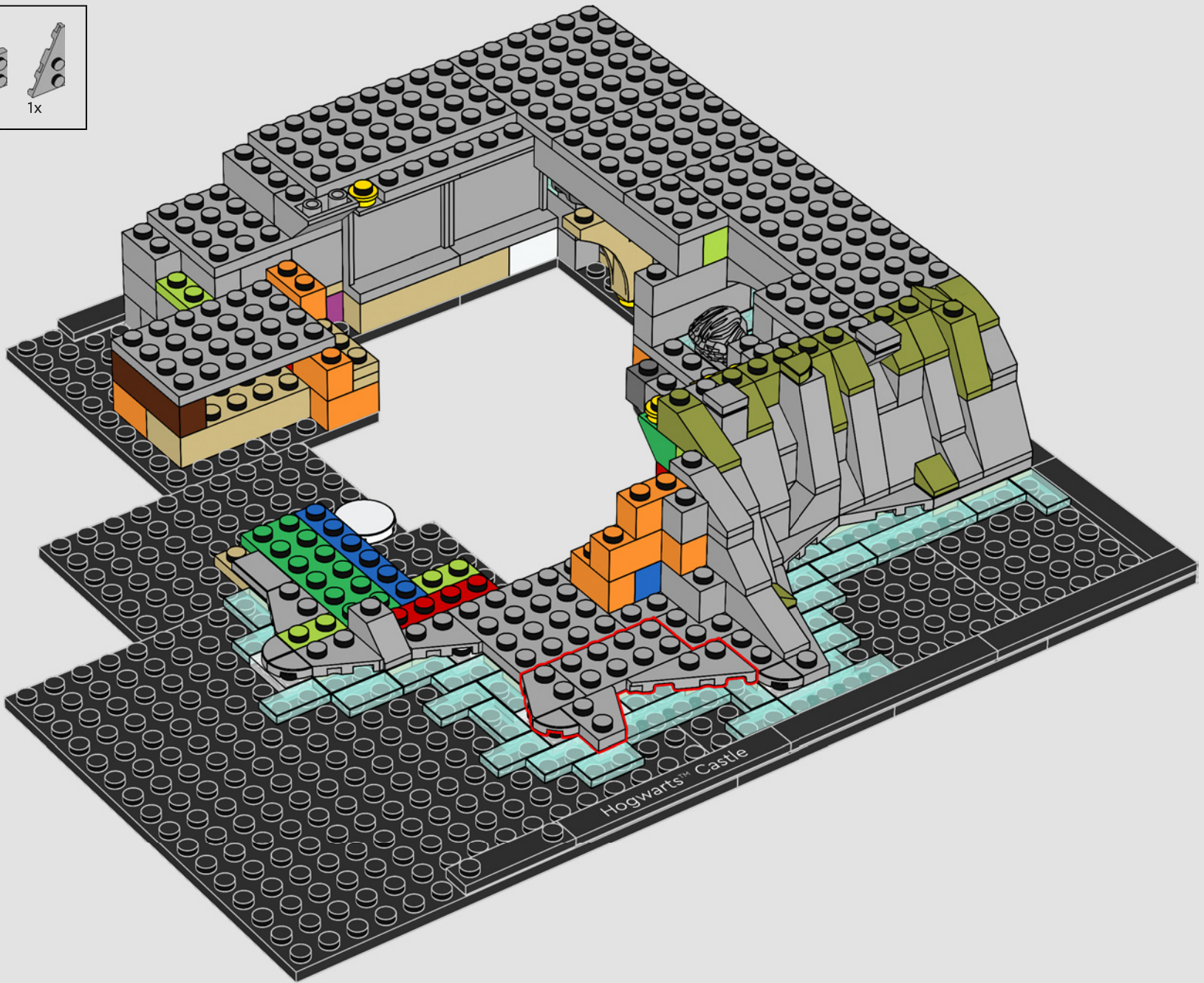



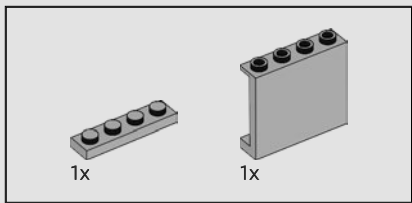

108

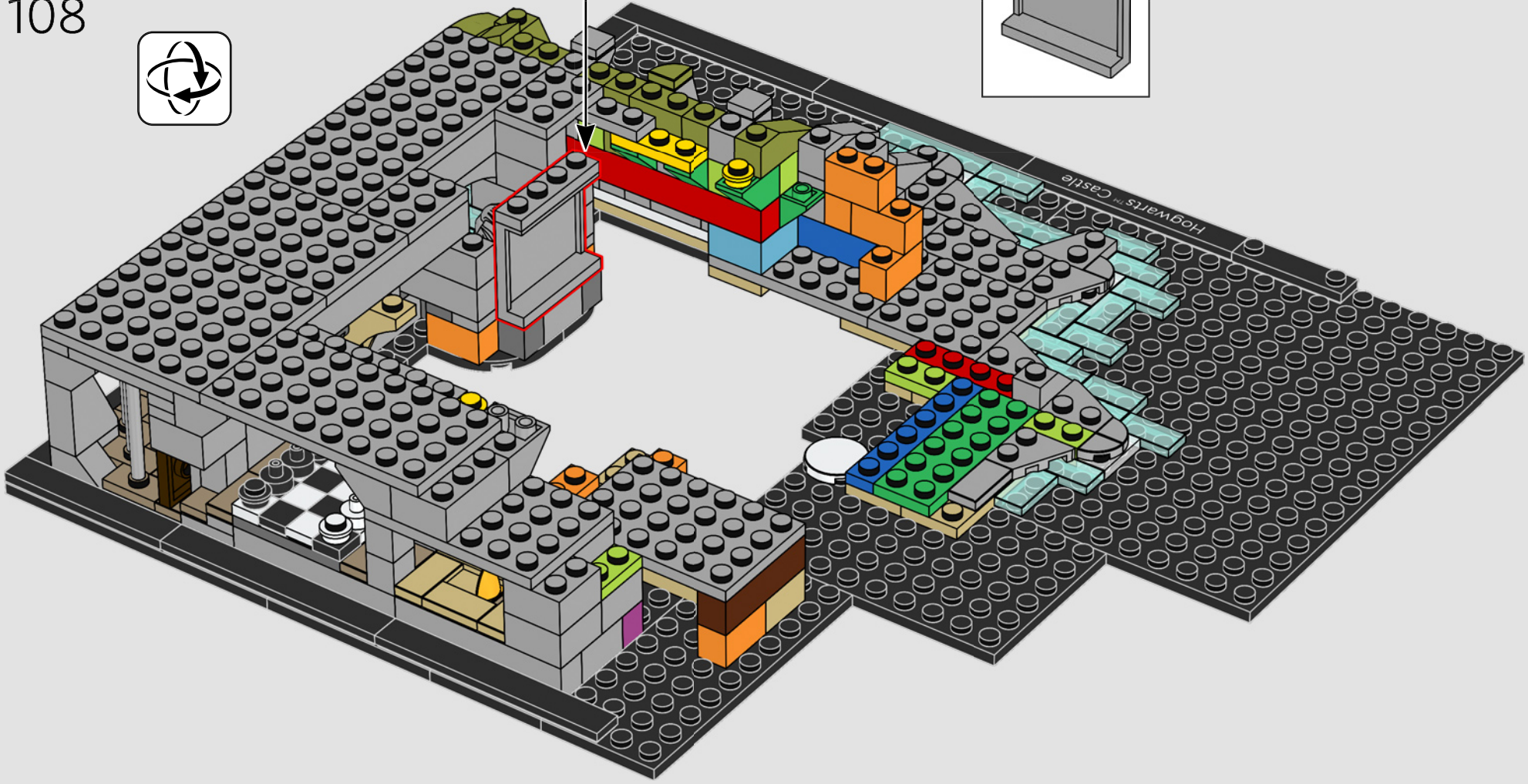
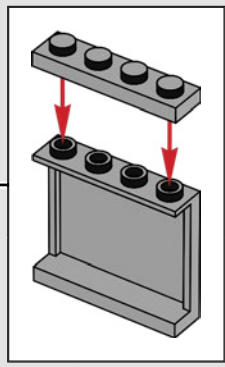
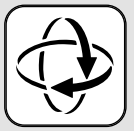



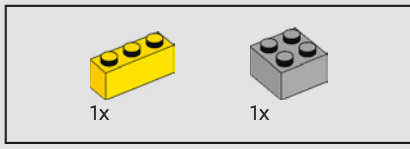

109

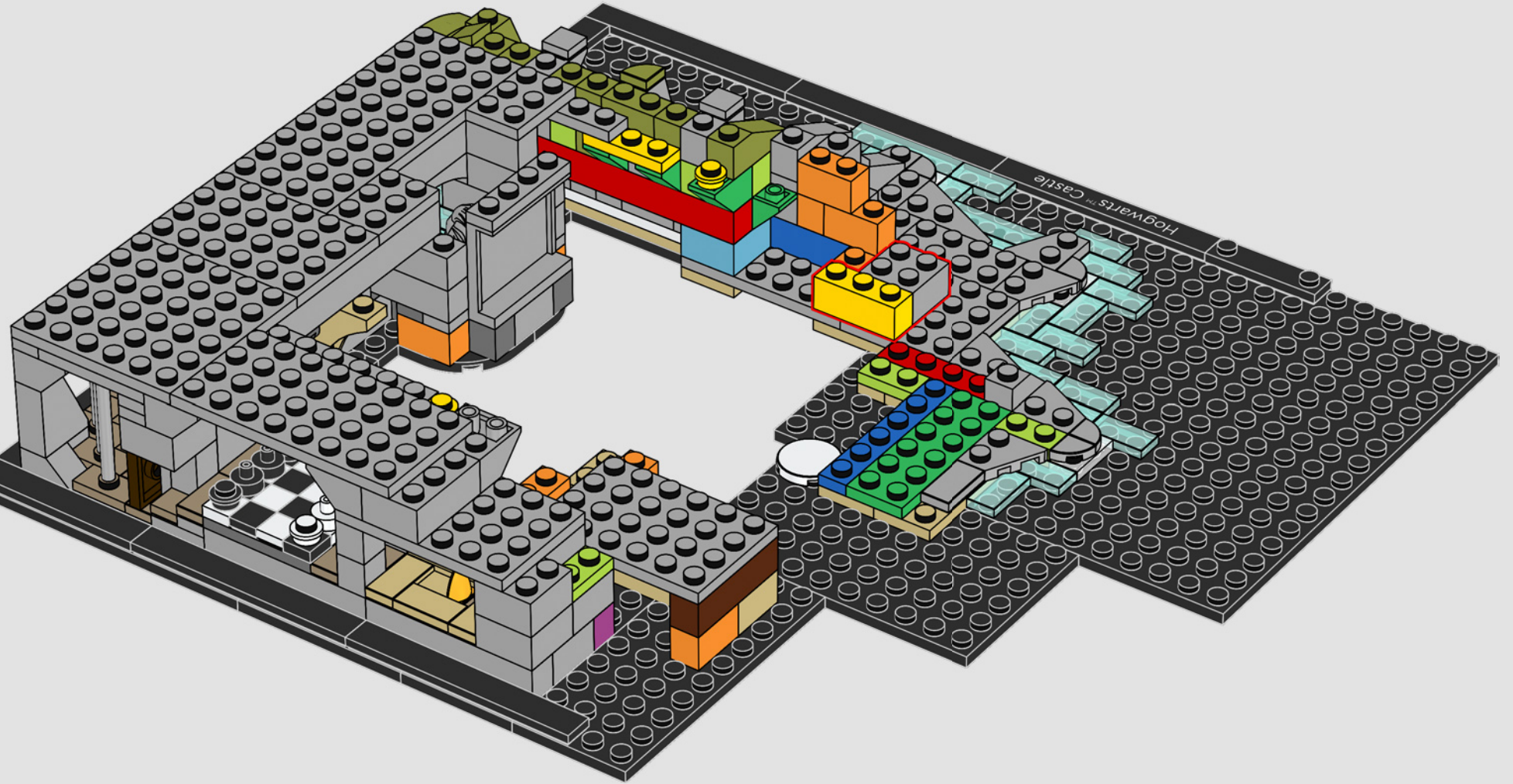

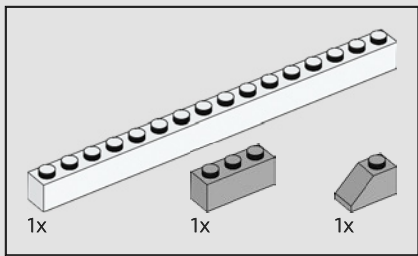

110

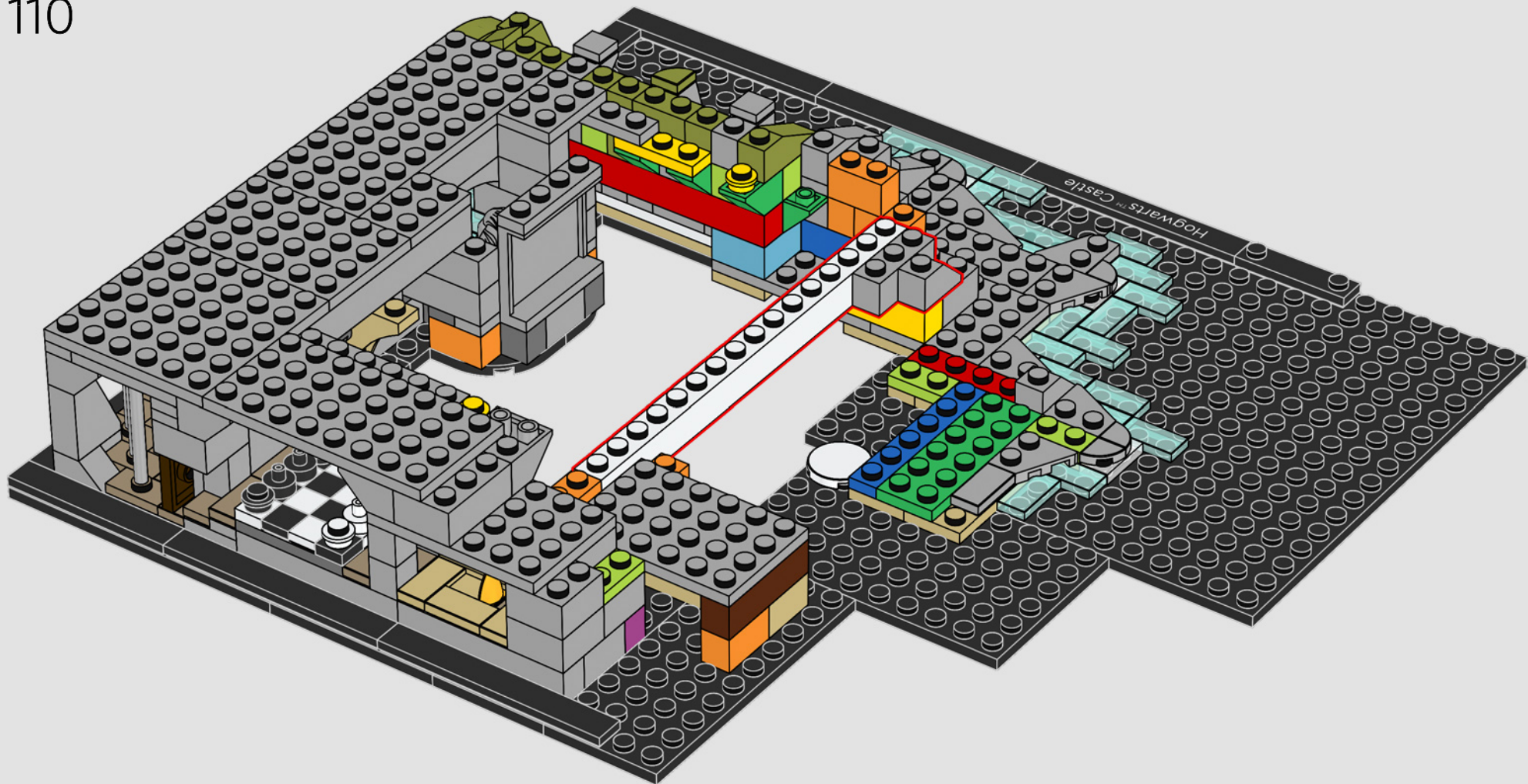



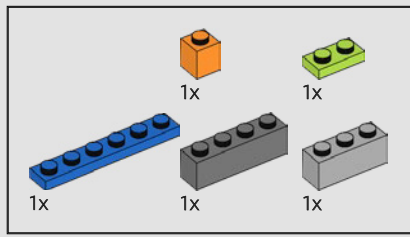

111

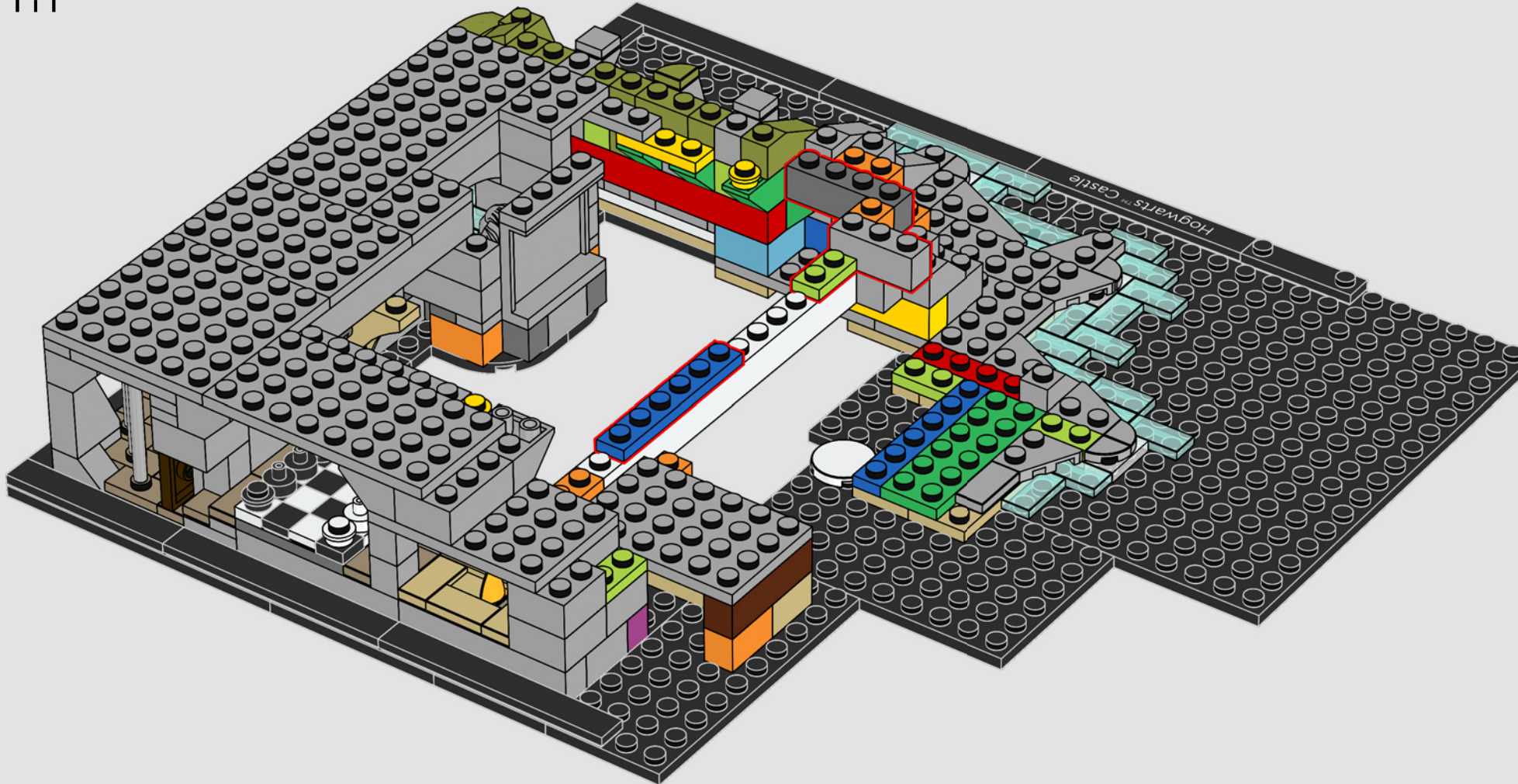





4x

112

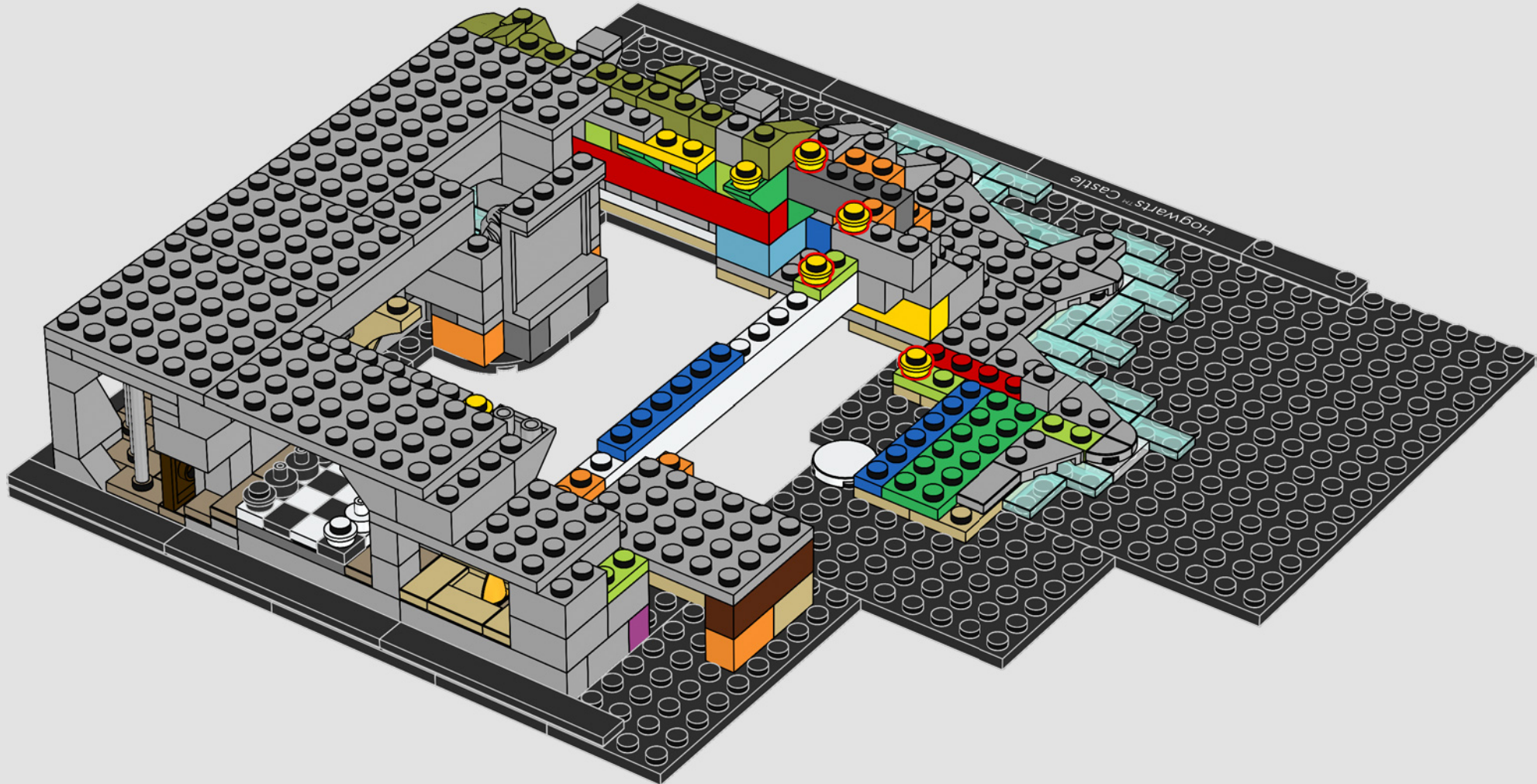

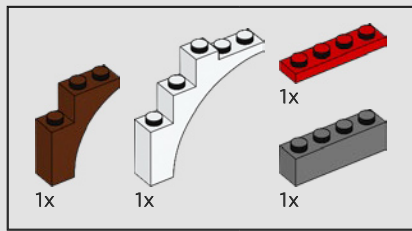

113

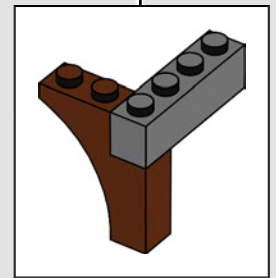
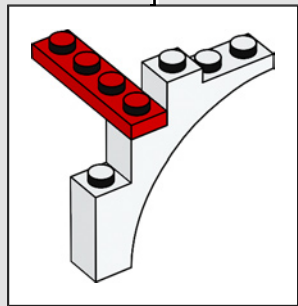
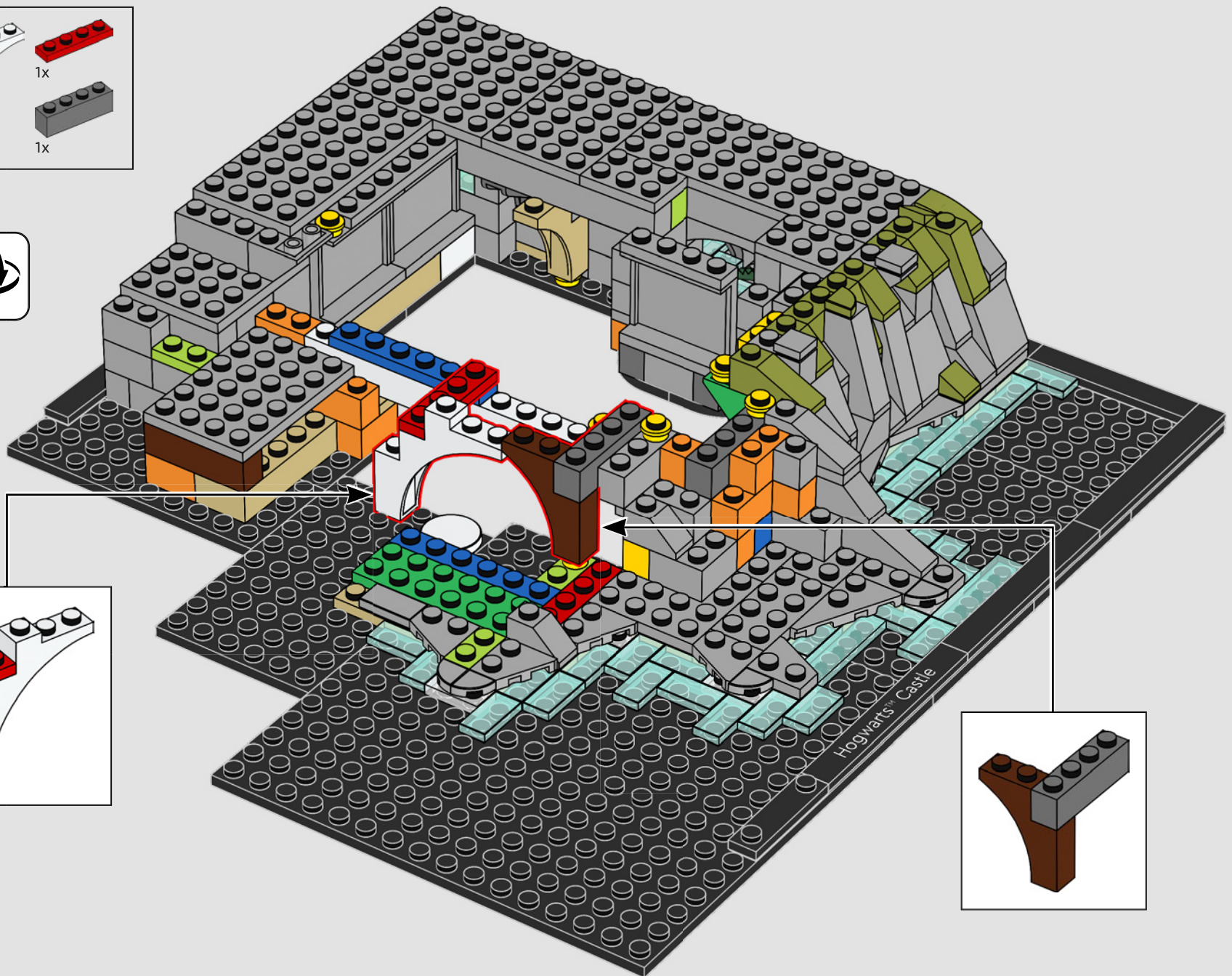



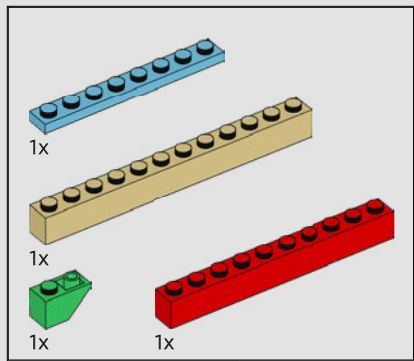

114

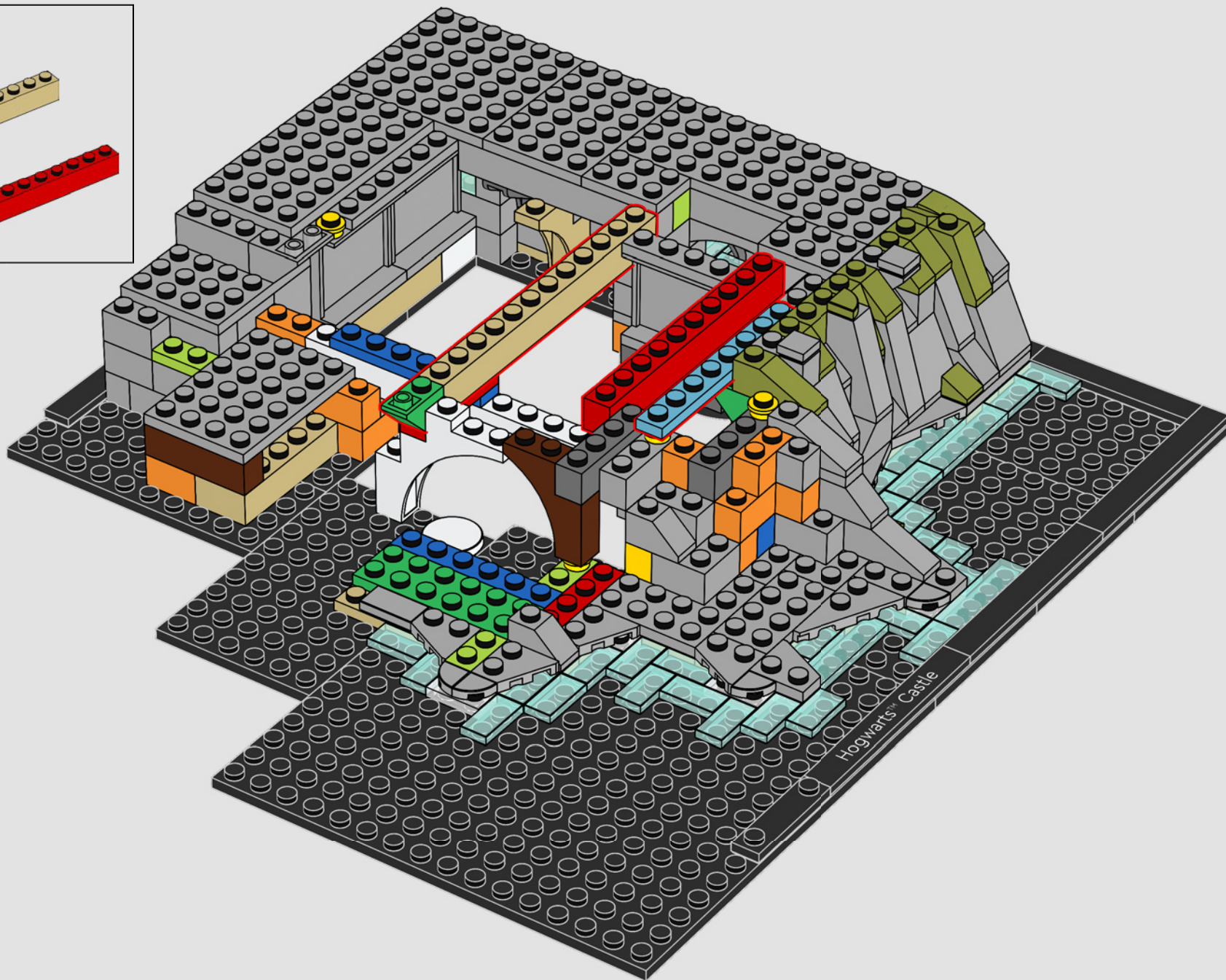



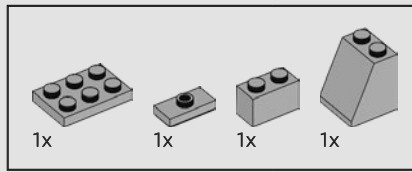

115

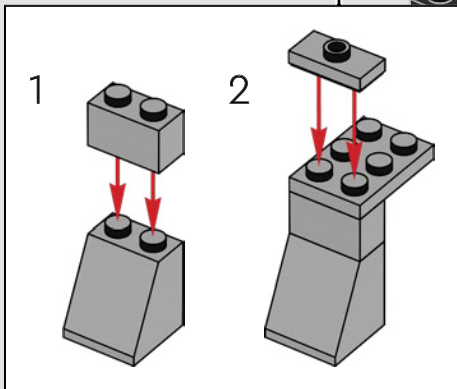
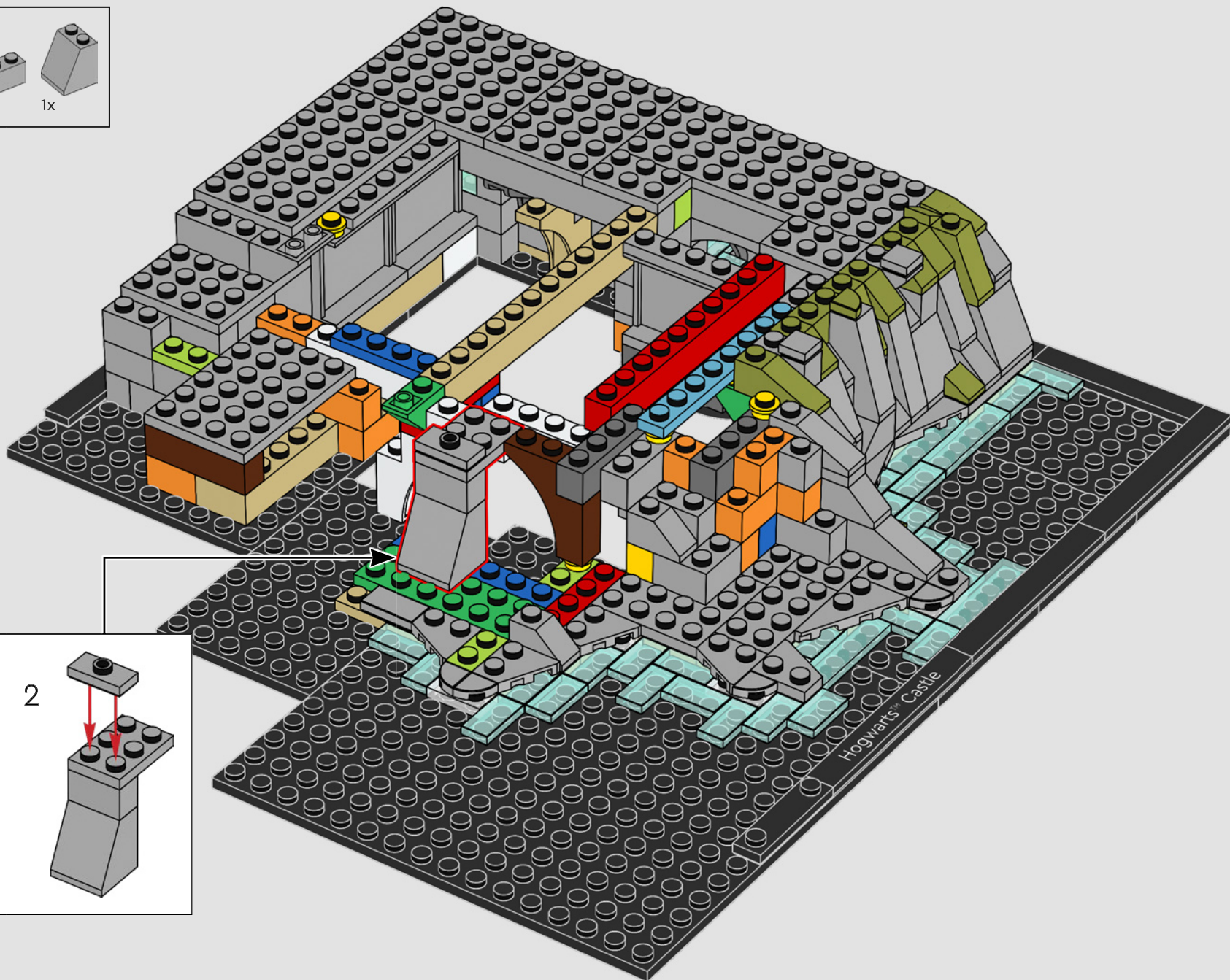

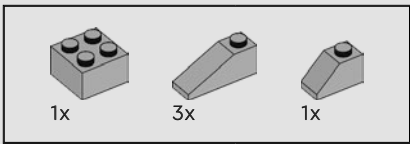

116

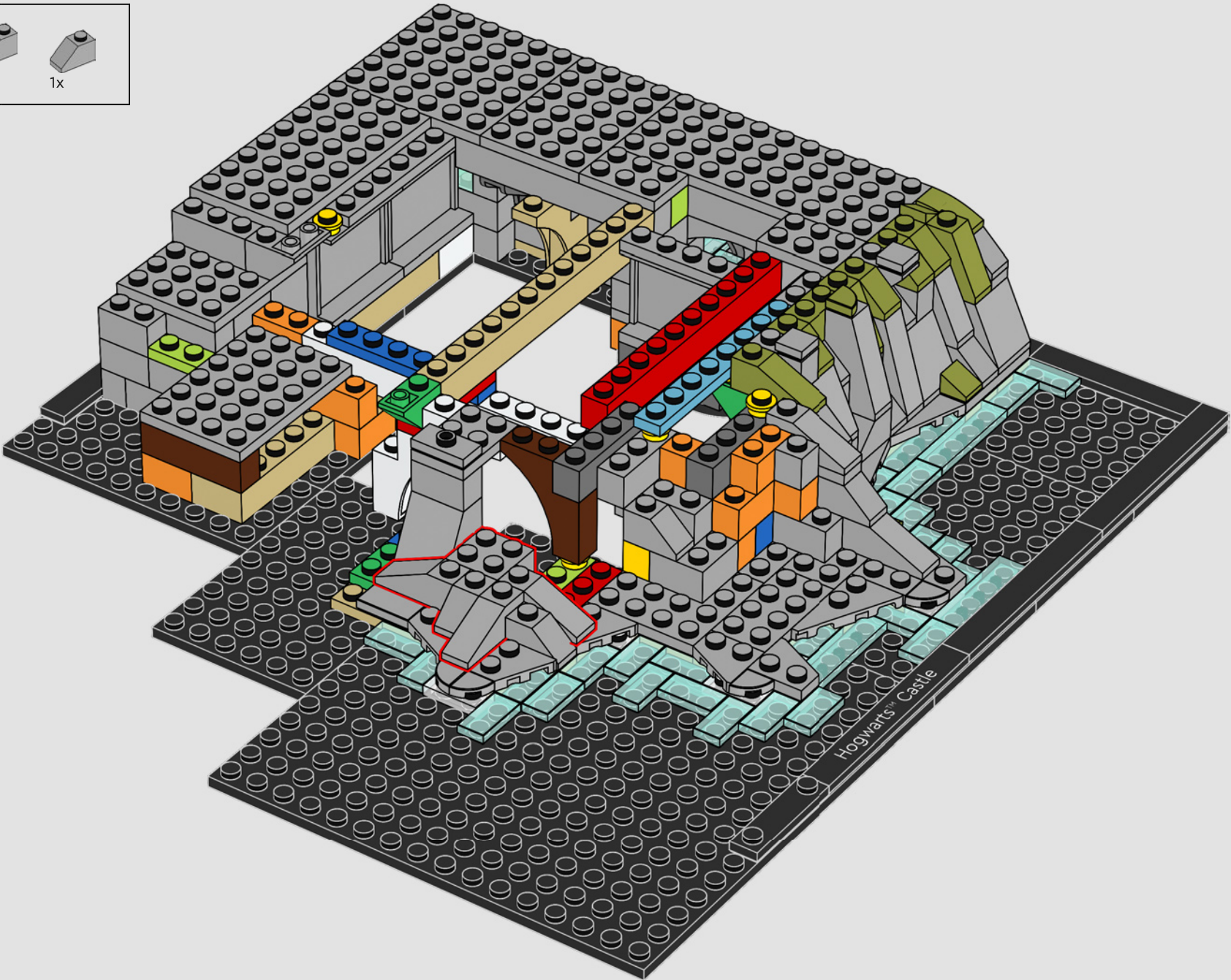



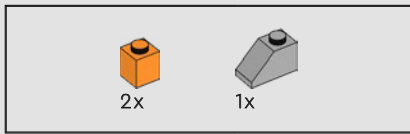

117





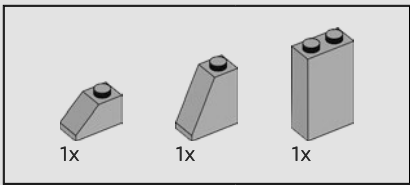

118



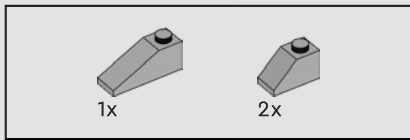

119







3x

120

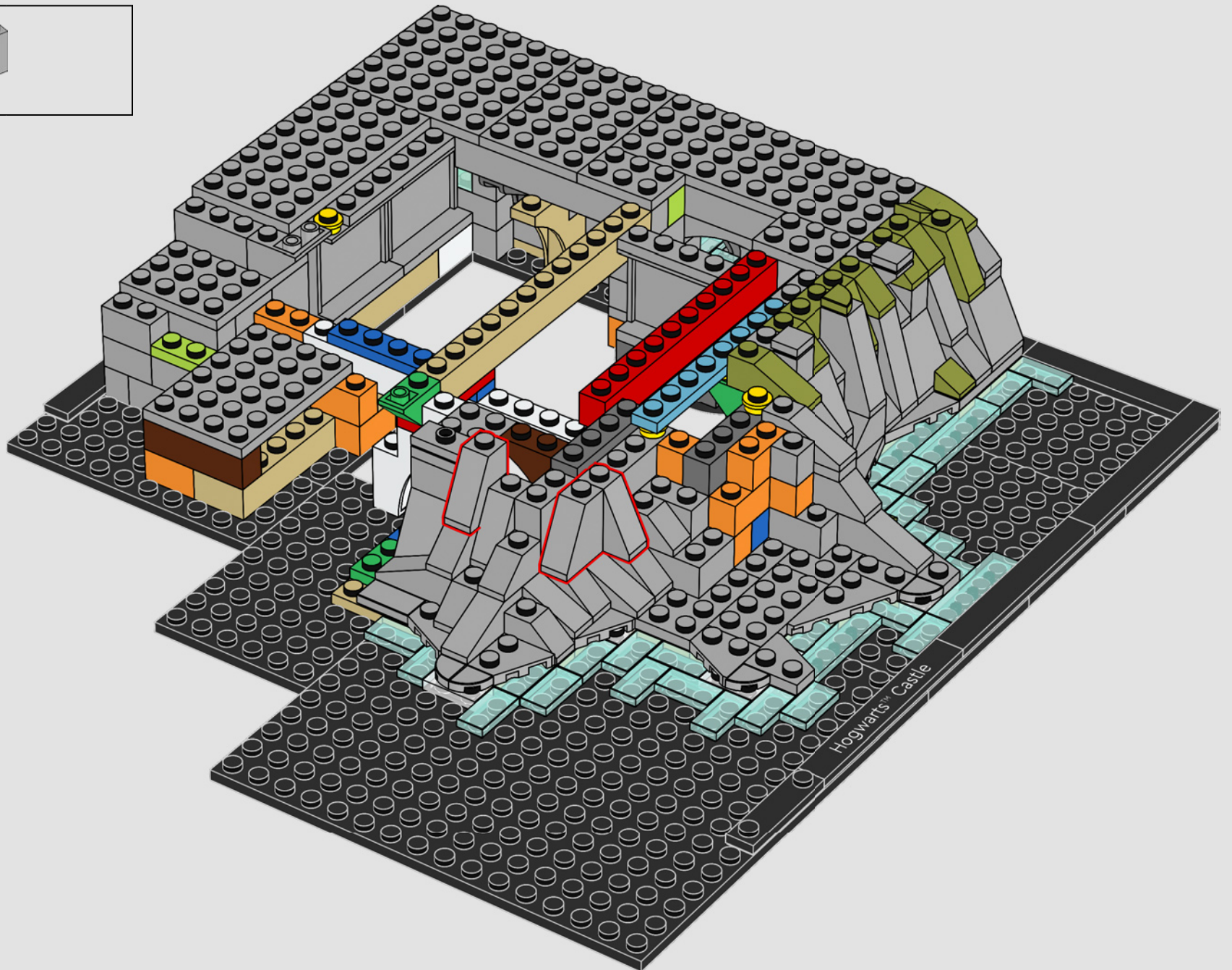





121

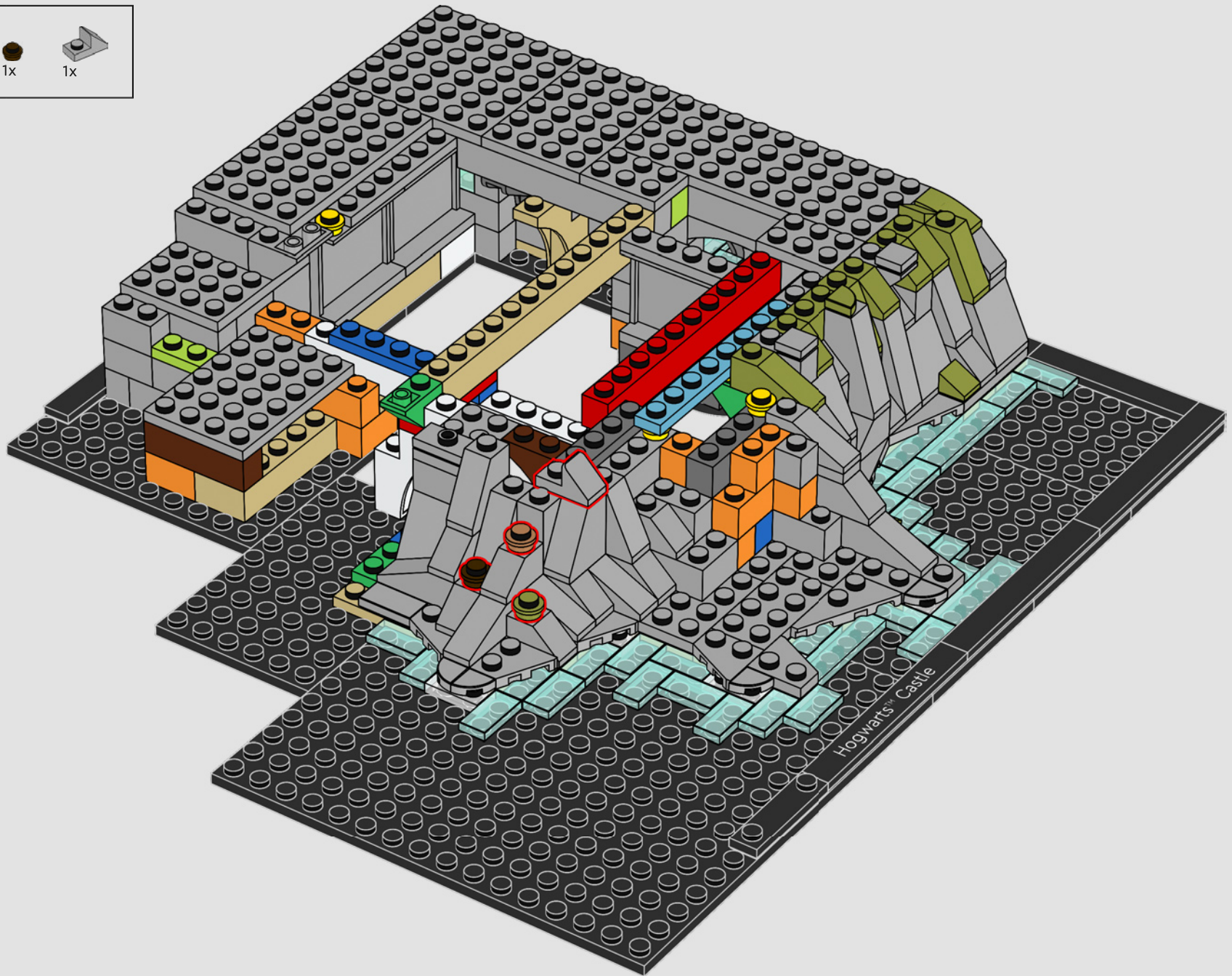

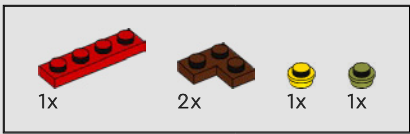

122

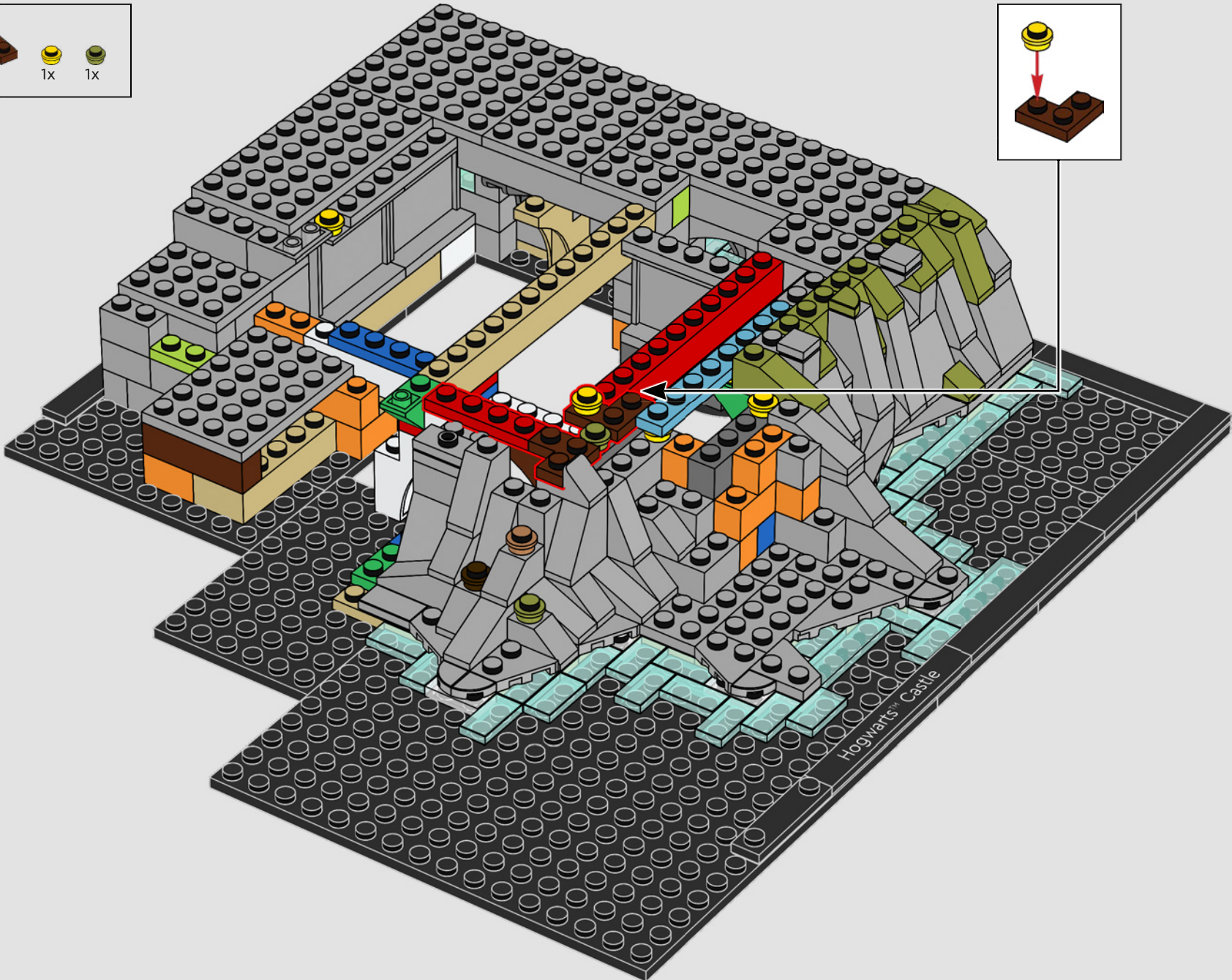



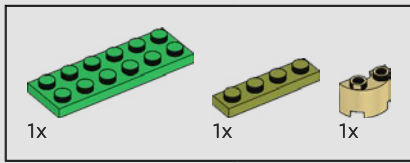

123

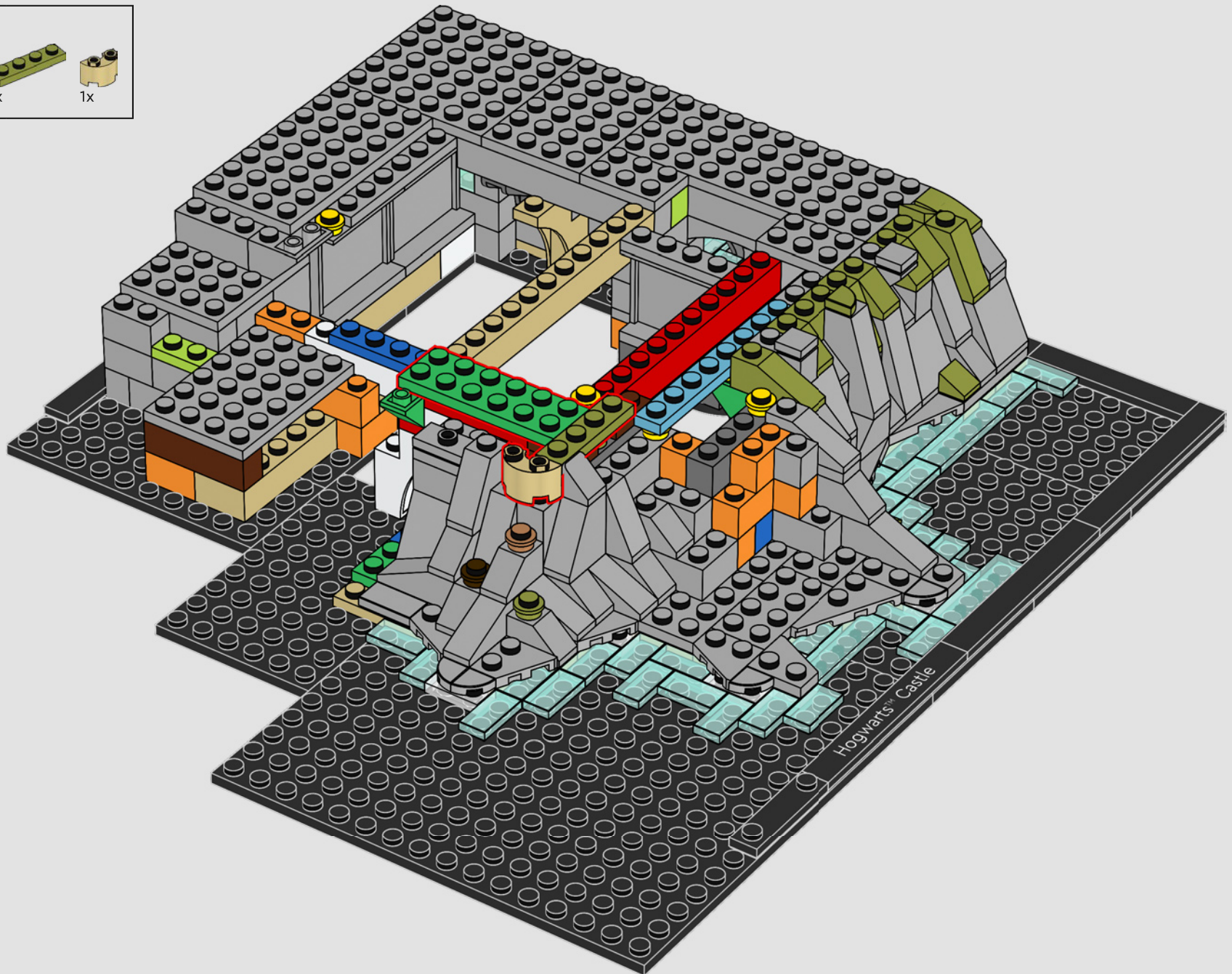



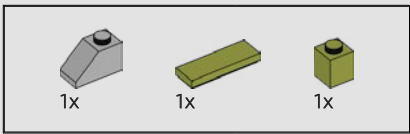

124



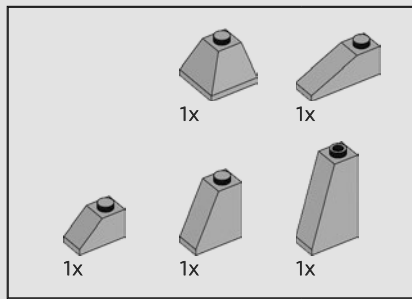

125

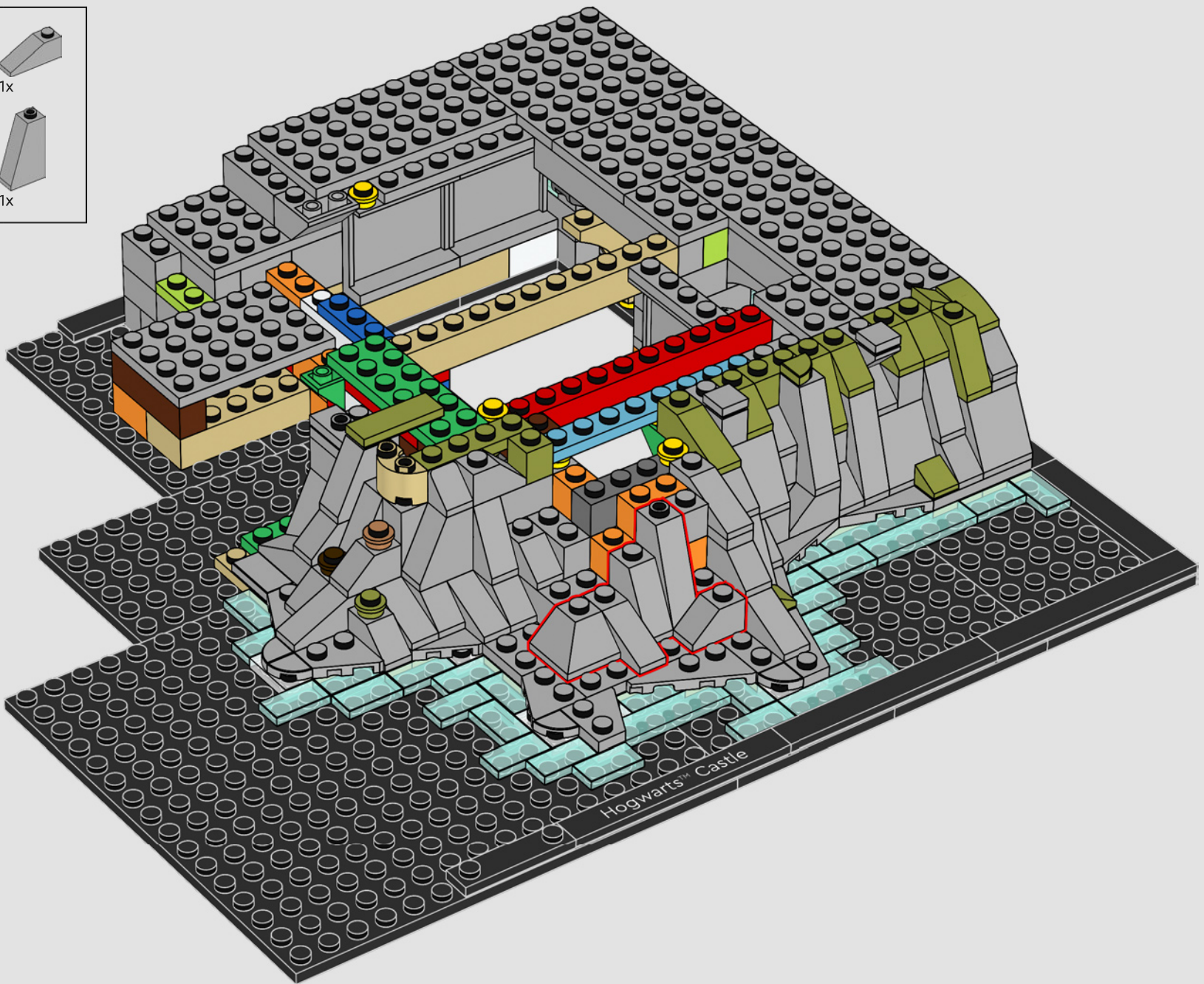



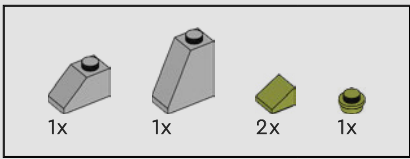

126

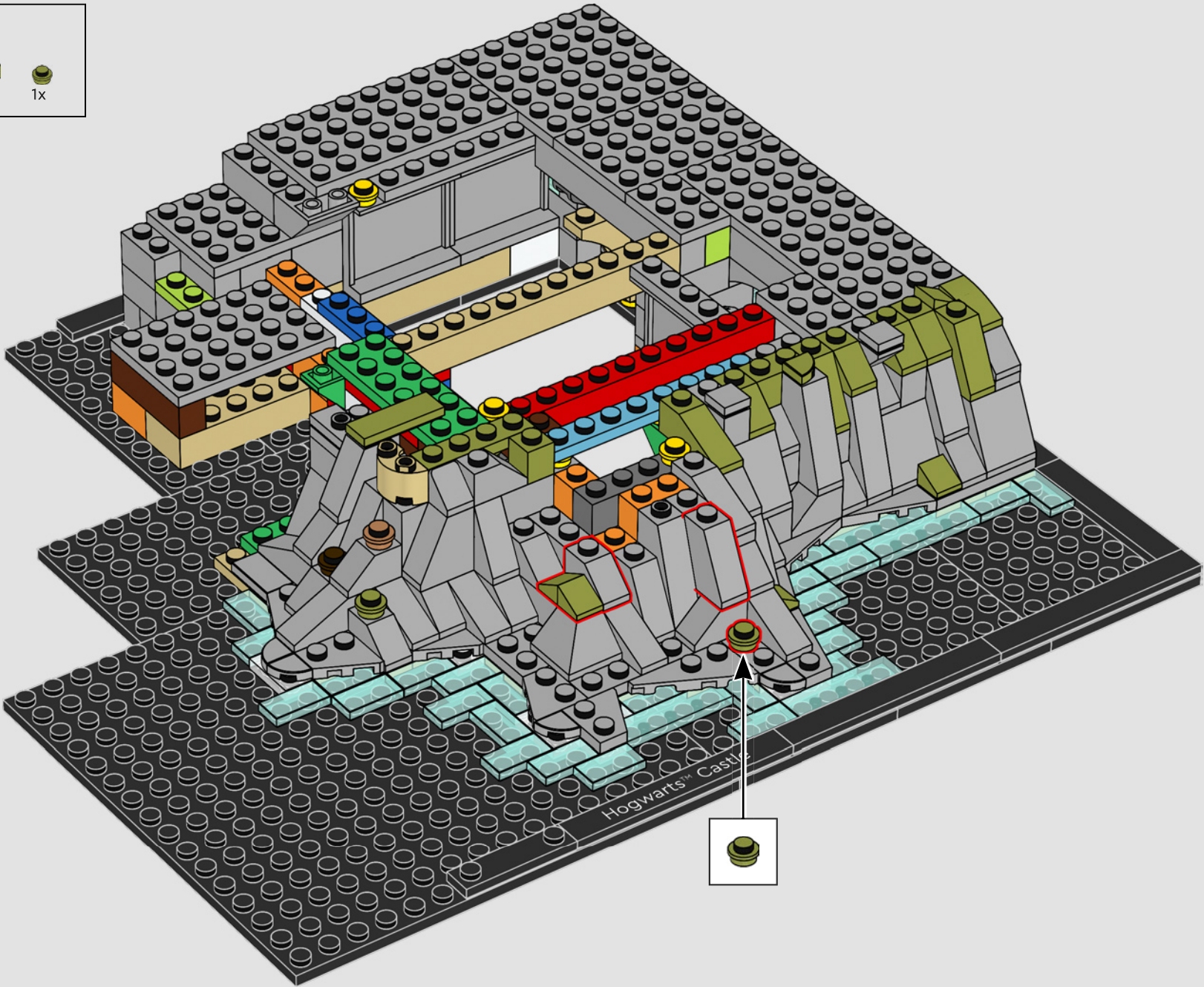





127

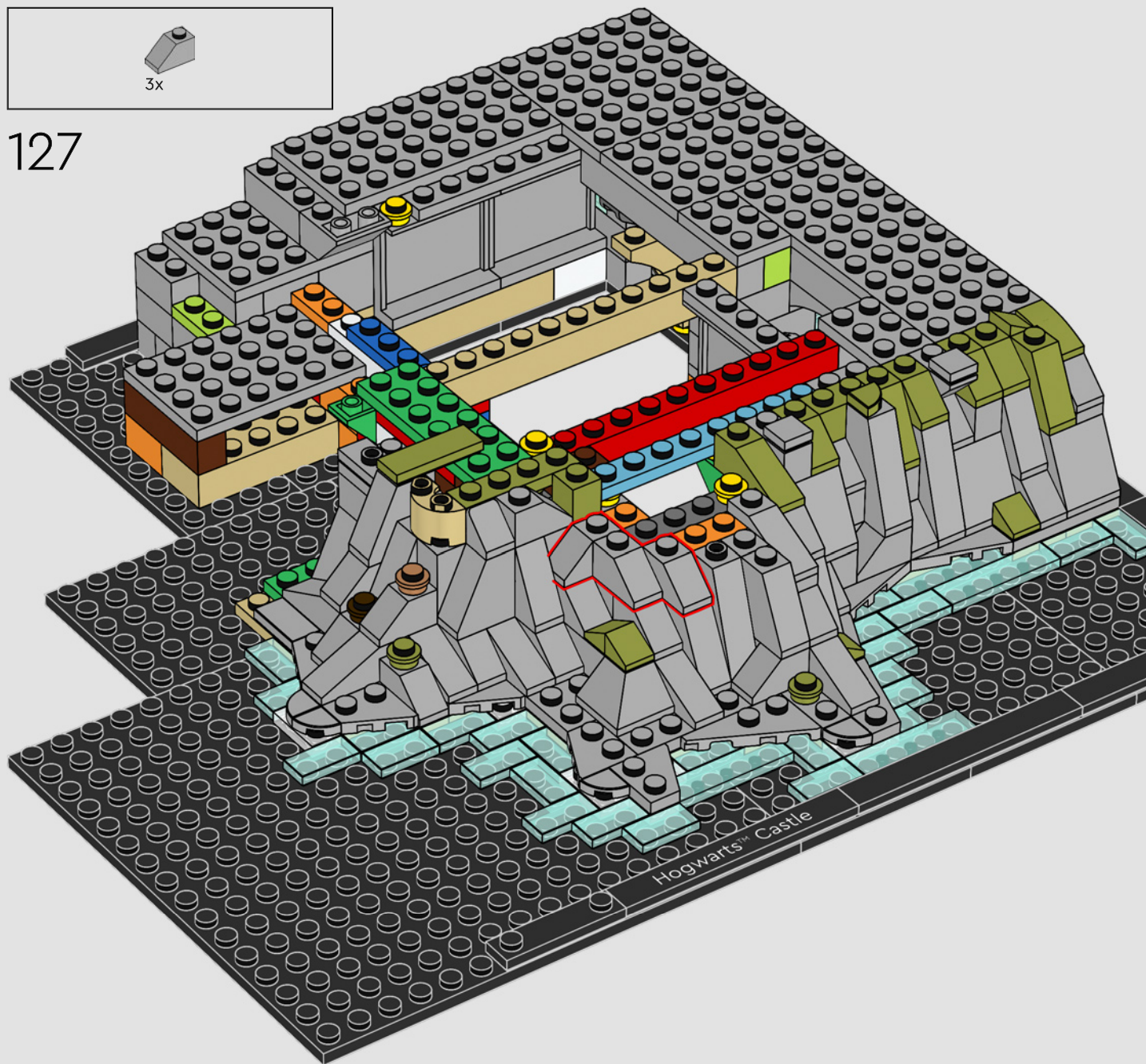

Molti dei segreti del castello sono ancora un mistero per il Mondo dei maghi. Nemmeno Albus Silente ha mai saputo tutto sulla sua costruzione o progettazione.



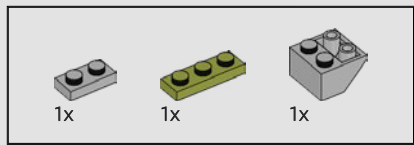

128

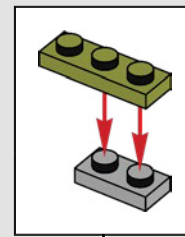
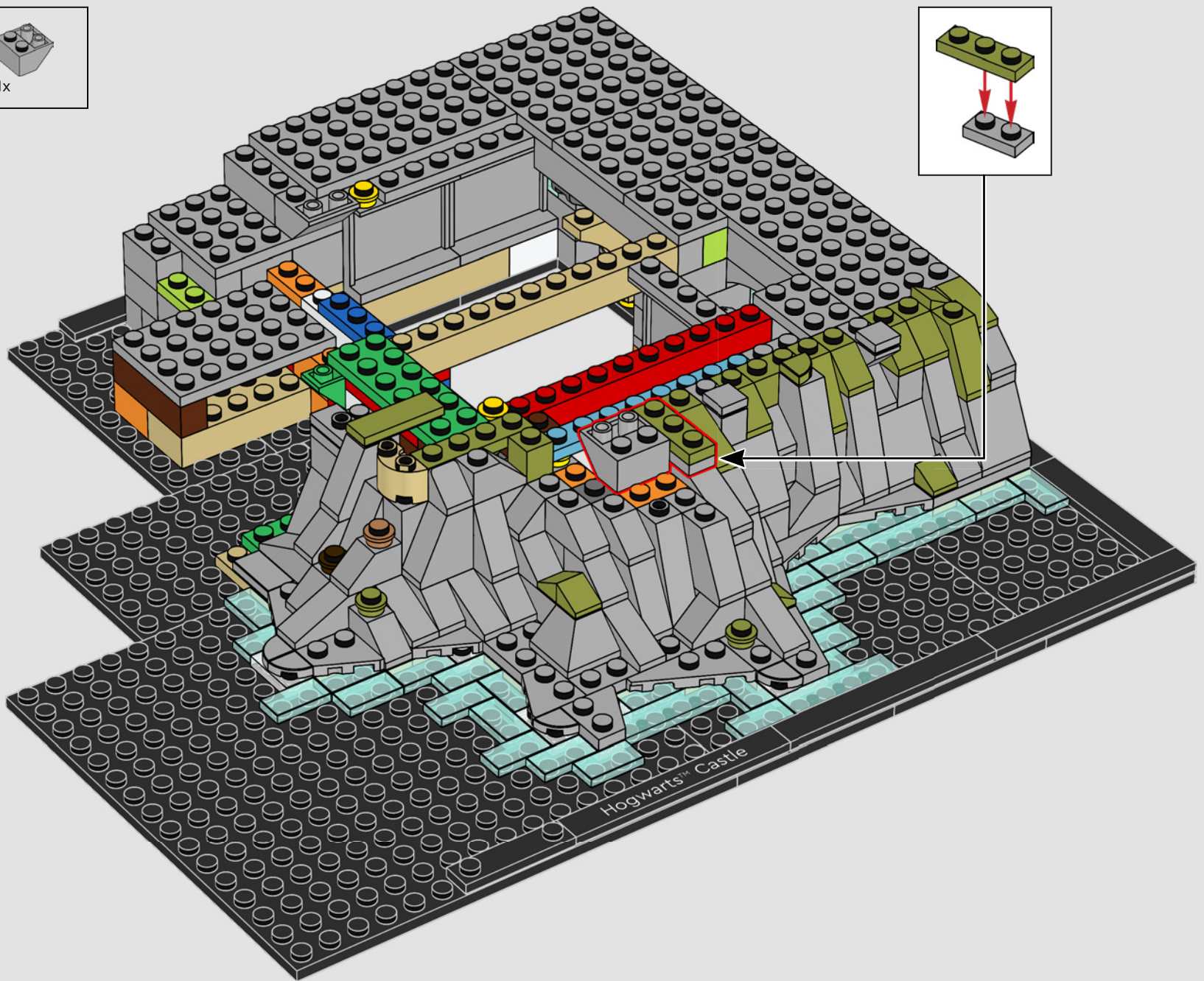



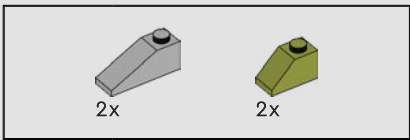

129

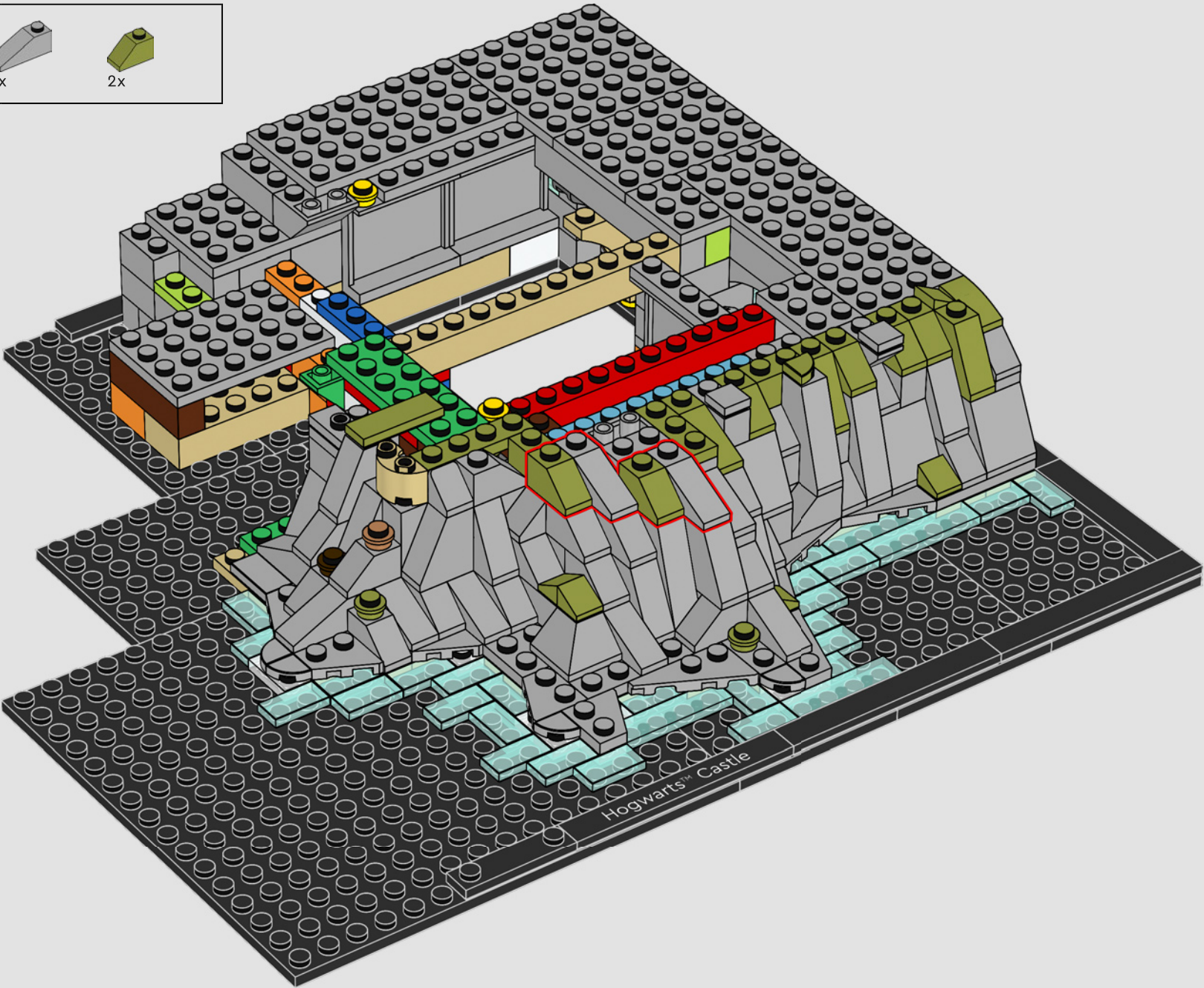





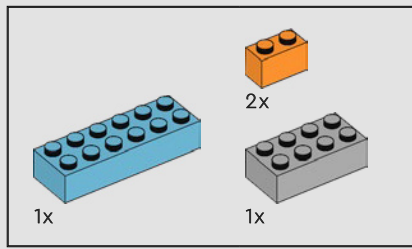

130

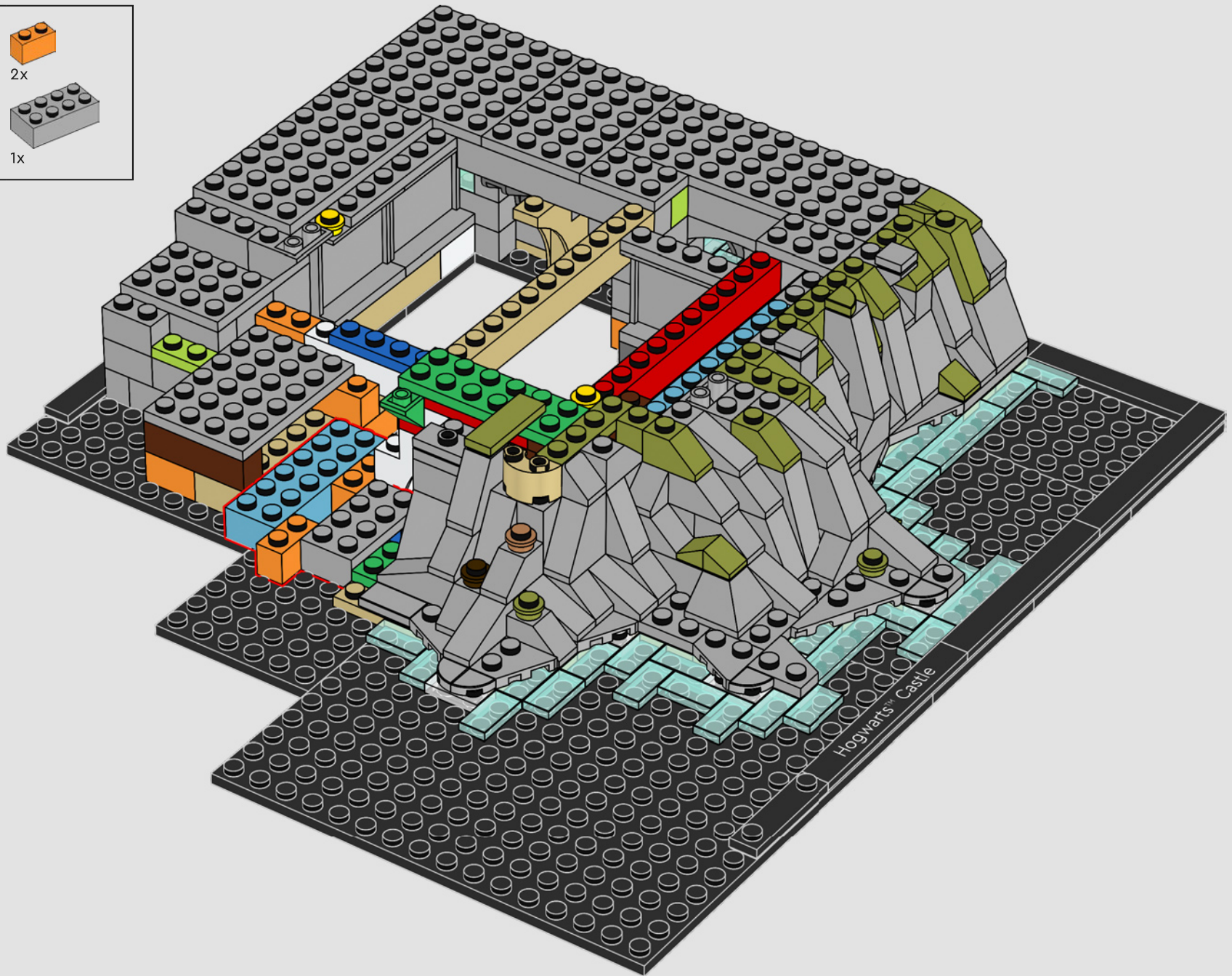



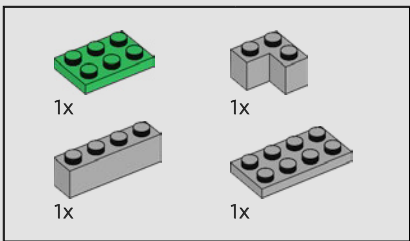

131

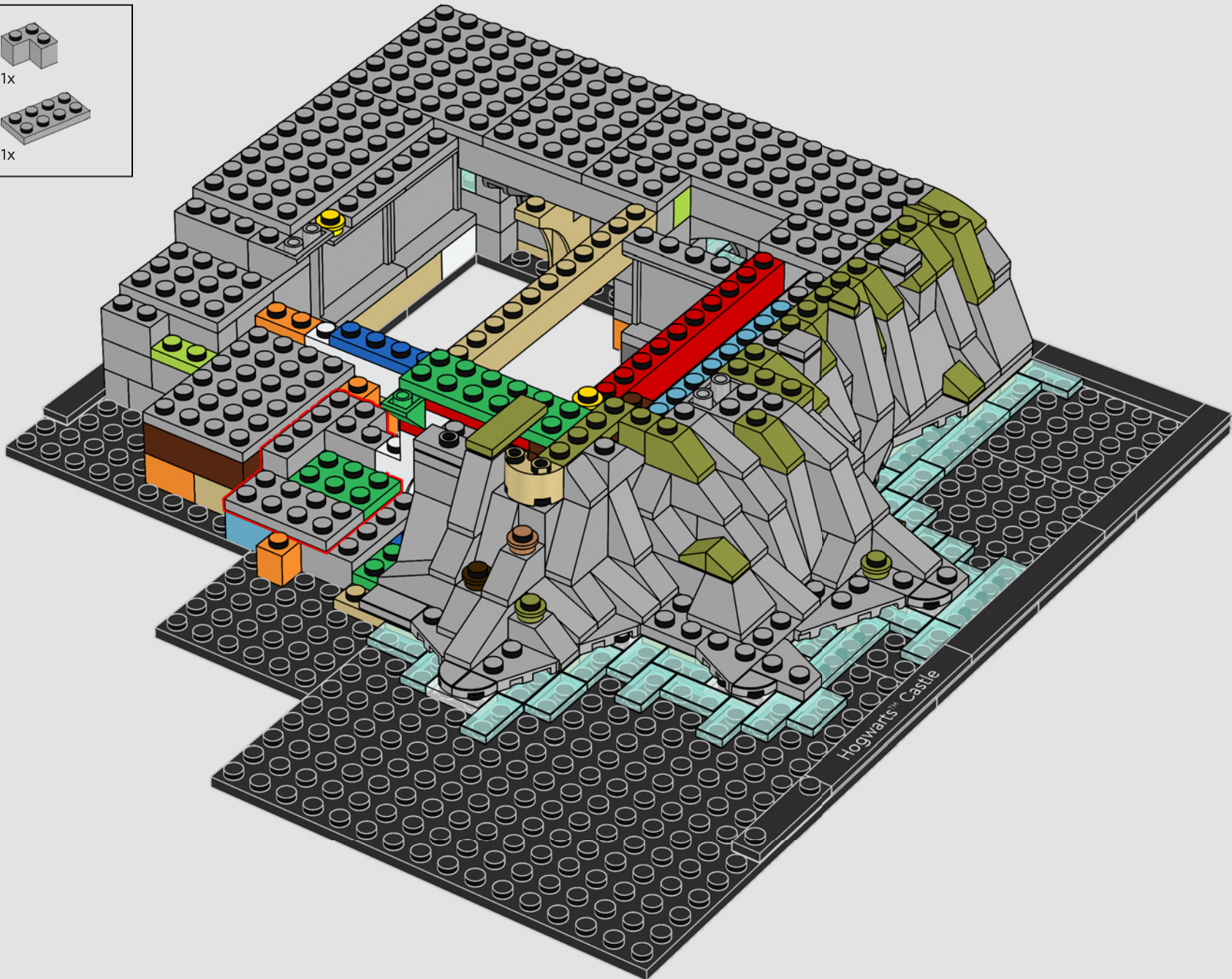



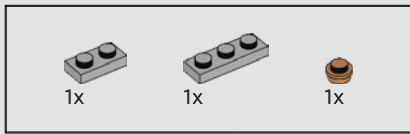

132

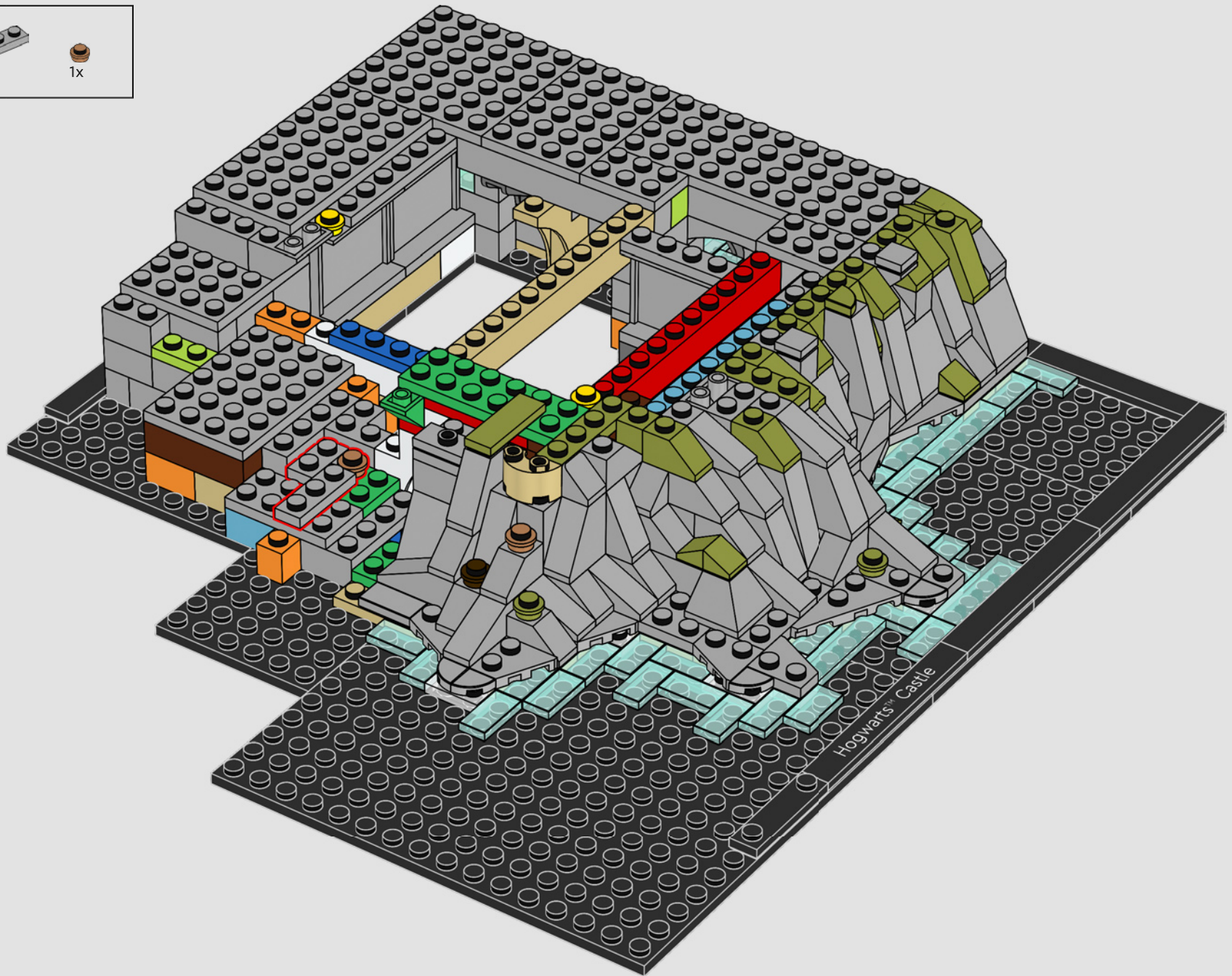

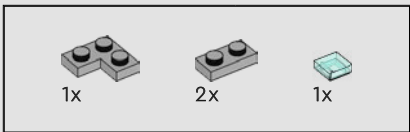

133

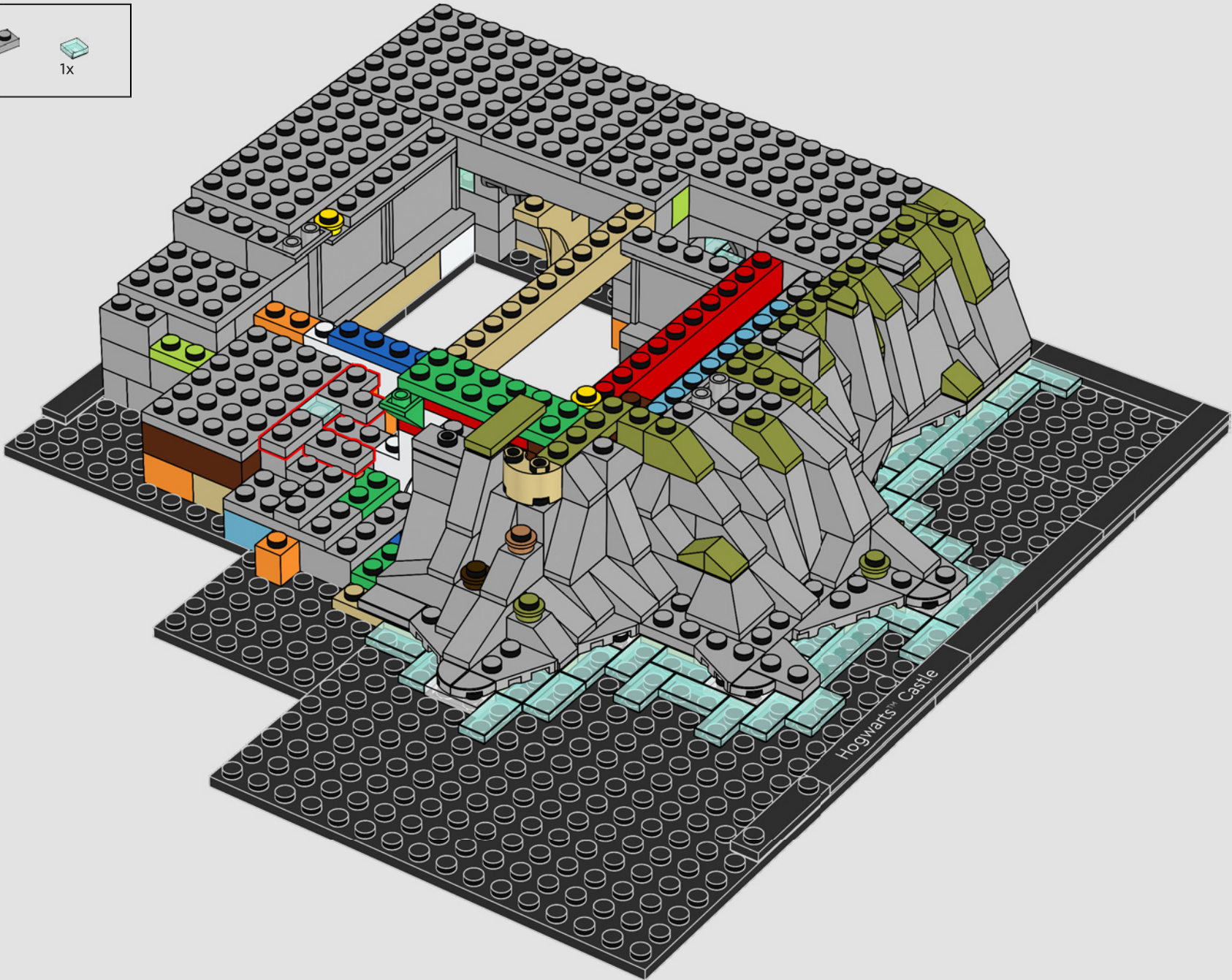



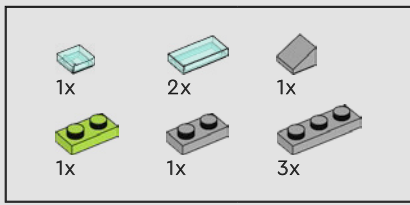

134

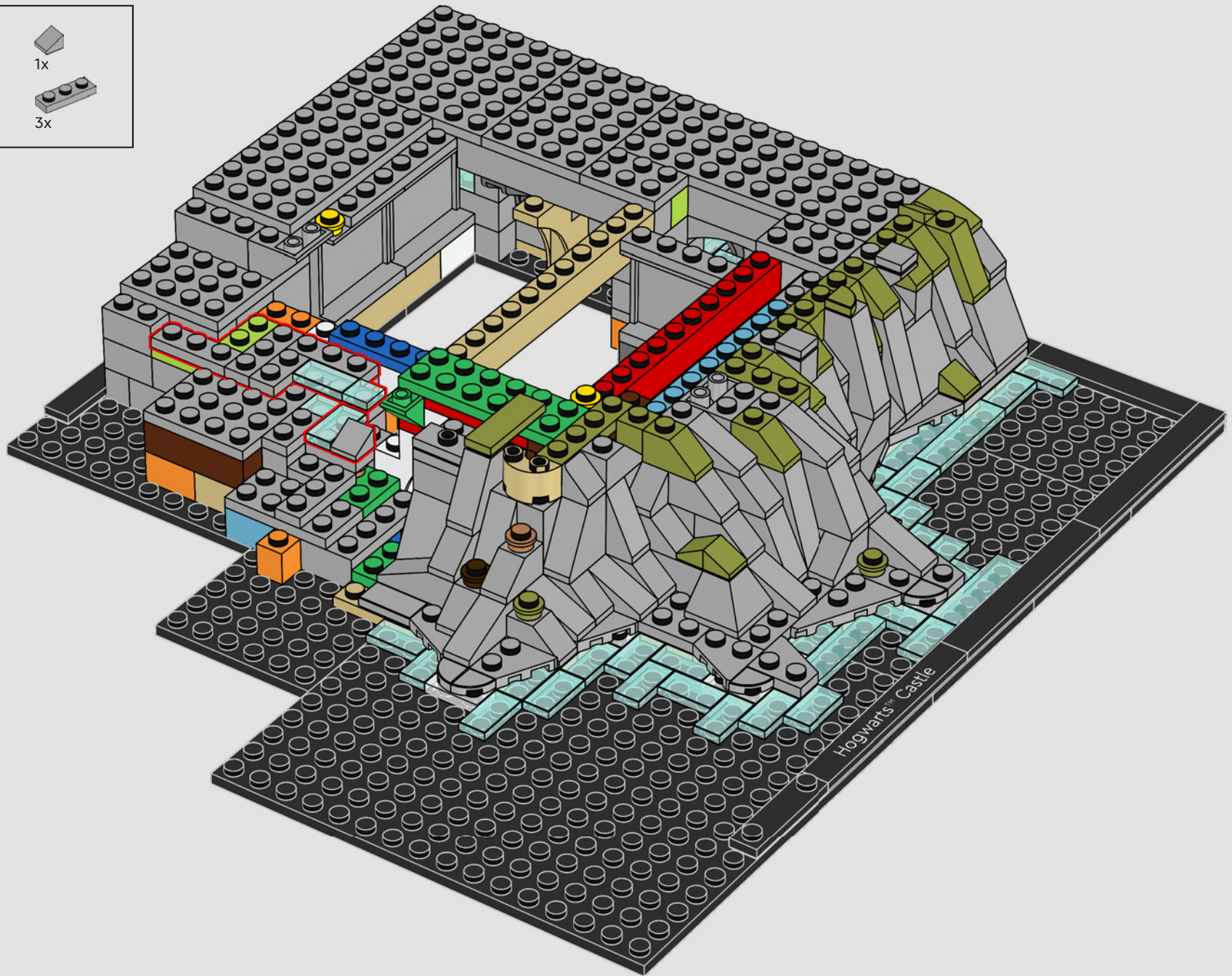



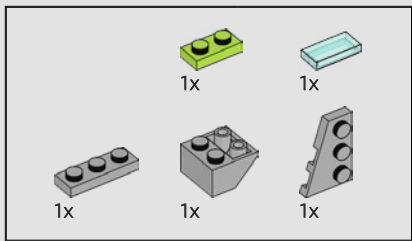

135

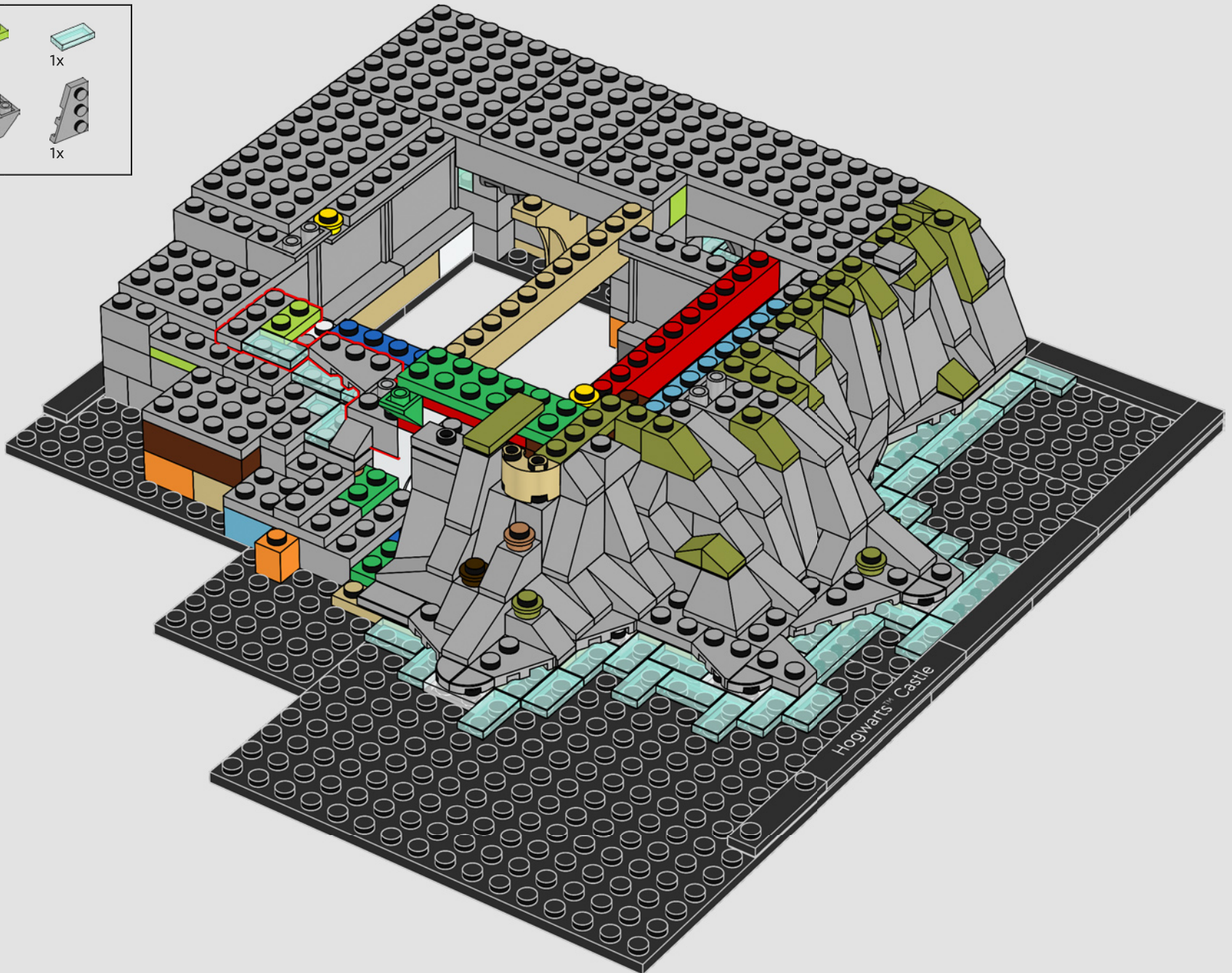

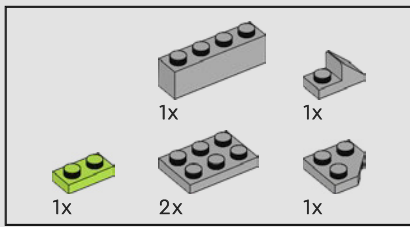

136

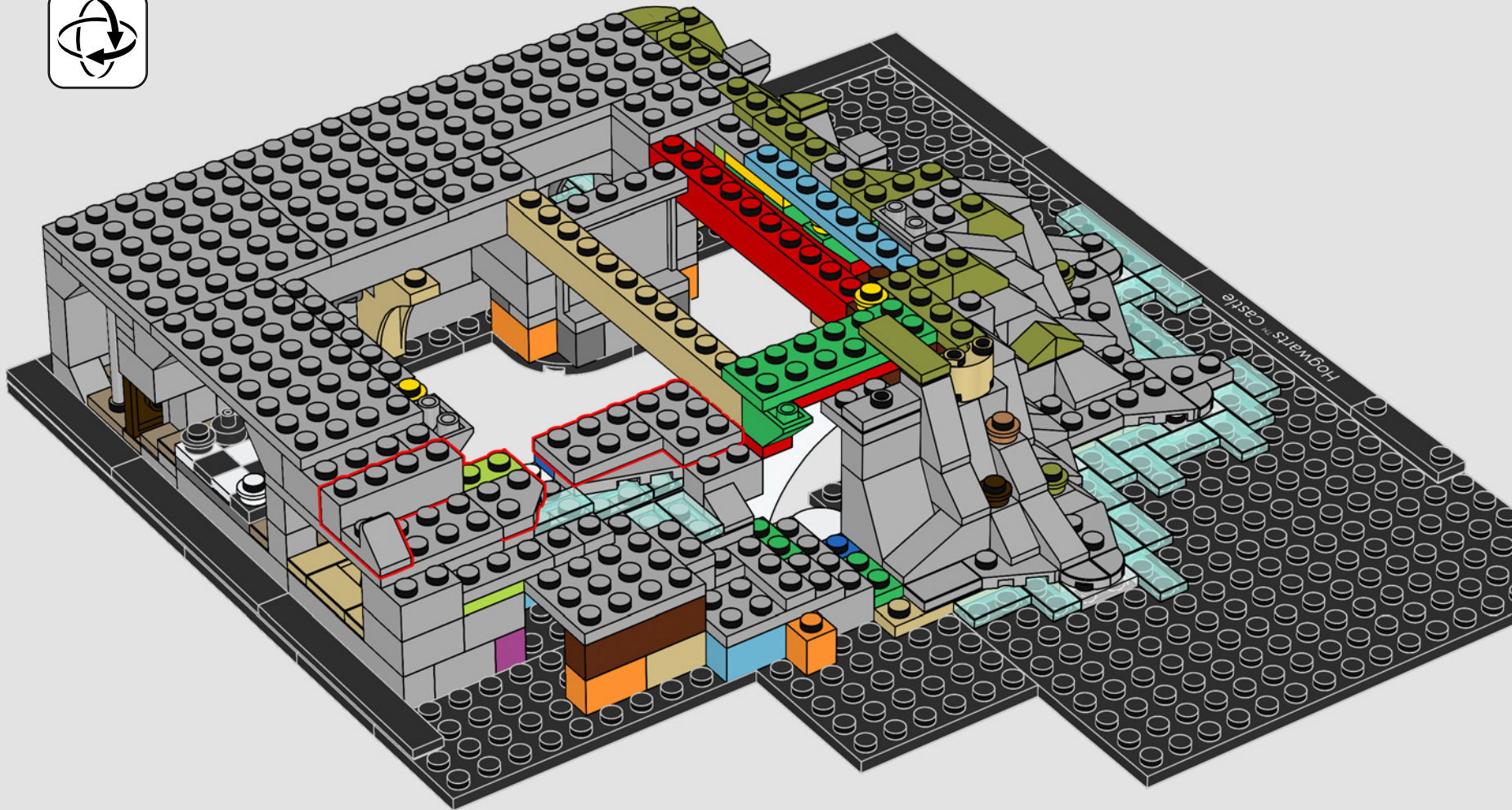



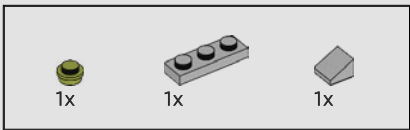

137

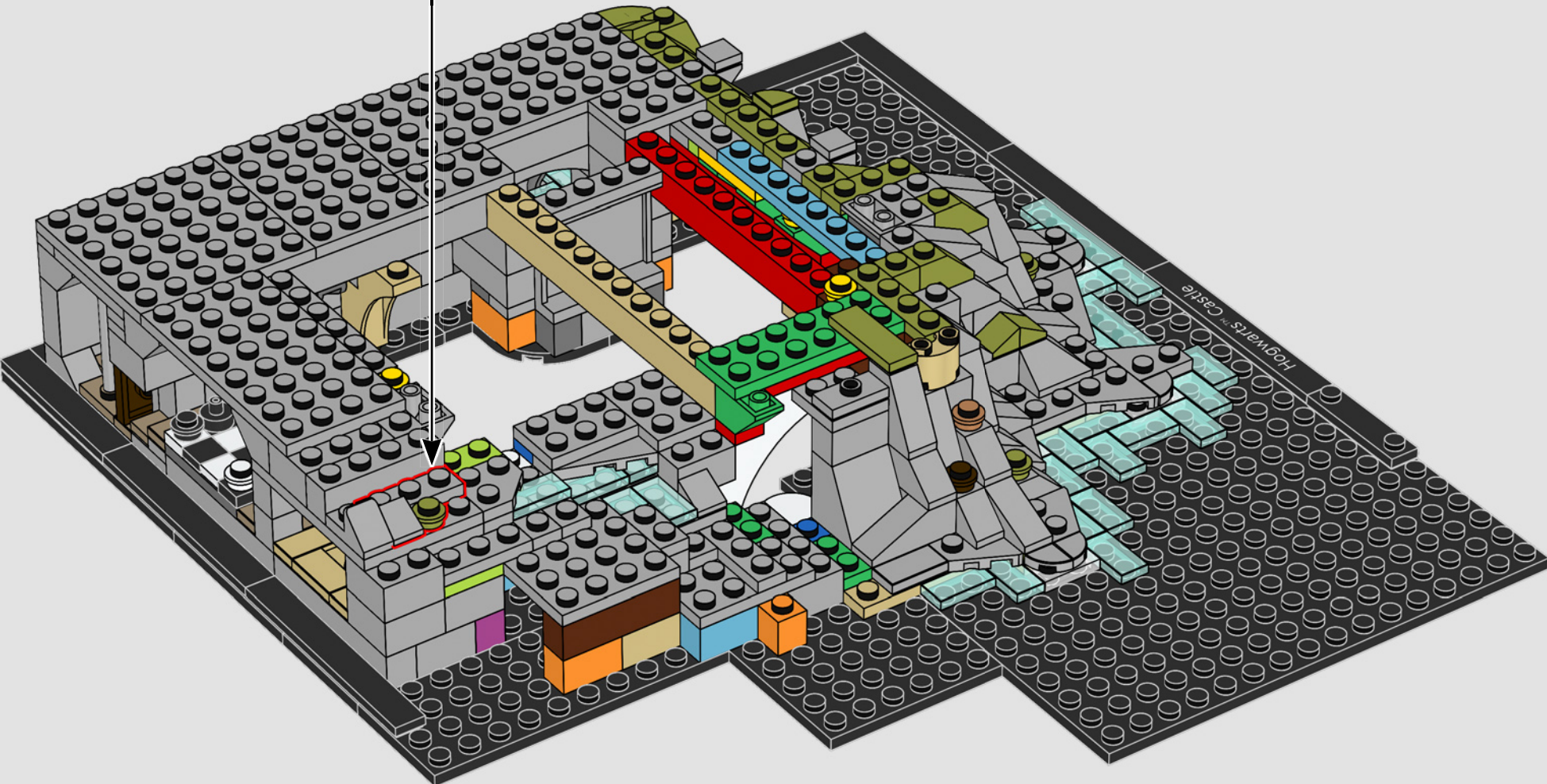
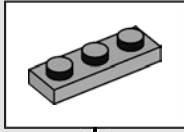



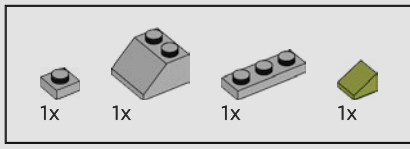

138

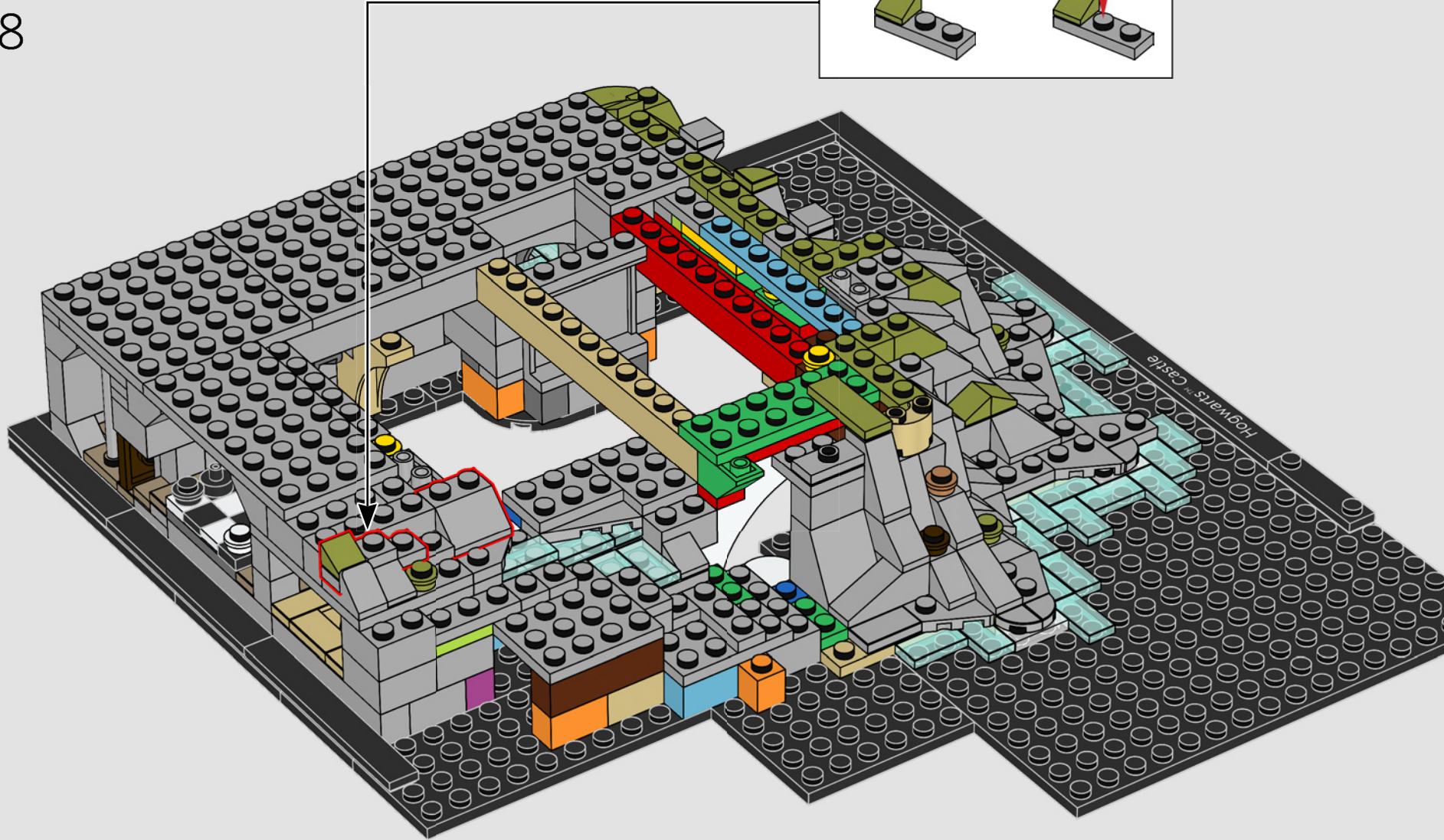
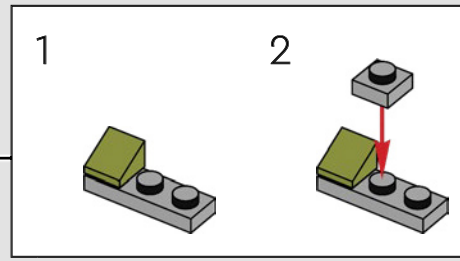

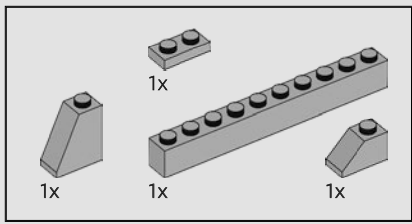

139

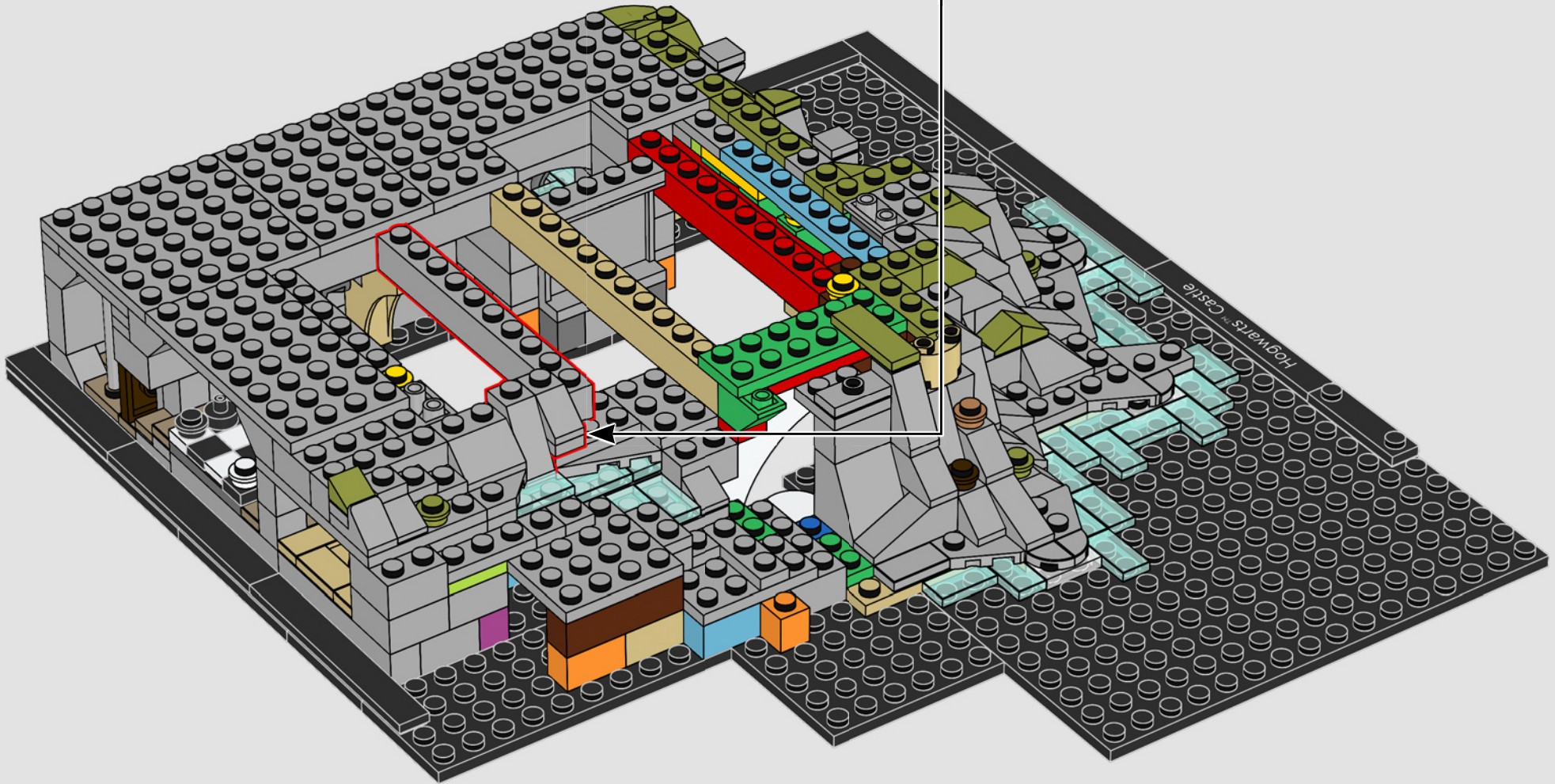
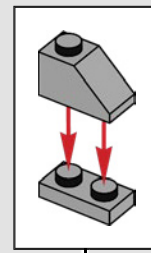



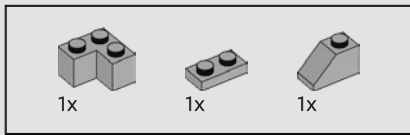

140

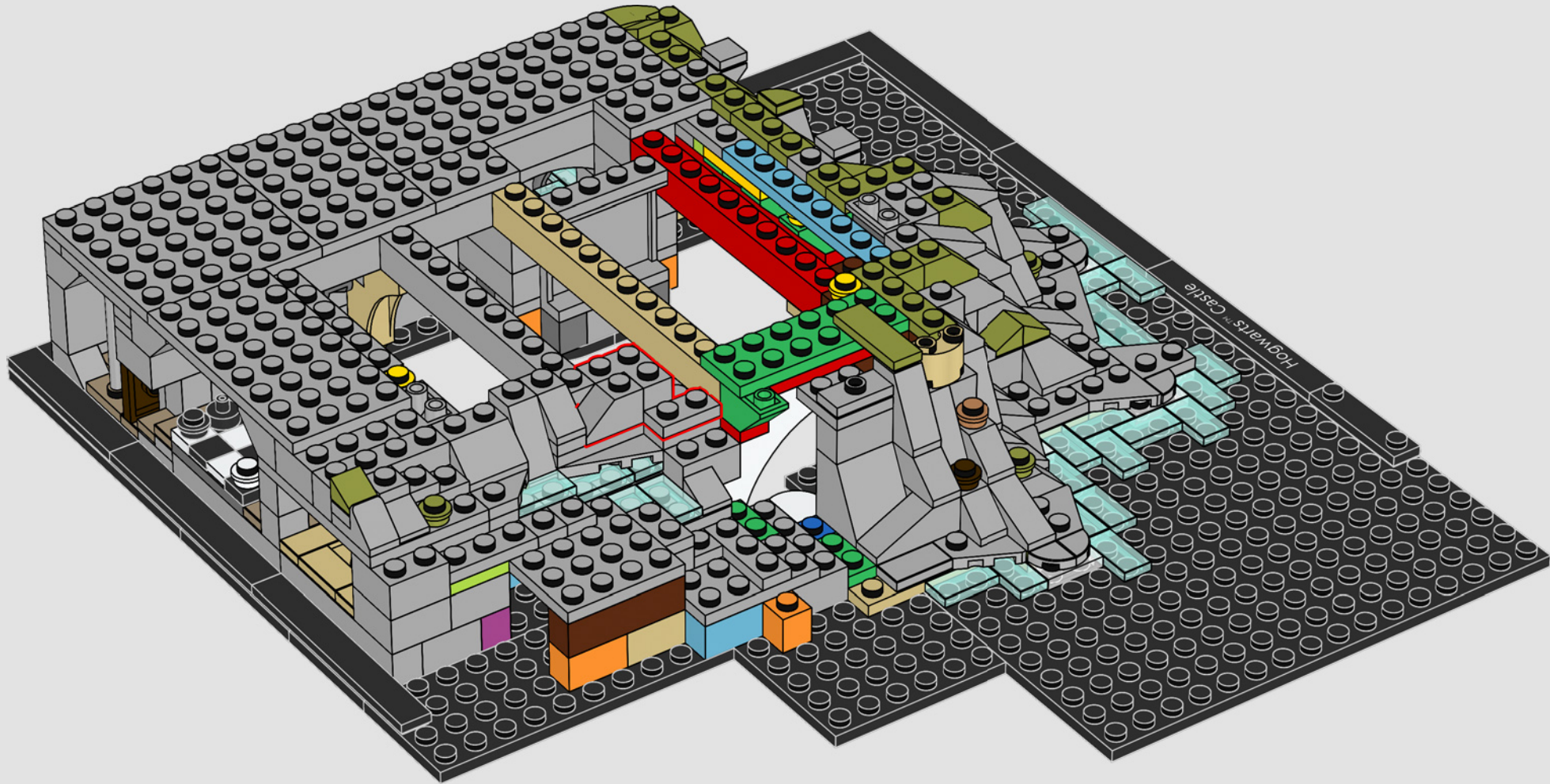



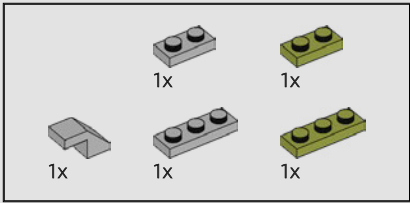

141

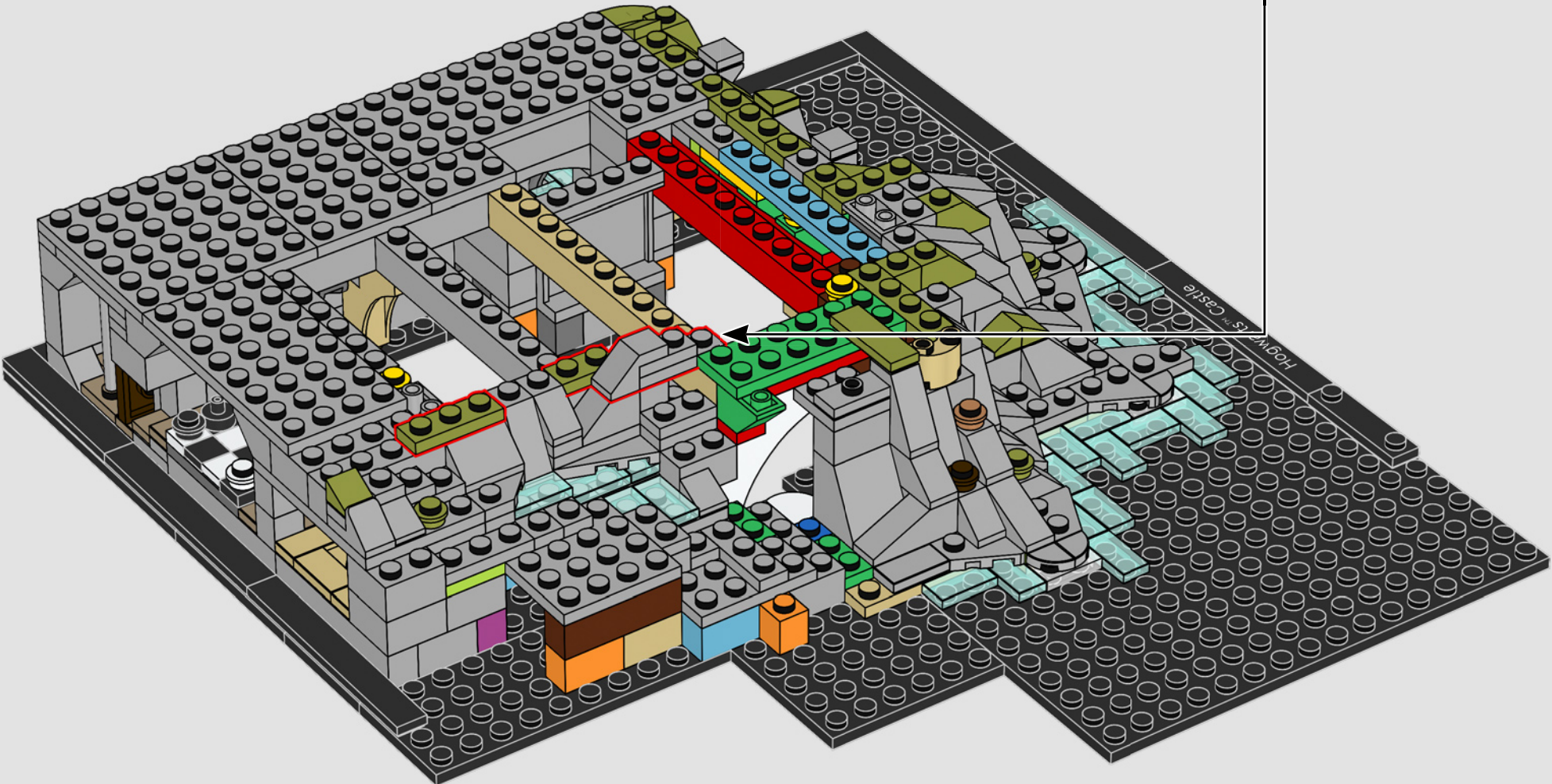
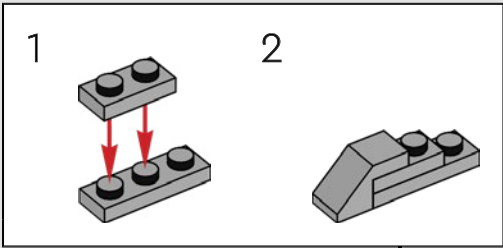

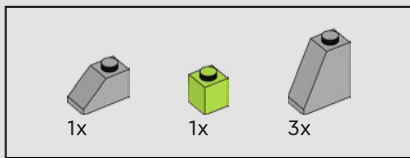

142

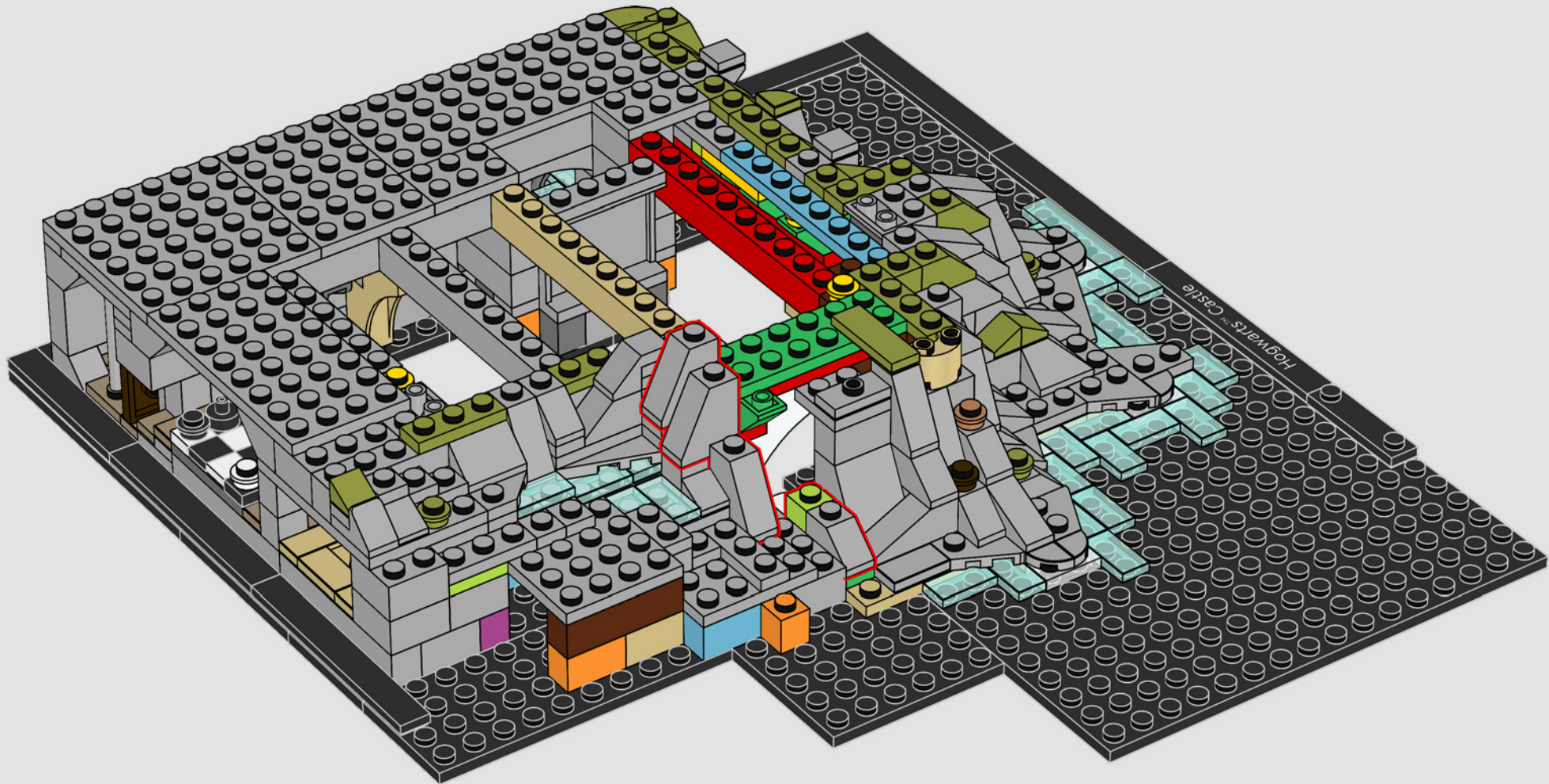



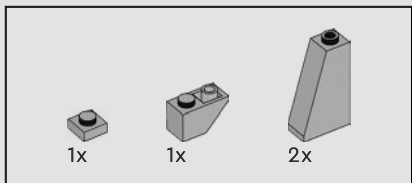

143

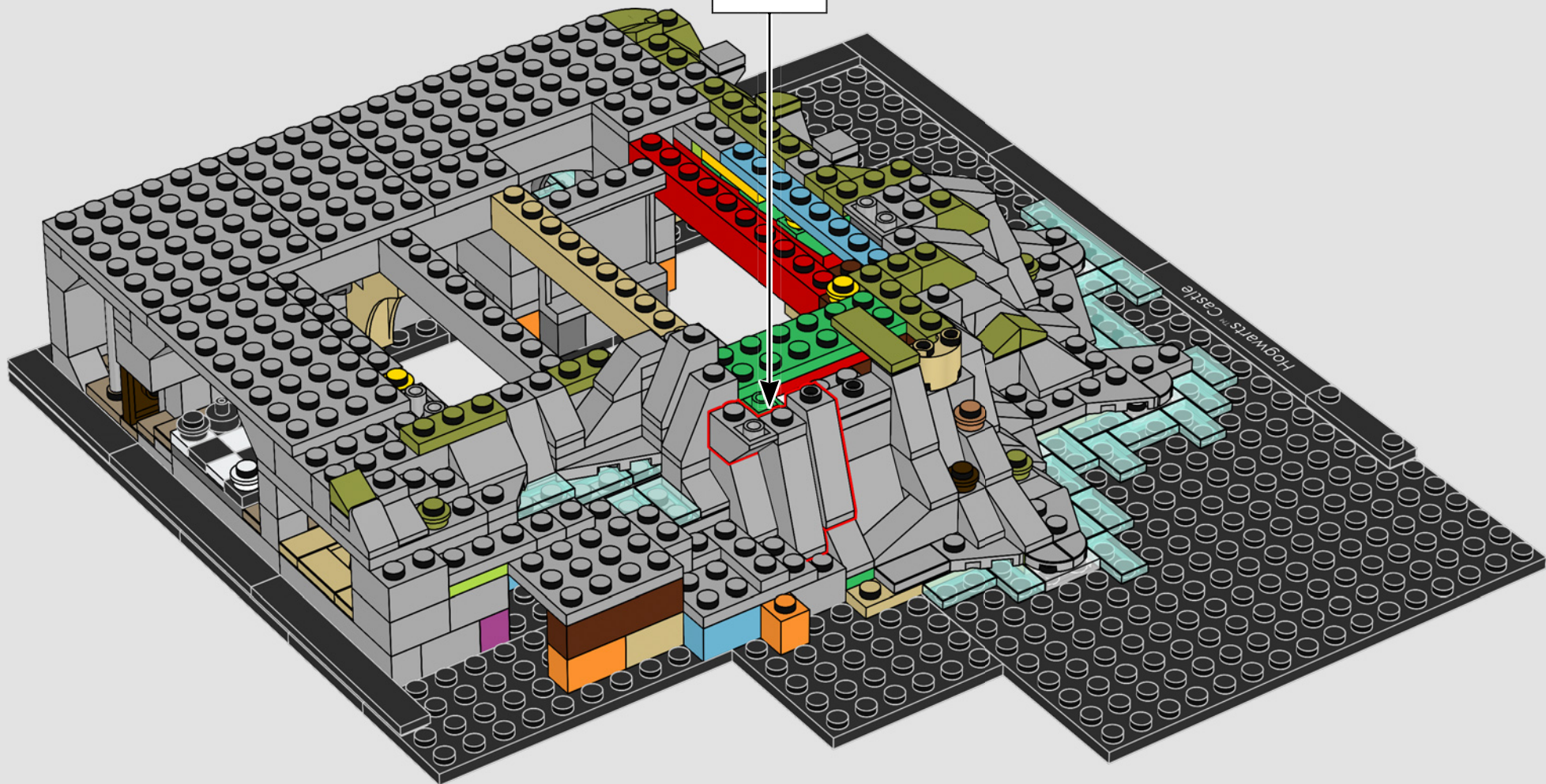
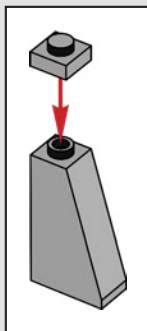



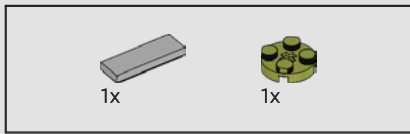

144

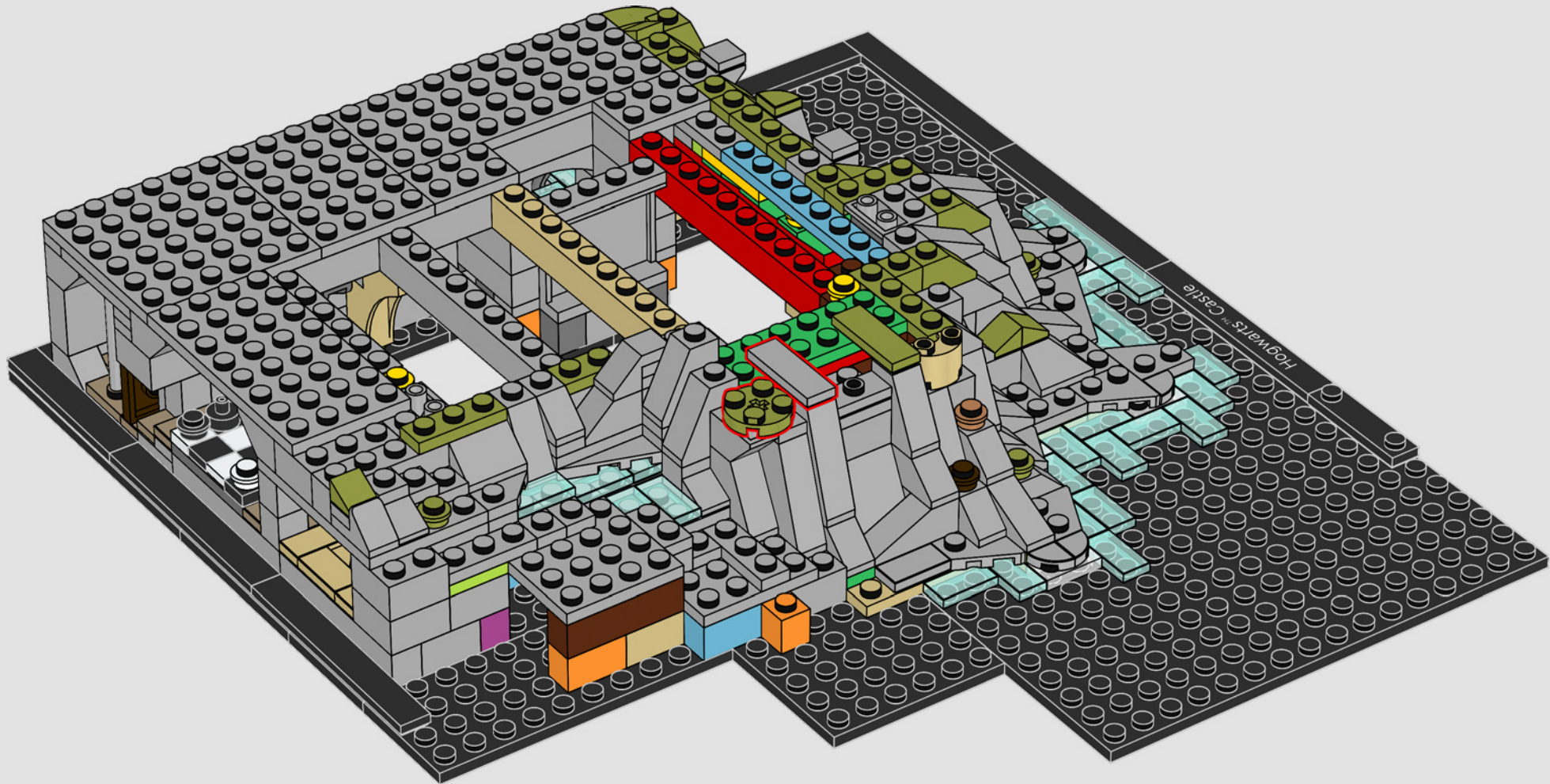

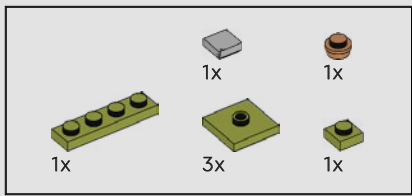

145

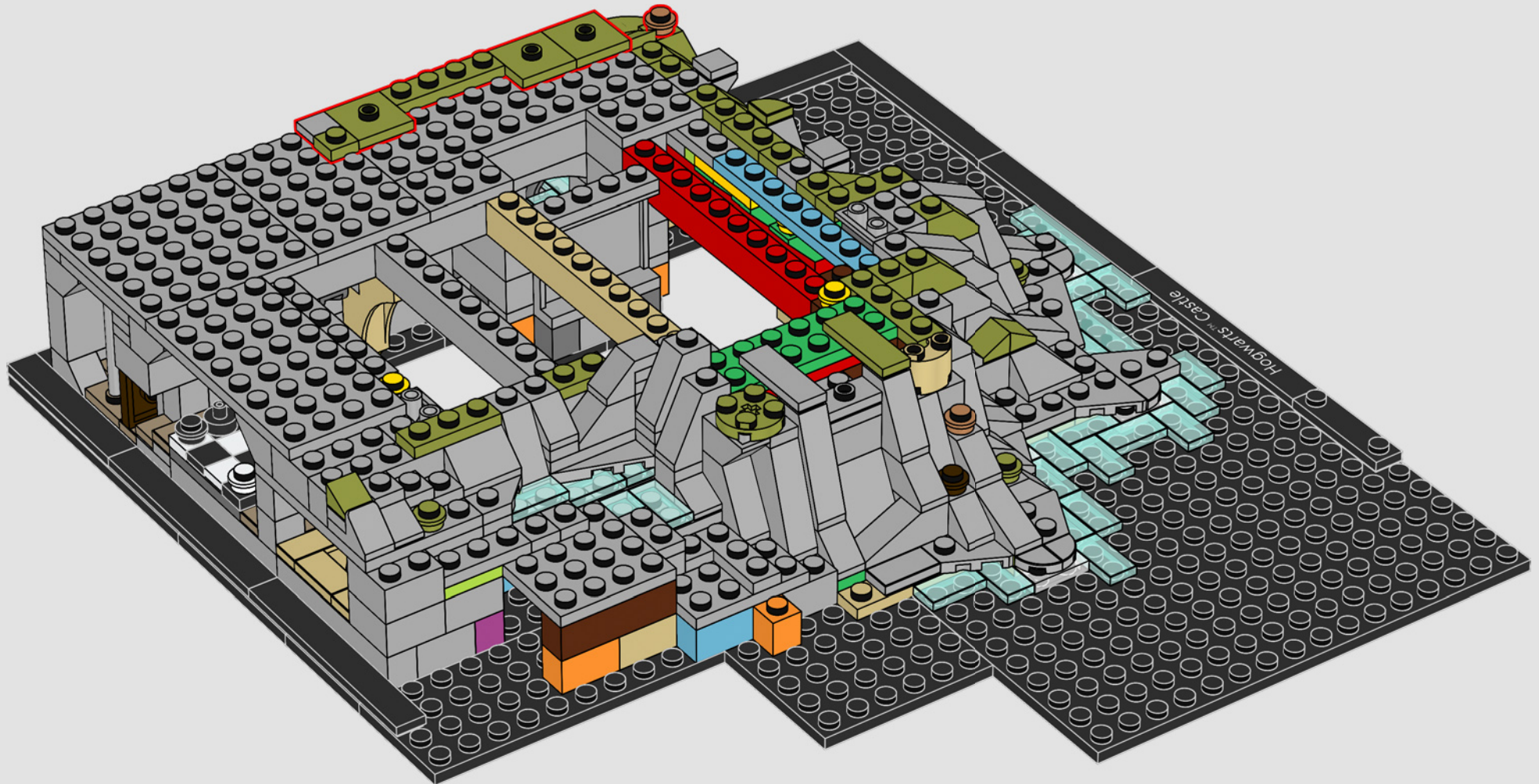



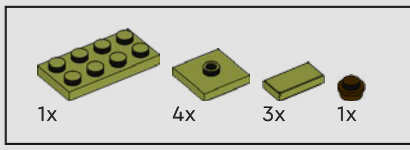

146

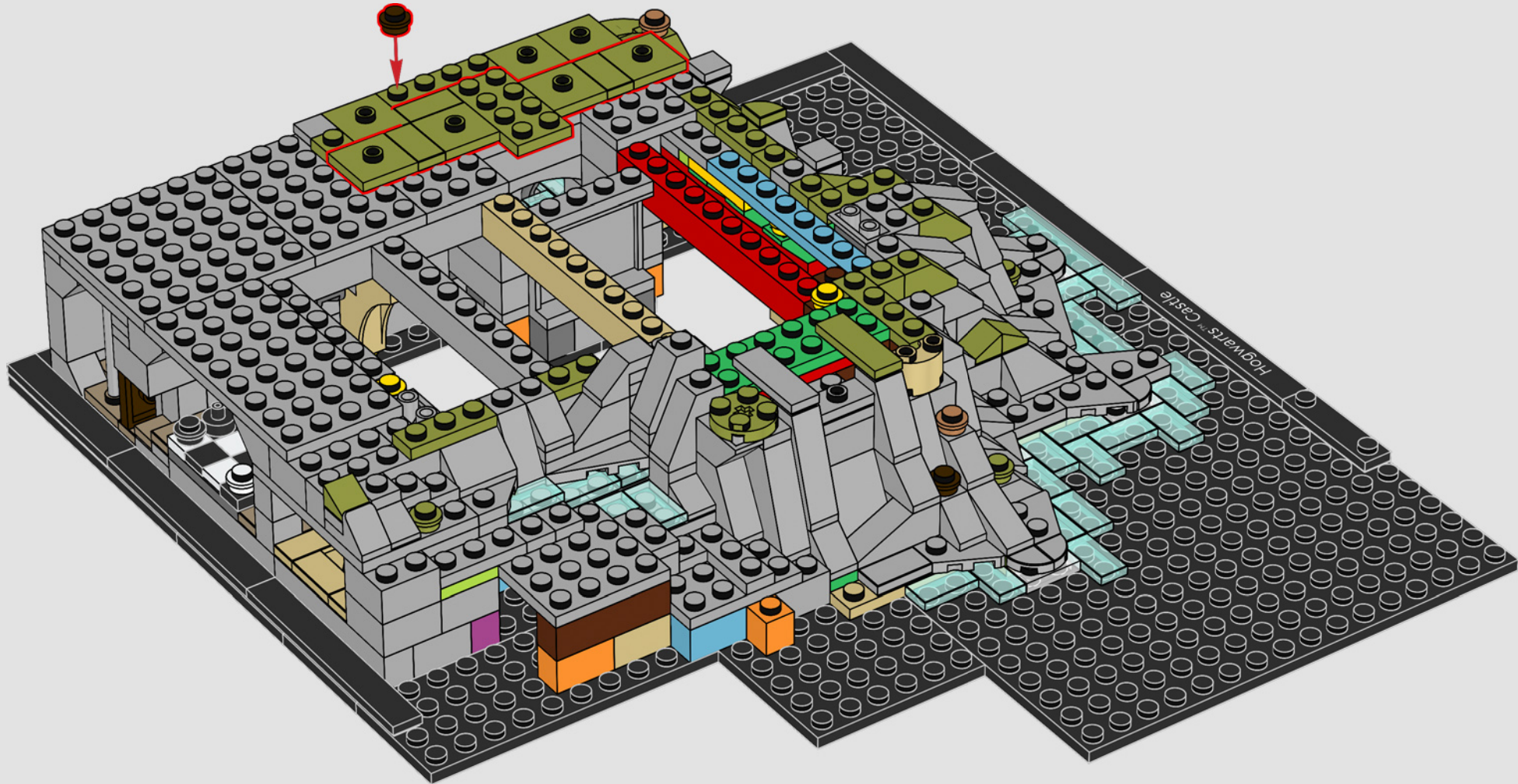



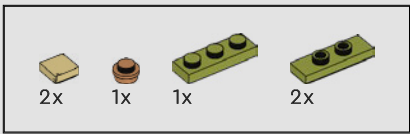

147

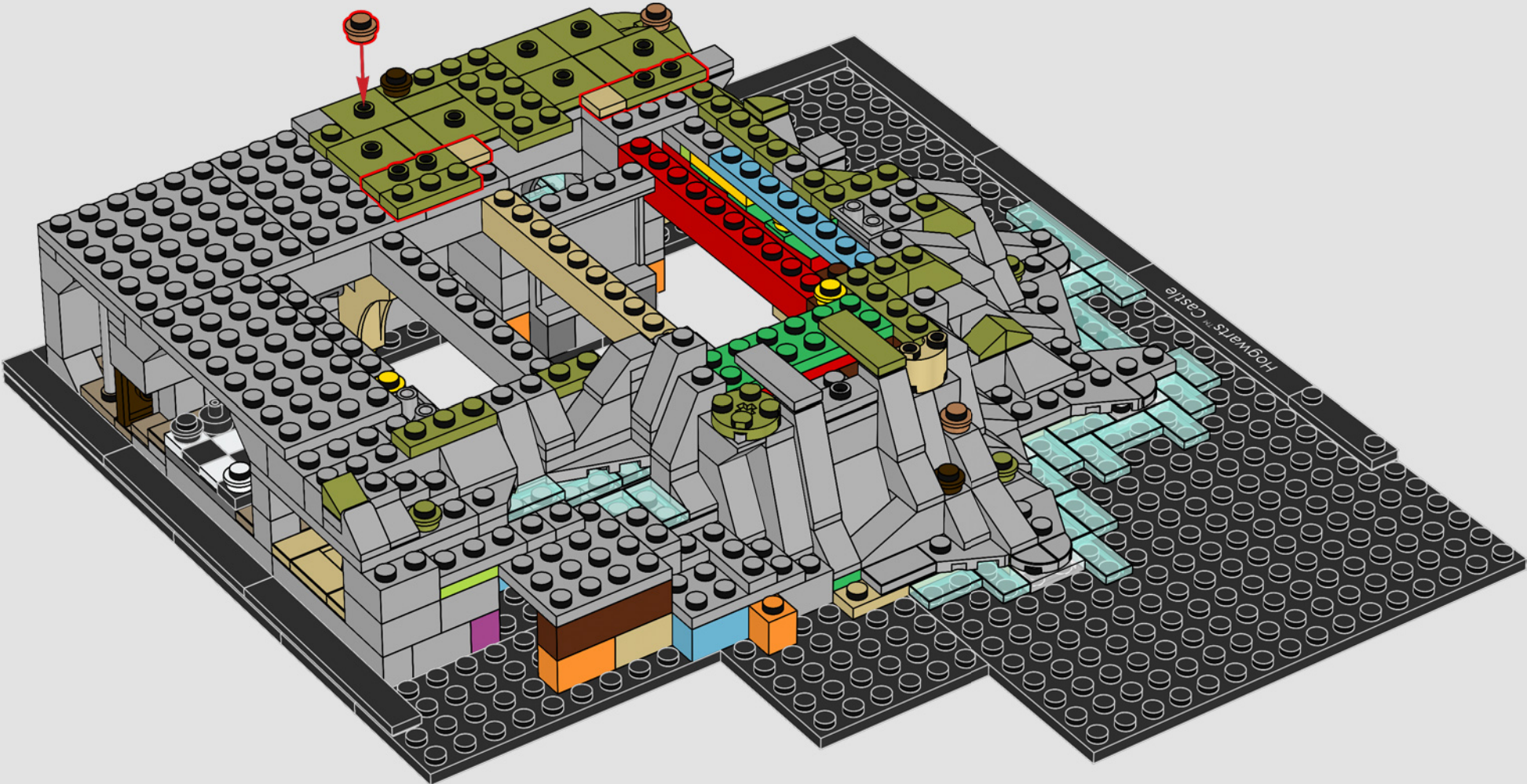

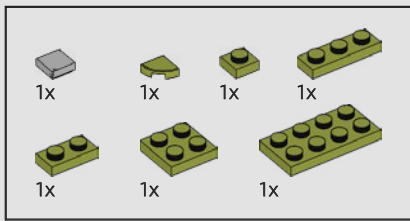

148

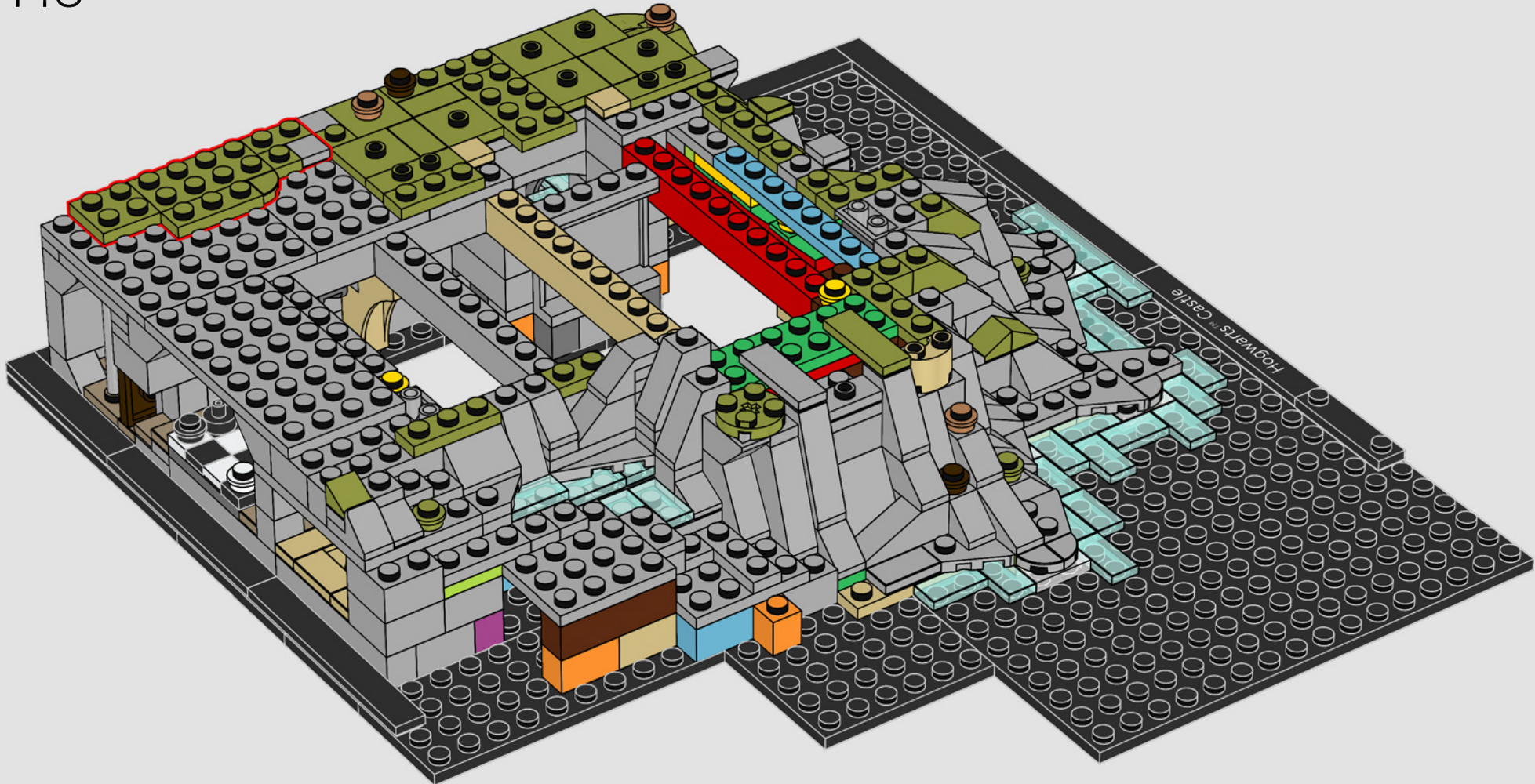



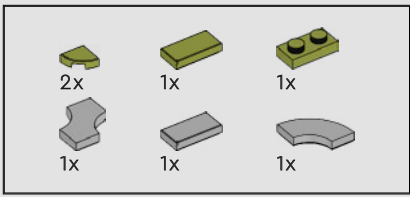

149

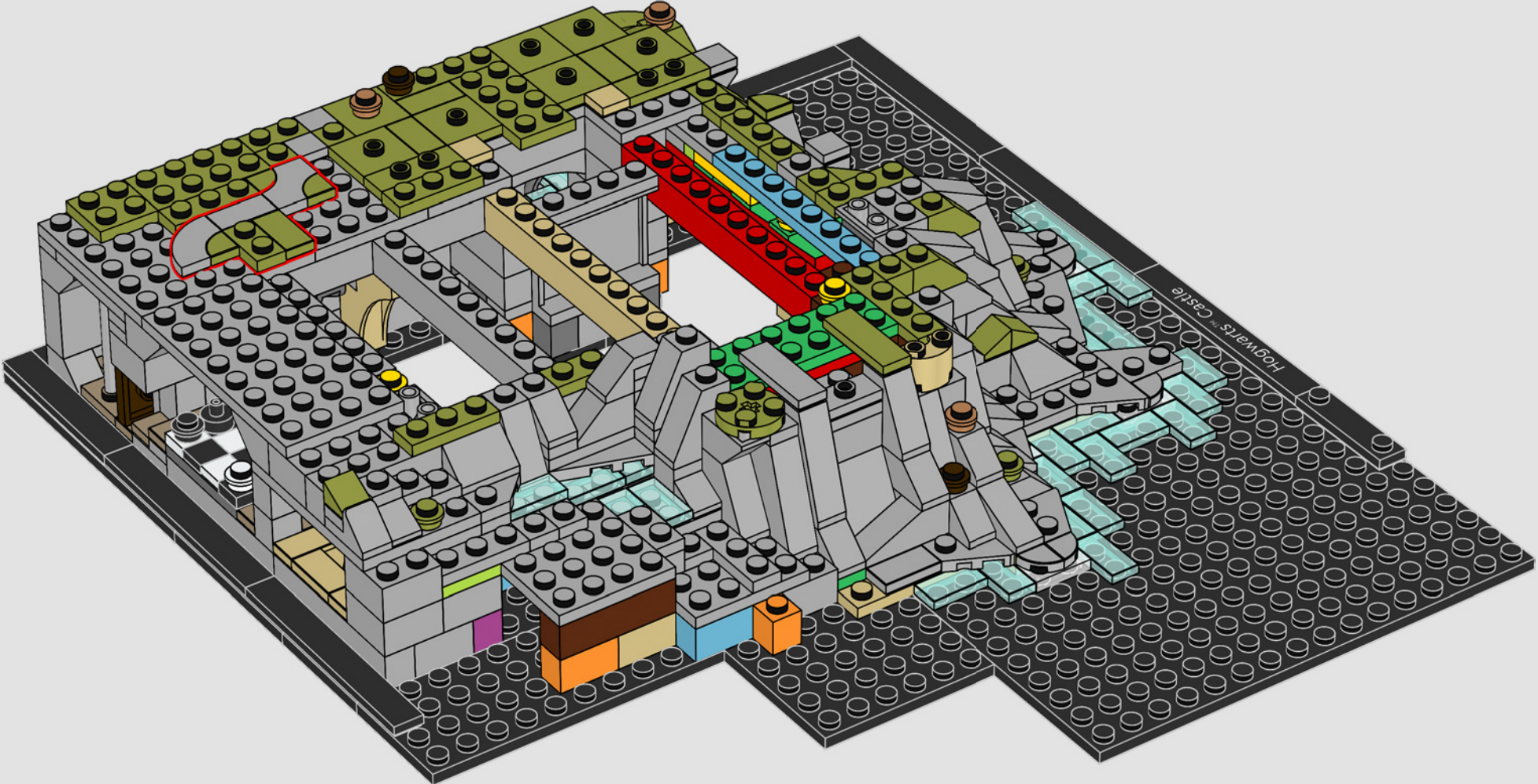



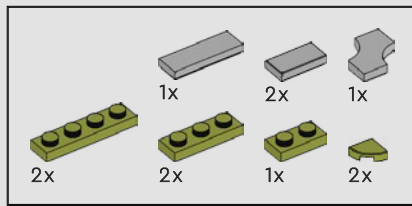

150

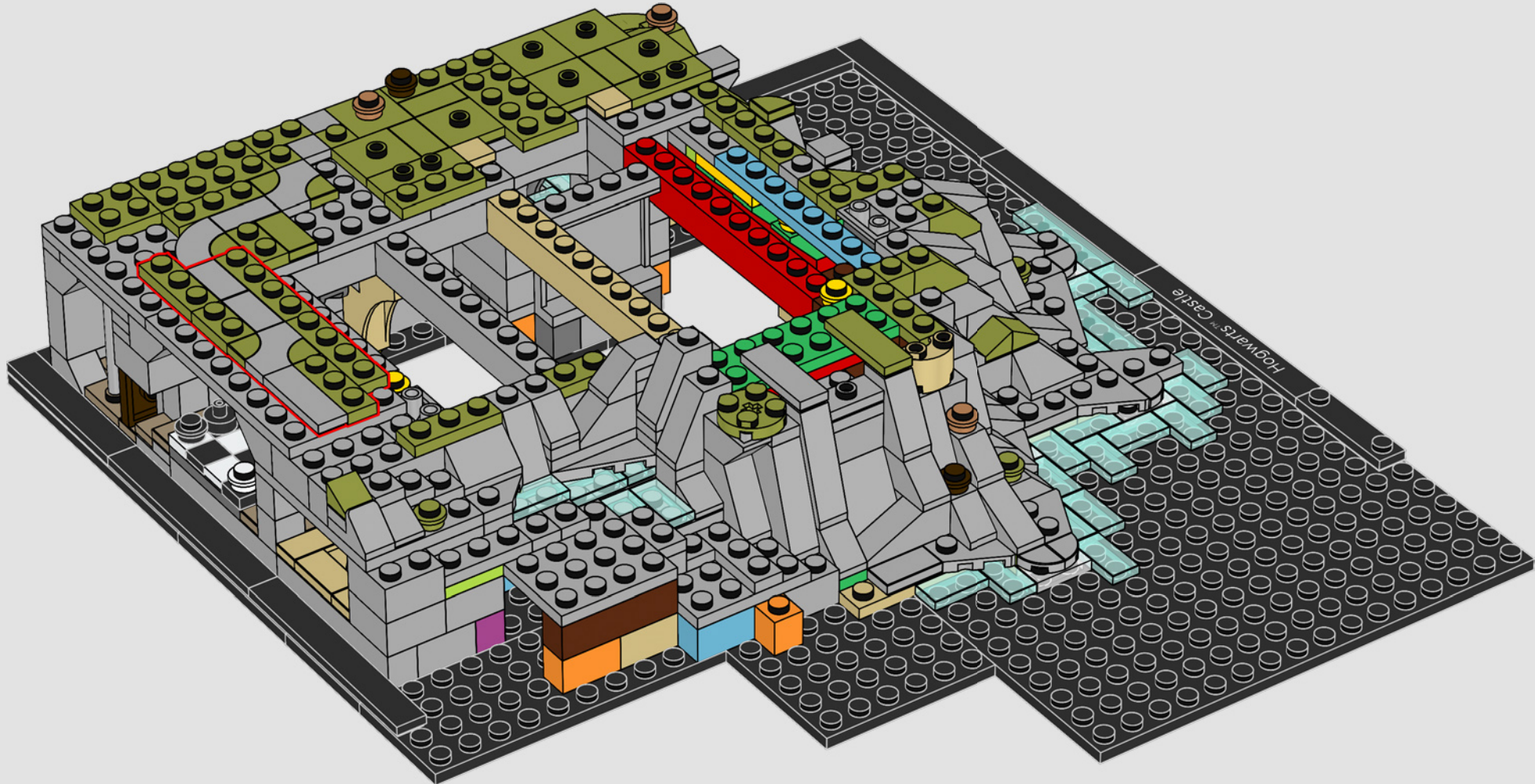

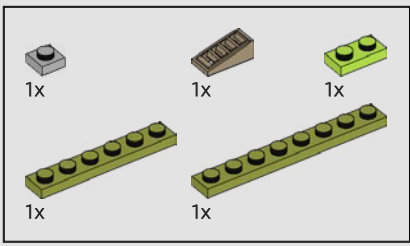

151

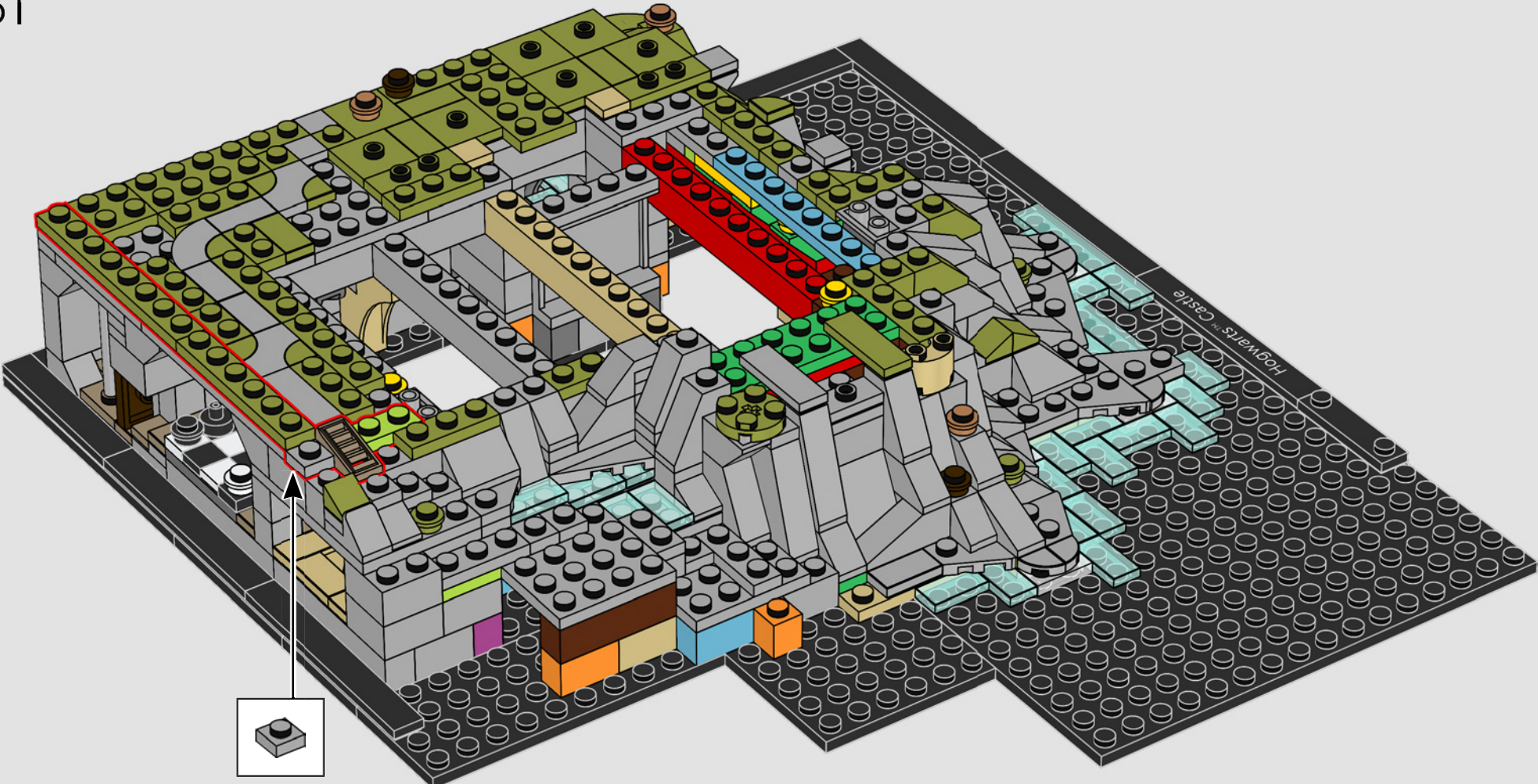



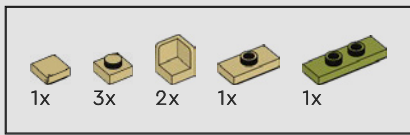

152

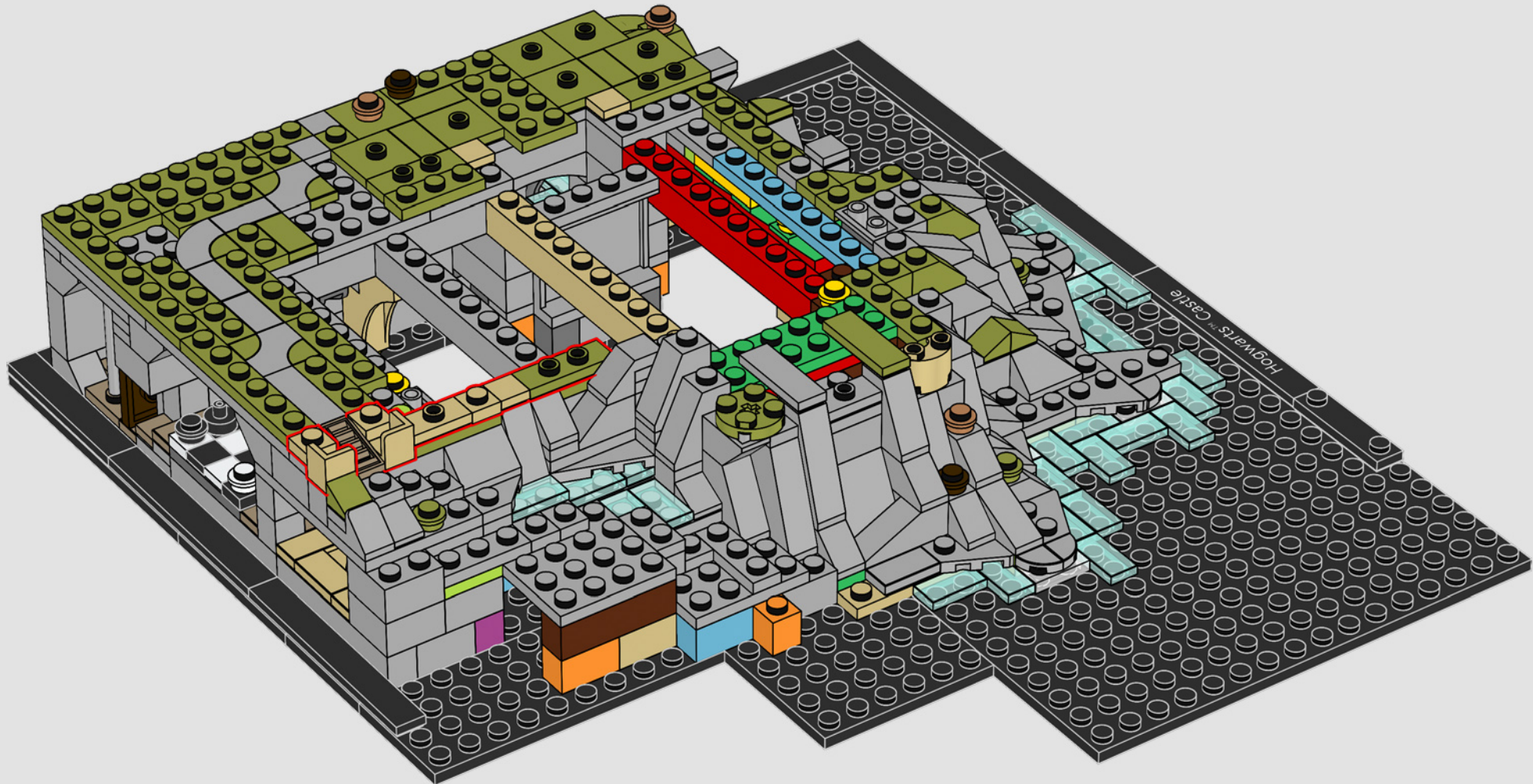



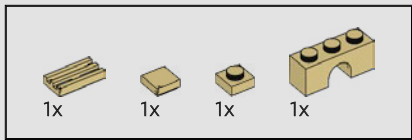

153

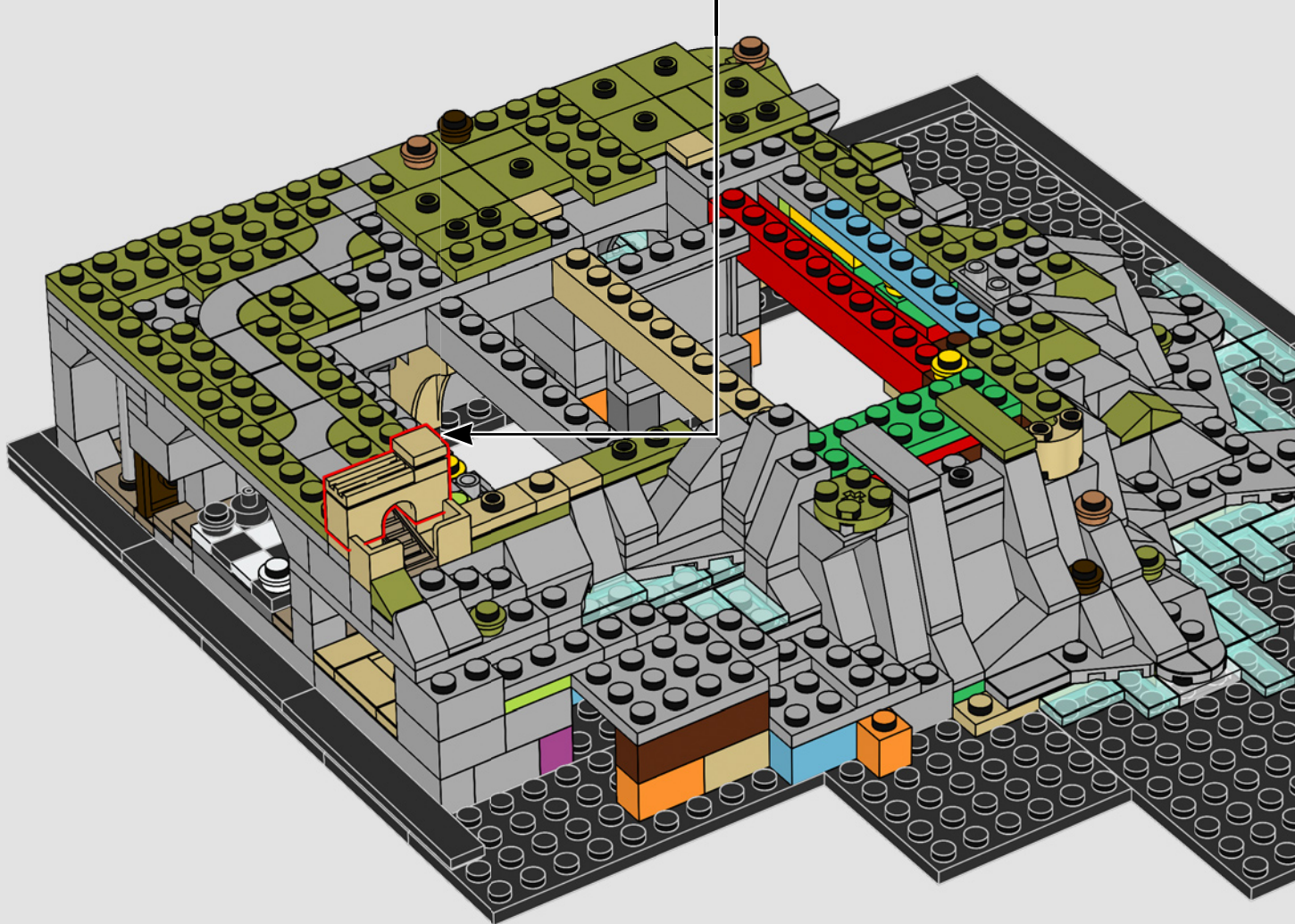
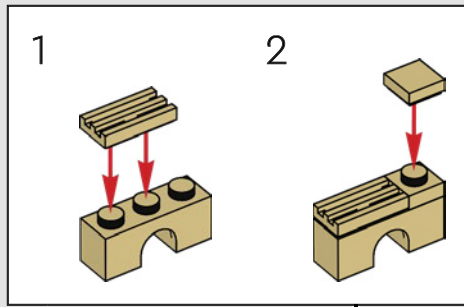

Le quattro Case rappresentavano il coraggio e la determinazione (Grifondoro), la saggezza e l'arguzia (Corvonero), la lealtà e la dedizione (Tassorosso) e i valori di ambizione e astuzia (Serpeverde).





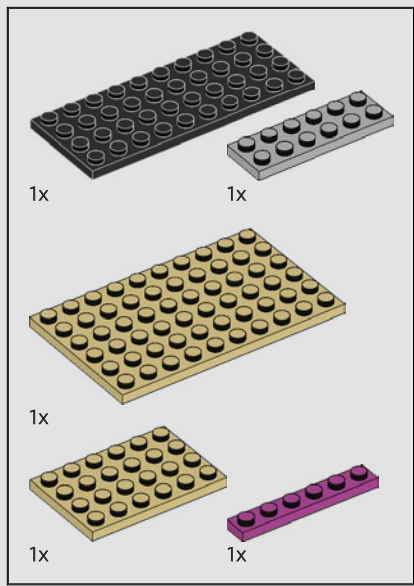

154





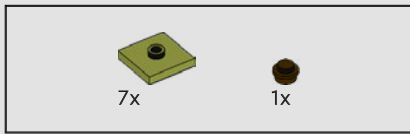

155

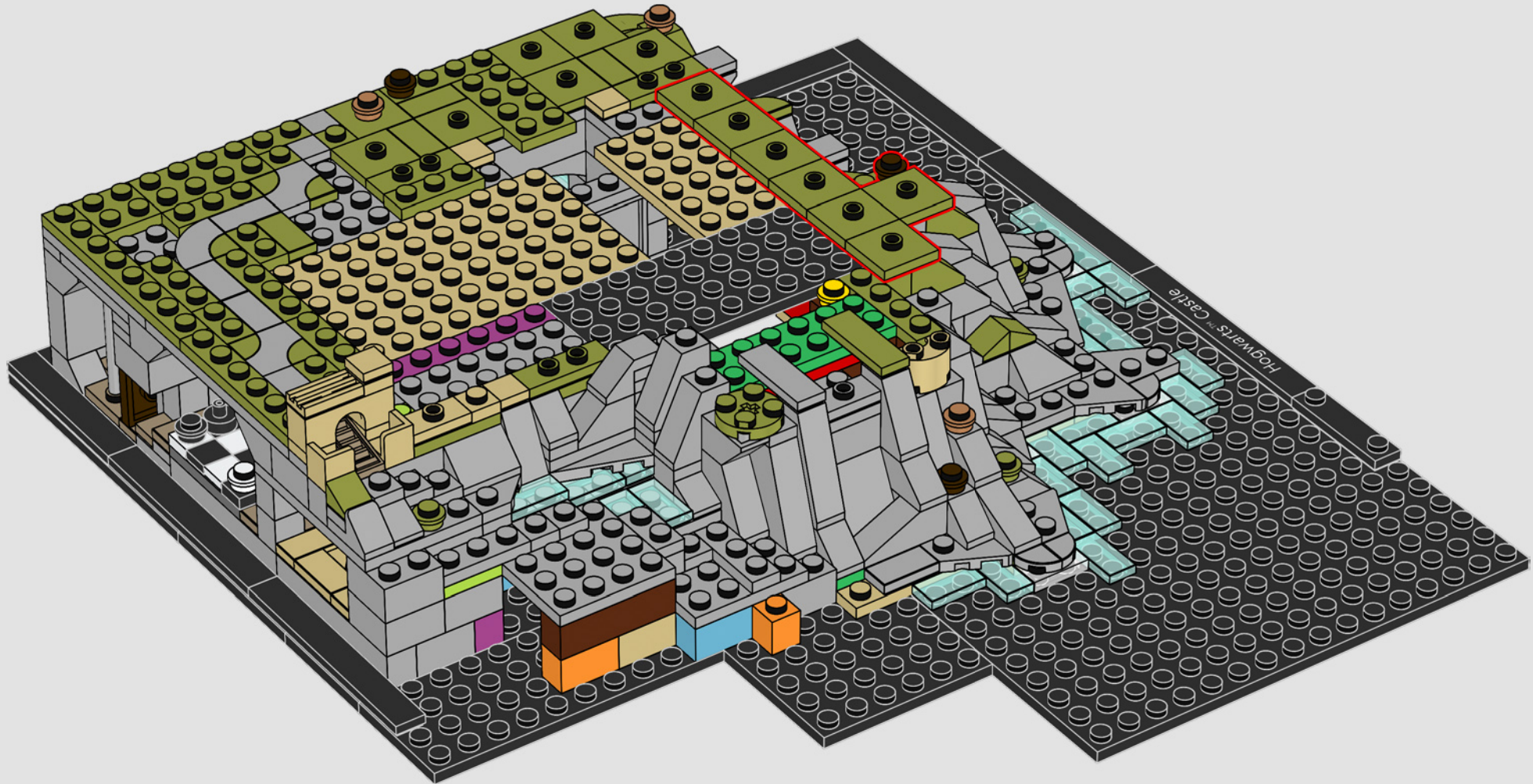

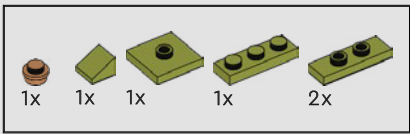

156

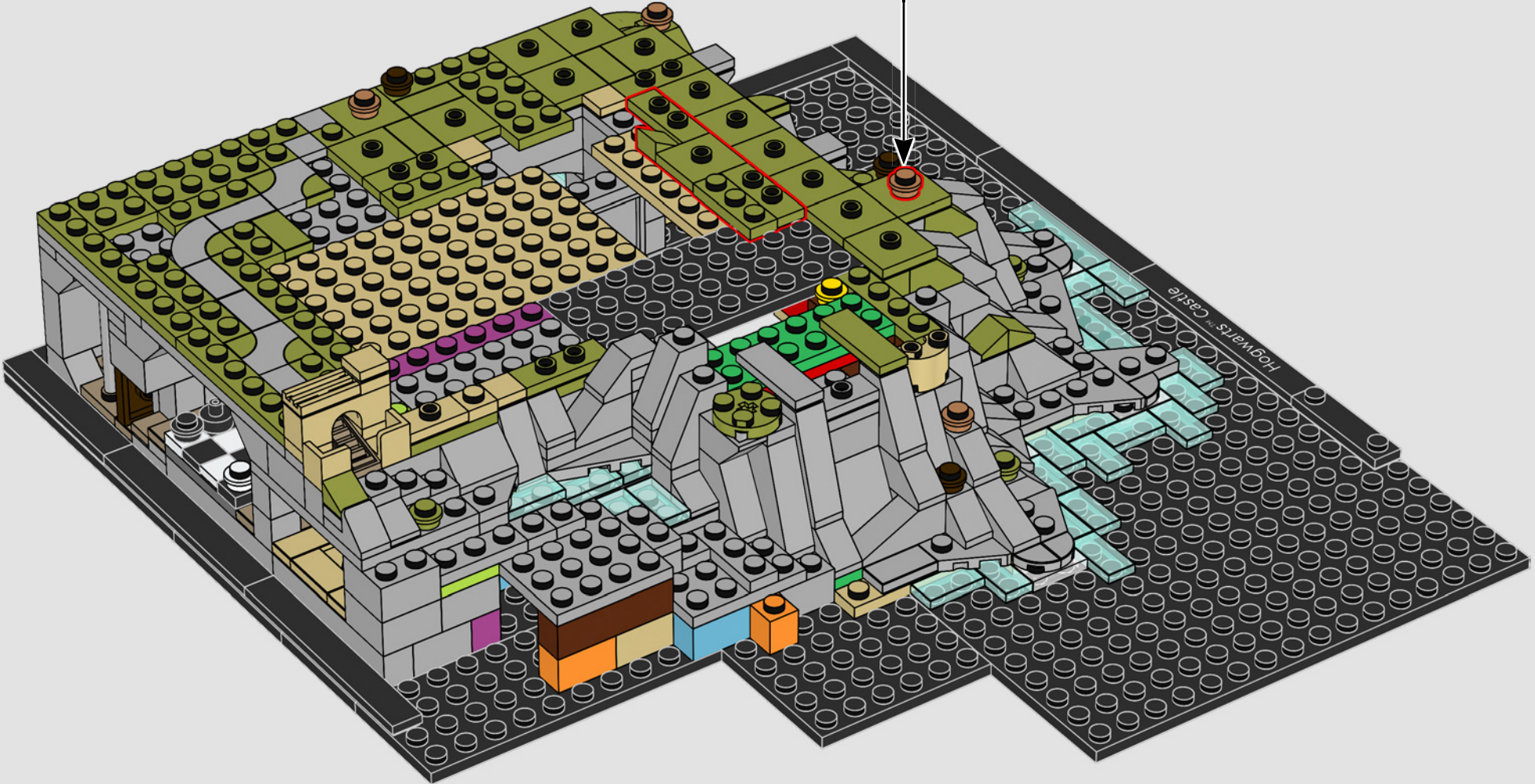



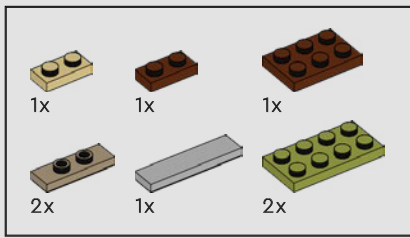

157

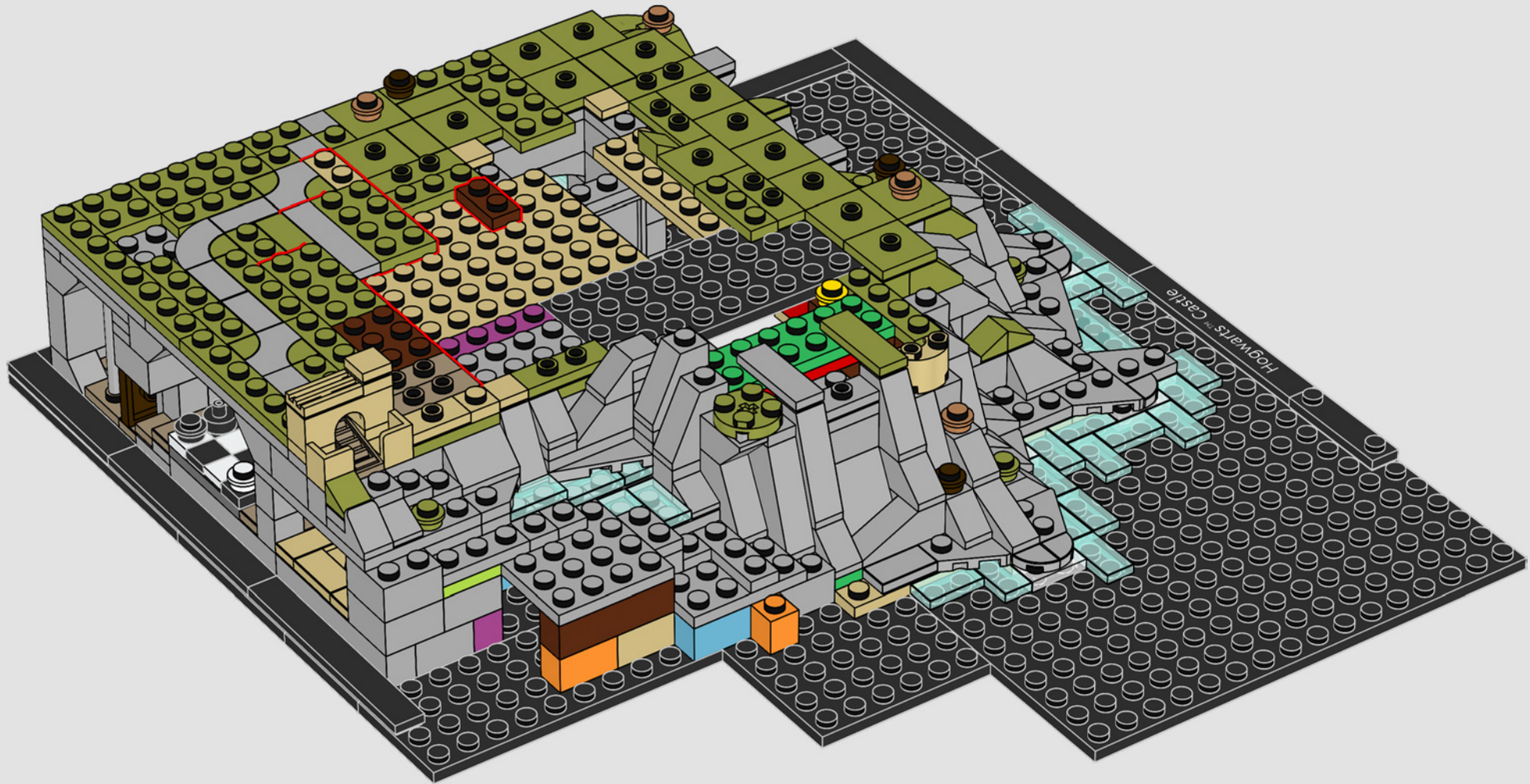



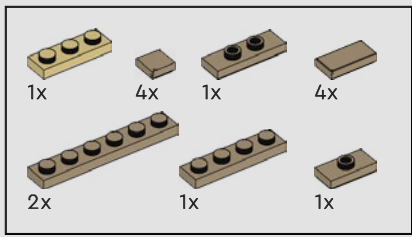

158

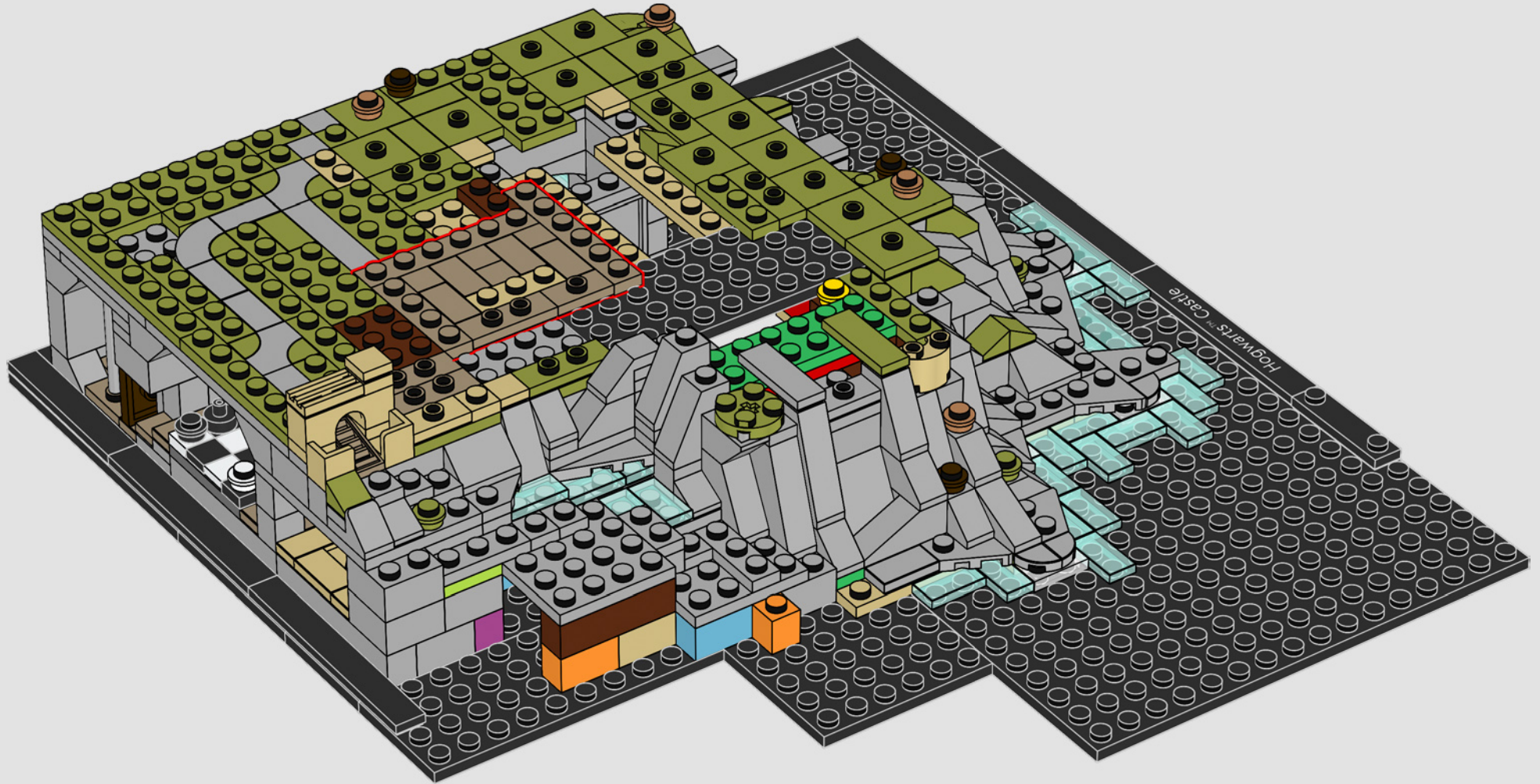

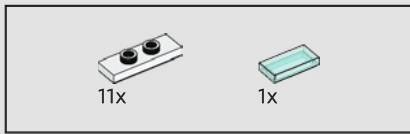

159

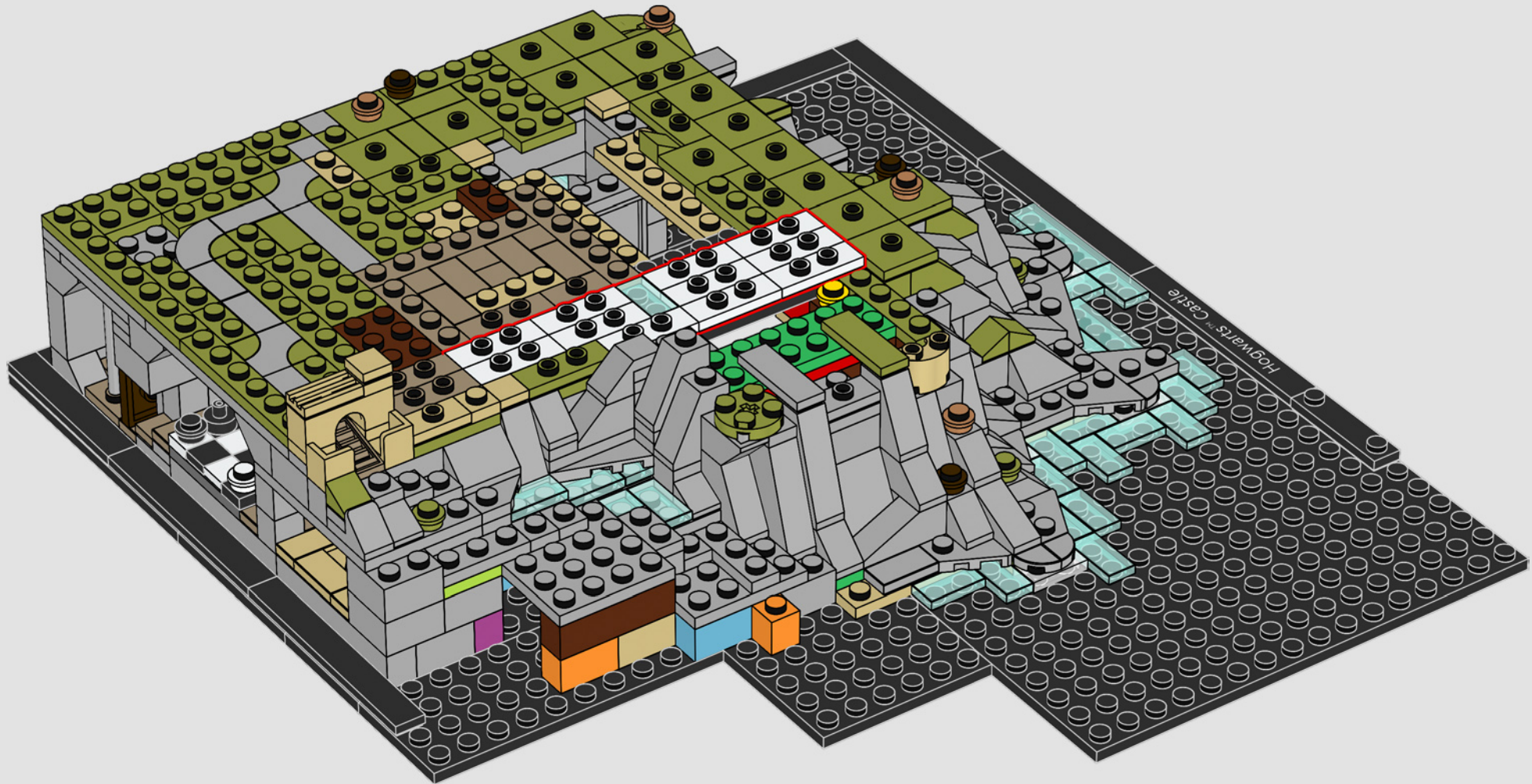



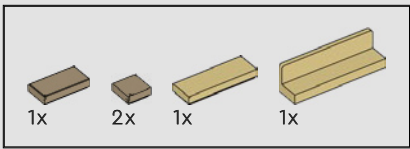

160

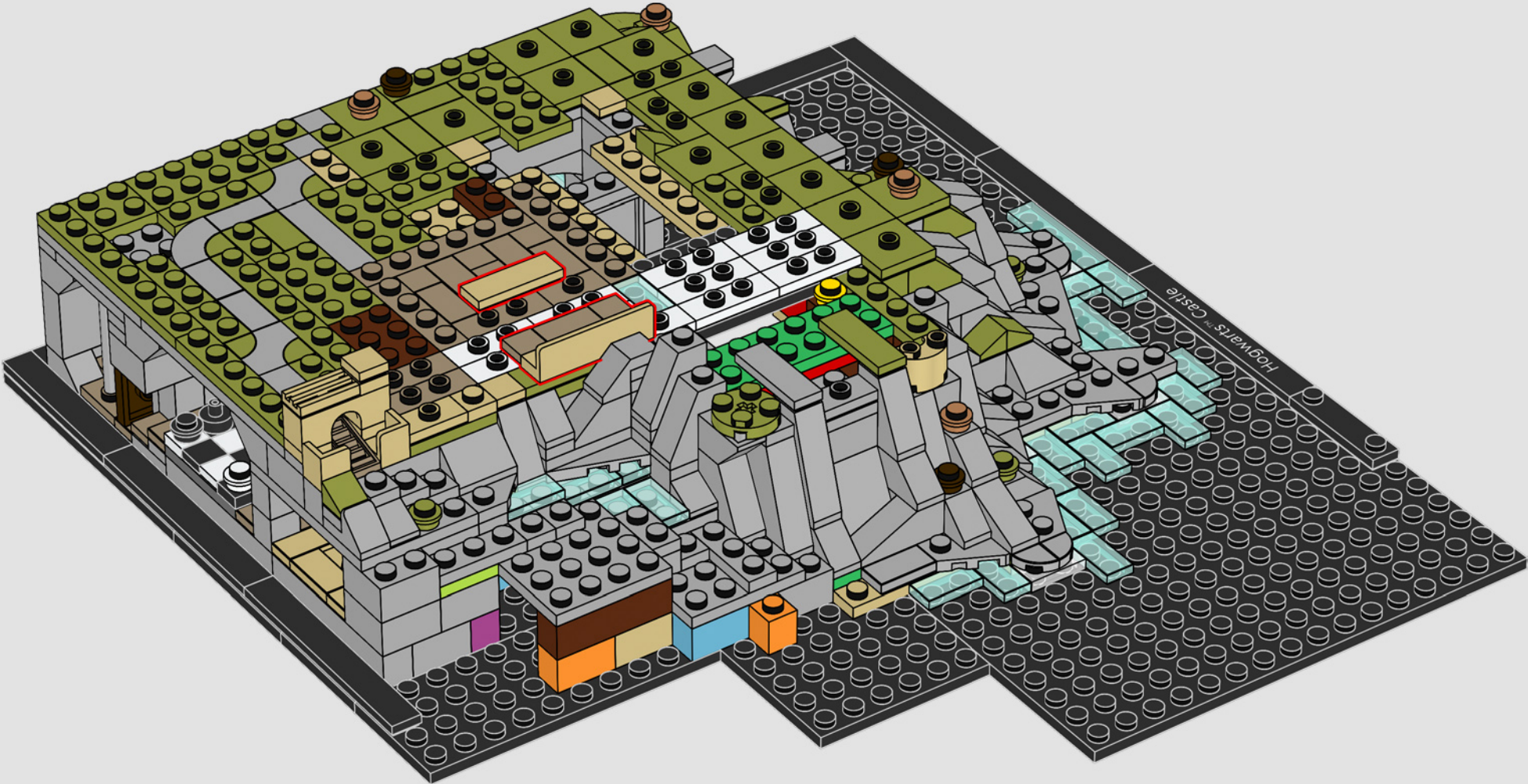



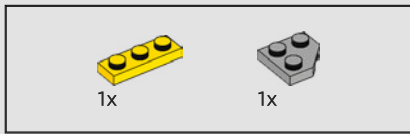

161

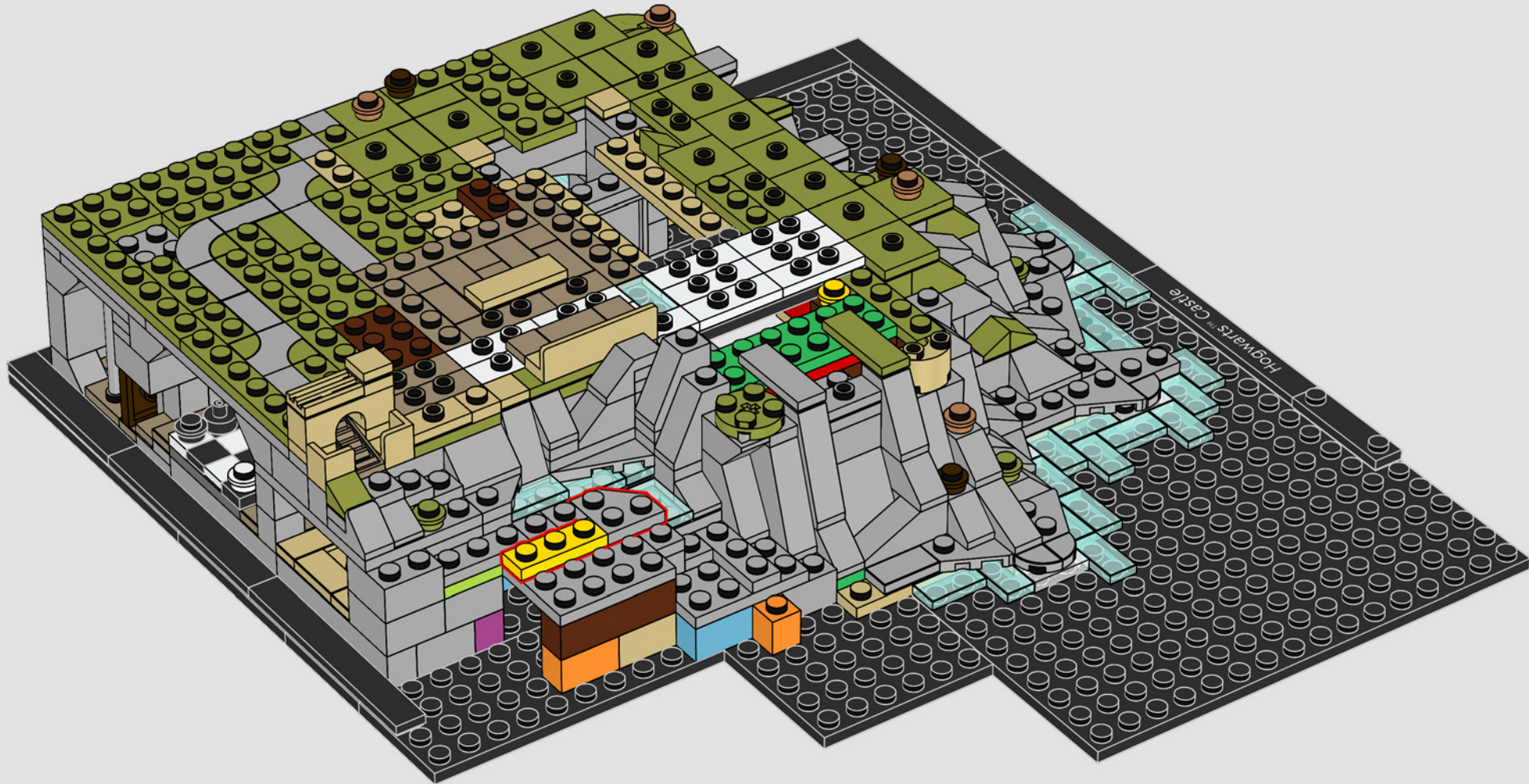

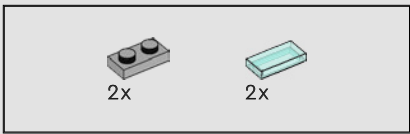

162

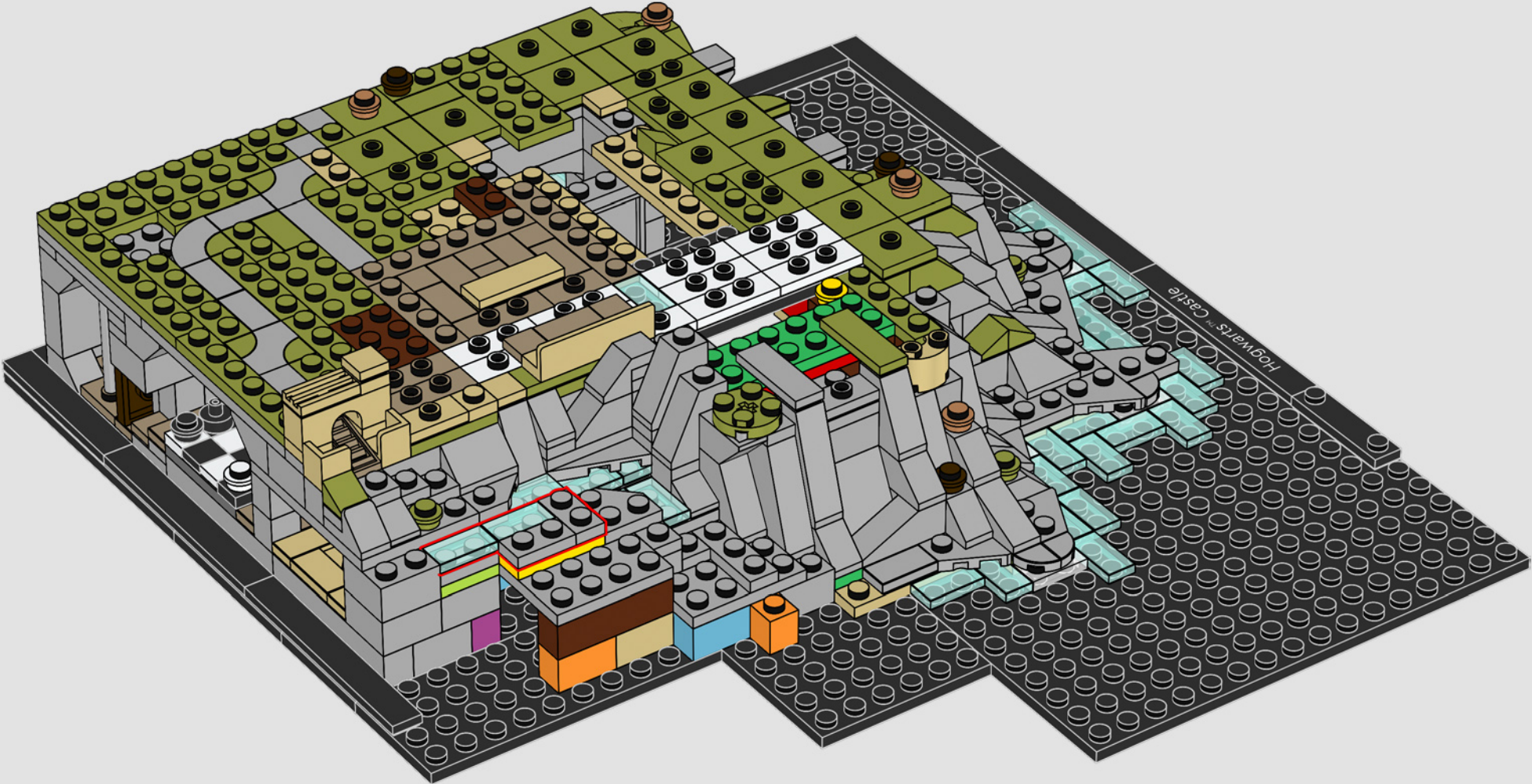



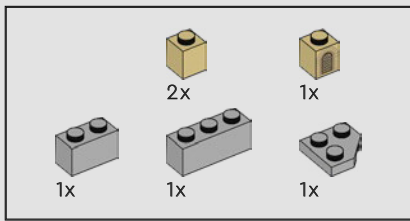

163

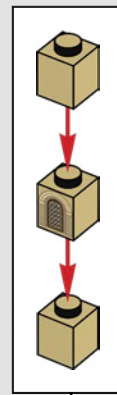
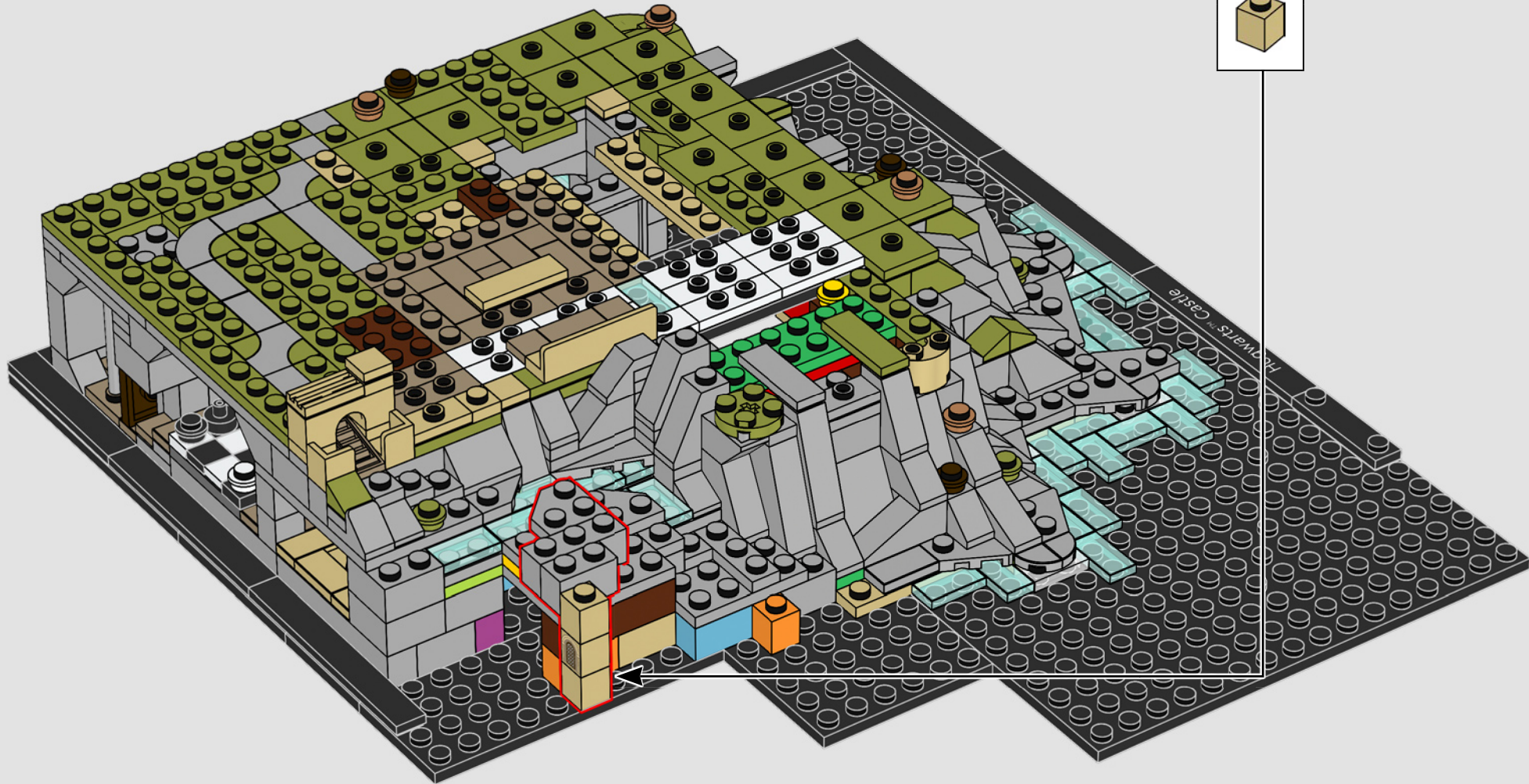





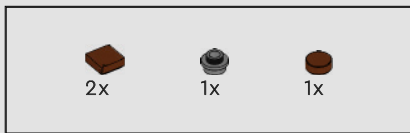

168

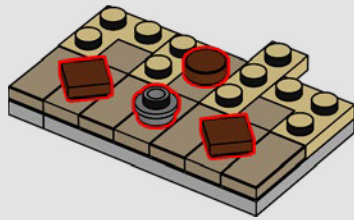

169

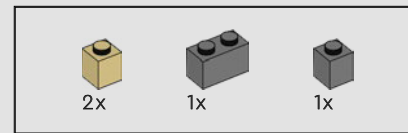
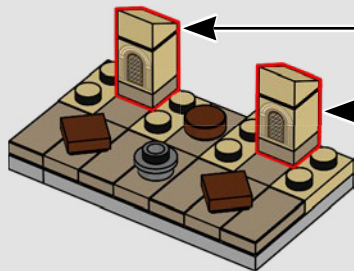
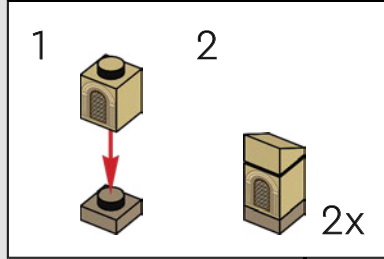

170

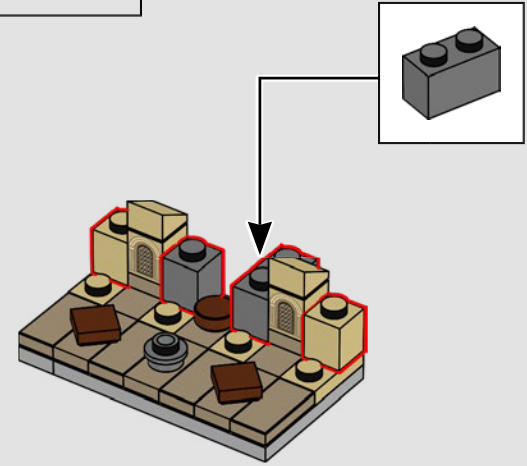

171

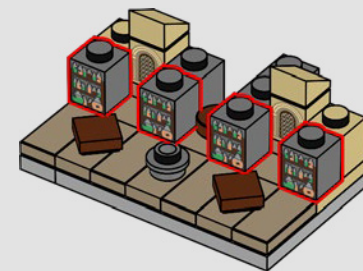



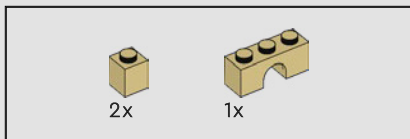

172

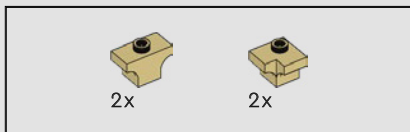
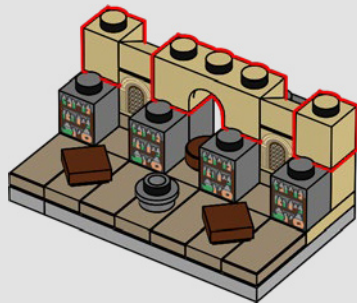

173

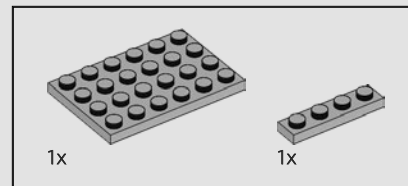
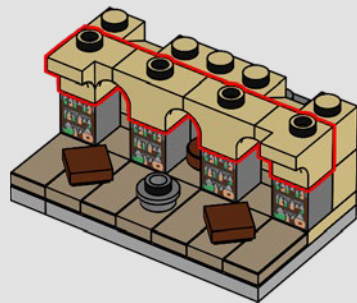

174

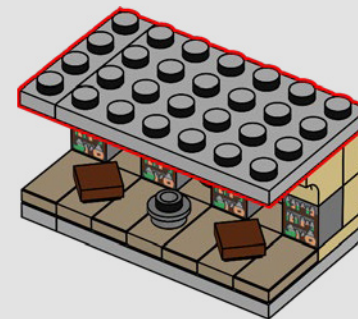

175

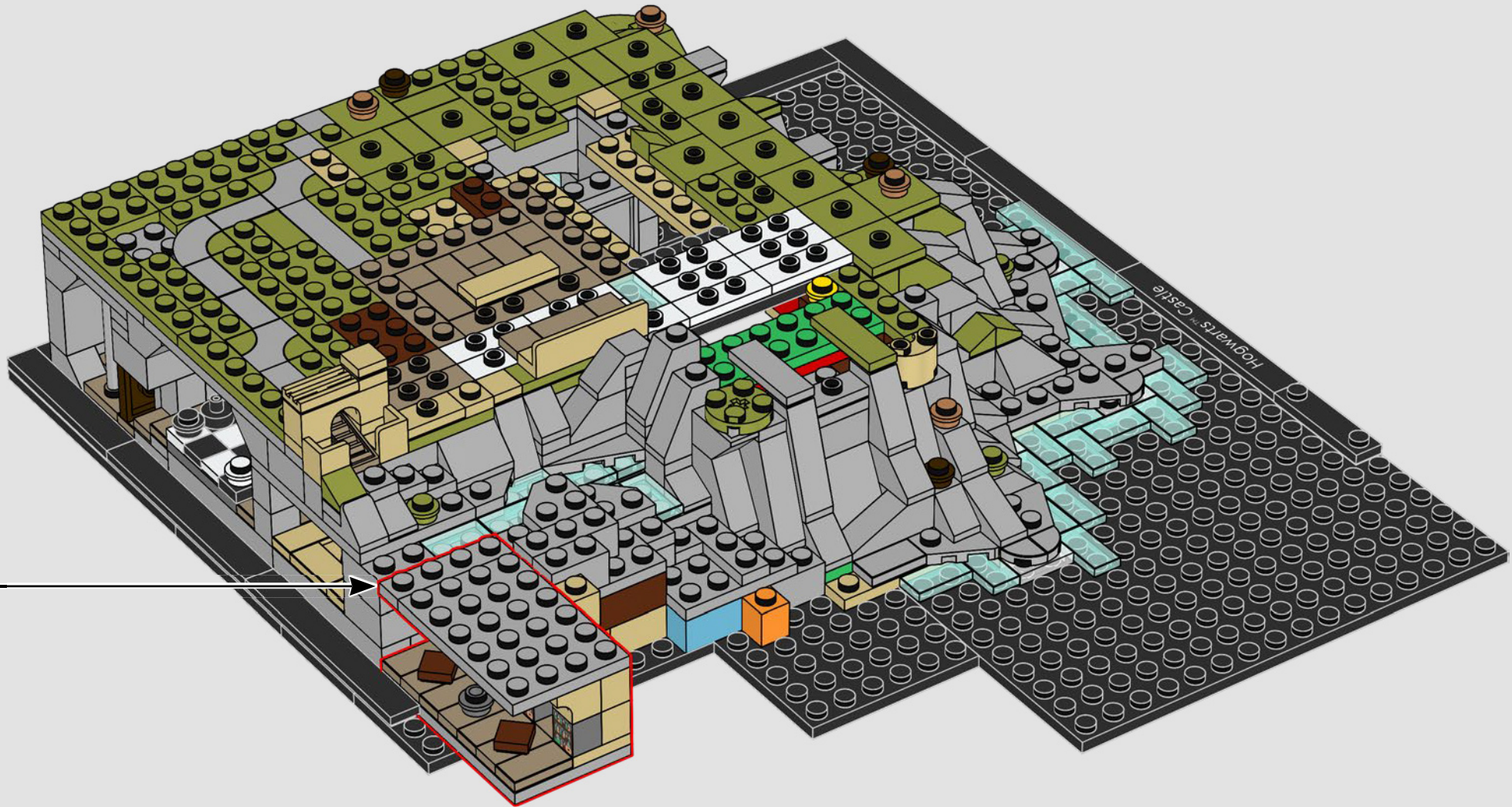





I Babbani potrebbero essere tentati di preparare le loro pozioni, ma rischiano di rimanere delusi (o peggio!) dai risultati. Solo le streghe o i maghi possono creare la magia necessaria per preparare elisir di successo.



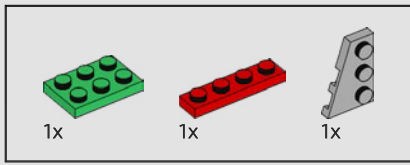

176

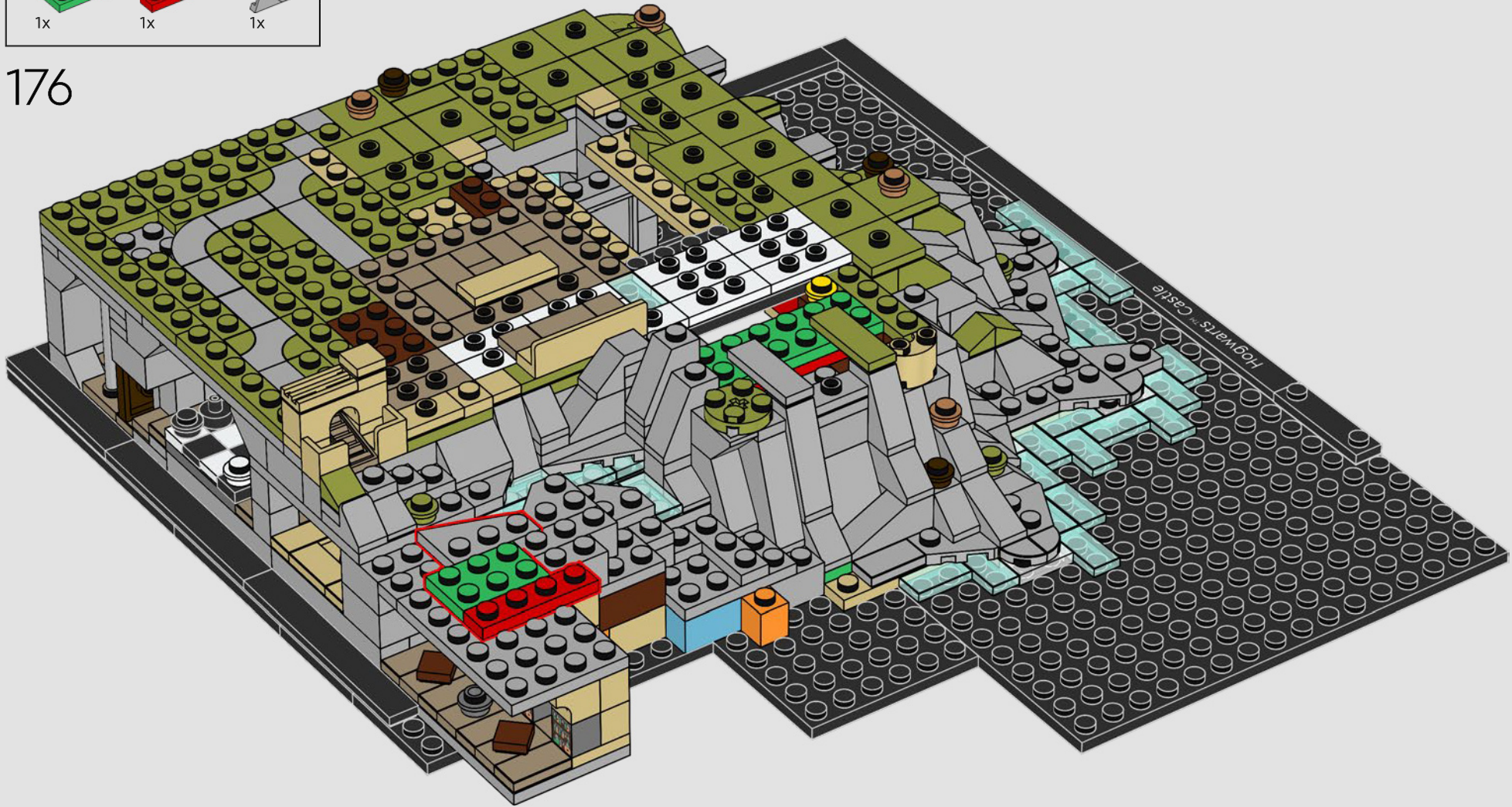



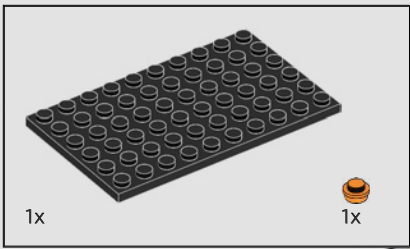

177

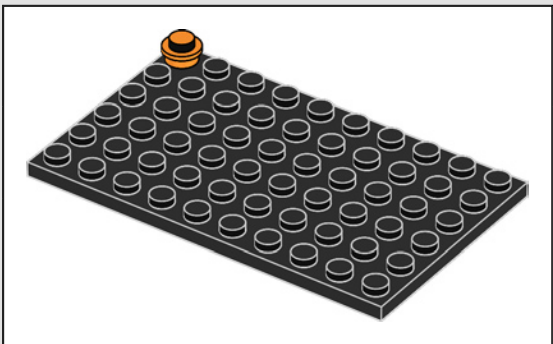
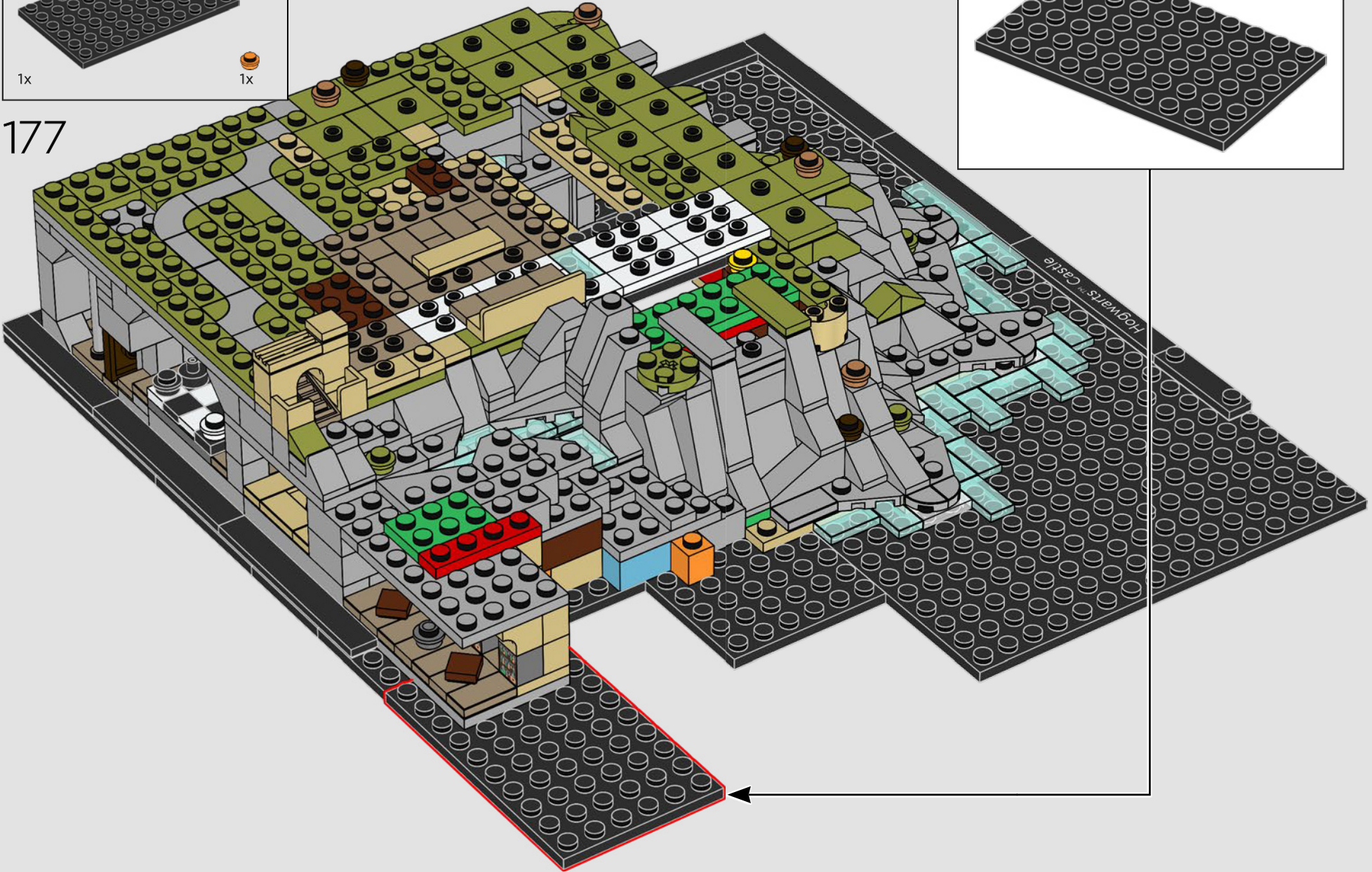



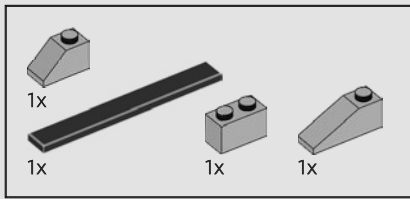

178

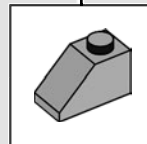









179





		
2x	1x	1x

180





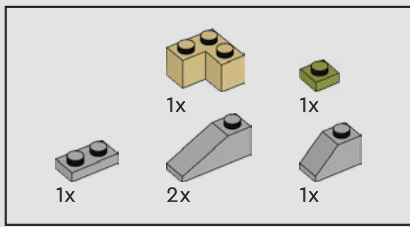

181

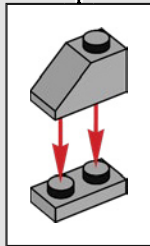



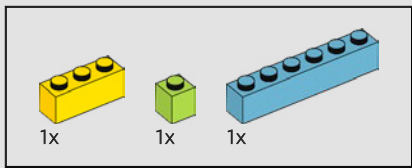

182

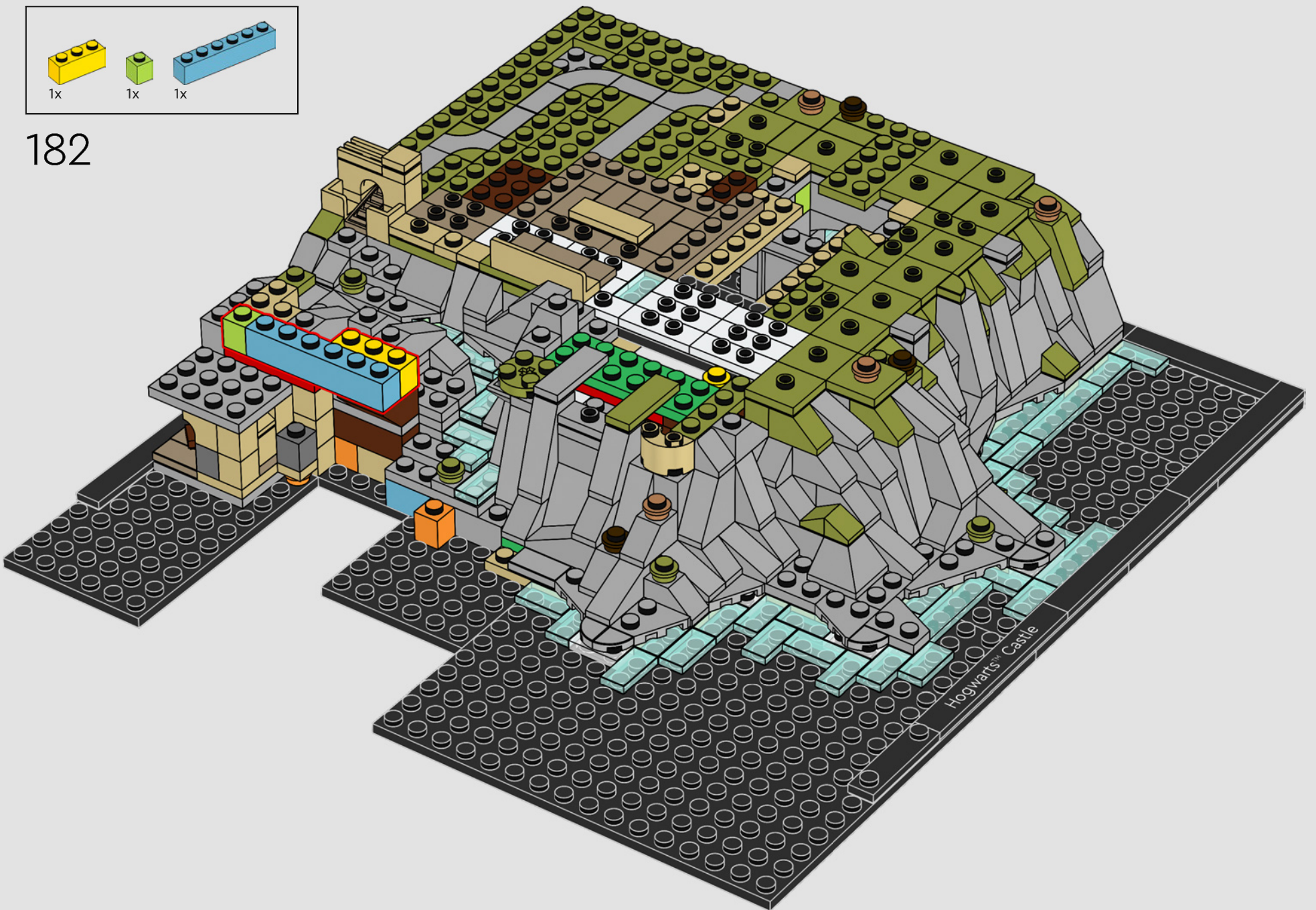



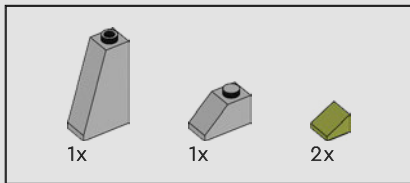

183

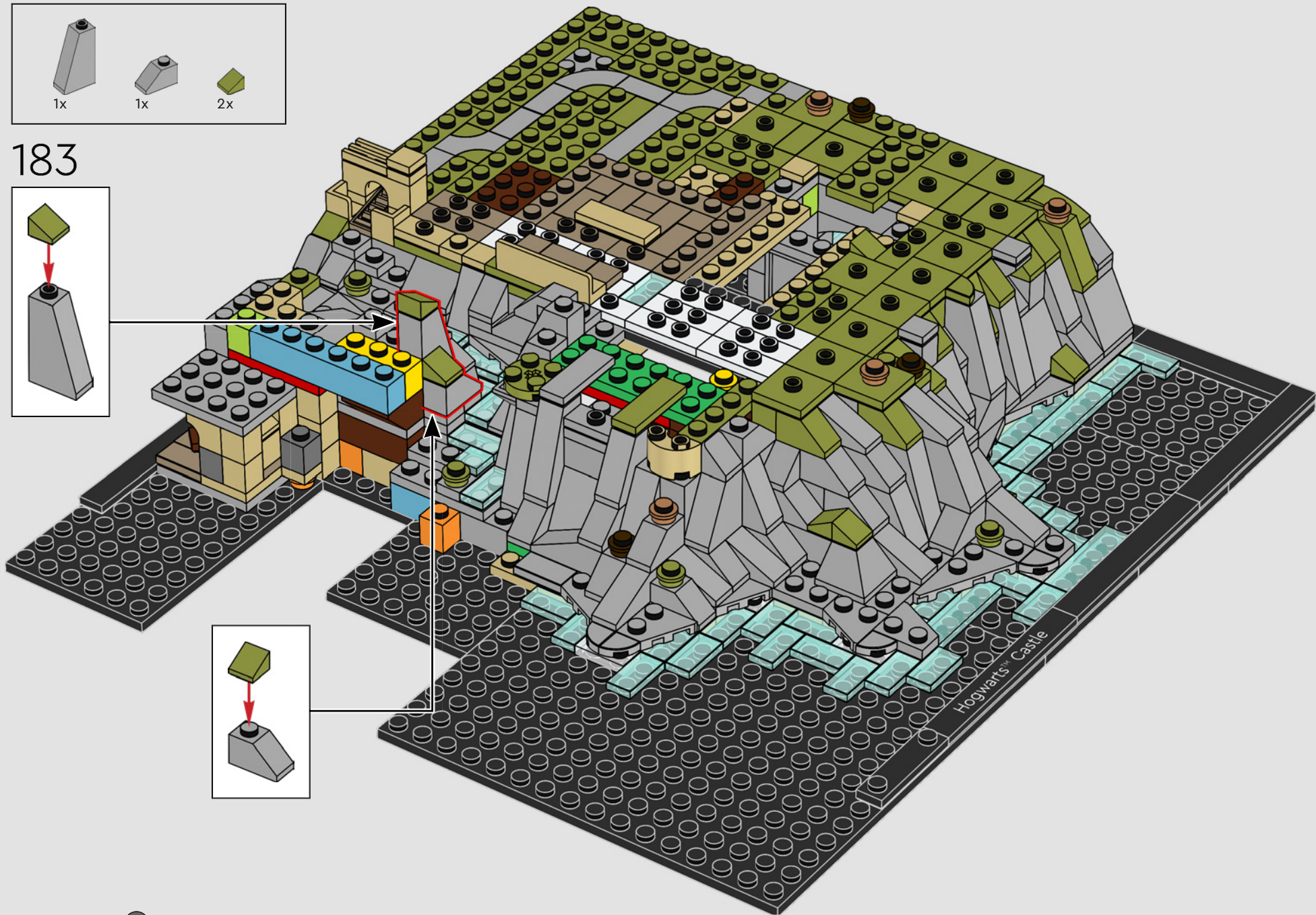
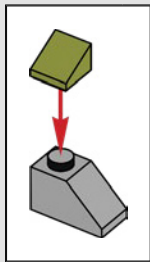
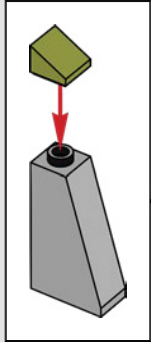



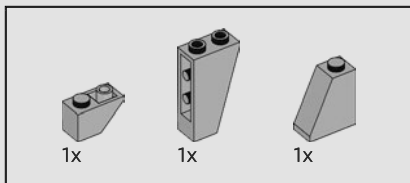

184

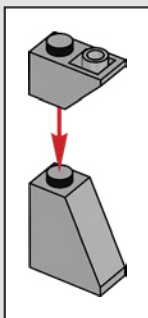

Secondo la leggenda, fu Priscilla Corvono a chiamare il castello Hogwarts™ dopo aver sognato un cinghiale dalle verruche che la condusse nell'ambientazione perfetta. Questo però non è mai stato confermato.



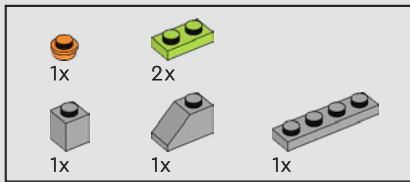

185





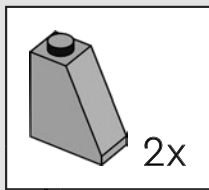
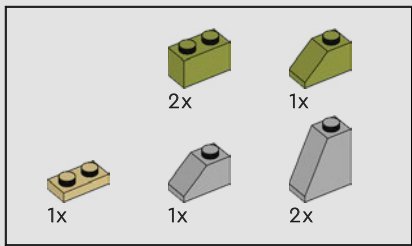

186





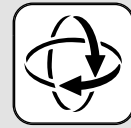
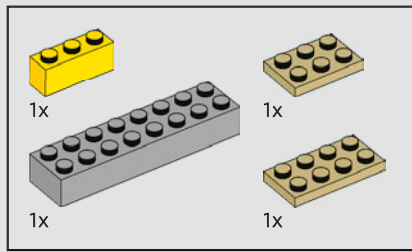

187

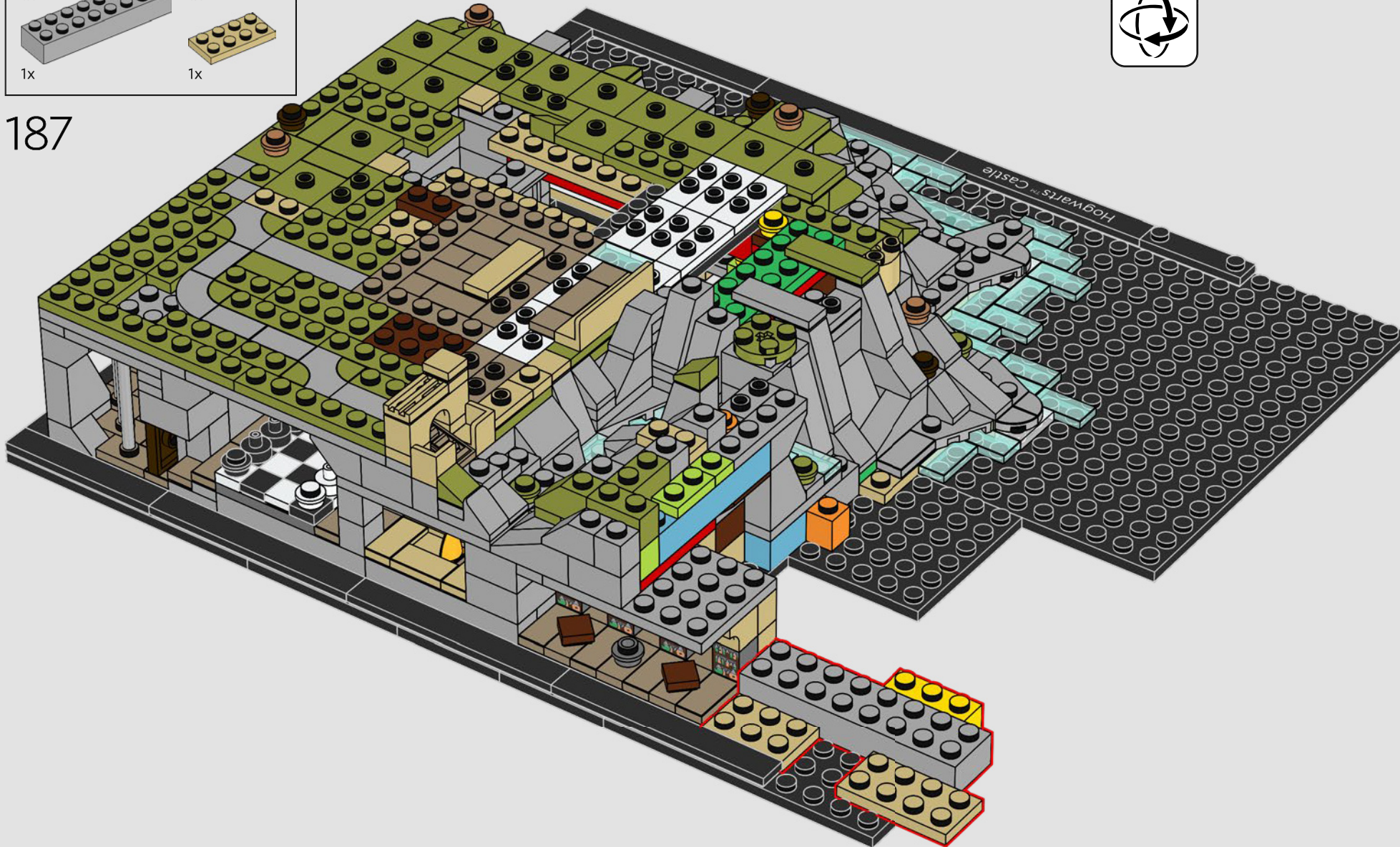



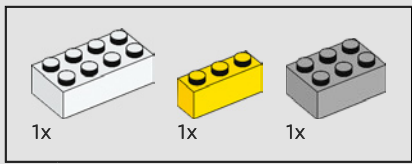

188

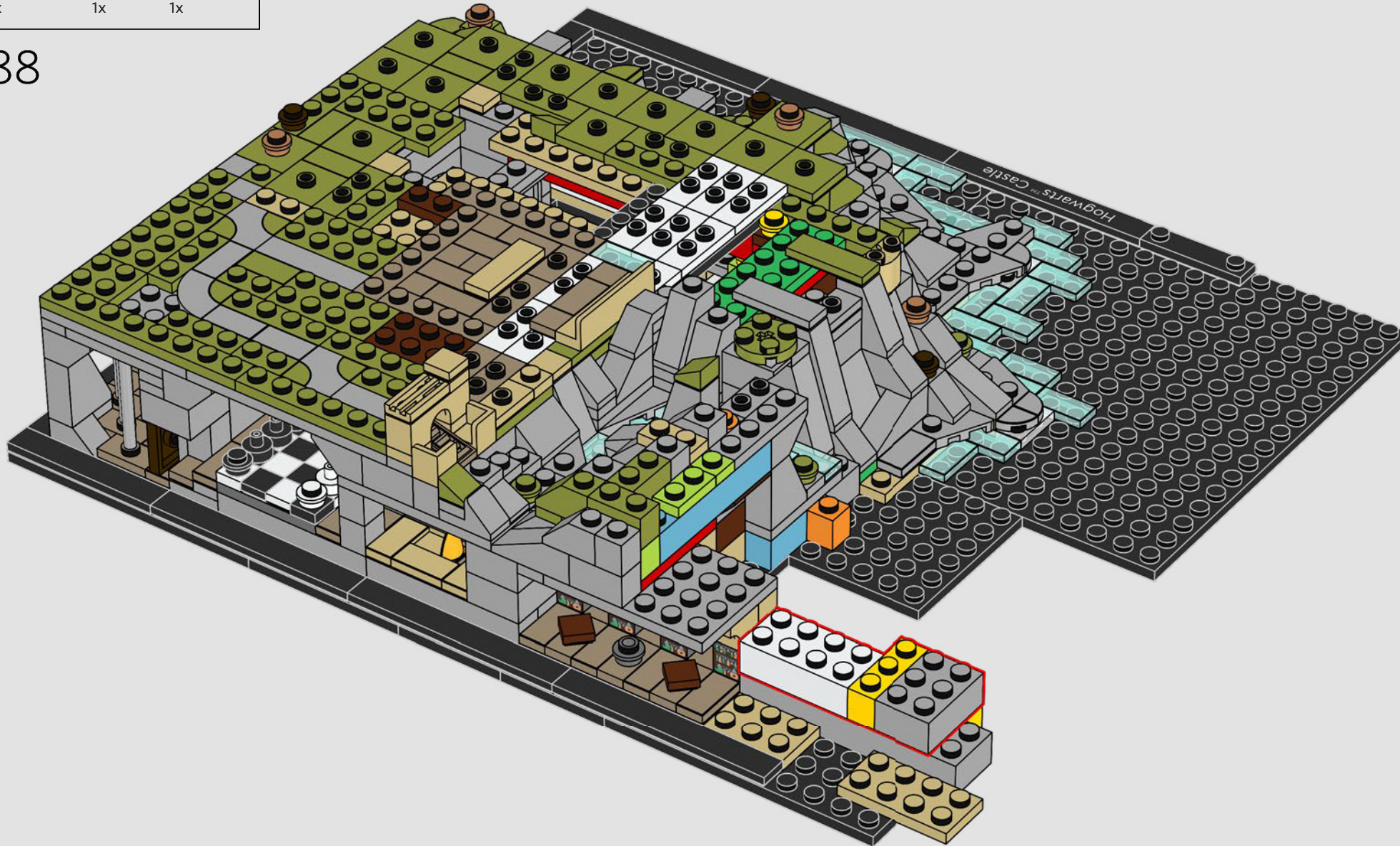

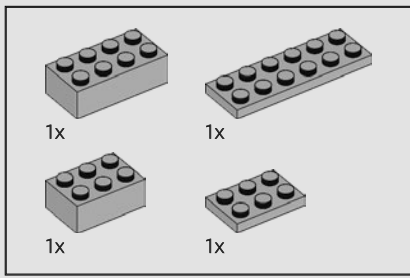

189

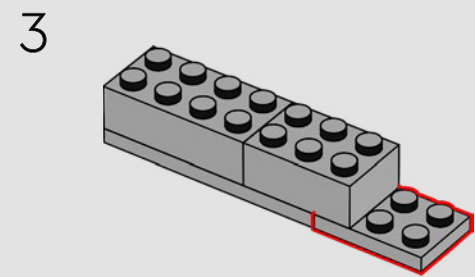
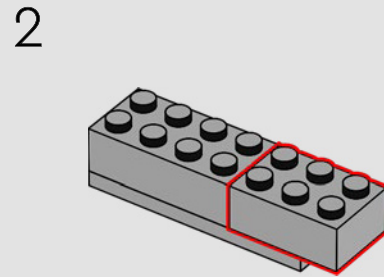
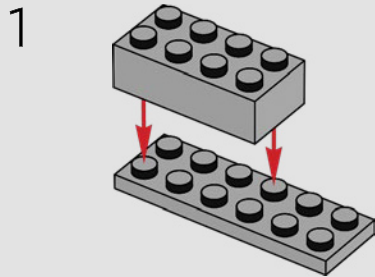



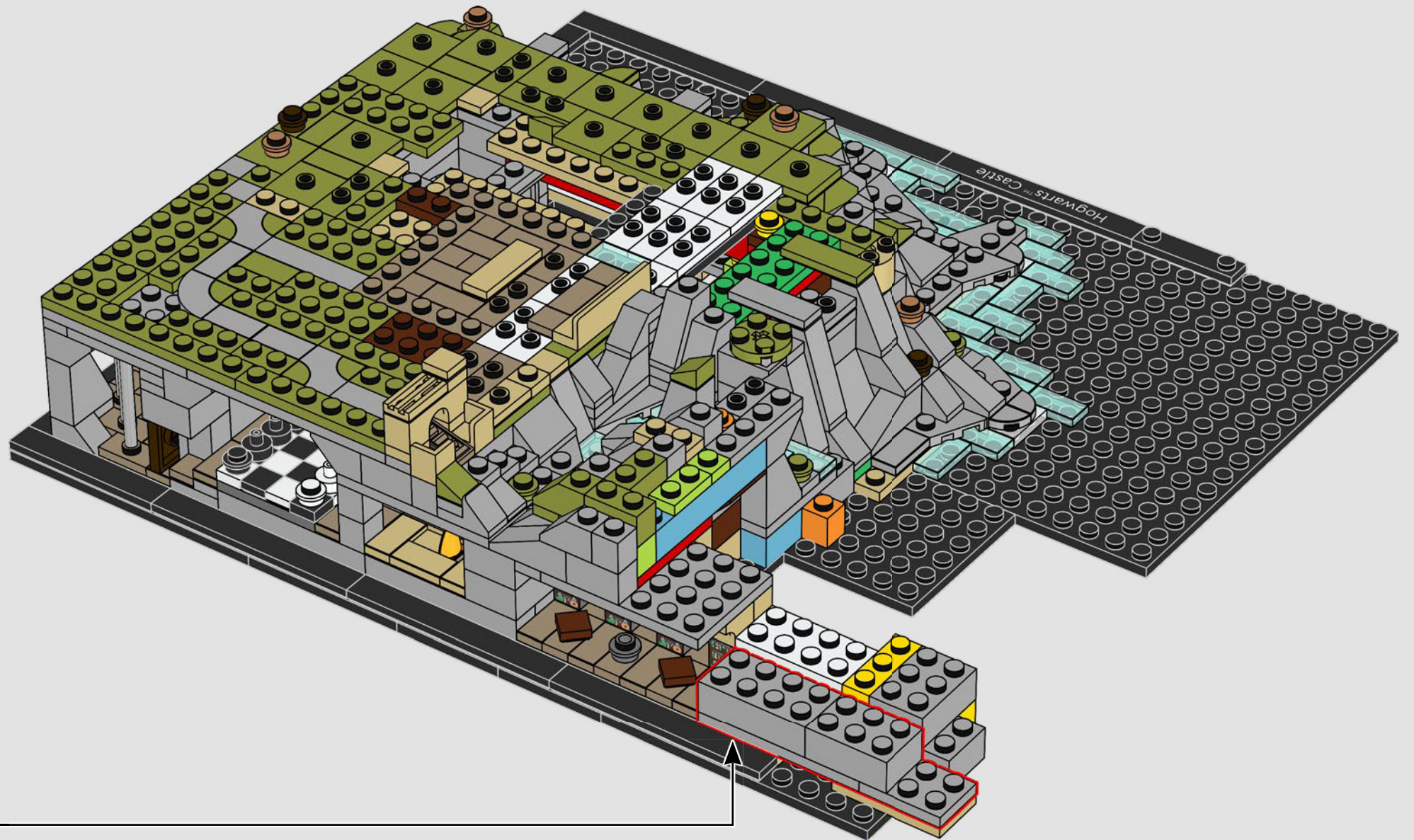



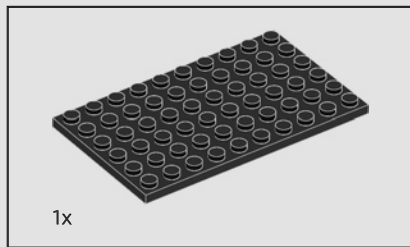

1x

190

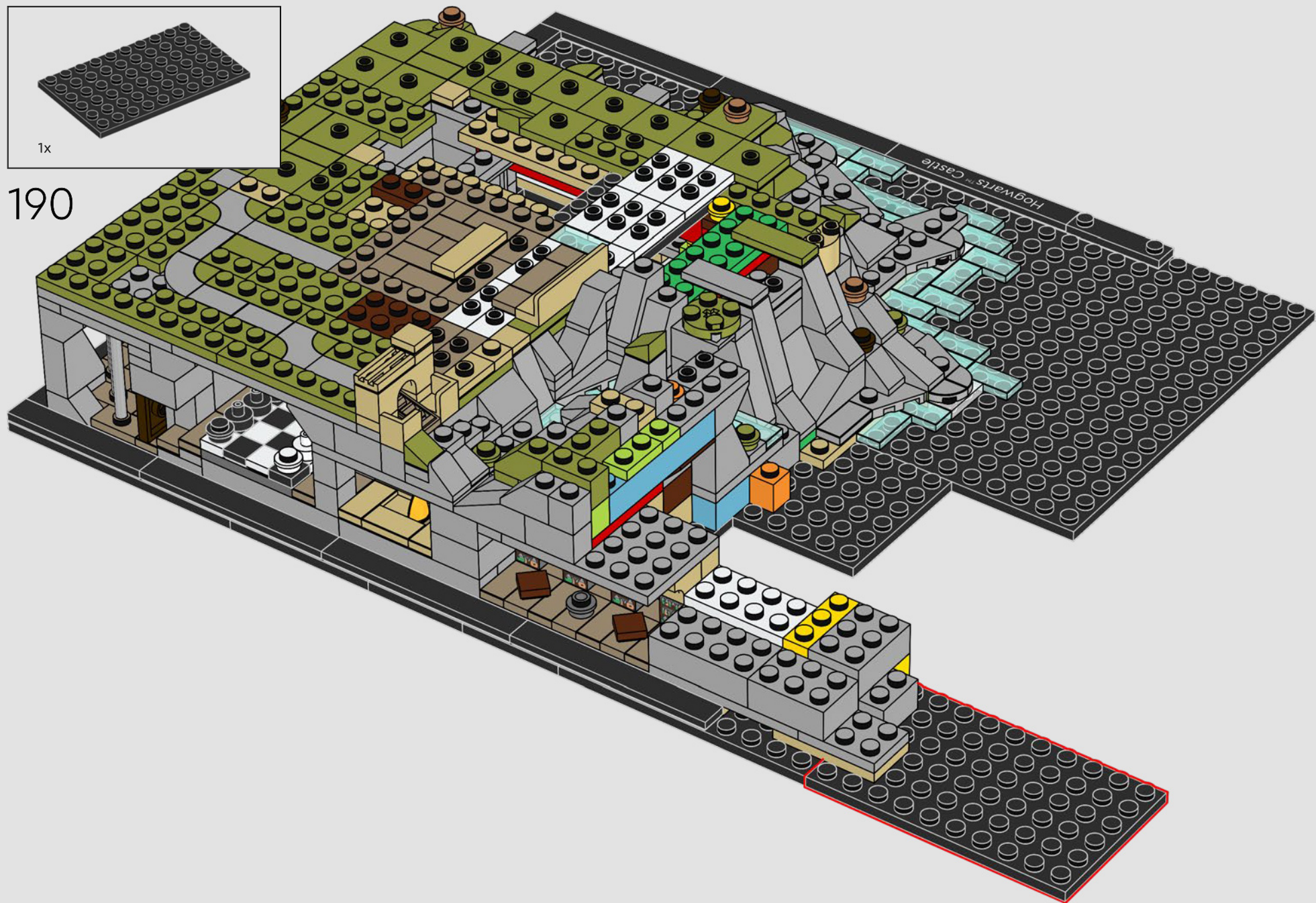



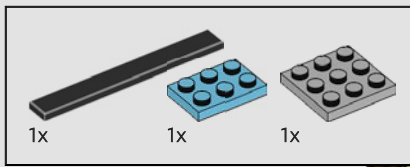

191

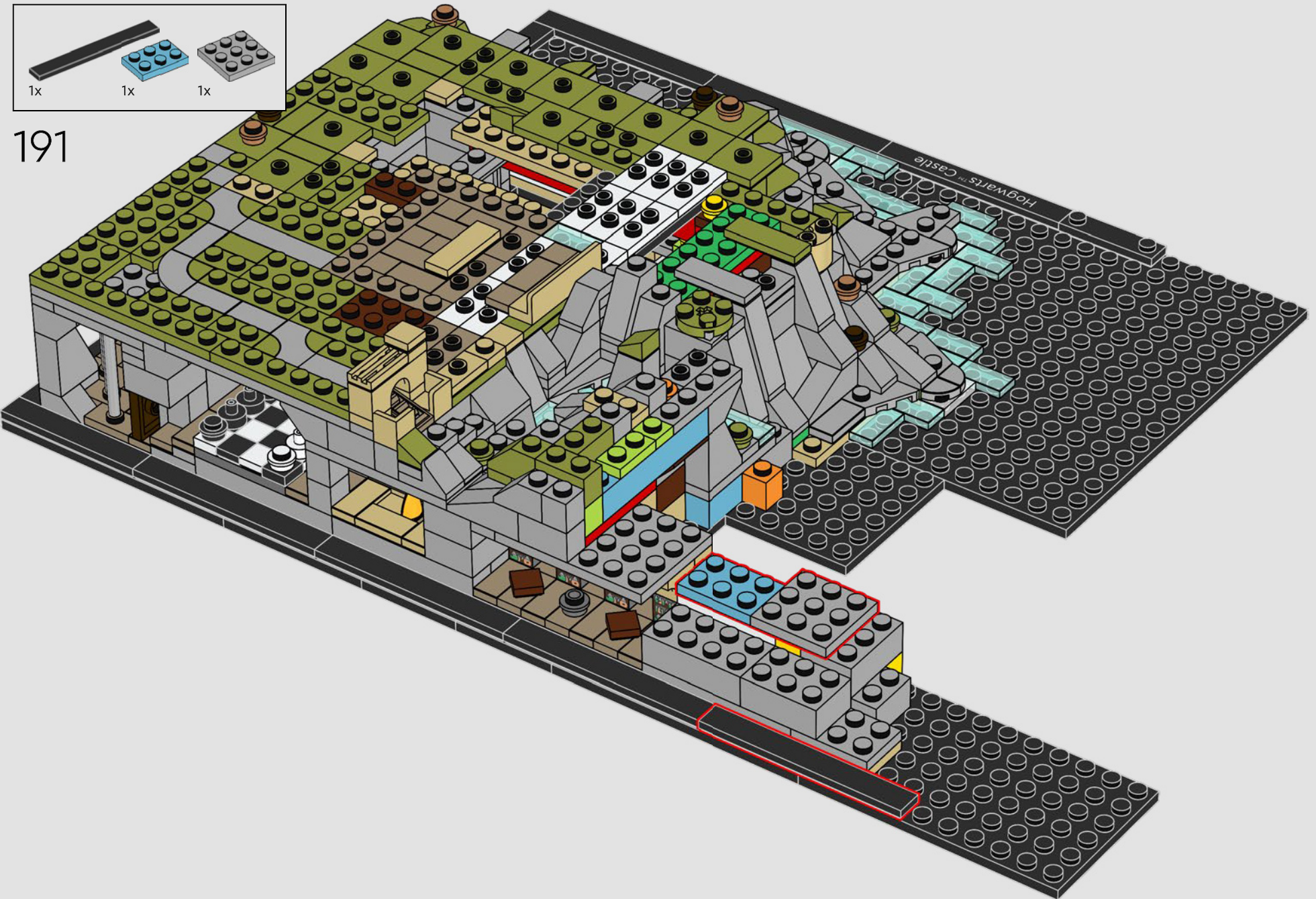





192

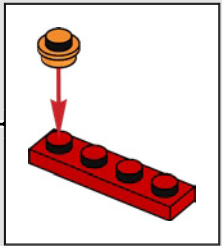
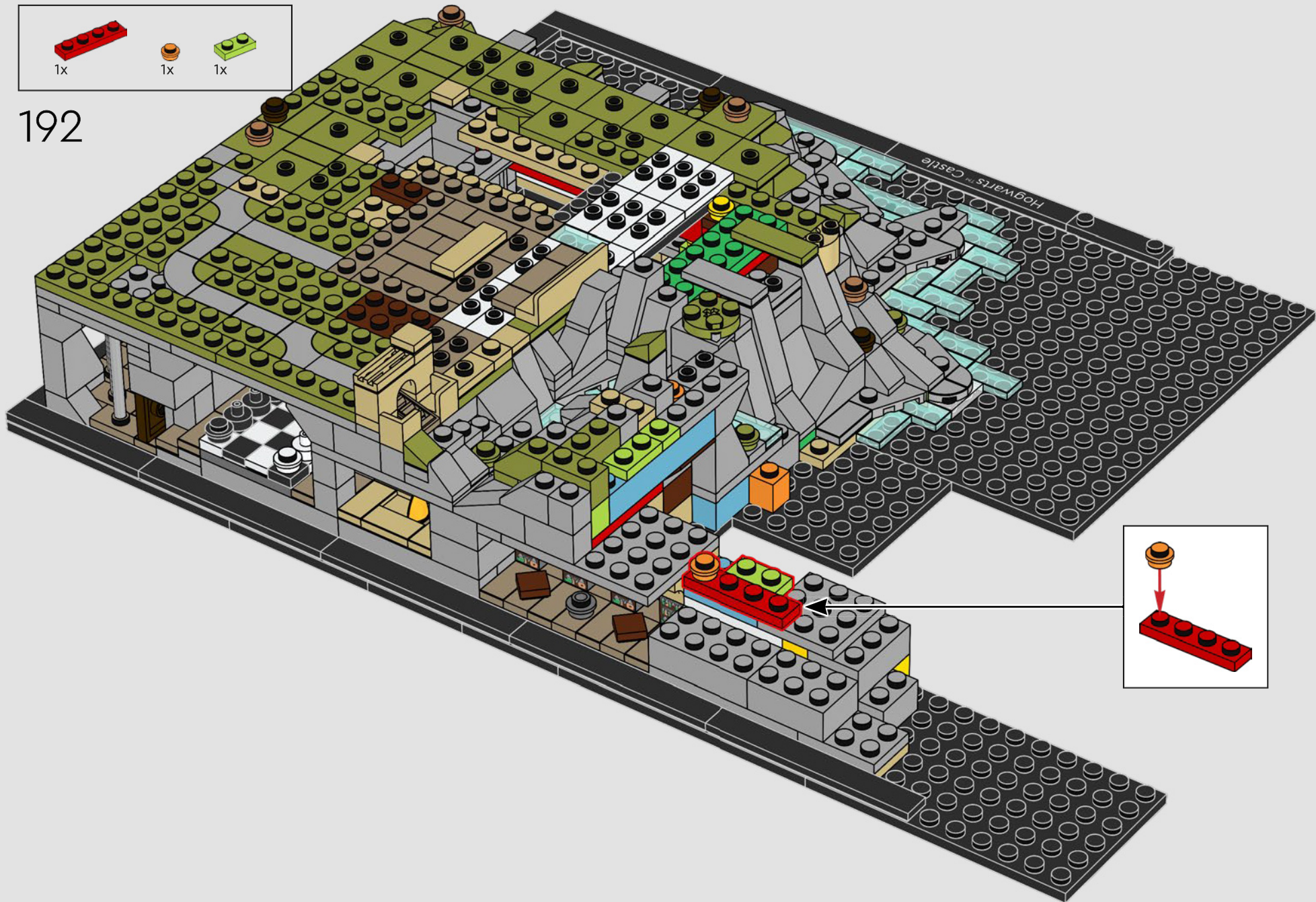



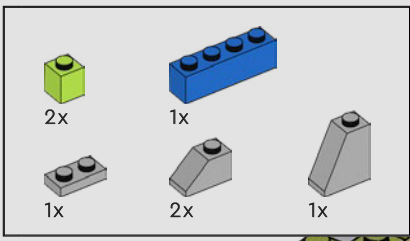

193

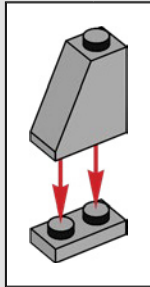
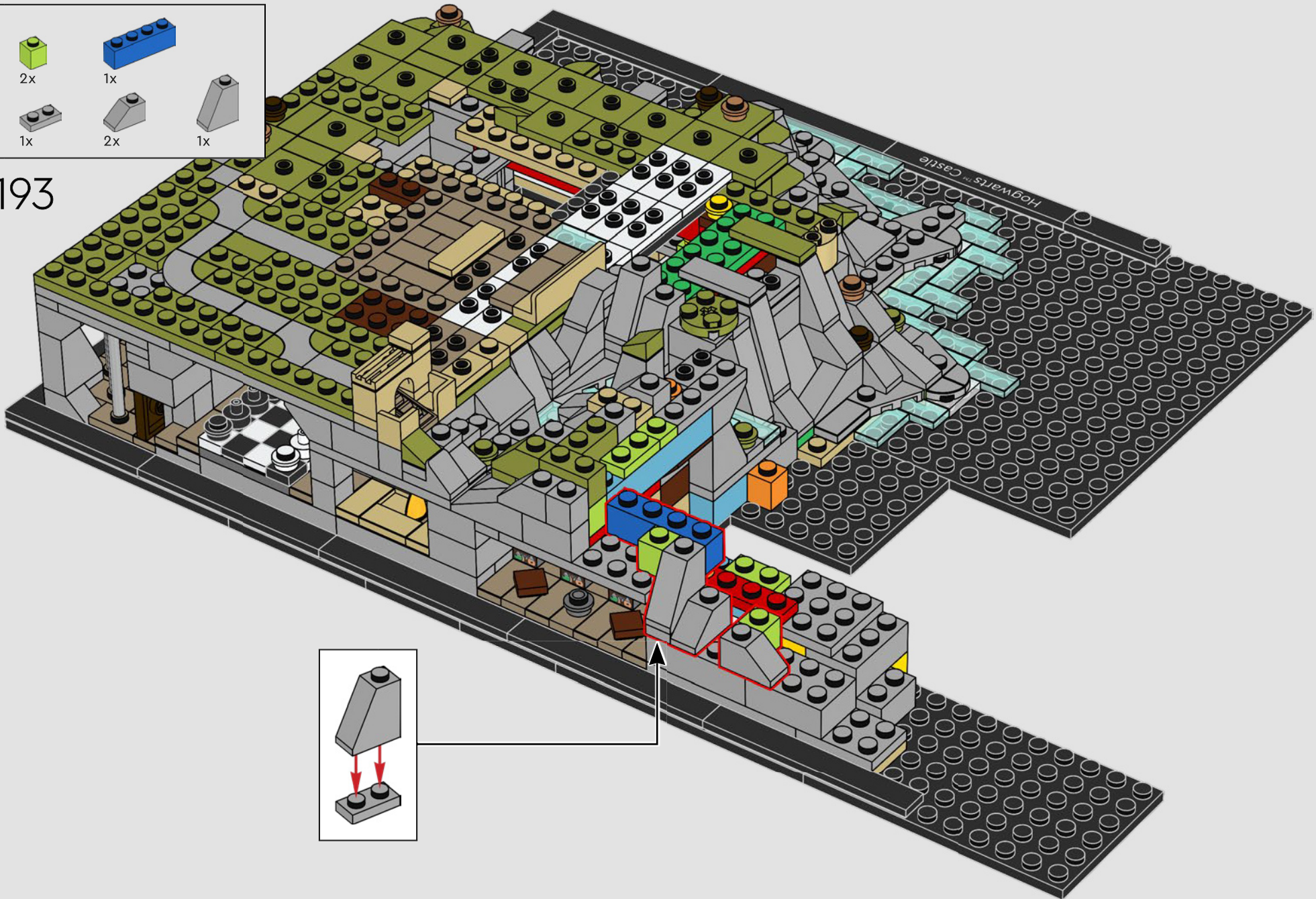



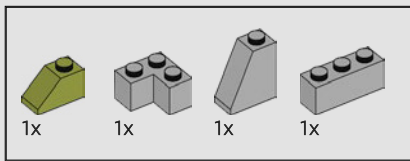

194

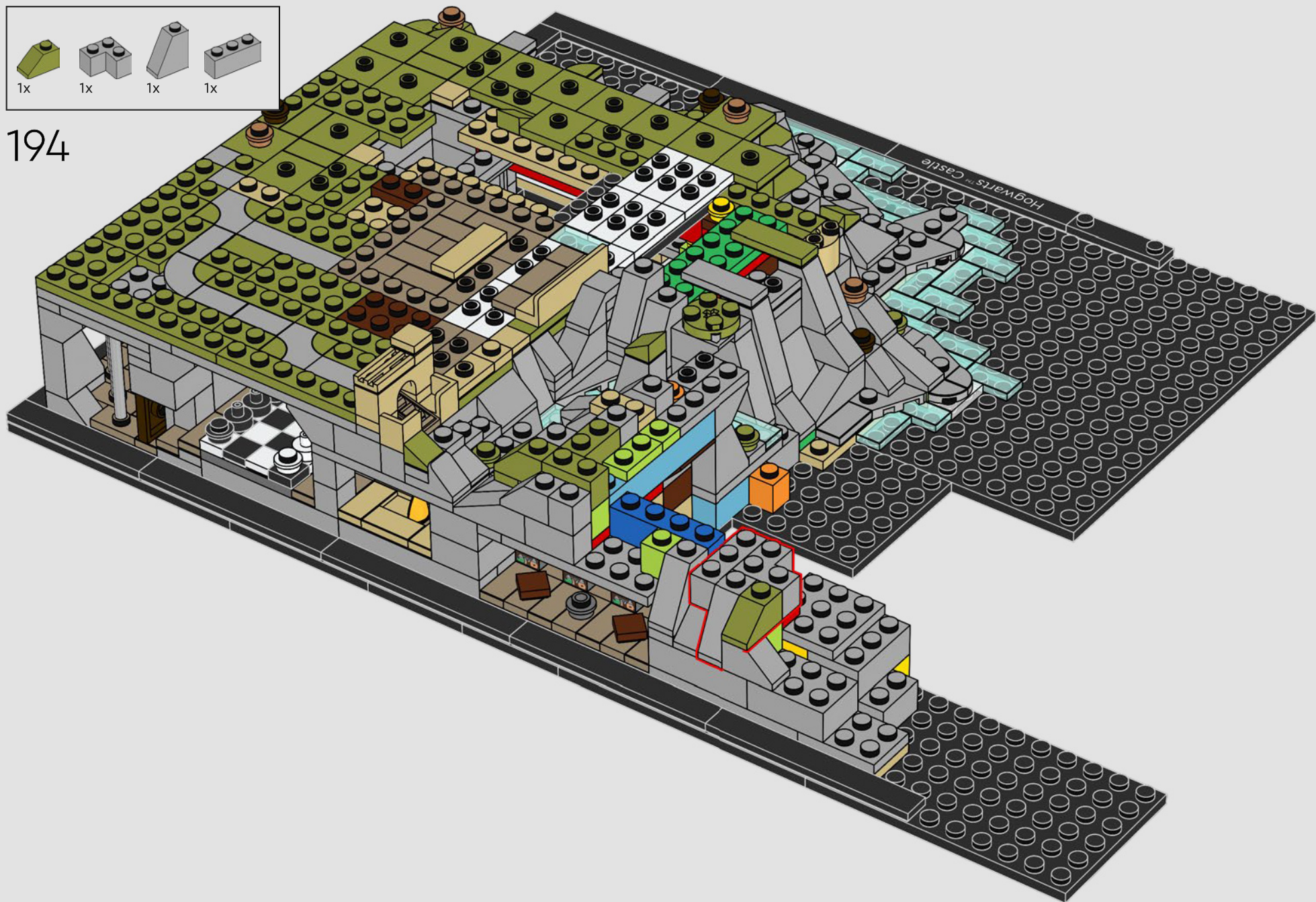



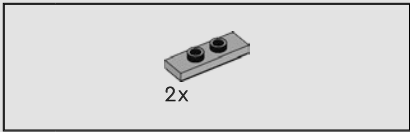

195





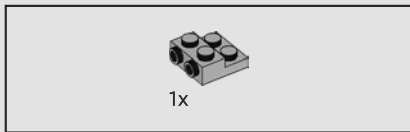

196





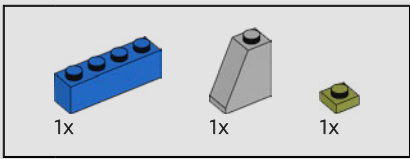

197

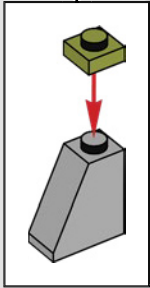



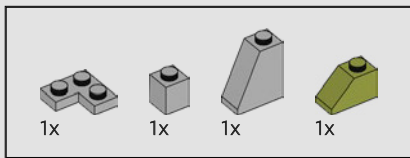

198

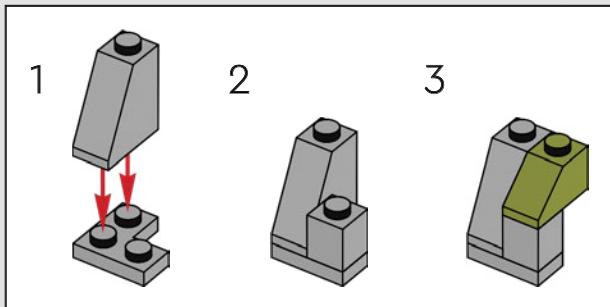
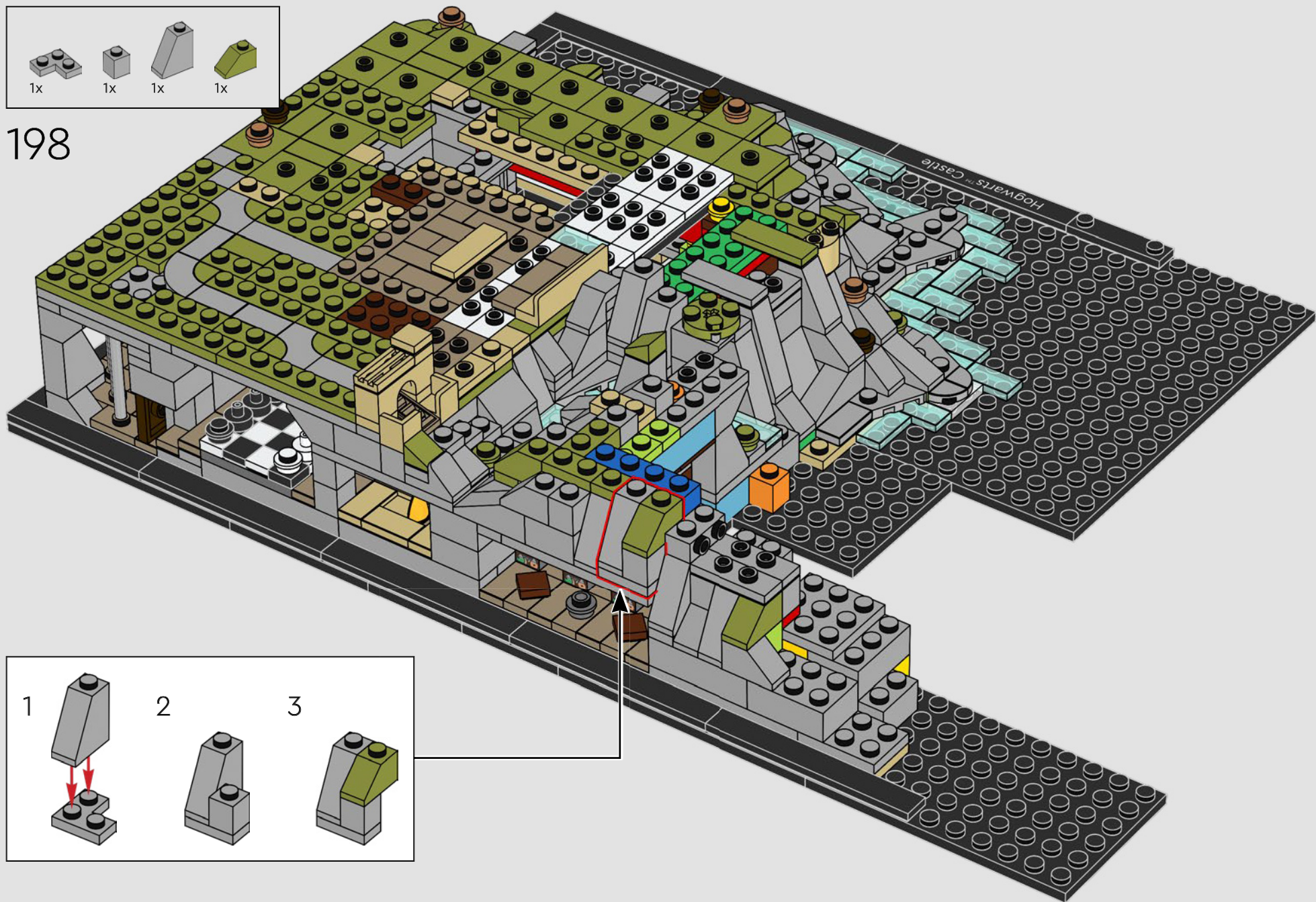



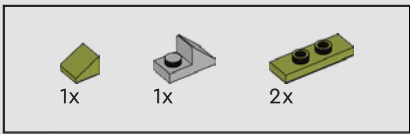

199

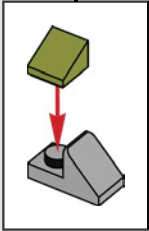



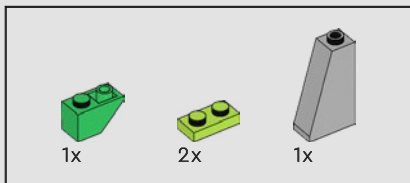

200

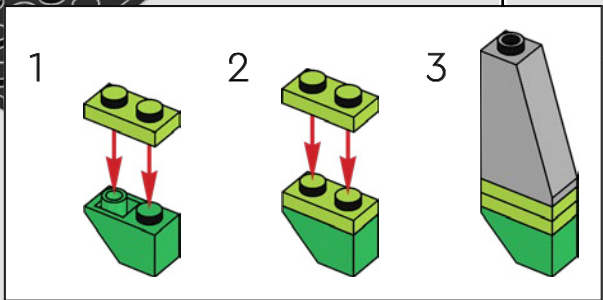
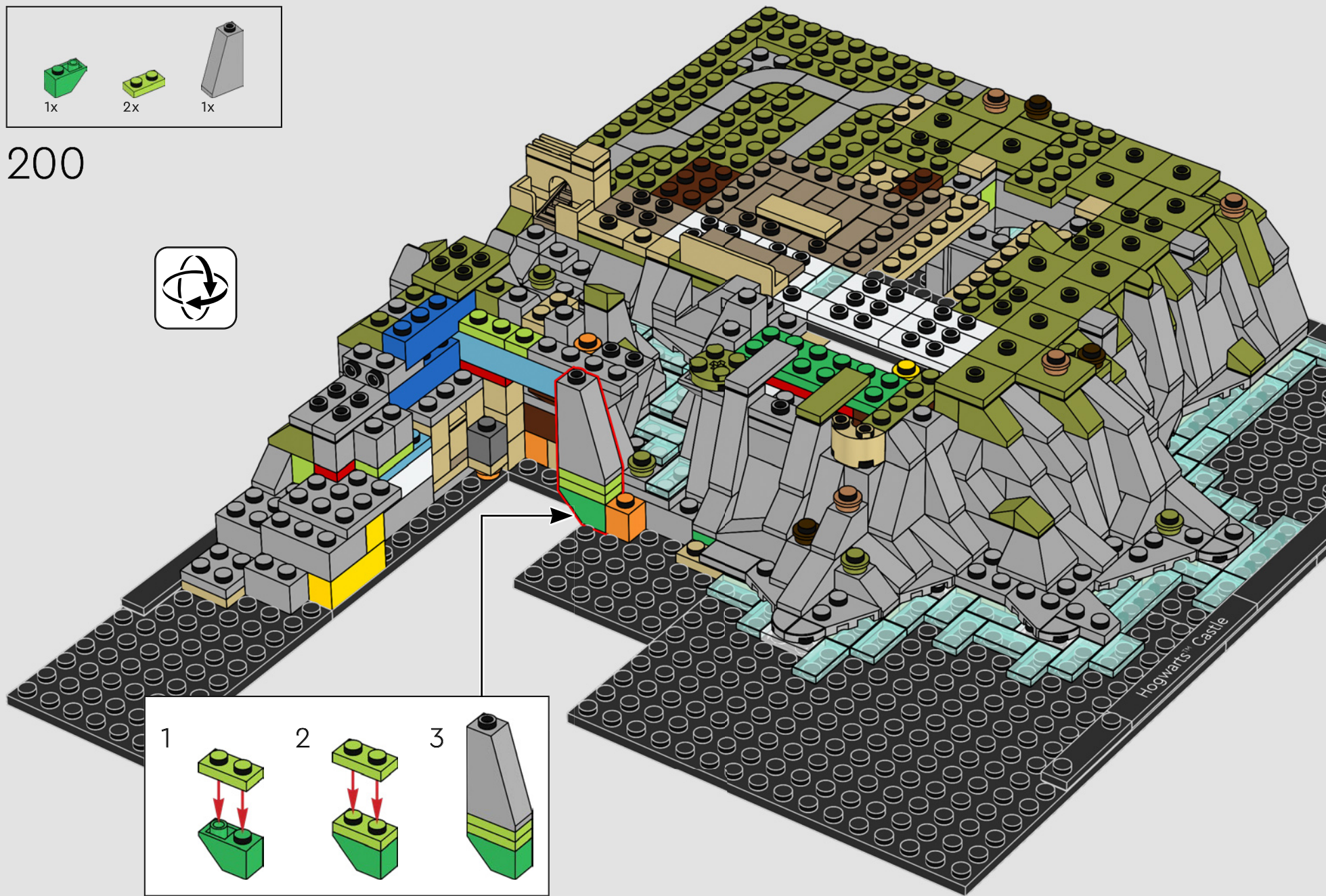
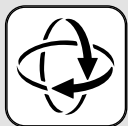



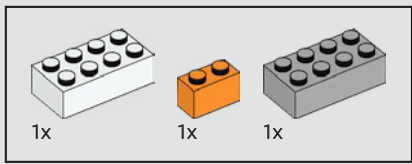

201





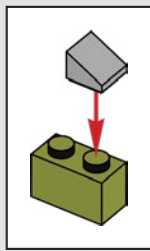
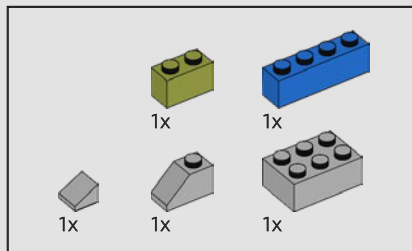

202

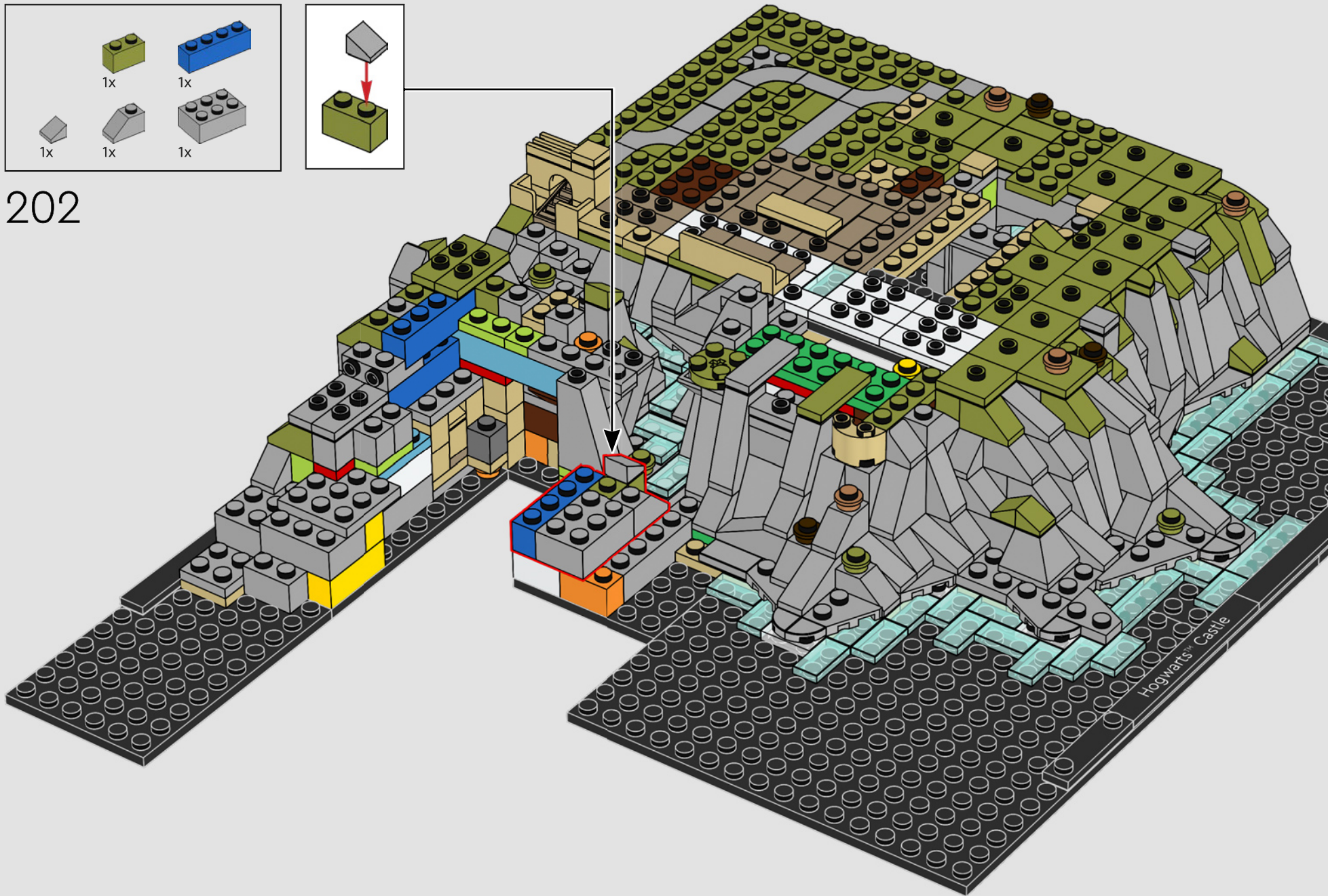



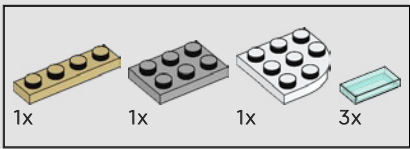

203

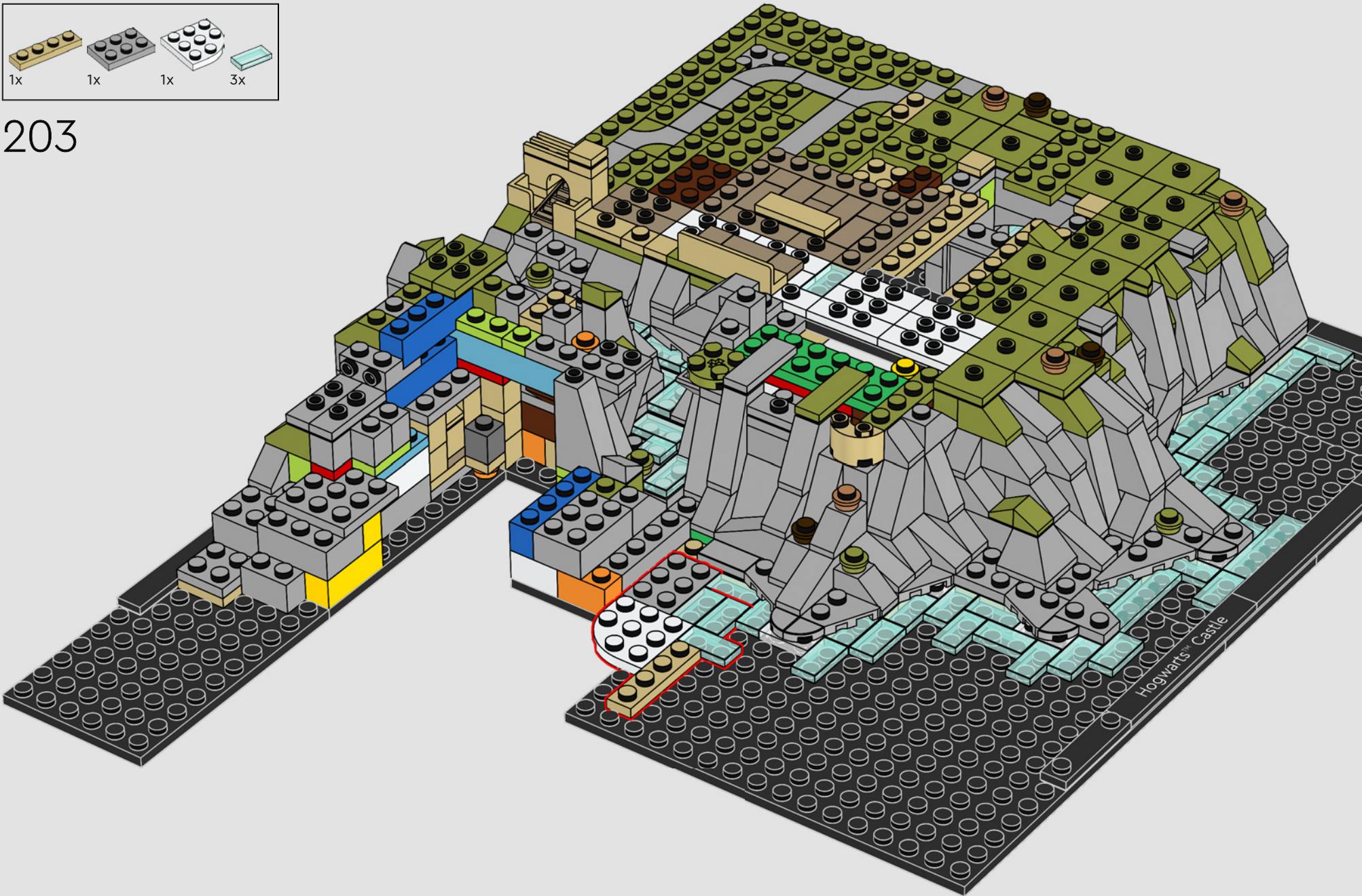



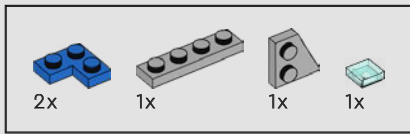

204

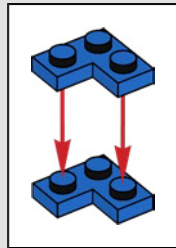
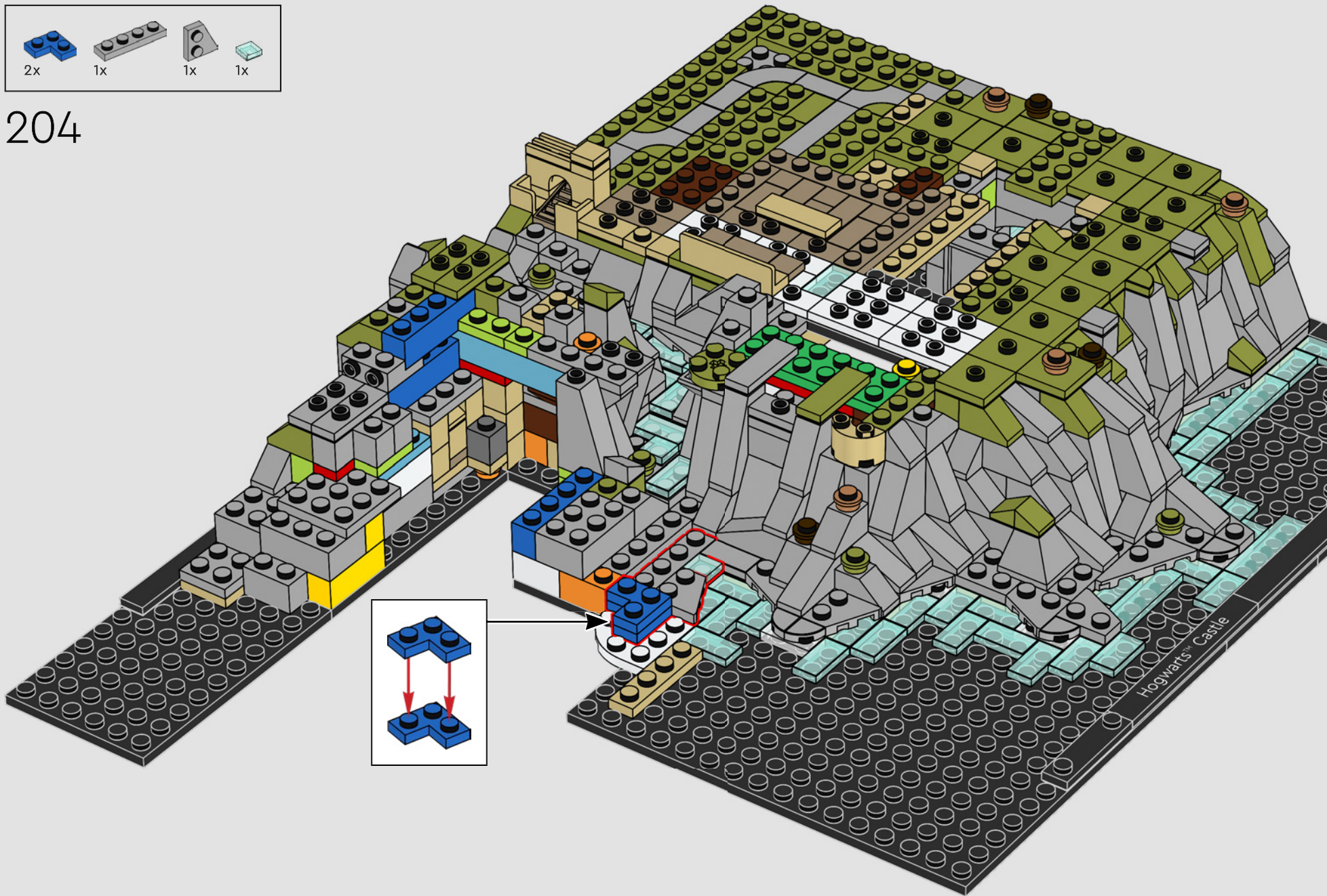



1x	1x	2x

205





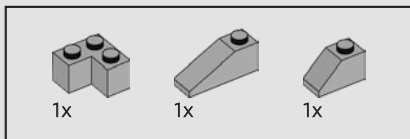

206





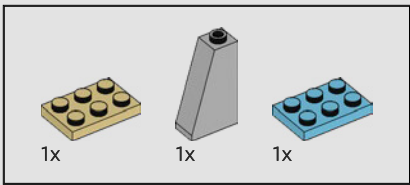

207

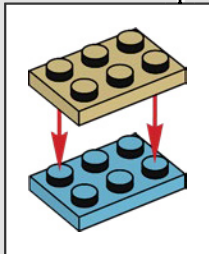
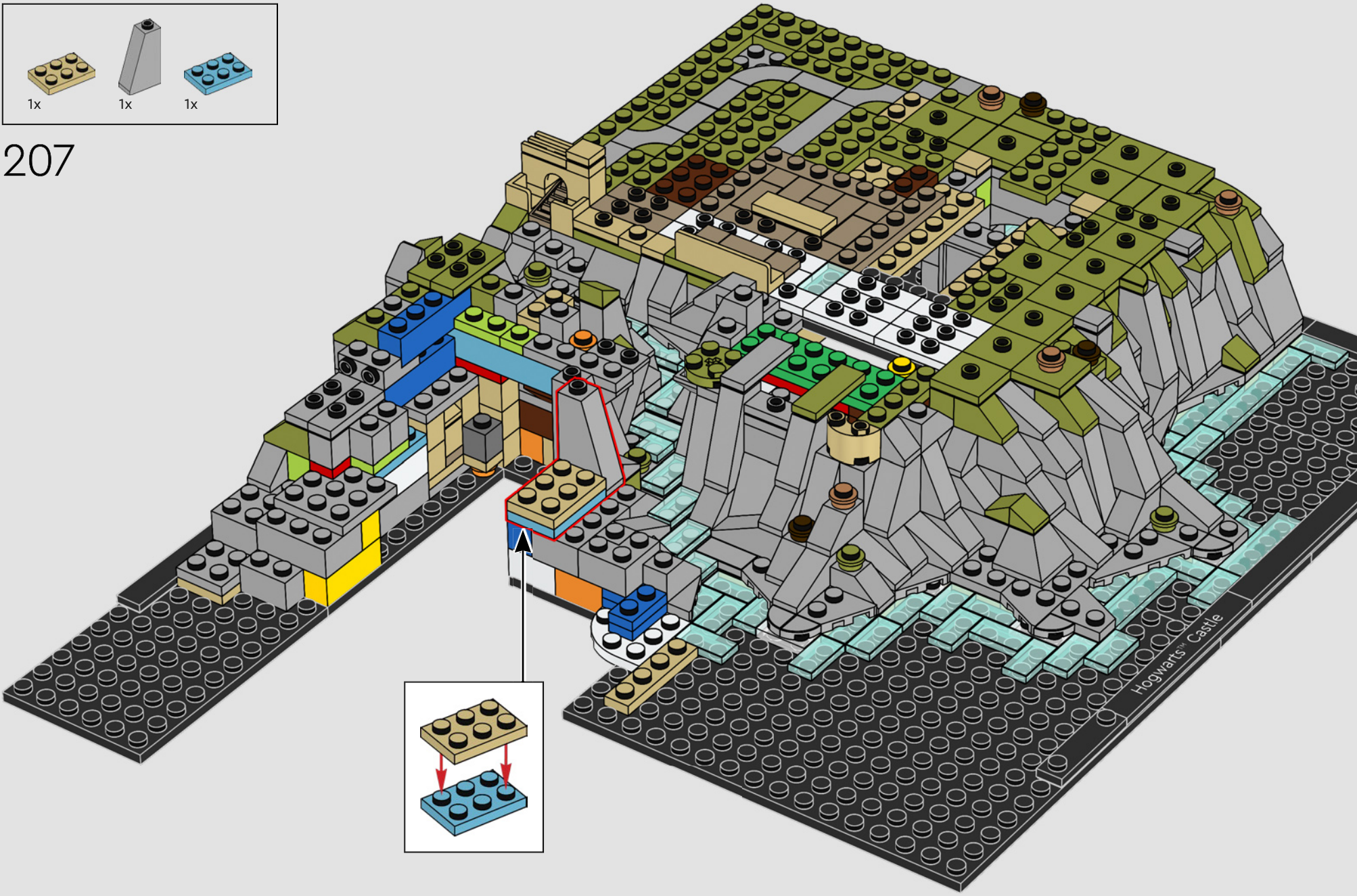



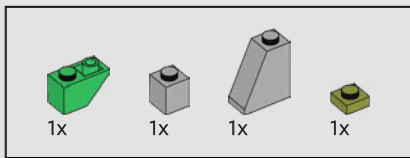

208

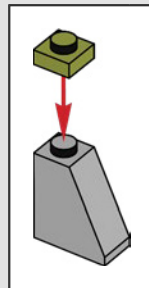
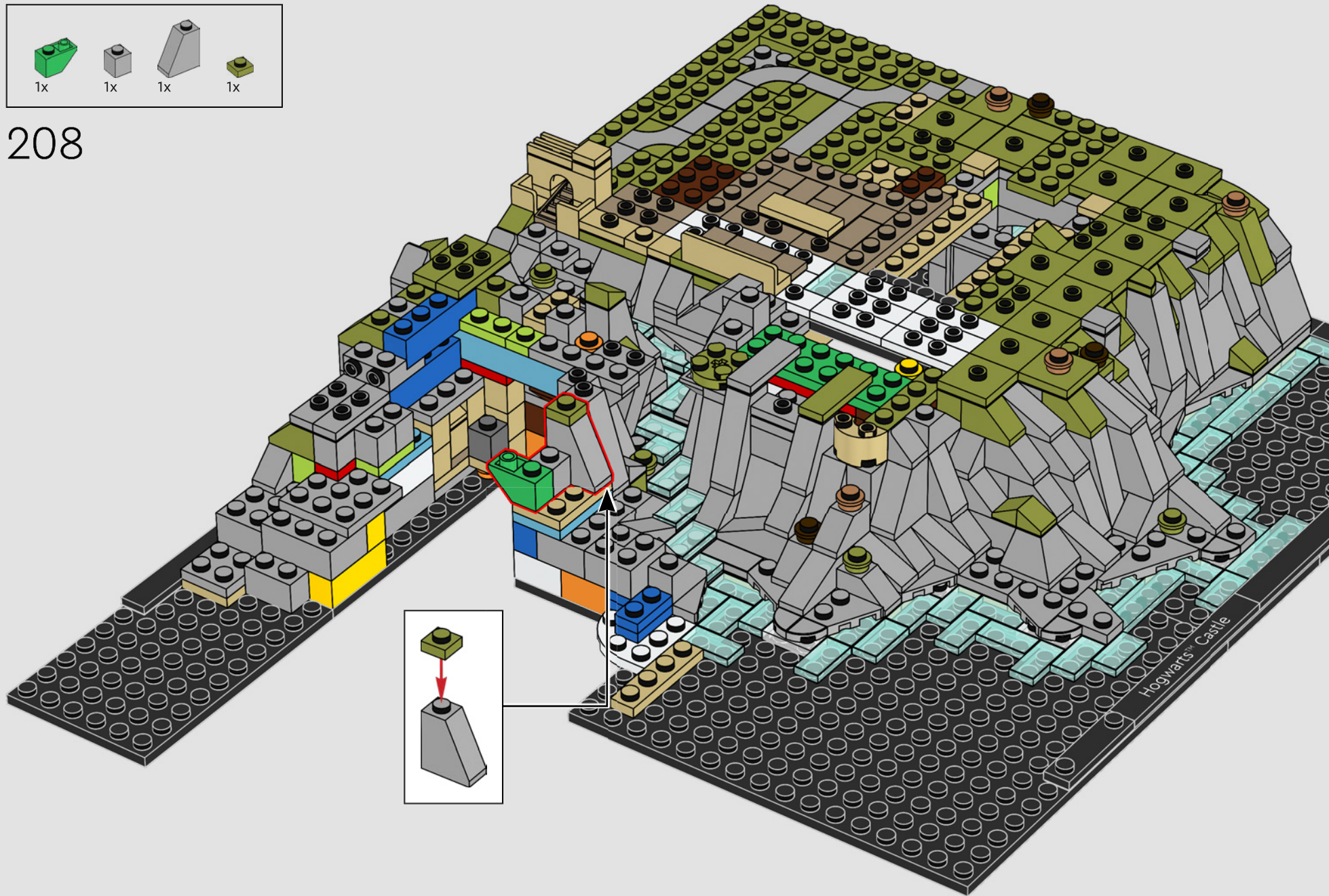



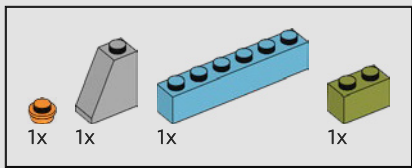

209

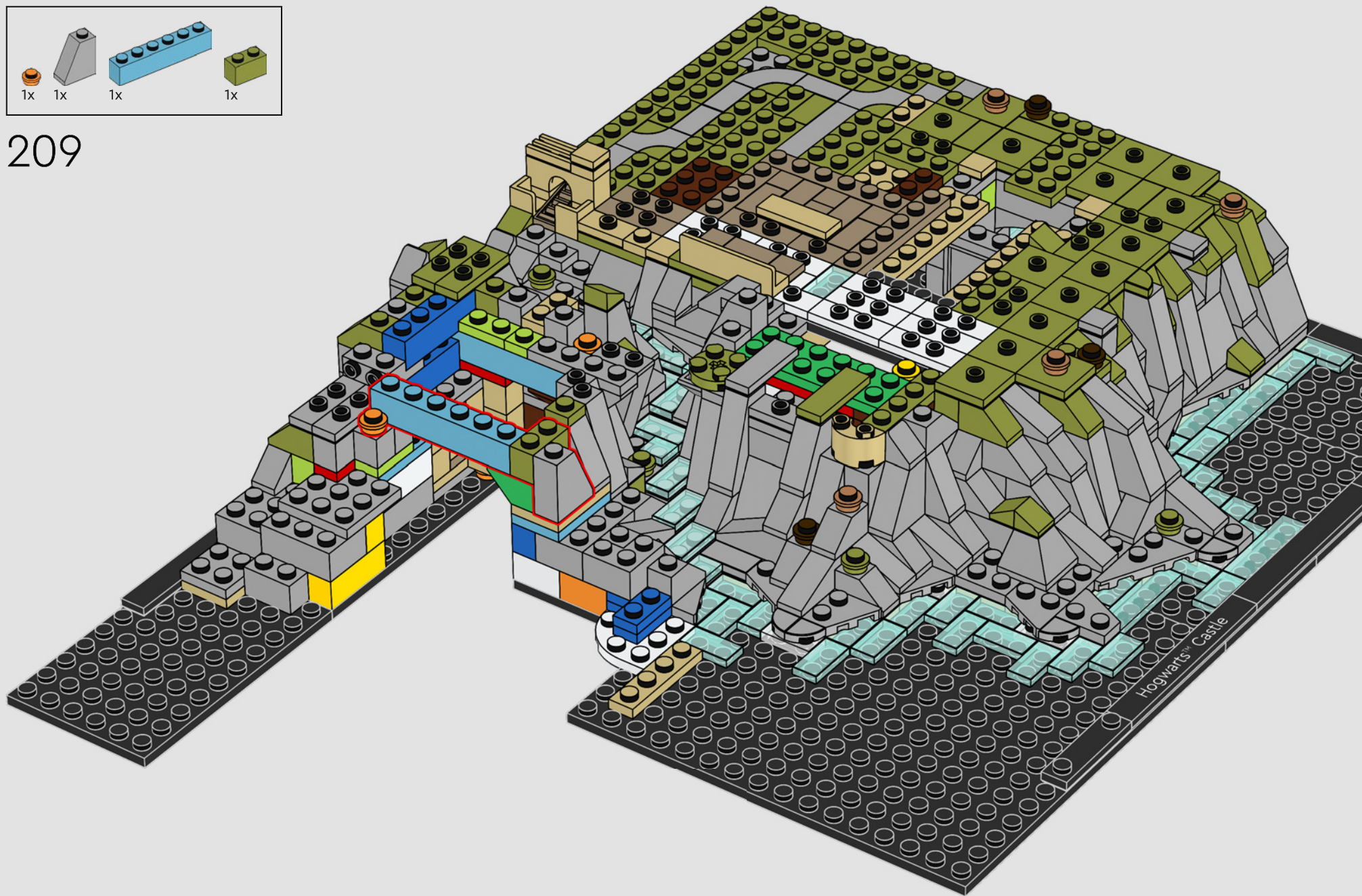



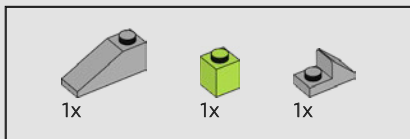

210

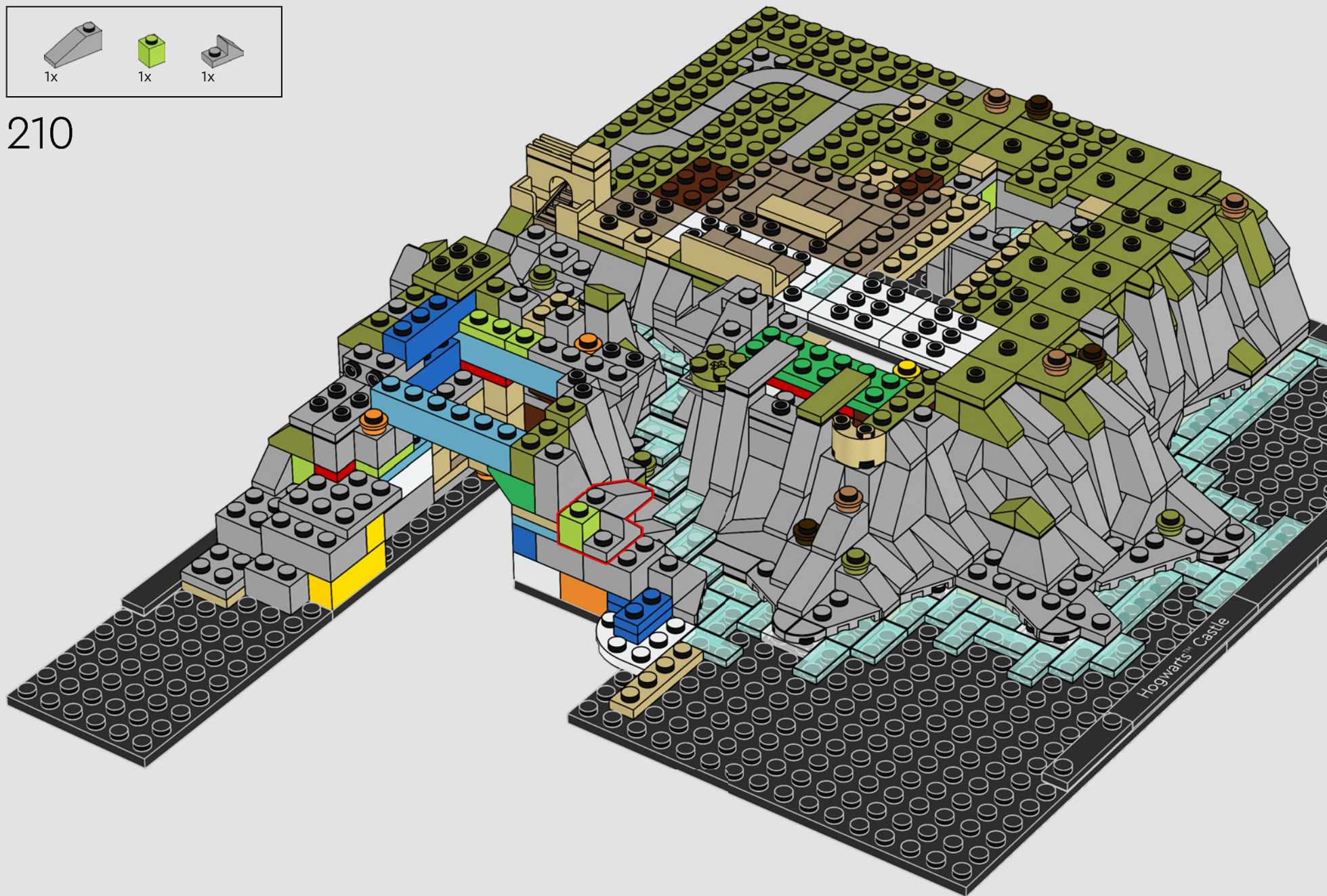



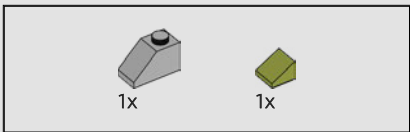

211

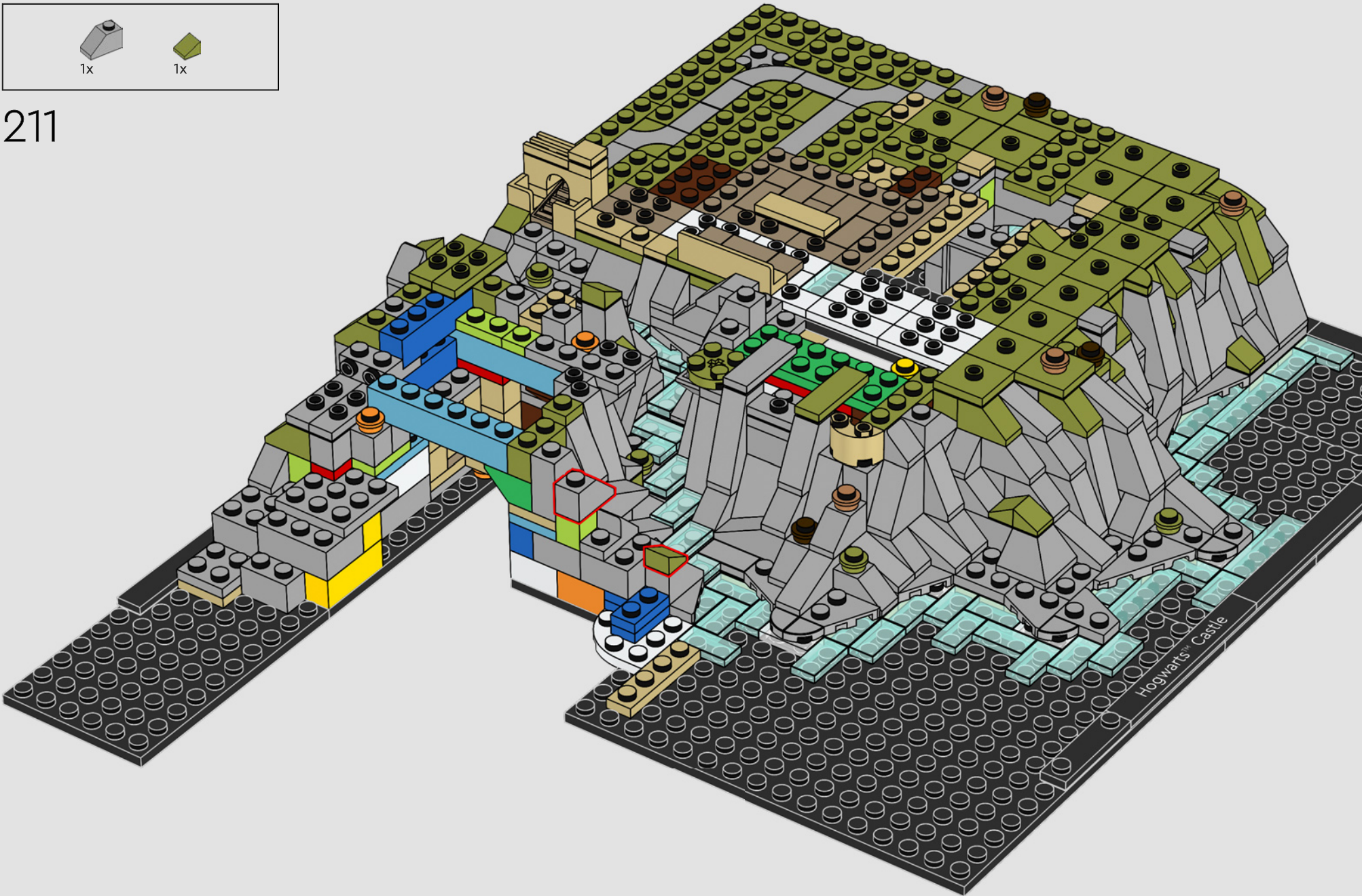





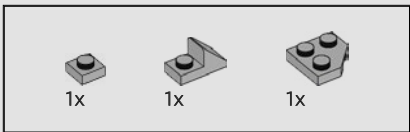

212

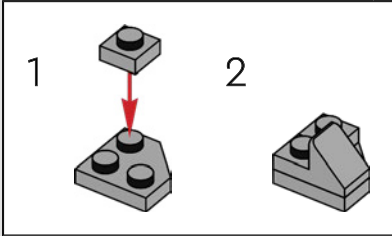
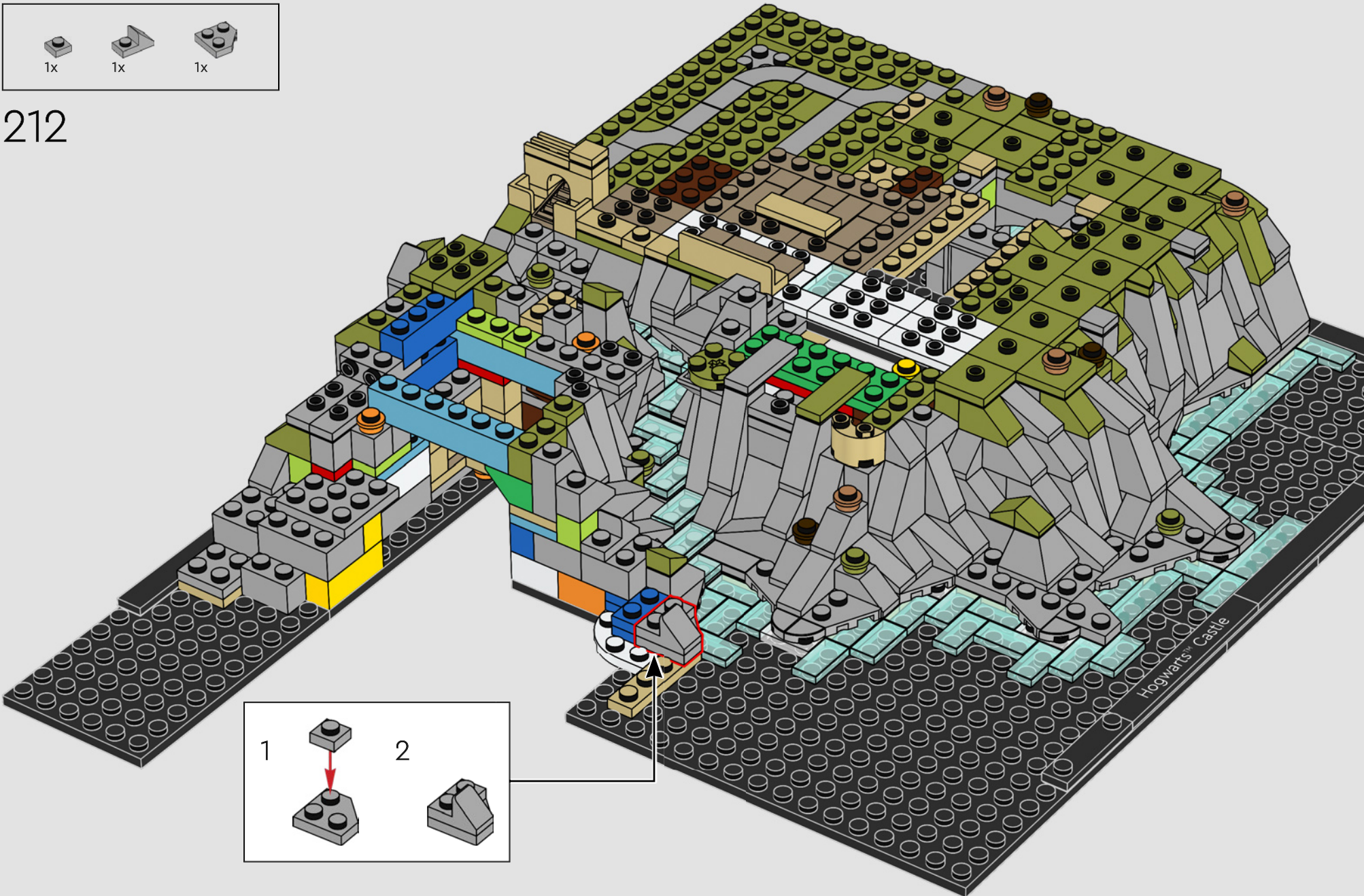



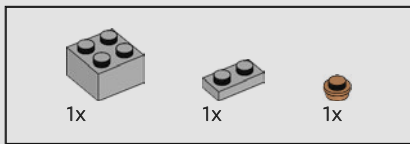

213

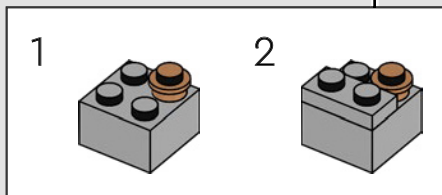
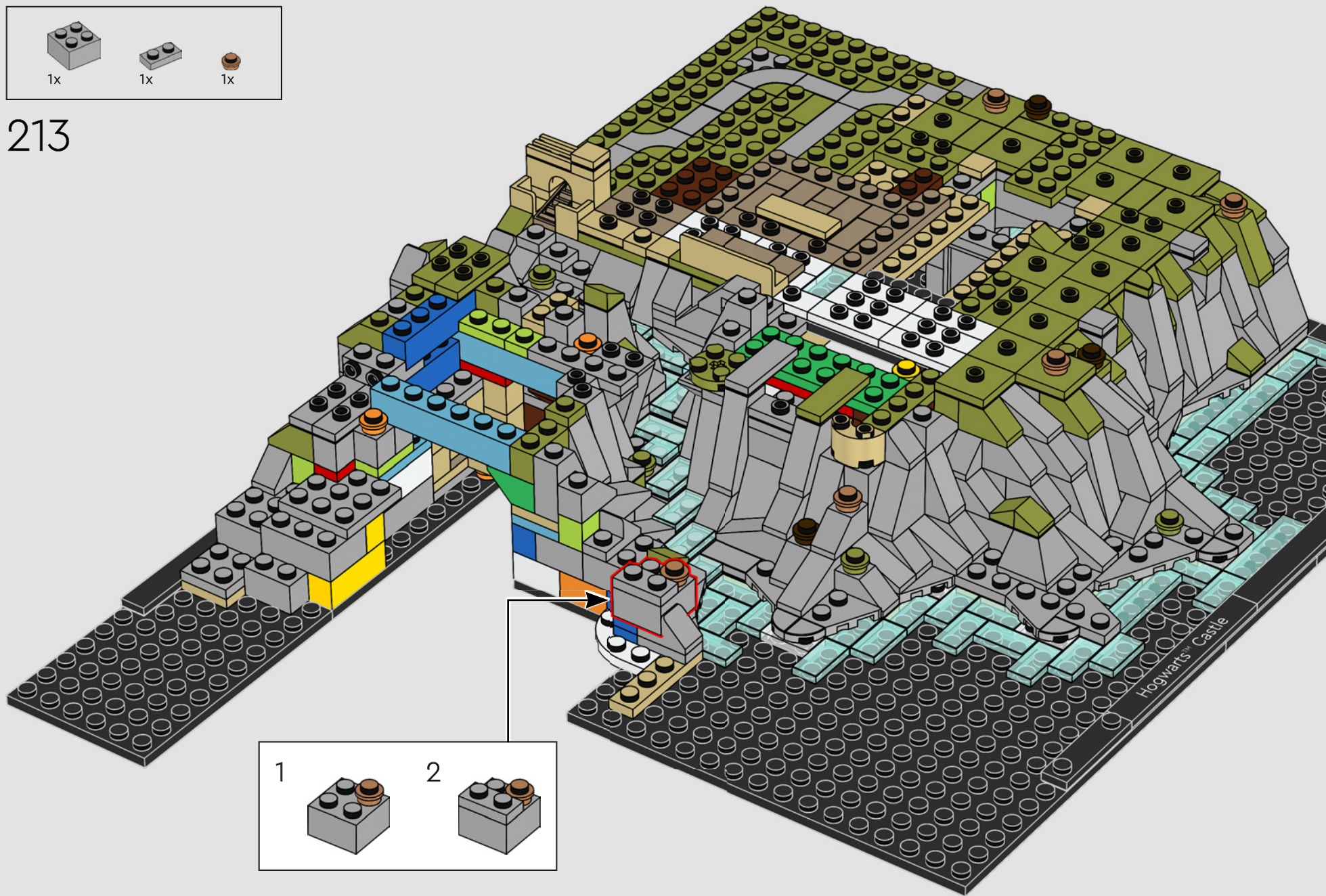



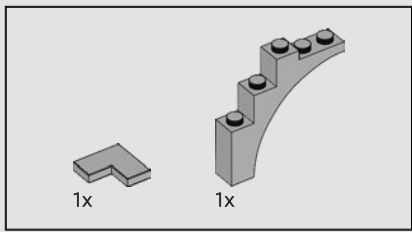

214

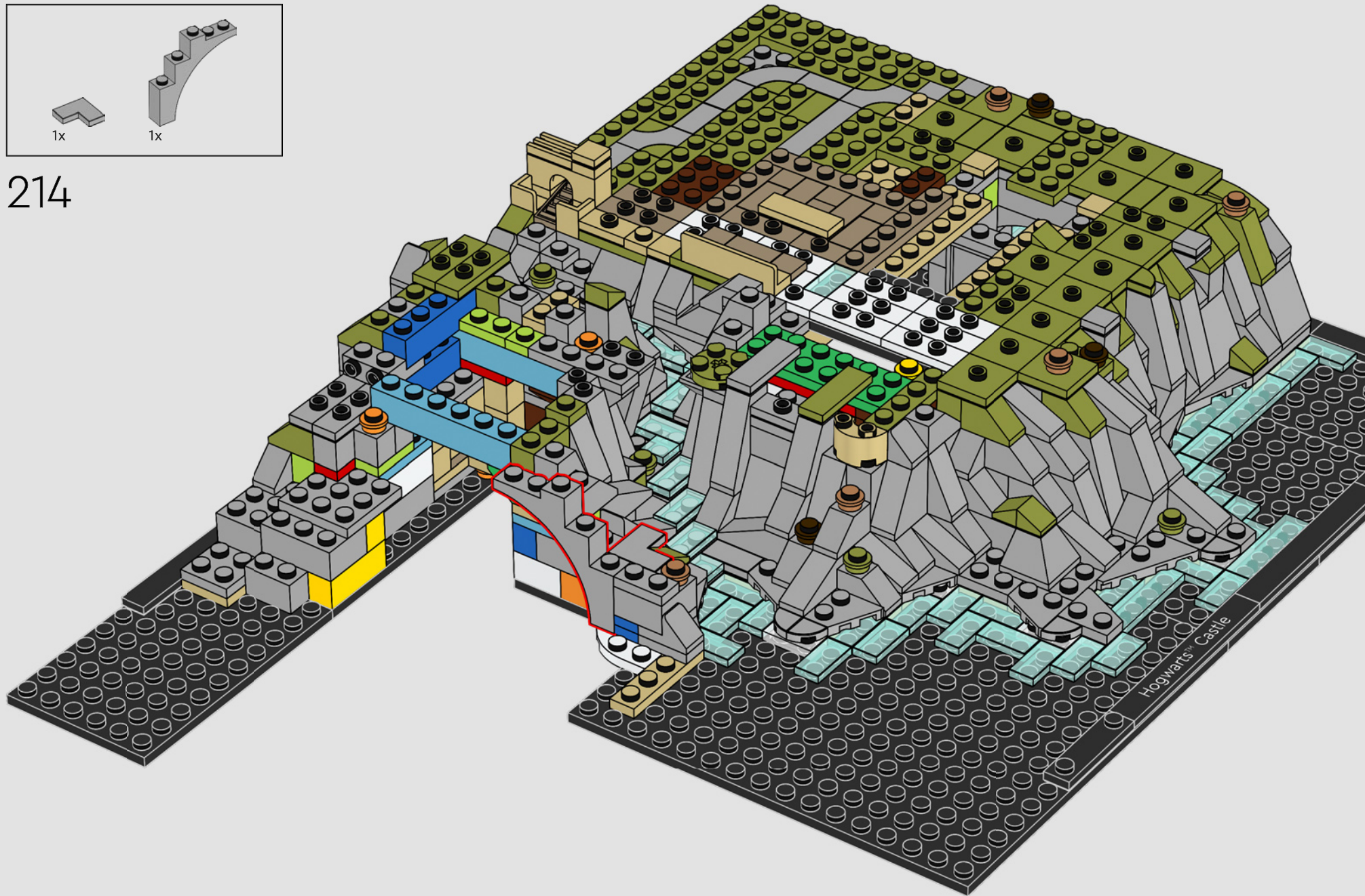



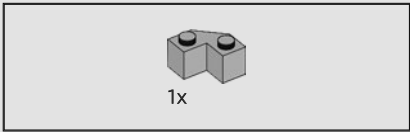

215





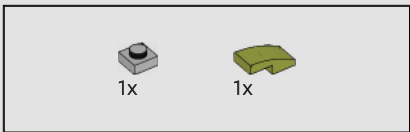

216

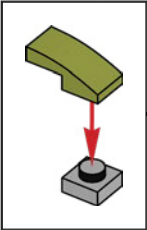
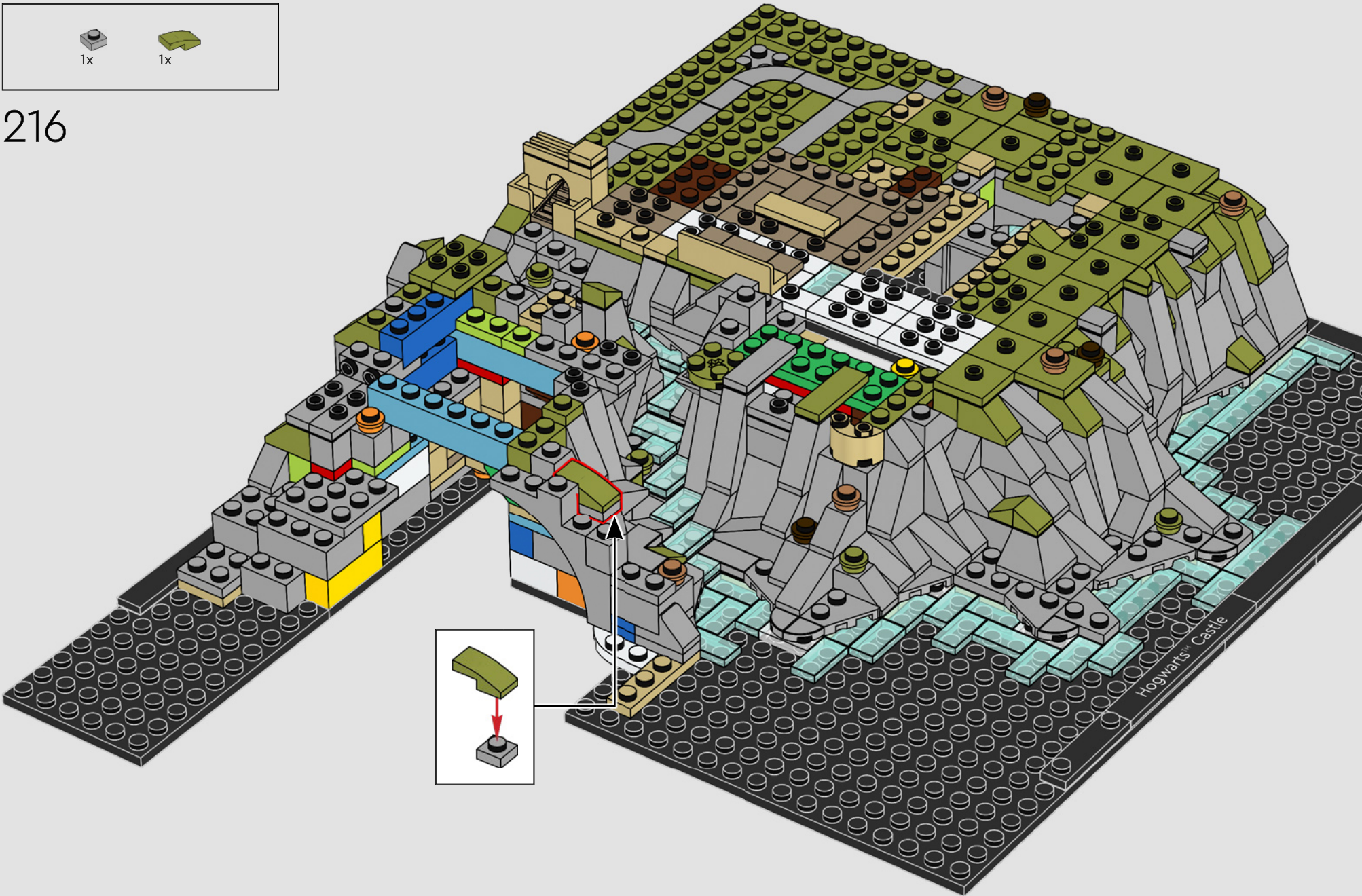



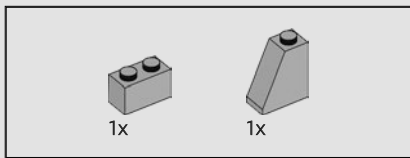

217

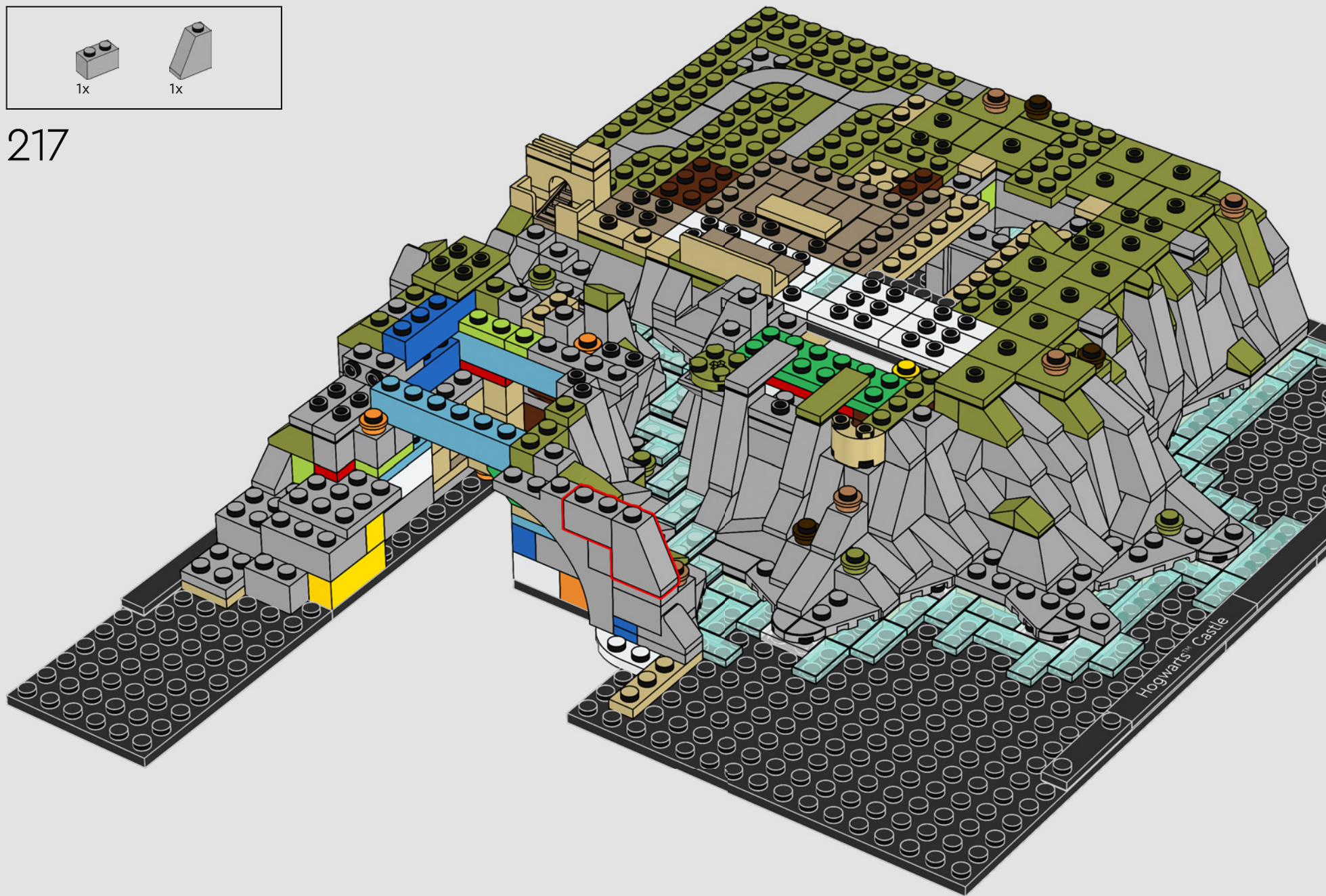



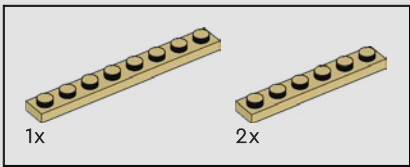

218

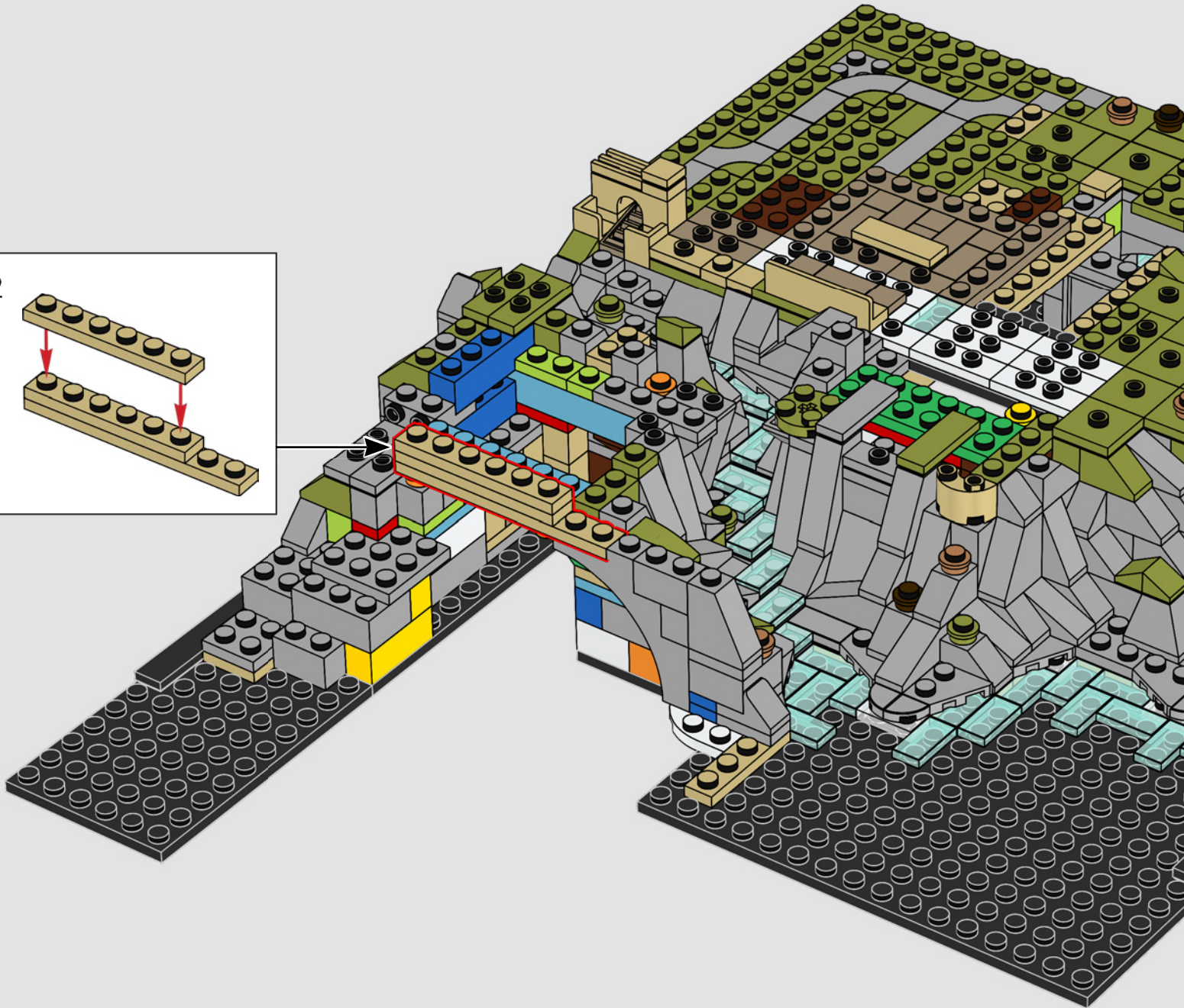
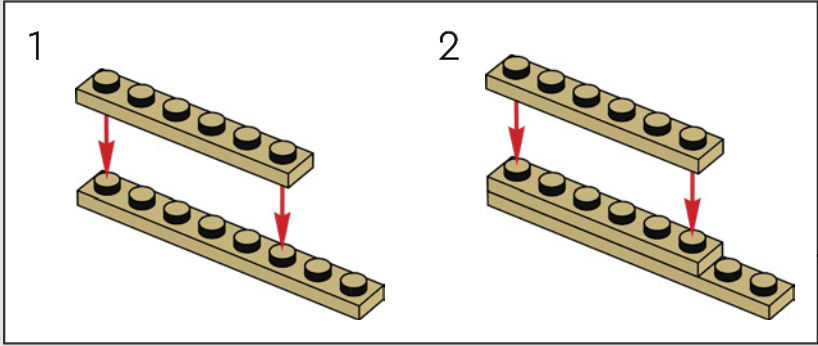



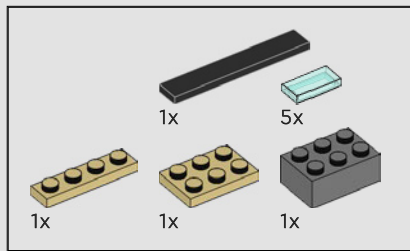

219

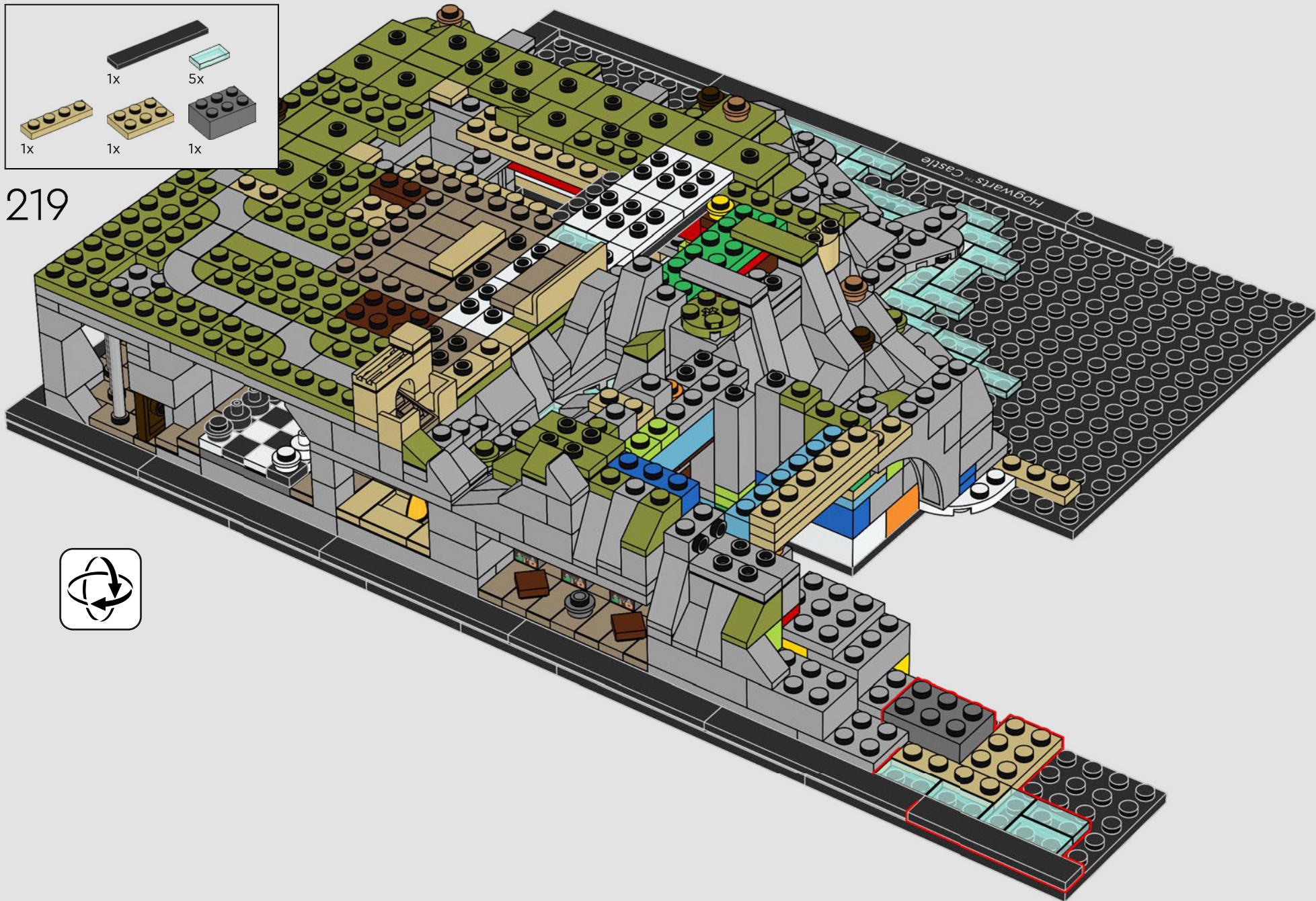



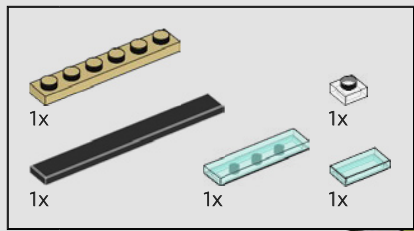

220





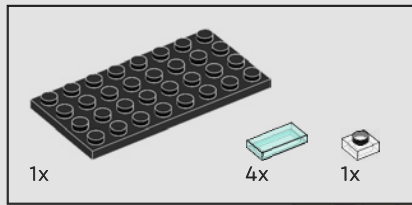

221

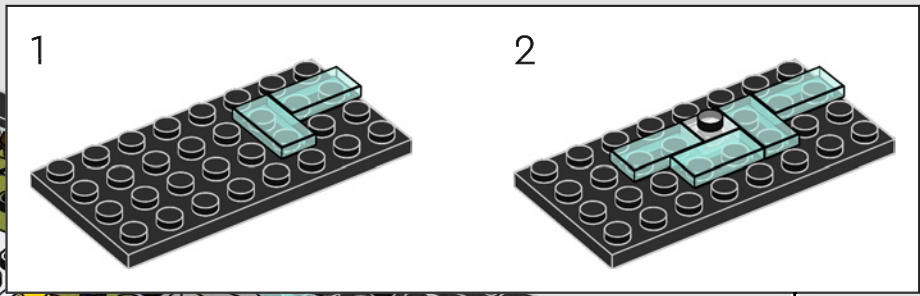



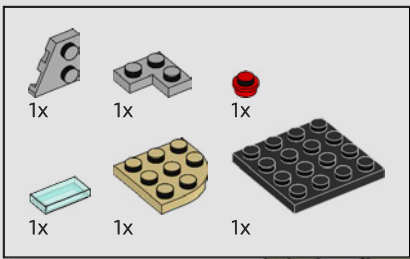

222

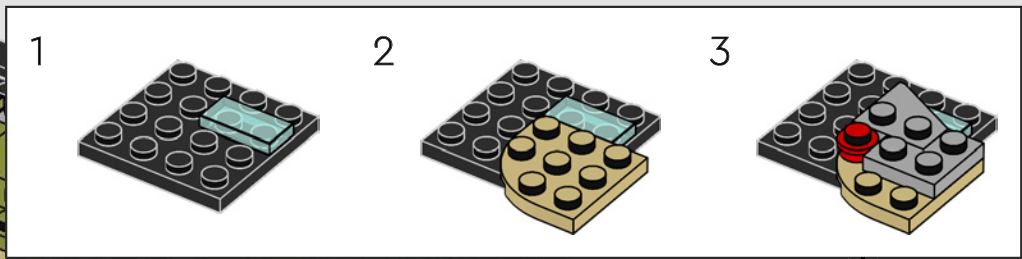



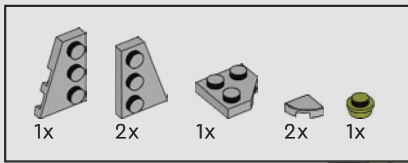

223





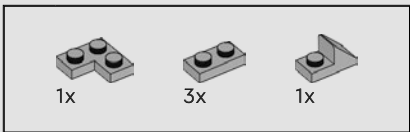

224

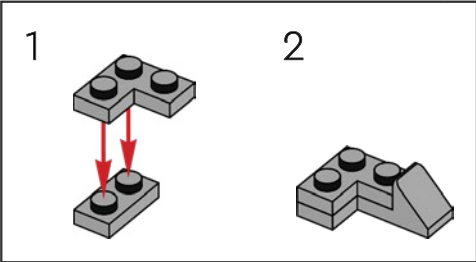
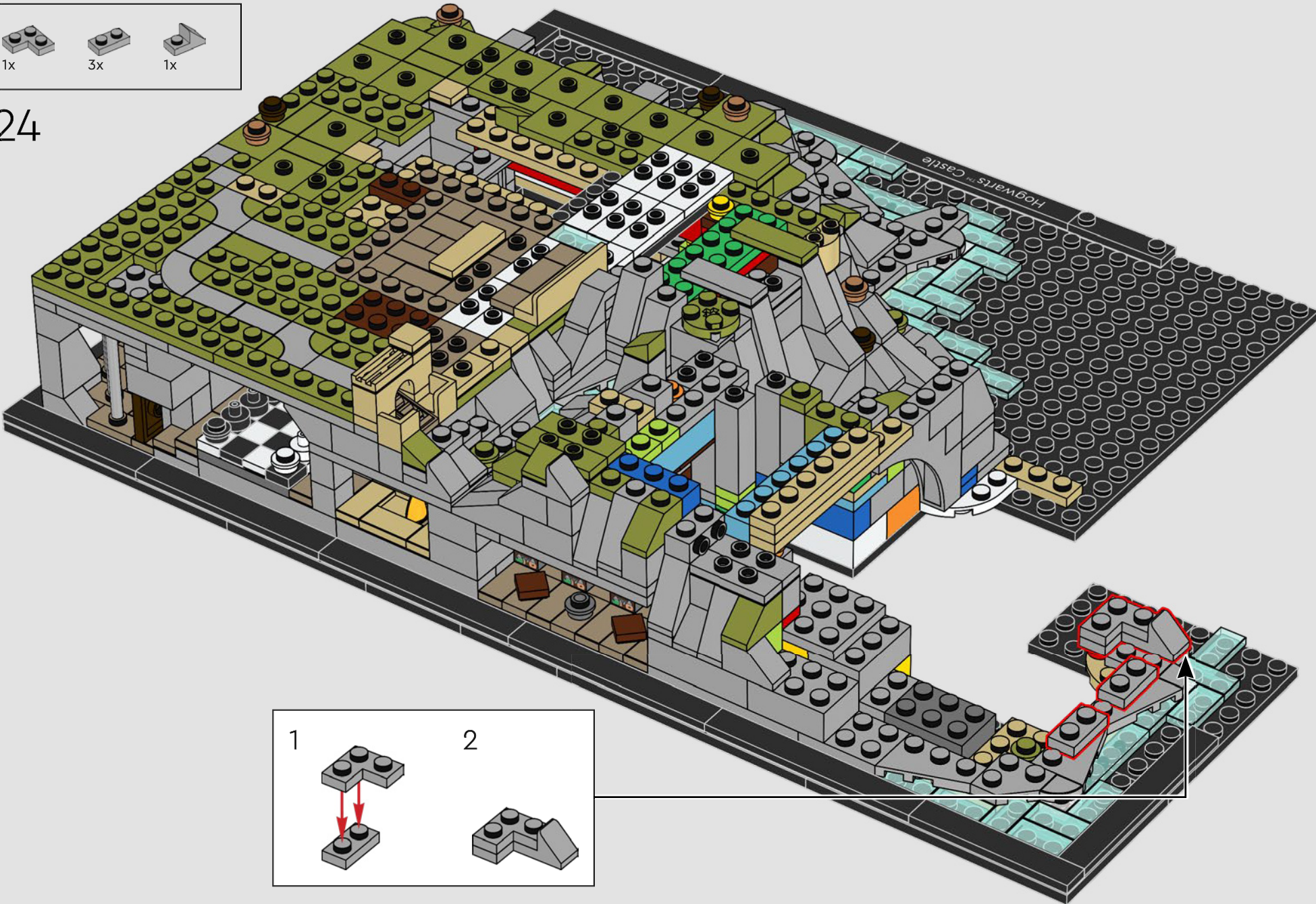



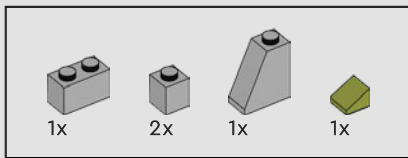

225

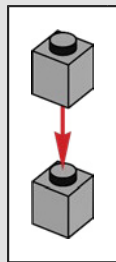
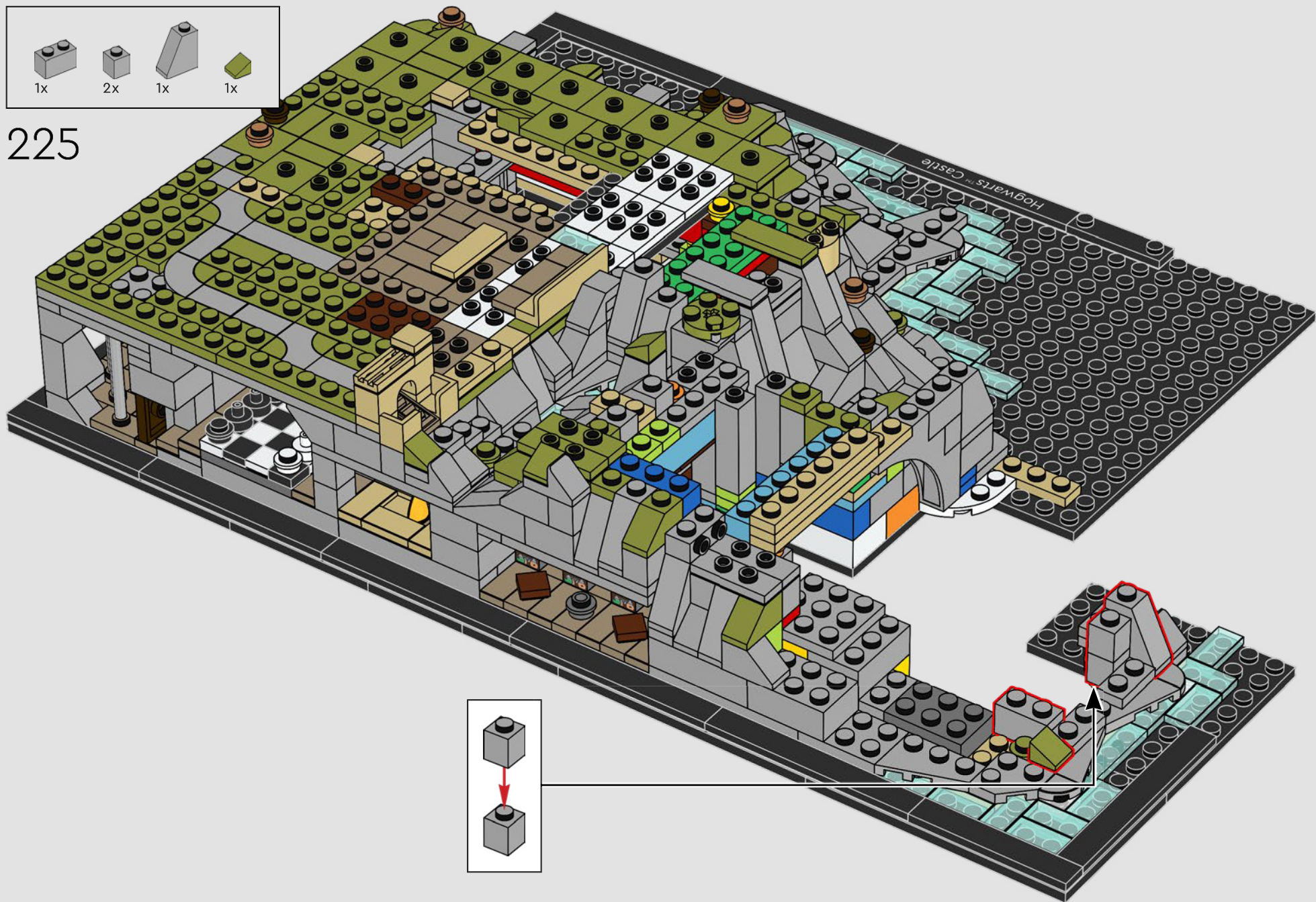



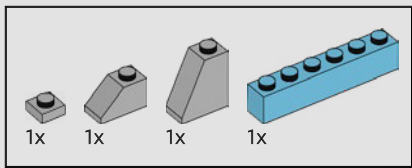

226





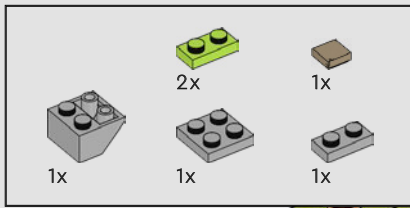

227

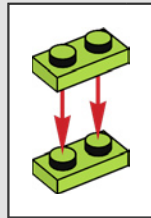
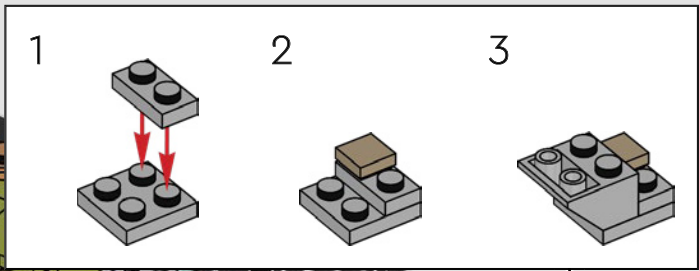



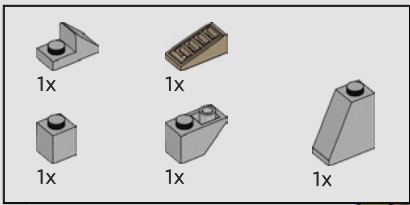

228

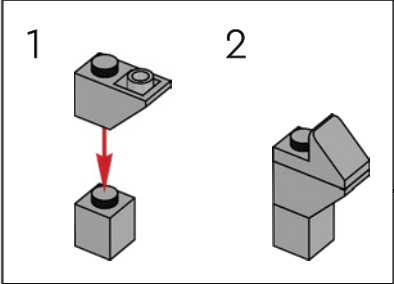
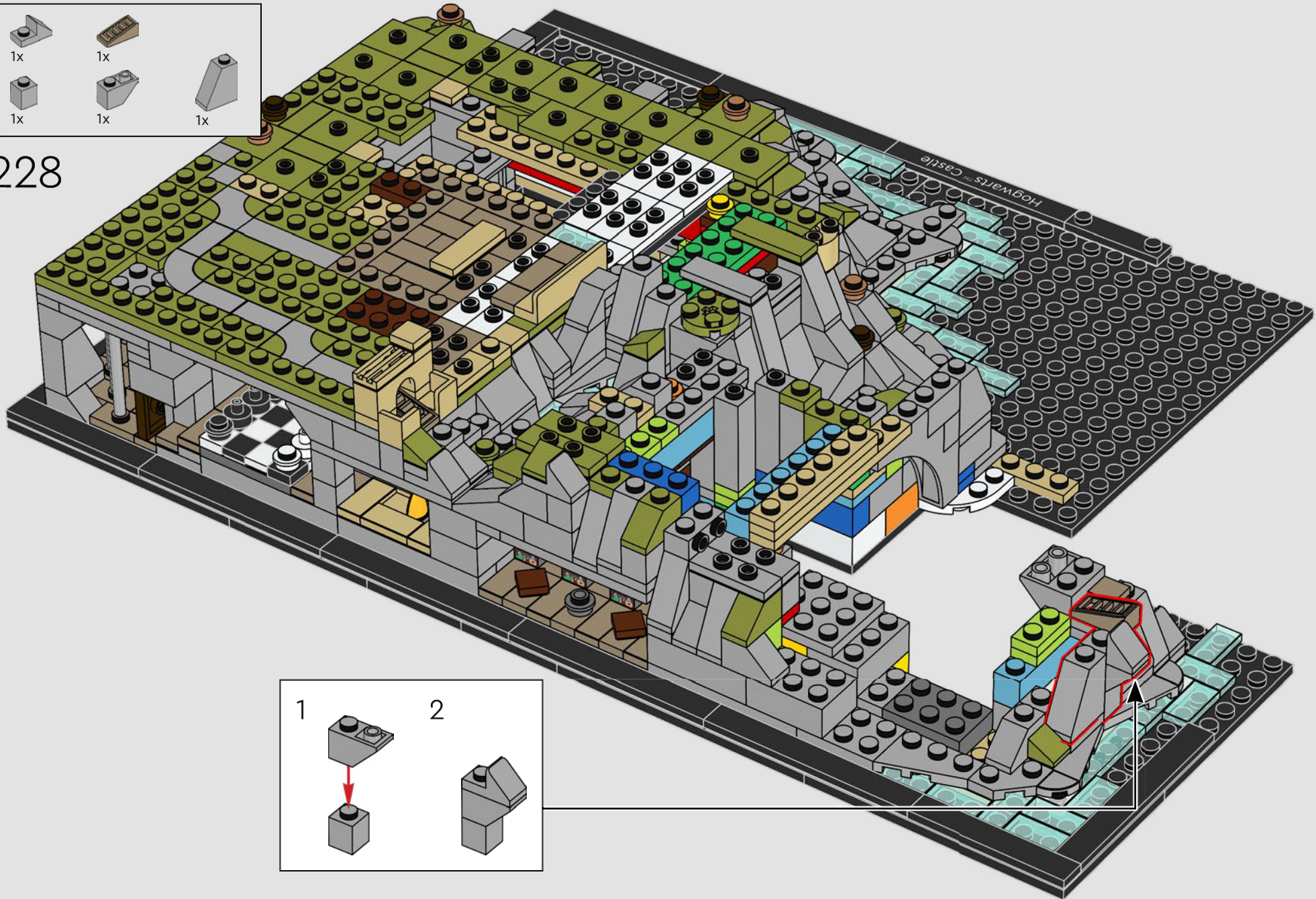



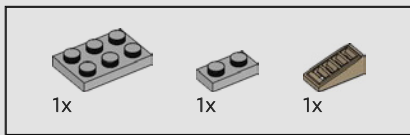

229

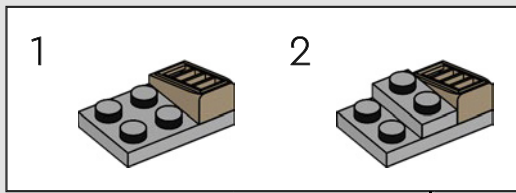



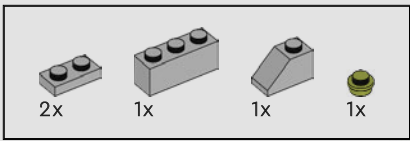

230

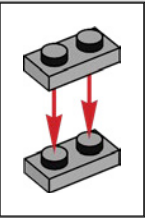



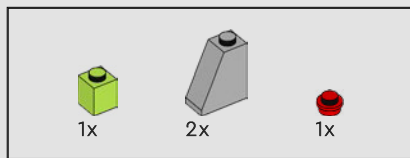

231

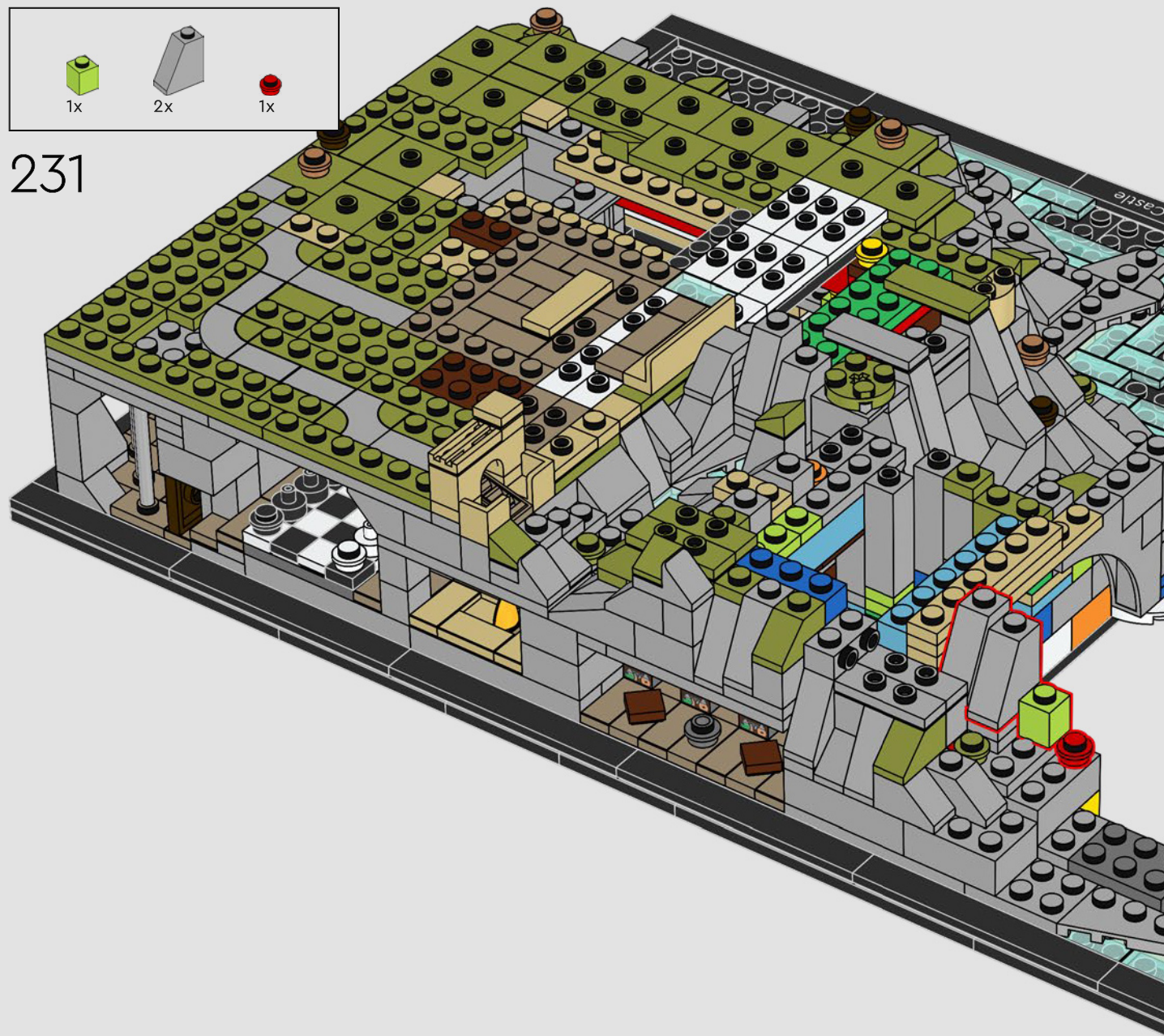

Sebbene i quattro fondatori fossero amici di lunga data, Salazar Serpeverde nutriva una profonda diffidenza nei confronti dei Babbani che alla fine lo portò ad abbandonare la scuola e i suoi tre compagni di magia.





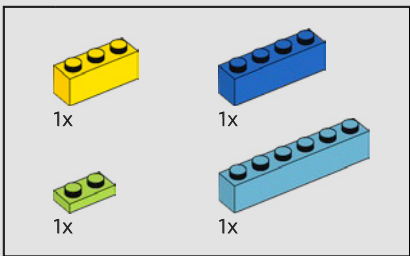

232

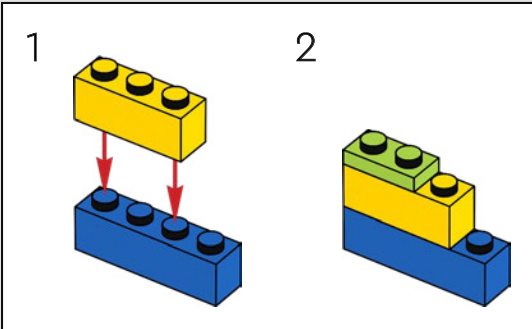
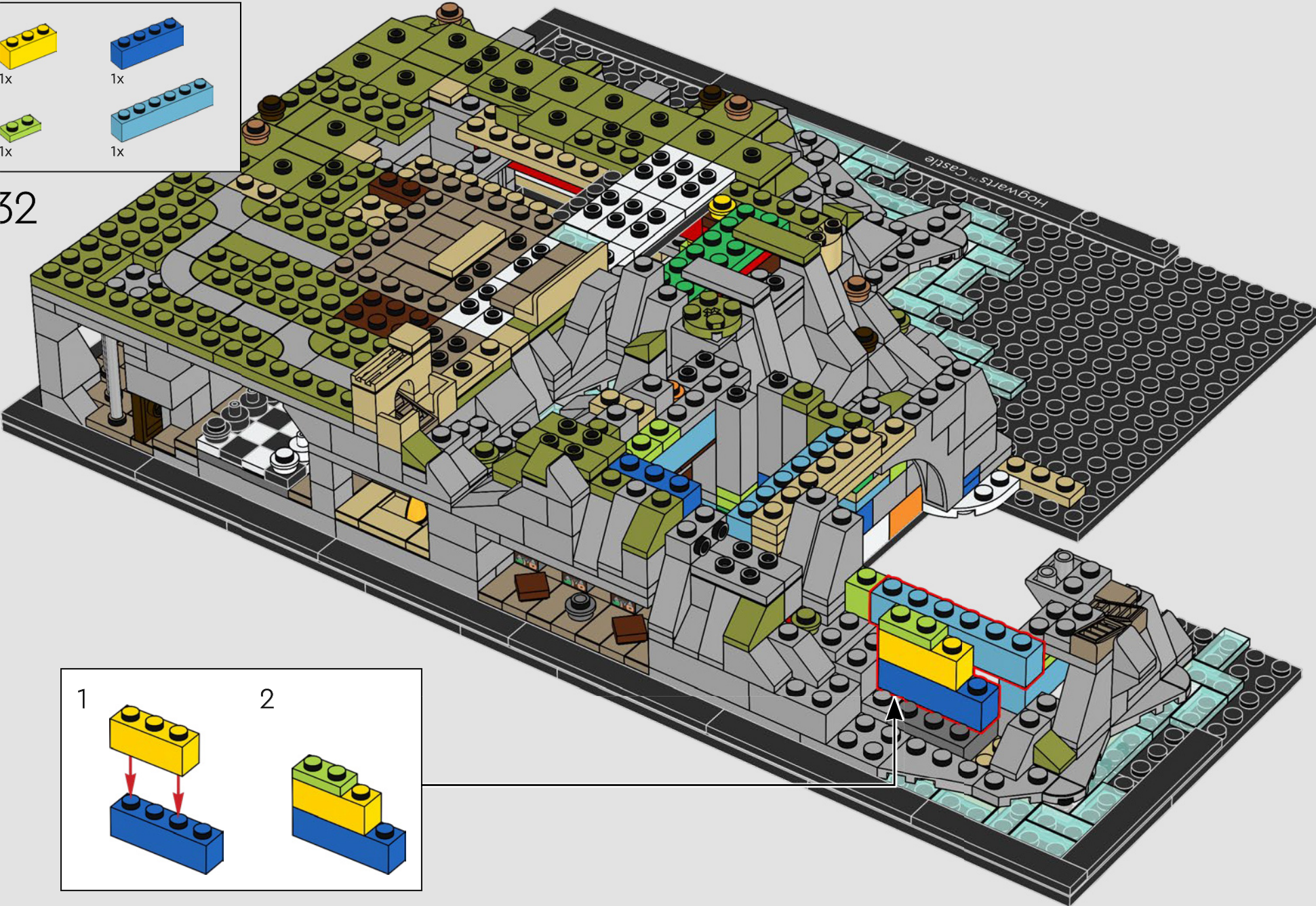



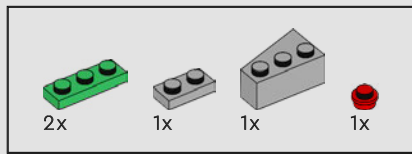

233

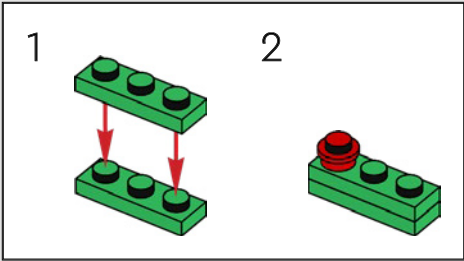
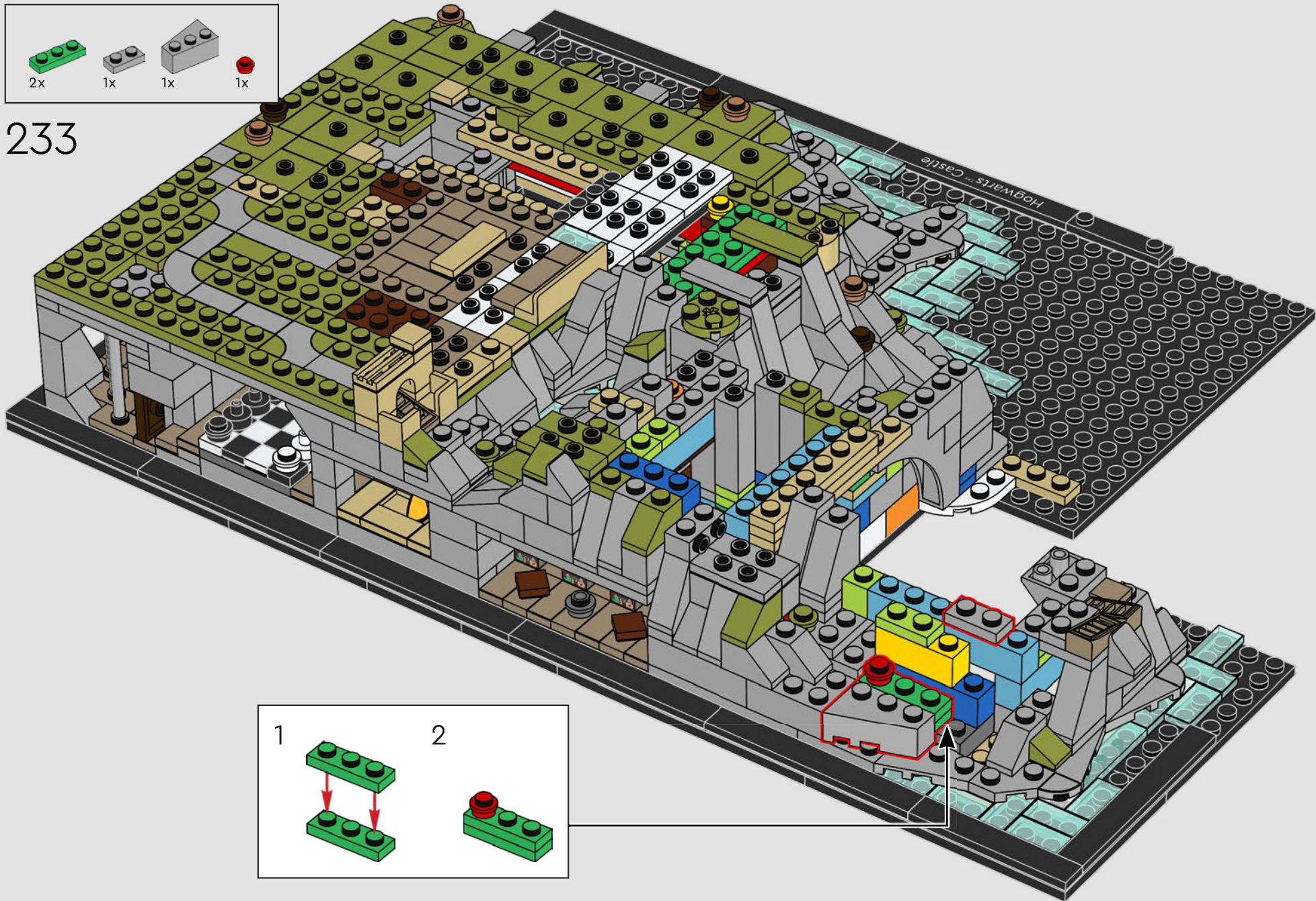



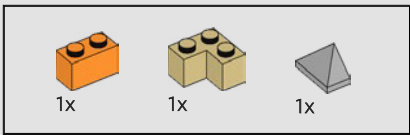

234





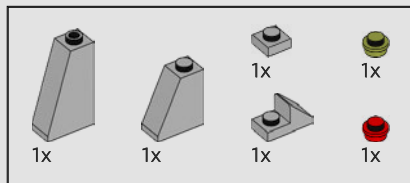

235





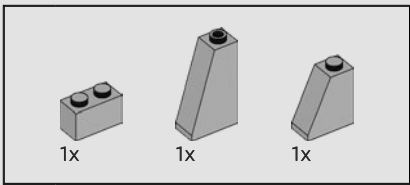

236

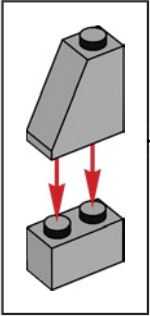
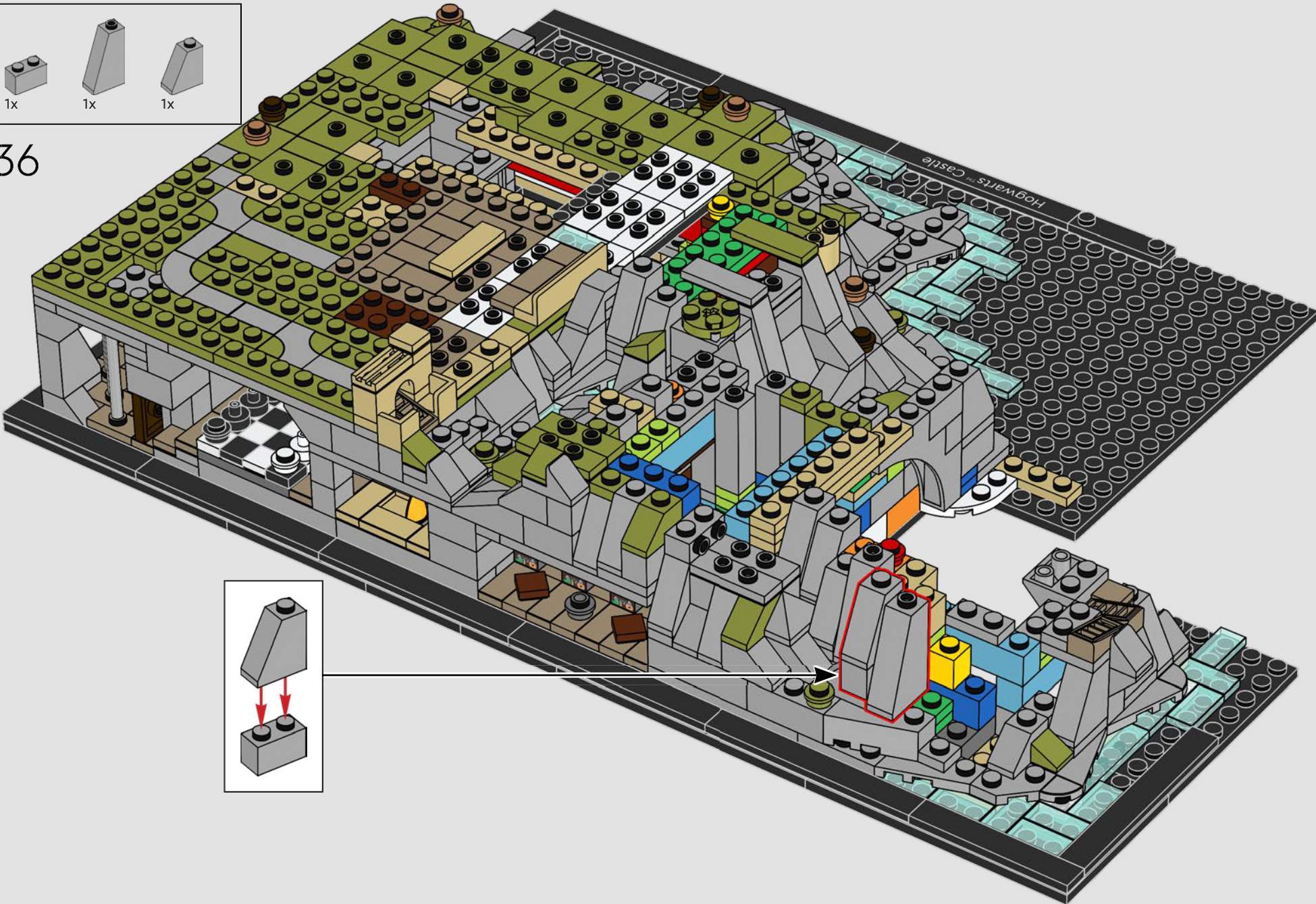



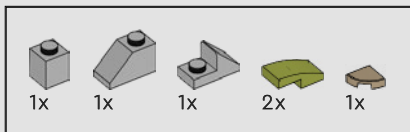

237

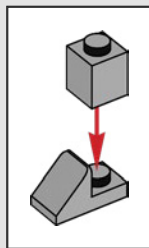
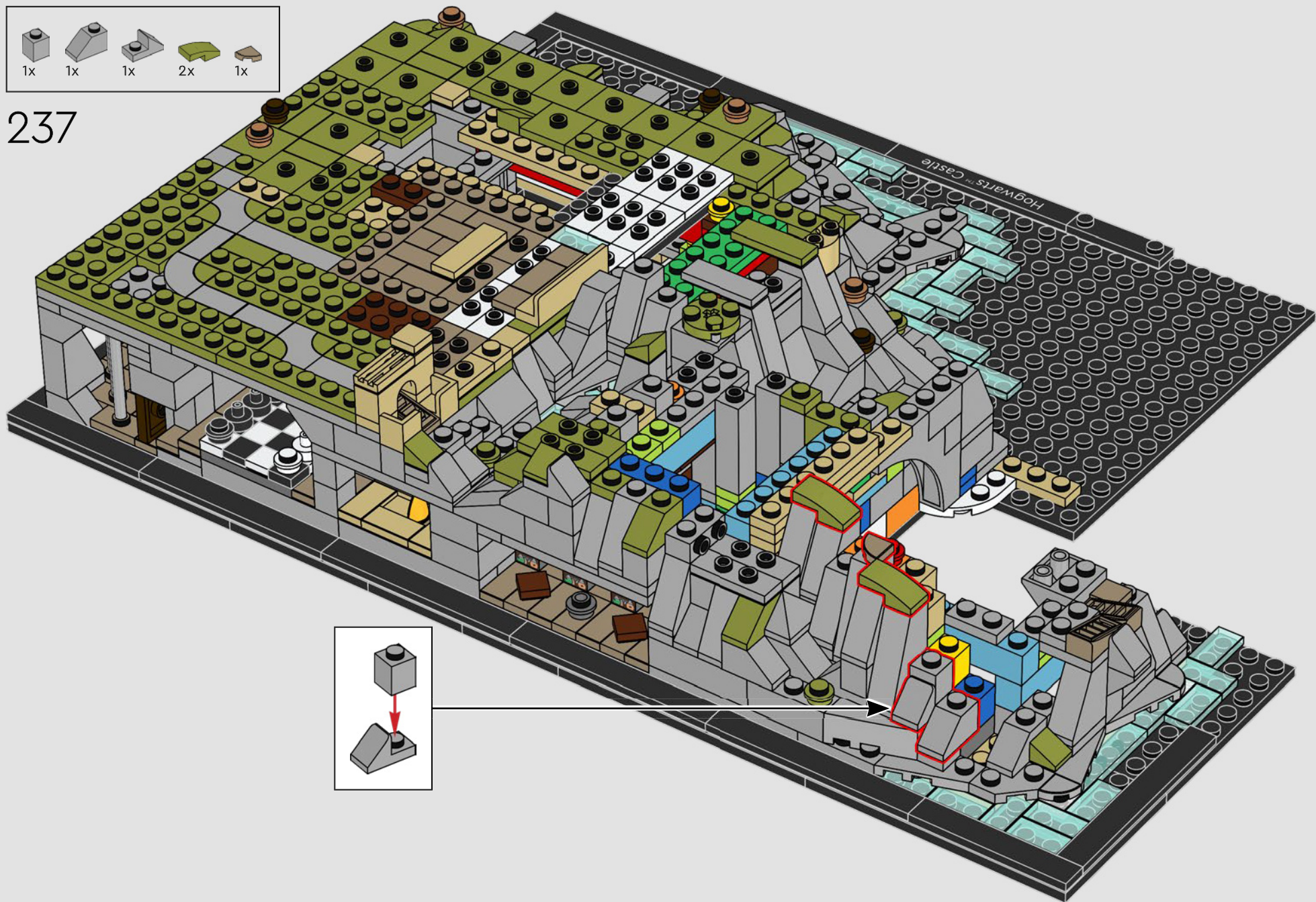



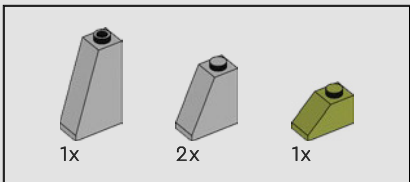

238





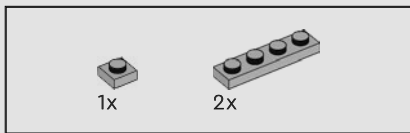

239

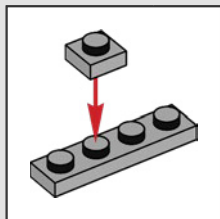
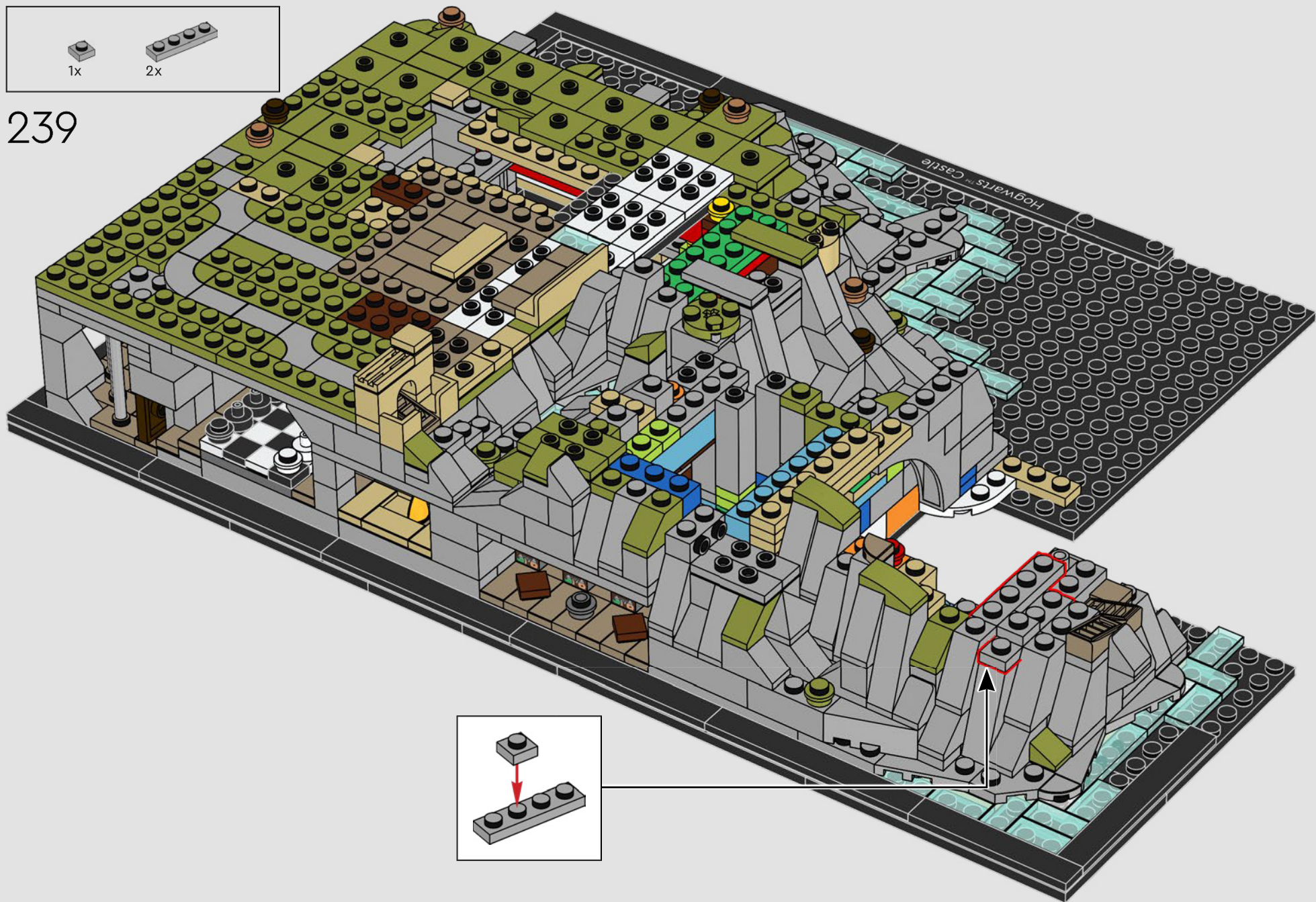





240





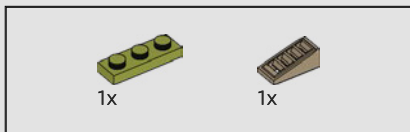

241

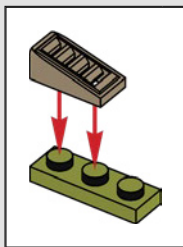
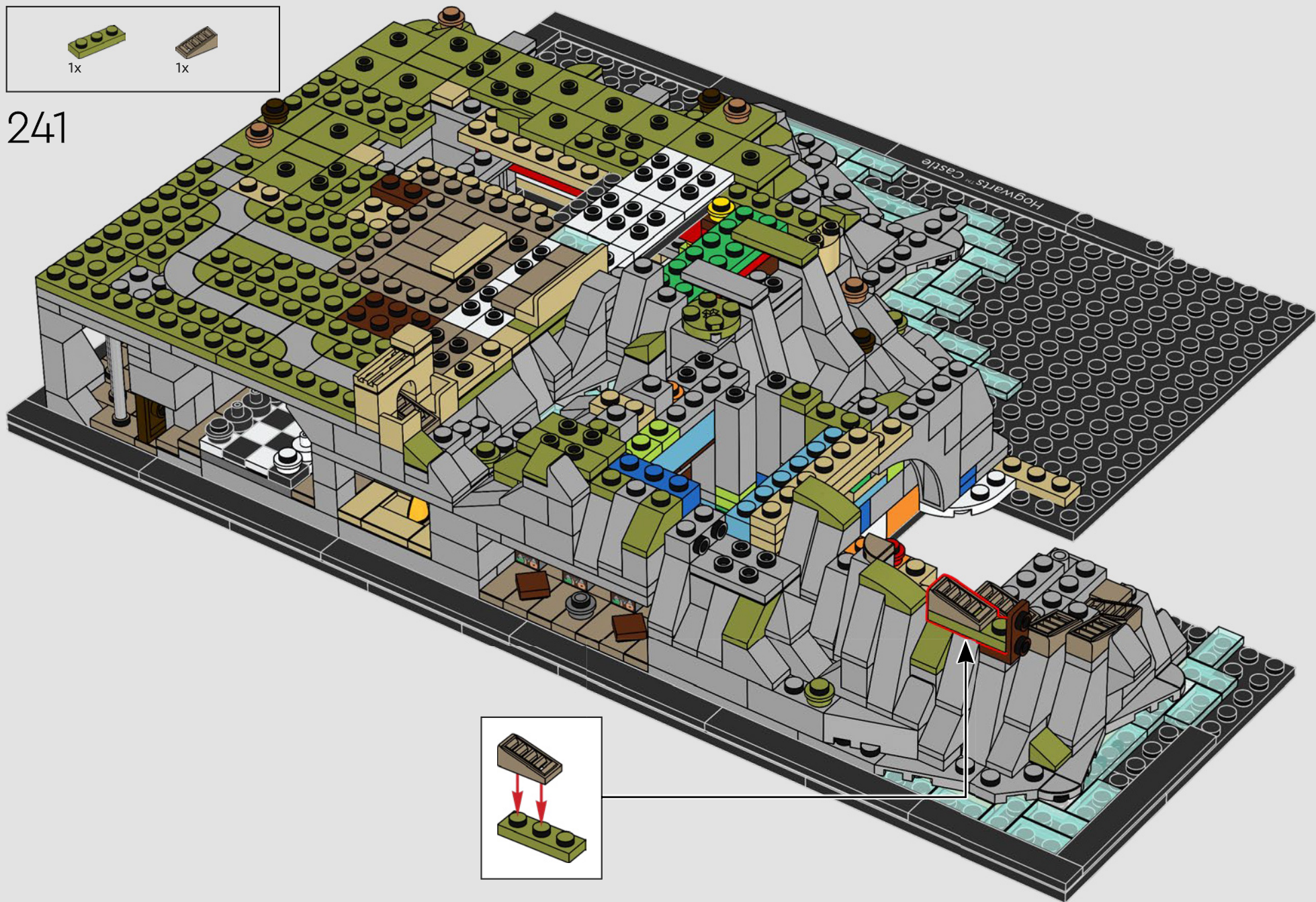





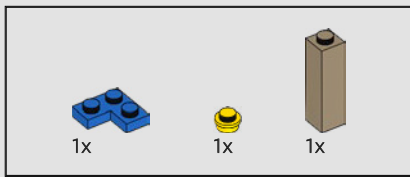

242

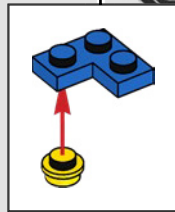
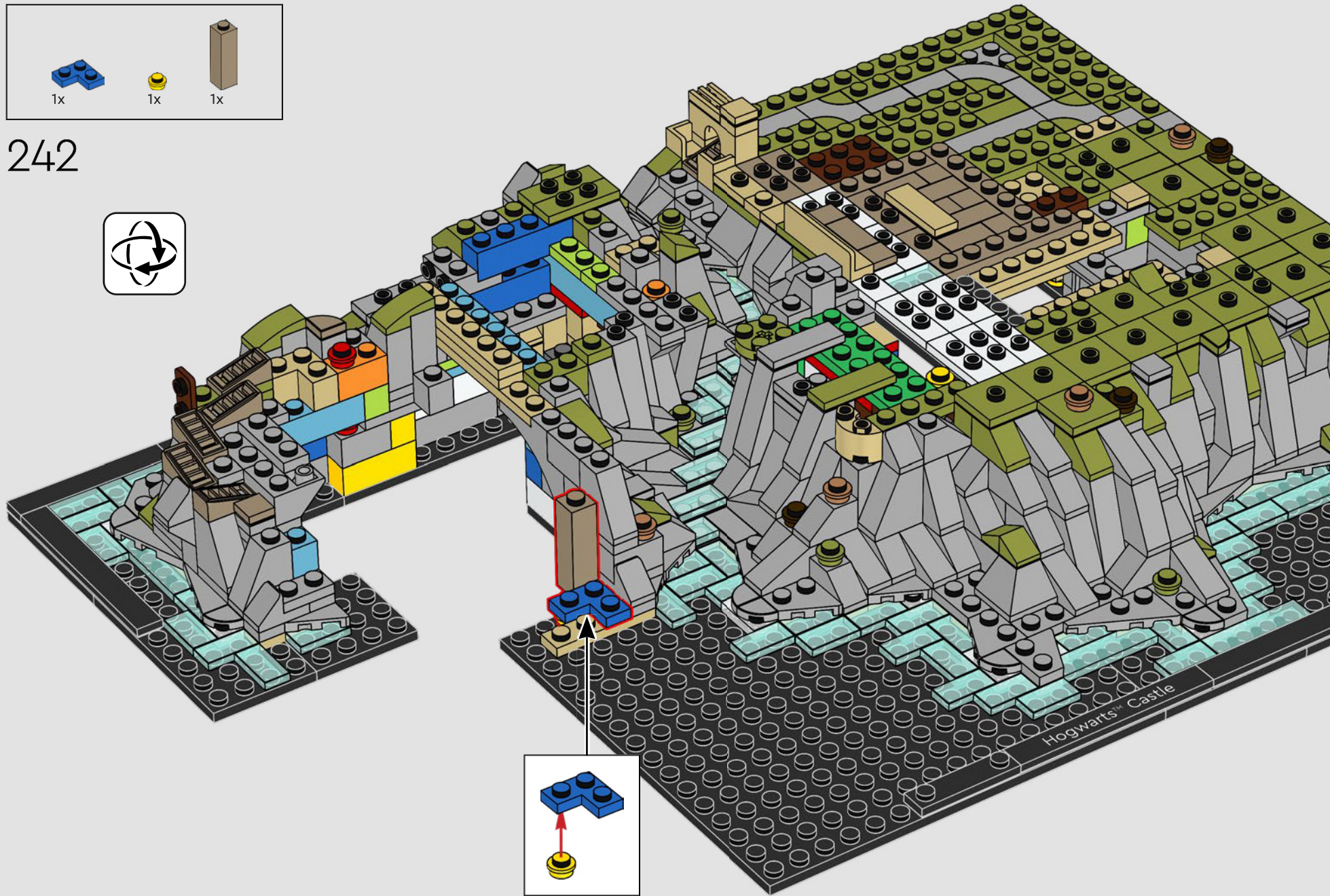



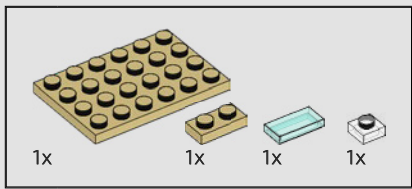

243

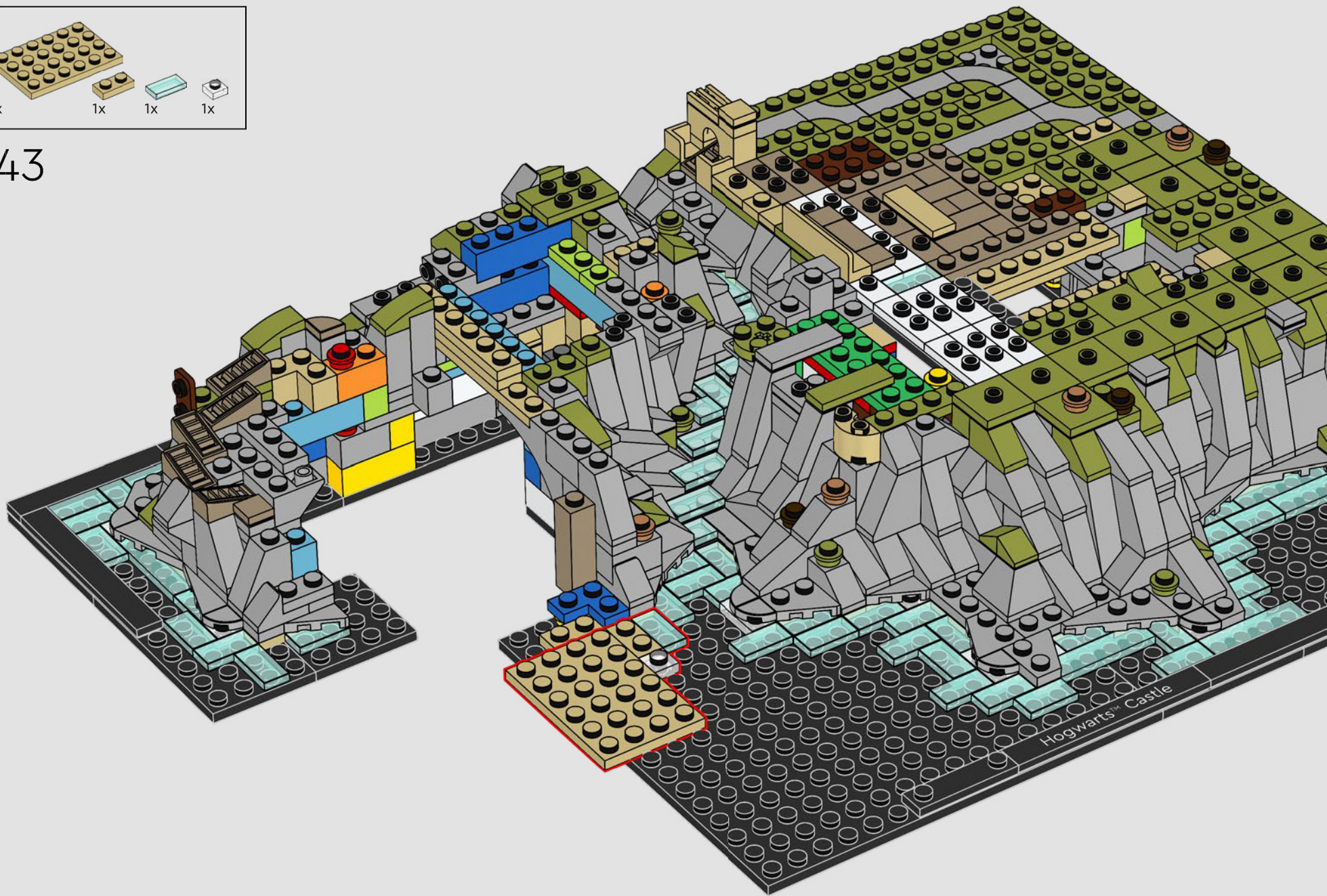



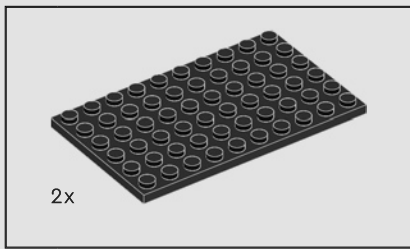

244

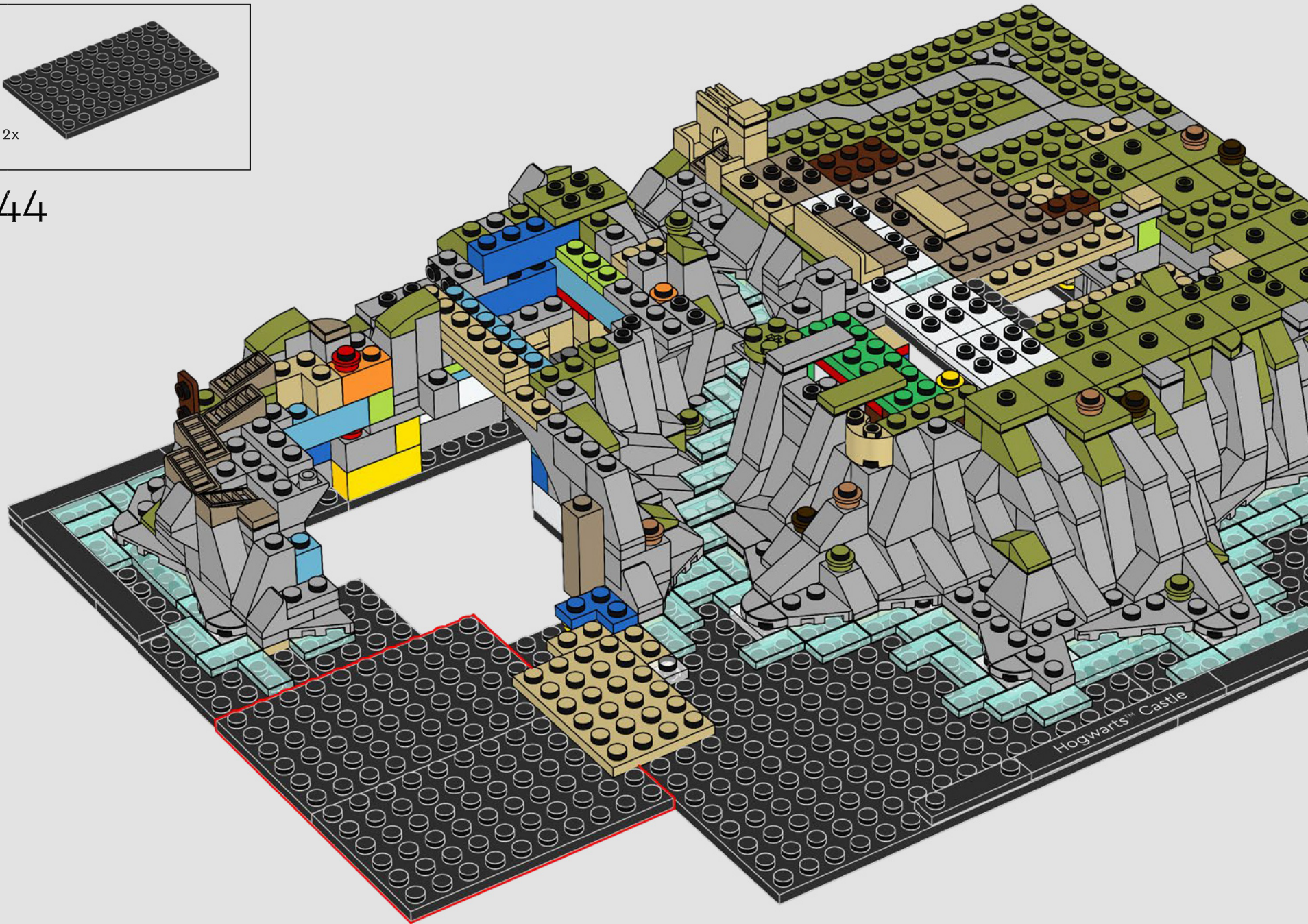



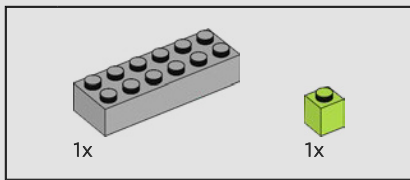

245

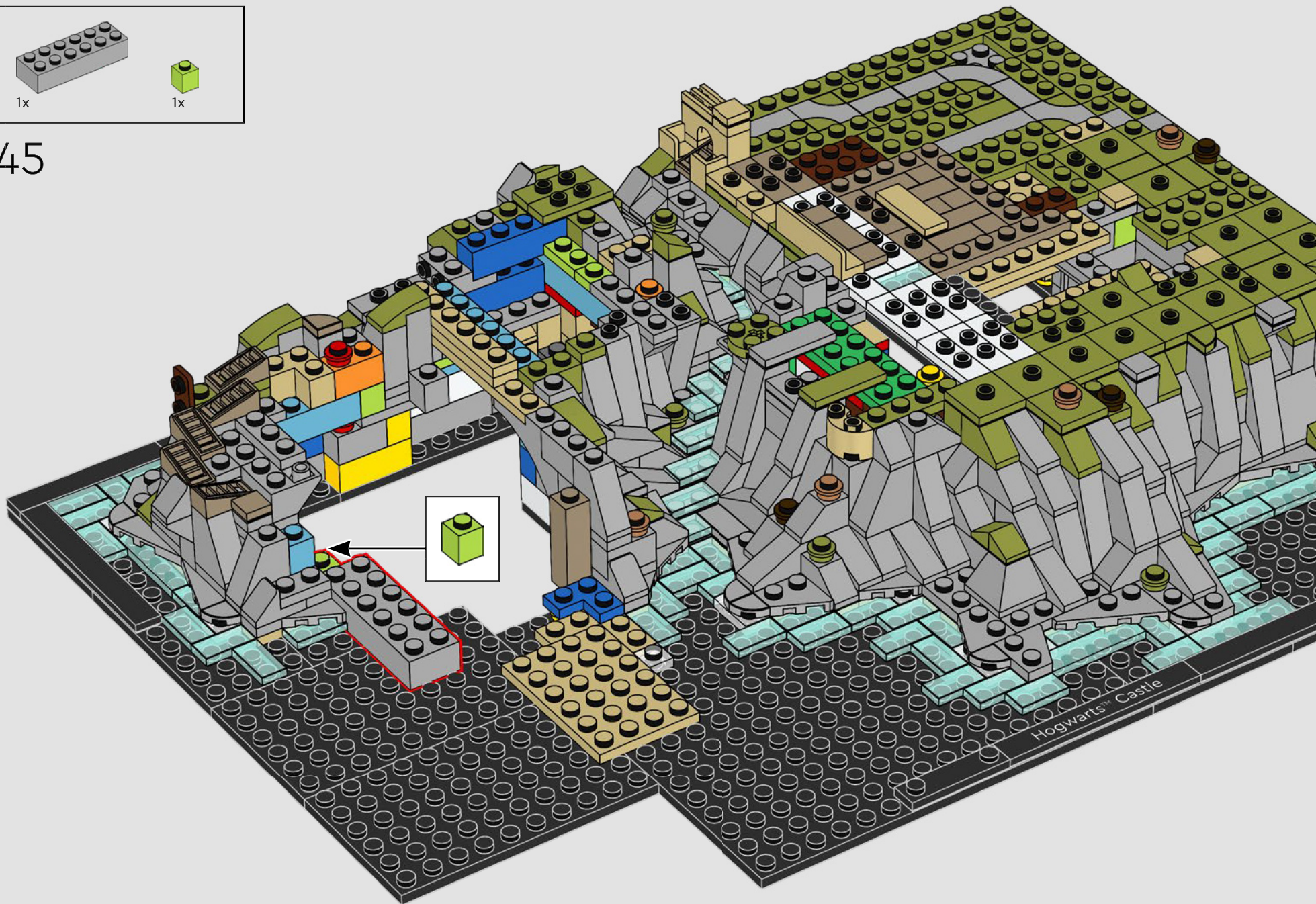



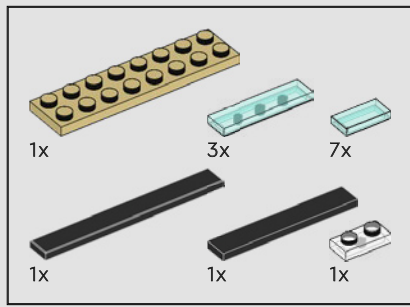

246

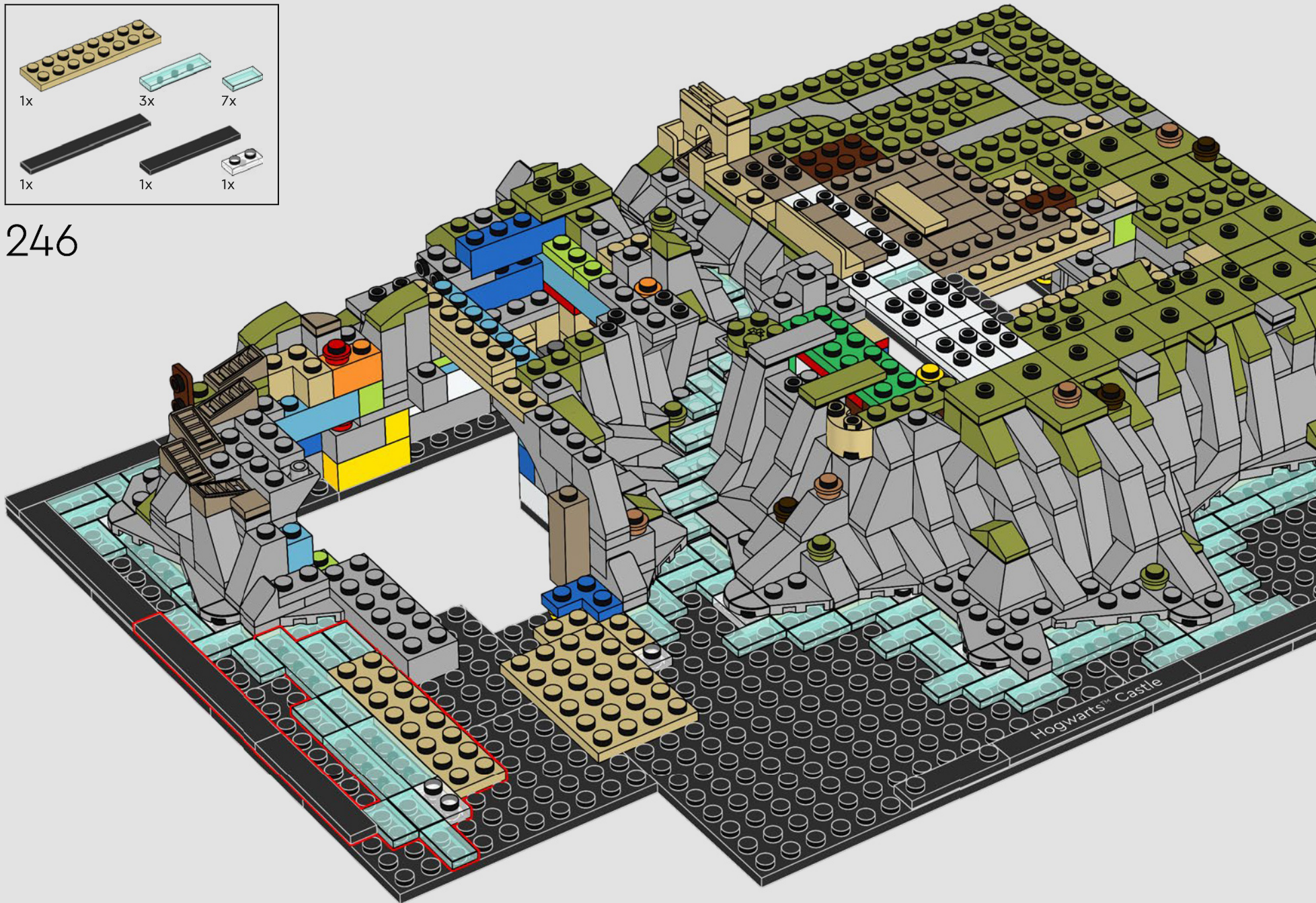



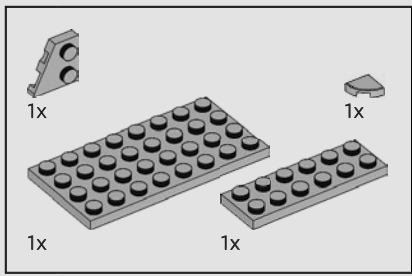

247

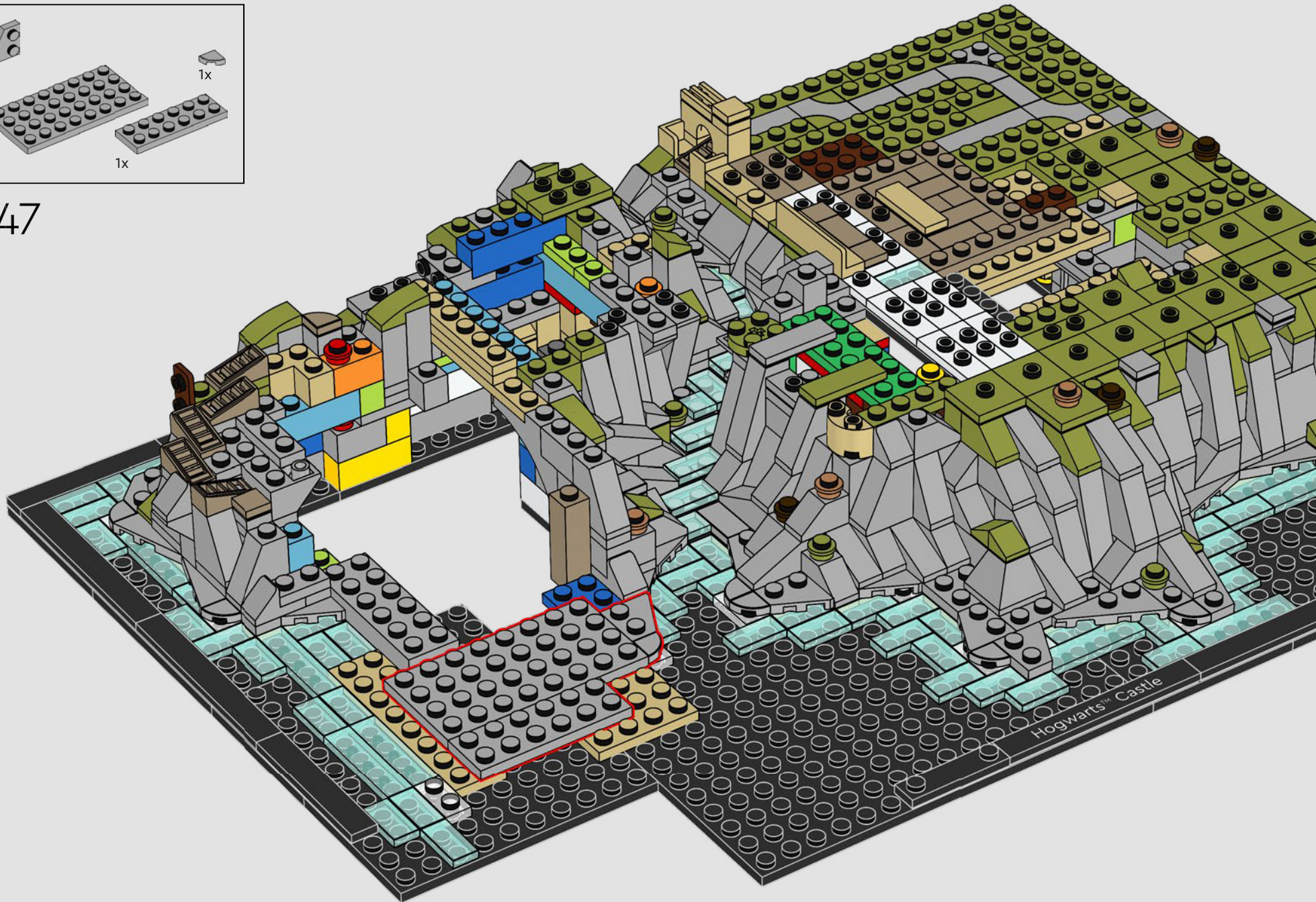



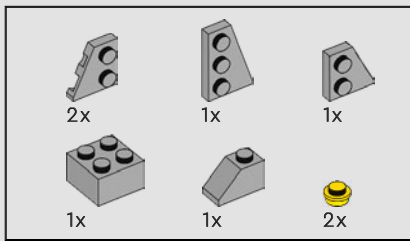

248

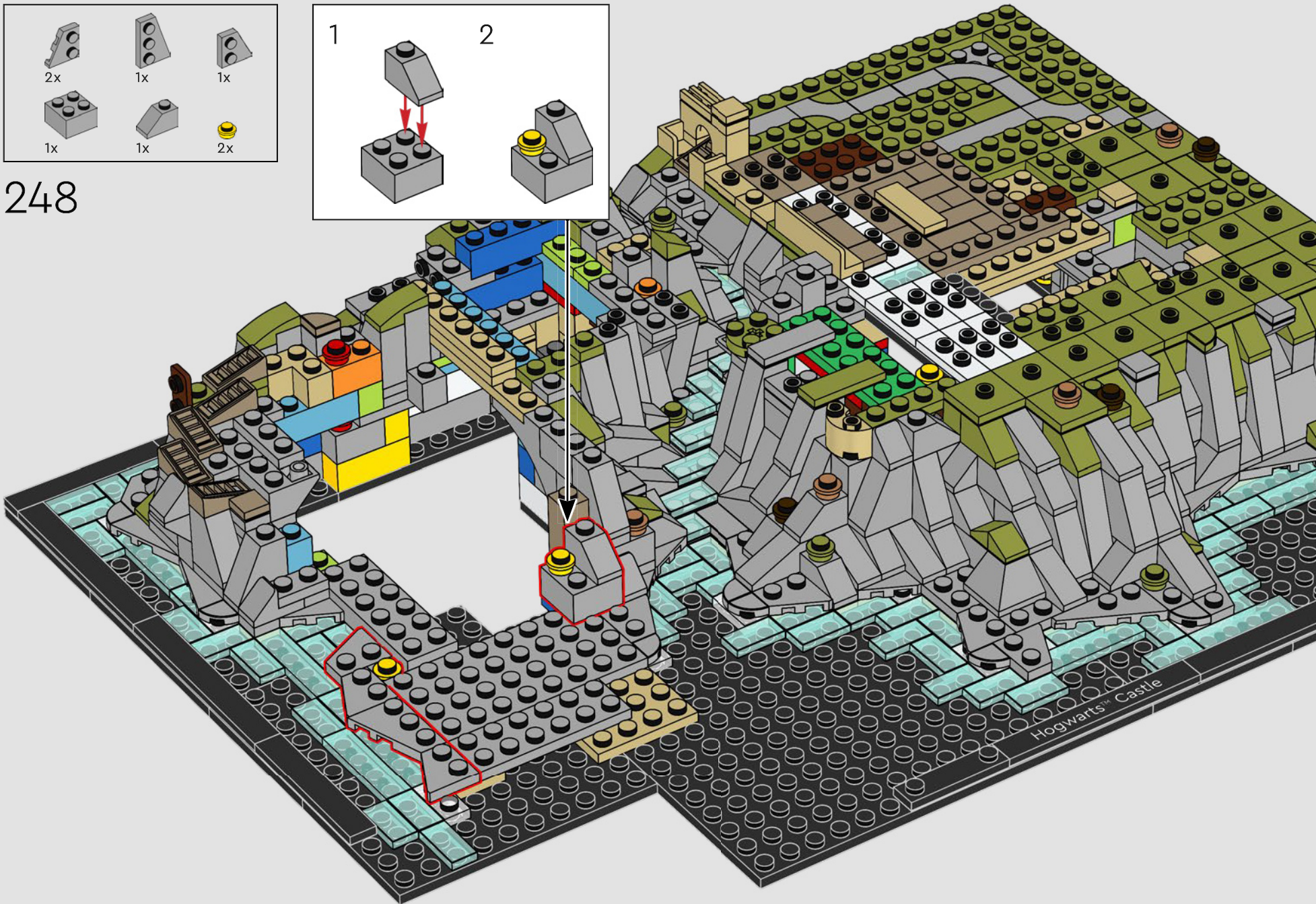
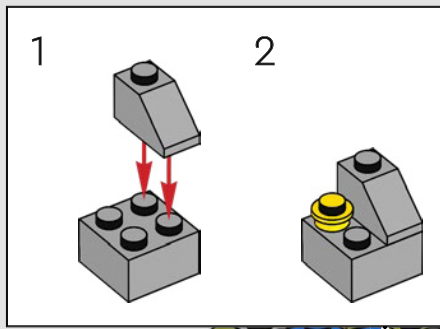



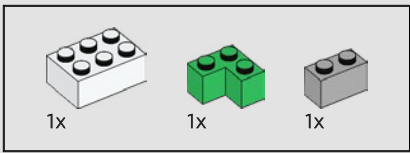

249

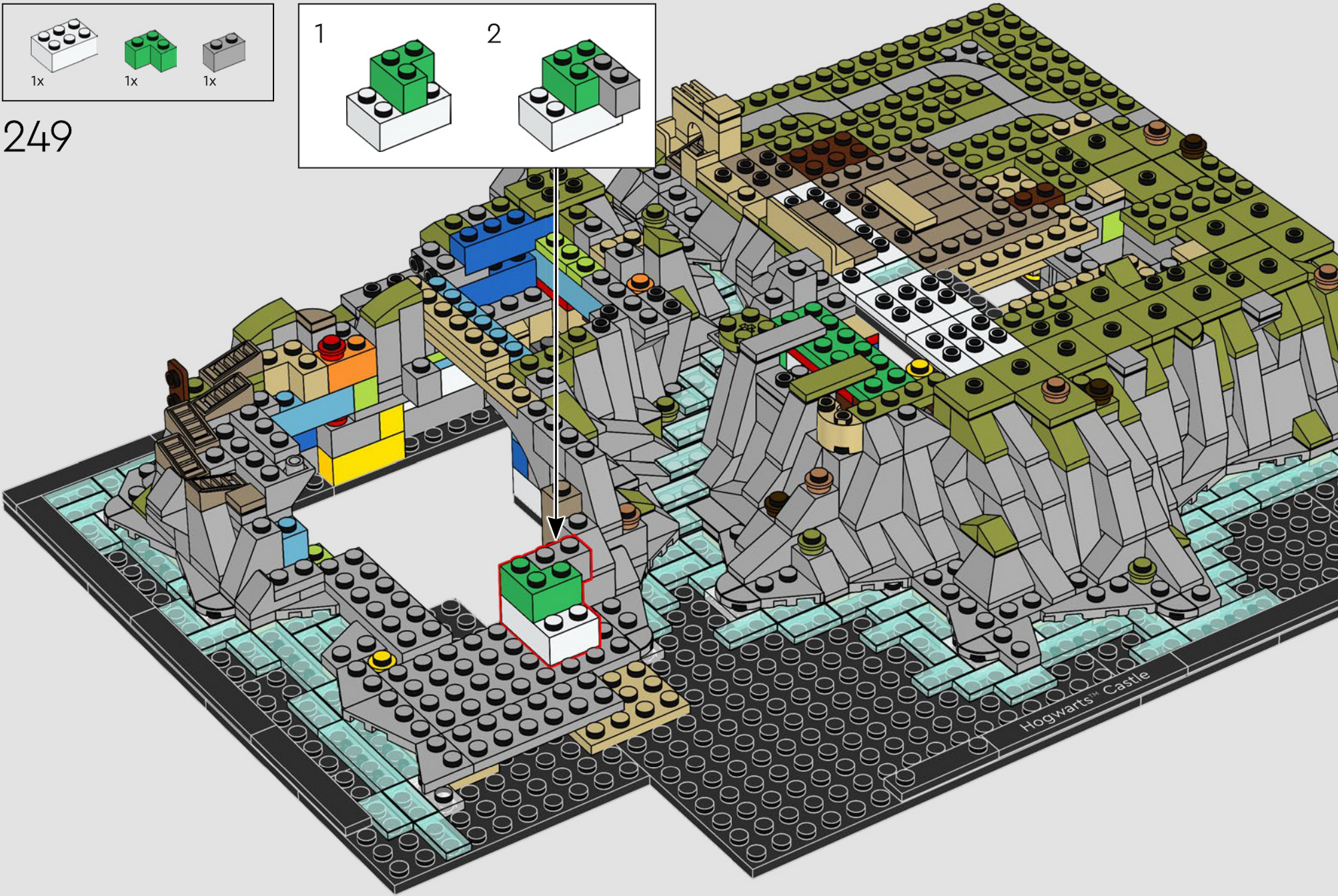
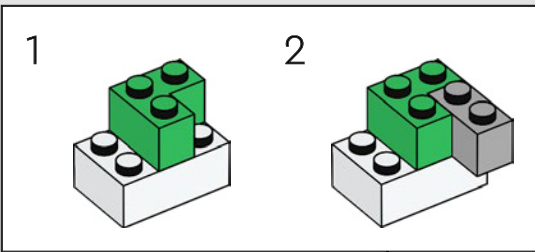



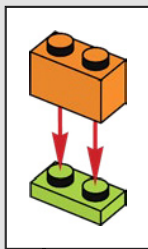
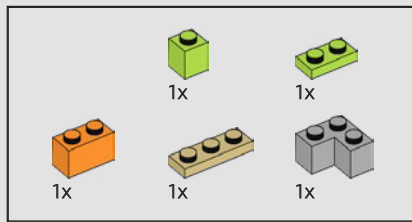

250

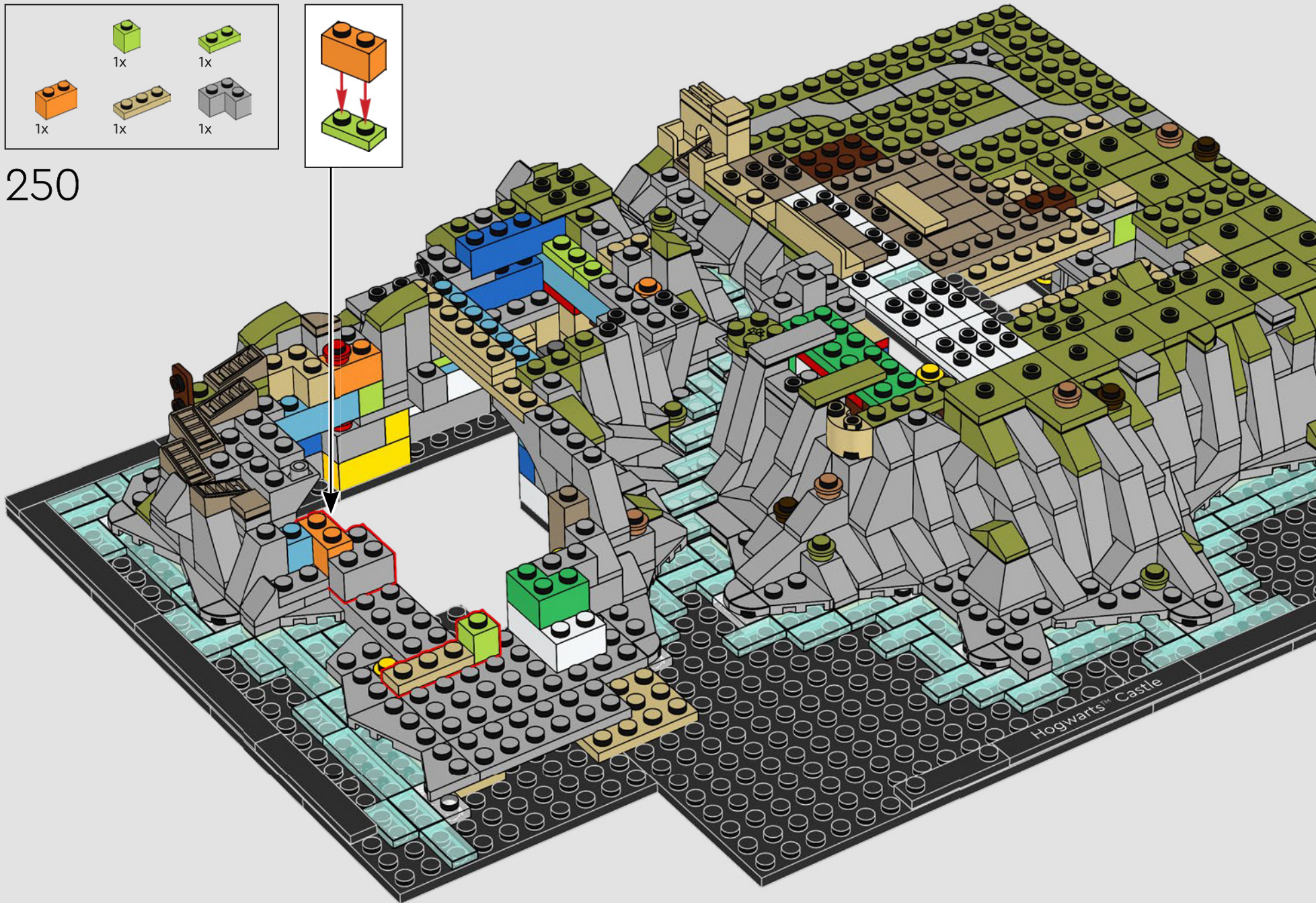



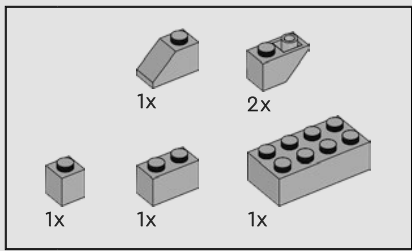

251

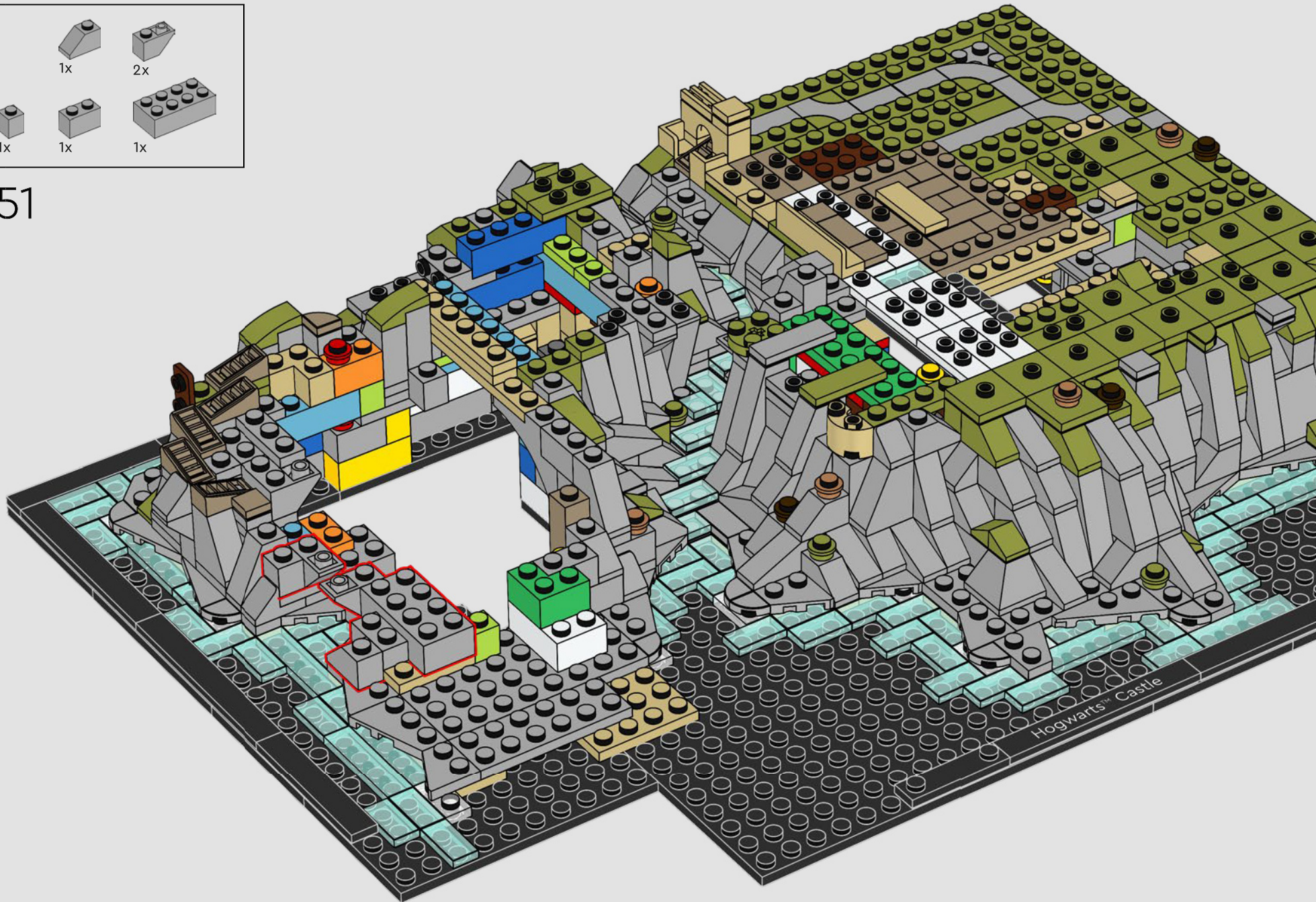



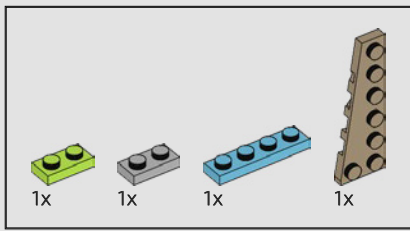

252

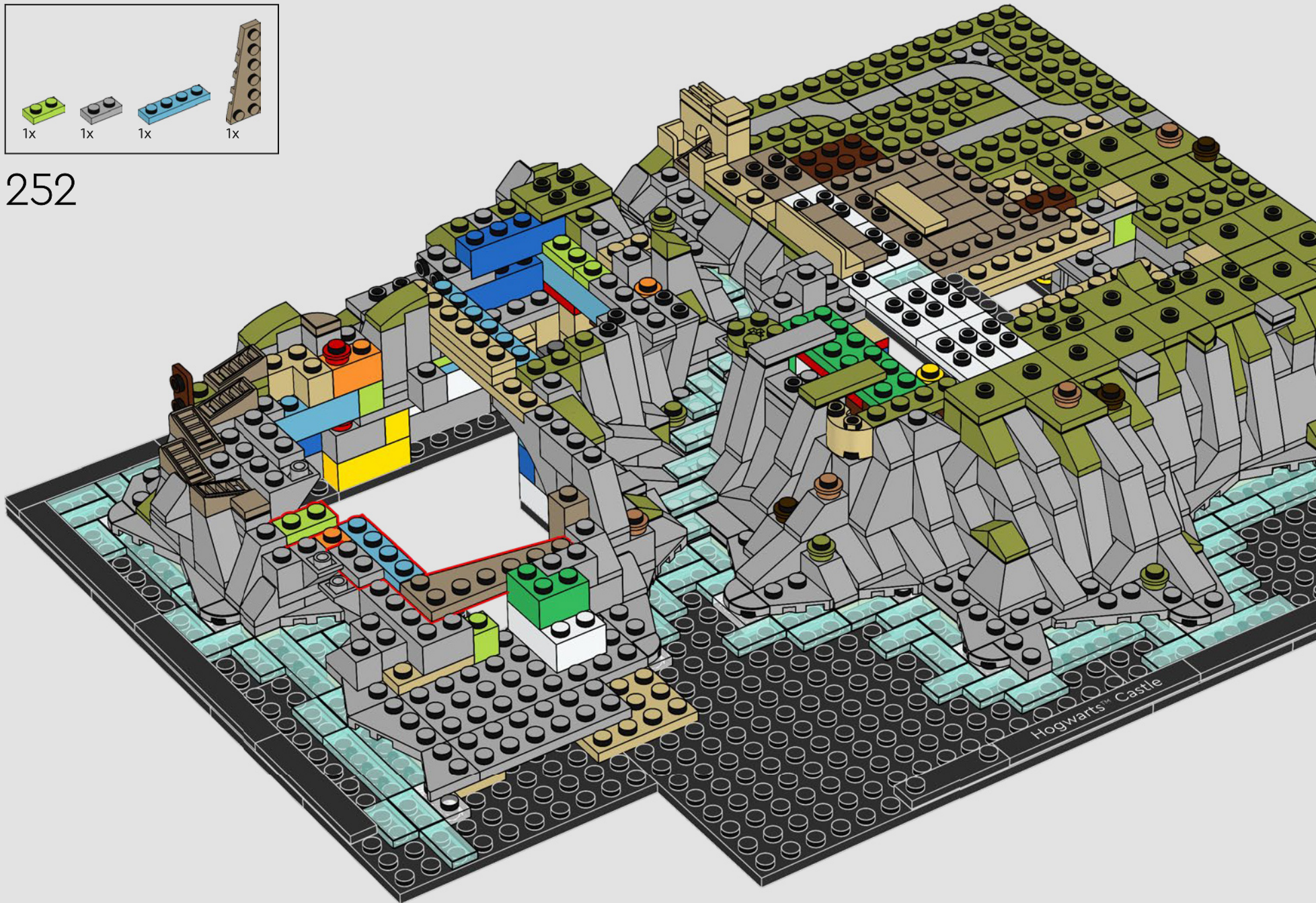



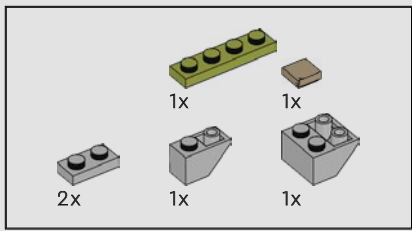

253

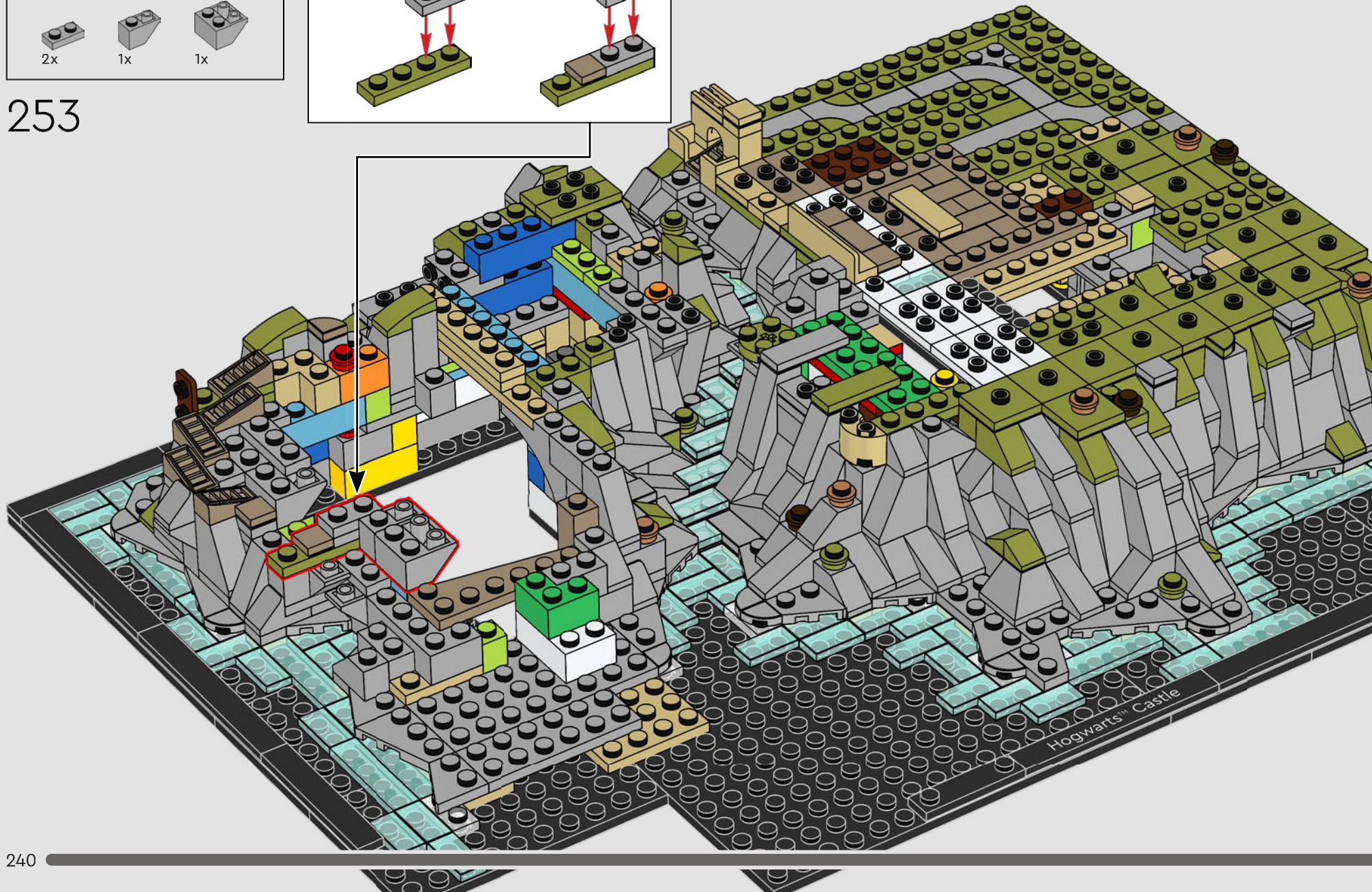
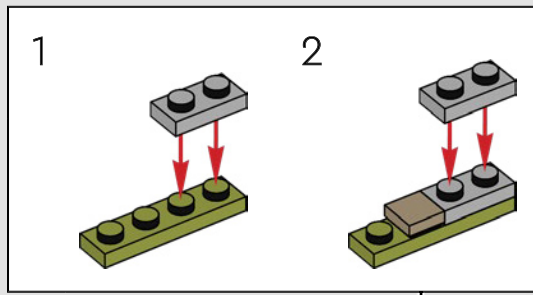



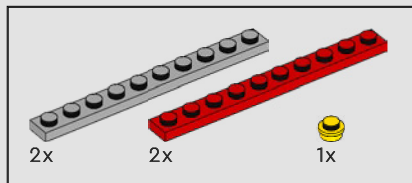

254

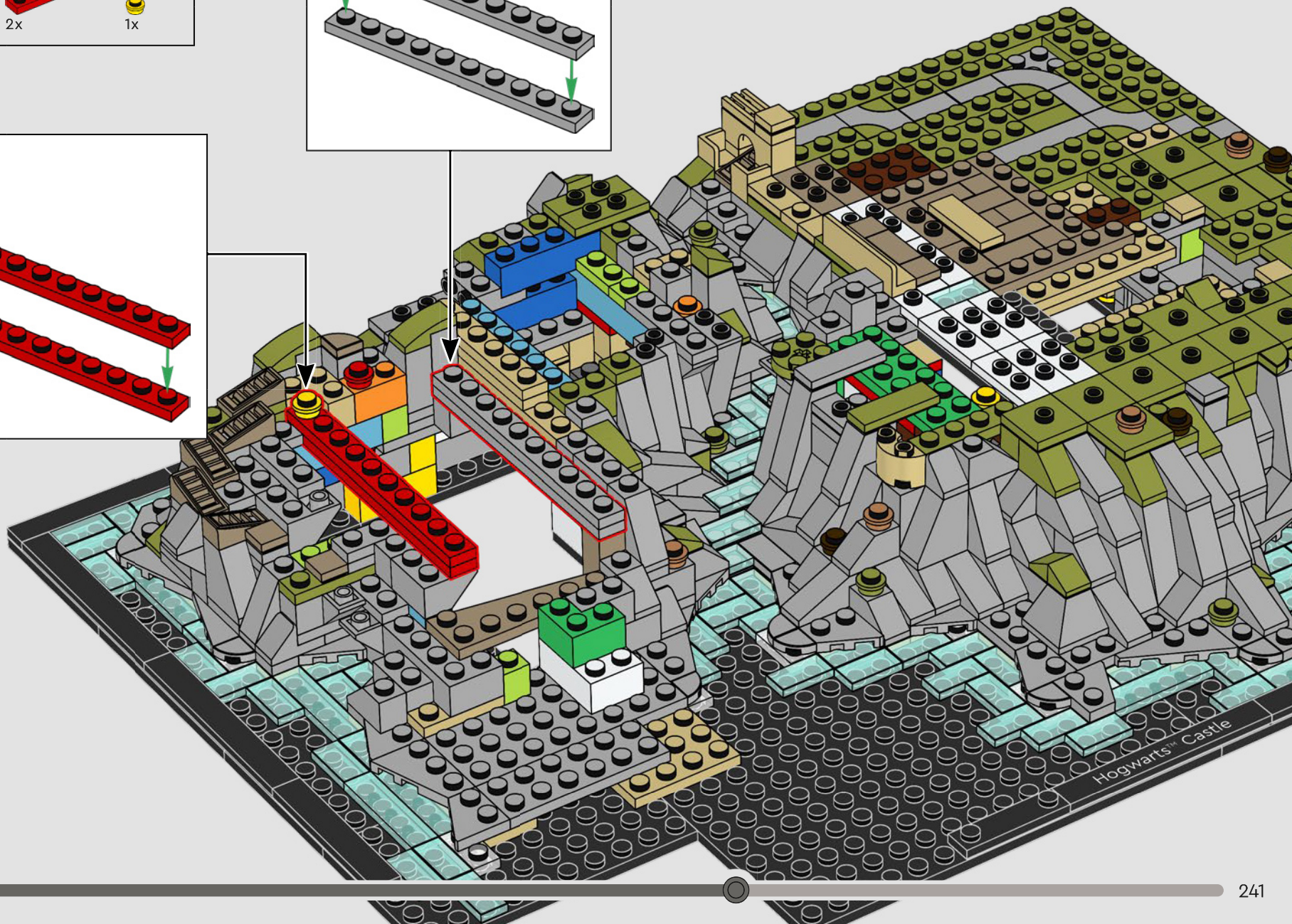
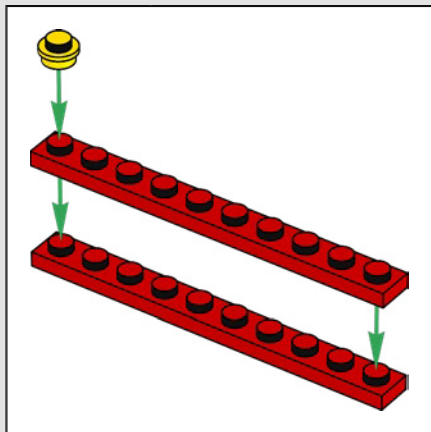
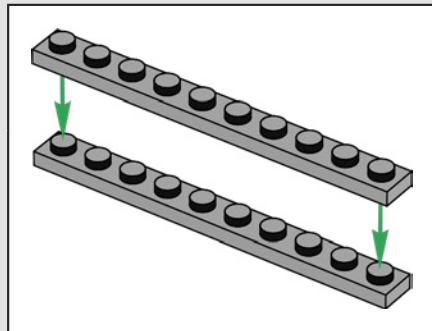



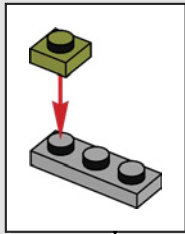
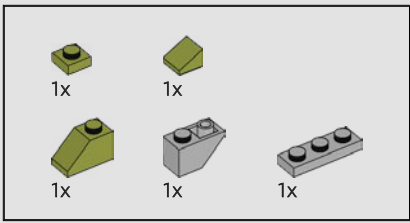

255

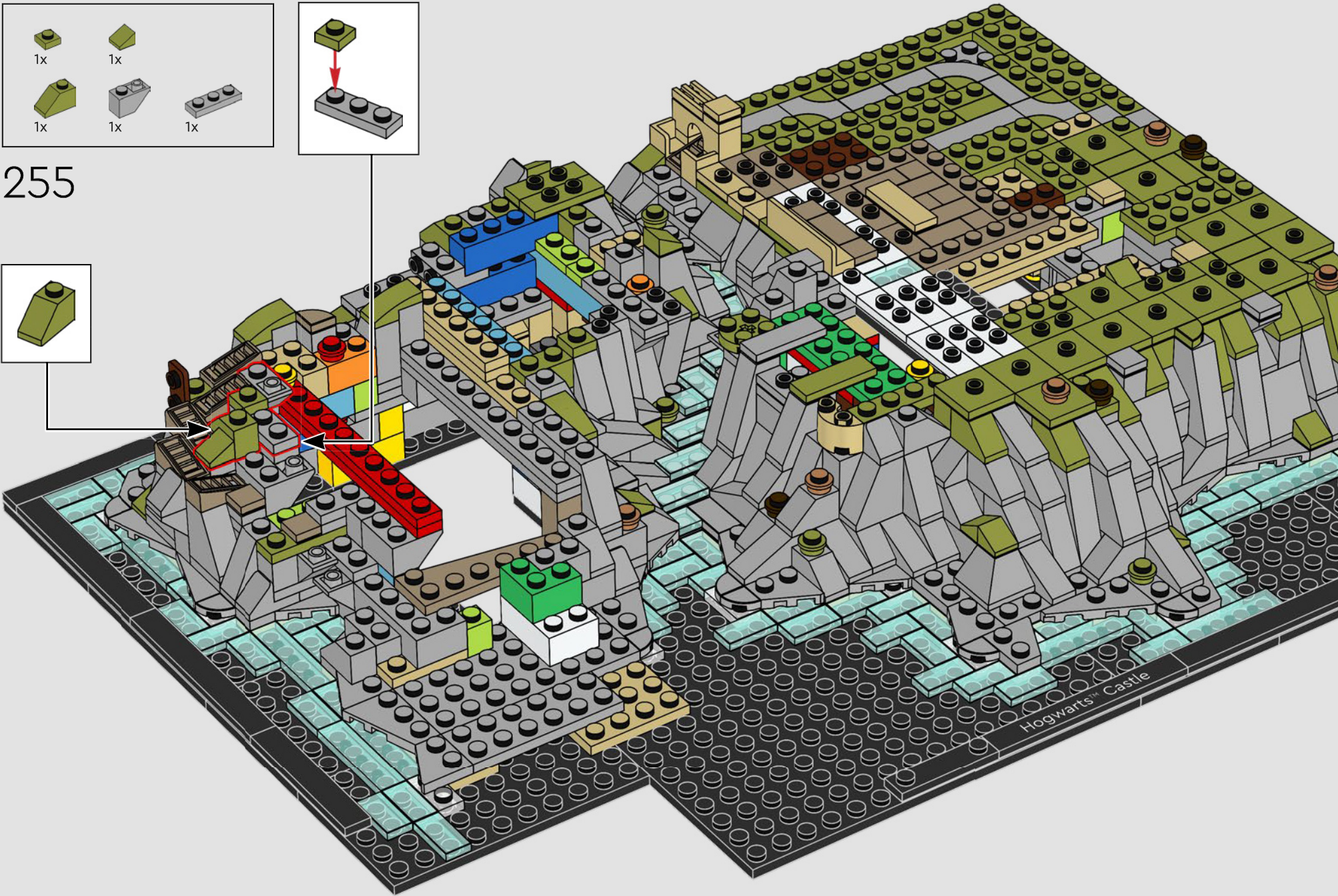



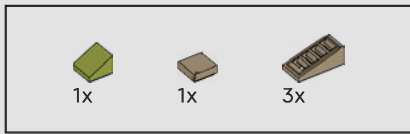

256

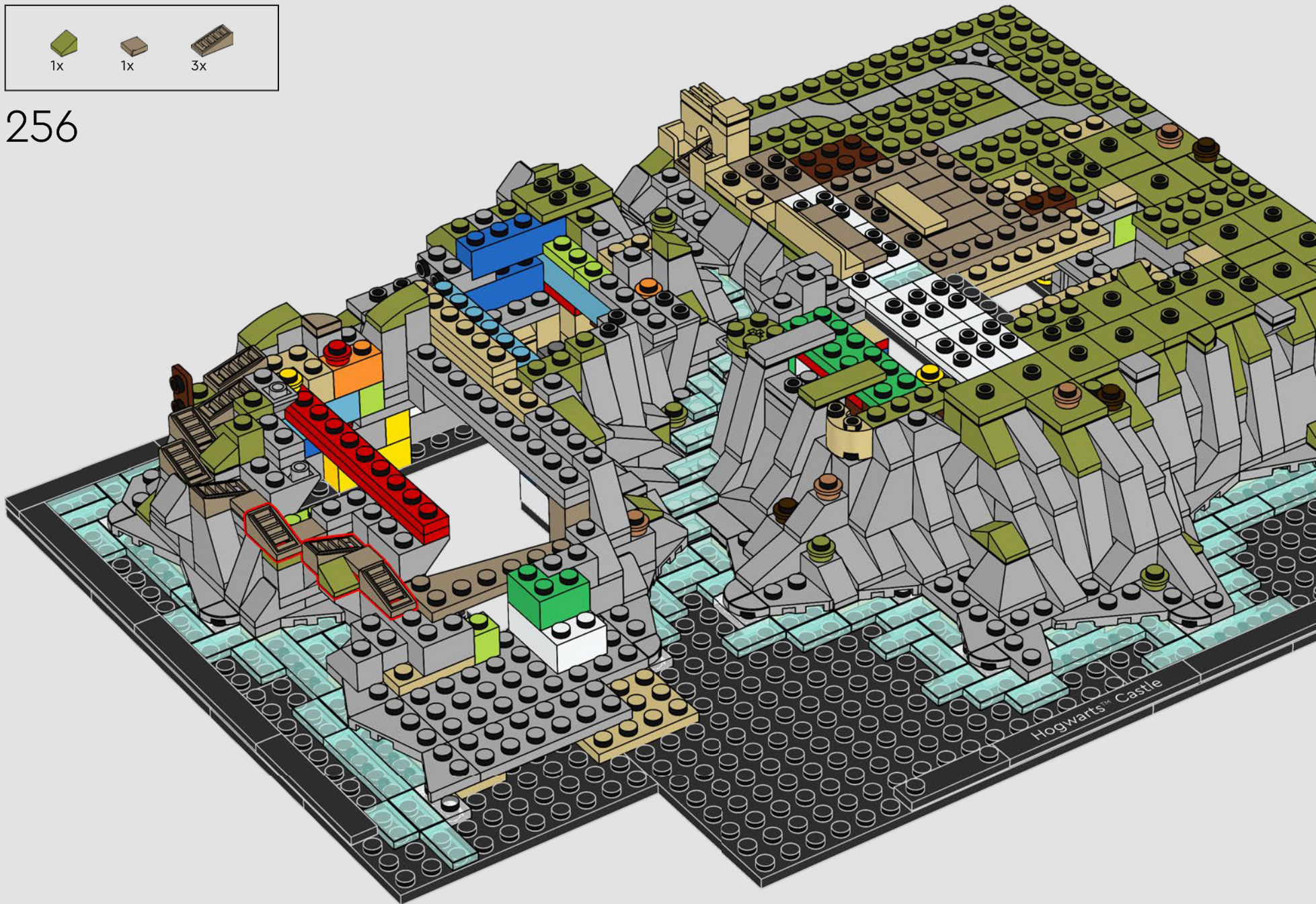



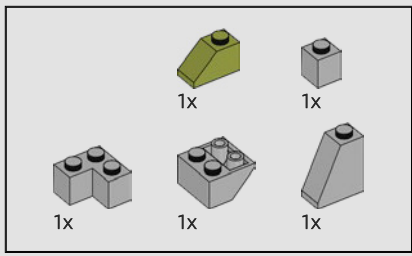

257

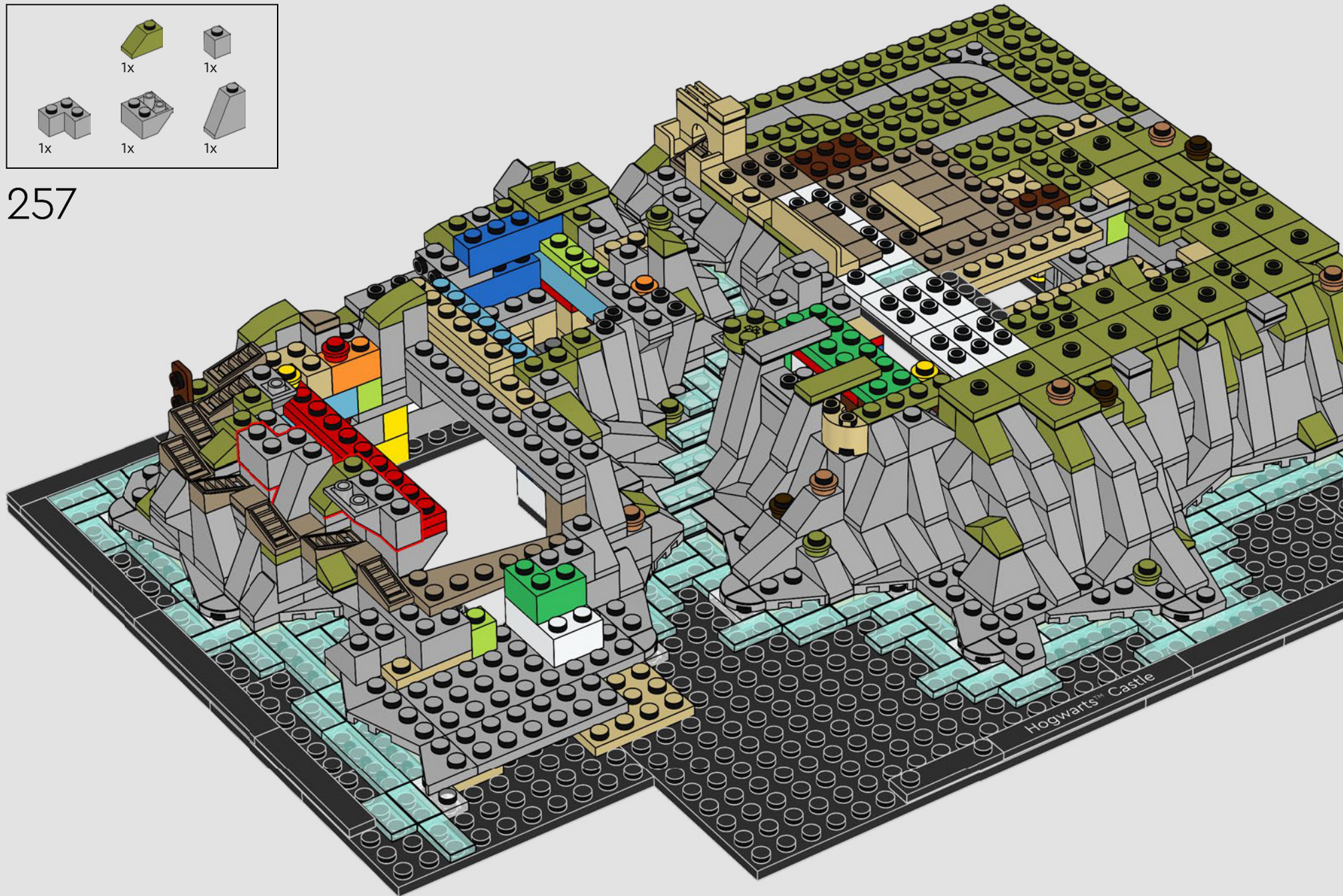



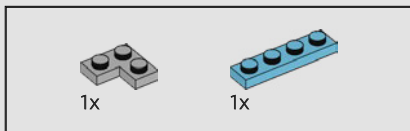

258

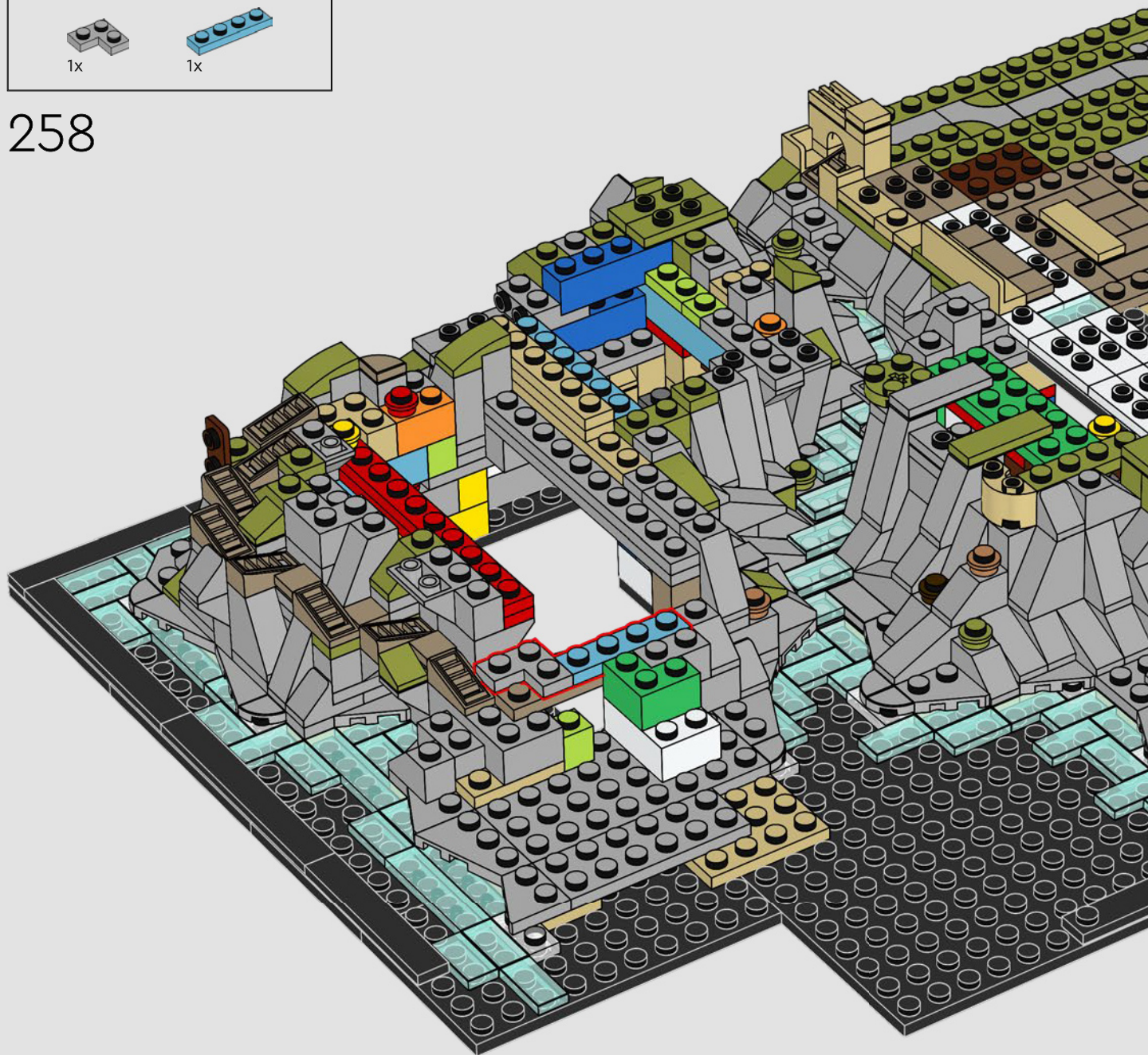

Tosca Tassorosso  
era famosa per i suoi  
incantesimi e le sue  
magie culinarie e molte  
delle sue deliziose ricette  
vengono ancora servite  
alle feste scolastiche.





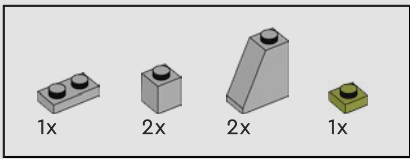

259

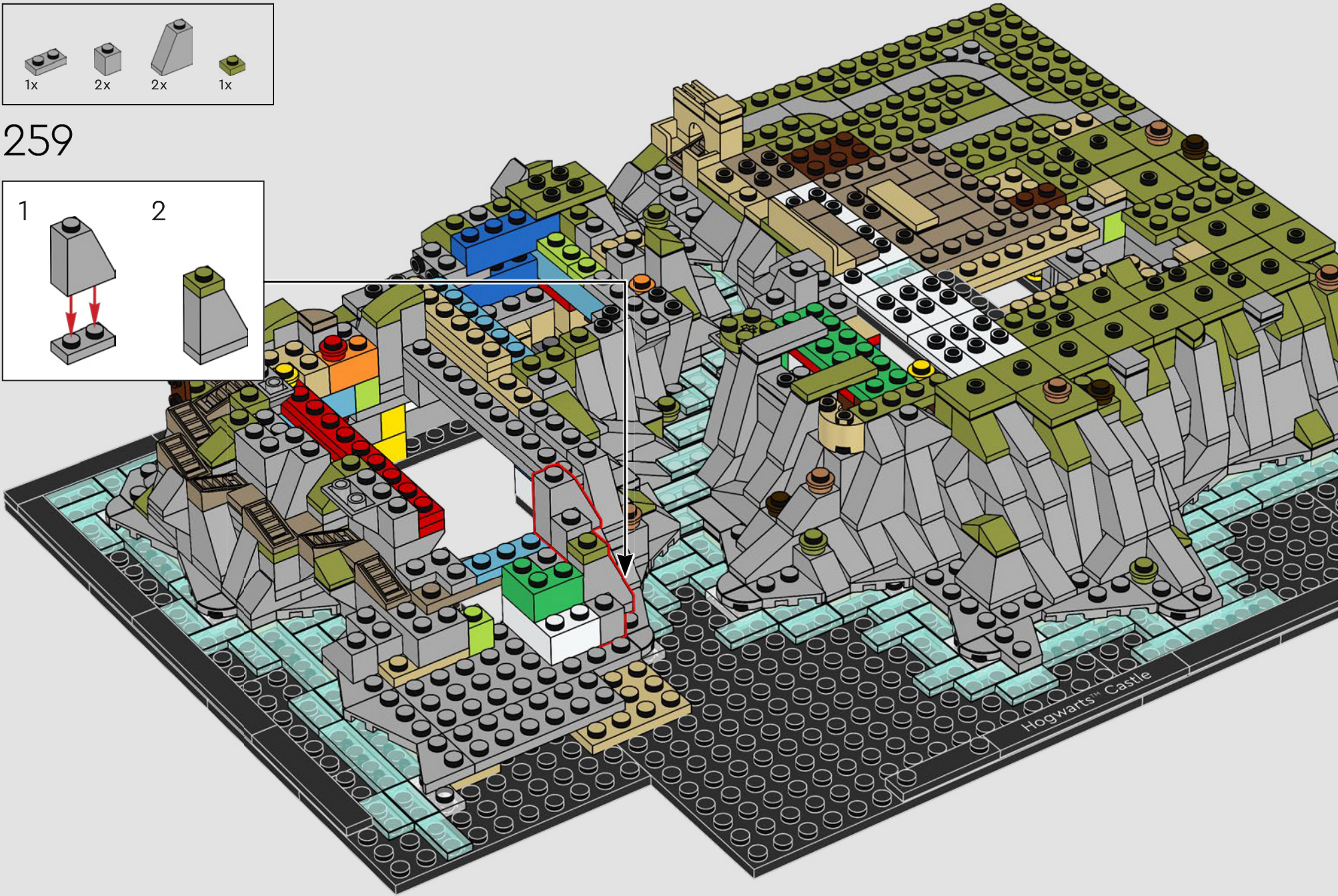
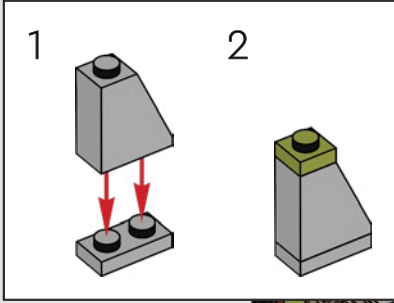



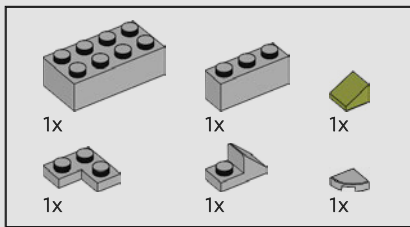

260

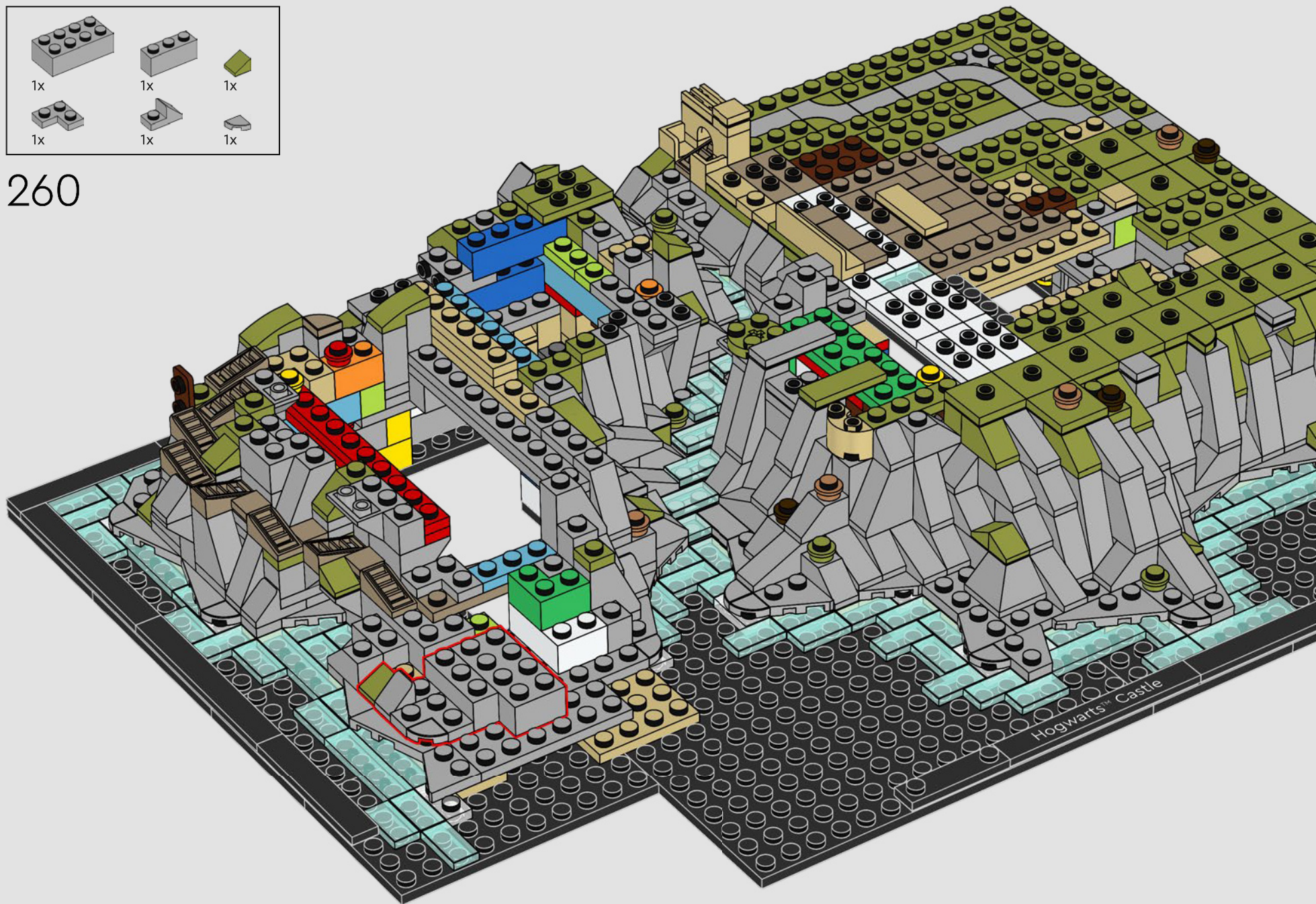



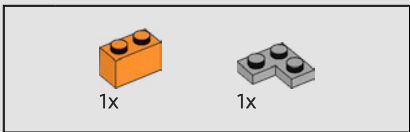

261

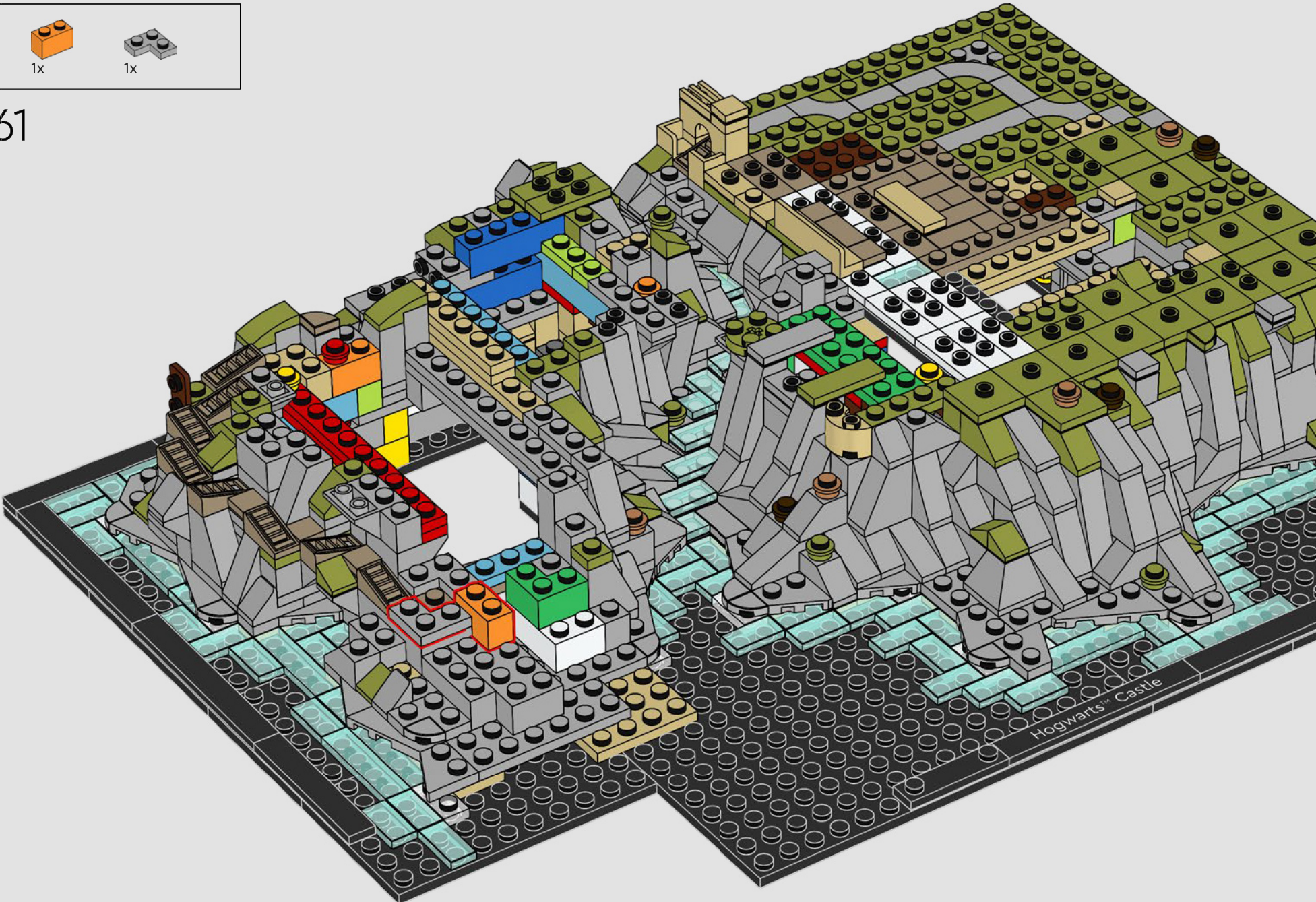



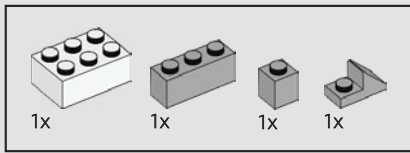

262

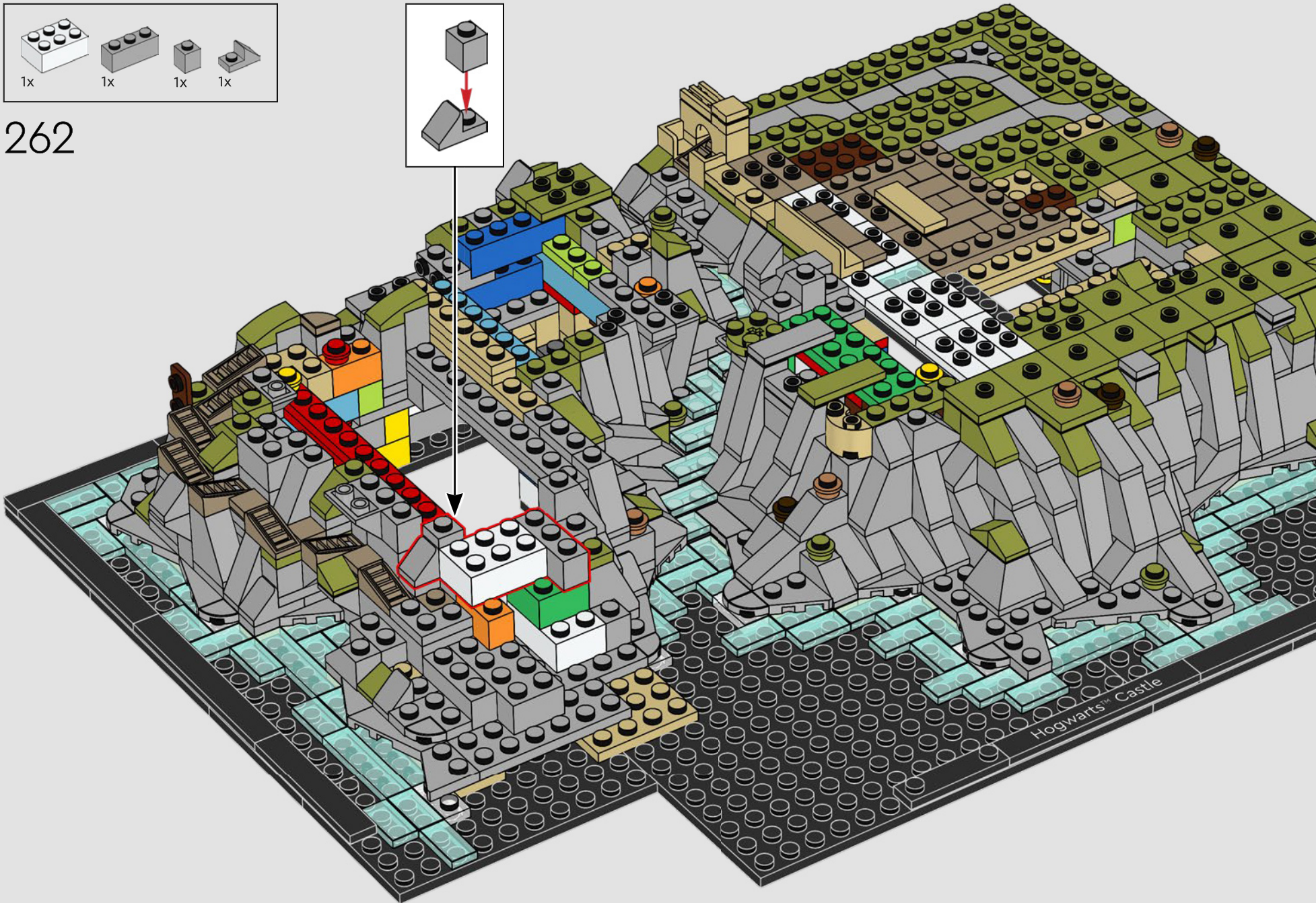
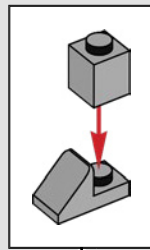

Hogwarts™ Castle





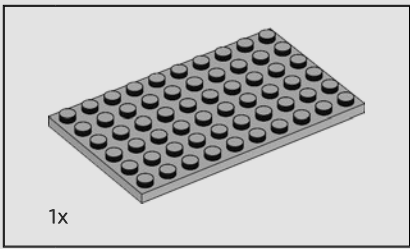

263

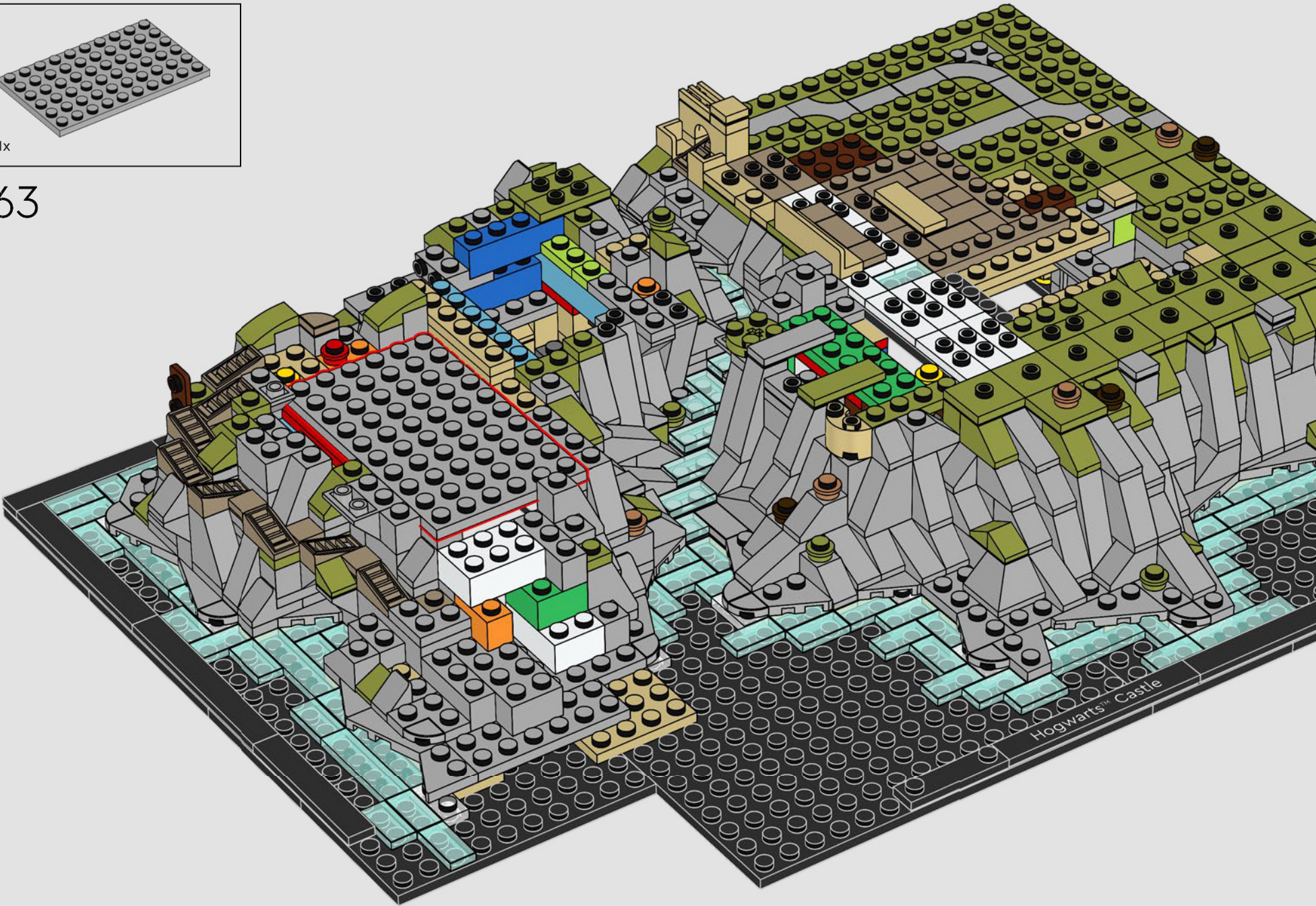



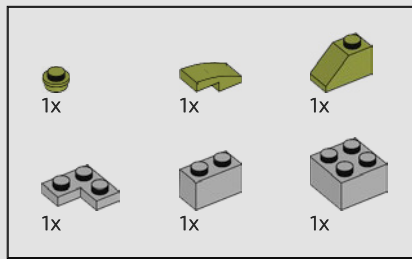

264

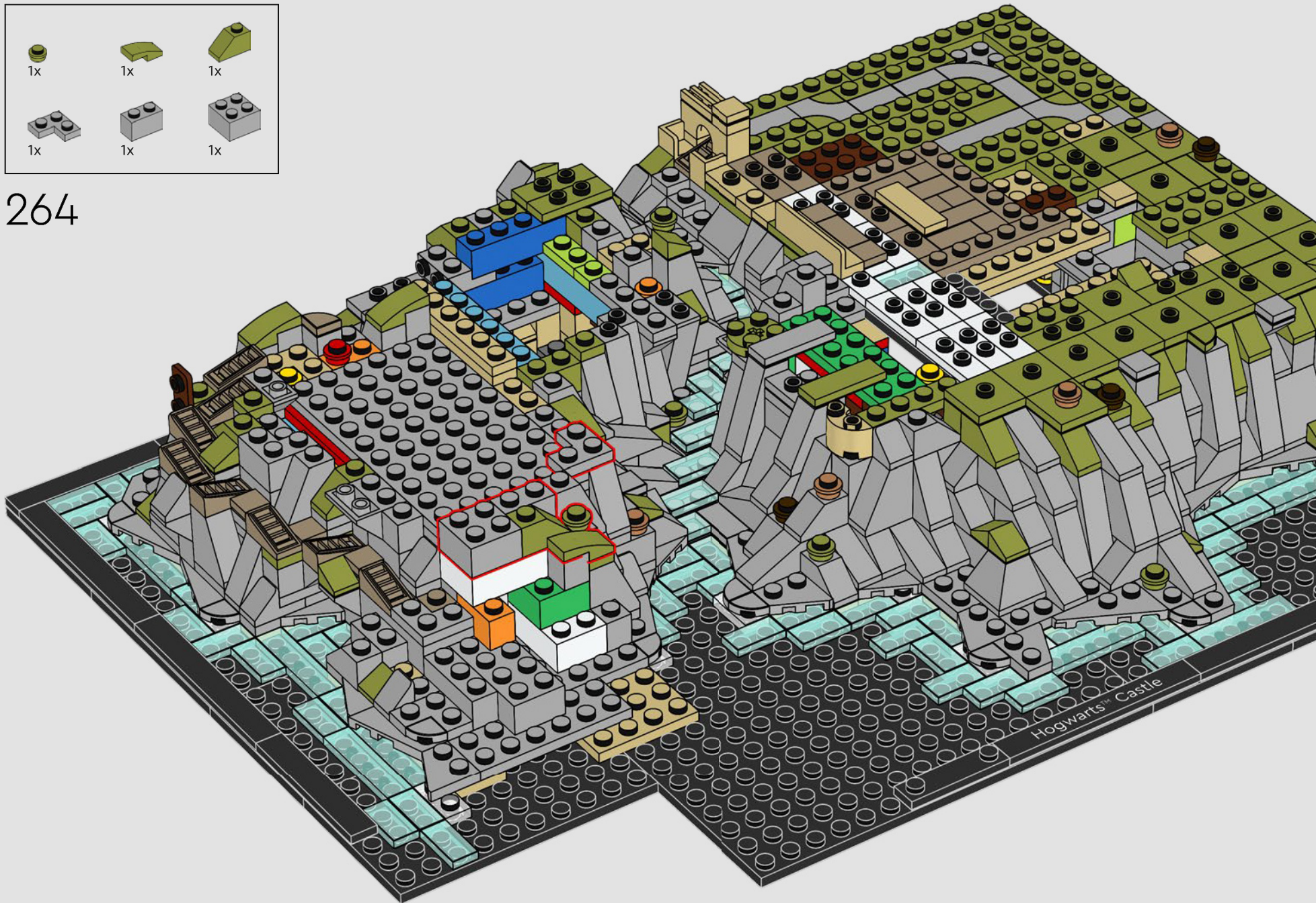



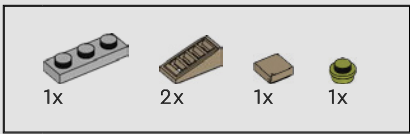

265

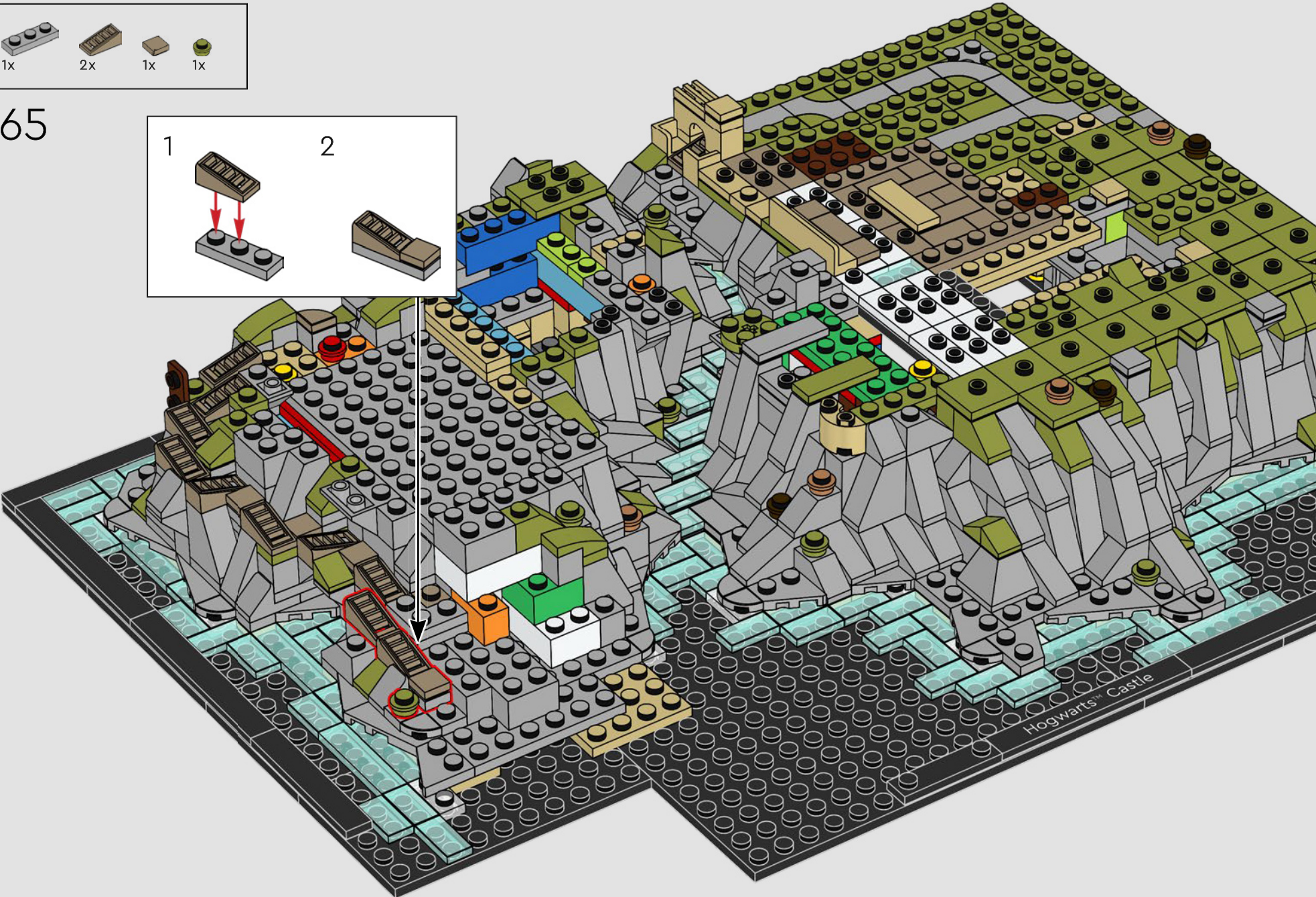
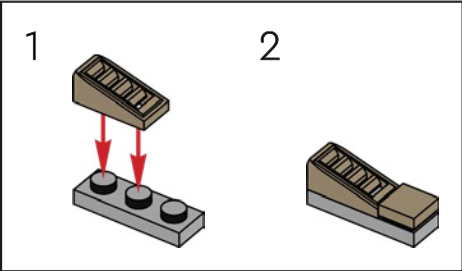



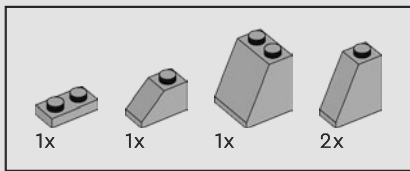

266

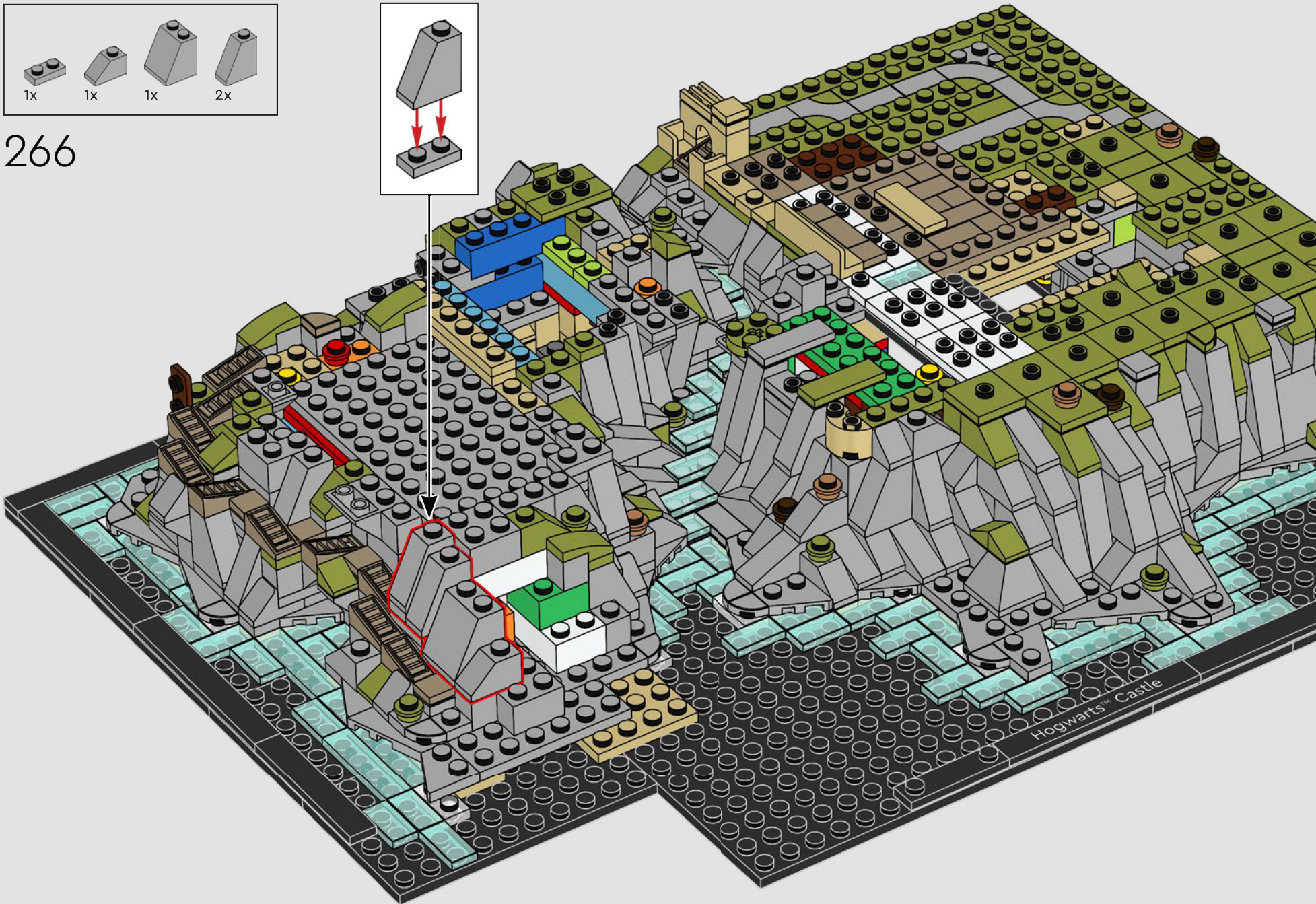
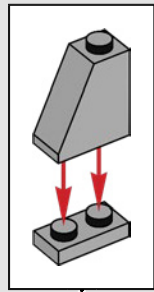



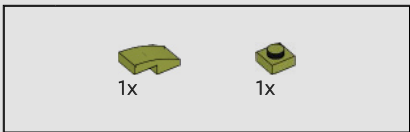

267

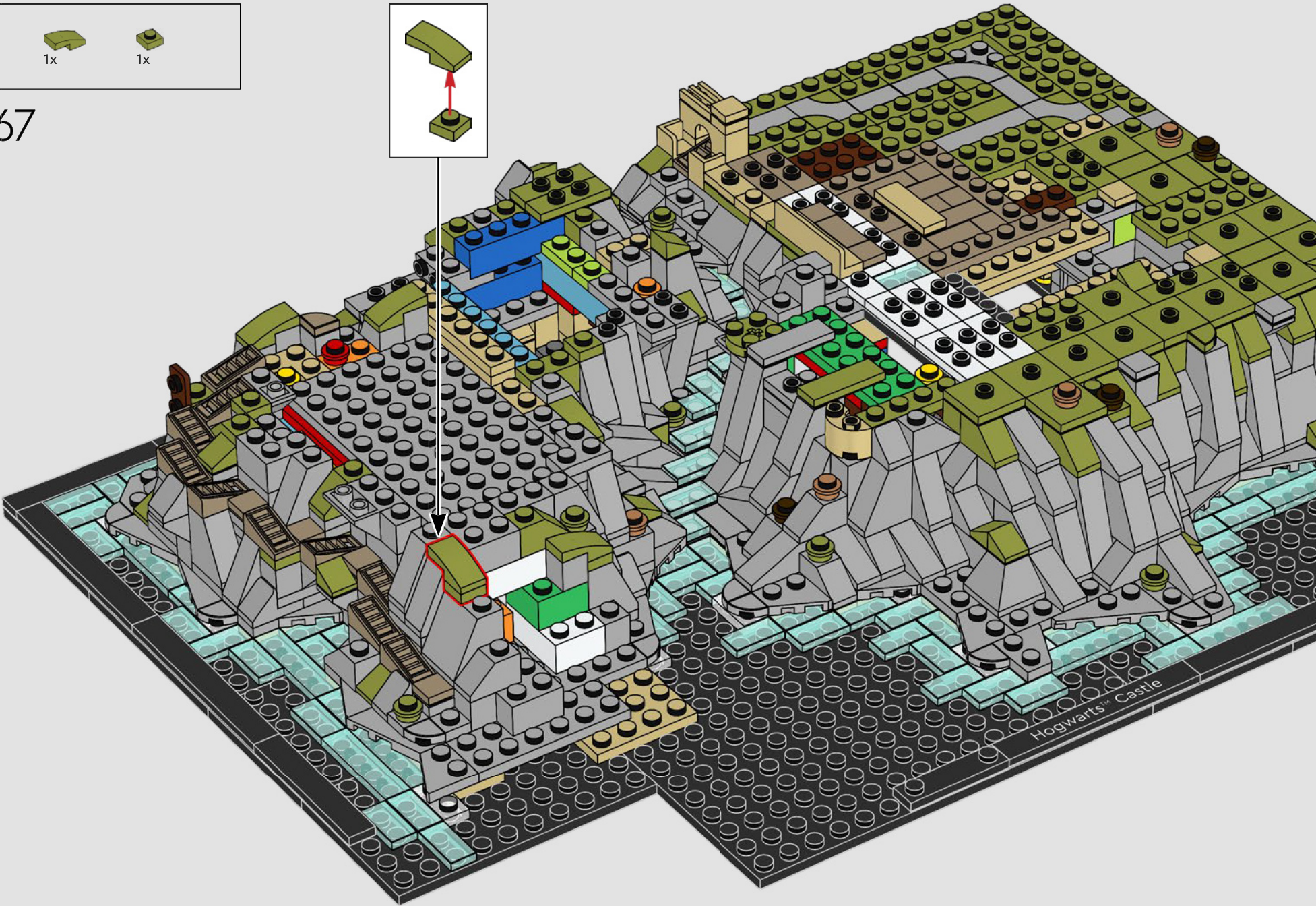
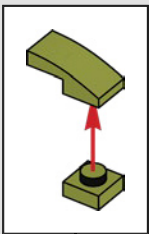





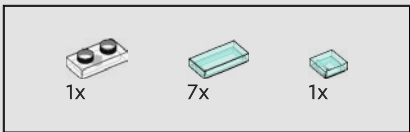

268

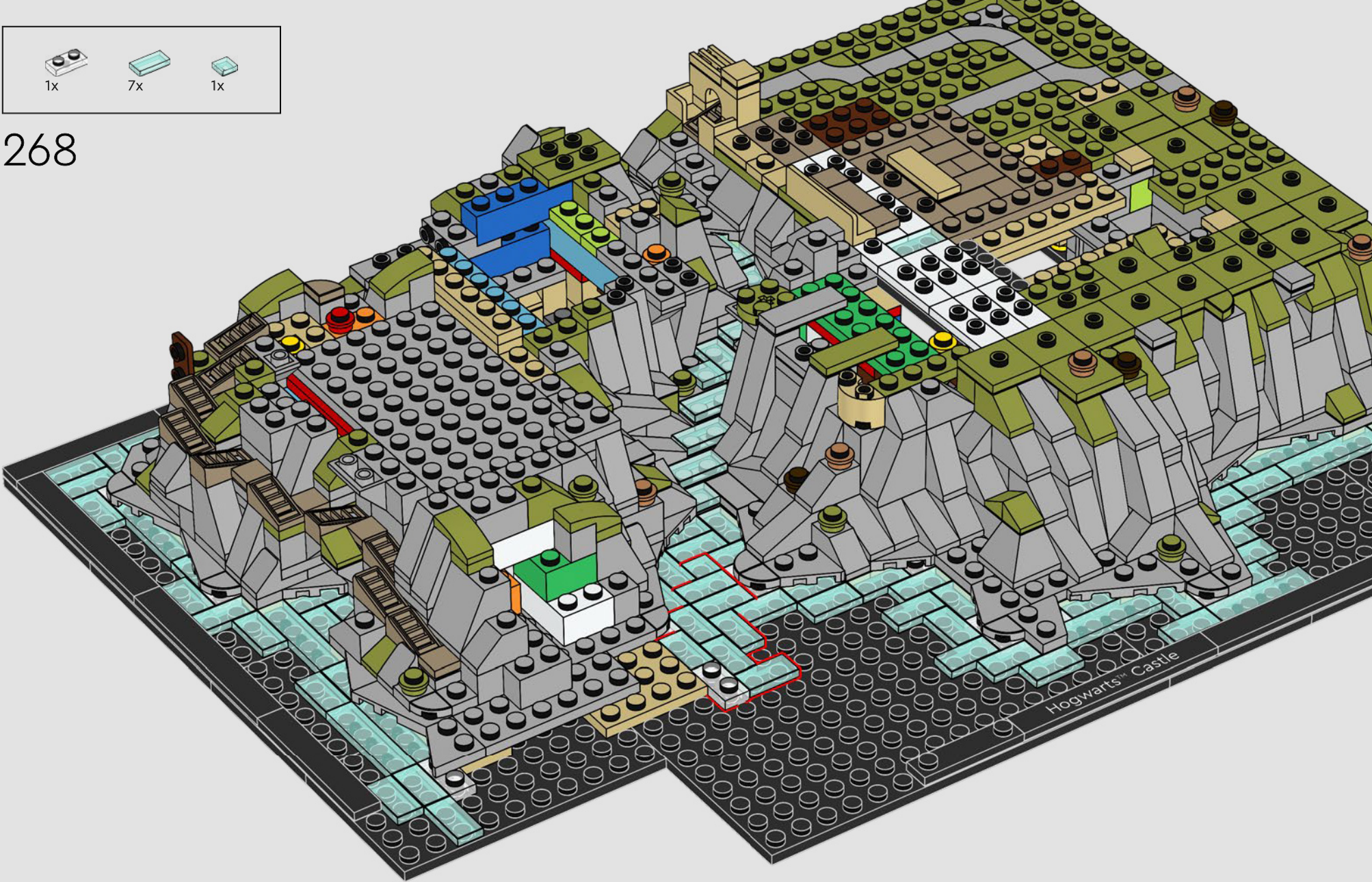



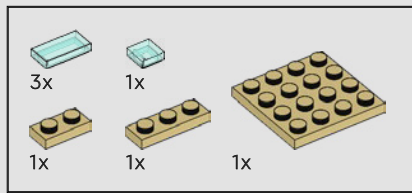

269

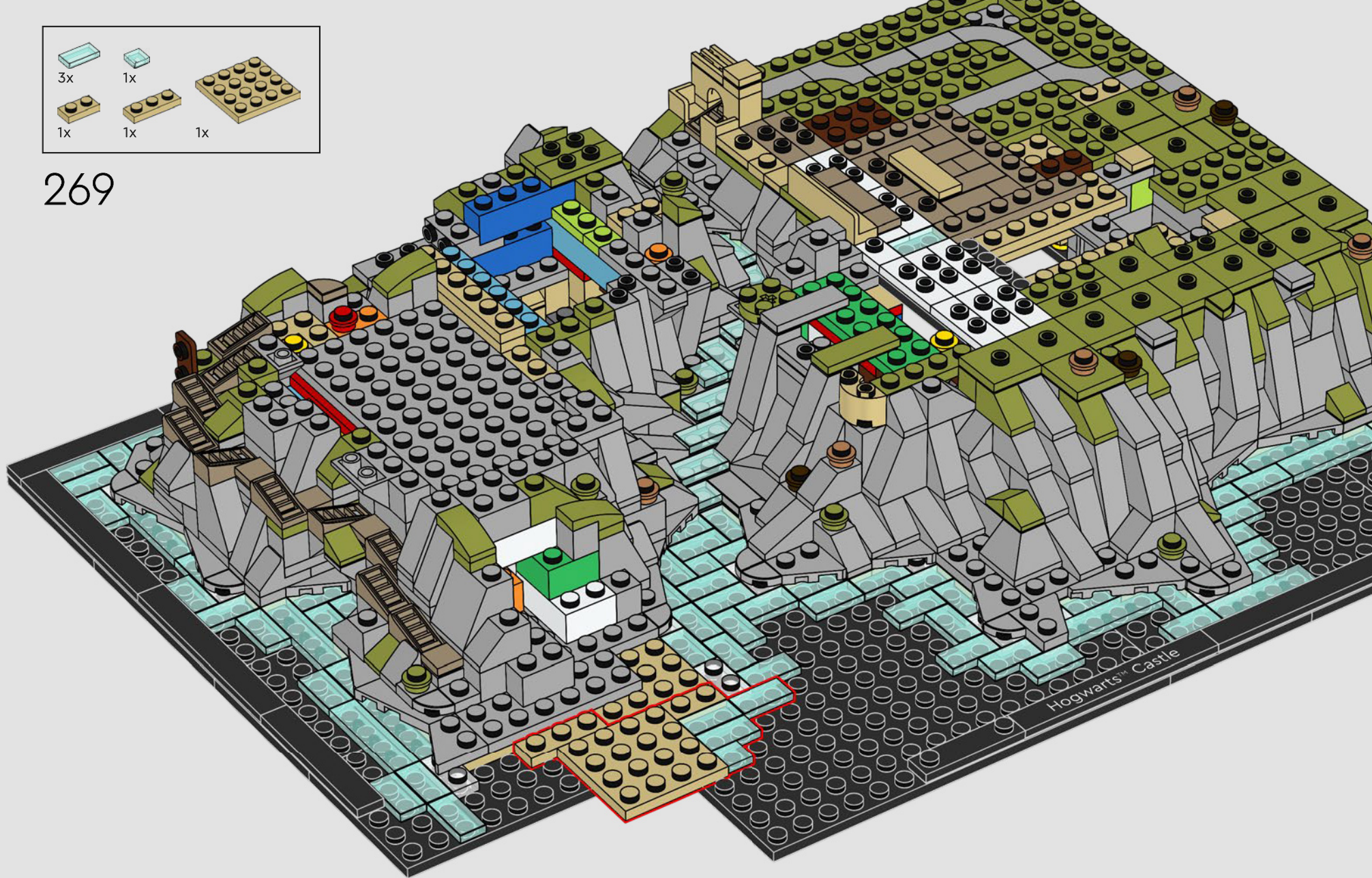



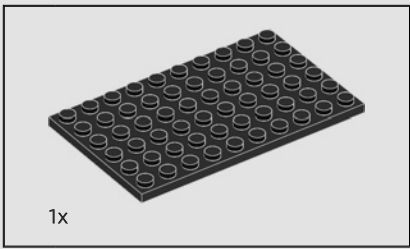

270

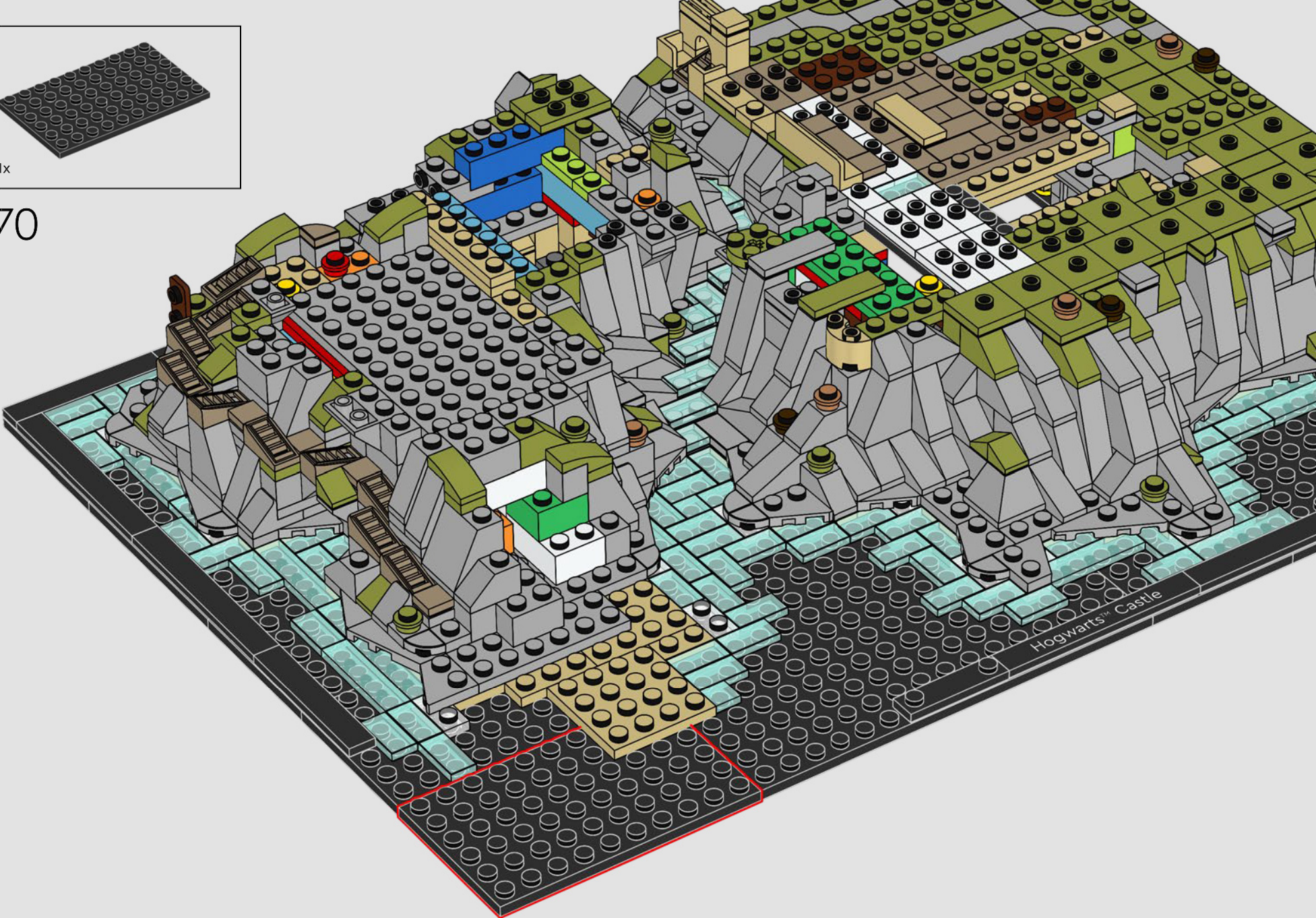



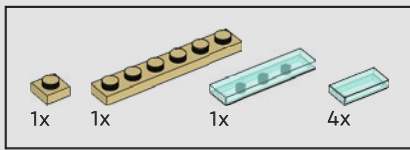

271

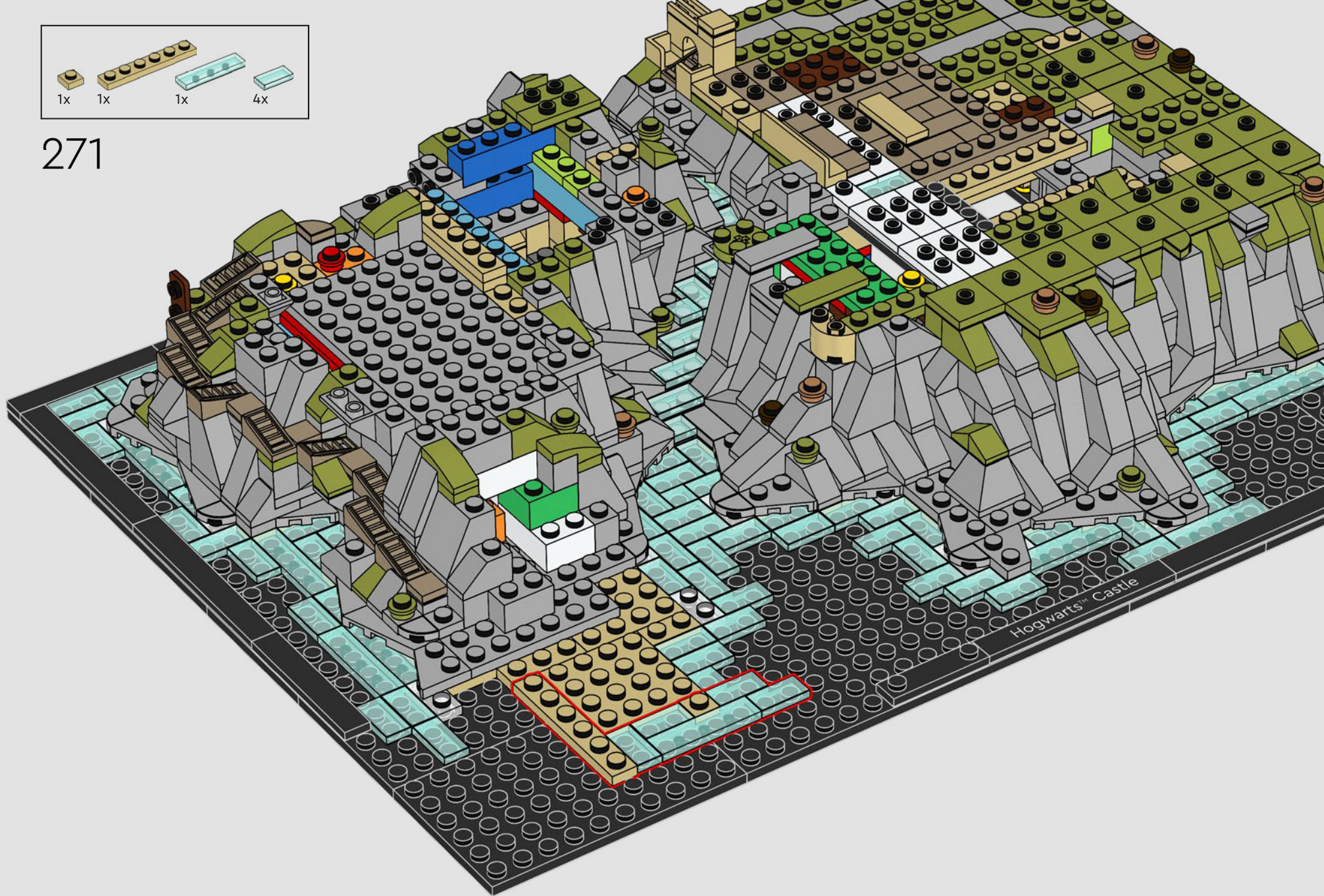

Hogwarts™ Castle





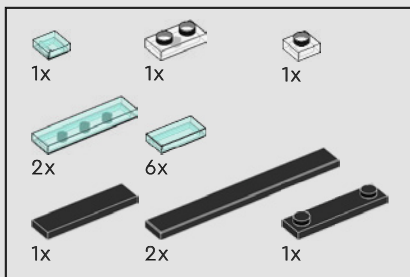

272

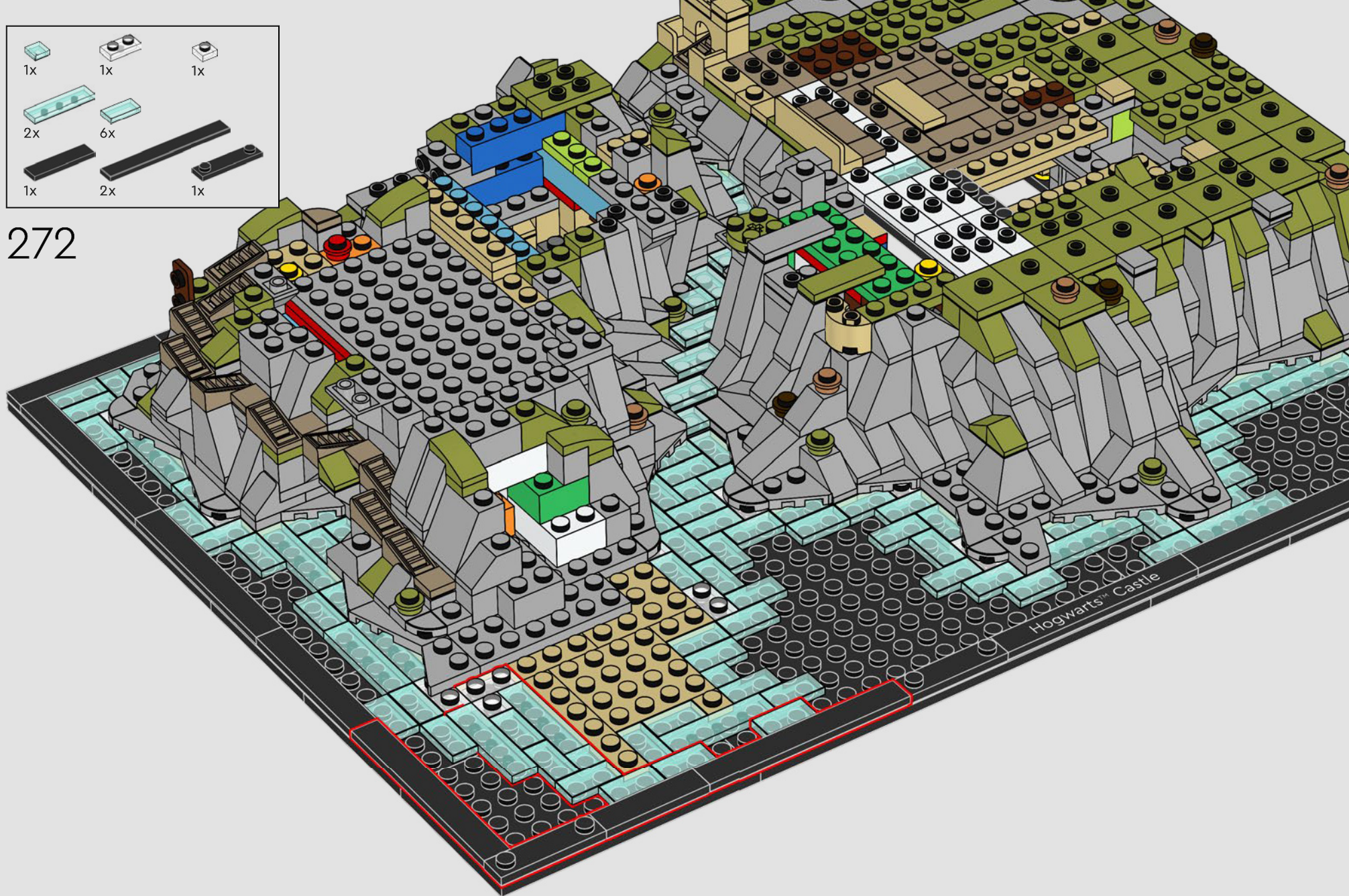



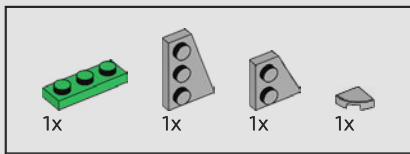

273

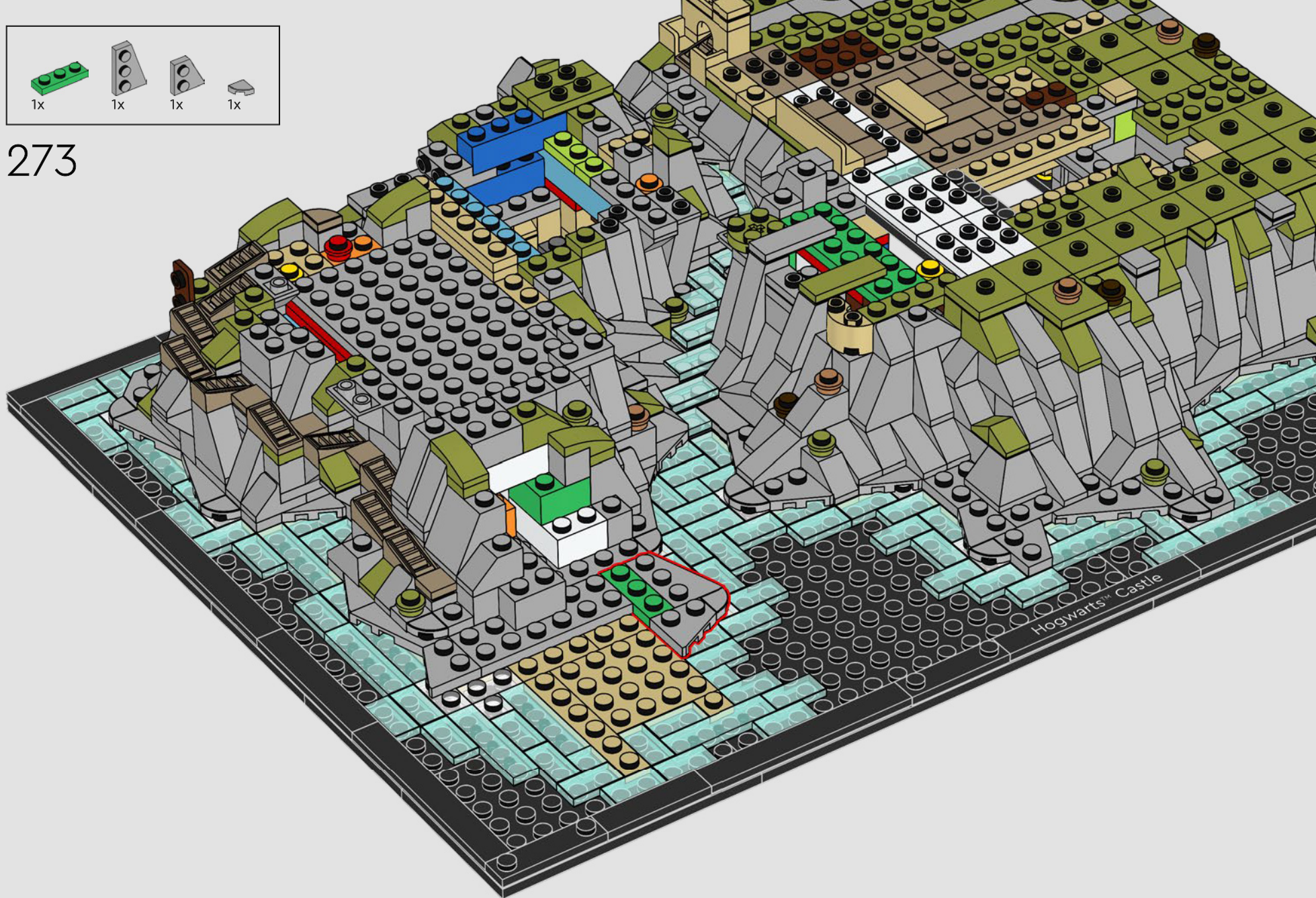

Hogwarts™ Castle





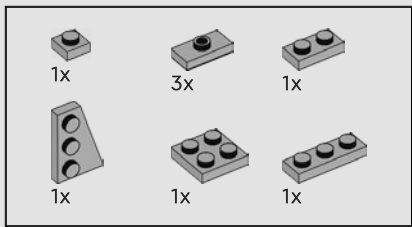

274





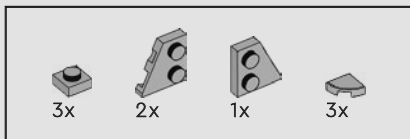

275

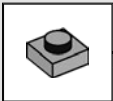
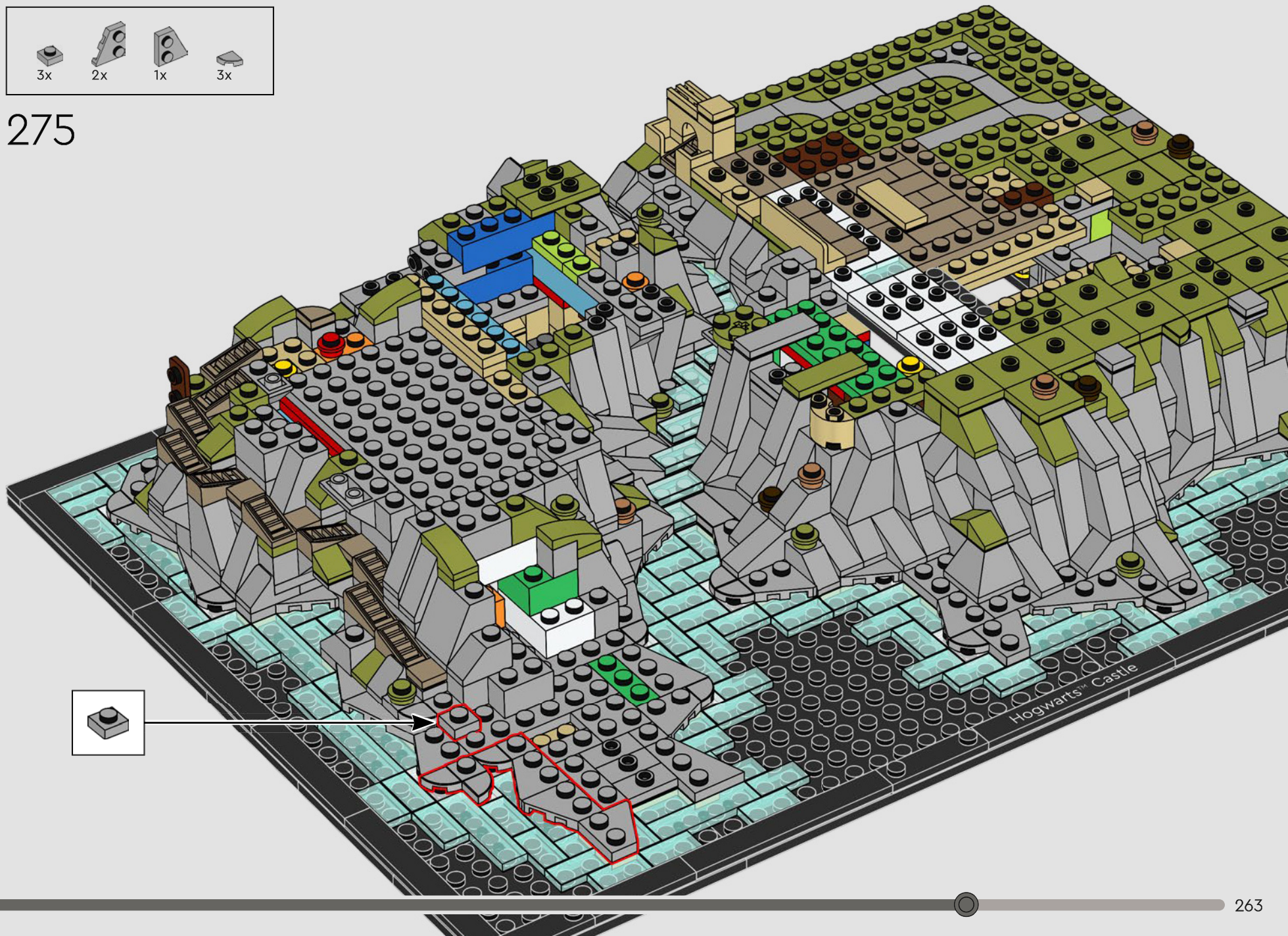

Hogwarts™ Castle



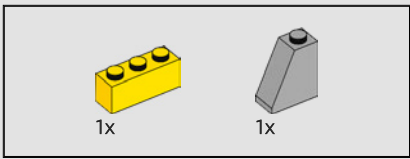

276



L'eredità di Godric Grifondoro è ancora viva nel Cappello Parlante, una soluzione per smistare equamente gli studenti nelle loro case.



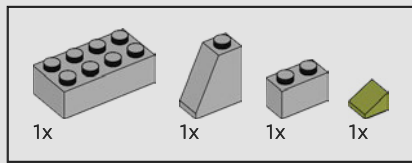

277

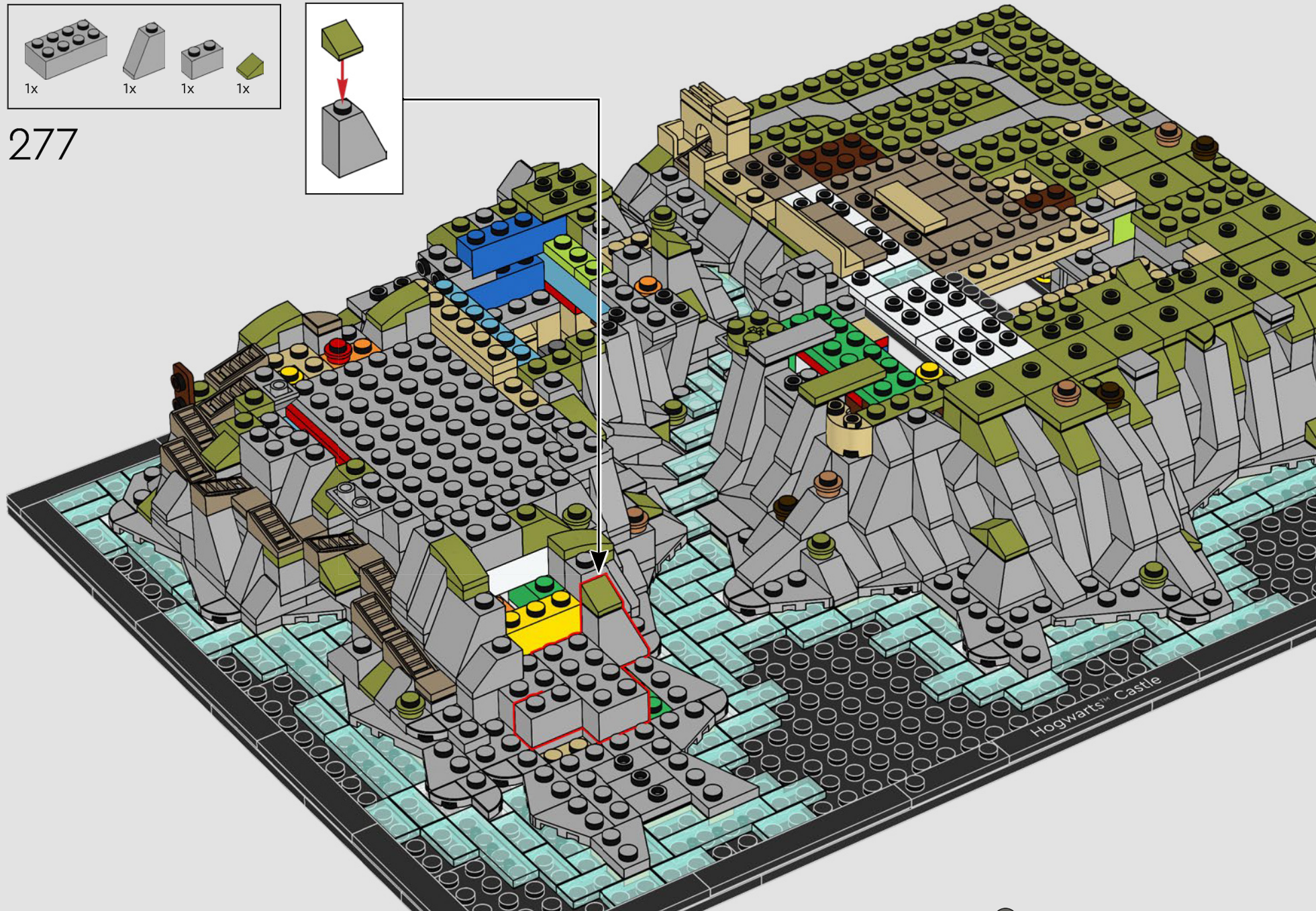
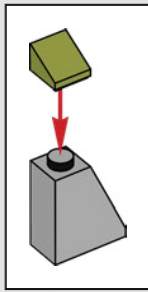

Hogwarts™ Castle





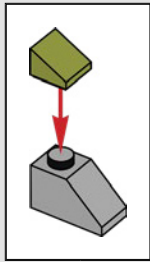
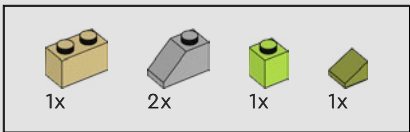

278

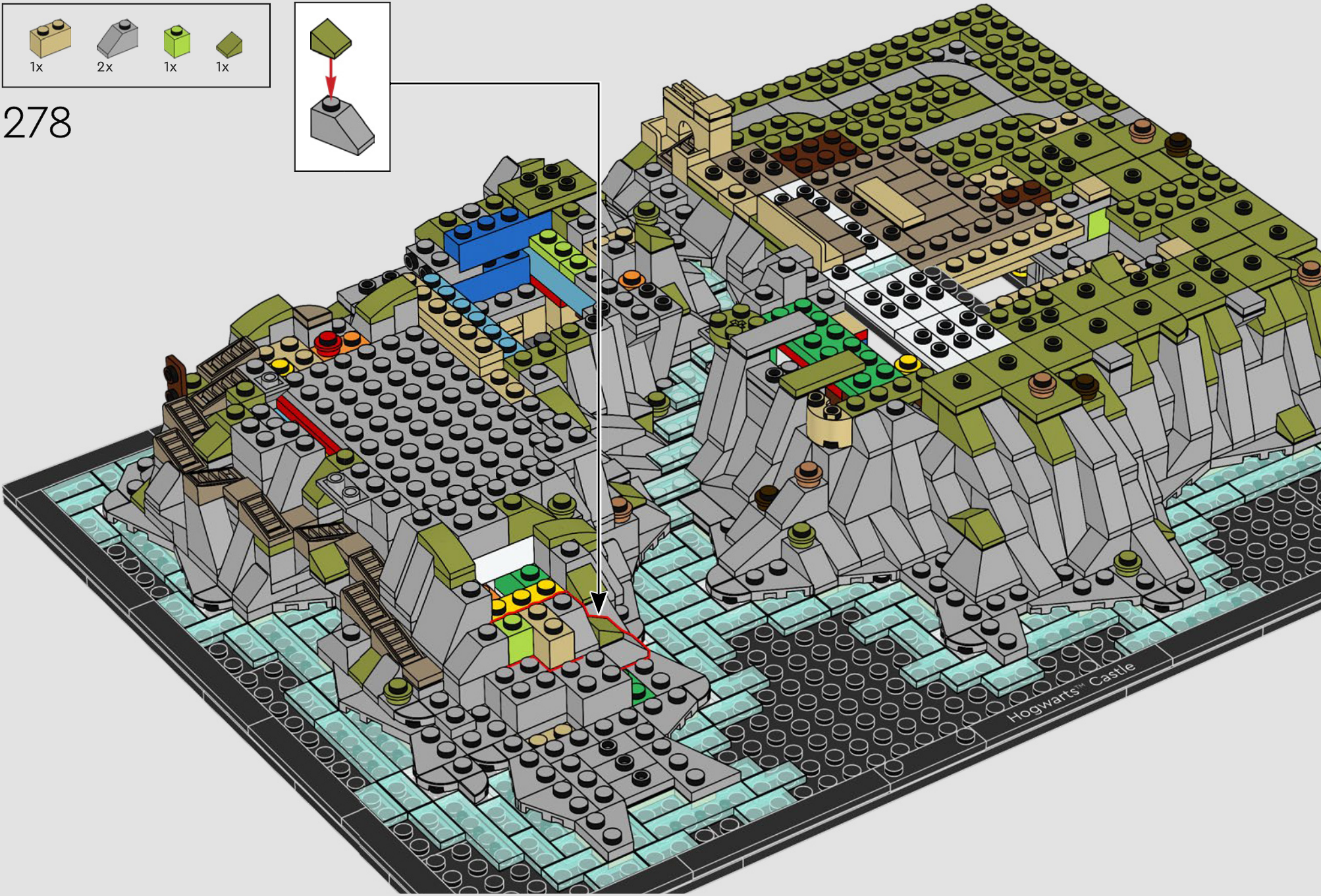



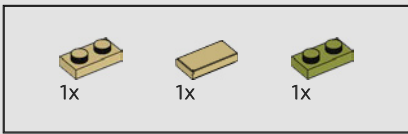

279

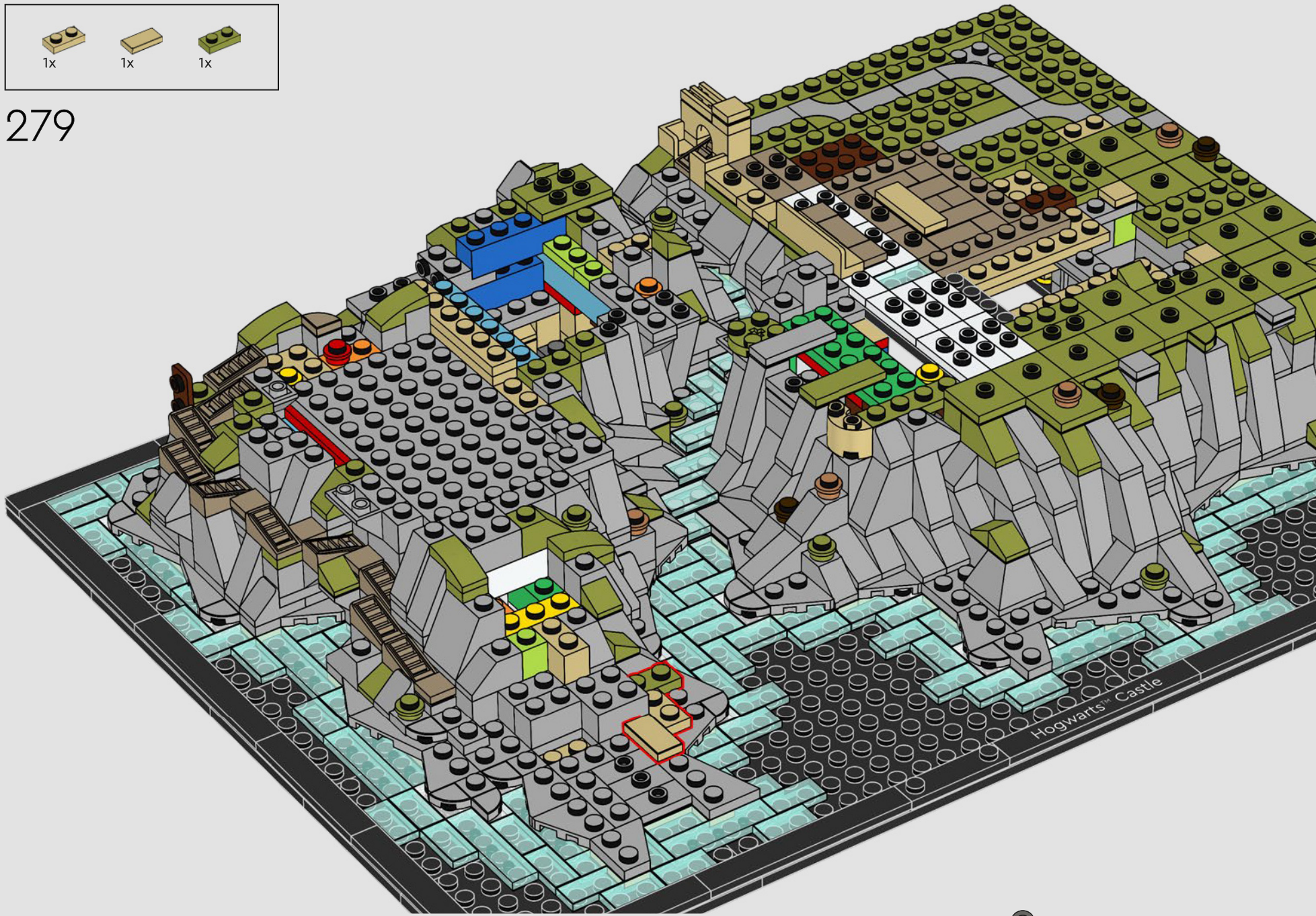



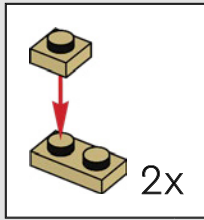
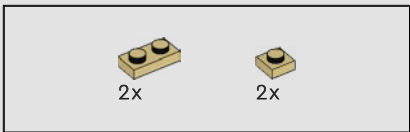

280

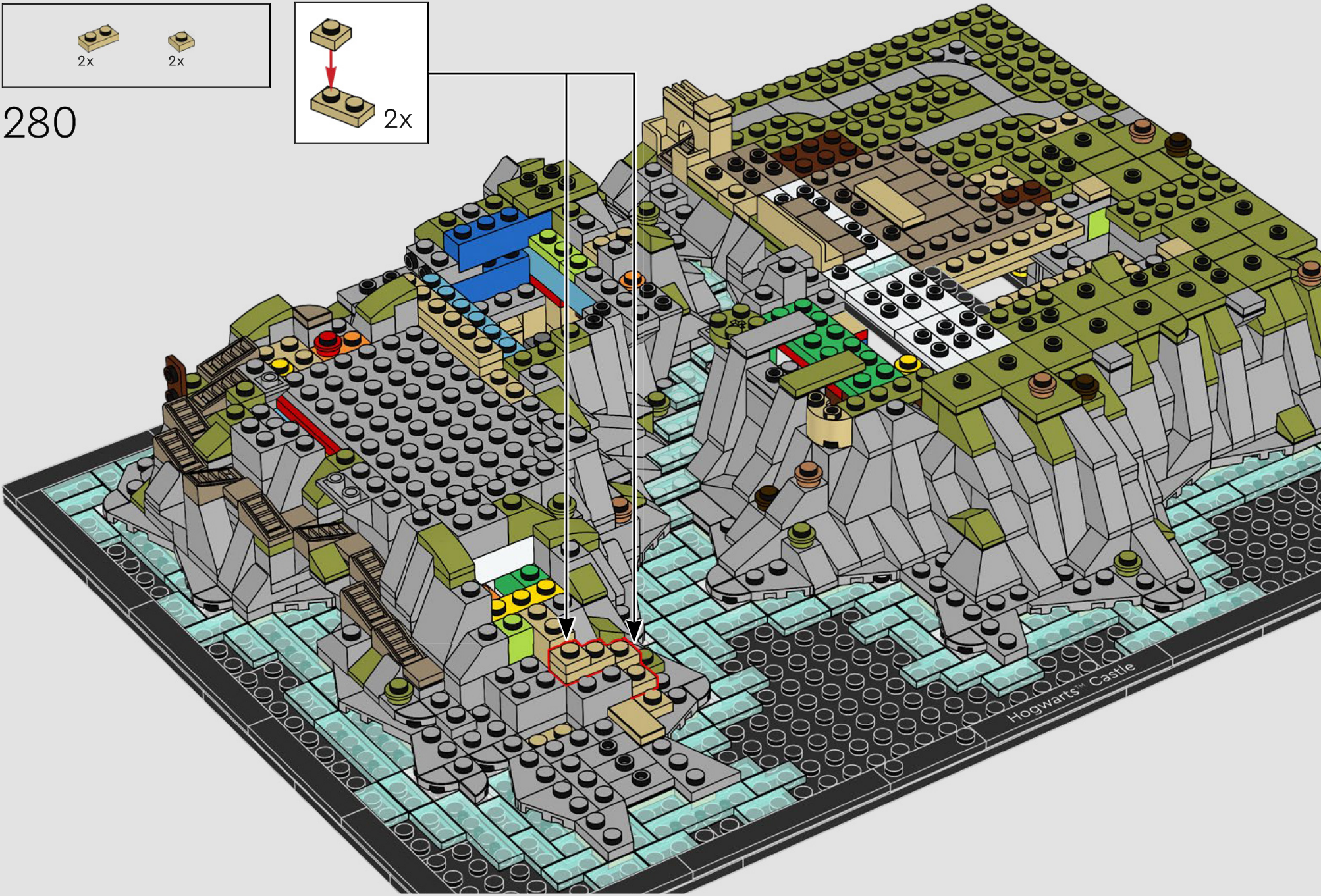



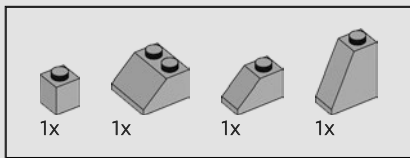

281







282





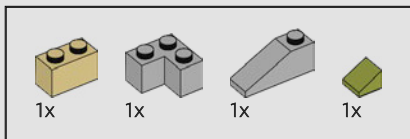

283

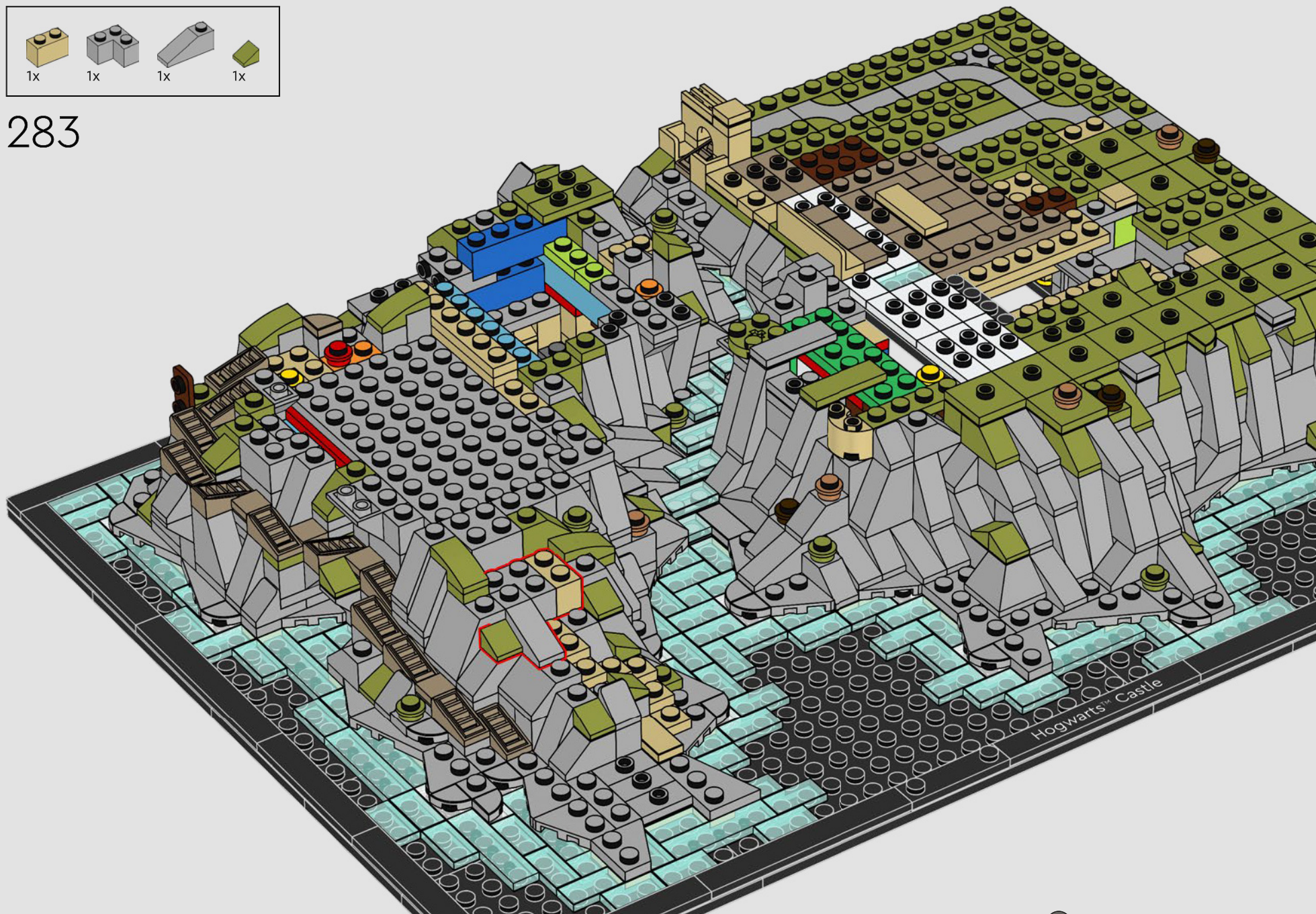

Hogwarts™ Castle





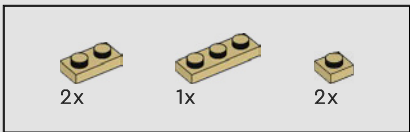

284

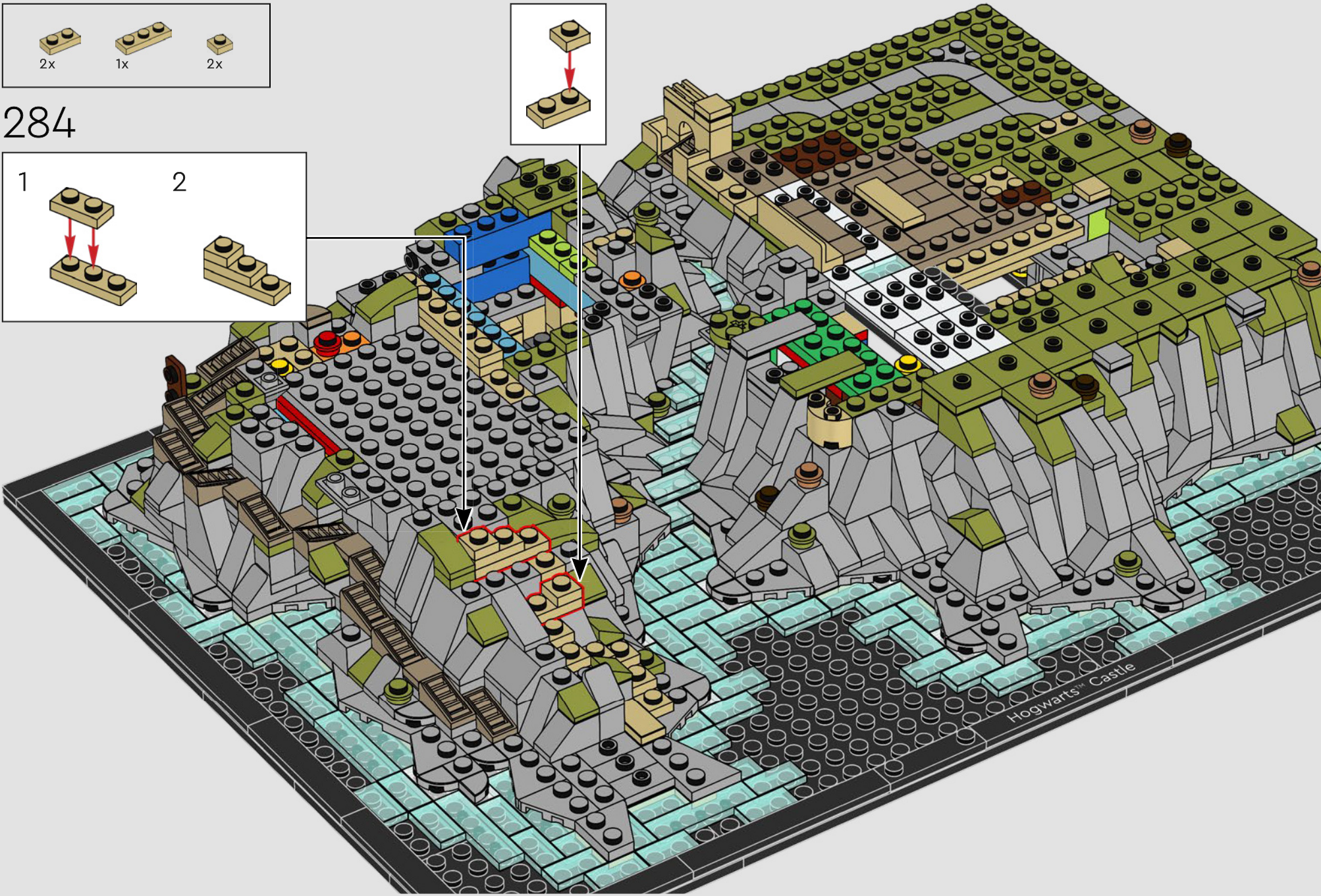
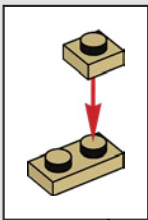
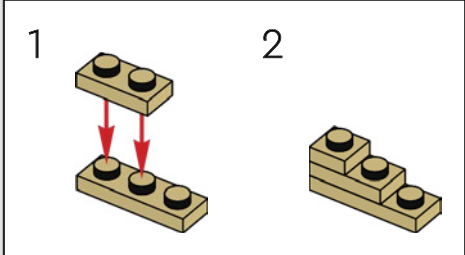





285

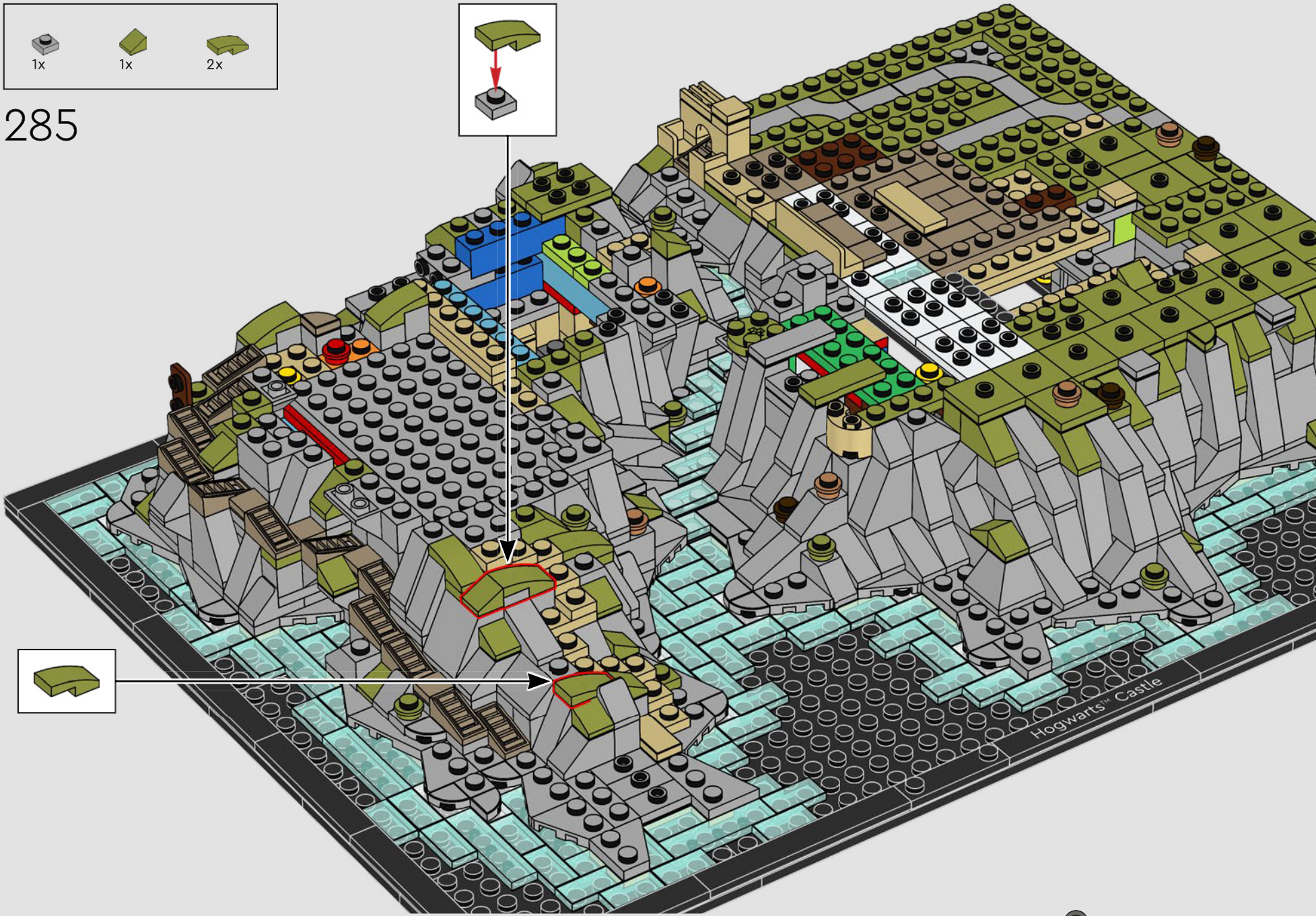
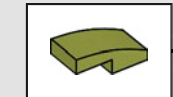
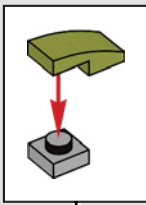

Hogwarts™ Castle





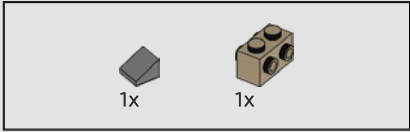
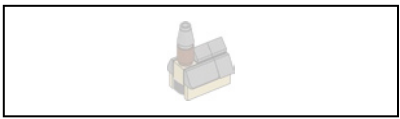

286

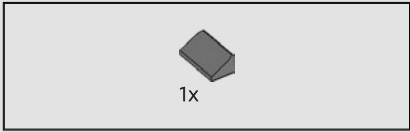
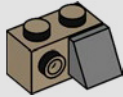

287

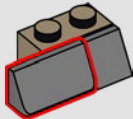

288

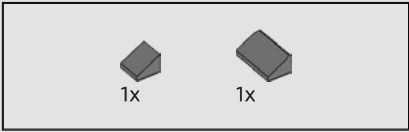
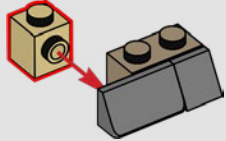

289

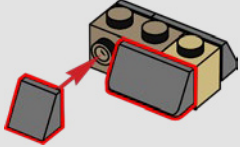

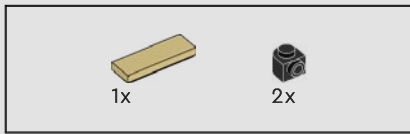

290

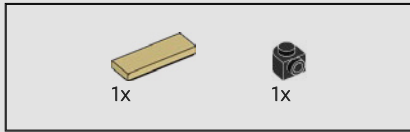
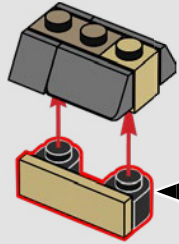
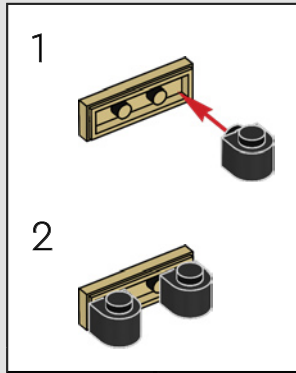

291

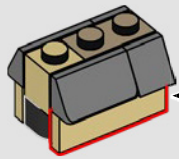
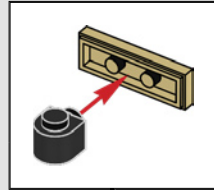

292

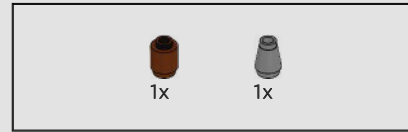
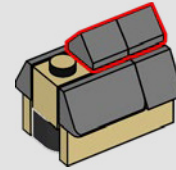

293

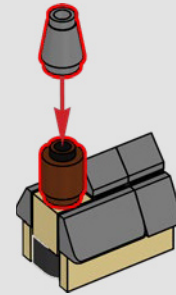



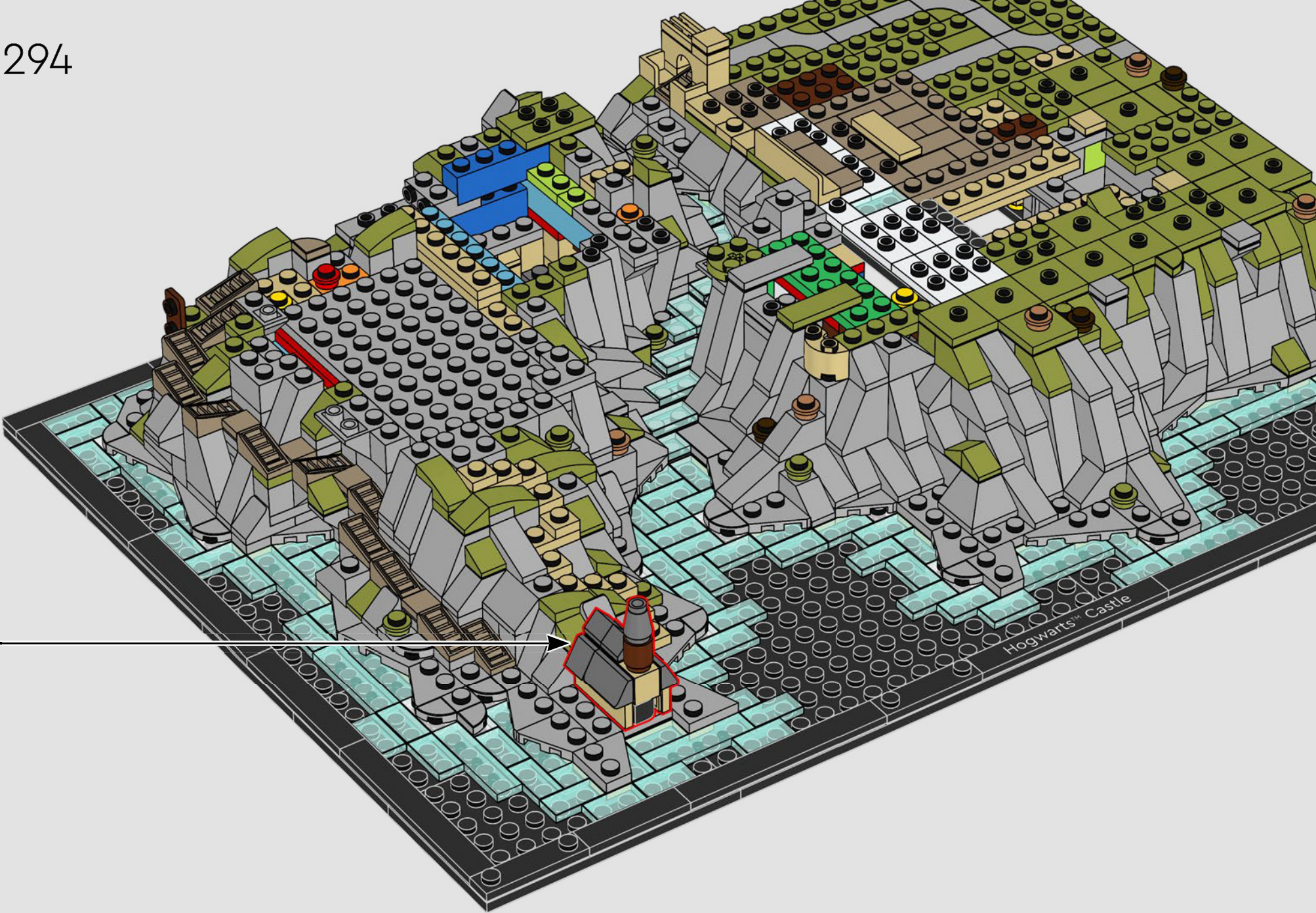



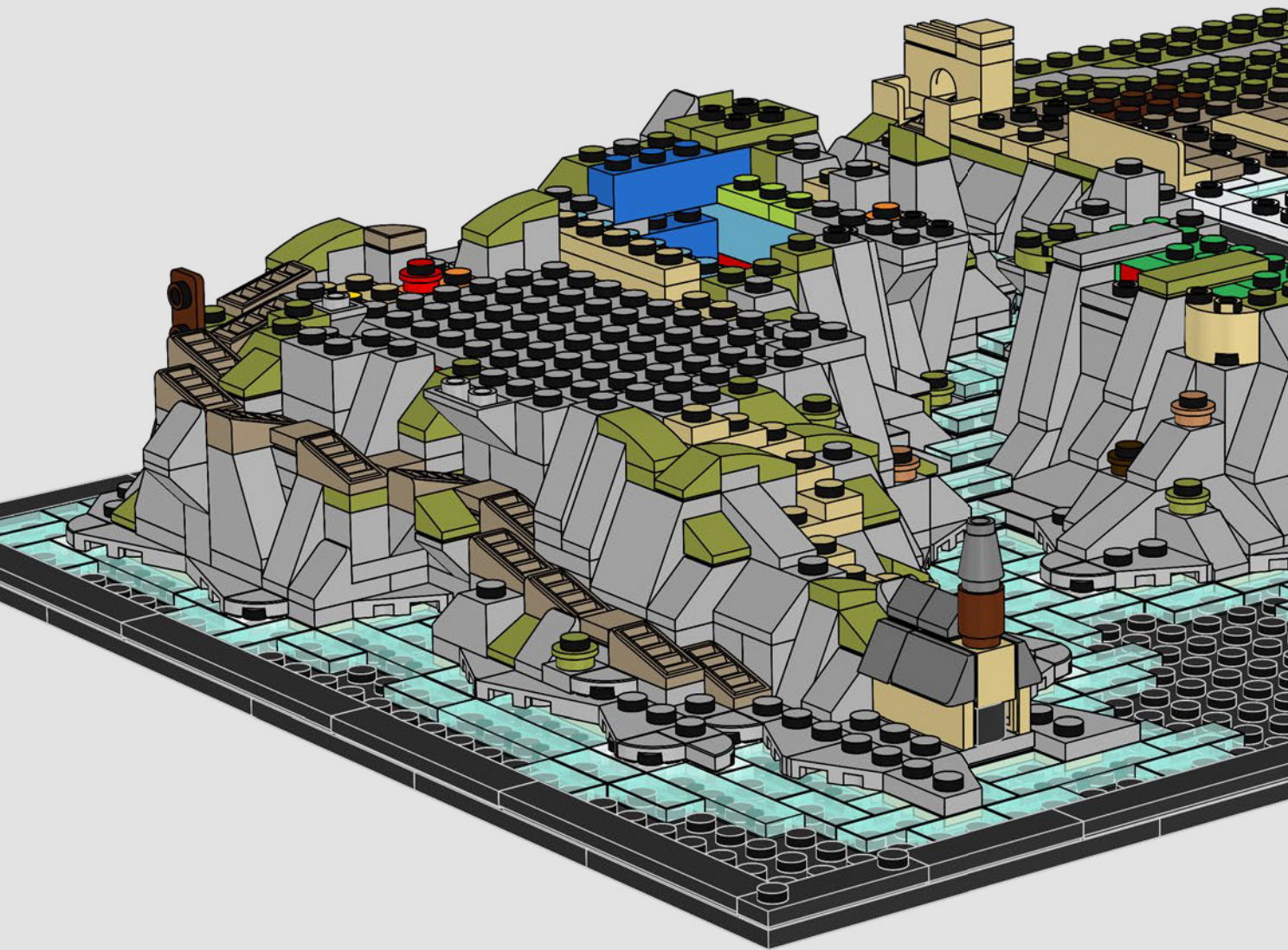

Ogni anno, il 1° settembre, barche incantate trasportano i nuovi studenti del primo anno, scesi dall'Espresso per Hogwarts™ alla stazione di Hogsmeade, alla rimessa delle barche di Hogwarts dopo aver attraversato il Lago Nero.







295





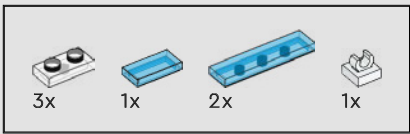

296

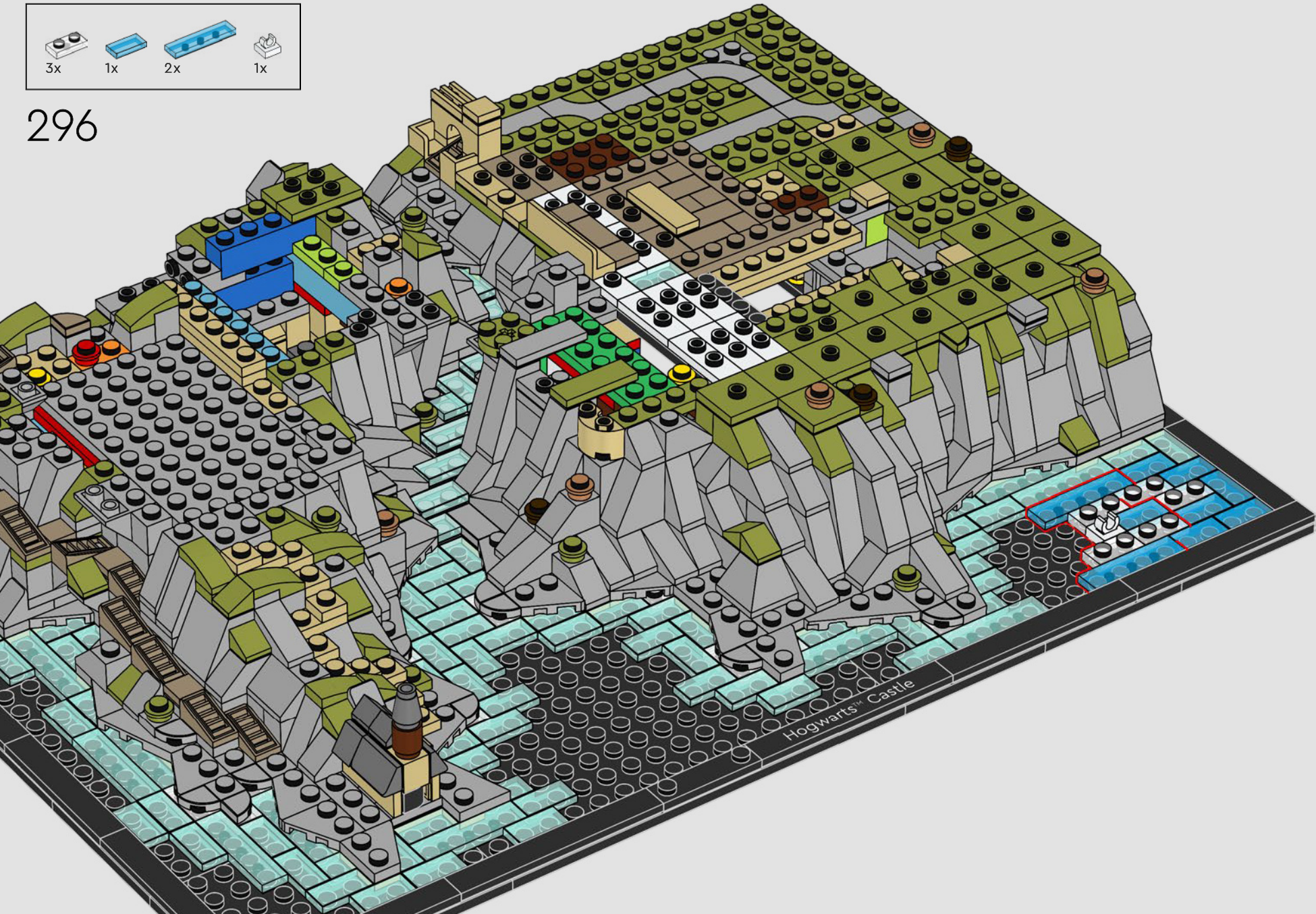



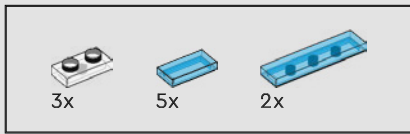

297

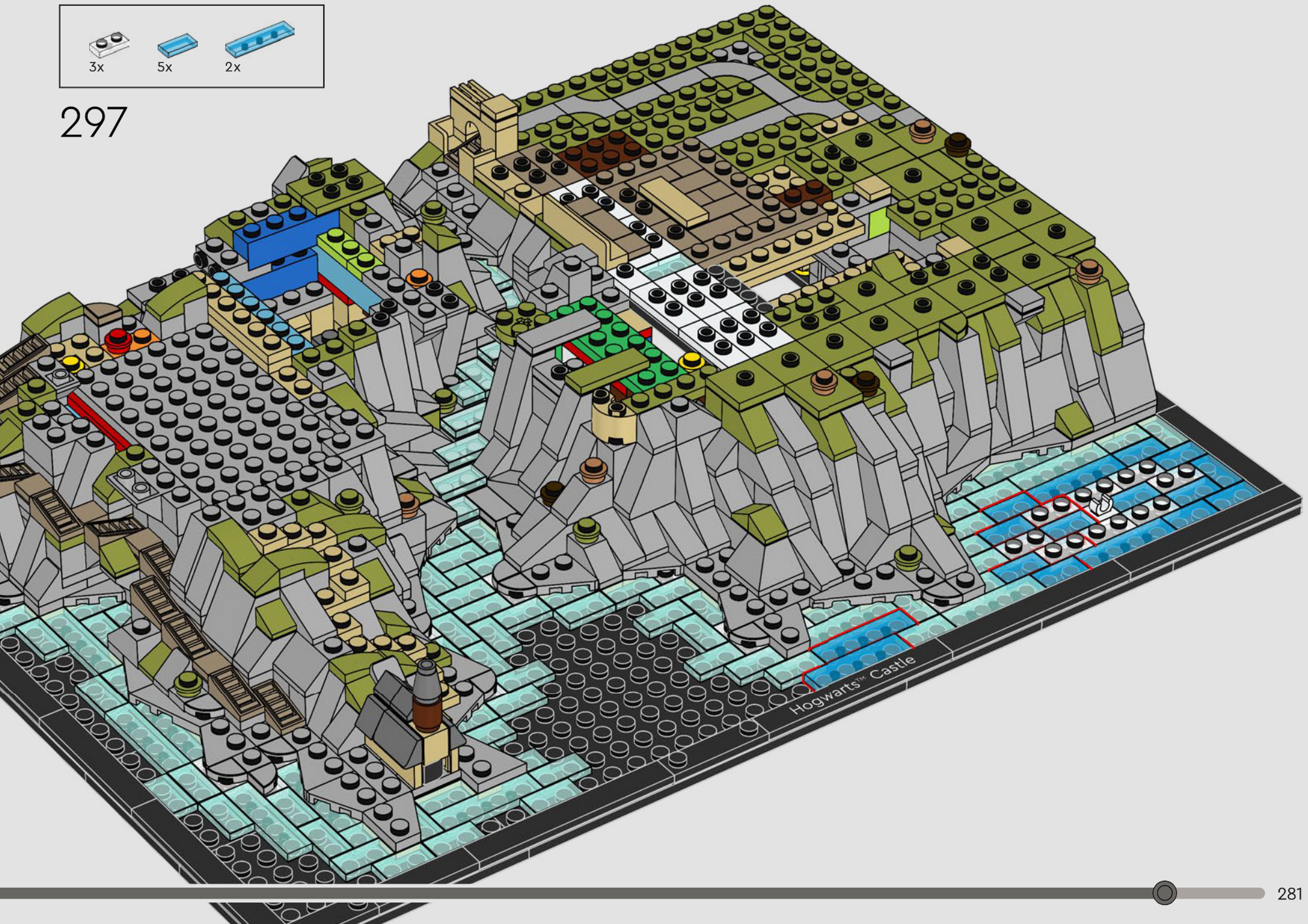



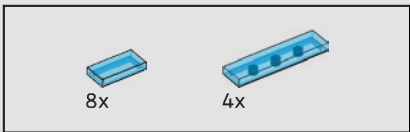

298







31x

299

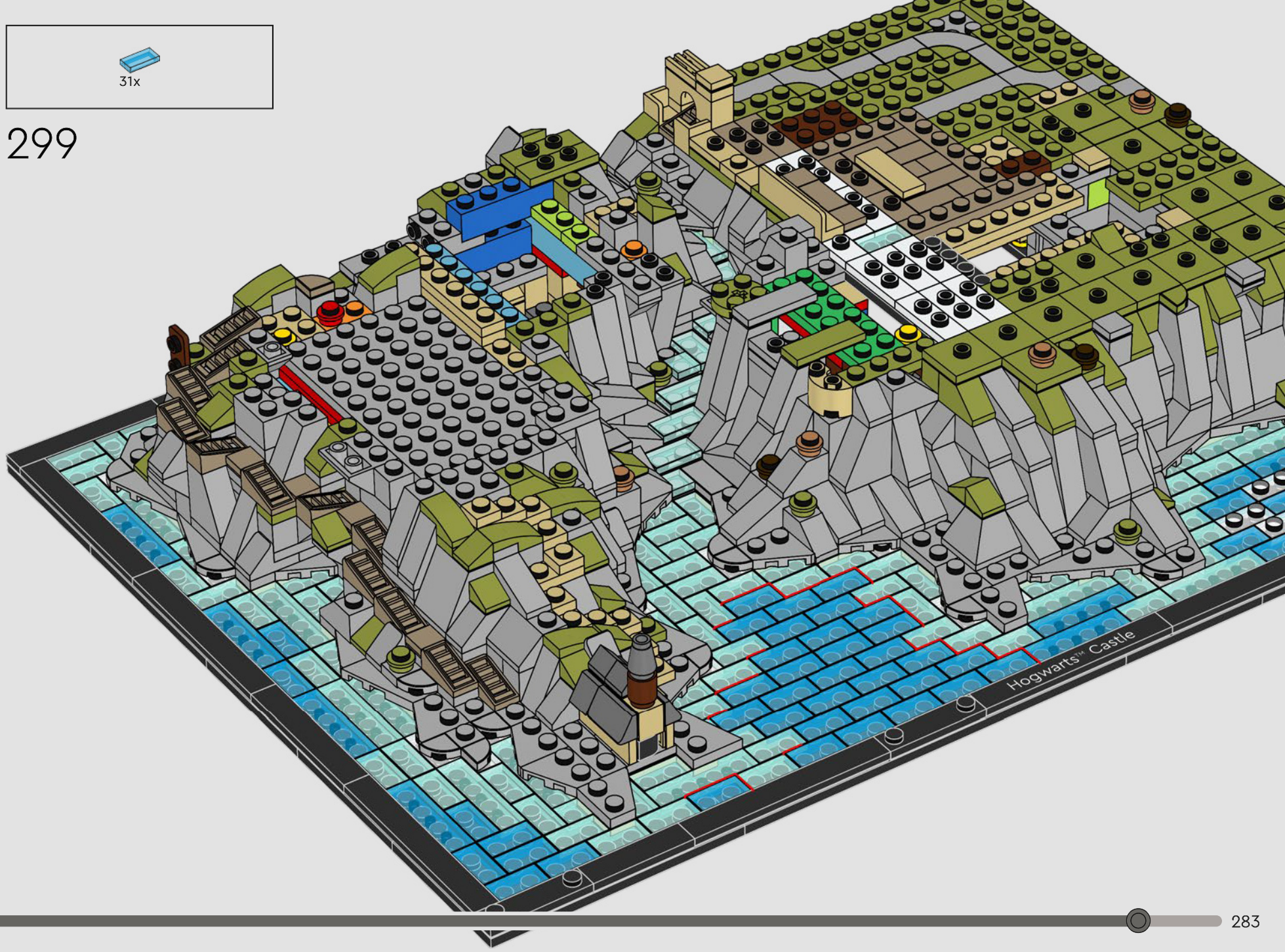

Hogwarts™ Castle



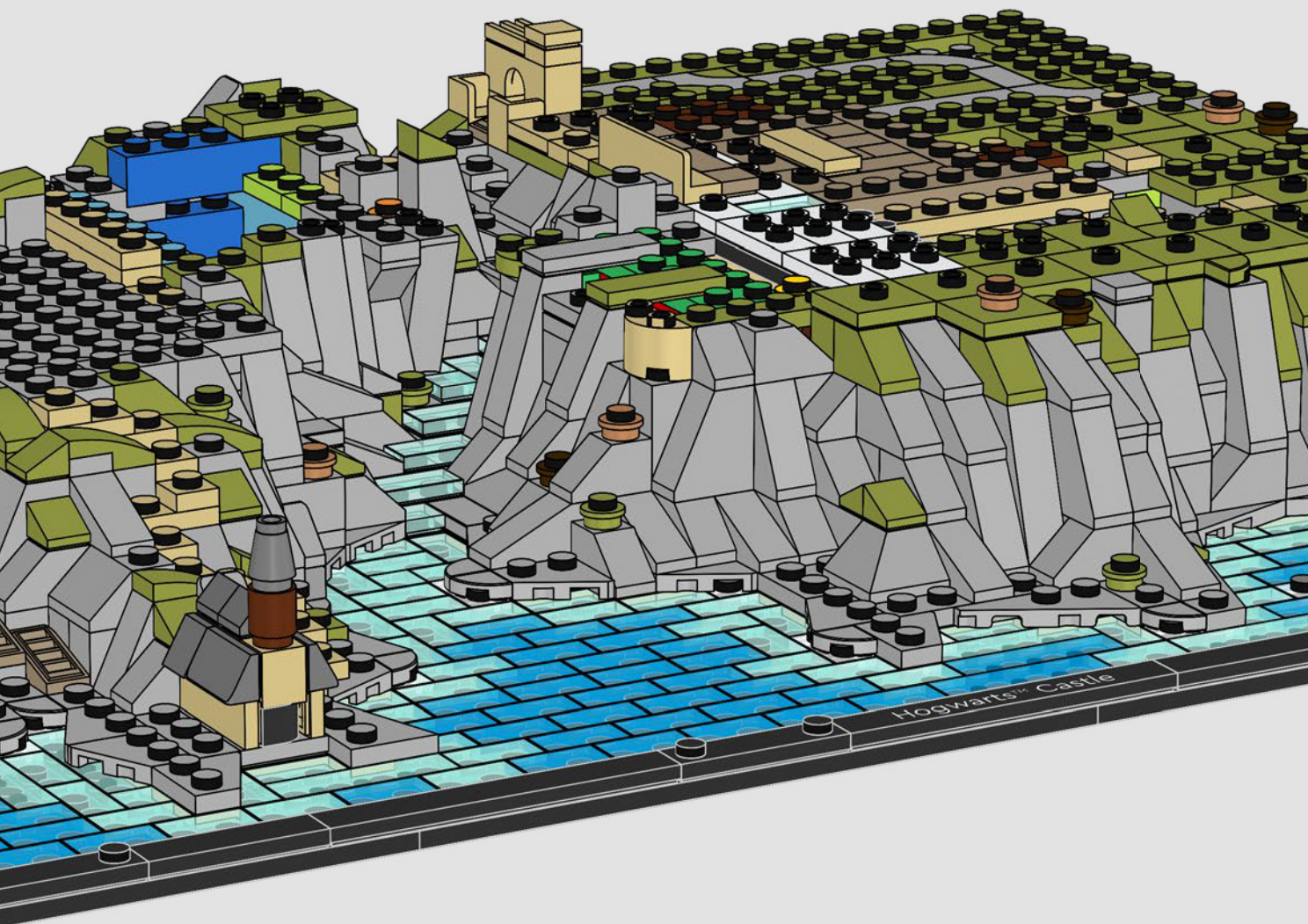

Le attività ricreative all'interno e nei dintorni del Lago Nero sono generalmente sconsigliate (a meno che non siate in buoni rapporti con gli Avvincini). Questo modello, tuttavia, è sicuro per streghe, maghi e babbani.





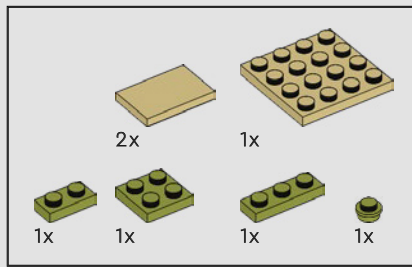

300

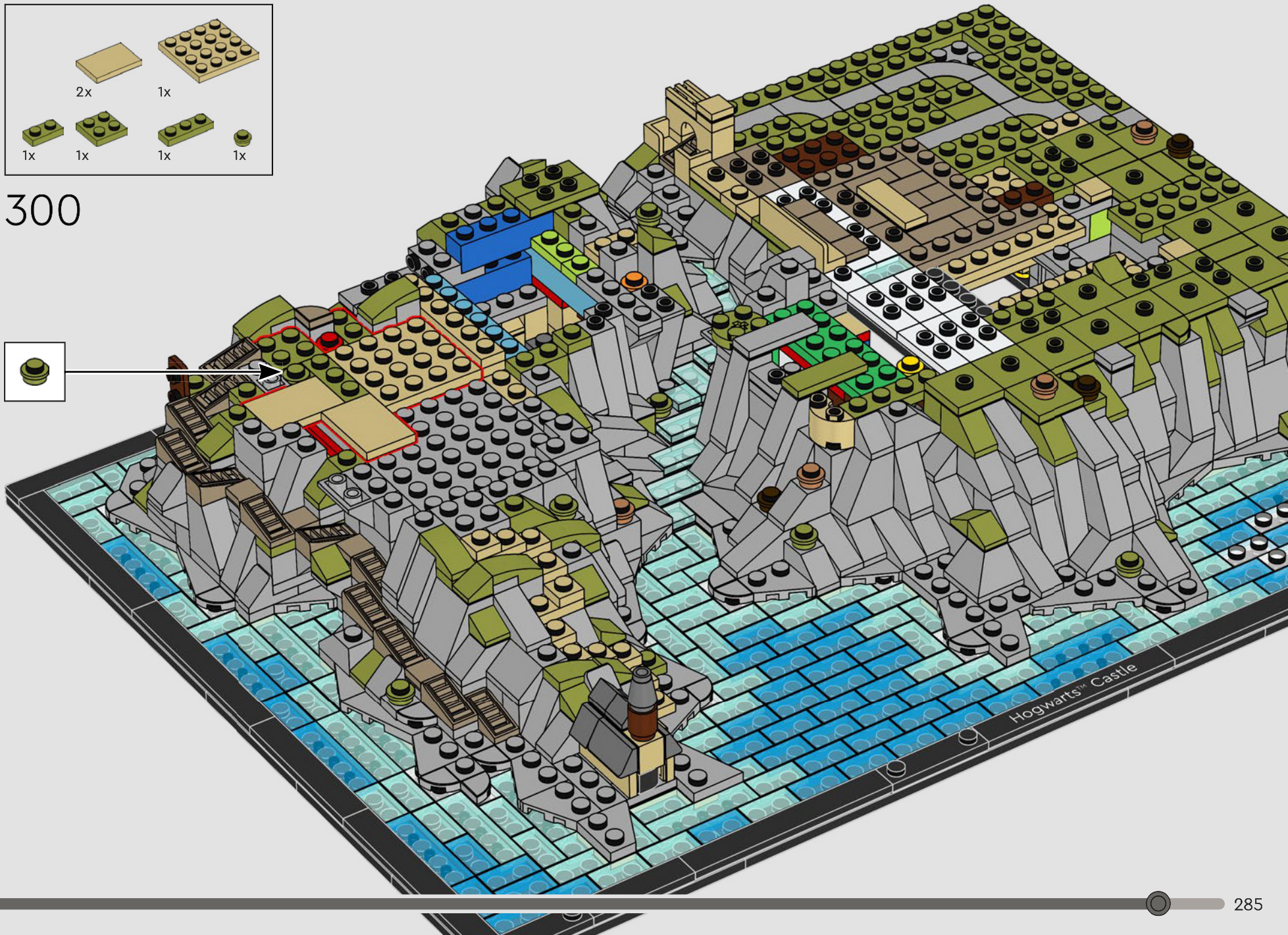



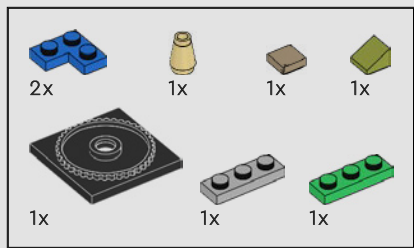

301





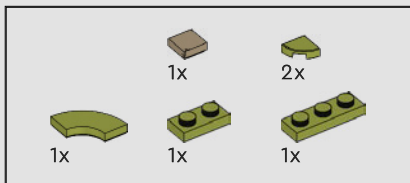

302





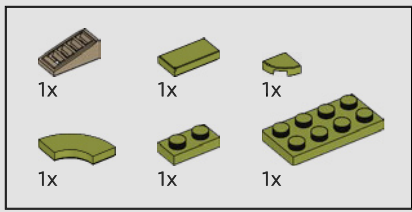

303





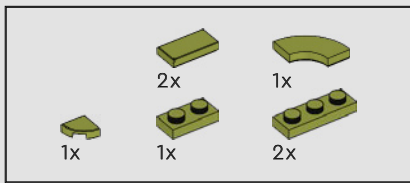

304





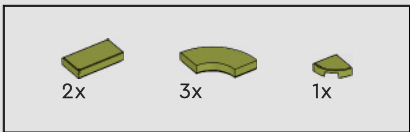

305





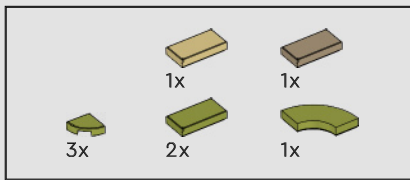

306





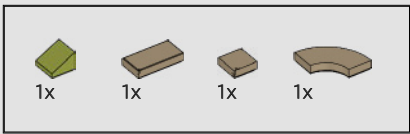

307





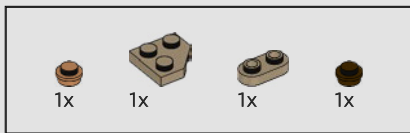

308





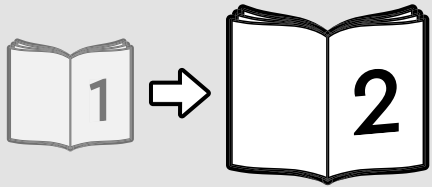







# I

LEGO and the LEGO logo are trademarks of the LEGO Group. ©2023 The LEGO Group.

WIZARDING WORLD and all related trademarks, characters, names, and indicia are  
© & ™ Warner Bros. Entertainment Inc. Publishing Rights © JKR. (s23)