

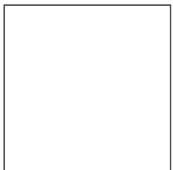

# Harry Potter





## WE'RE MAKING OUR PACKAGING MORE SUSTAINABLE

We're transitioning from single-use plastic to paper-based packaging. As we progress, you may find a mix of paper and plastic in our boxes.

## NOUS RENDONS NOS EMBALLAGES PLUS DURABLES

Nous passons des emballages en plastique à usage unique aux emballages à base de papier. Durant la transition, vous pourriez trouver un mélange de papier et de plastique dans nos boîtes.

## QUEREMOS HACER MÁS SUSTENTABLES NUESTROS MATERIALES DE EMBALAJE

Estamos cambiando las bolsas de plástico desechables por bolsas con base de papel. Conforme avanzamos en este propósito, puedes encontrar una mezcla de papel y de plástico en nuestras cajas.

[LEGO.com/sustainable-packaging](https://LEGO.com/sustainable-packaging)

# LEGO® VIP

- 1.** SIGN UP  
INSCRIVEZ-VOUS  
REGÍSTRATE

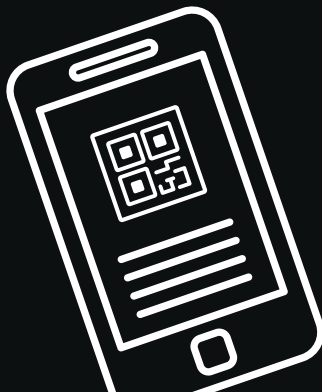

- 2.** EARN POINTS  
FOR PURCHASES  
GAGNEZ DES POINTS  
POUR VOS ACHATS  
GANA PUNTOS POR  
TUS COMPRAS

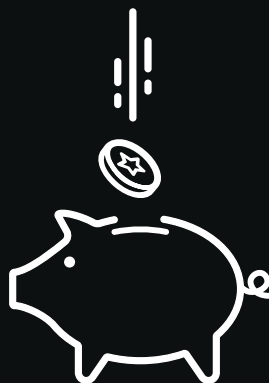

- 3.** REDEEM POINTS FOR REWARDS, EXPERIENCES,  
DISCOUNTS & MORE  
ÉCHANGEZ DES POINTS CONTRE DES RÉCOMPENSES,  
DES EXPÉRIENCES, DES RÉDUCTIONS ET PLUS ENCORE  
CANJEA PUNTOS POR RECOMPENSAS, EXPERIENCIAS,  
DESCUENTOS Y MUCHO MÁS

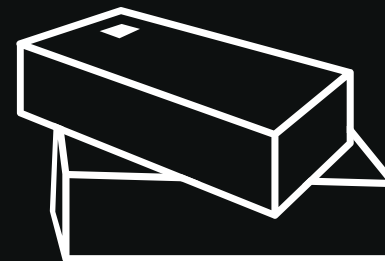
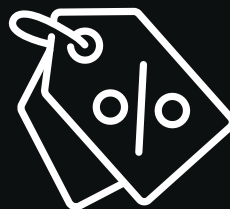



## HOGWARTS™ — A (VERY BRIEF) HISTORY

Built more than 1,000 years ago, at a time when our Muggle™ world did not take as kindly to witches and wizards as we do today, Hogwarts™ School of Witchcraft and Wizardry became an architectural, historic and carefully concealed landmark. Its founders, Godric Gryffindor™, Rowena Ravenclaw™, Helga Hufflepuff™ and Salazar Slytherin™ shared a thirst for wisdom and knowledge and with Hogwarts as their foundation, they aspired to nurture and educate new generations of young witches and wizards at the world's best magic school.

## POUDLARD : UNE (TRÈS BRÈVE) HISTOIRE

Construit il y a plus de 1 000 ans, à une époque où notre monde moldu était peu tendre envers les sorciers et sorcières, le collège Poudlard, école de sorcellerie, est devenu un monument architectural, historique et soigneusement dissimulé. Ses fondateurs, Godric Gryffondor, Rowena Serdaigle, Helga Poufsouffle et Salazar Serpentard partageaient la même soif de sagesse et de connaissance et, avec Poudlard comme pierre angulaire, ils aspiraient à soutenir et à éduquer de nouvelles générations de jeunes sorciers et sorcières dans la meilleure école de magie du monde.

## HOGWARTS™ : UNA (MUY BREVE) HISTORIA

Construido hace más de 1000 años, en una época en la que nuestro mundo Muggle™ no veía con tan buenos ojos a las brujas y magos como hoy en día, el Colegio Hogwarts™ de Magia y Hechicería se convirtió en un hito arquitectónico, histórico y cuidadosamente oculto. Sus fundadores, Godric Gryffindor™, Rowena Ravenclaw™, Helga Hufflepuff™ y Salazar Slytherin™ compartían la sed por la sabiduría y el conocimiento y, con Hogwarts como base, aspiraban a nutrir y educar a nuevas generaciones de jóvenes brujas y magos en la mejor escuela de magia del mundo.



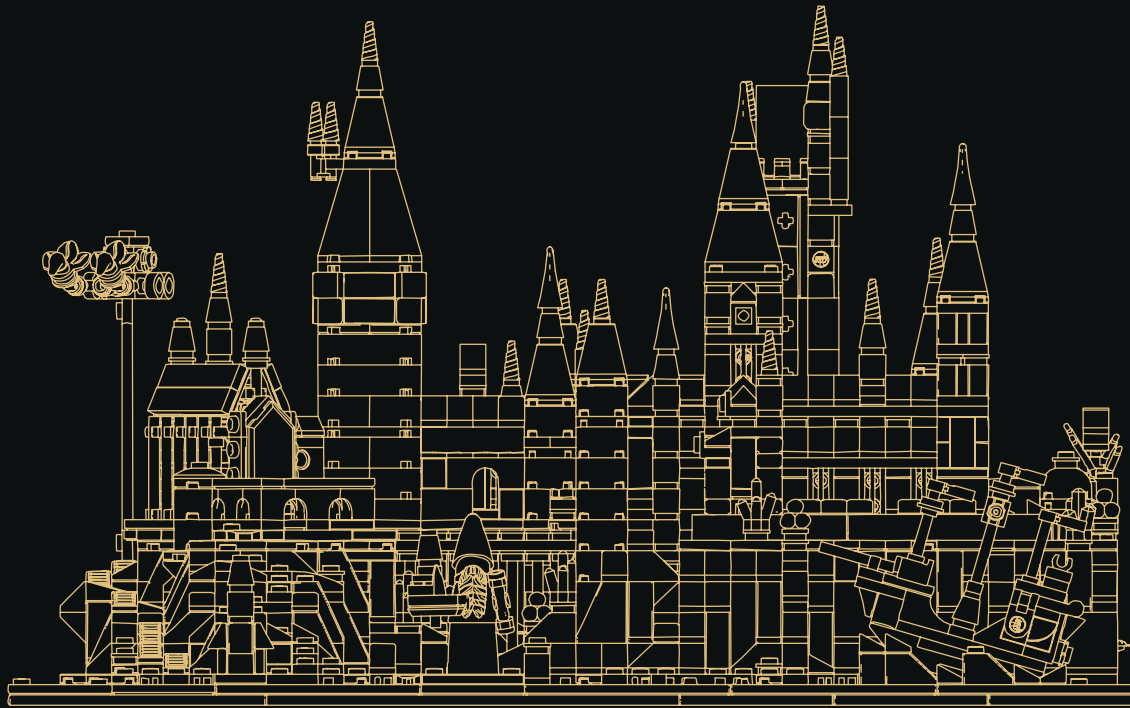

## THE ARCHITECT OF HOGWARTS™

They enlisted the help of the famous Architect of Hogwarts™ to build a suitable castle in the Scottish Highlands, with four Houses each representing the values of the founders. Over the centuries, the castle has taken on a magical life of its own, with its floors, towers and classrooms connected by moving staircases, secret rooms protected by spells, and the ghosts and living portraits of famous former occupants and headmasters and headmistresses to inspire, guide and occasionally tease young students!

## L'ARCHITECTE DE POUDLARD

Ils ont demandé l'aide du célèbre architecte de Poudlard pour construire un château adéquat dans les Highlands écossais, avec quatre maisons représentant chacune les valeurs d'un des fondateurs. Au fil des siècles, le château a adopté une vie magique qui lui est propre, avec ses étages, ses tours et ses salles de classe reliés par des escaliers mobiles, ses pièces secrètes protégées par des sortilèges, et les fantômes et portraits vivants d'anciens occupants et directeurs célèbres qui inspirent, guident et parfois taquent les jeunes élèves !

## EL ARQUITECTO DE HOGWARTS™

Recurrieron a la ayuda del famoso Arquitecto de Hogwarts™ para construir un castillo adecuado en las Tierras Altas de Escocia con cuatro casas, cada una de las cuales representaba los valores de los fundadores. A lo largo de los siglos, el castillo ha cobrado vida mágica por sí mismo, con plantas, torres y aulas conectadas por escaleras móviles, habitaciones secretas protegidas por hechizos y fantasmas y retratos vivientes de famosos ocupantes y directores y directoras de épocas pasadas que inspiran, guían y, ocasionalmente, ¡juegan bromas a los jóvenes estudiantes!







## MINIATURE SCALE, MAXIMUM LEVEL OF DETAIL

"I was an architect before joining the LEGO Group, so it made sense to approach this model as an actual architecture case study. I studied drawings, sketch models and a 1:24 scale studio model of the castle used in several of the Harry Potter™ films. We then measured all proportions and translated the original model into a scale that's full of details yet not 'too big.' Incorporating the bridge and parts of the exterior landscape allowed us to present the castle in its magnificent location. The model also features magical details from several storylines and movies, like the three obstacles protecting the Sorcerer's Stone™, the Chamber of Secrets™, the arrivals of the Beauxbatons' Carriage and the Durmstrang Ship, and the Weasleys' flying Ford Anglia's rough landing in the Whomping Willow™. Last, but not least, we have the Architect of Hogwarts™ Castle minifigure – after you build this set, you will be a Hogwarts architect, too! Enjoy your stay at Hogwarts School of Witchcraft and Wizardry!"

*Yi-Chien Cheng, LEGO® Senior Designer*

## UNE ÉCHELLE MINIATURE, UN NIVEAU DE DÉTAIL MAXIMAL

« J'étais architecte avant de rejoindre le groupe LEGO; il était donc logique d'aborder ce modèle comme une véritable étude de cas d'architecture. J'ai étudié des dessins, des modèles de croquis et une maquette de studio à l'échelle 1:24 du château utilisée dans plusieurs des films de Harry Potter™. Nous avons ensuite mesuré toutes les proportions et transposé le modèle original à une échelle riche en détails, mais pas non plus trop grande. L'intégration du pont et de certaines parties du paysage extérieur nous a permis de présenter le château dans son magnifique environnement. Le modèle présente également des détails magiques issus de plusieurs histoires et films, comme les trois obstacles protégeant la Pierre philosophale, la Chambre des Secrets, l'arrivée du carrosse de Beauxbatons et du navire de Durmstrang, ou encore l'atterrissage brutal de la Ford Anglia volante des Weasley dans le Saule cogneur. Enfin, nous avons la figurine de l'architecte du château de Poudlard. Après avoir construit cet ensemble, vous serez vous aussi un architecte de Poudlard ! Profitez bien de votre séjour au collège Poudlard, école de sorcellerie ! »

*Yi-Chien Cheng, concepteur principal LEGO®*

## ESCALA EN MINIATURA, MÁXIMO NIVEL DE DETALLE

"Antes de incorporarme a The LEGO Group, yo solía ser arquitecto. Por eso, la mejor manera que encontré de abordar este modelo fue como un verdadero caso de estudio arquitectónico. Estudié dibujos, modelos preliminares y un modelo de estudio a escala 1:24 del castillo utilizado en varias de las películas de Harry Potter™. Después medimos todas las proporciones y trasladamos el modelo original a una escala que, si bien está llena de detalles, no resulta inconvenientemente grande. Incorporar el puente y partes del paisaje exterior nos permitió presentar el castillo en su magnífica ubicación. El modelo también presenta detalles mágicos de varias tramas y películas, como los tres obstáculos que protegen la Piedra Filosofal, la Cámara de los Secretos, las llegadas del carruaje de Beauxbatons y el barco de Durmstrang, y el brusco aterrizaje del Ford Anglia volador de los Weasley en el Sauce Boxeador. Por último, pero no por ello menos importante, tenemos la minifigura del Arquitecto de Hogwarts™. Después de construir este set, ¡tú también lo serás! ¡Que disfrutes de tu estancia en el Colegio Hogwarts de Magia y Hechicería!"

*Yi-Chien Cheng, diseñador sénior de LEGO®*



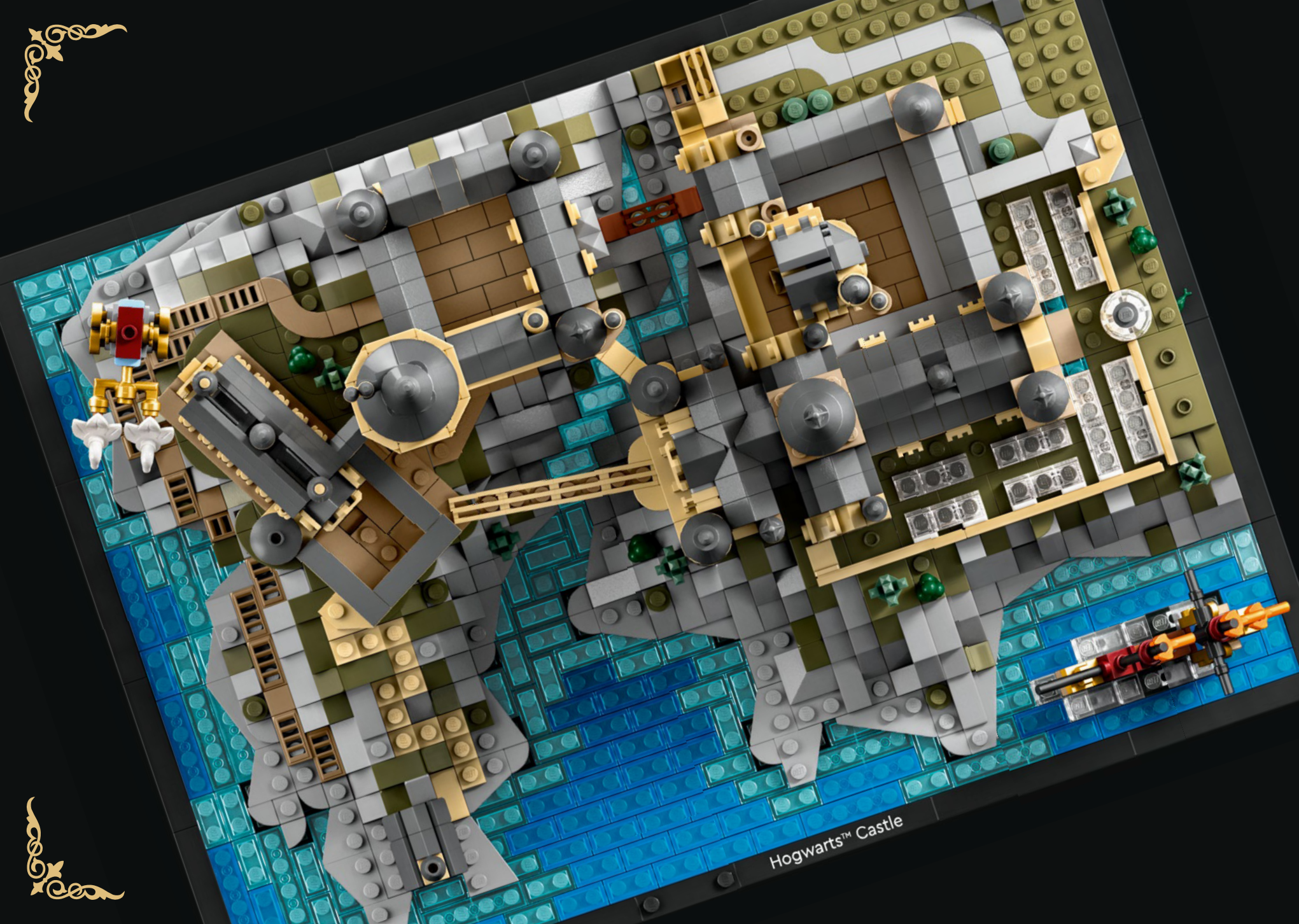

Hogwarts™ Castle





## A TOUR OF YOUR SCHOOL

Hogwarts™ Castle towers above its rock foundation overlooking the Black Lake. You can visit the Great Hall, main tower, courtyard, bridges, greenhouse area and the astronomy tower. Deep in the dungeons, the Mirror of Erised is stored away, but don't be tempted to lose yourself in wishful daydreams! Take a Potions class, try your luck with the Basilisk in the Chamber of Secrets™ or follow in the footsteps of Harry Potter™, Hermione Granger™ and Ron Weasley™ in the Devil's Snare room, the Winged Key room and the Chessboard Chamber.

Take the Beauxbatons' Carriage on a scenic flight, rescue the Weasleys' flying Ford Anglia from the clutches of the Whomping Willow™, or board the Durmstrang Ship as it ascends from the Black Lake.

## UNE VISITE DE VOTRE ÉCOLE

Le château de Poudlard se dresse au-dessus de ses fondations rocheuses et surplombe le lac noir. Vous pouvez visiter la Grande Salle, la tour principale, la cour, les ponts, la serre et la tour d'astronomie. Au fond des donjons se cache le Miroir du Riséd, mais ne vous laissez pas envahir par les faux espoirs ! Suivez un cours de potions, tentez votre chance avec le Basilic dans la Chambre des Secrets ou retracez le parcours de Harry Potter™, Hermione Granger™ et Ron Weasley™ dans la salle du Filet du Diable, la salle des clés ailées et la Chambre de l'échiquier.

Prenez le carrosse de Beauxbâtons pour un vol panoramique, sauvez la Ford Anglia volante des Weasley des griffes du Saule cogneur, ou montez à bord du navire de Durmstrang alors qu'il émerge du lac noir.

## UN RECORRIDO POR TU ESCUELA

El Castillo de Hogwarts™ se eleva sobre sus cimientos de roca con vista al Lago Negro. Podrás visitar el Gran Comedor, la torre principal, el patio, los puentes, la zona de invernaderos y la torre de astronomía. En lo más profundo de las mazmorras se guarda el Espejo de Oesed, ¡pero no caigas en la tentación de perderte en ensoñaciones! Asiste a una clase de Pociones, prueba suerte con el Basilisco en la Cámara de los Secretos o sigue los pasos de Harry Potter™, Hermione Granger™ y Ron Weasley™ en la sala del lazo del diablo, la habitación de las llaves aladas o la cámara donde está el tablero de ajedrez.

Lleva a dar un vuelo escénico al carruaje de Beauxbatons, rescata el Ford Anglia volador de los Weasley de las ramas del Sauce Boxeador o aborda el barco de Durmstrang antes de que se pierda de vista en el Lago Negro.



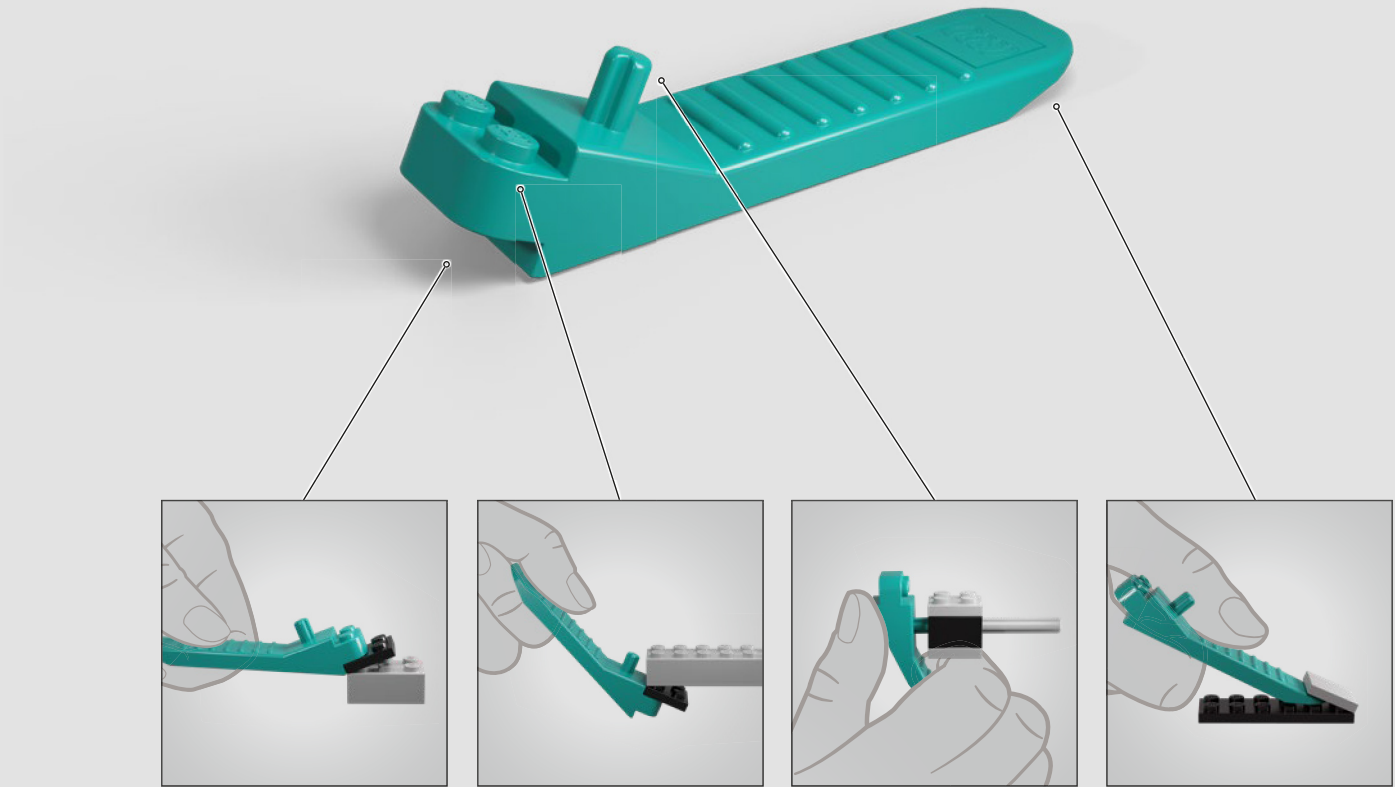

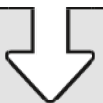



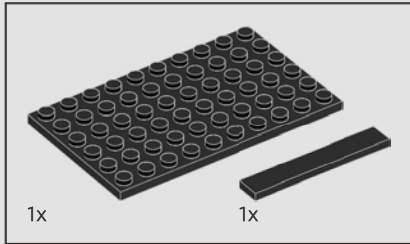
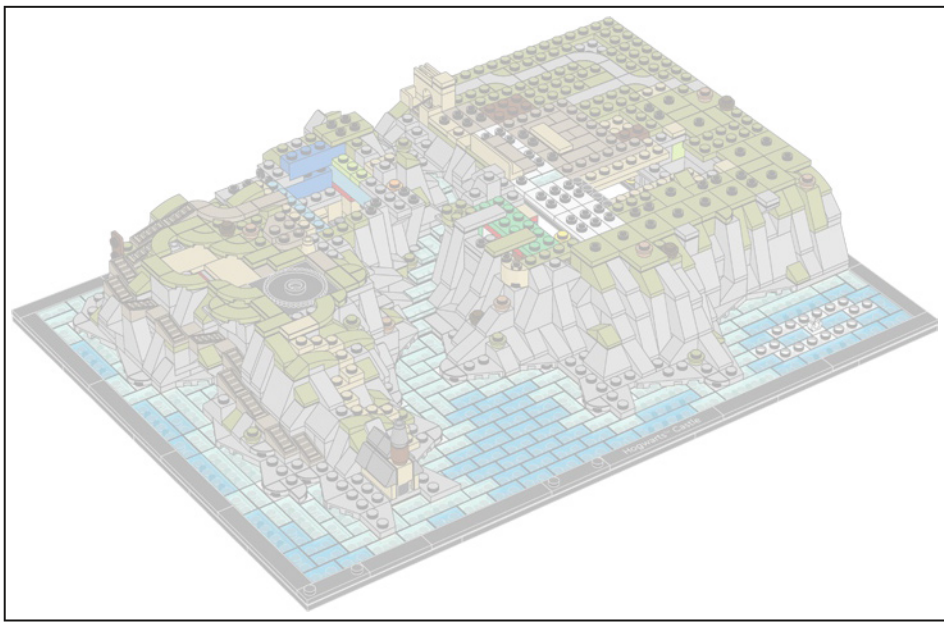

1

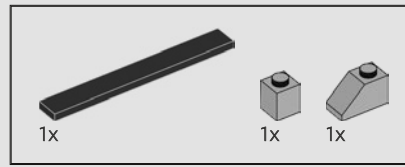
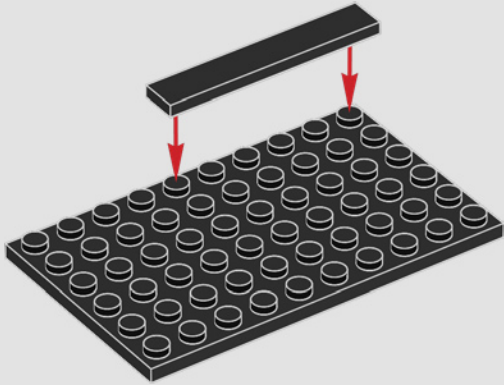

2

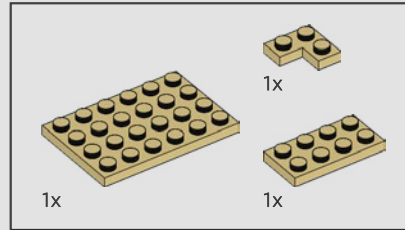
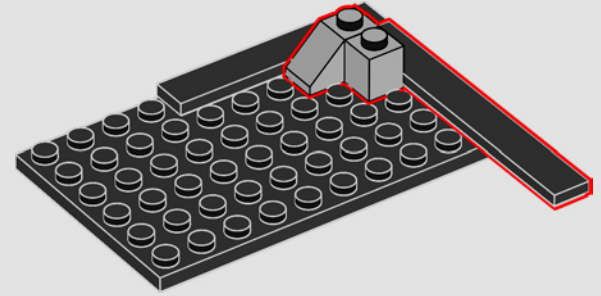

3

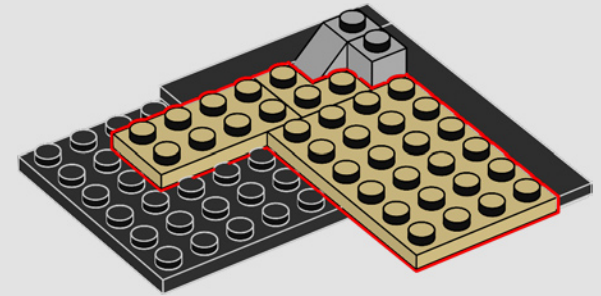

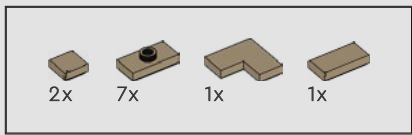

4

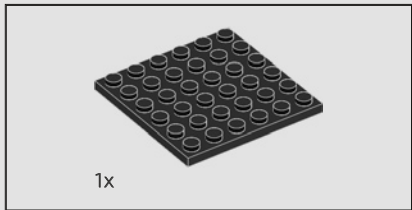
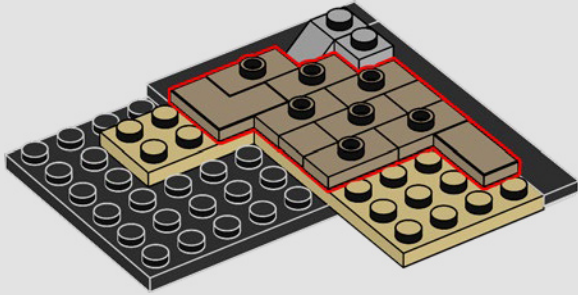

5

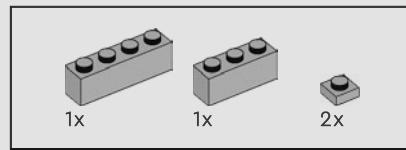
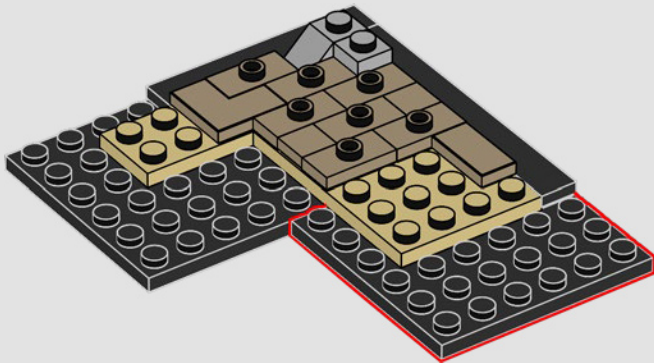

6

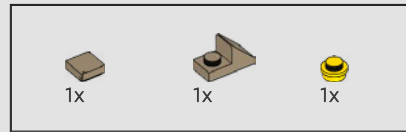
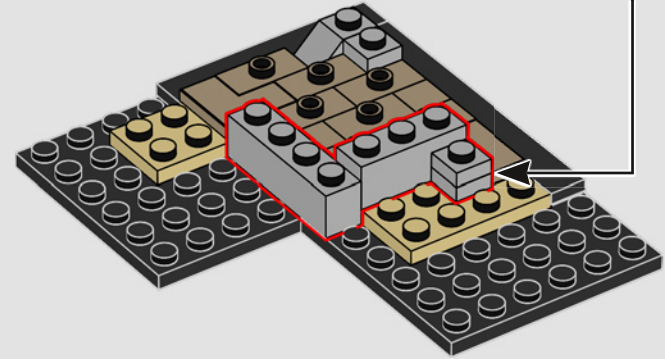

7

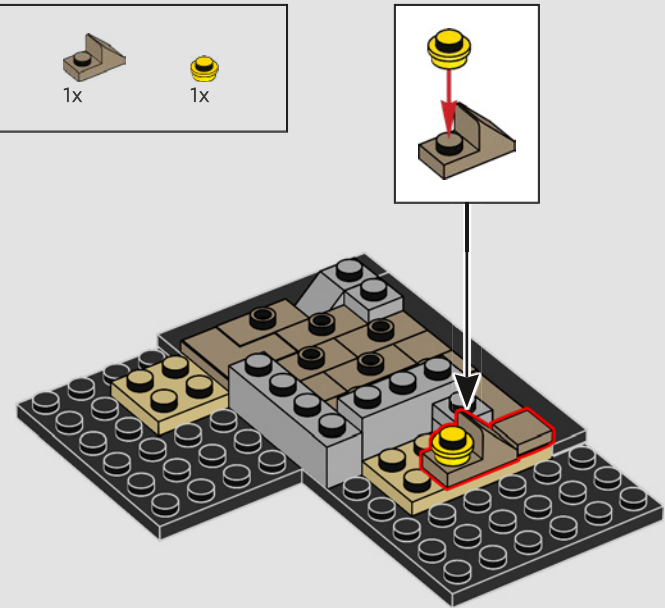

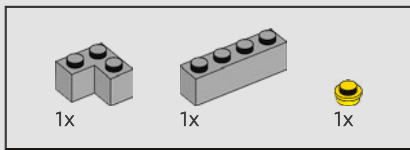

8

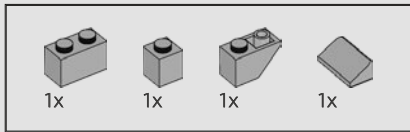
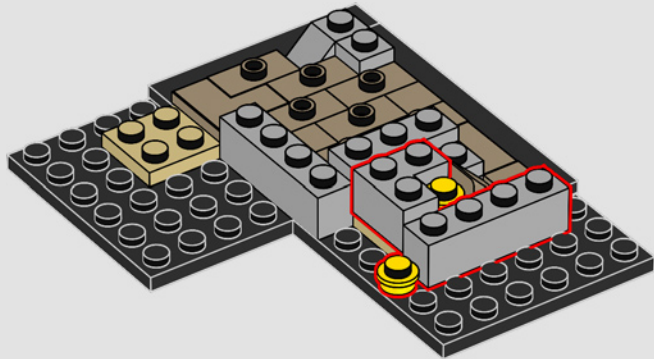

9

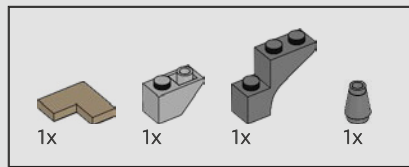
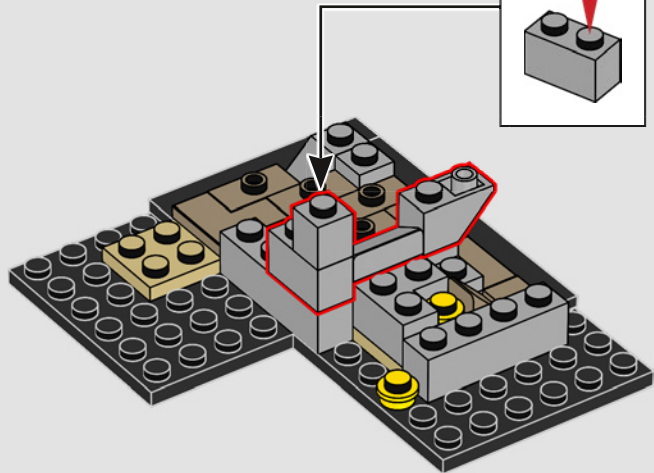

10

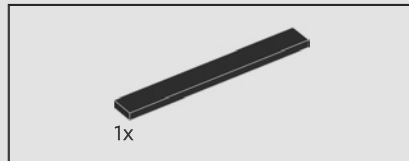
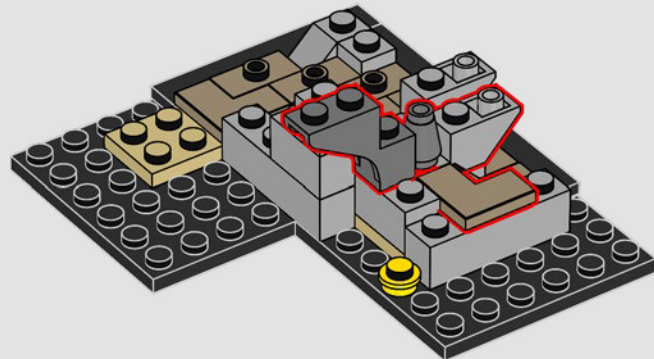

11

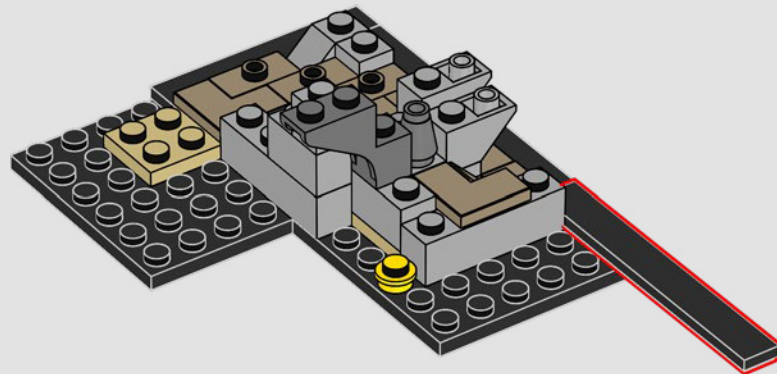

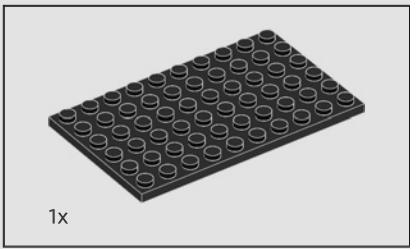

12

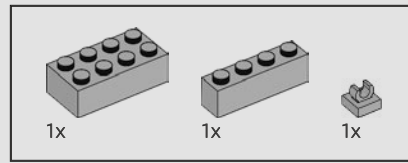
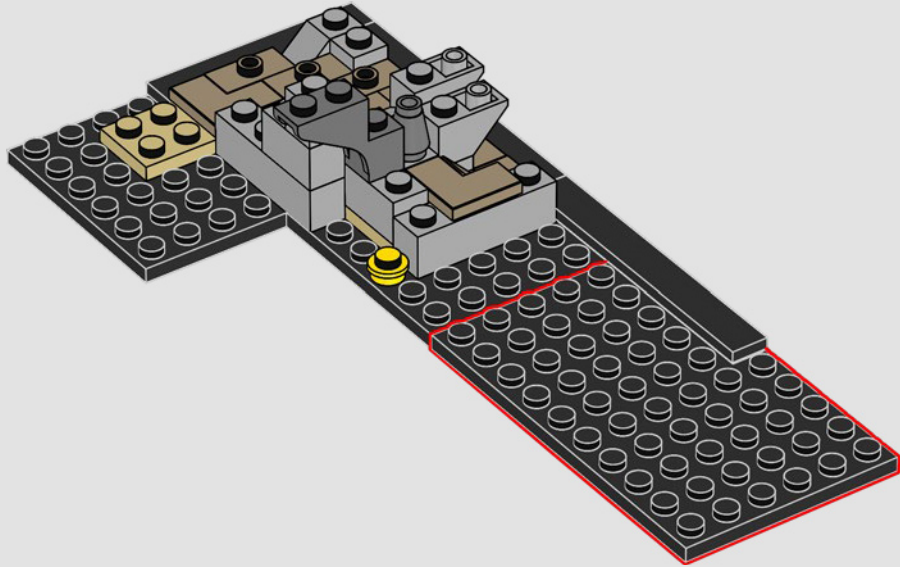

13

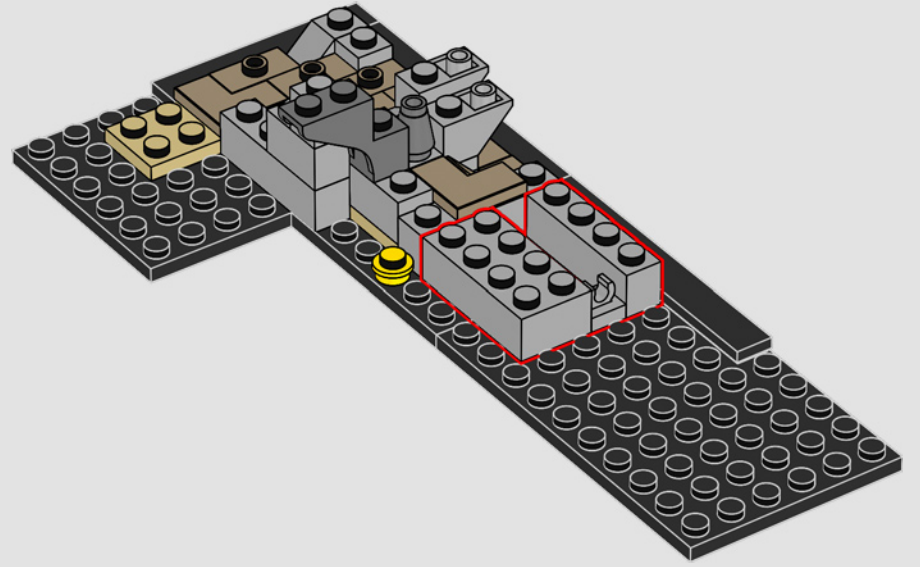



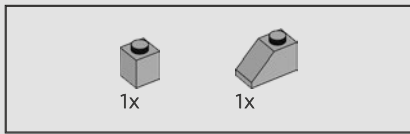

14

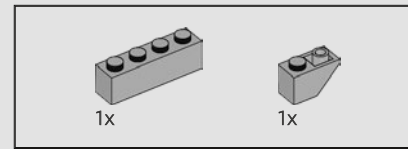
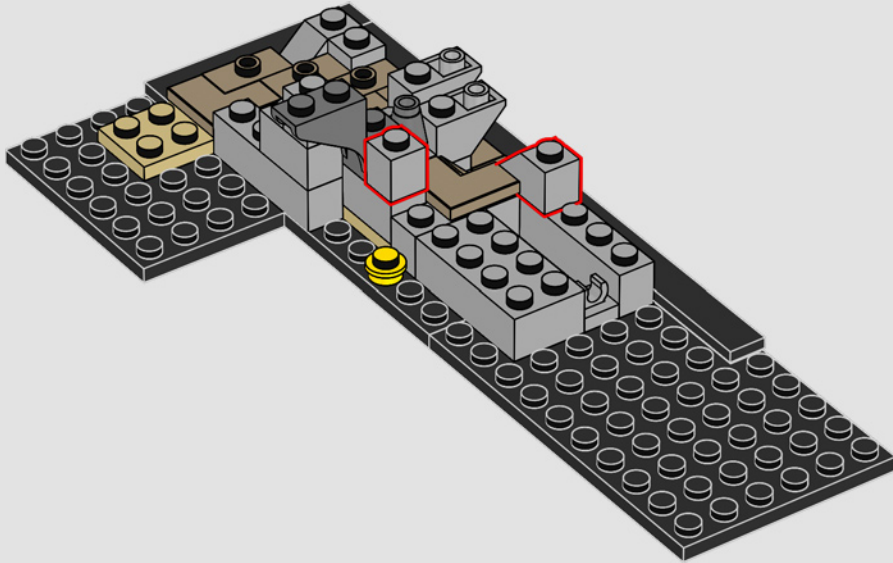

15

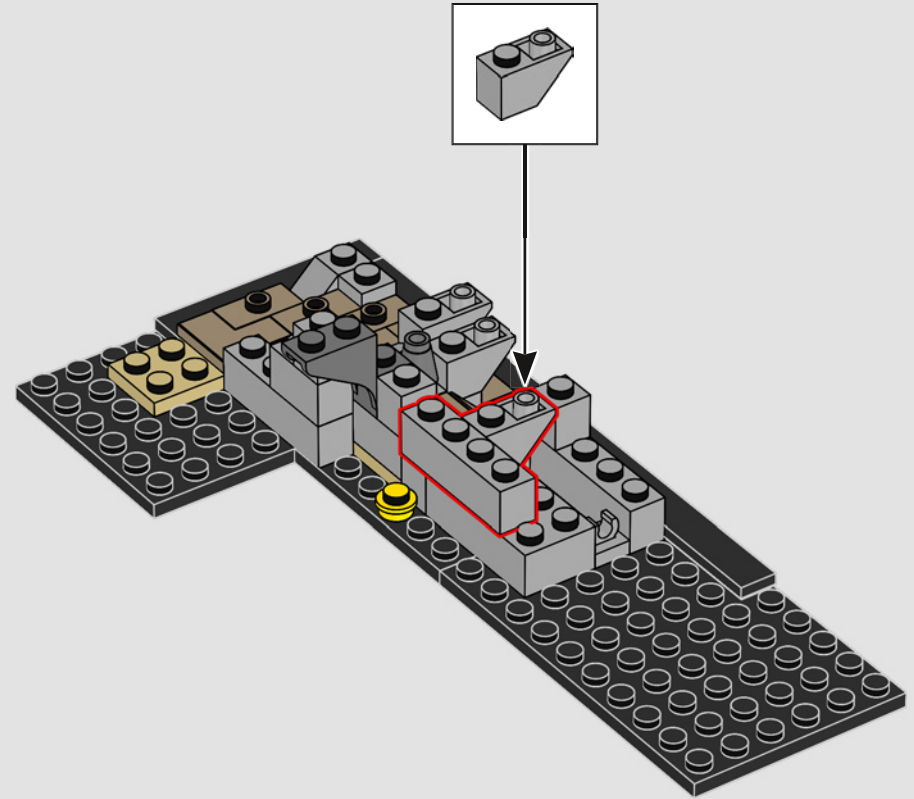

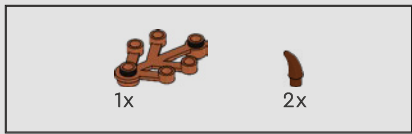

16

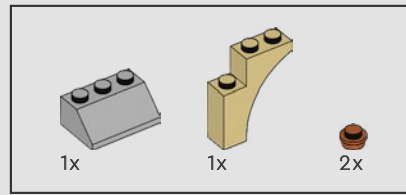
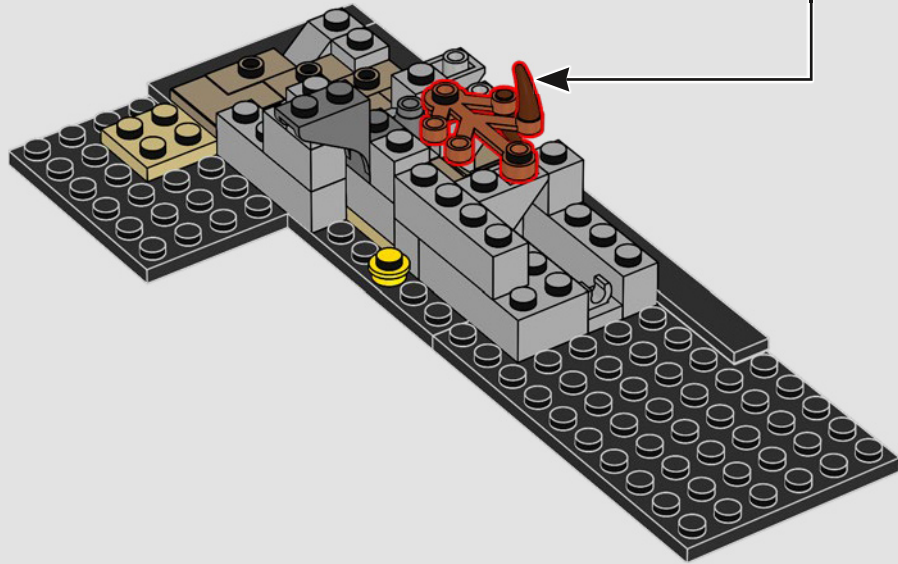
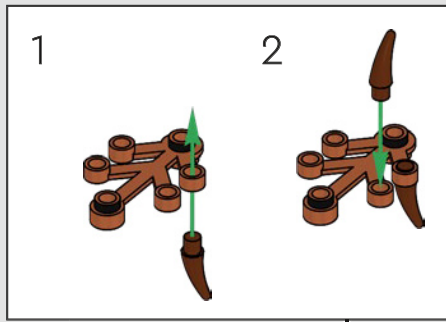

17

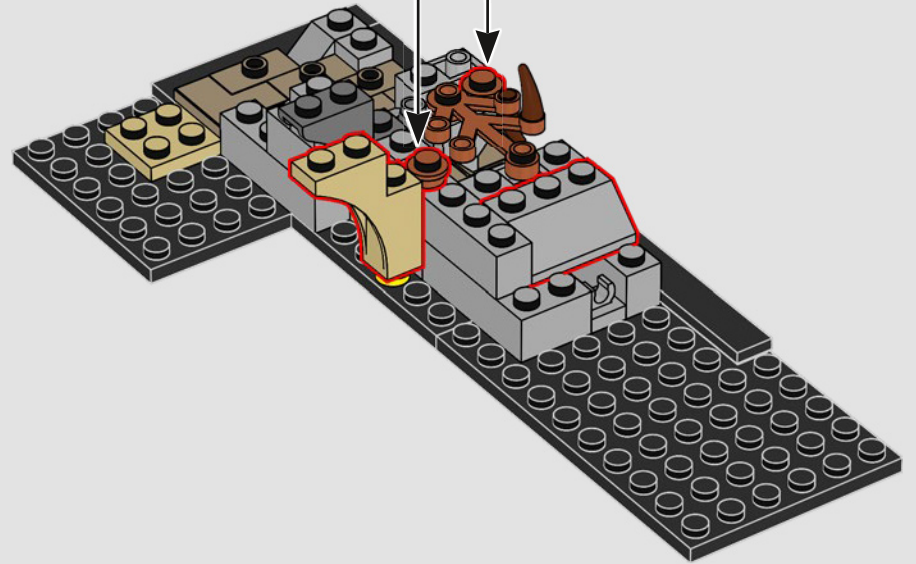

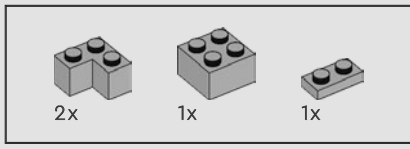

18

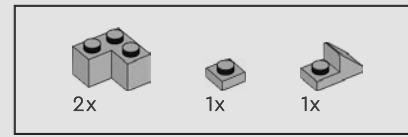
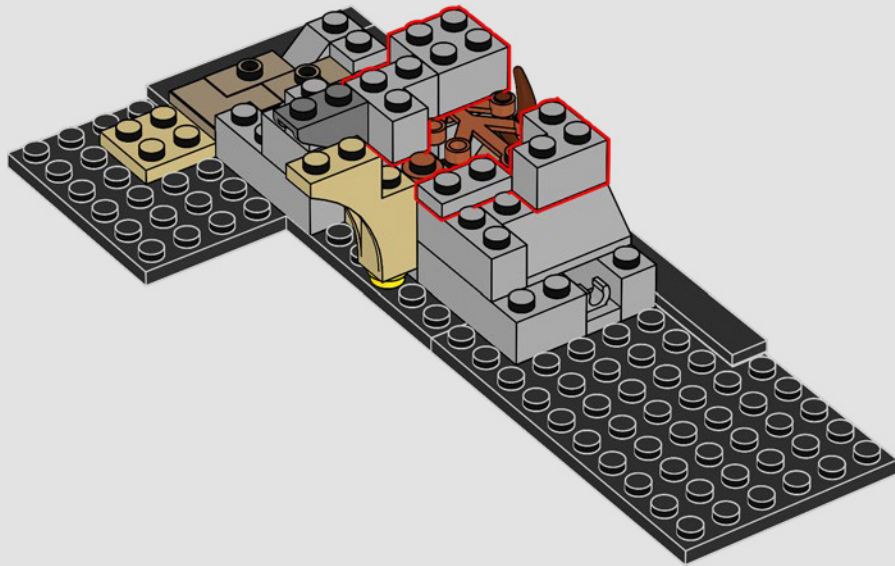

19

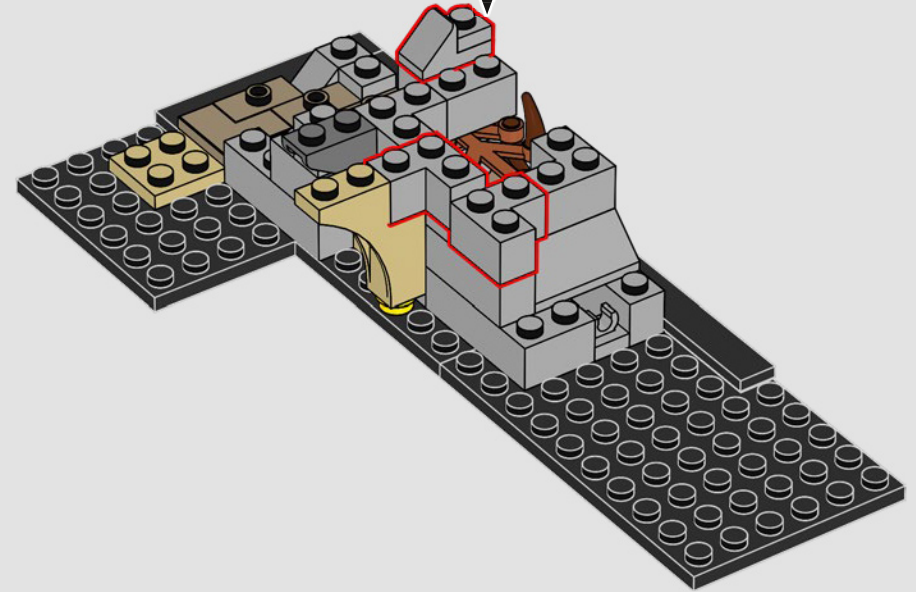
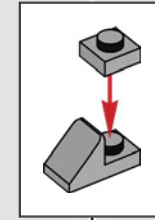

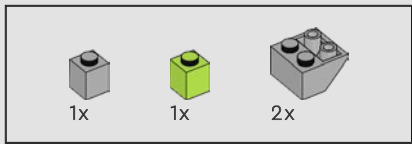

20

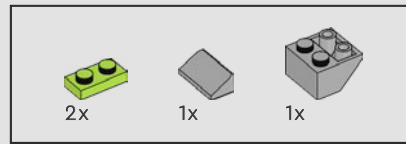
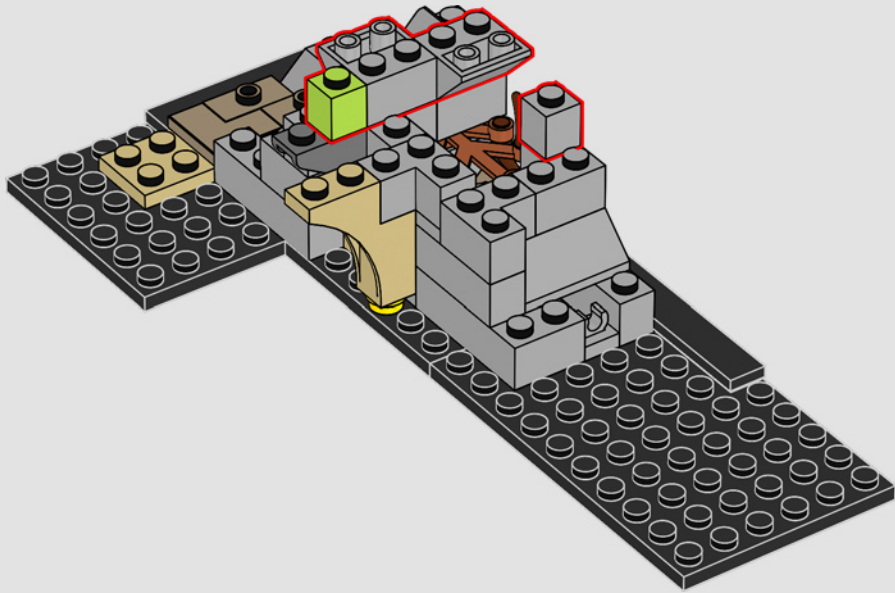

21

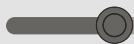
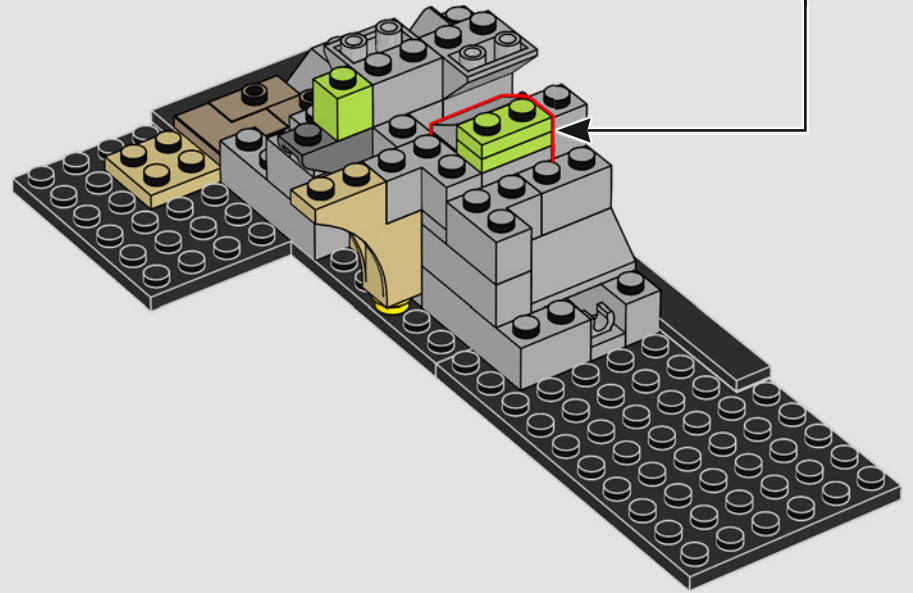
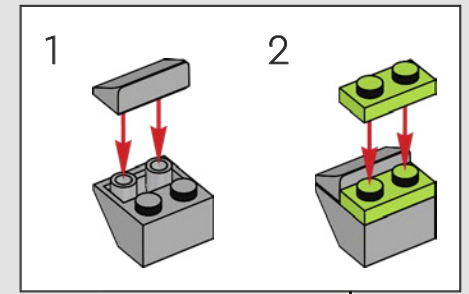

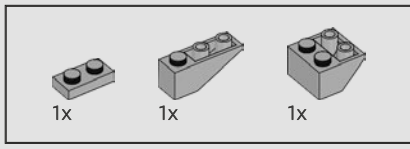

22

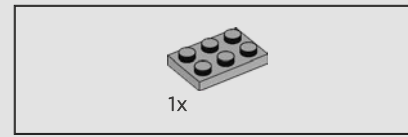
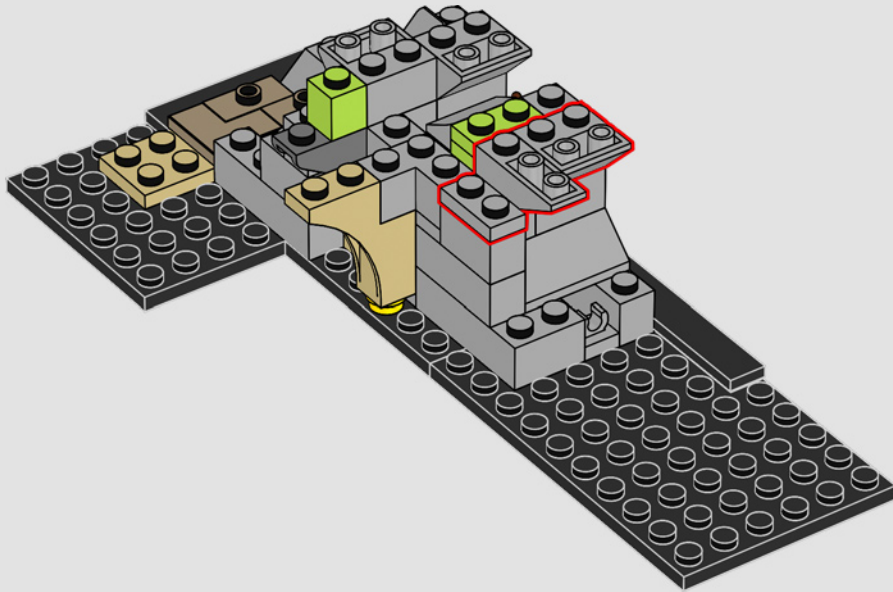

23

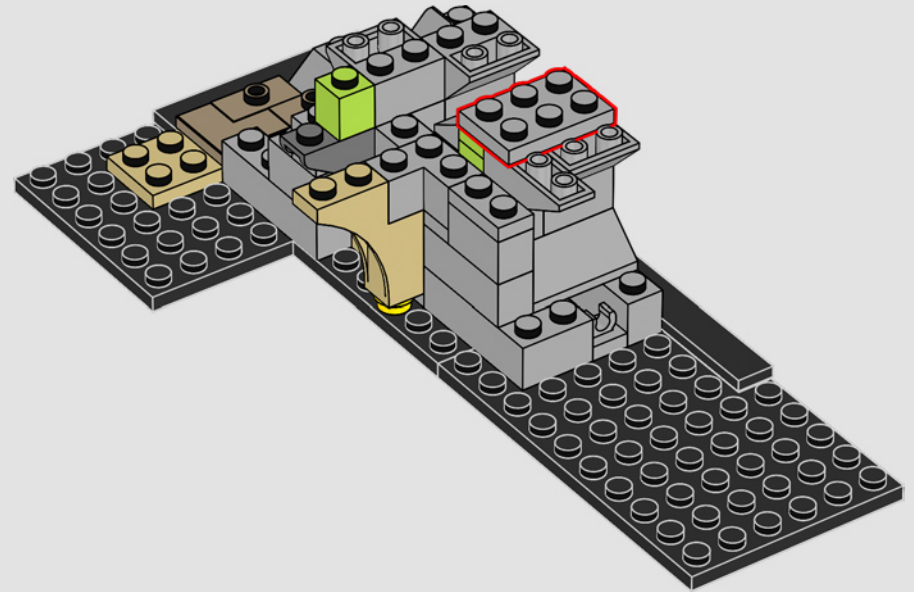

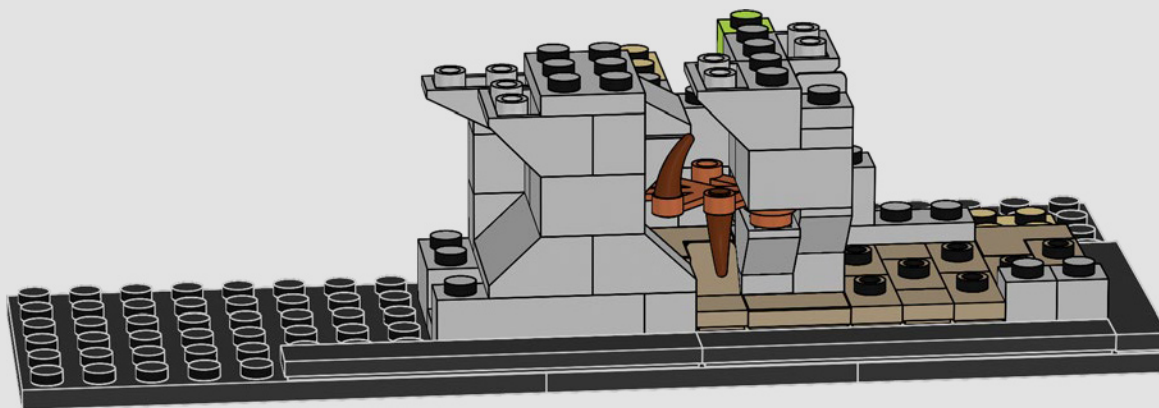

The Devil's Snare keeps intruders from reaching the secret hiding place of the Sorcerer's Stone™. It thrives in dampness and darkness. If you get stuck, stay calm, and open your curtains to let the sun in!

Le Filet du Diable empêche les intrus d'atteindre la cachette secrète de la Pierre philosophale. Il prospère dans un environnement humide et obscur. Si vous vous faites prendre, restez calme et ouvrez les rideaux pour laisser entrer le soleil !

El lazo del diablo impide que los intrusos lleguen al escondite secreto donde está oculta la Piedra Filosofal. La humedad y la oscuridad lo fortalecen. Si te quedas atrapado, mantén la calma y abre las cortinas para que entre la luz del sol.



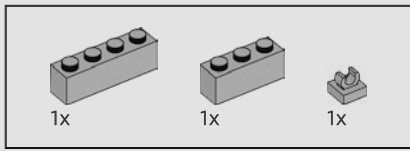

24

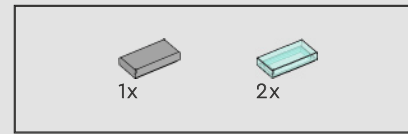
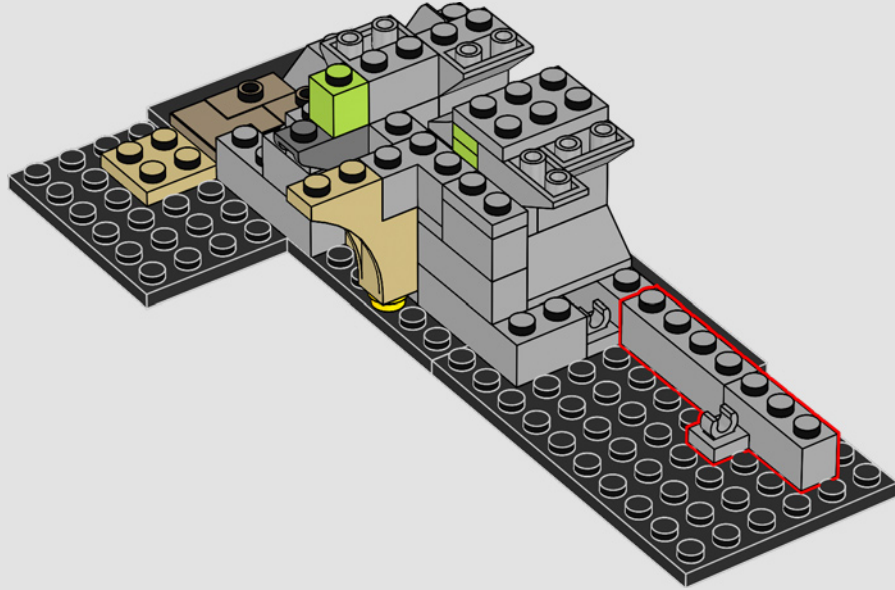

25

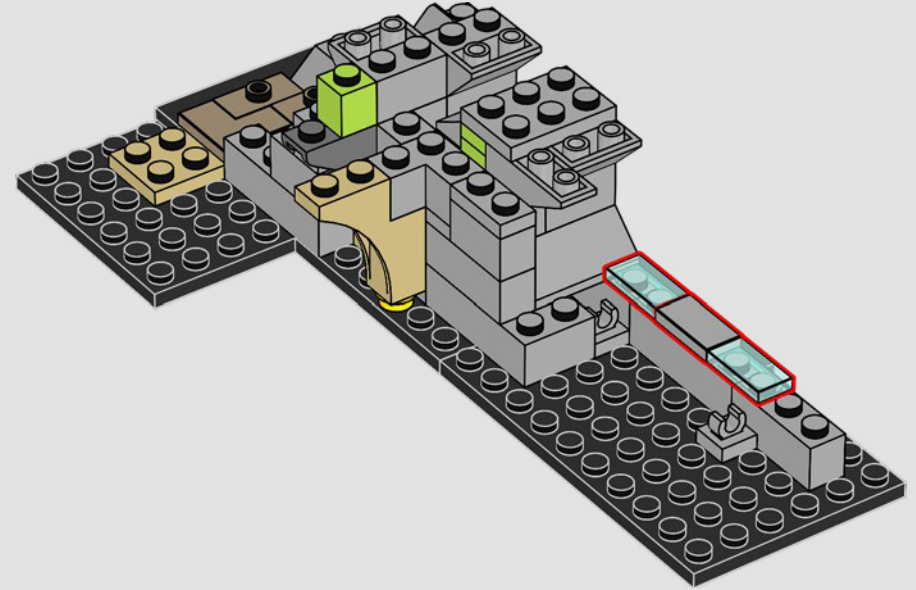

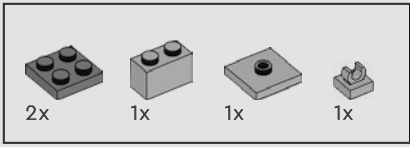

26

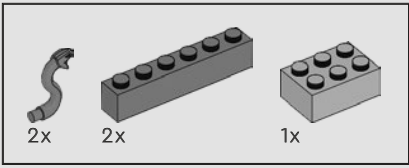
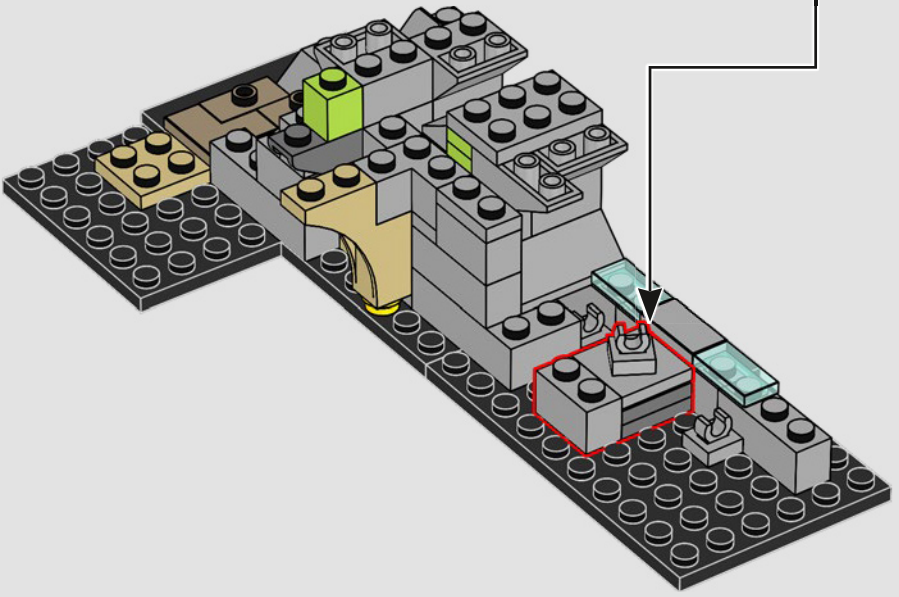
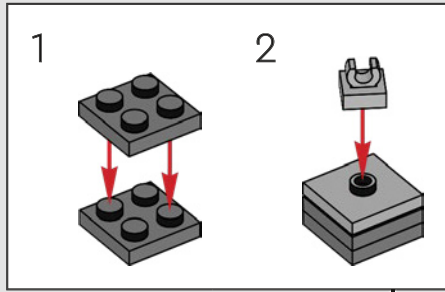

27

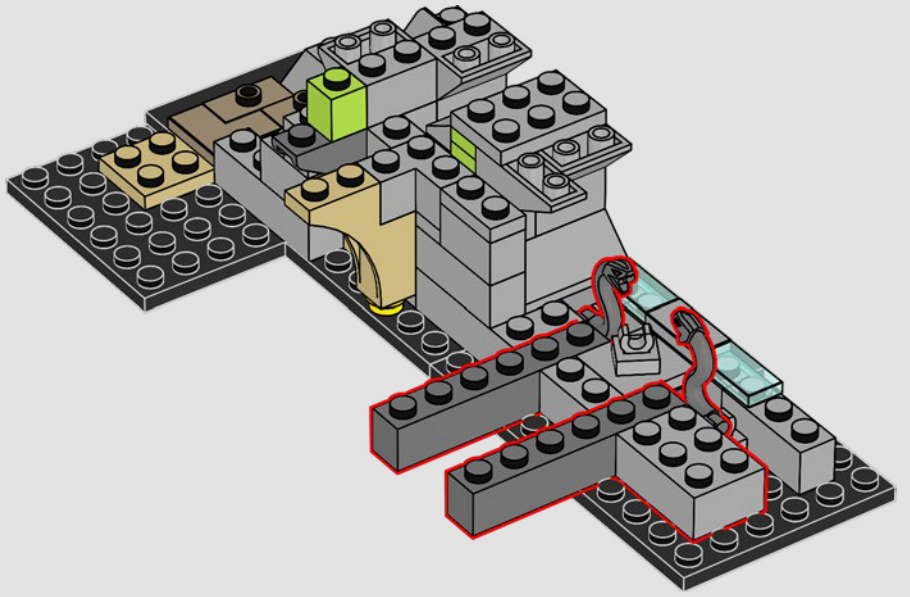



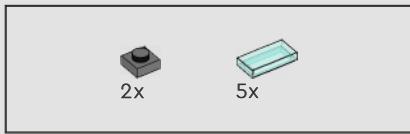

28

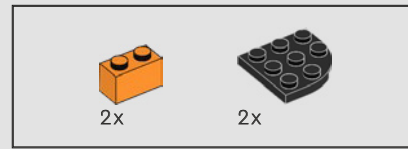
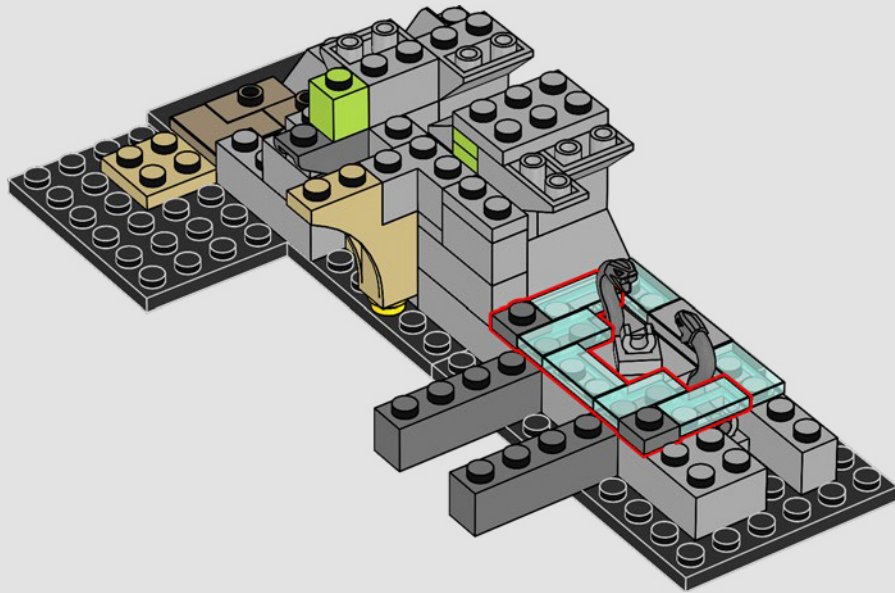

29

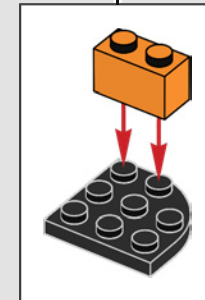
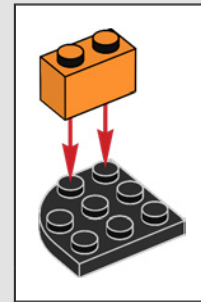
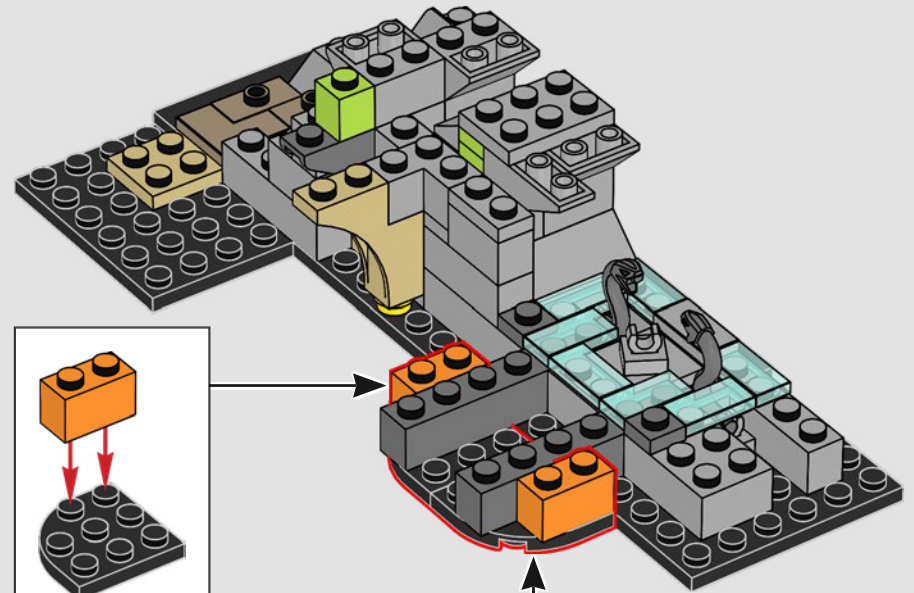

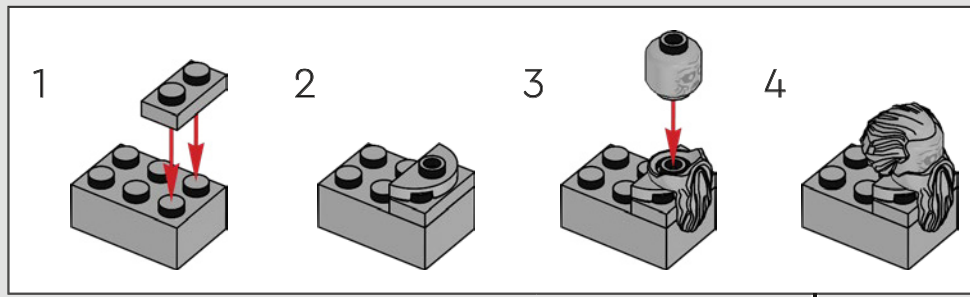
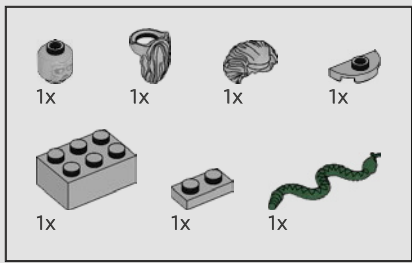

30

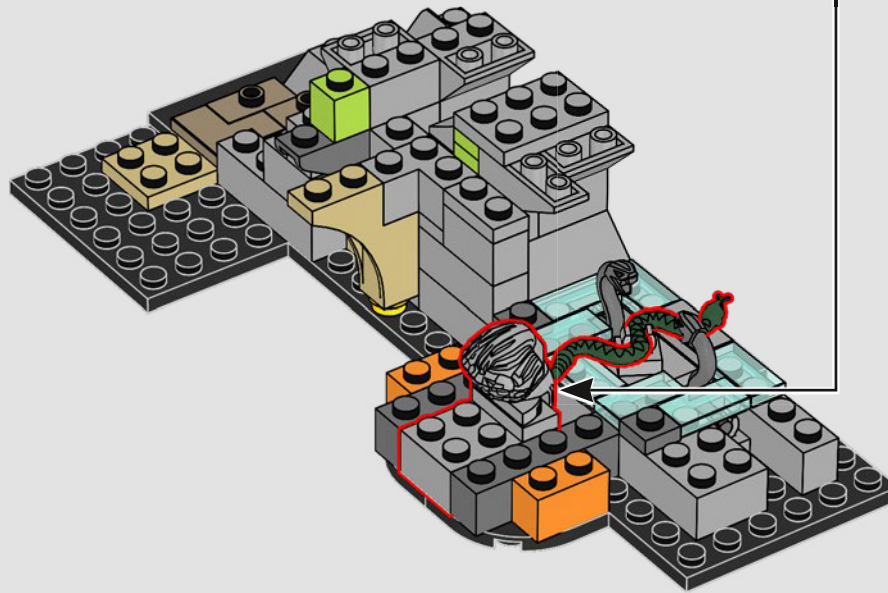

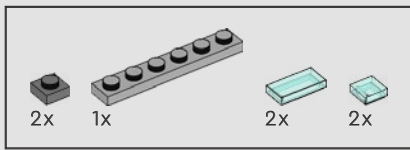

31

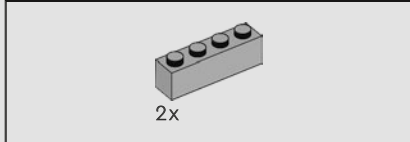
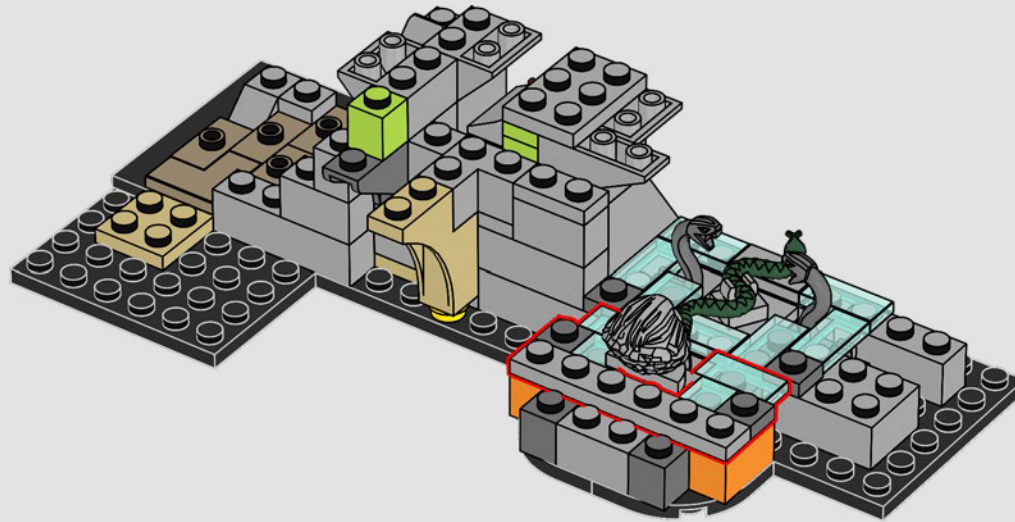

32

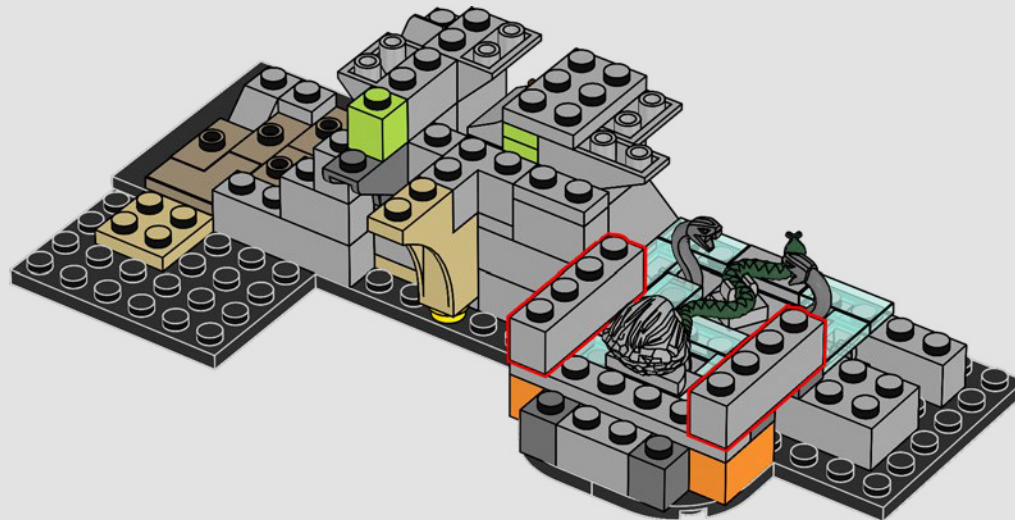

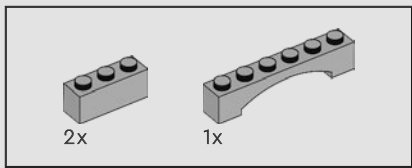

33

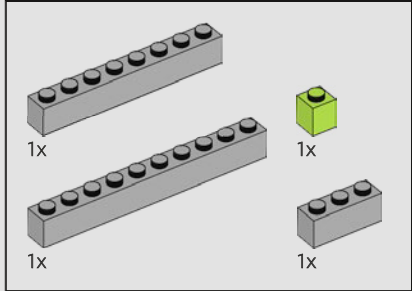
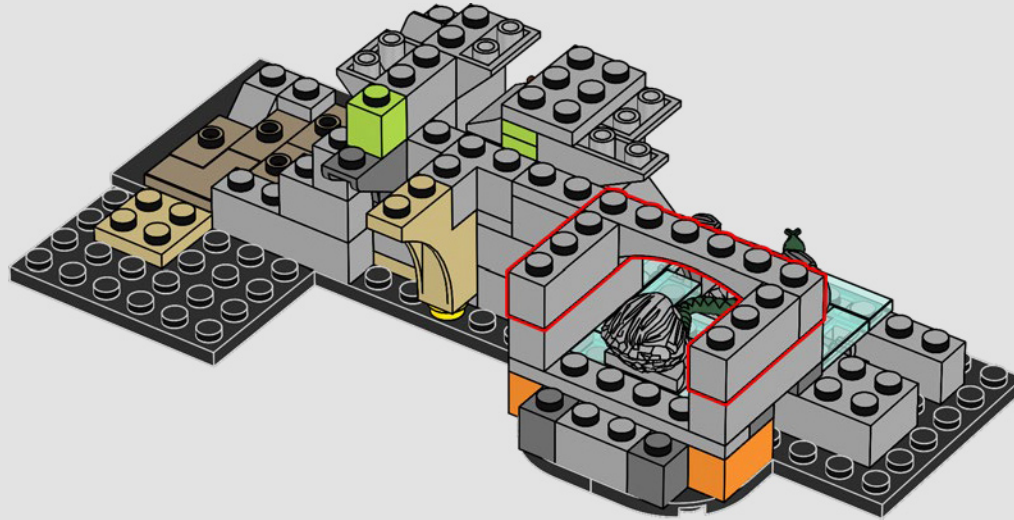

34

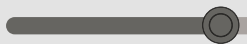
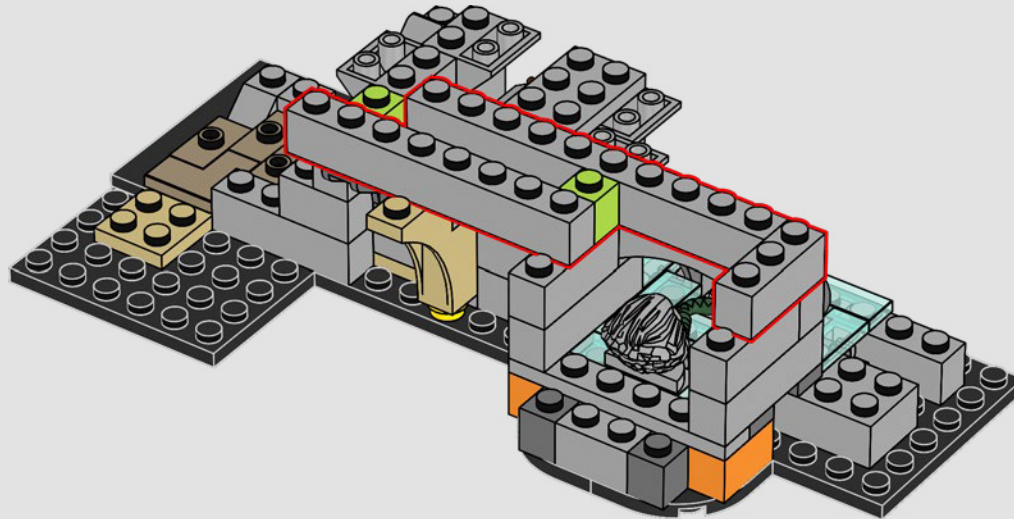

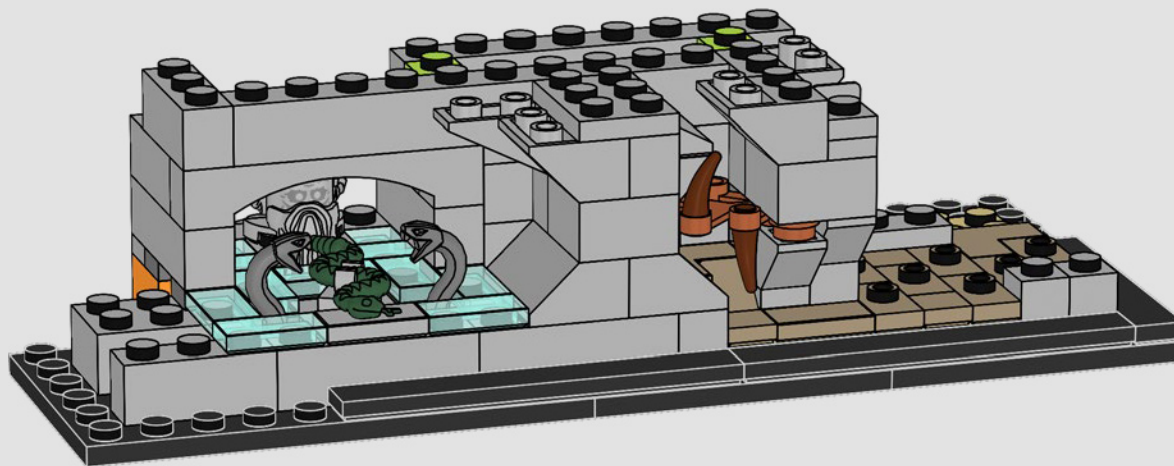

In a final act of defiance, Salazar Slytherin™ constructed The Chamber of Secrets™. A huge Basilisk was bewitched to honor his 'true heir' and bring ruthless destruction upon all Muggle™-born.

Dans un ultime acte de provocation, Salazar Serpentard a construit la Chambre des Secrets. Un énorme Basilic a été ensorcelé pour honorer son « véritable héritier » et infliger une impitoyable destruction à tous les nés-Moldus.

En un último acto desafiante, Salazar Slytherin™ construyó la Cámara de los Secretos. Un enorme Basilisco fue hechizado para honrar a su "verdadero heredero" y llevar la destrucción más despiadada a todos los que nacieron siendo Muggles™.



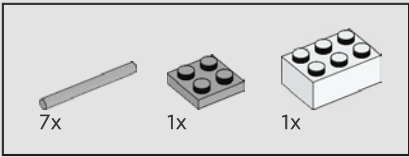

35

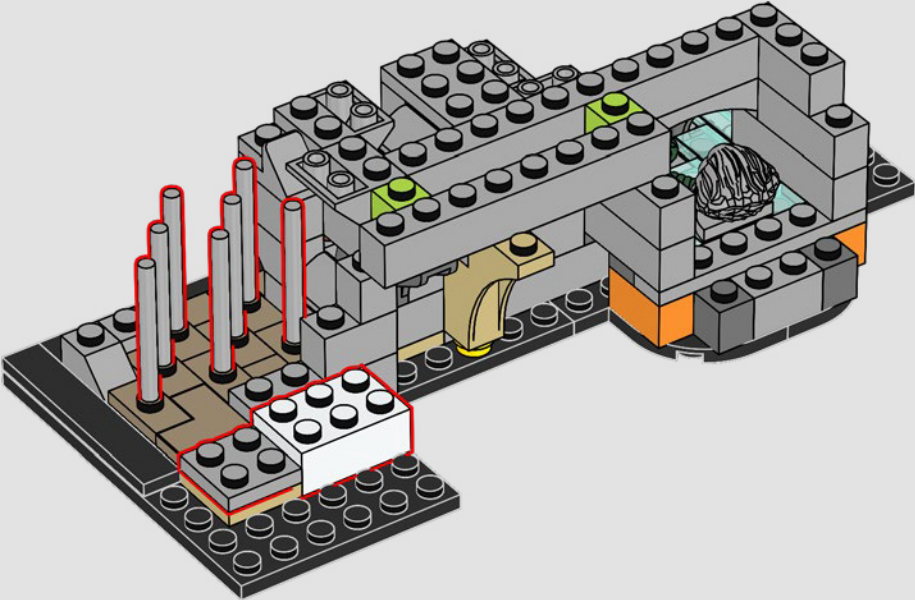

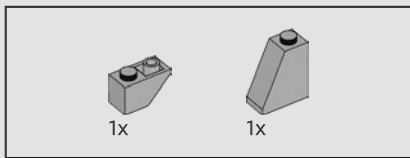

36

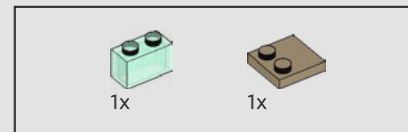
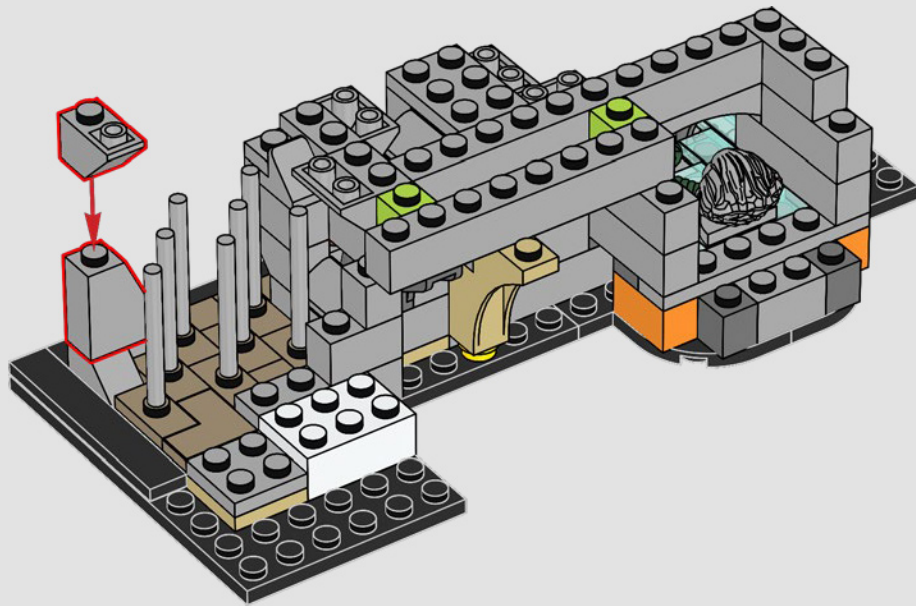

37

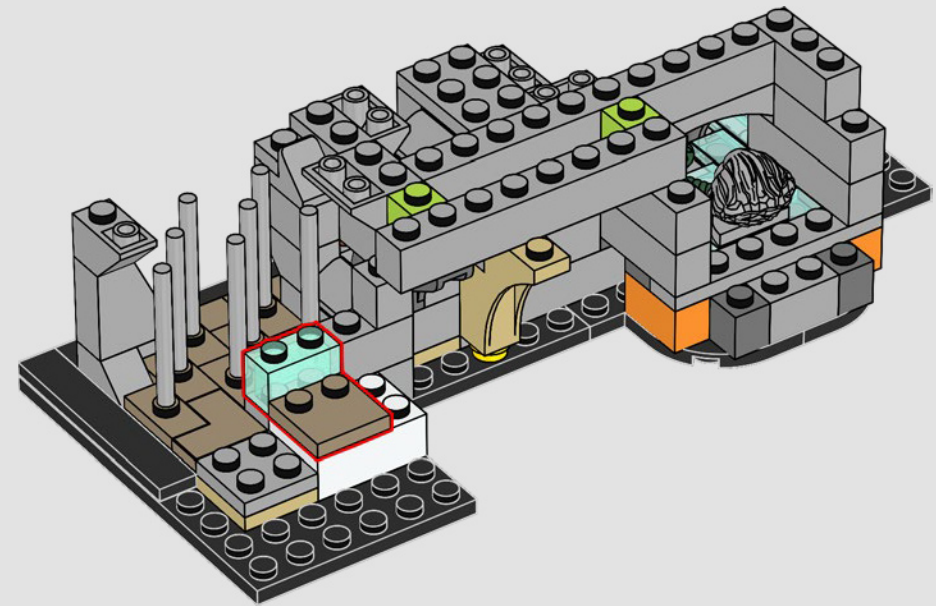

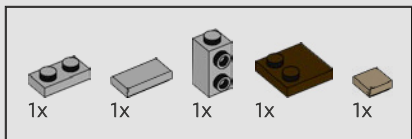

38

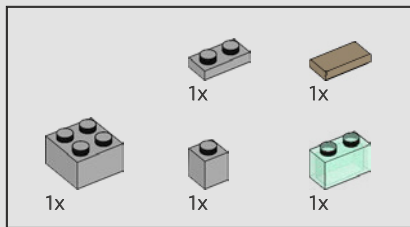
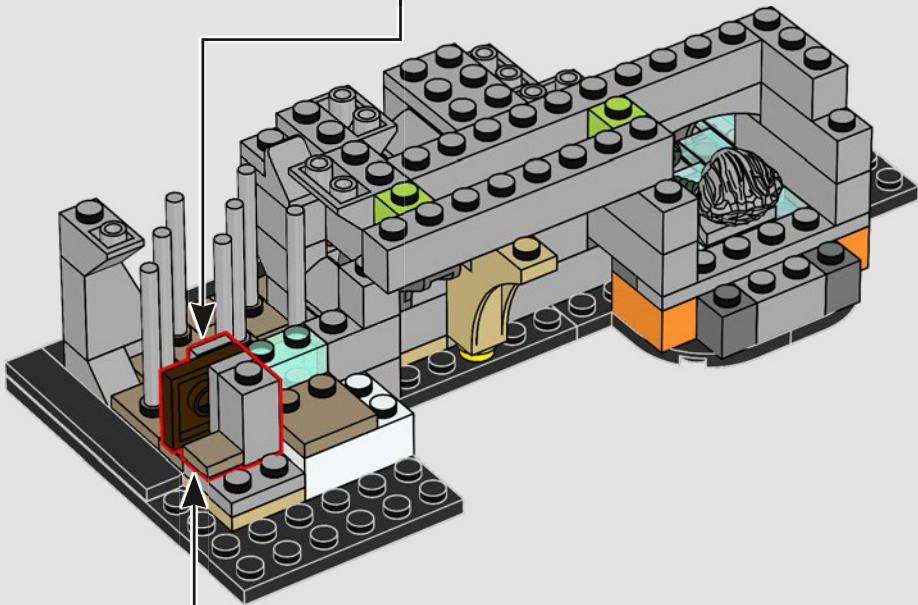
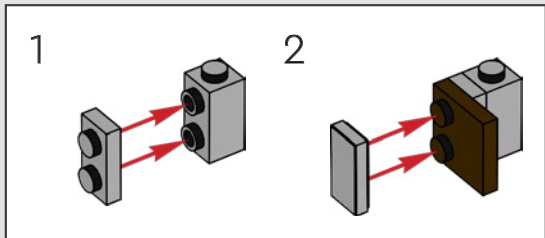

39

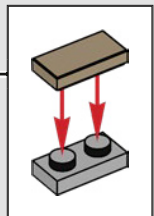
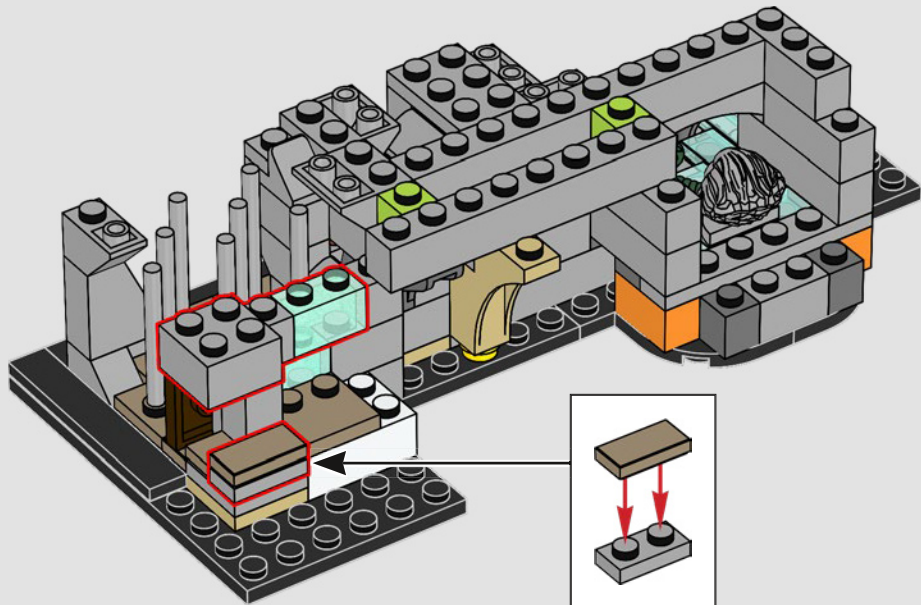



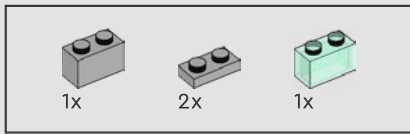

40

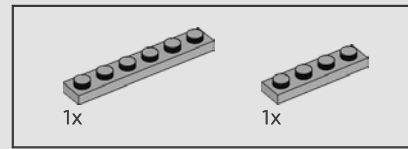
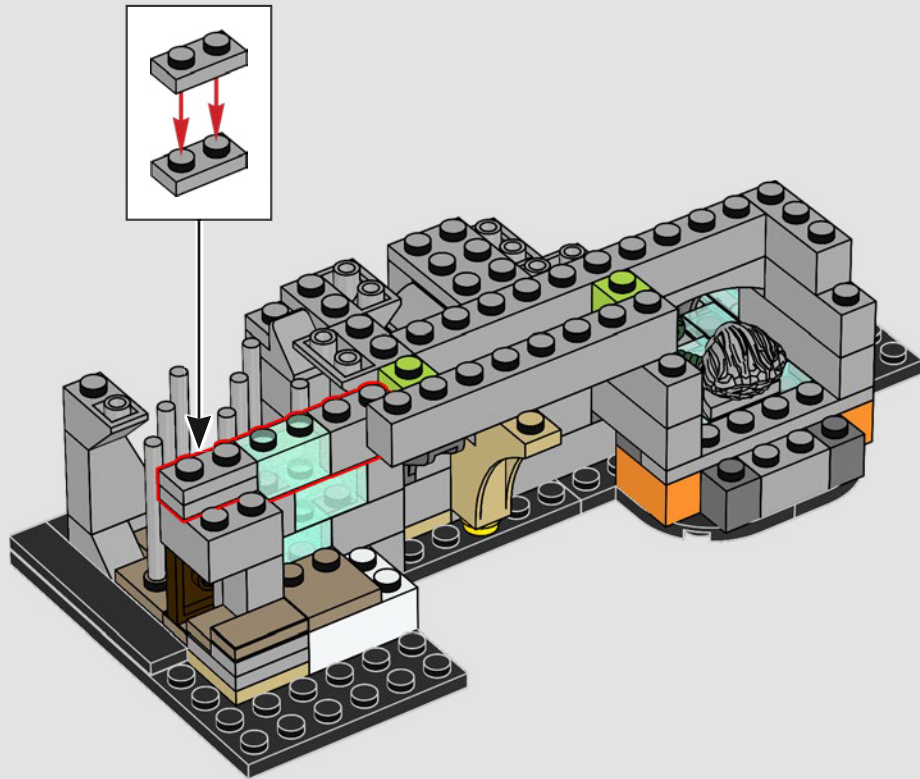

41

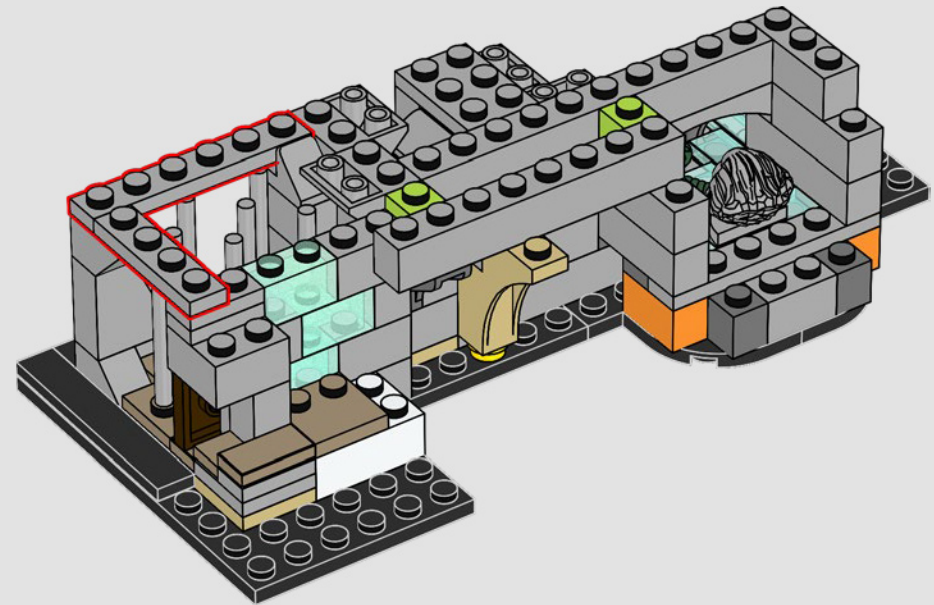

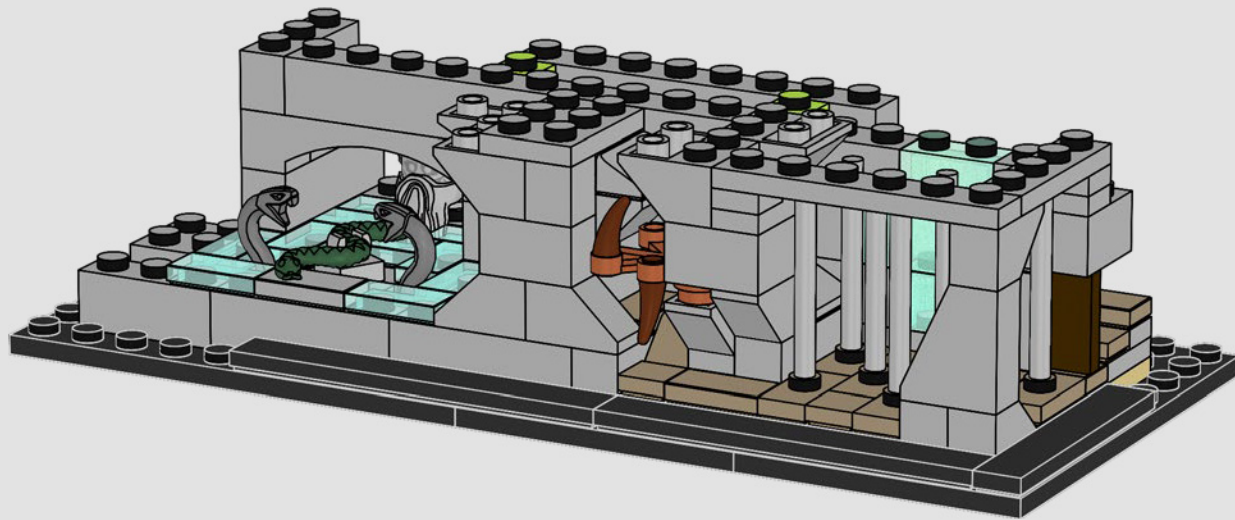

The Winged Key room was Professor Flitwick's clever construction, as one of the obstacles the Hogwarts™ staff designed to protect the secret hiding place of the Sorcerer's Stone™.

Création ingénieuse du professeur Flitwick, la salle des clés ailées est l'un des obstacles que le personnel de Poudlard a mis en place pour protéger la cachette secrète de la Pierre philosophale.

Construida por el Profesor Flitwick, la habitación de las llaves aladas fue diseñada por el personal de Hogwarts™ a manera de obstáculo para proteger el escondite secreto de la Piedra Filosofal.



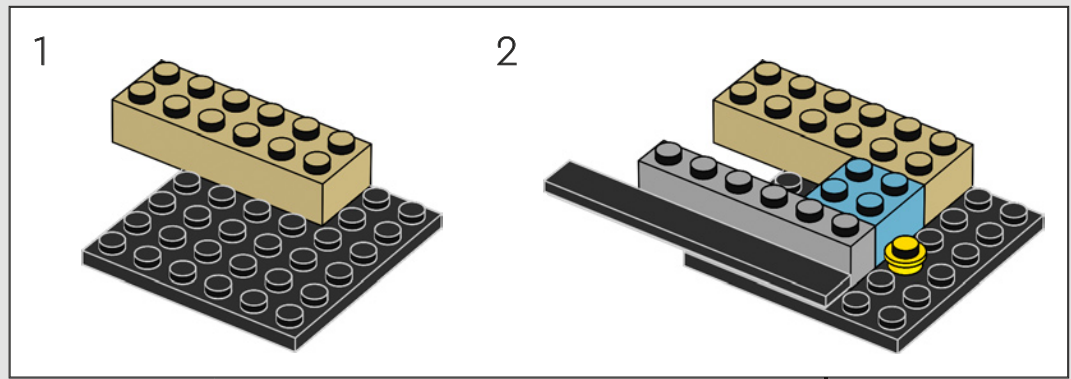
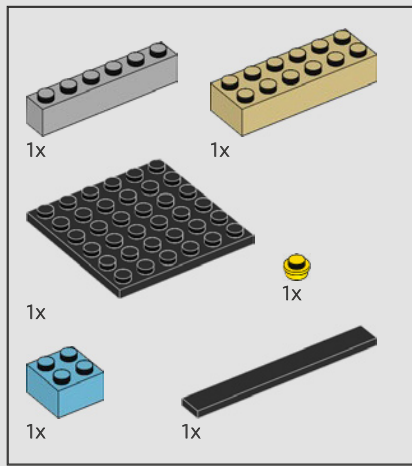

42

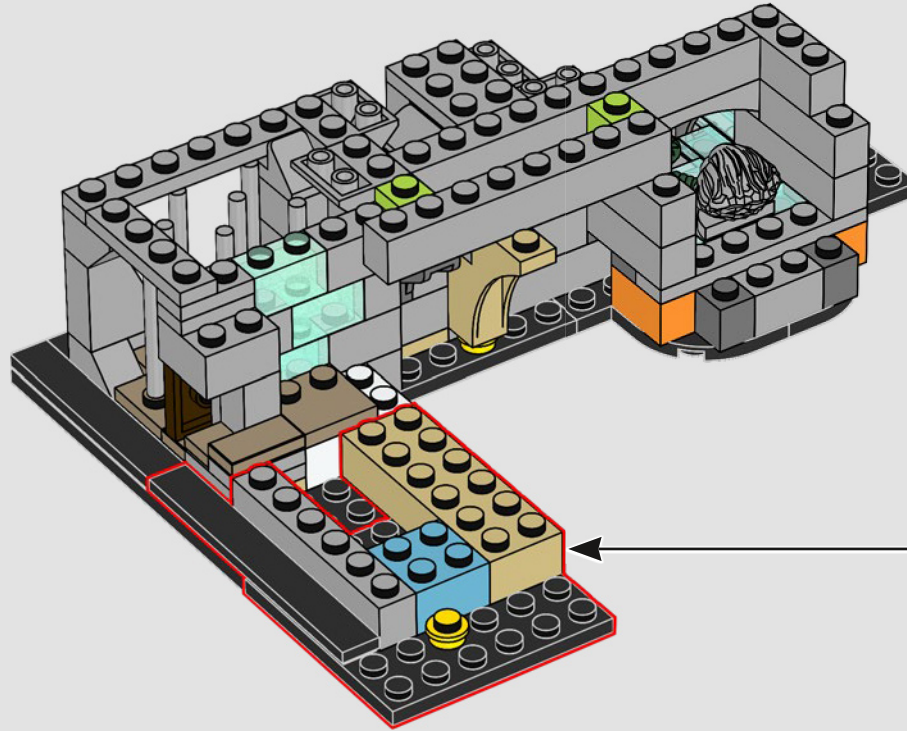

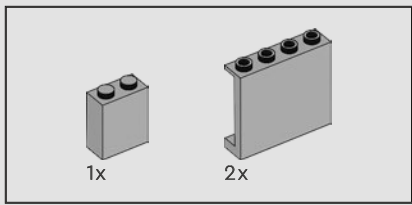

43

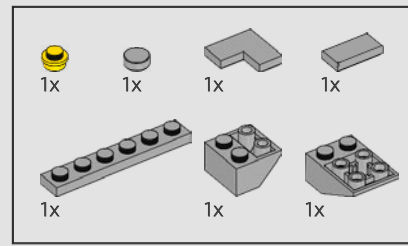
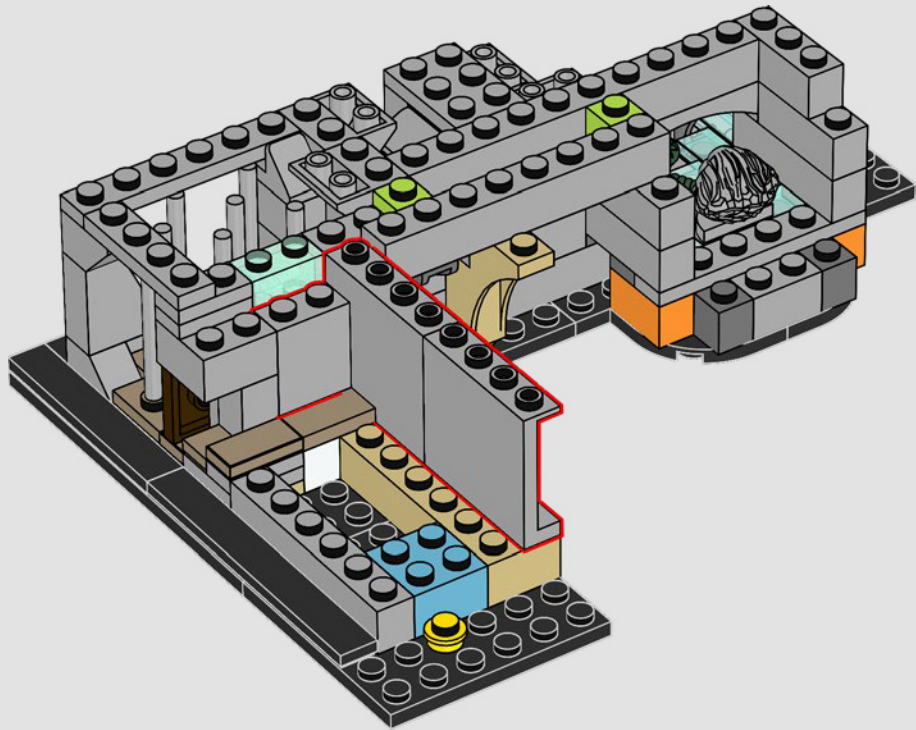

44

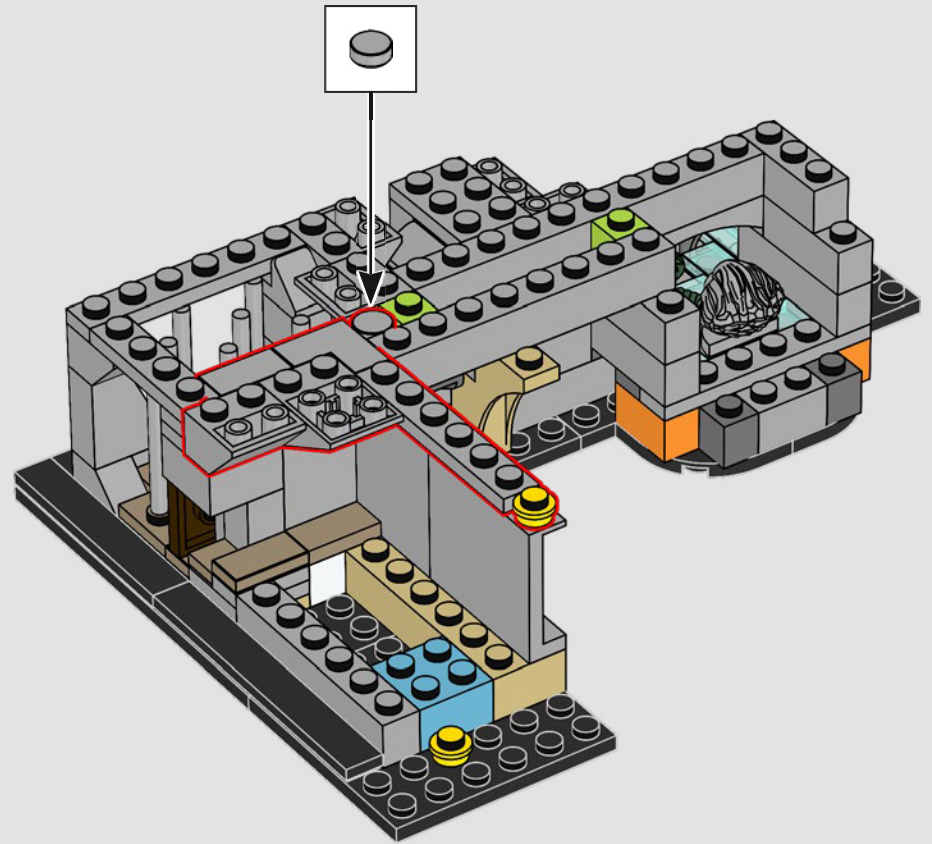

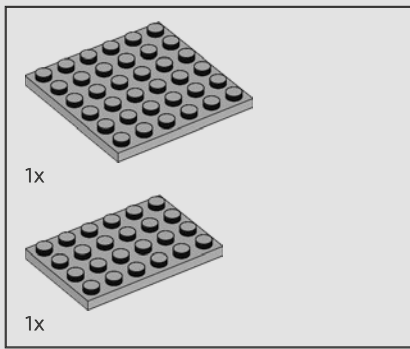

45

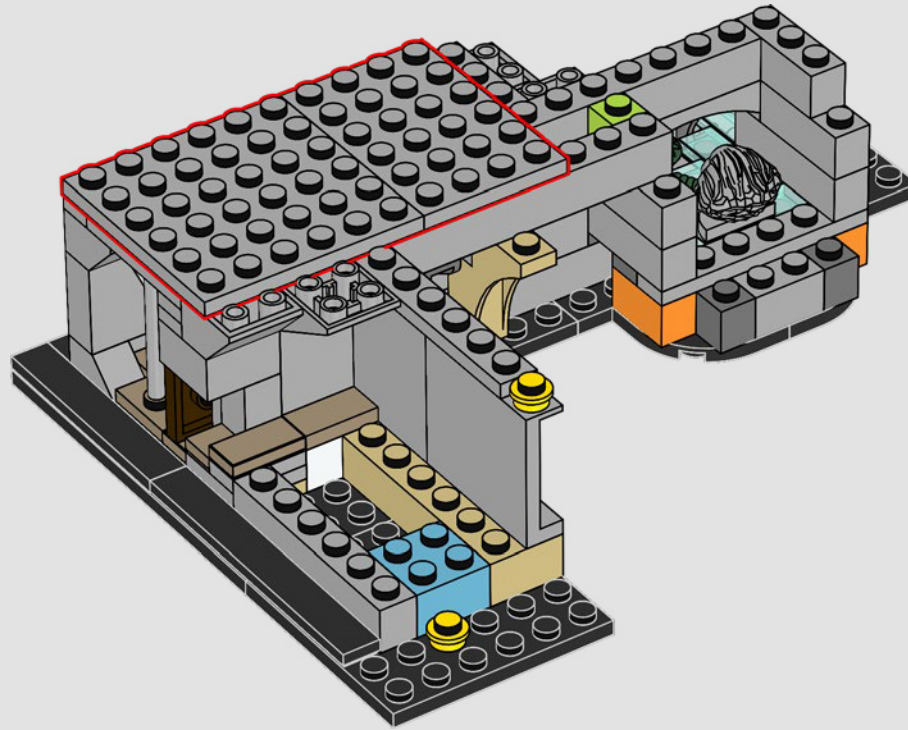

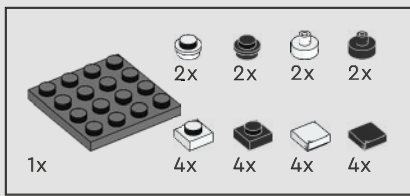

46

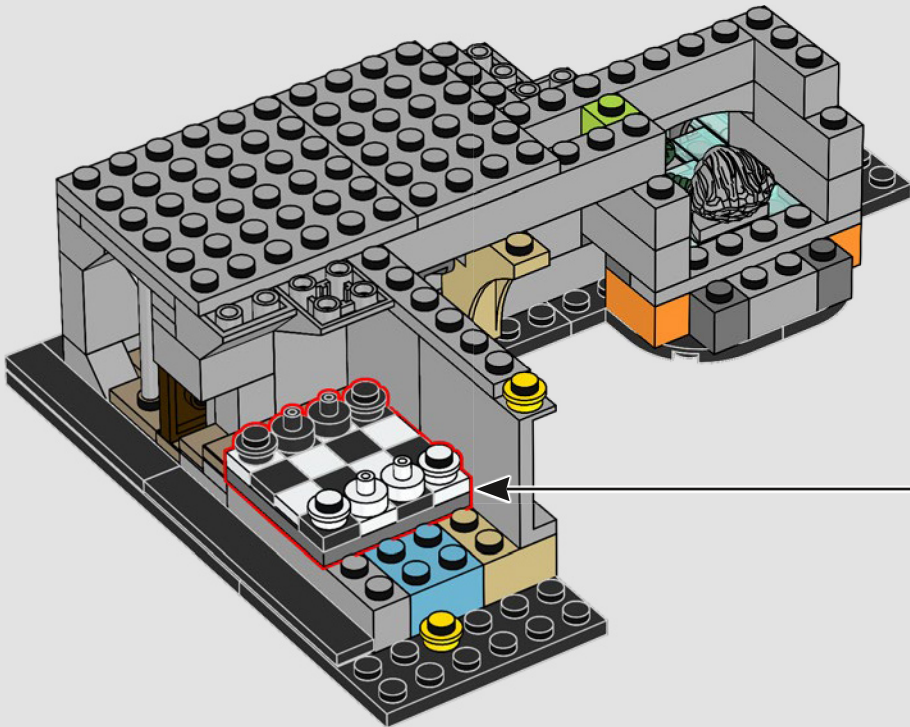
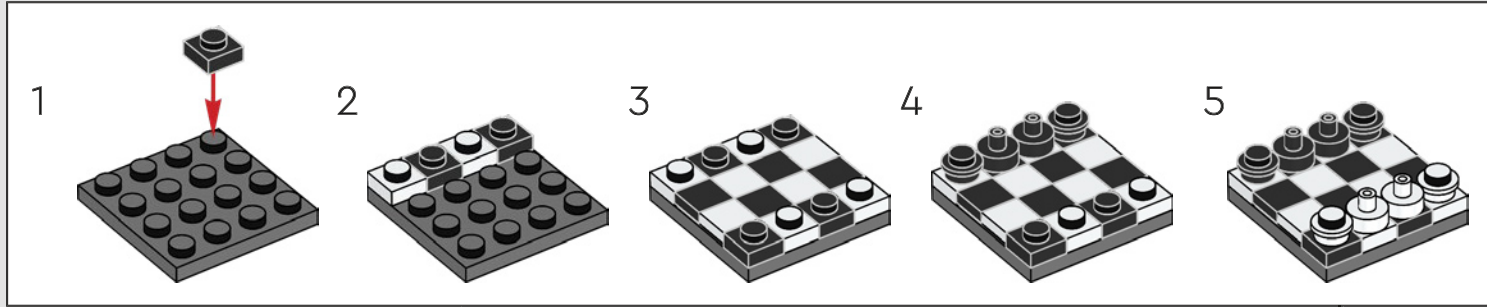

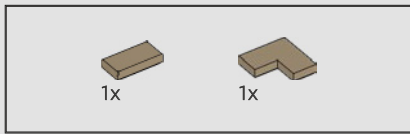

47

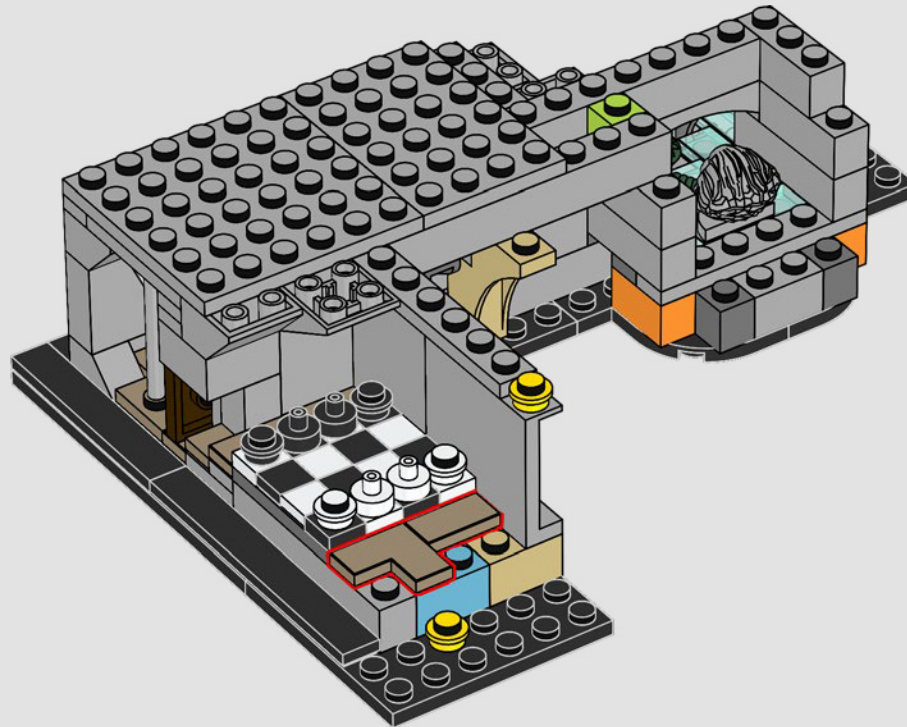

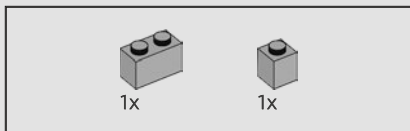

48

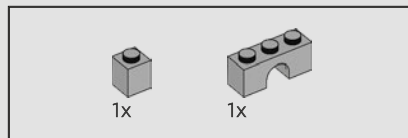
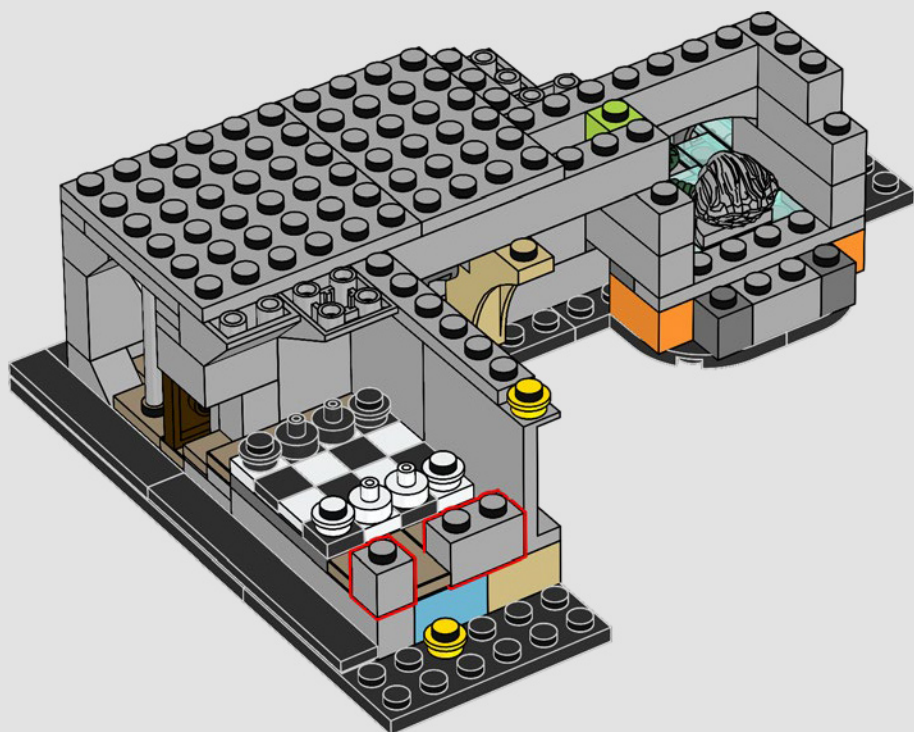

49

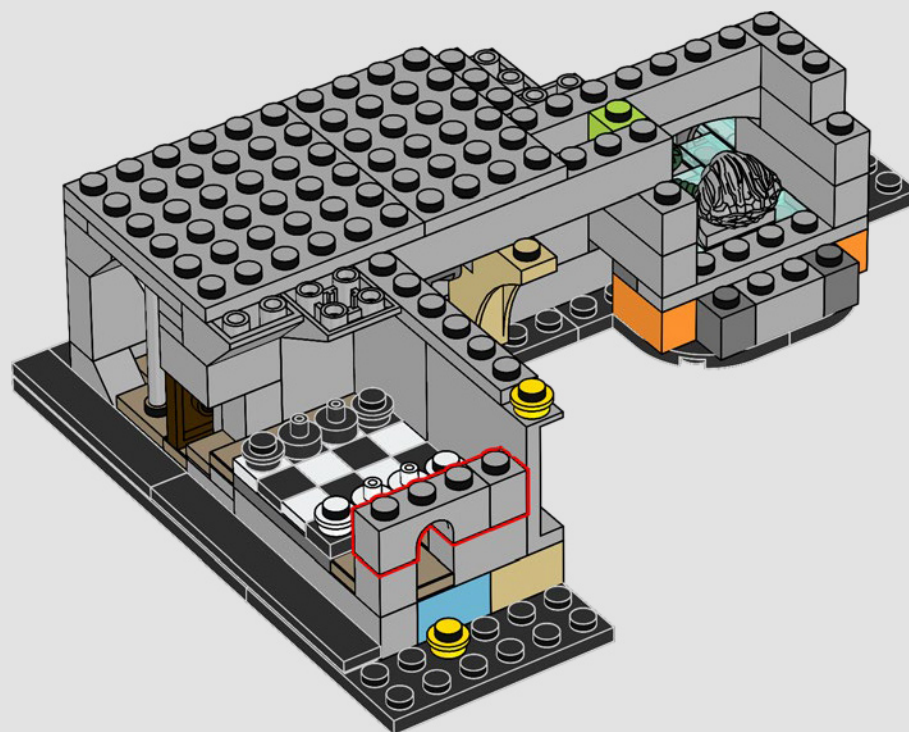



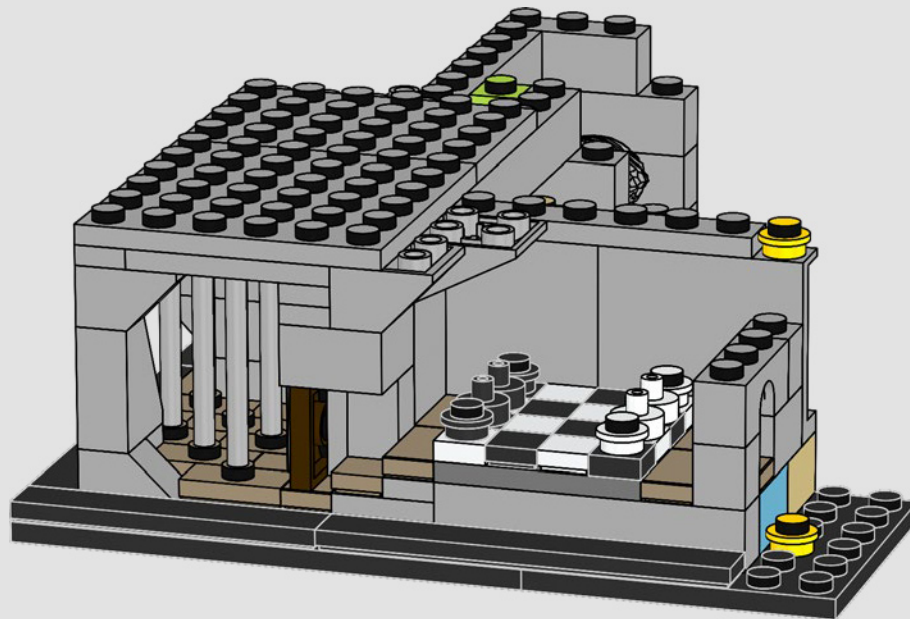

The Chessboard Chamber was another obstacle protecting the Sorcerer's Stone™ – one that required strategic skills, bravery and sacrifice. Ron fully deserved the 50 points he got for orchestrating his epic game!

Protection supplémentaire pour la Pierre philosophale, la Chambre de l'échiquier est un obstacle de taille – un obstacle qui nécessite stratégie, courage et sacrifices. Ron méritait pleinement les 50 points qu'il a obtenus pour avoir orchestré son jeu épique !

La habitación del tablero de ajedrez era otro obstáculo que protegía la Piedra Filosofal, uno que exigía habilidades estratégicas, valentía y sacrificio. ¡Ron se merecía plenamente los 50 puntos que obtuvo por orquestar su épica partida!

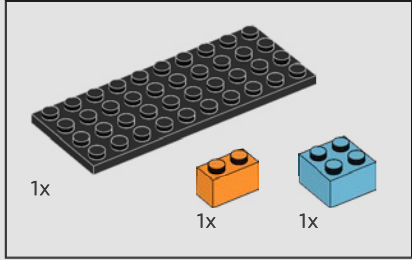
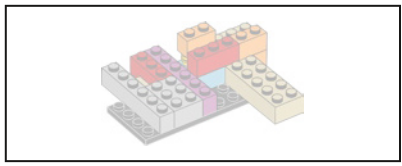

50

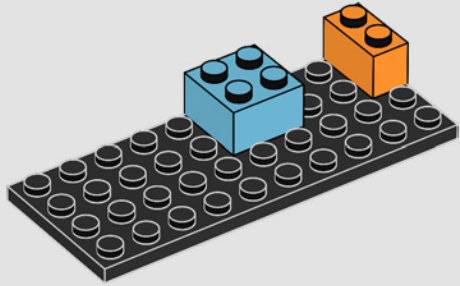

51

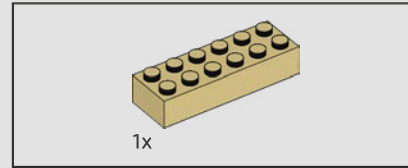
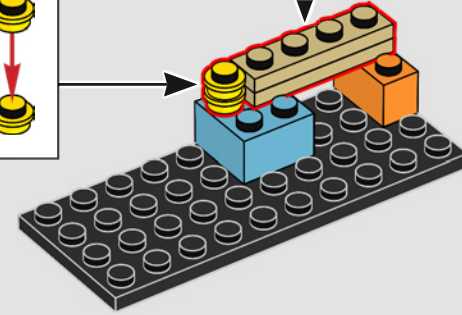
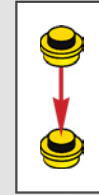
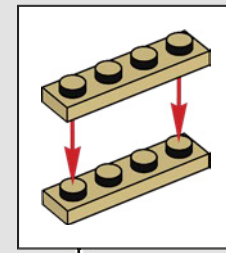

52

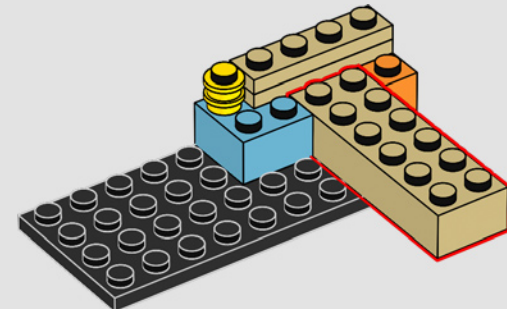

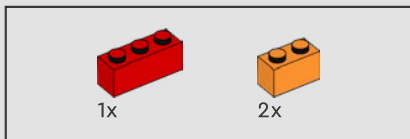

53

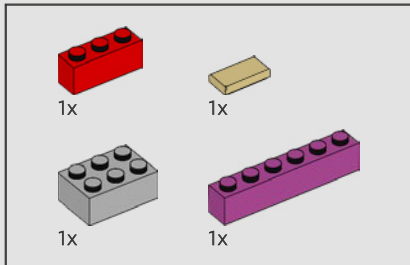
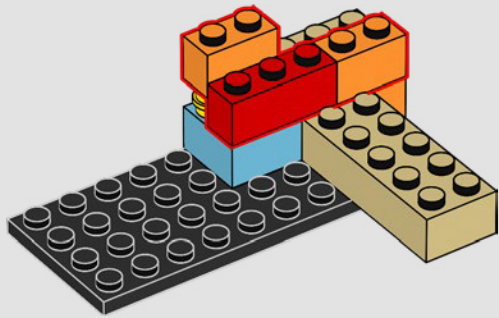

54

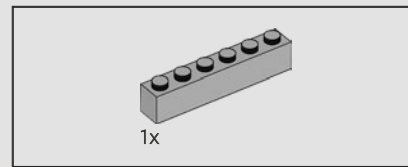
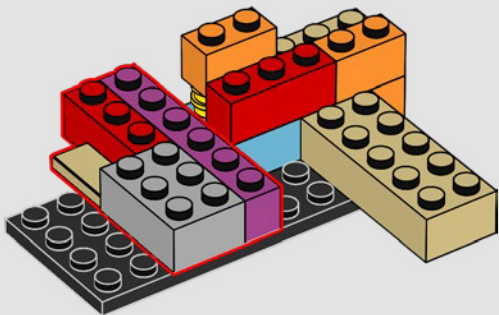

55

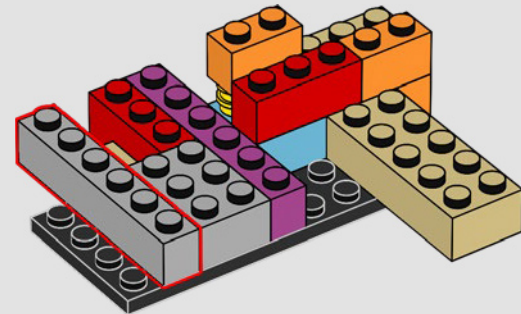

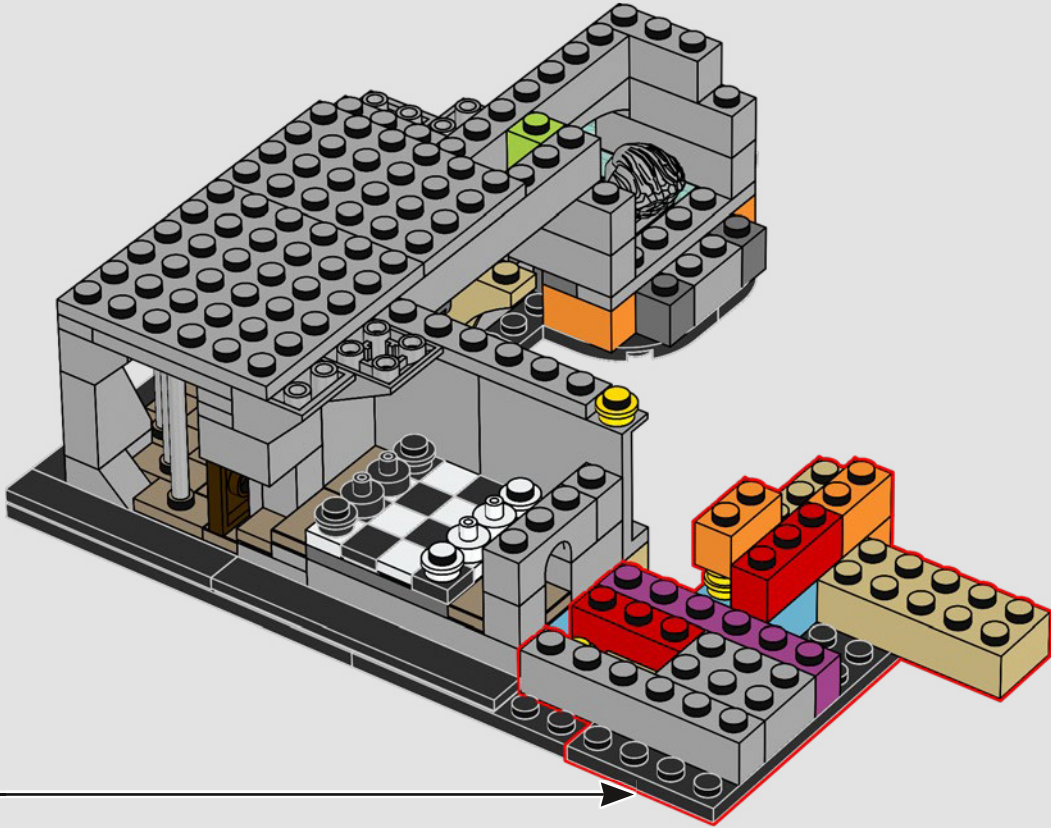

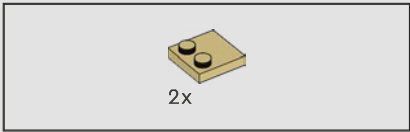

57

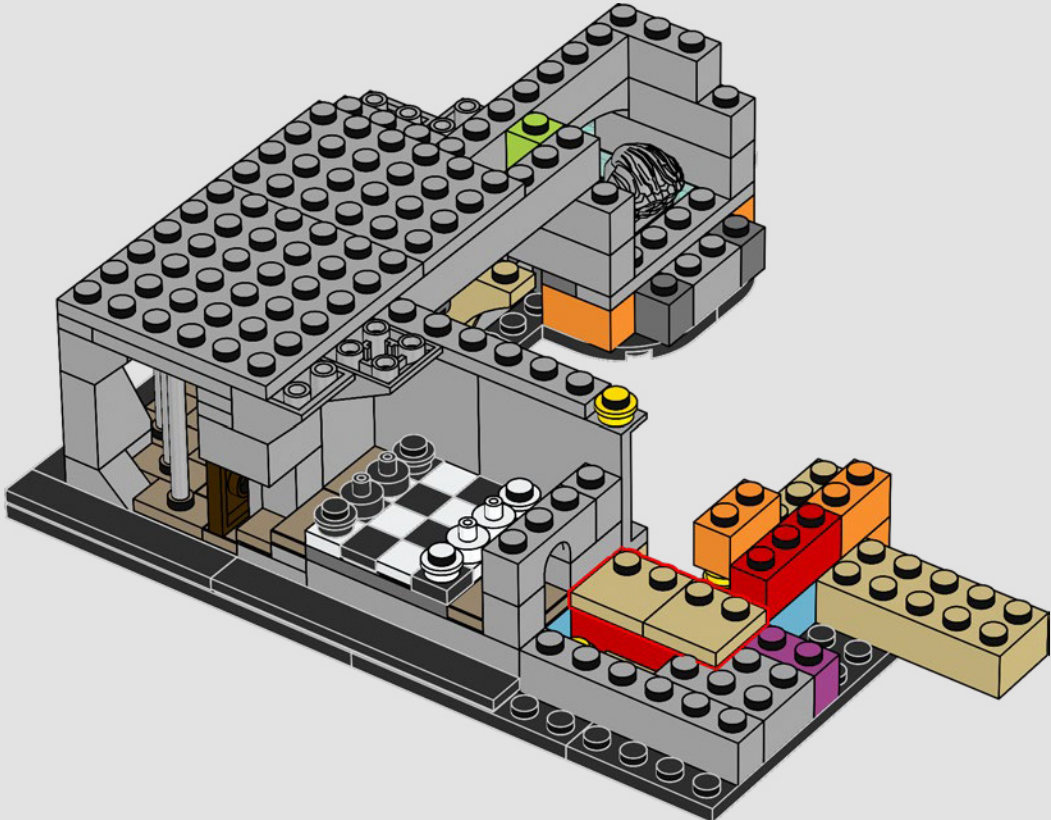



58

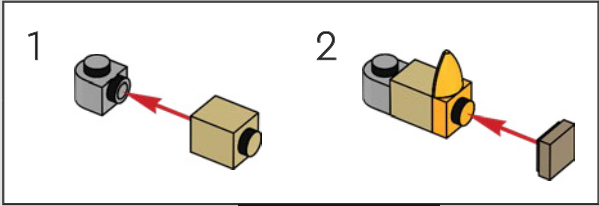
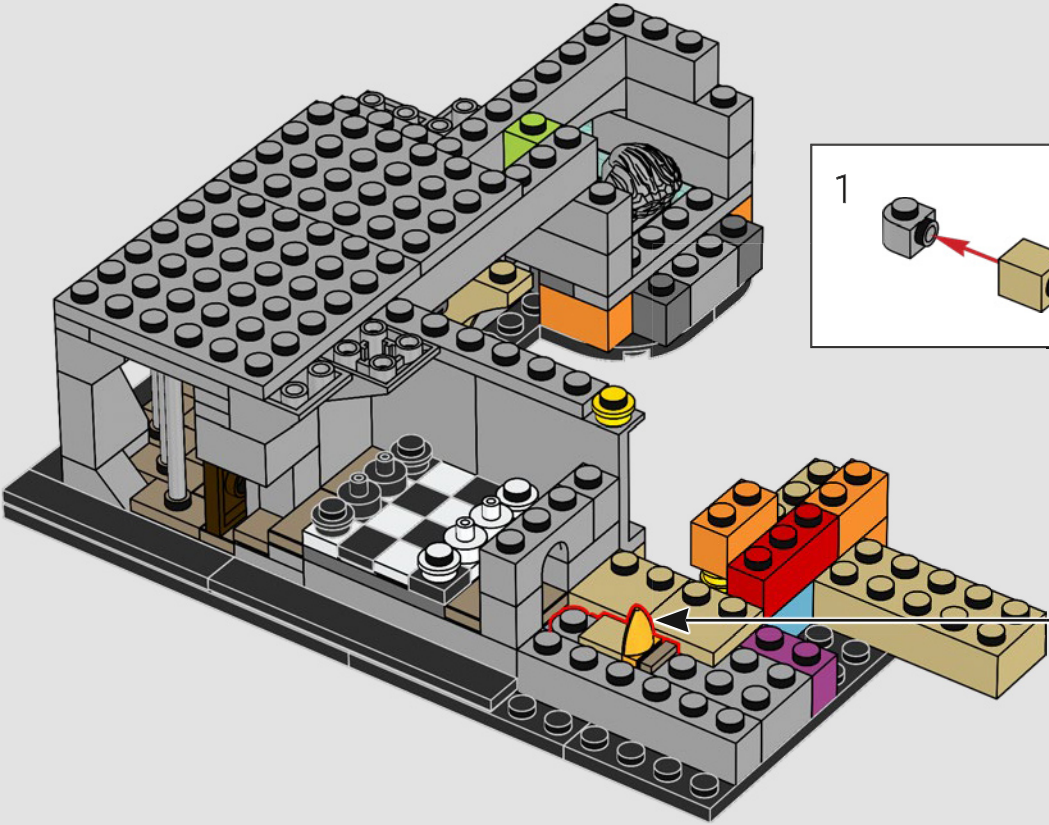

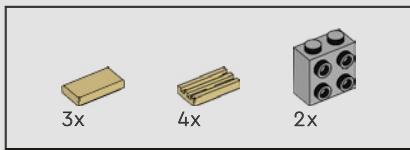

59

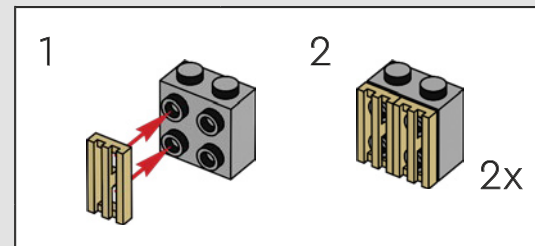
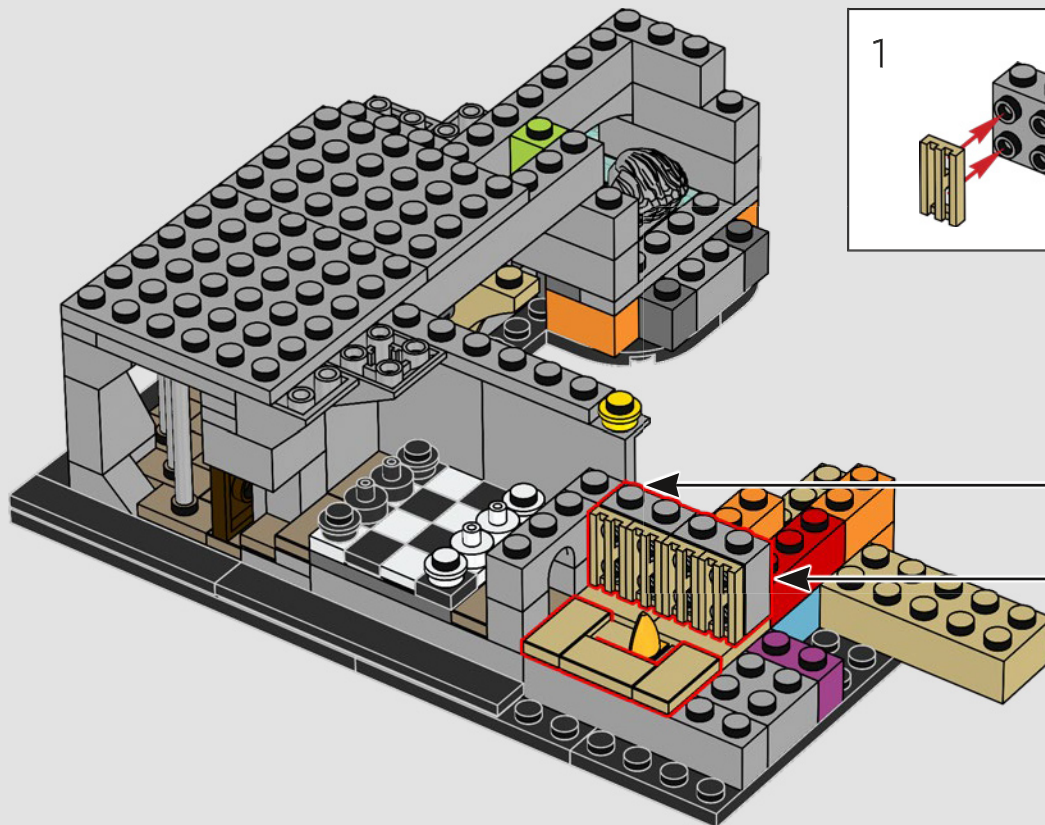

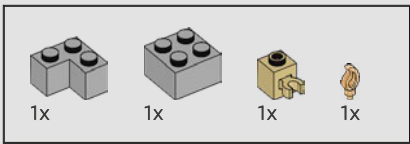

60

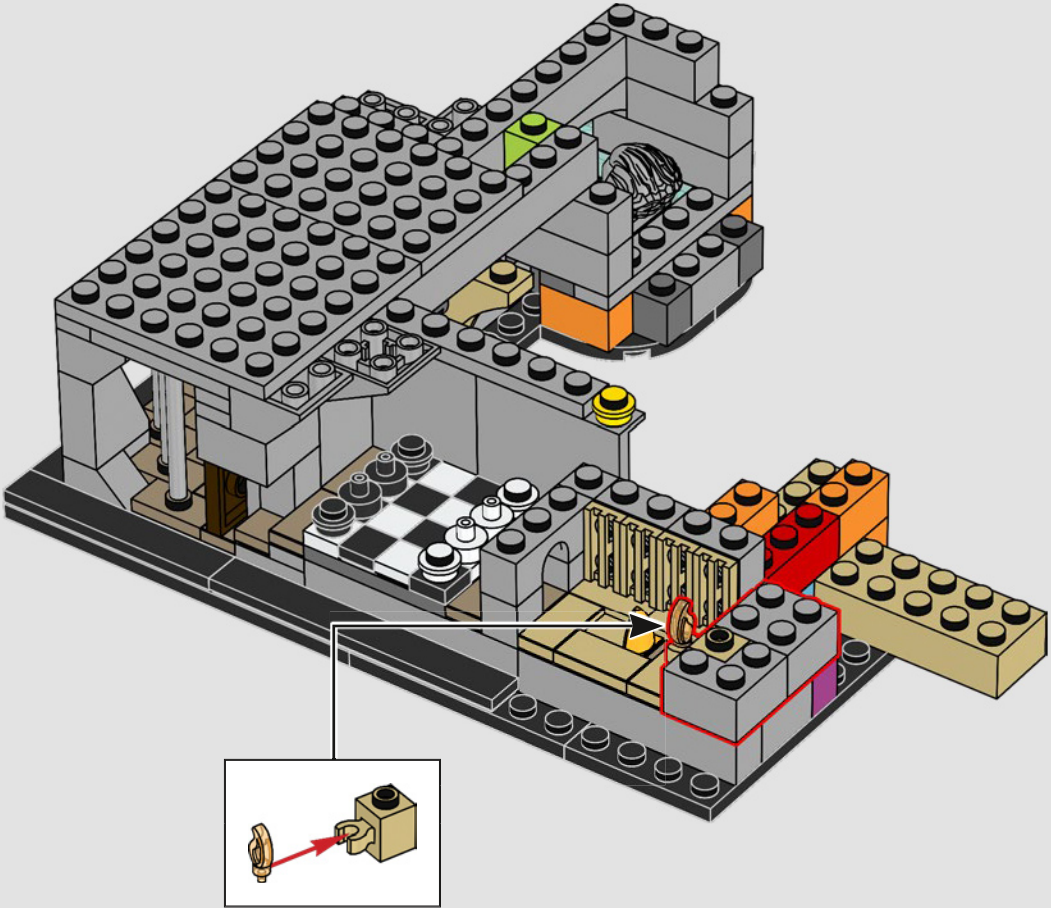





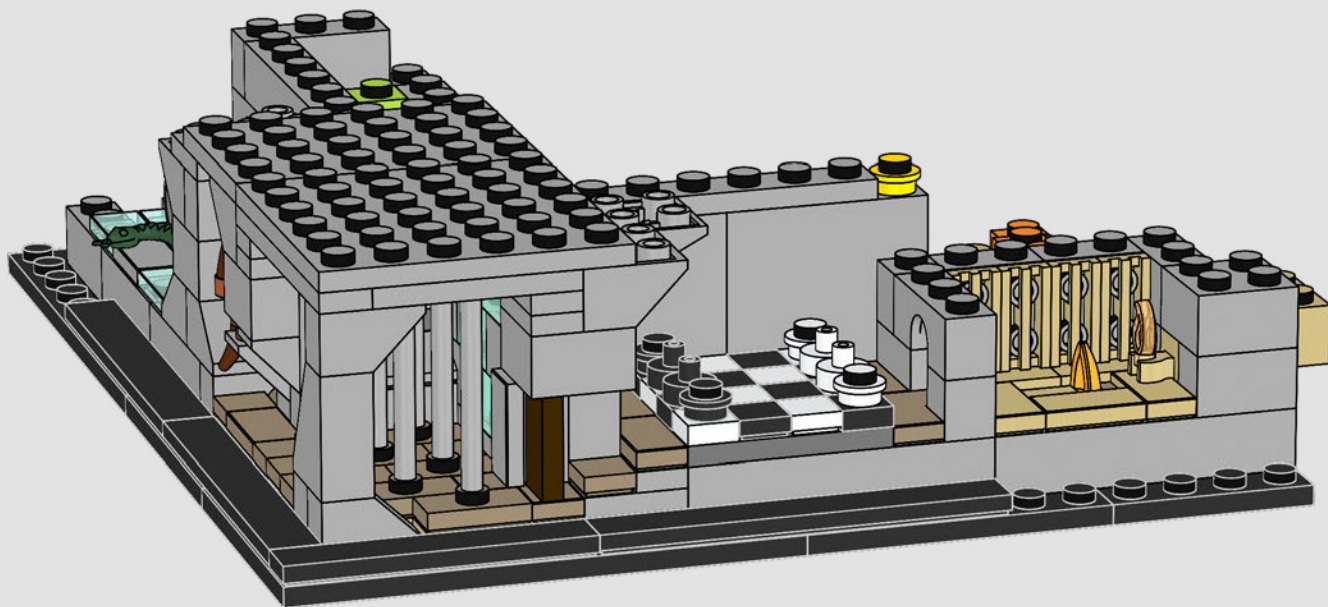

To understand the purpose of The Mirror of Erised, you must read its inscription backwards: "Erised stra ehru oyt ube cafru oyt on wohsi." (And maybe add or delete a few spaces in the process!)

Pour comprendre la raison d'être du Miroir du Riséd, il faut lire son inscription à l'envers : « Riséd elrue ocnot edsi amega siv notsap ert nomen ej. » (Et peut-être ajouter ou supprimer quelques espaces au passage !)

Para comprender el propósito del Espejo de Oesed, debes leer su inscripción al revés: "Oesed lenoz aro cut edon isara cut se onotse". (¡Y tal vez añadir o eliminar algunos espacios en el proceso!).



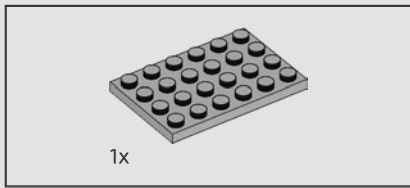

62

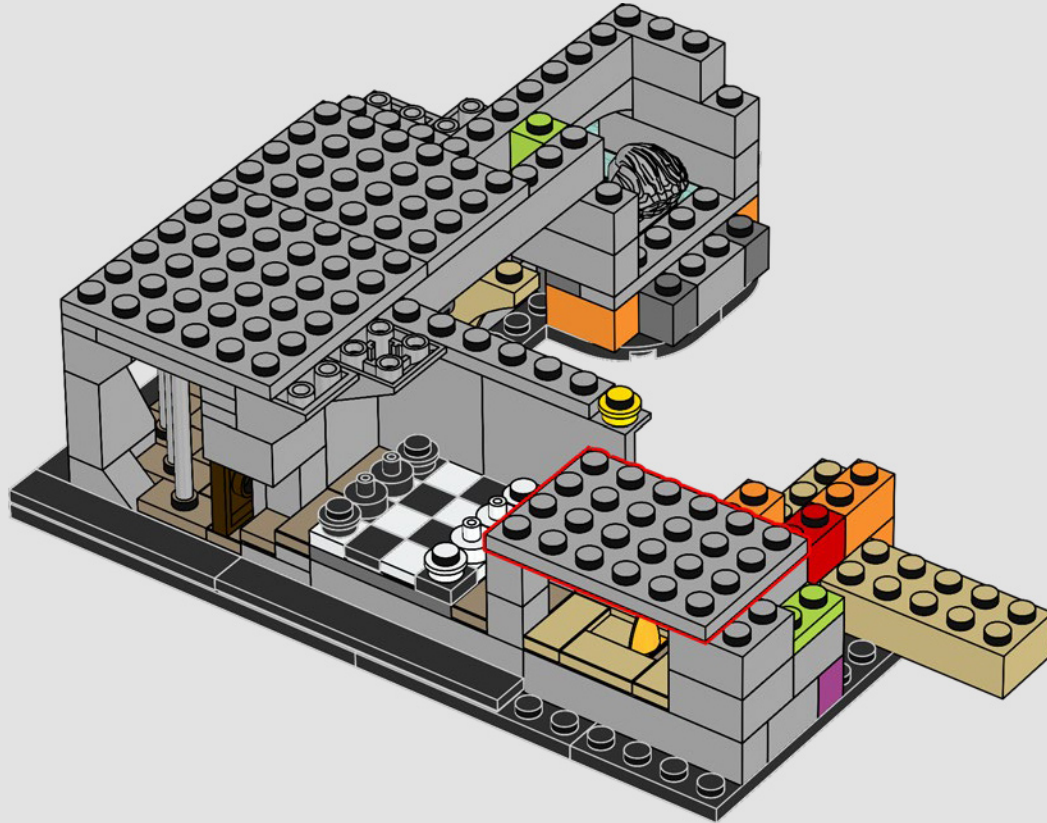



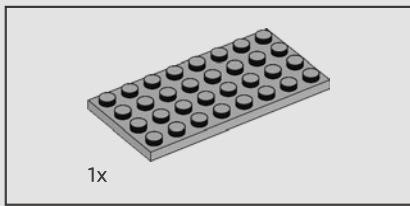

64

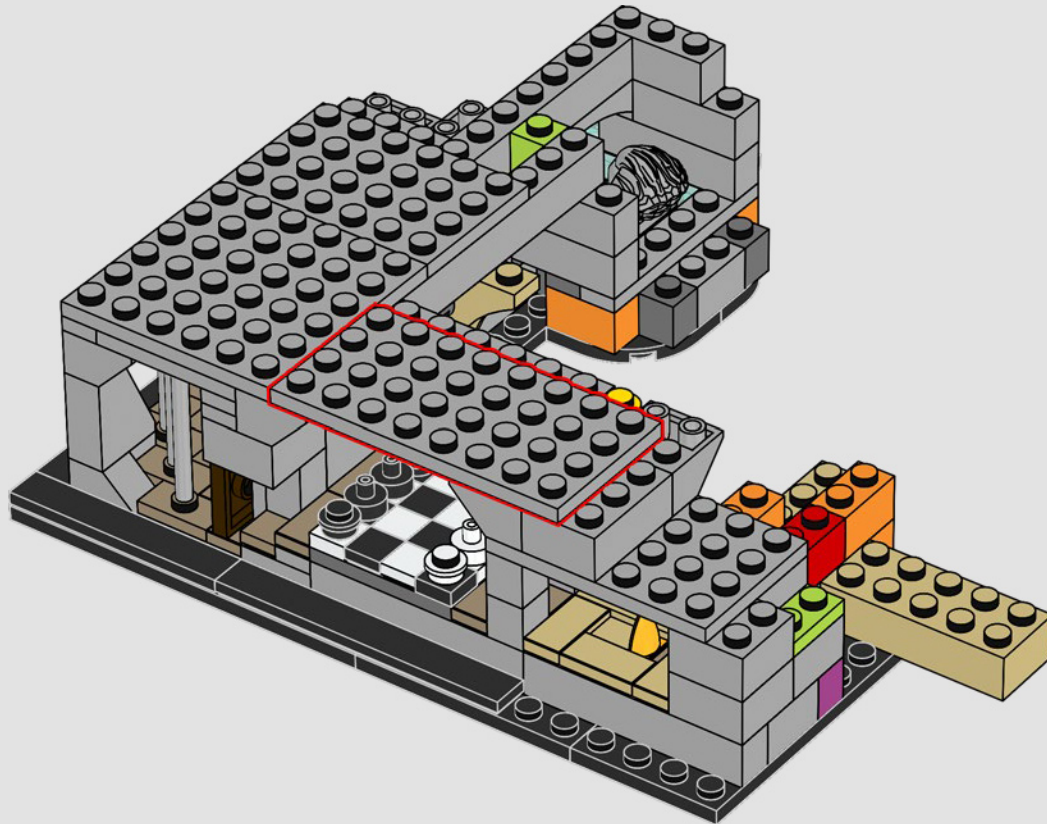

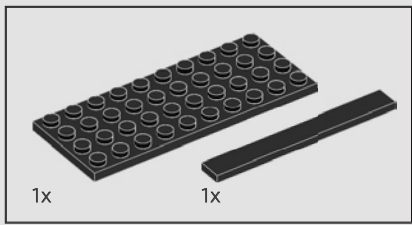

65

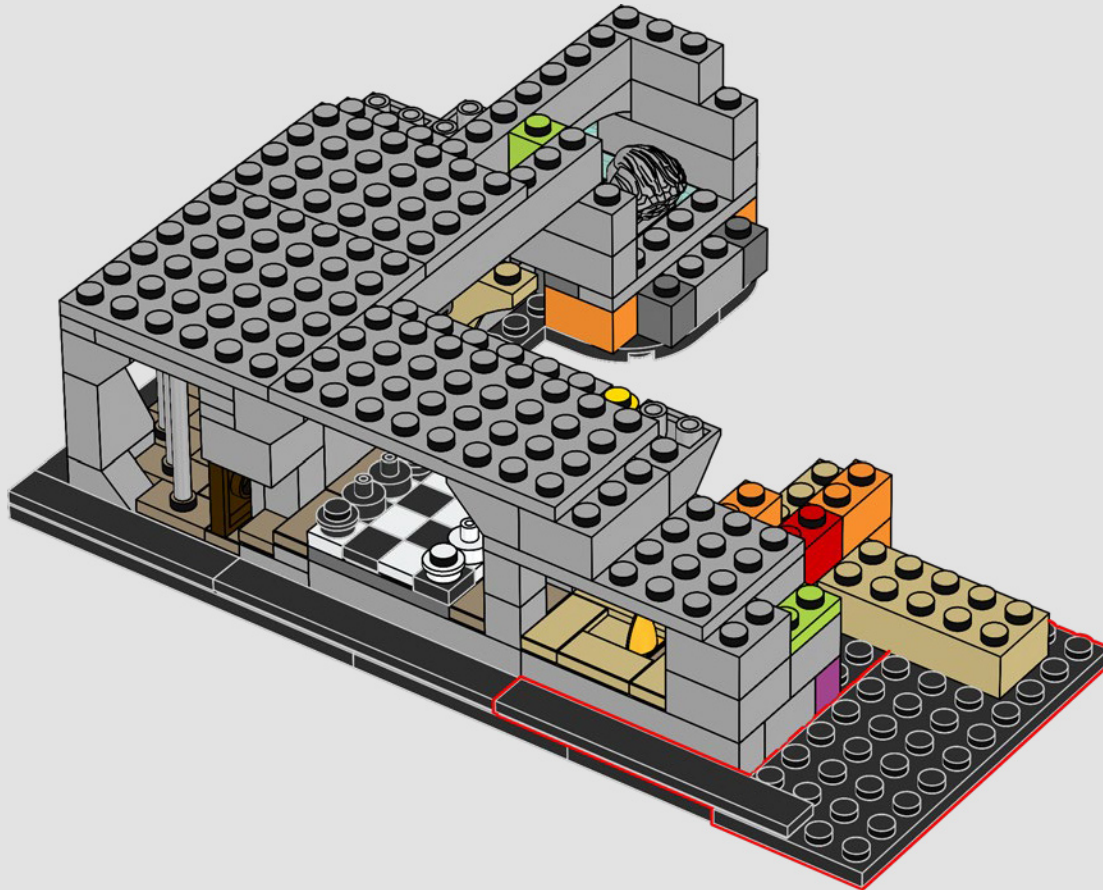

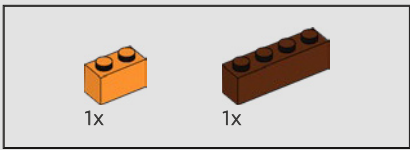

66

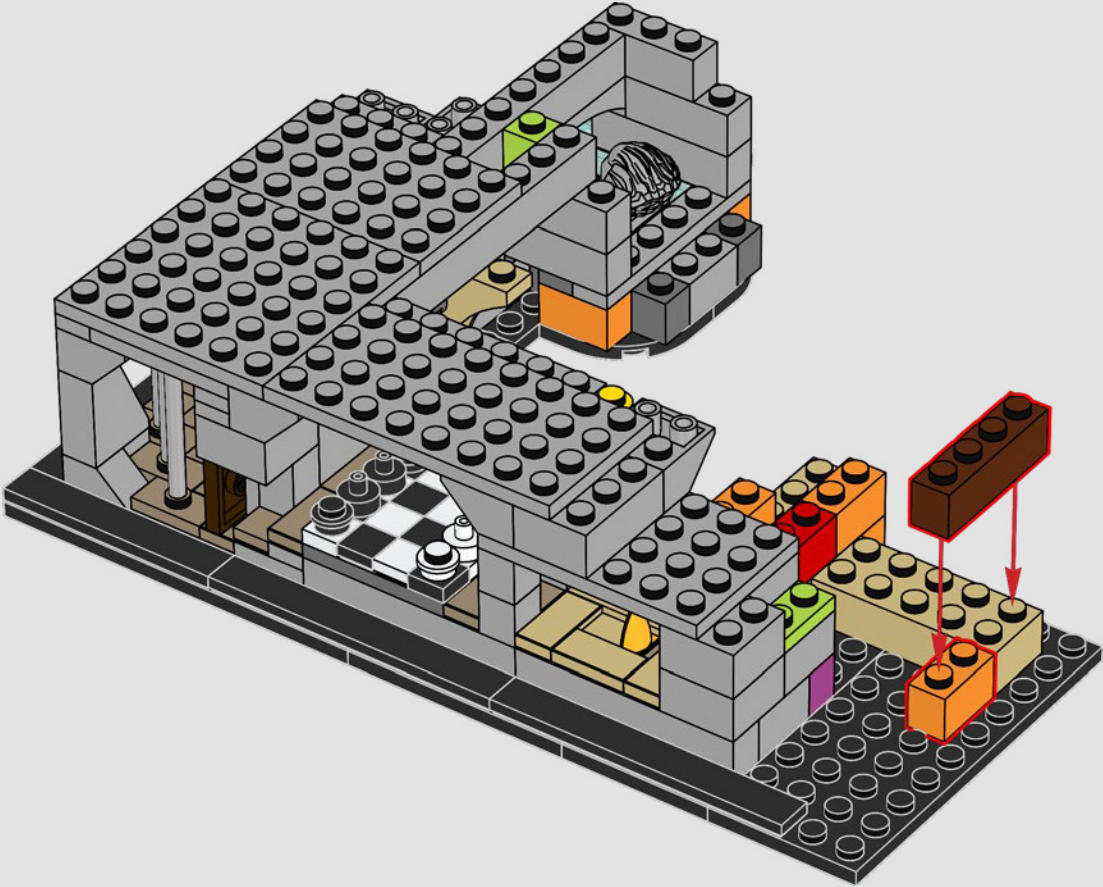

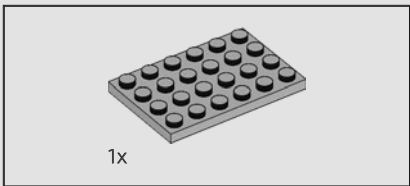

67

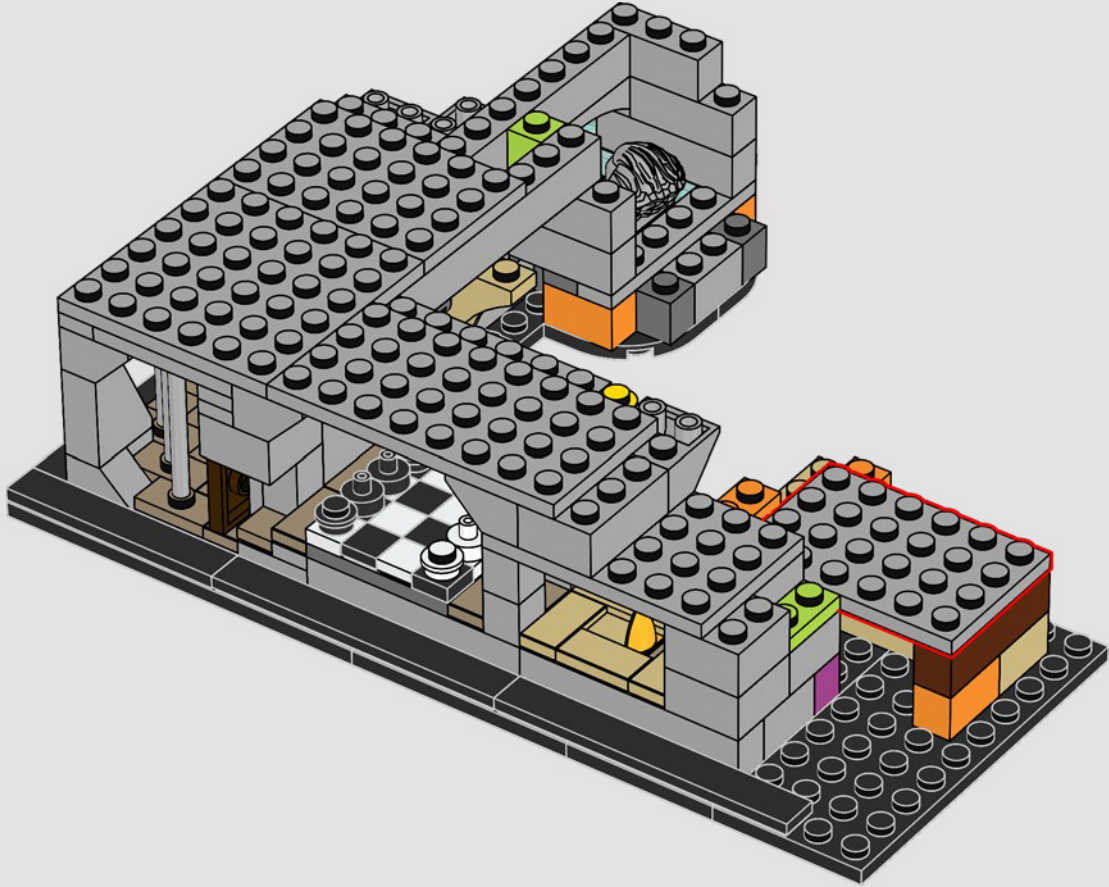





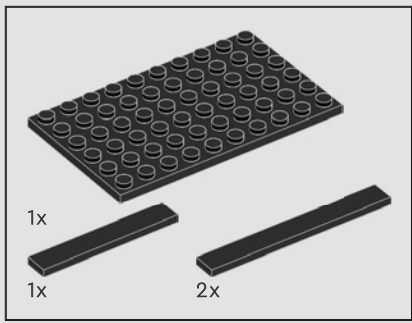

68

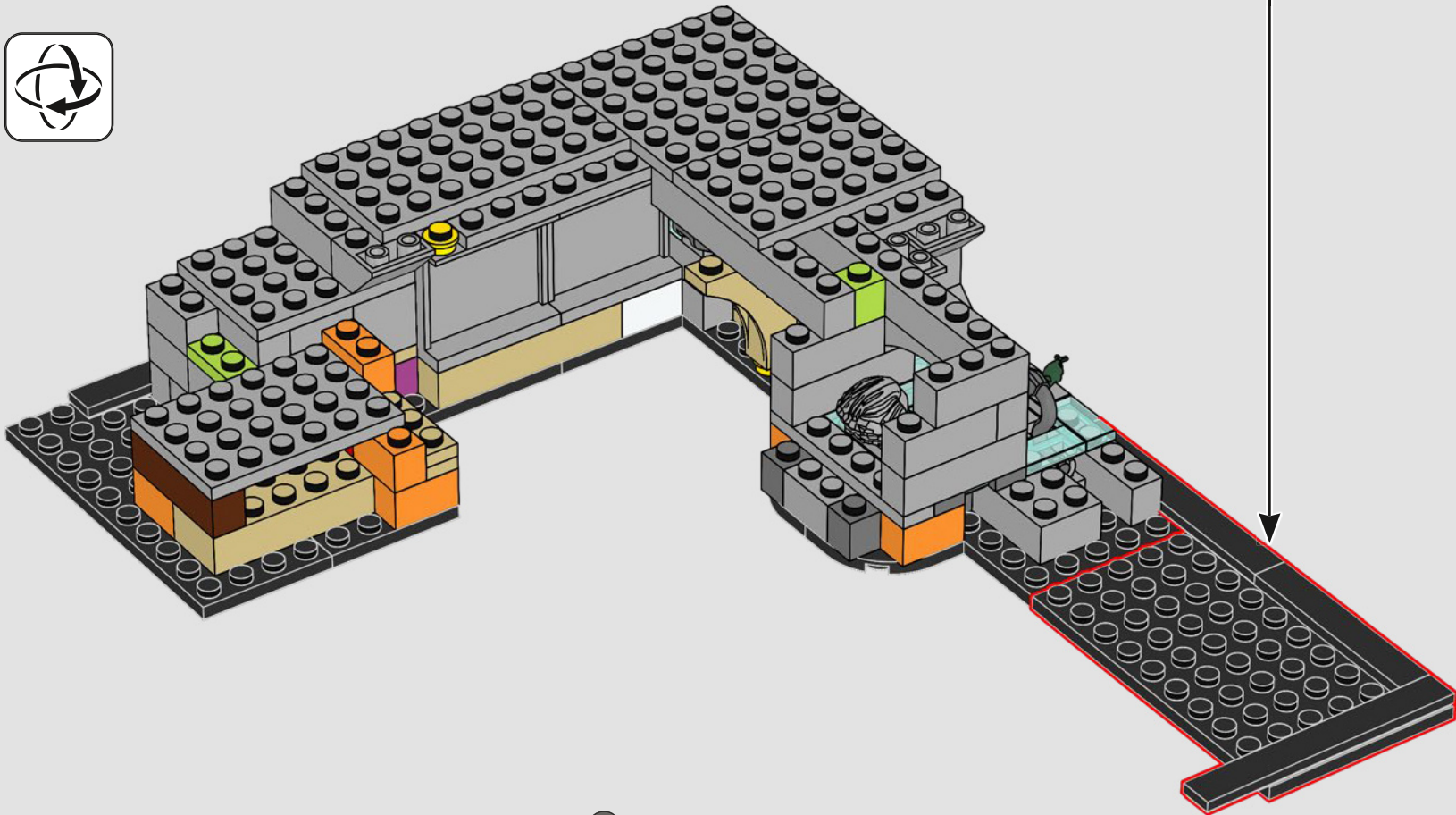
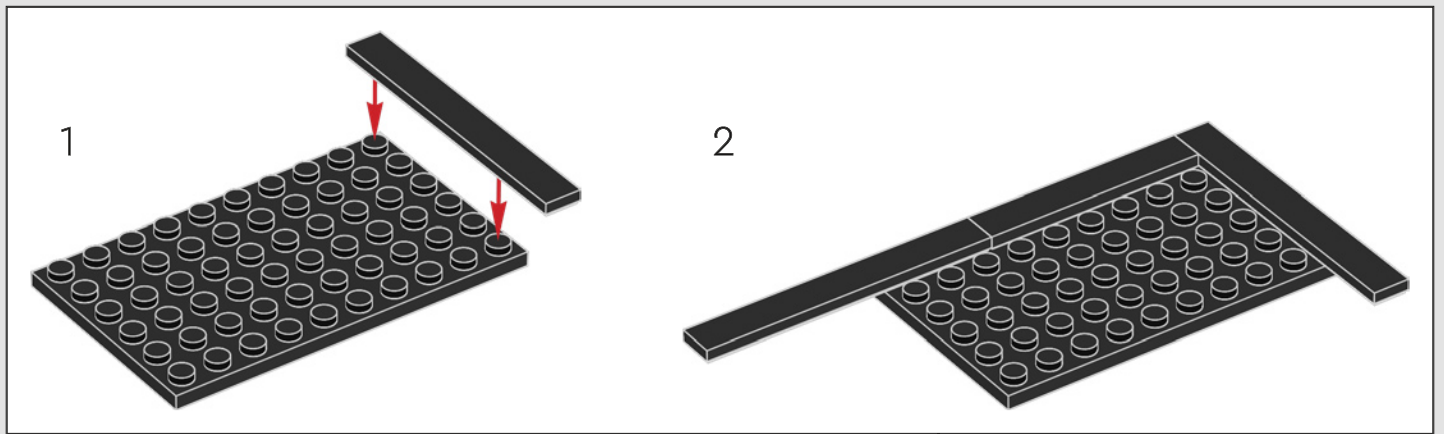

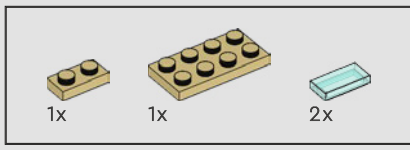

69

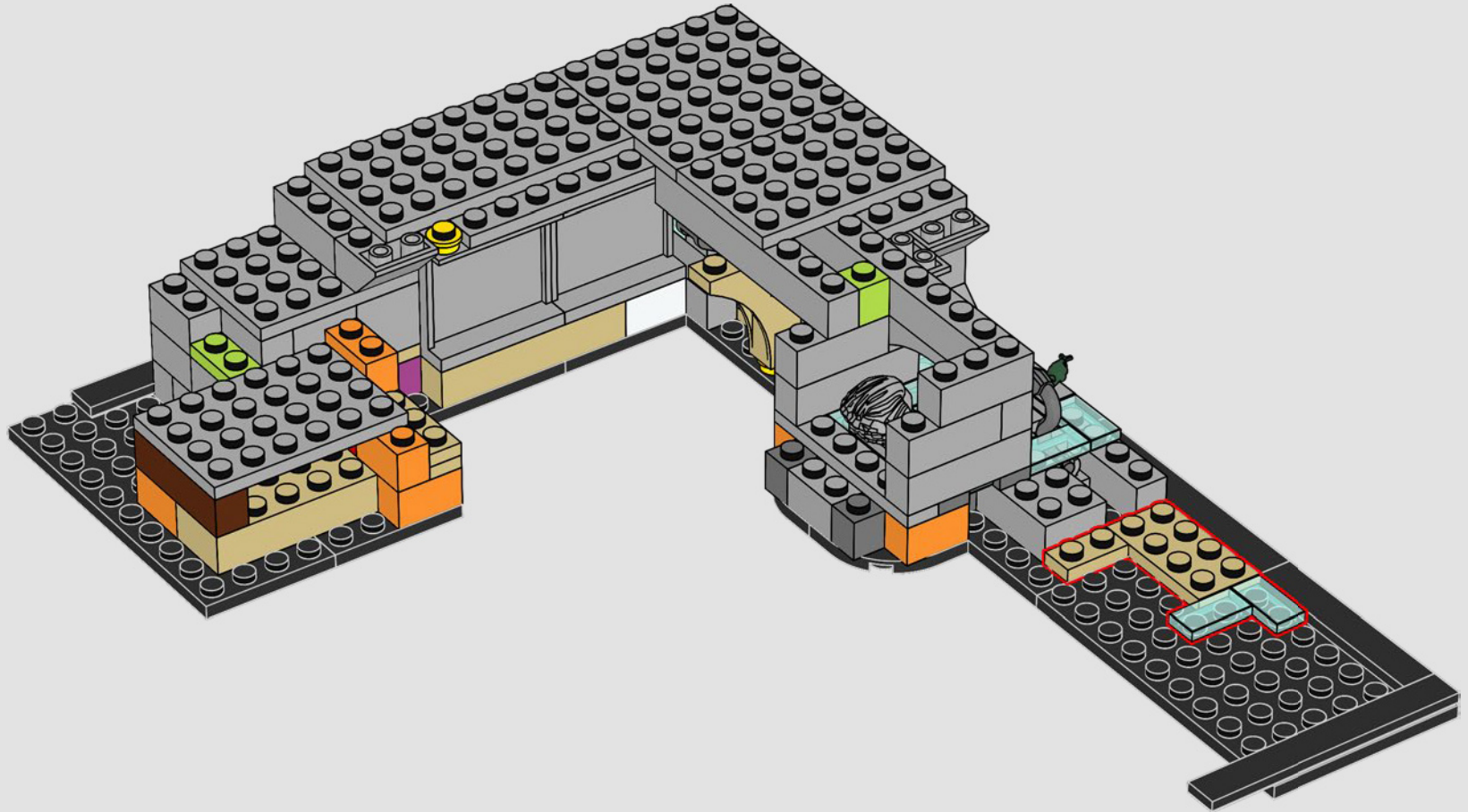

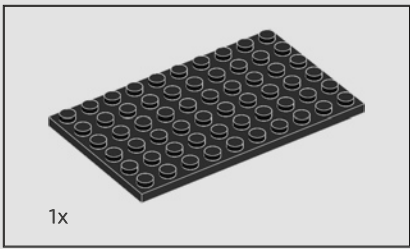

70

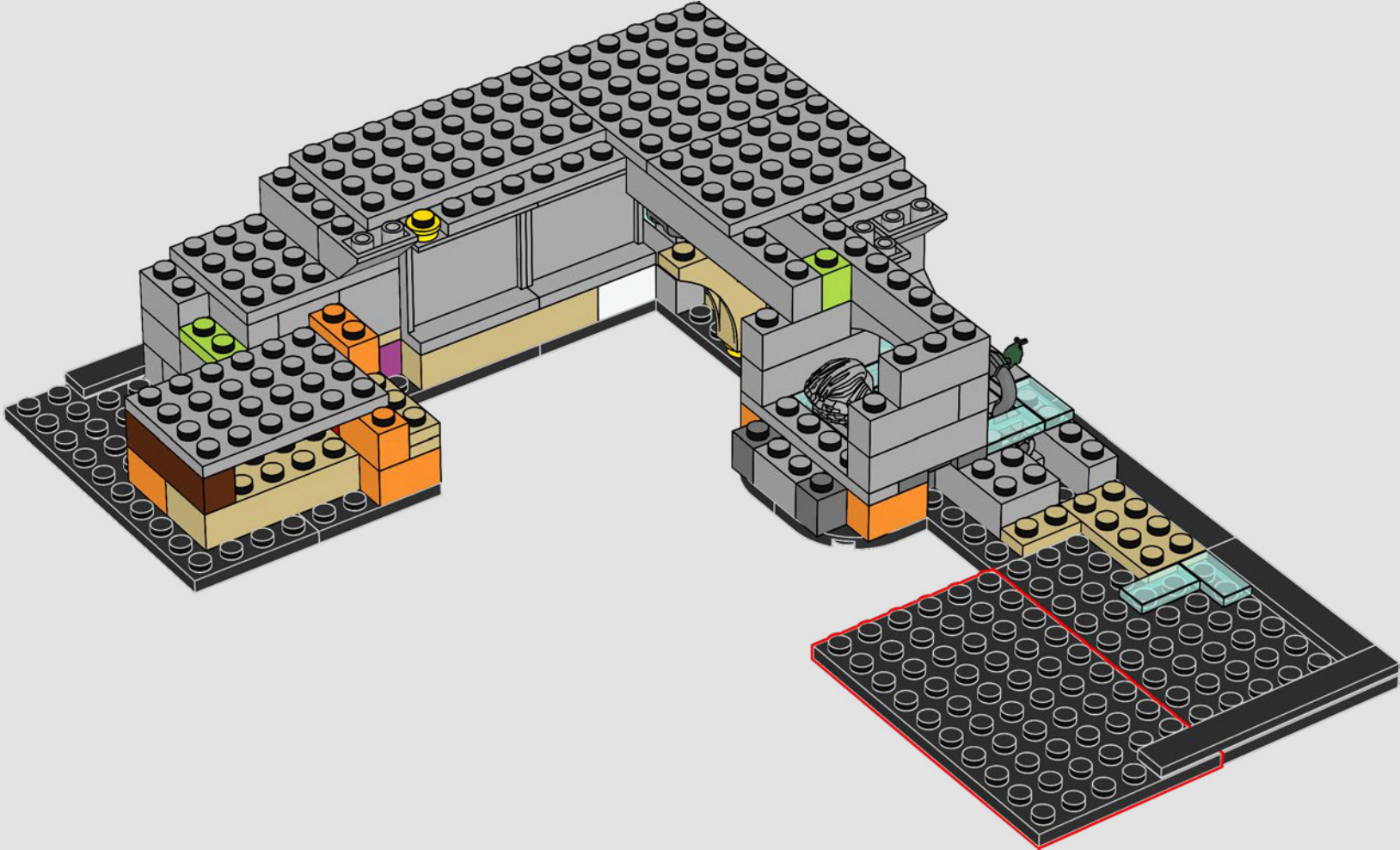

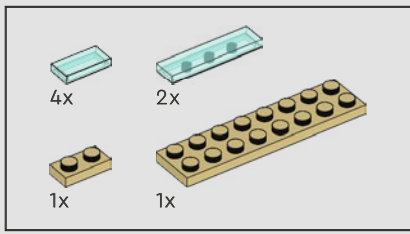

71

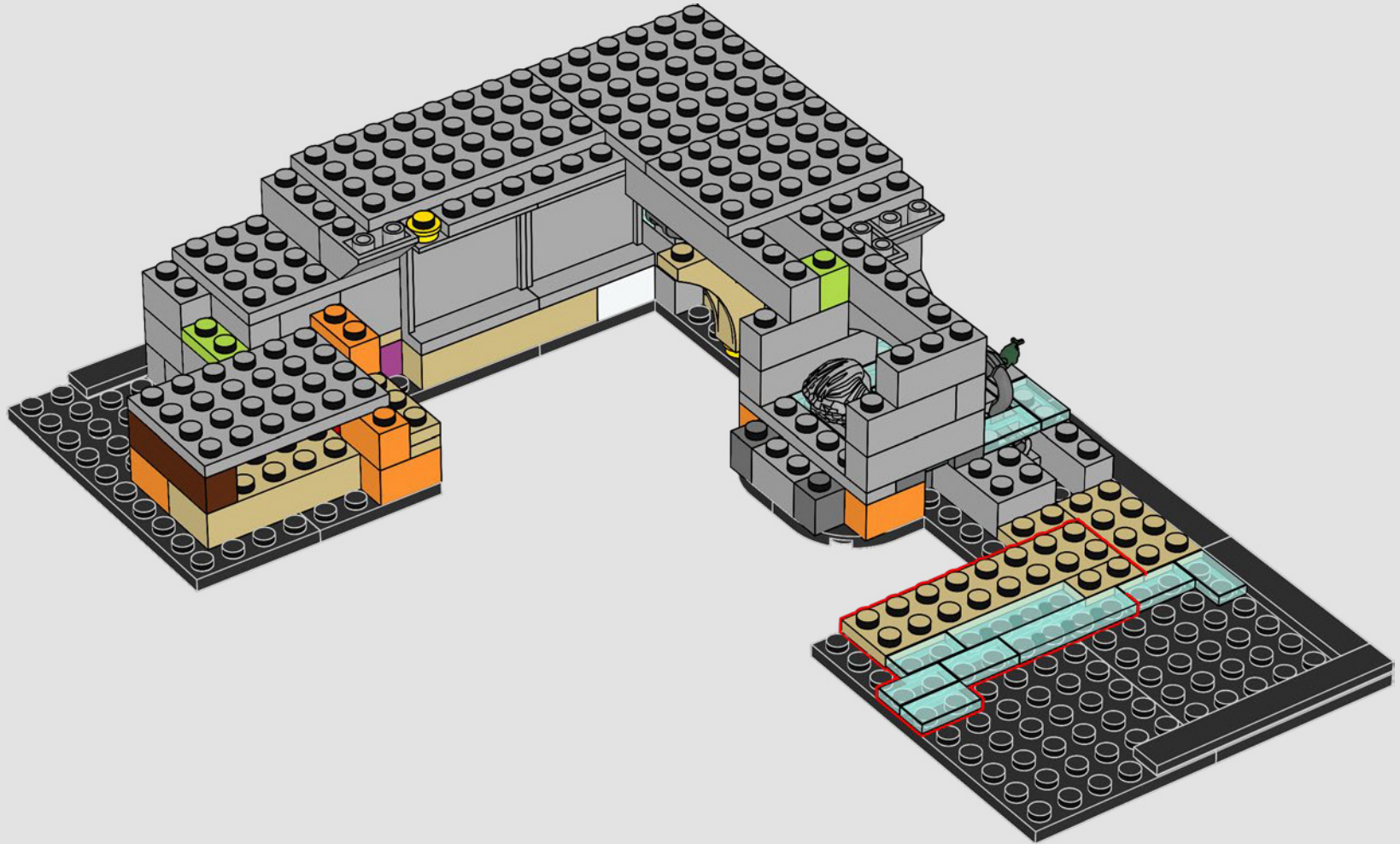

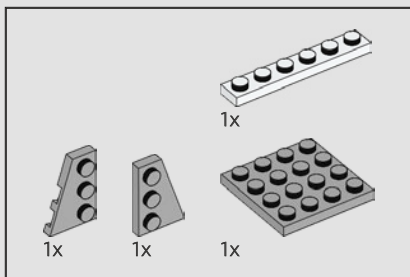

72

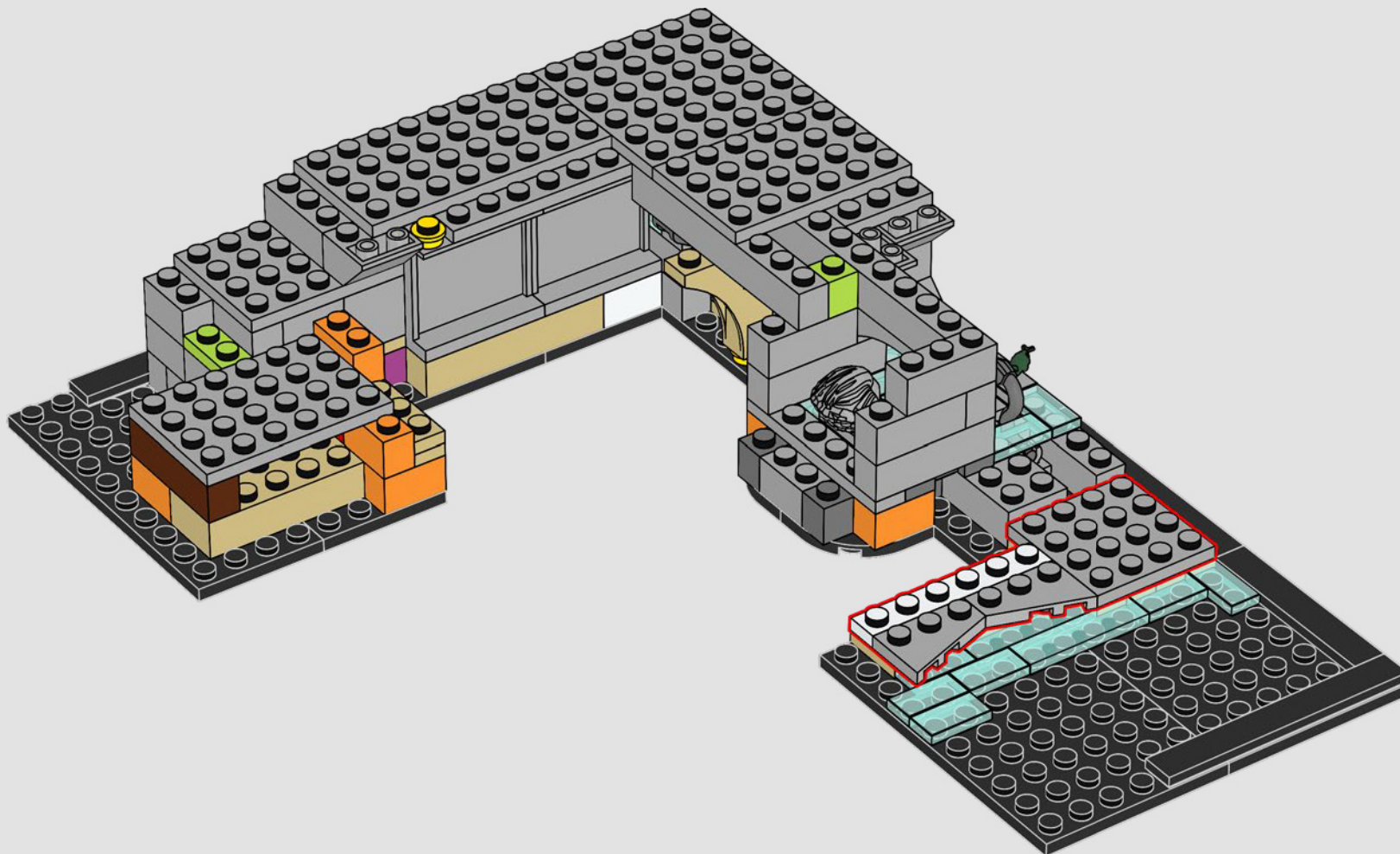

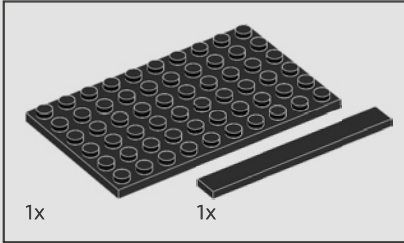
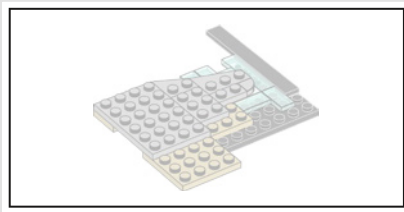

73

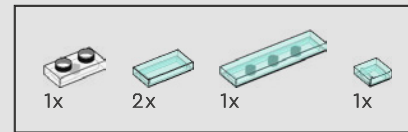
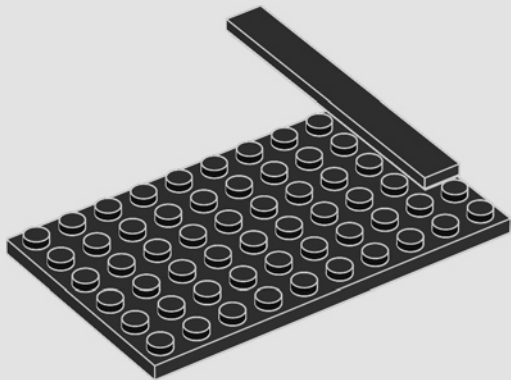

74

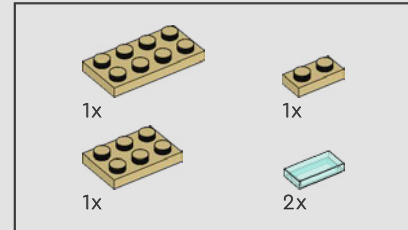
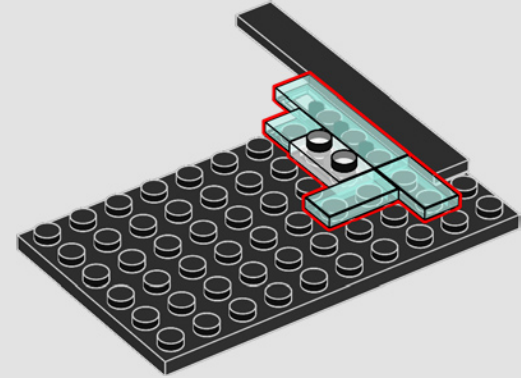

75

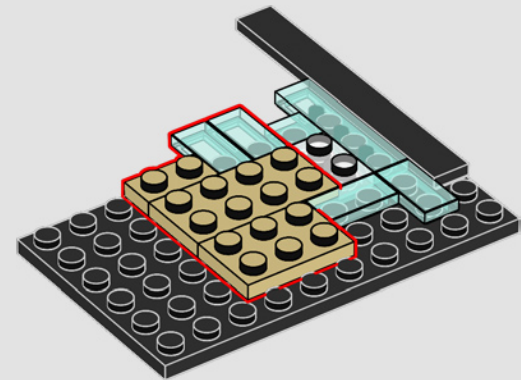

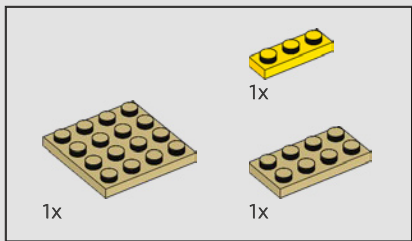

76

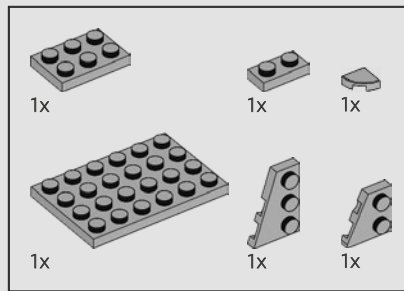
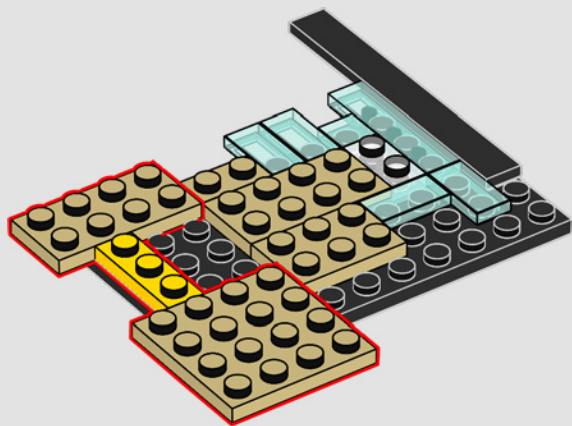

77

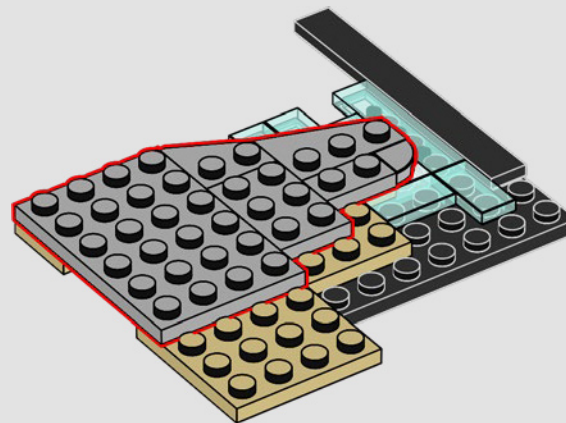



78

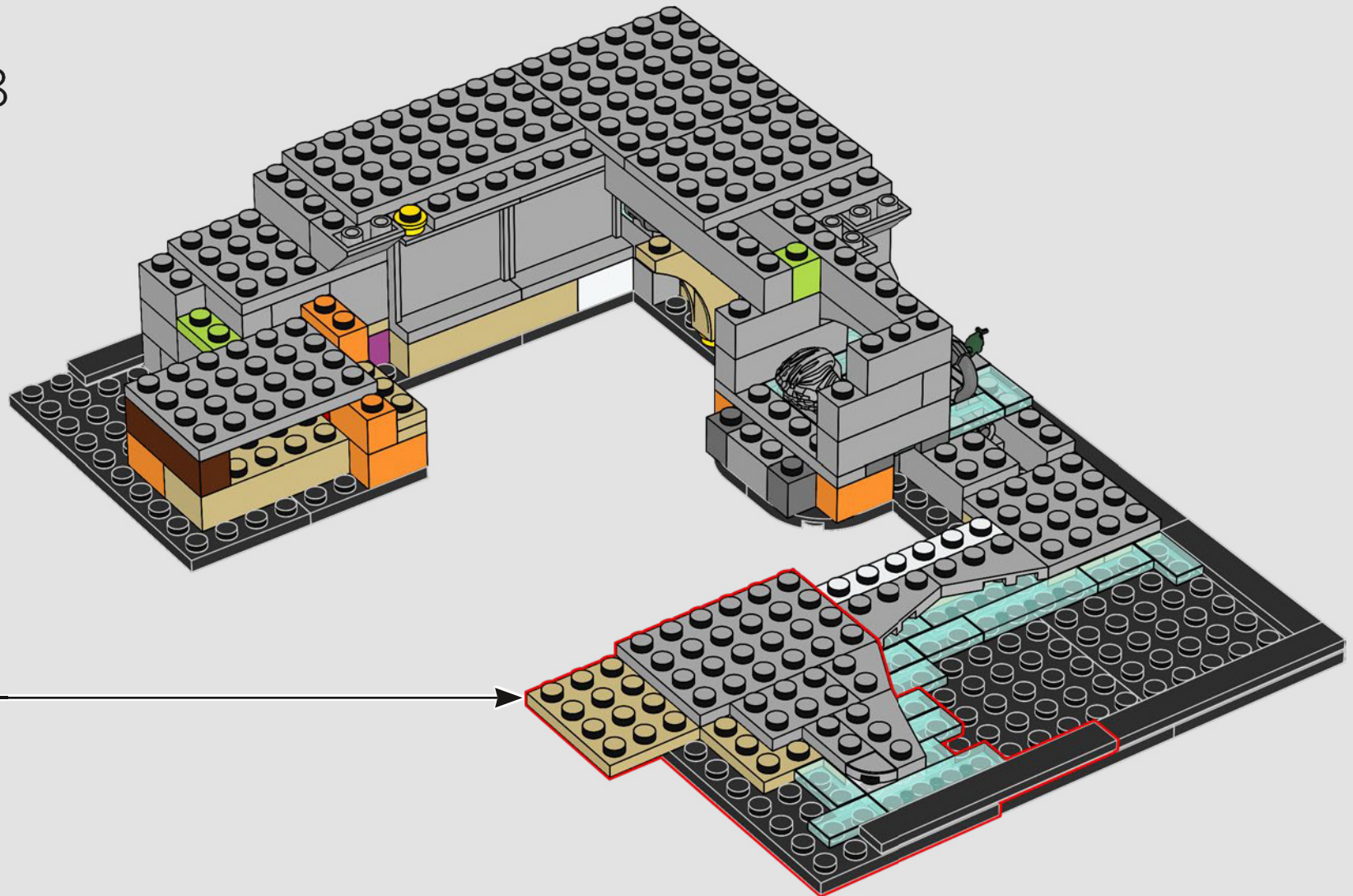

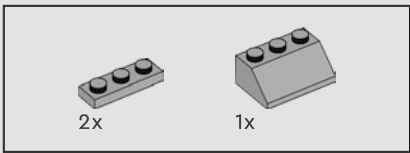

79

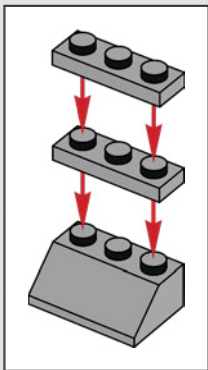
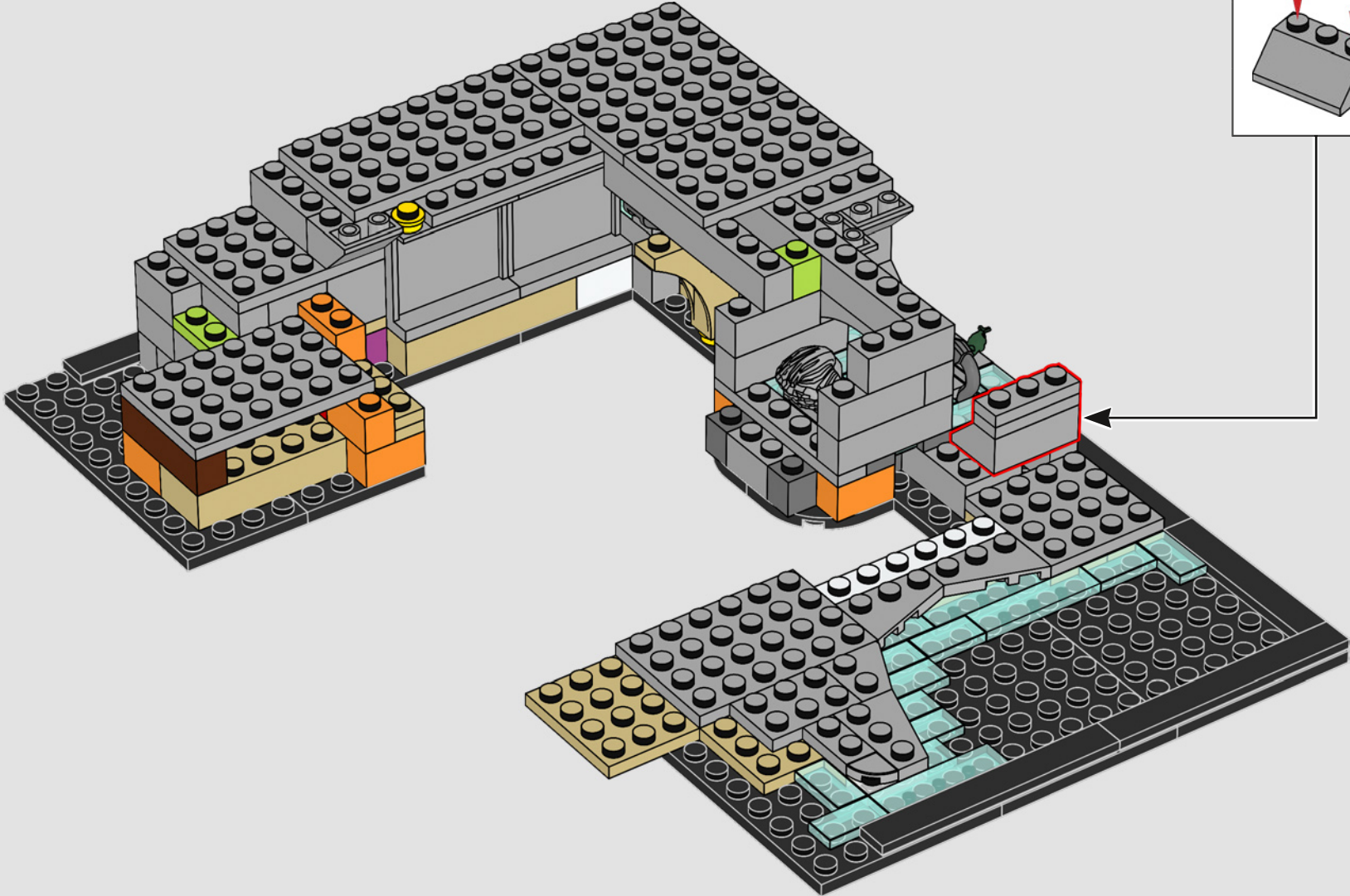

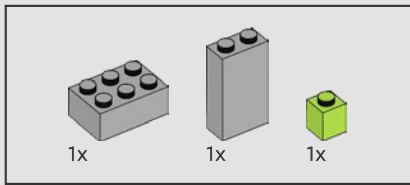

80

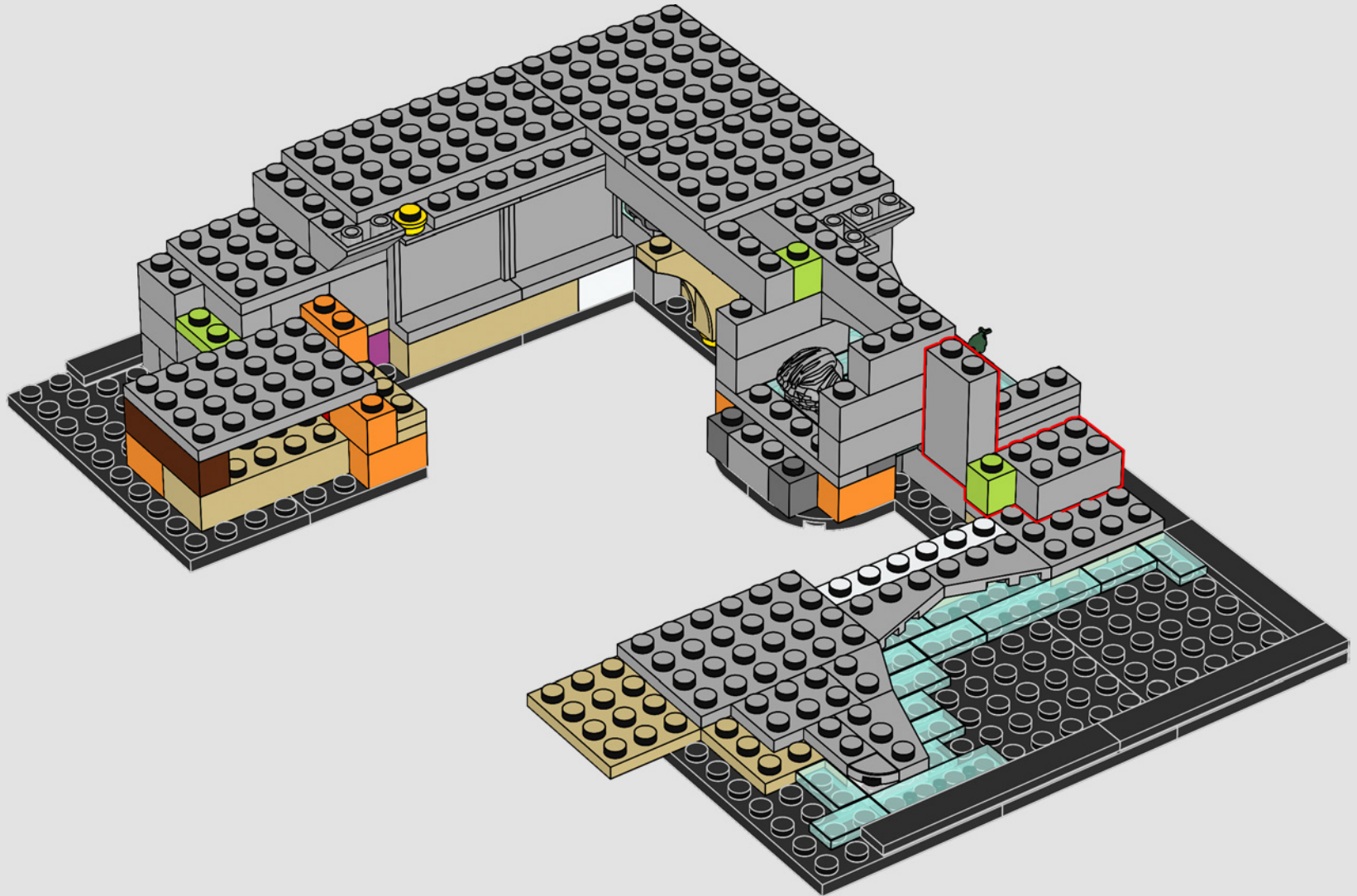

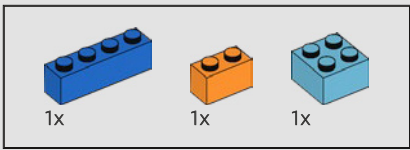

81

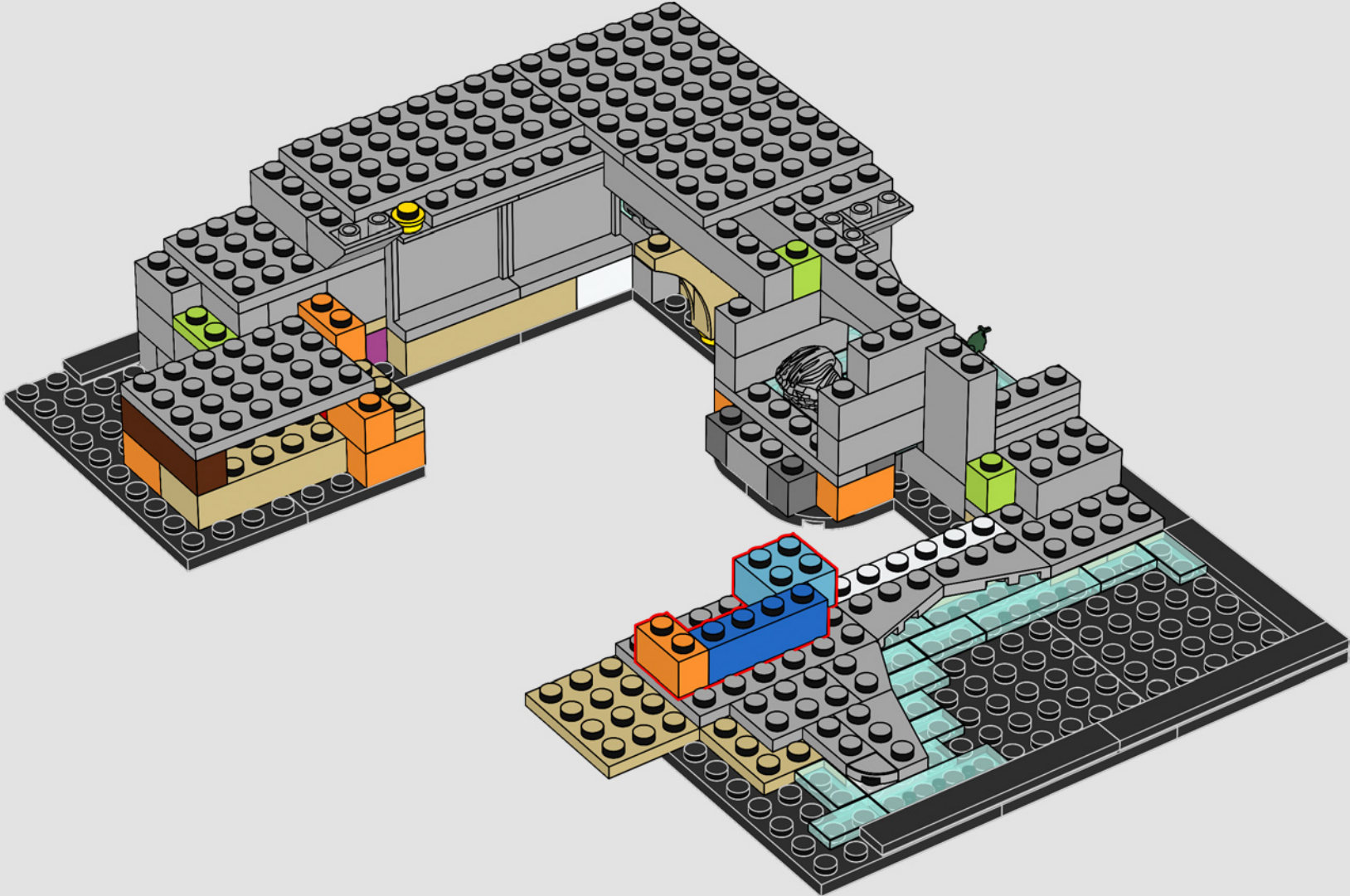

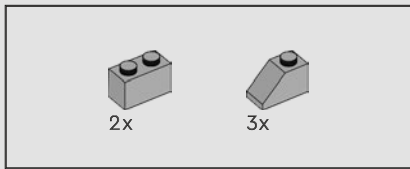

82

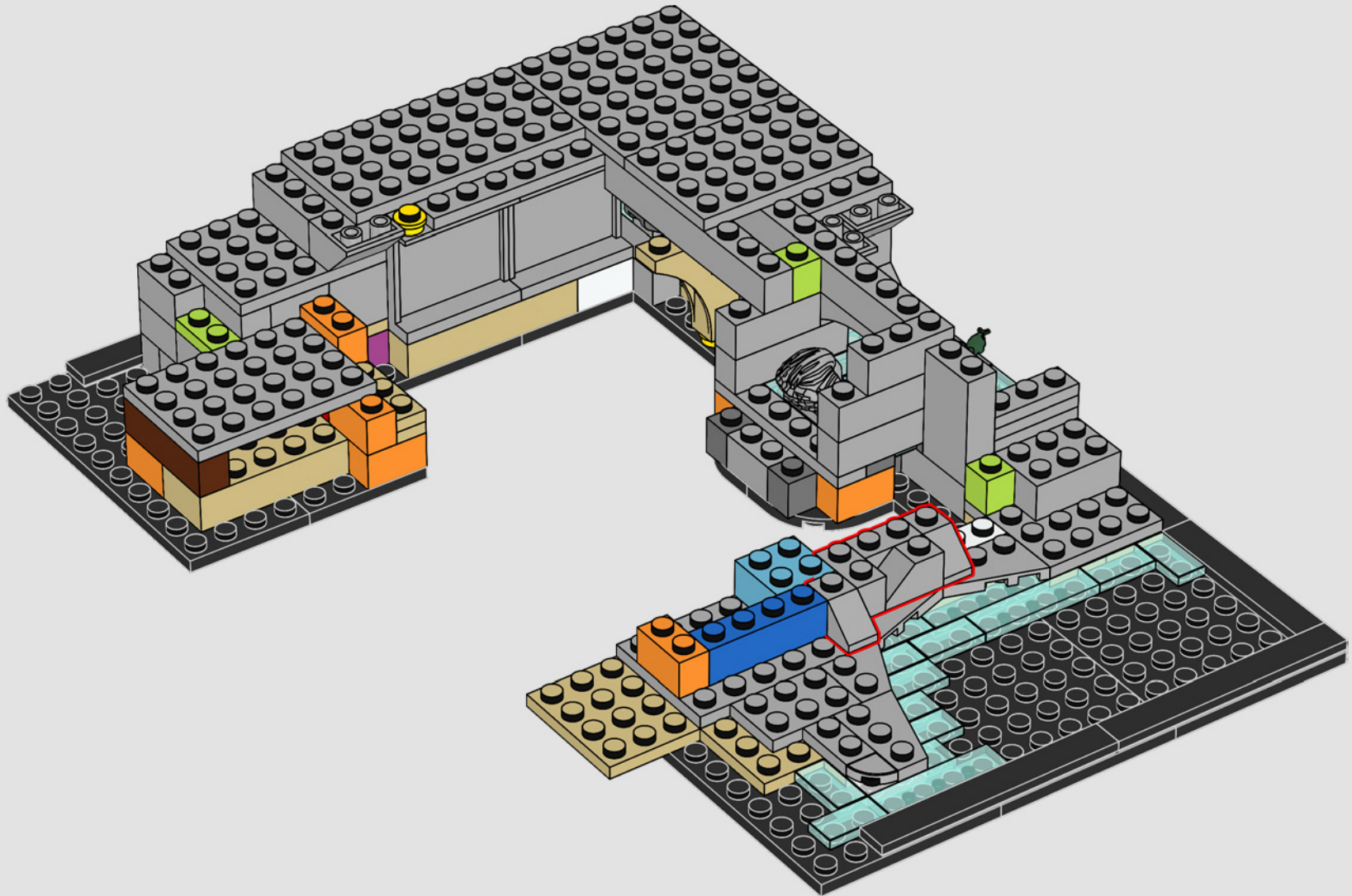

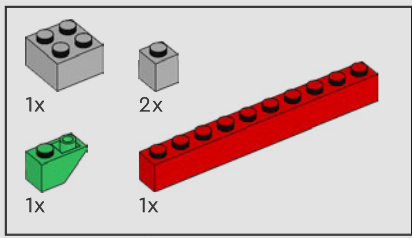

83

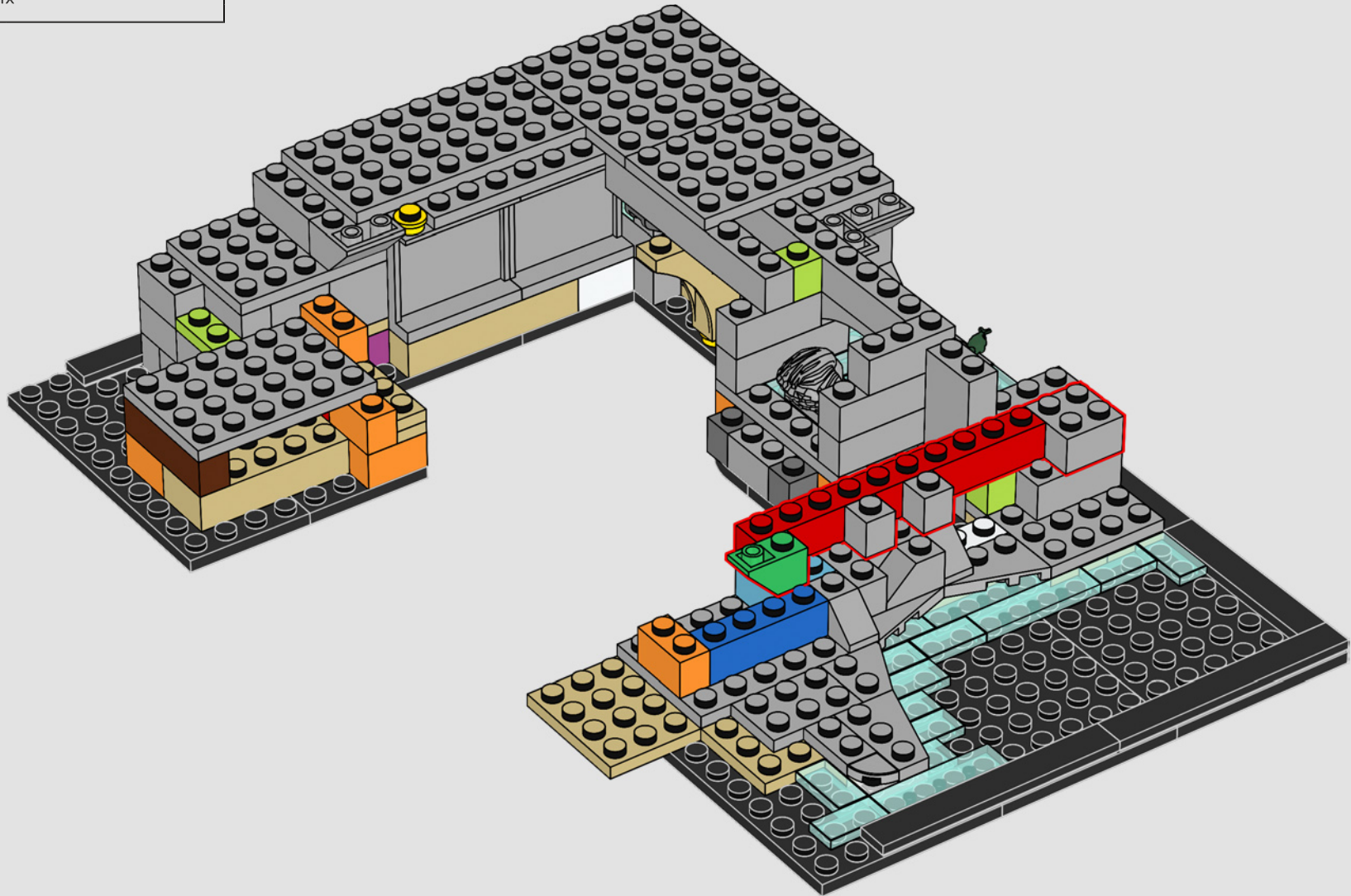

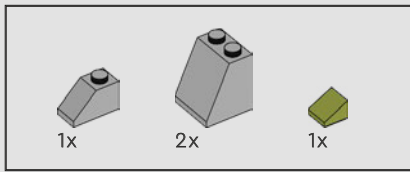

84

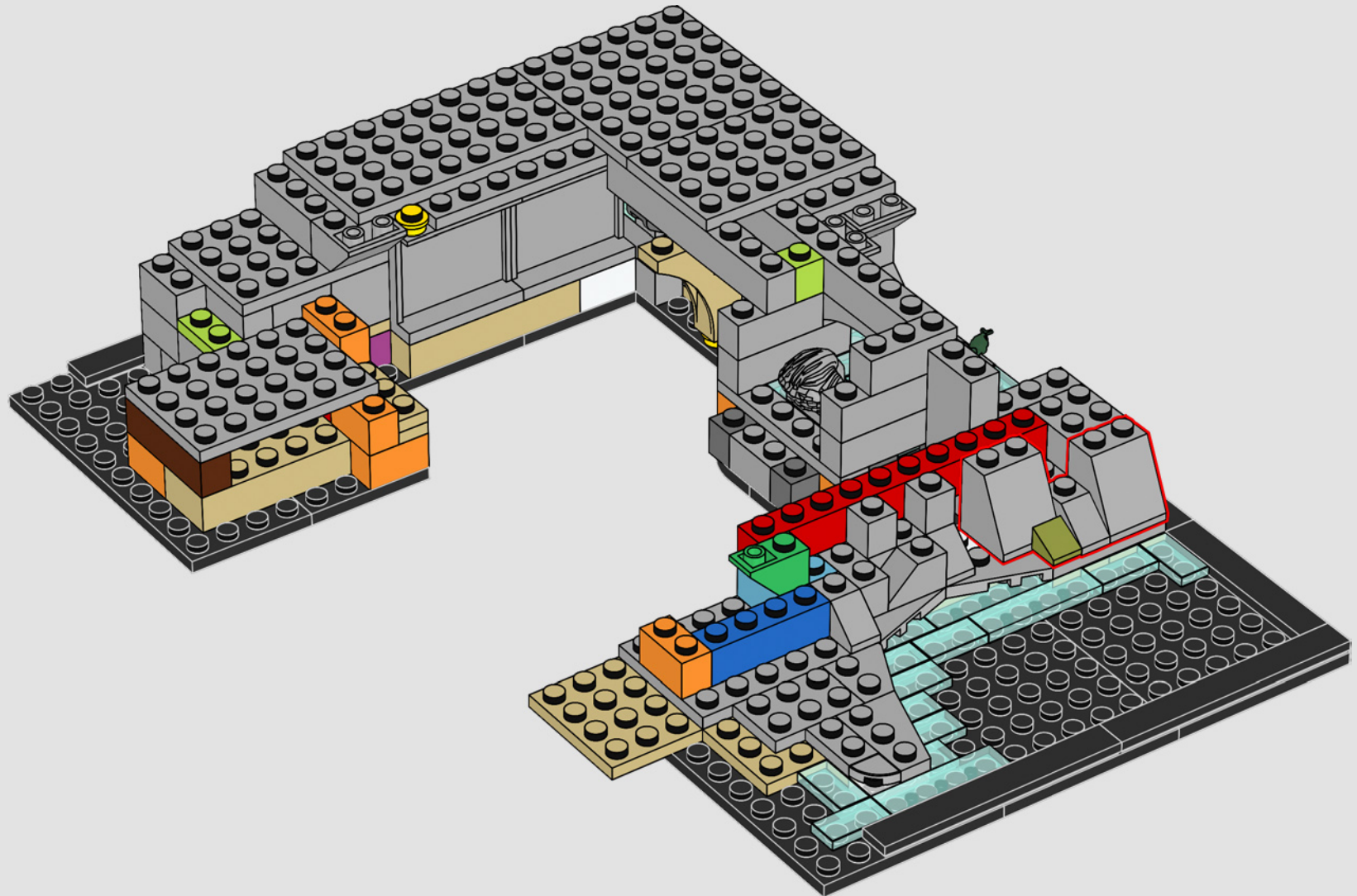

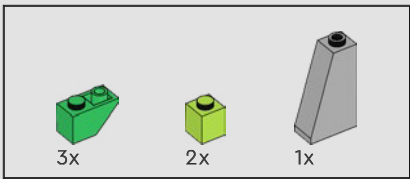

85

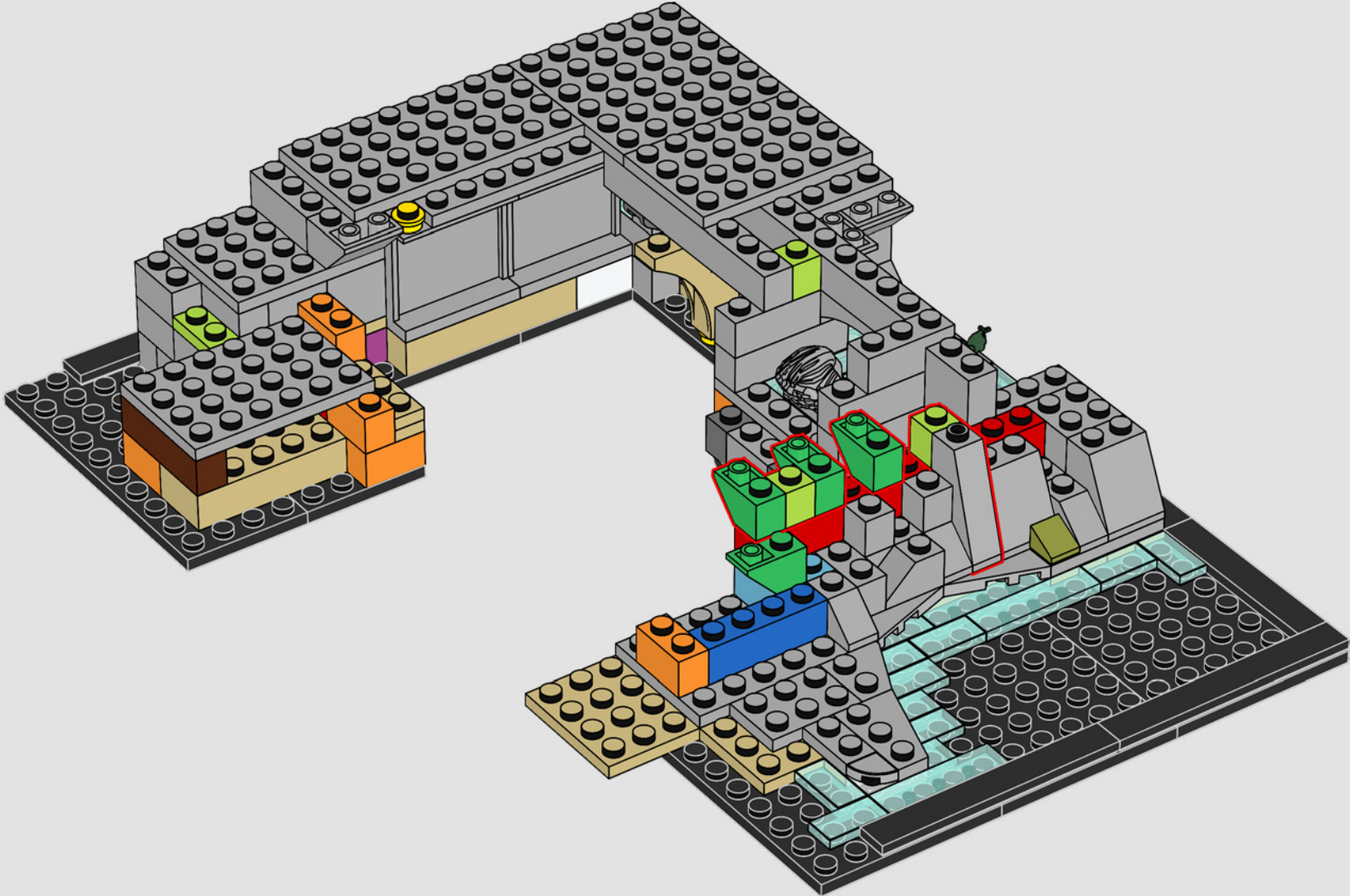



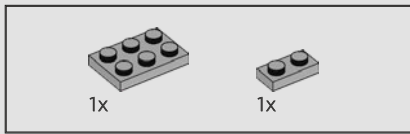

86

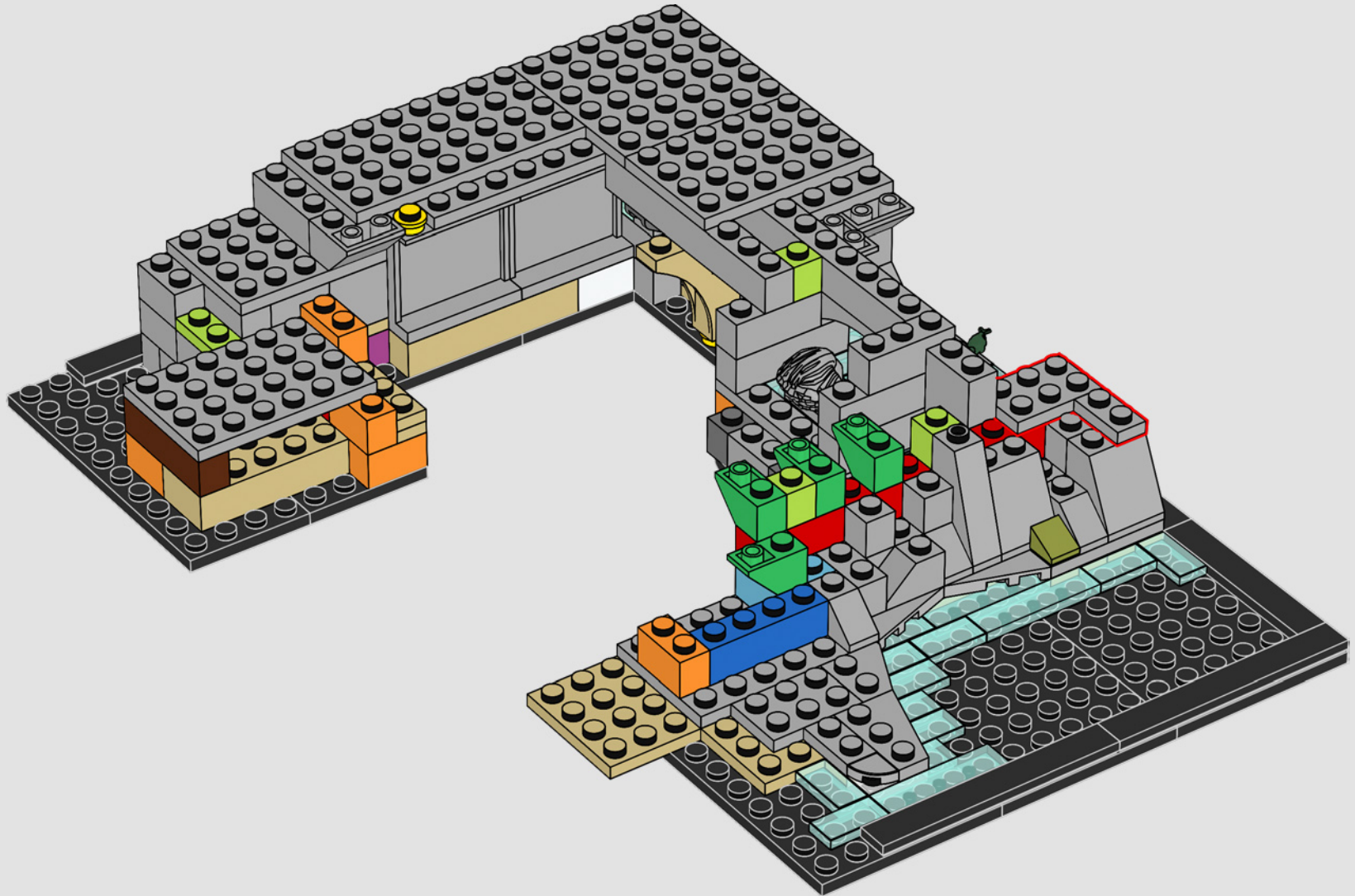

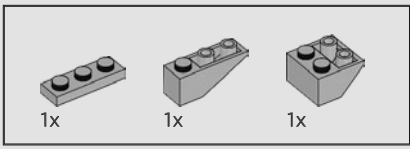

87

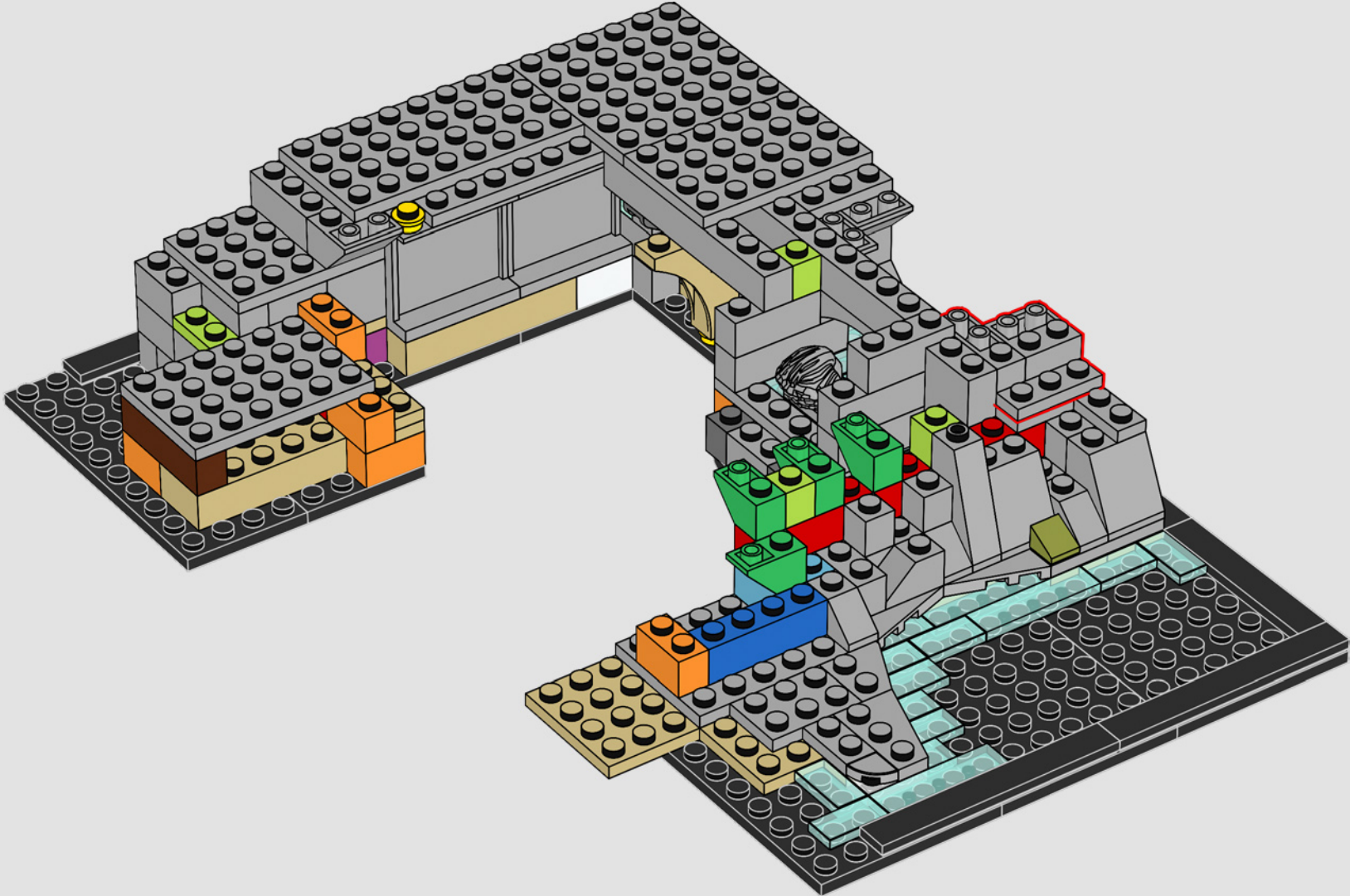

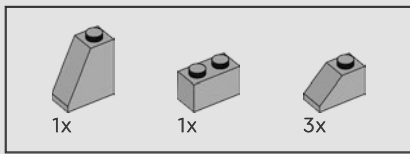

88

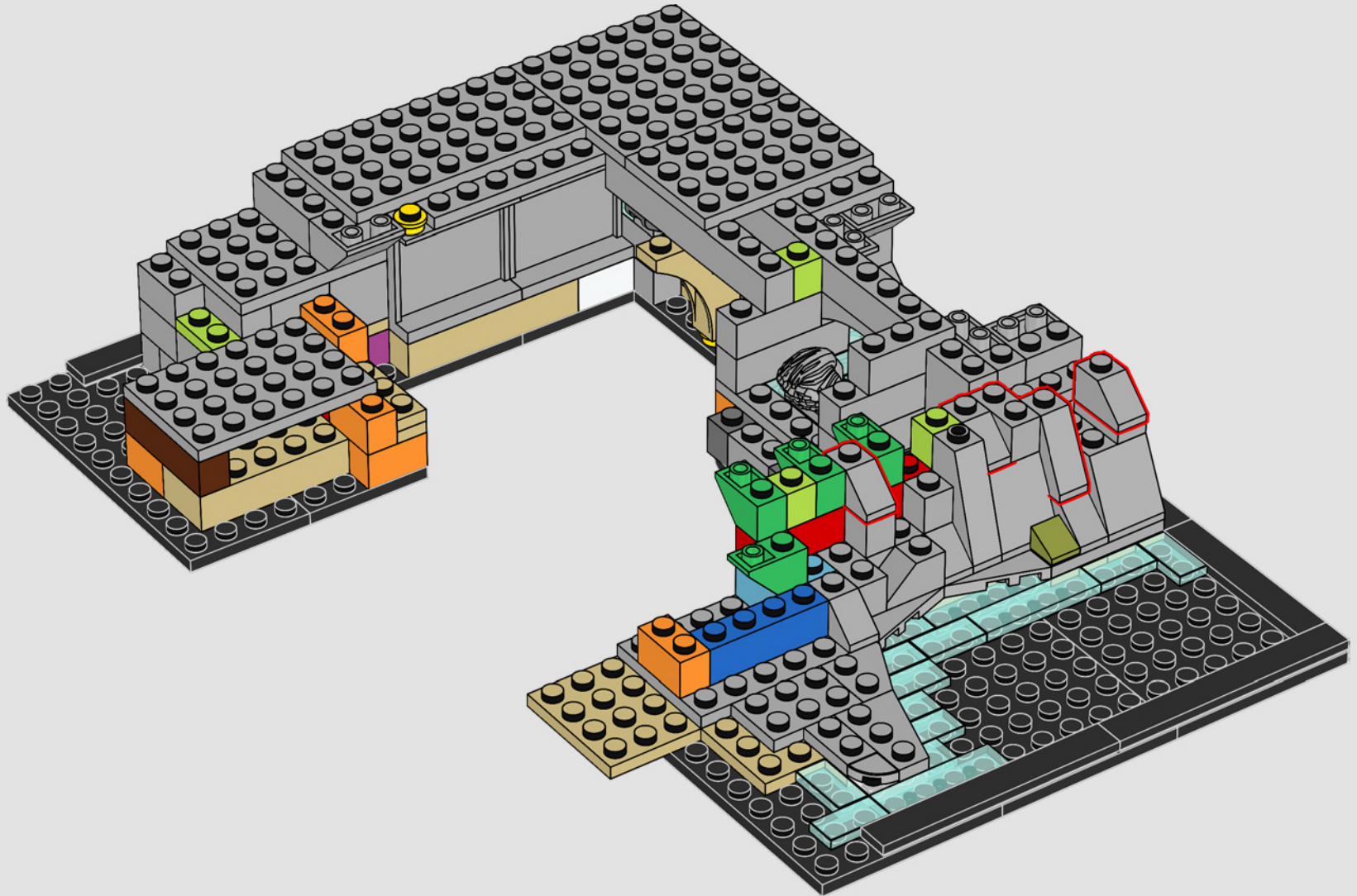

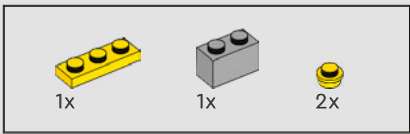

89

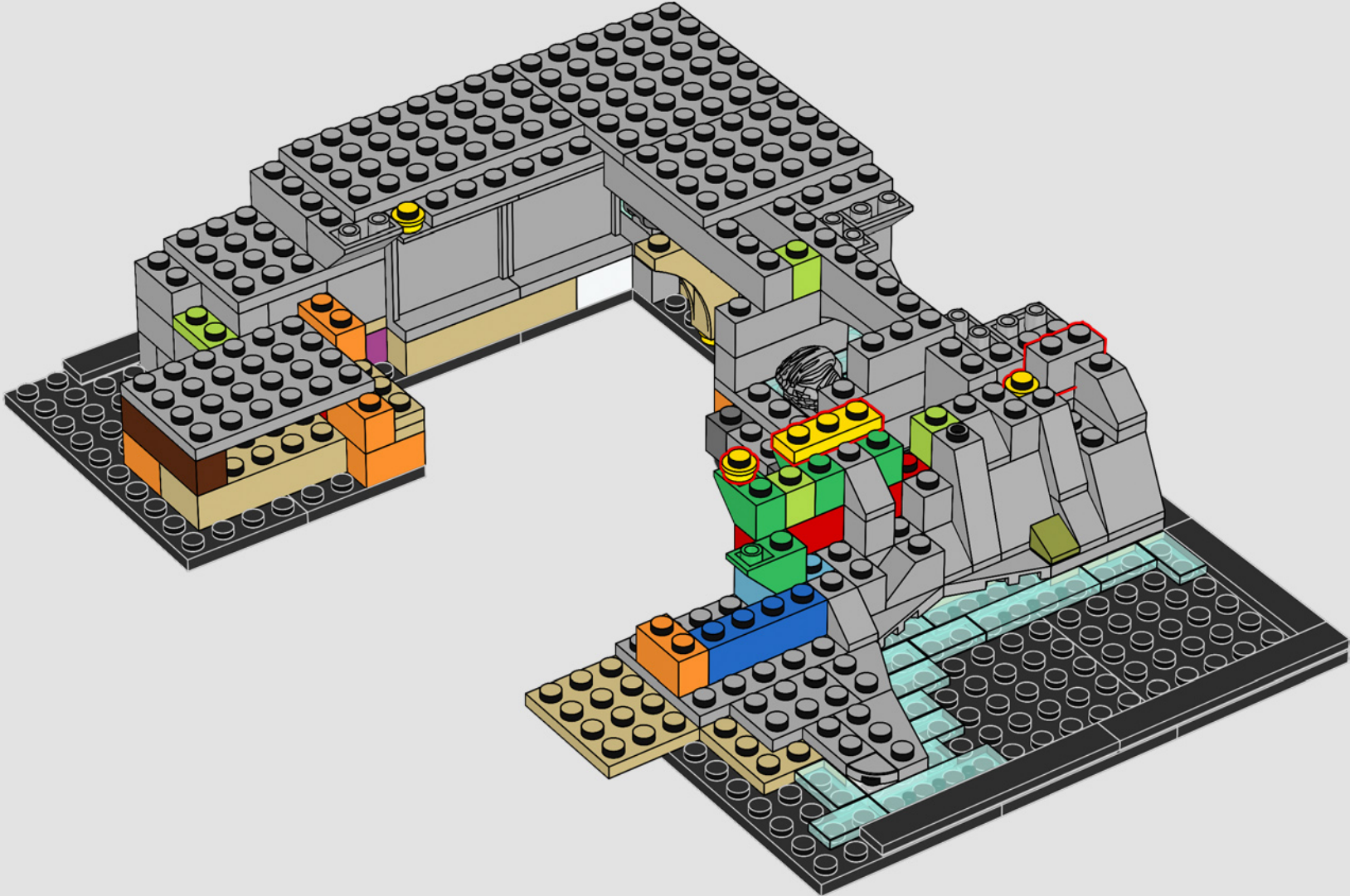

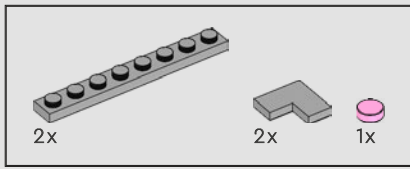

90

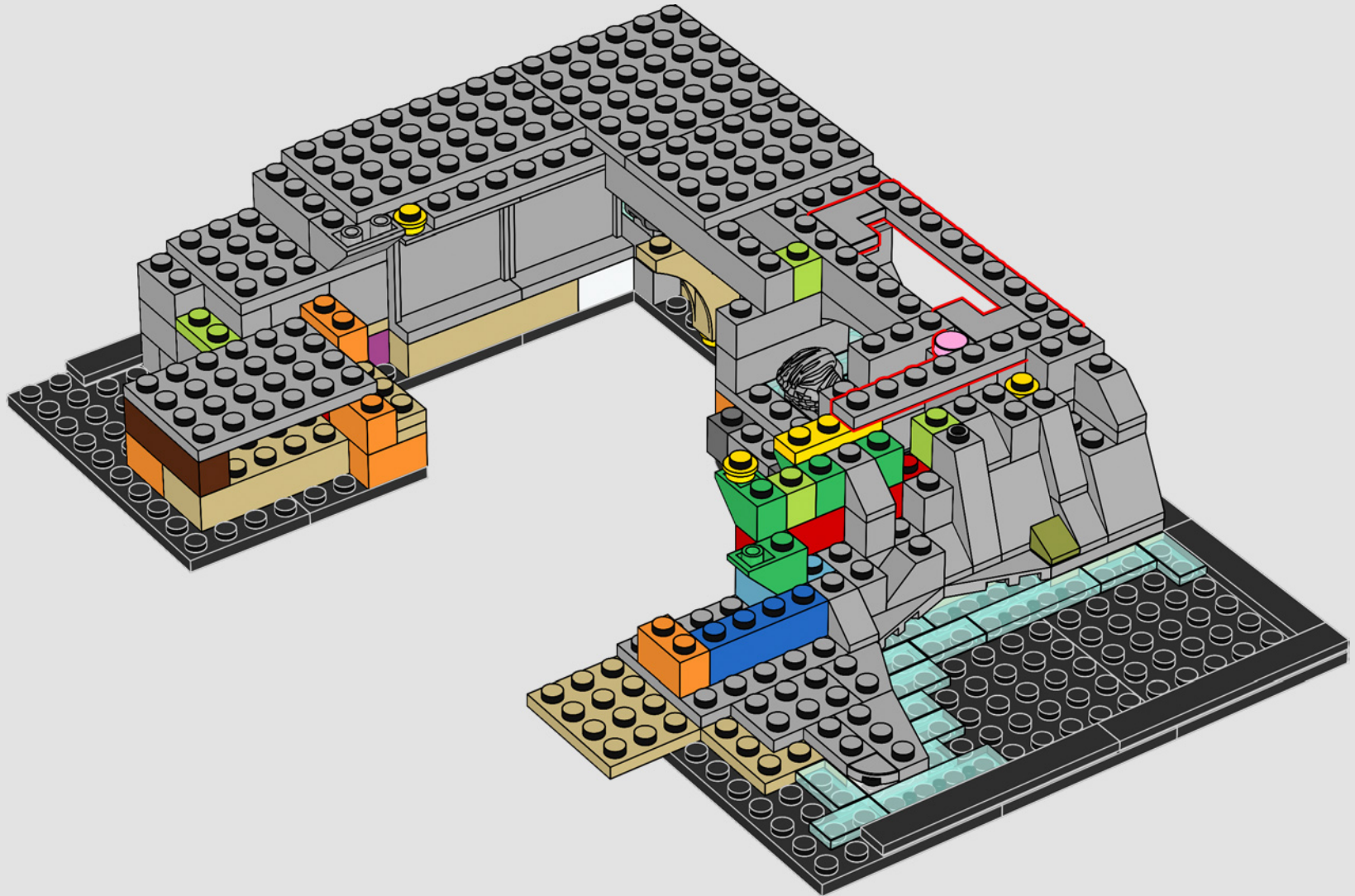

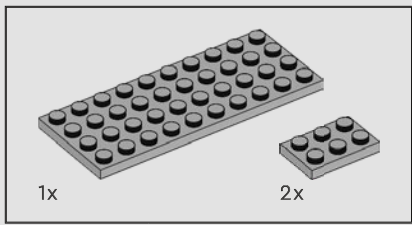

91

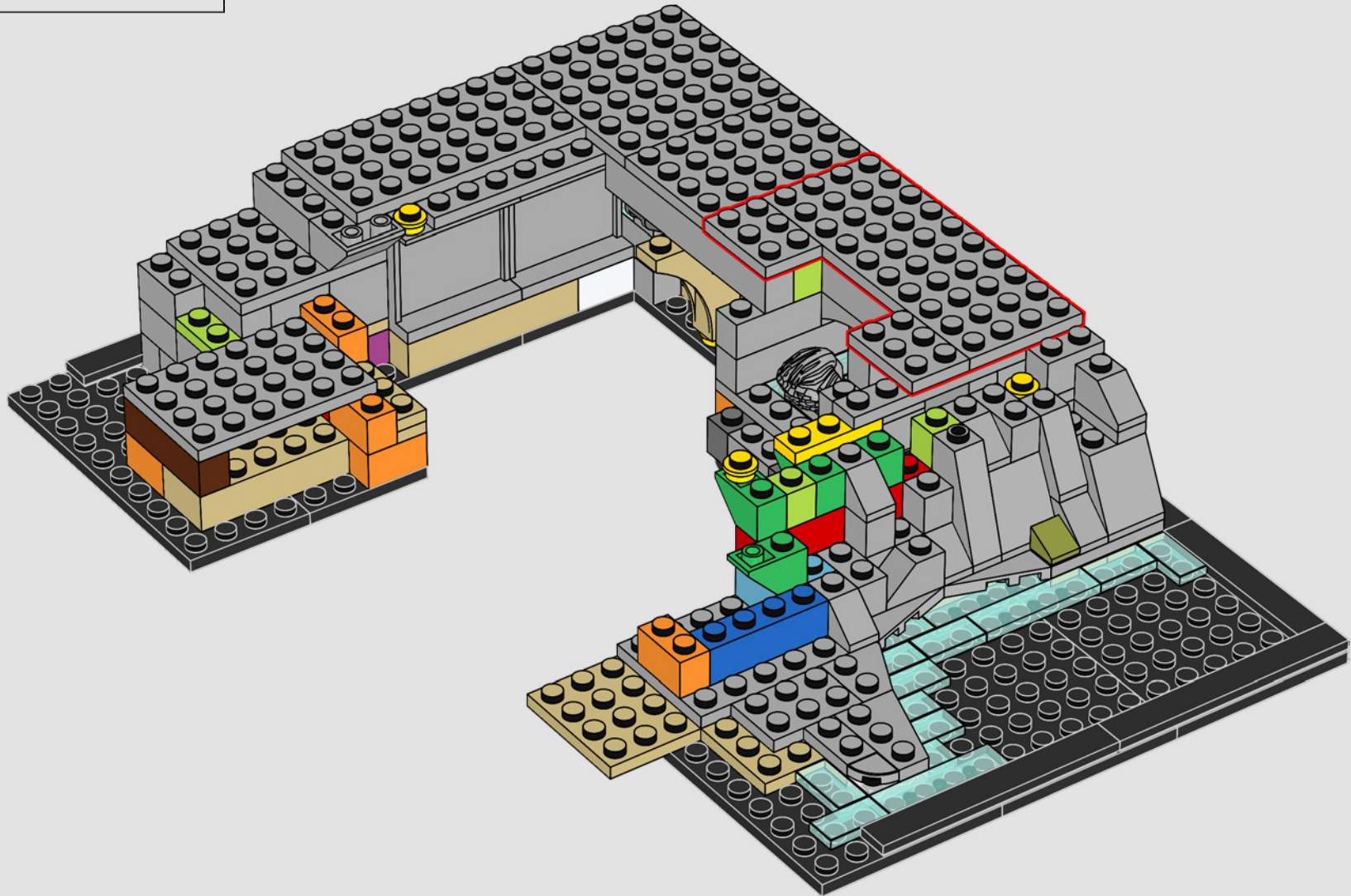

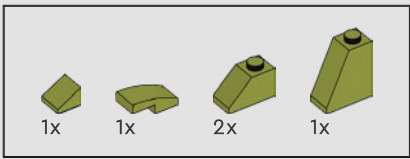

92

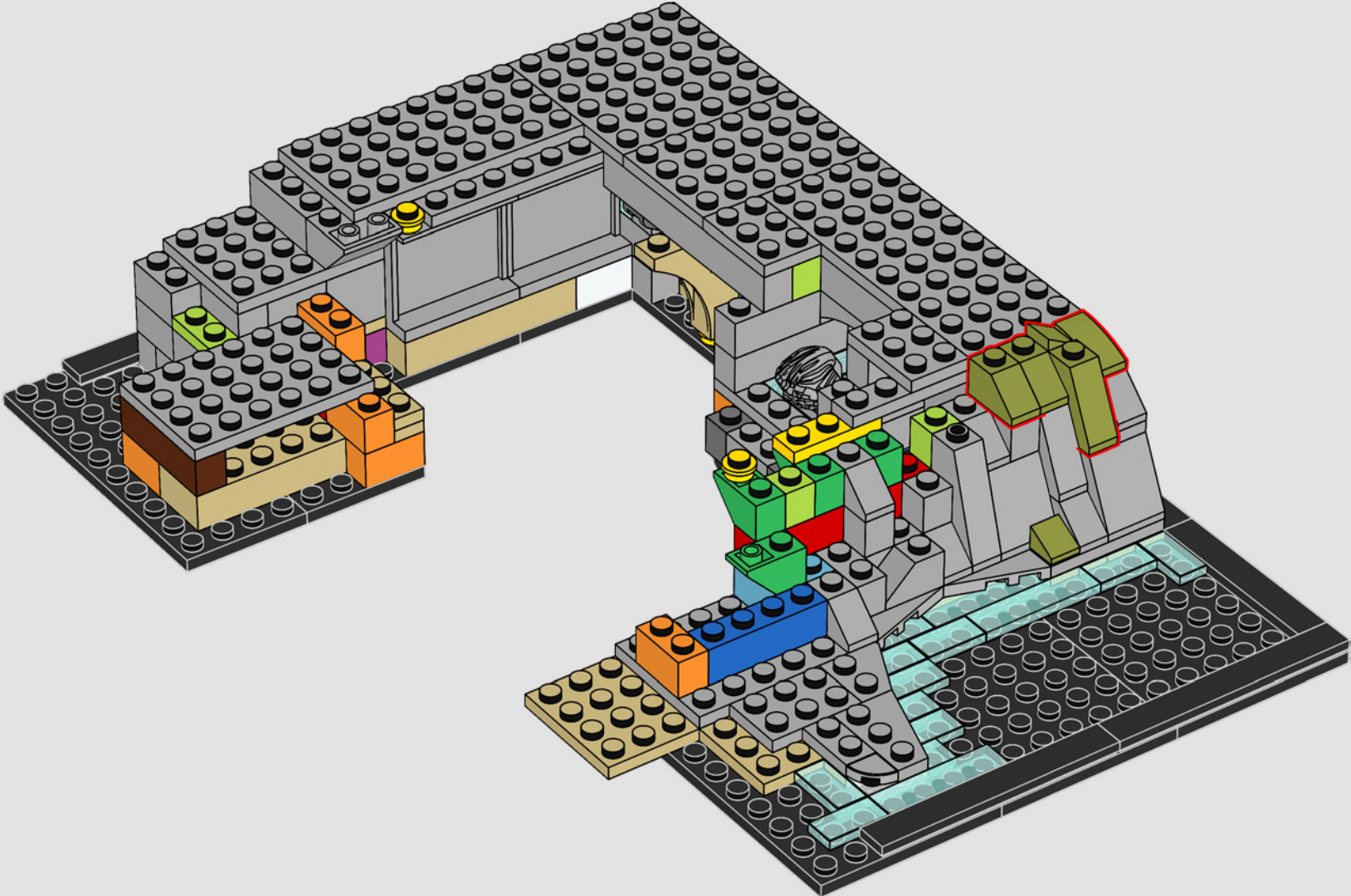

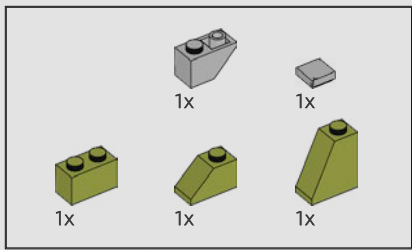

93

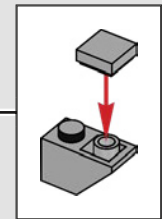
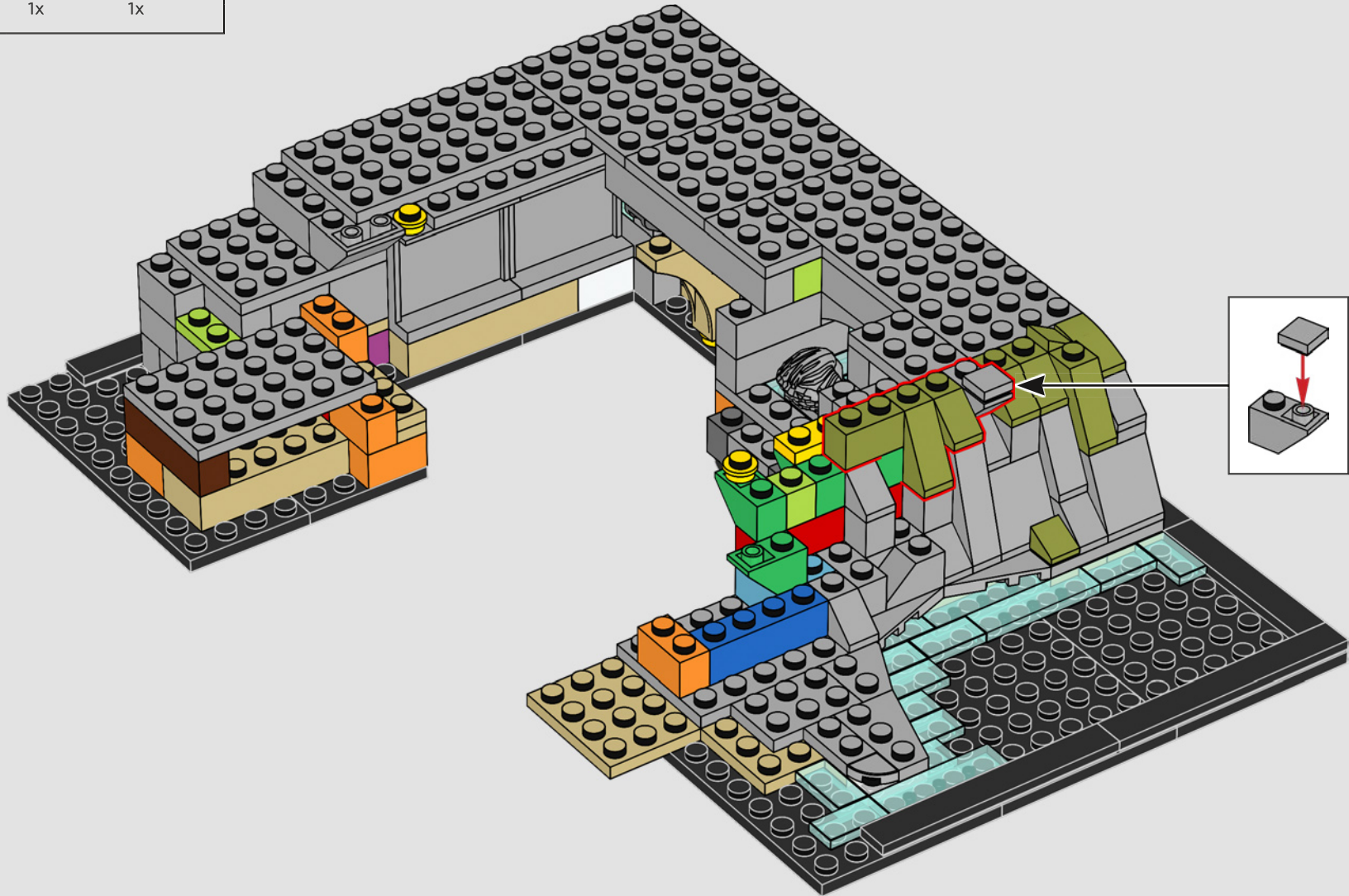



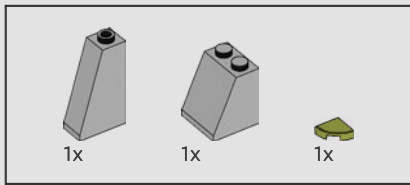

94

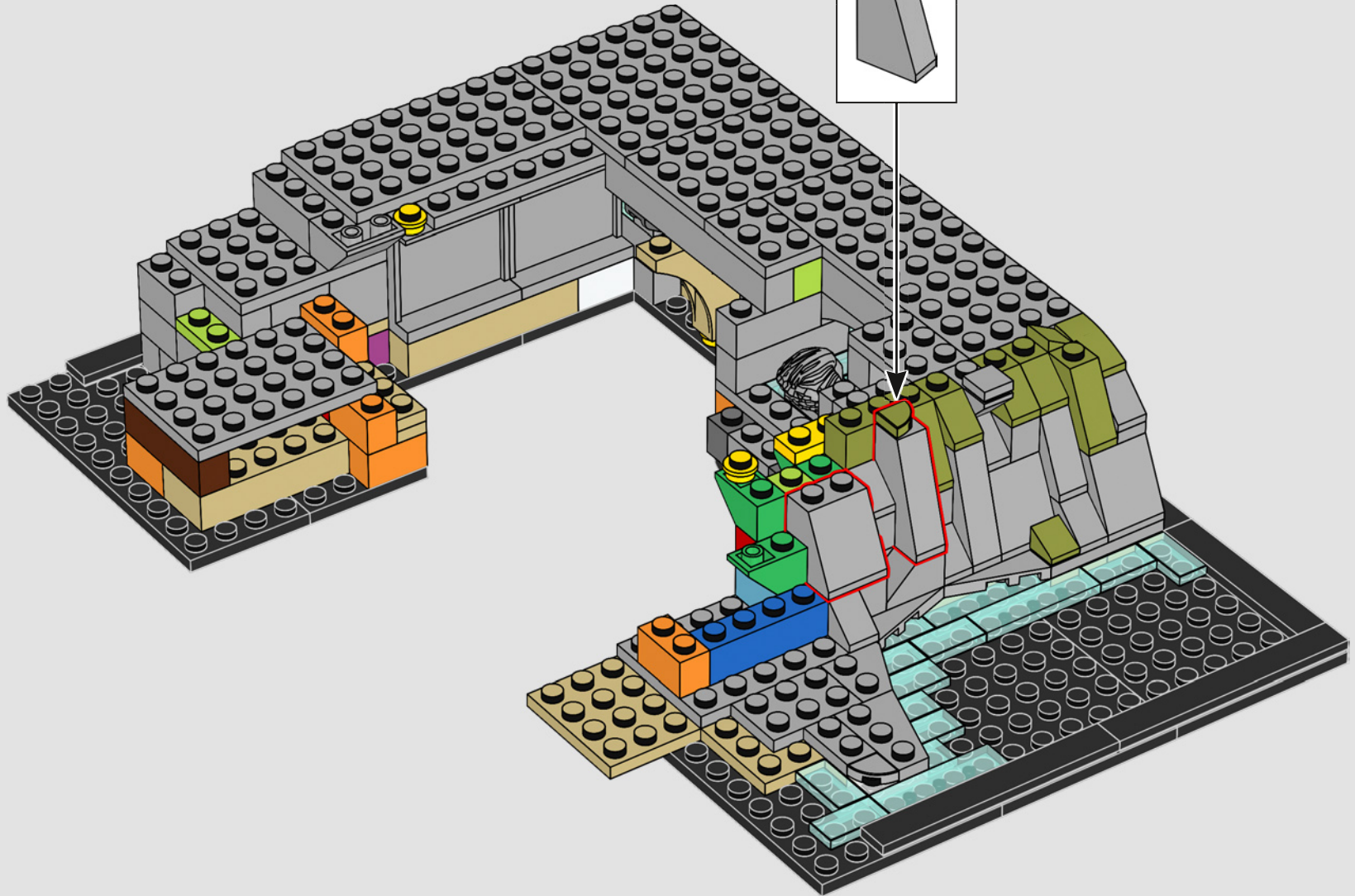
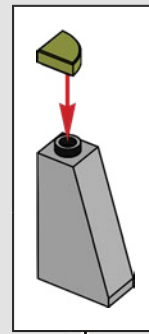

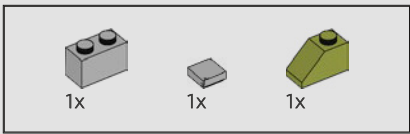

95

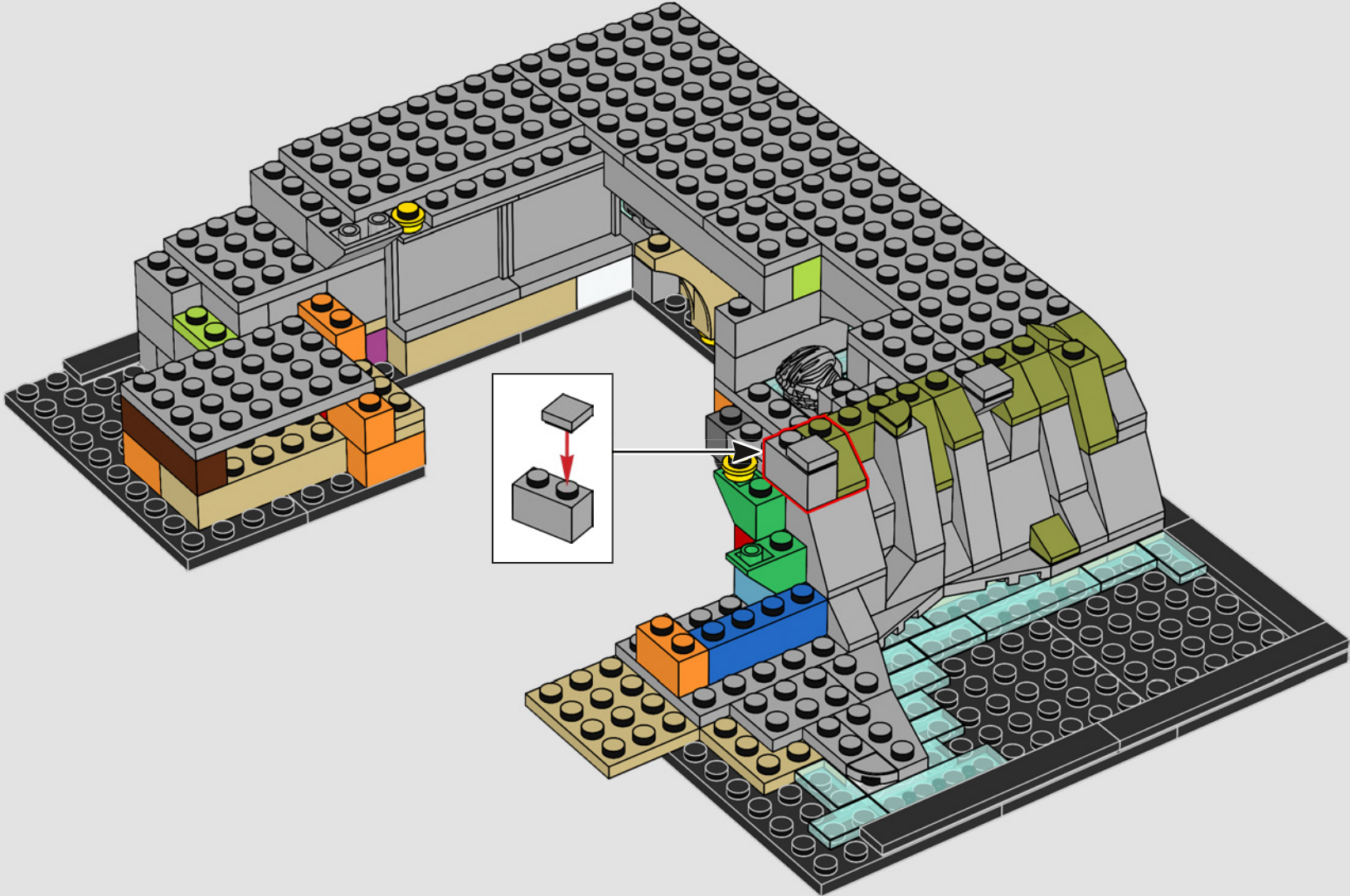

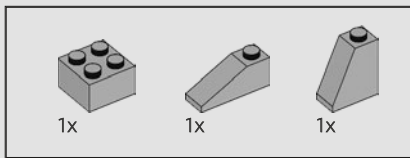

96

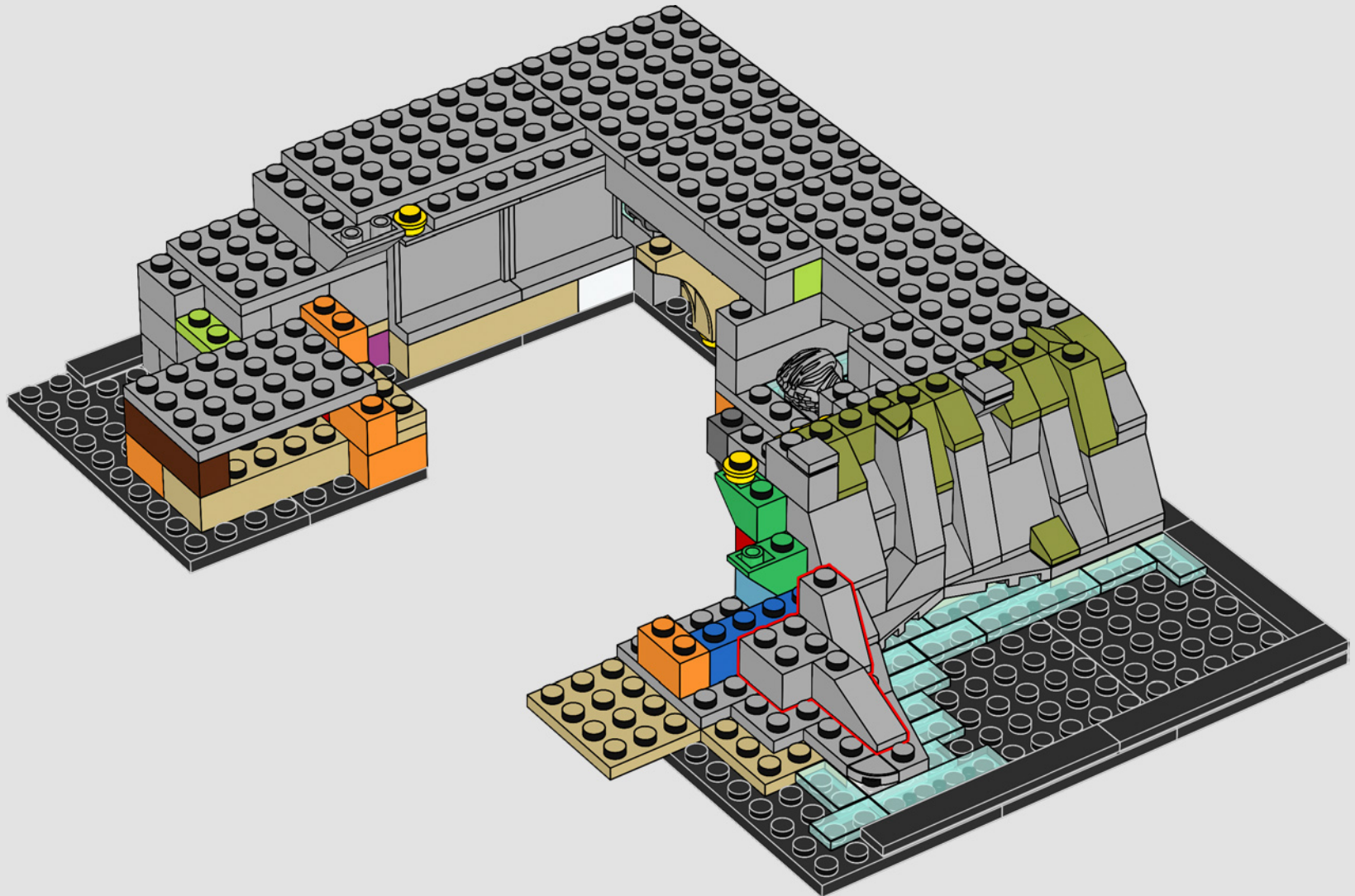

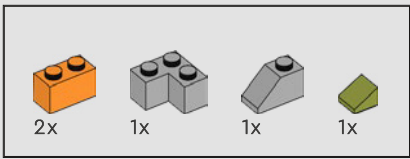

97

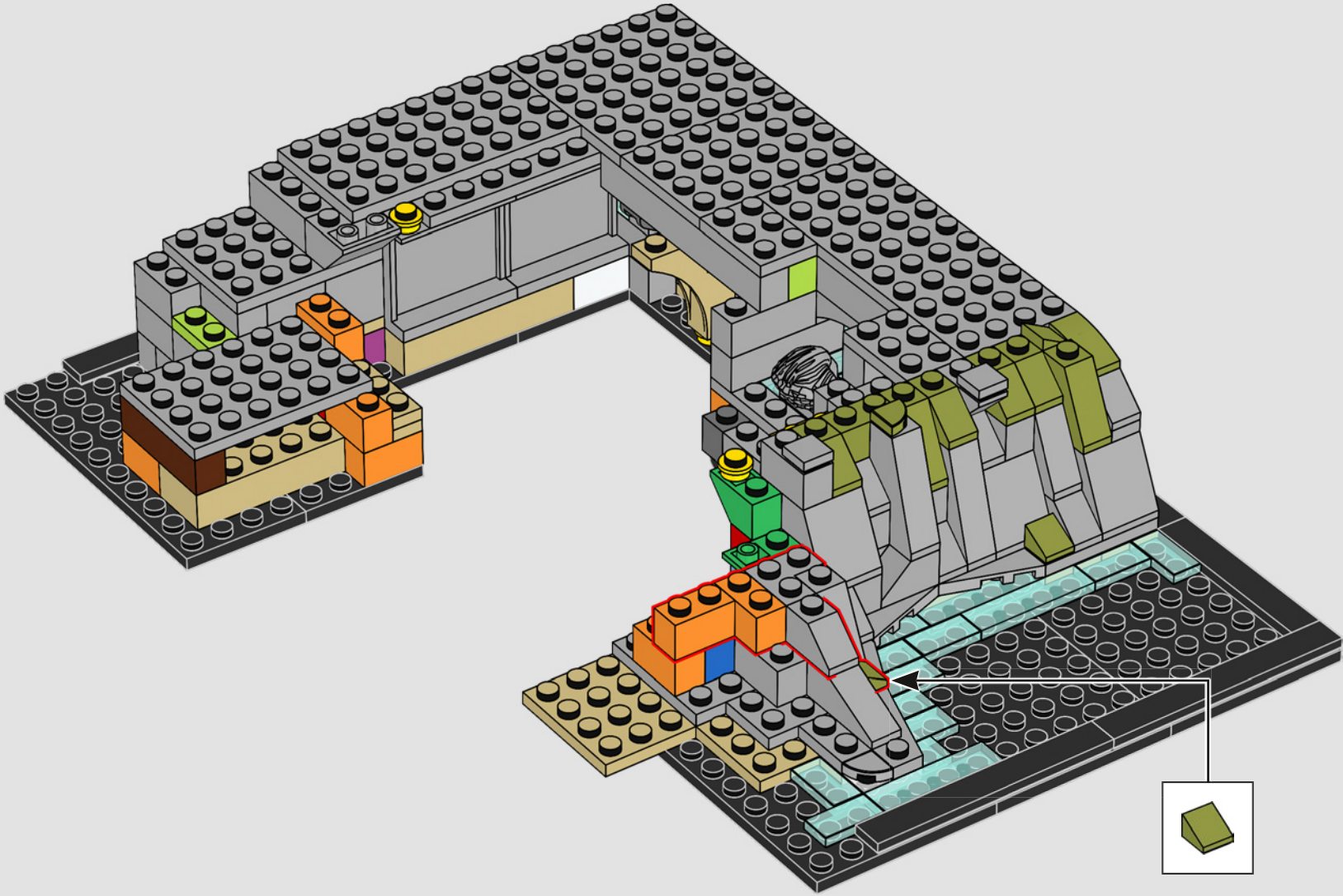

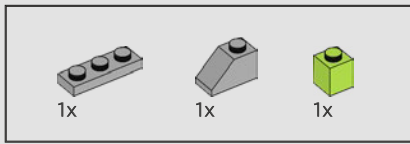

98

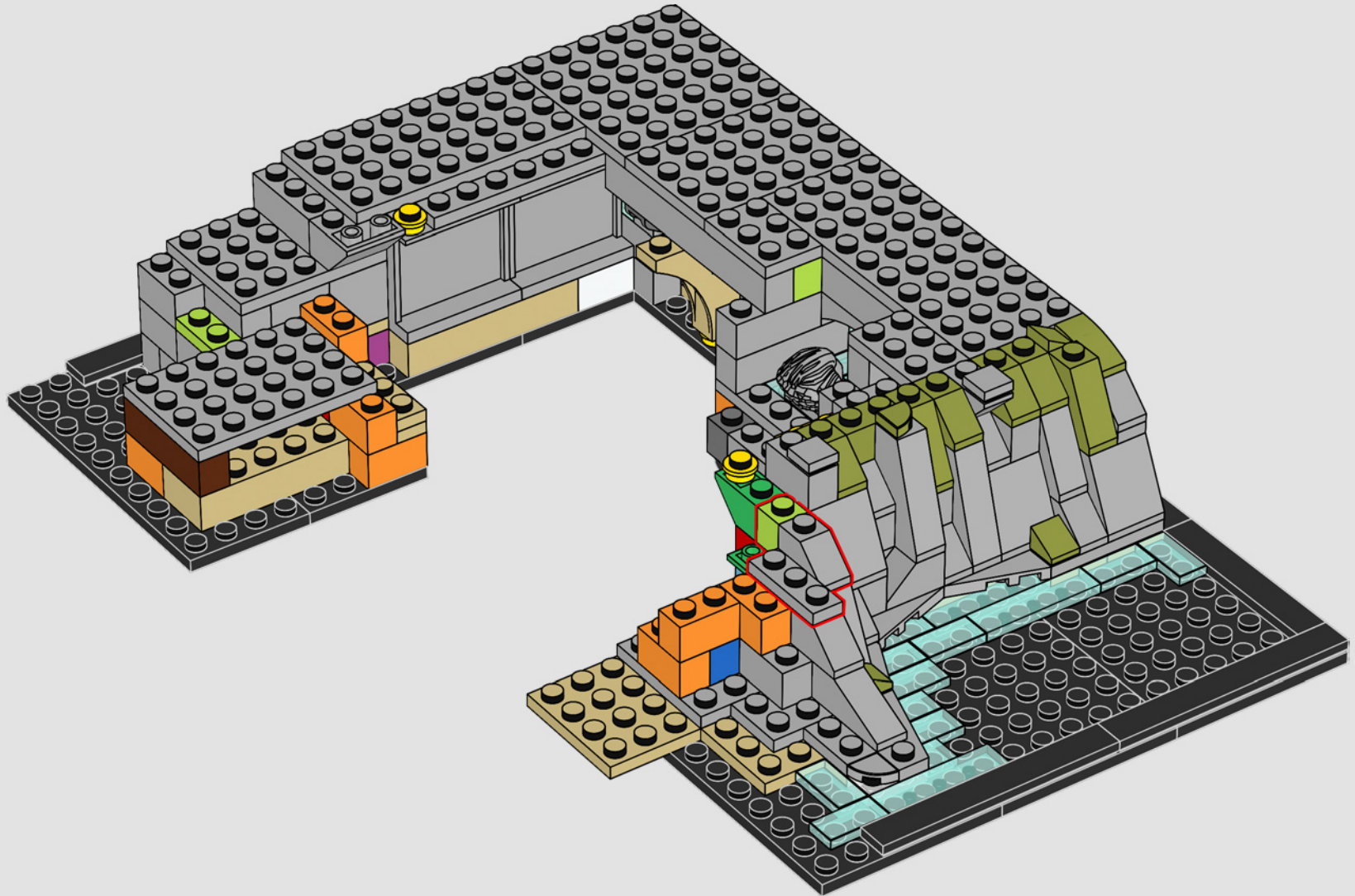

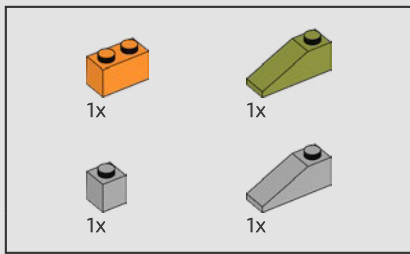

99

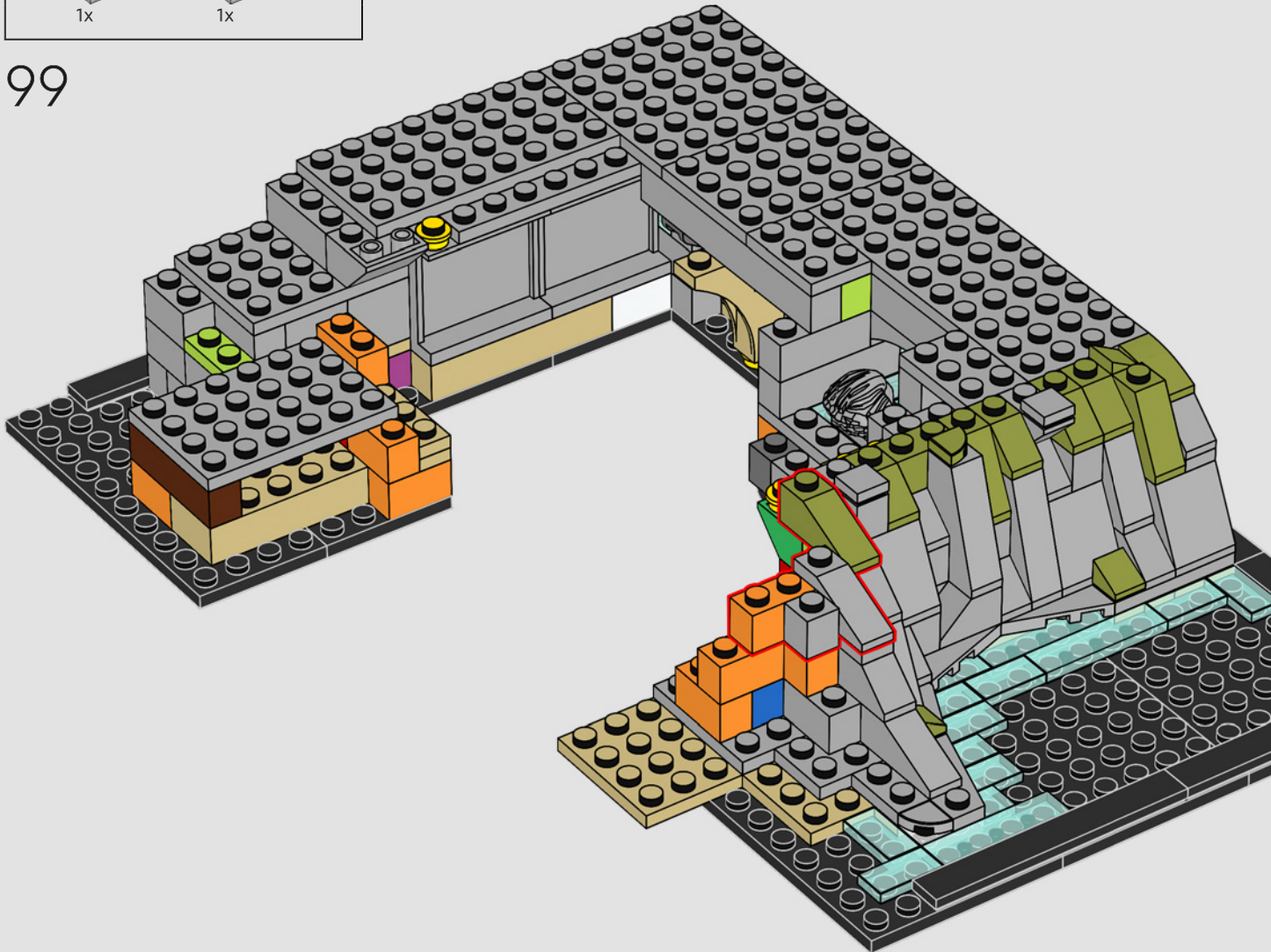

If Muggles™ should accidentally come across the Hogwarts™ grounds, the castle will look like an abandoned ruin, and warning signs will discourage them from exploring the site further.

Si des Moldus découvrent accidentellement le domaine de Poudlard, le château ressemblera à une ruine abandonnée, et des panneaux d'avertissement les dissuaderont d'explorer davantage le site.

Si los Muggles™ se topan accidentalmente con los terrenos de Hogwarts™, el castillo parecerá una ruina abandonada y las señales de advertencia los disuadirán de seguir explorando el lugar.



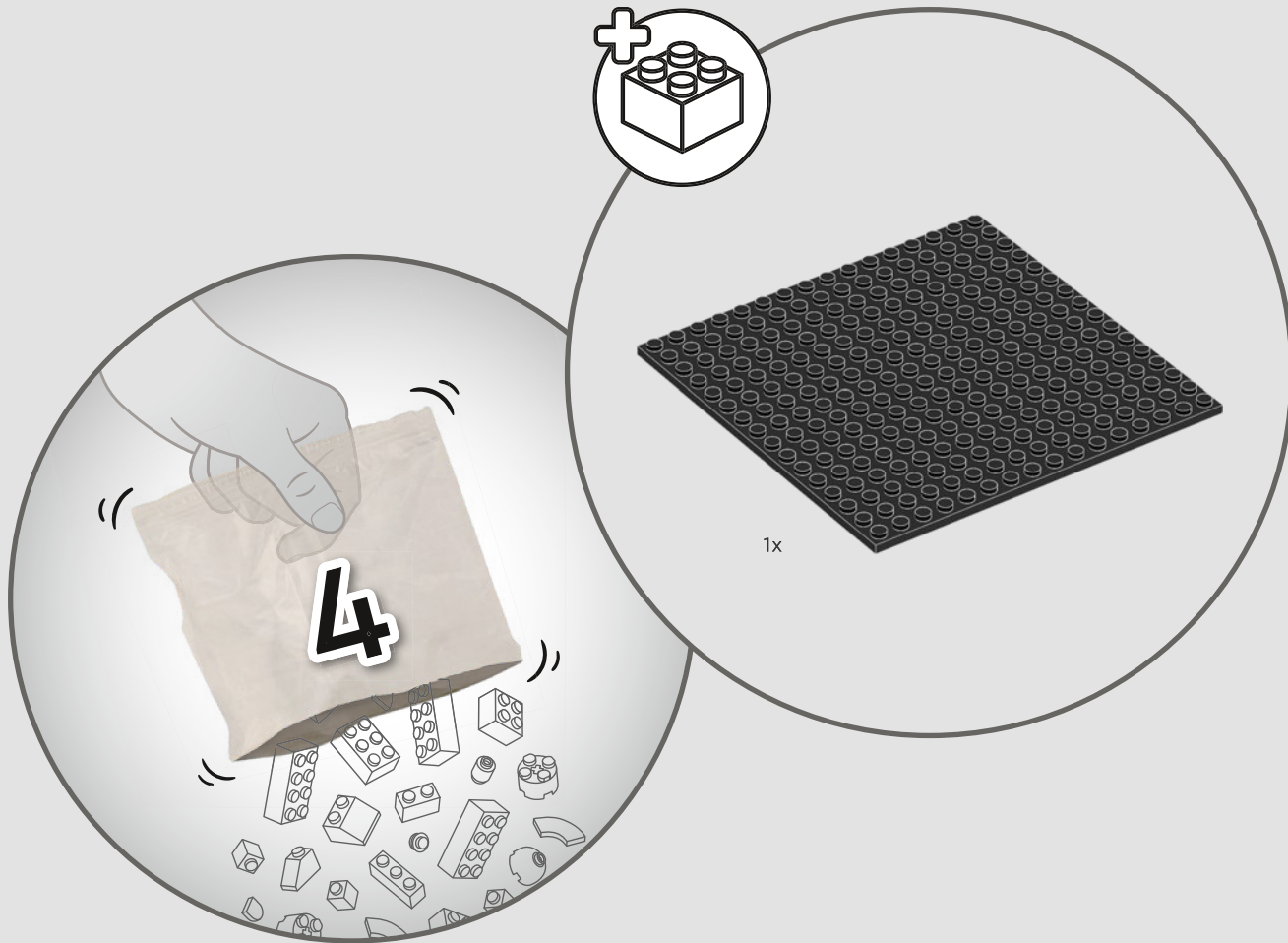

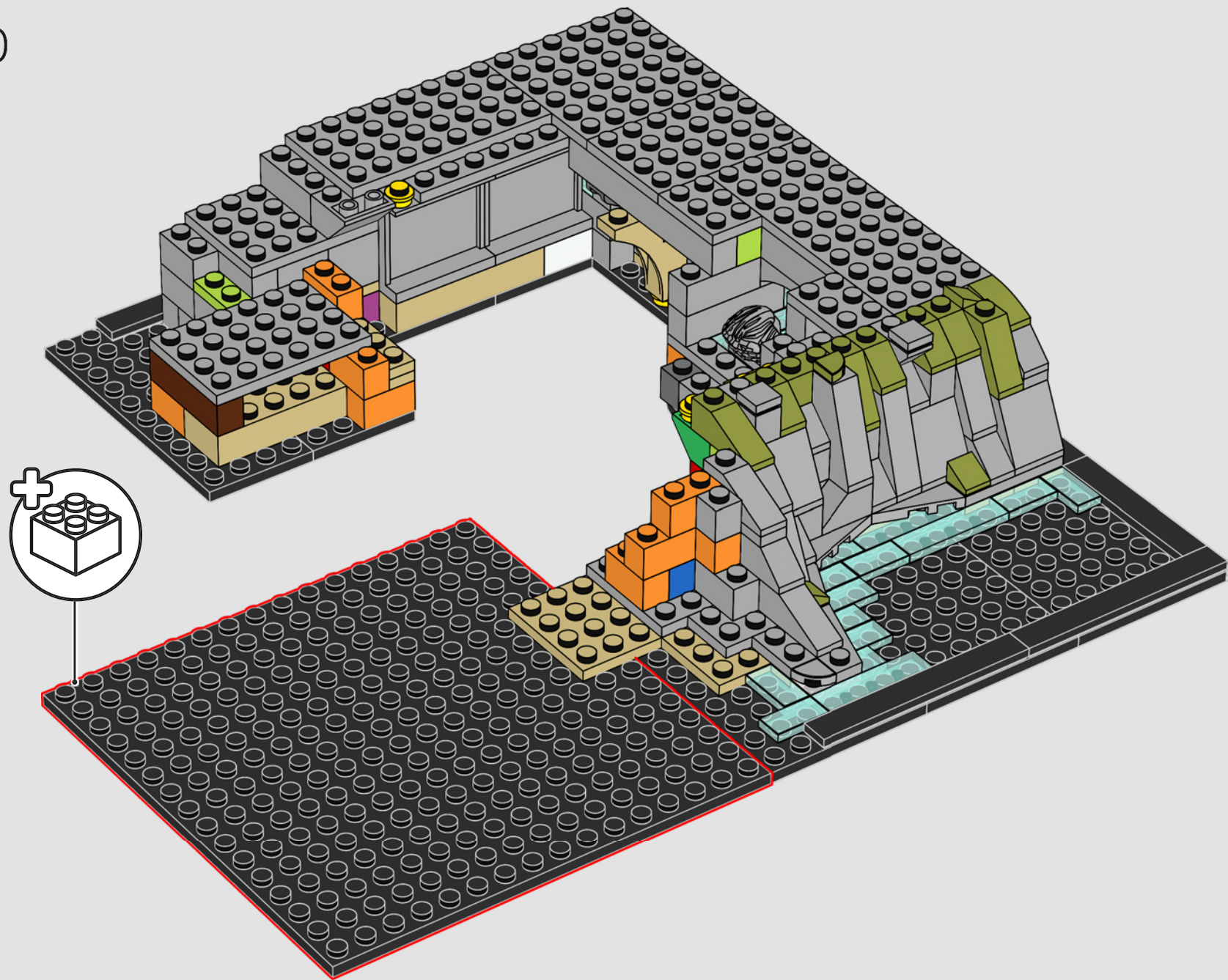



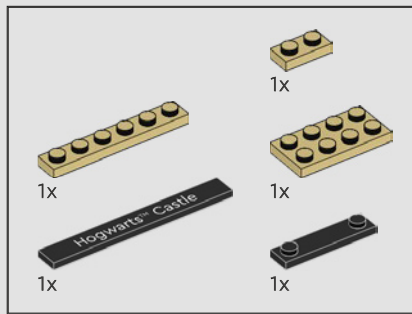

101

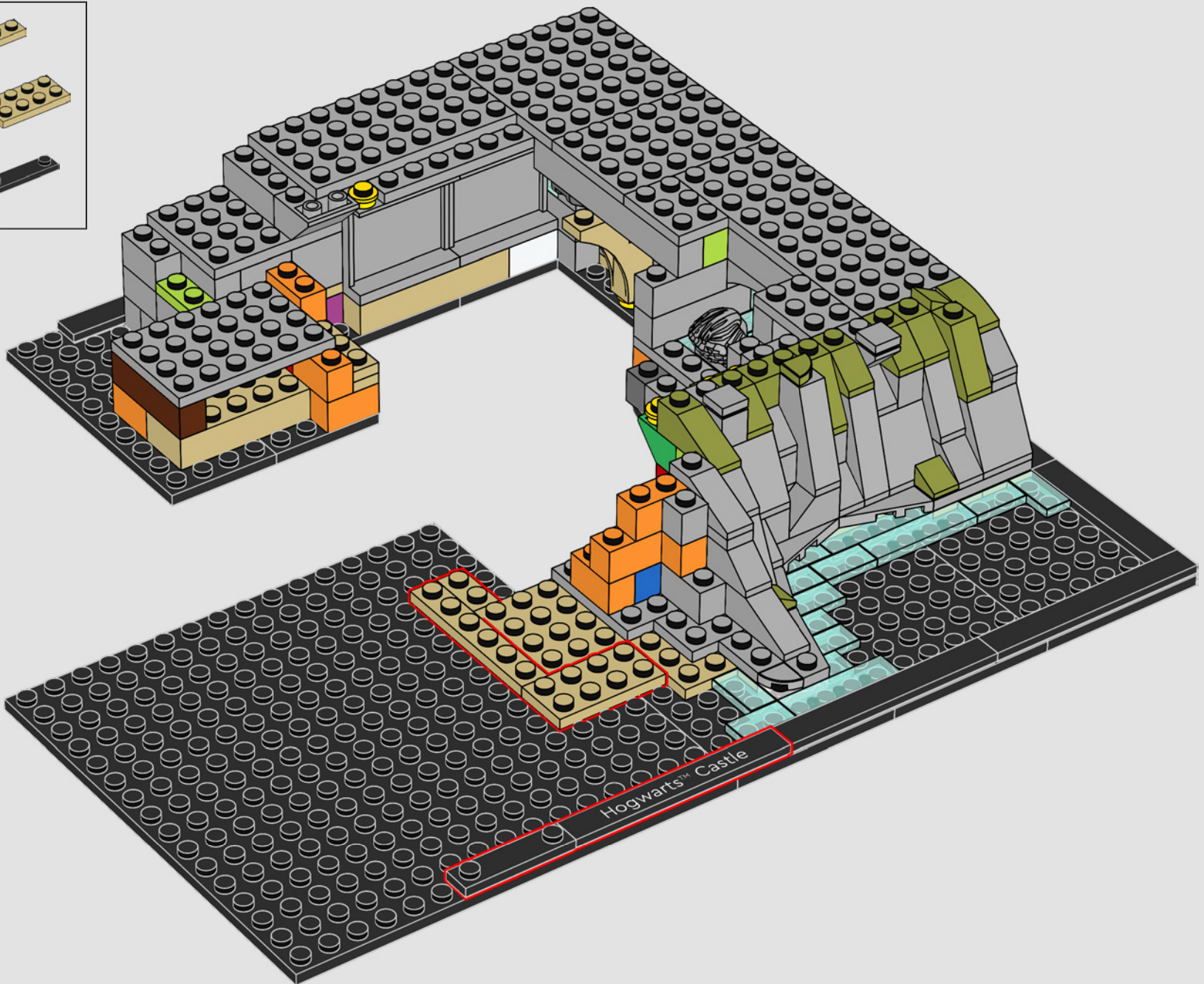

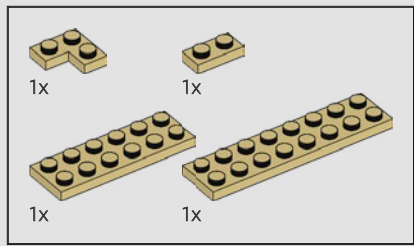

102

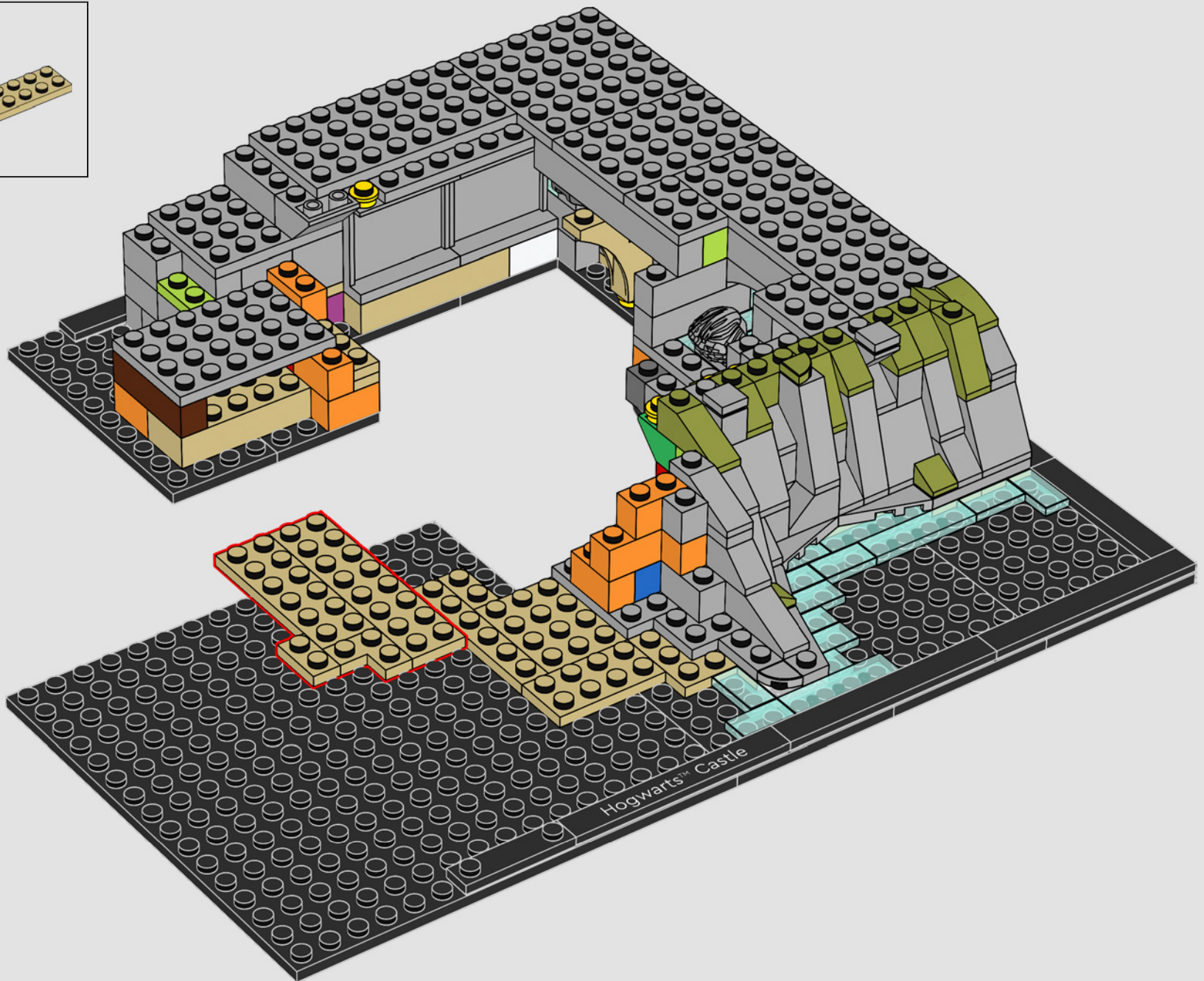

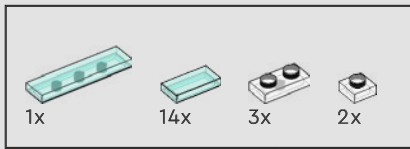

103

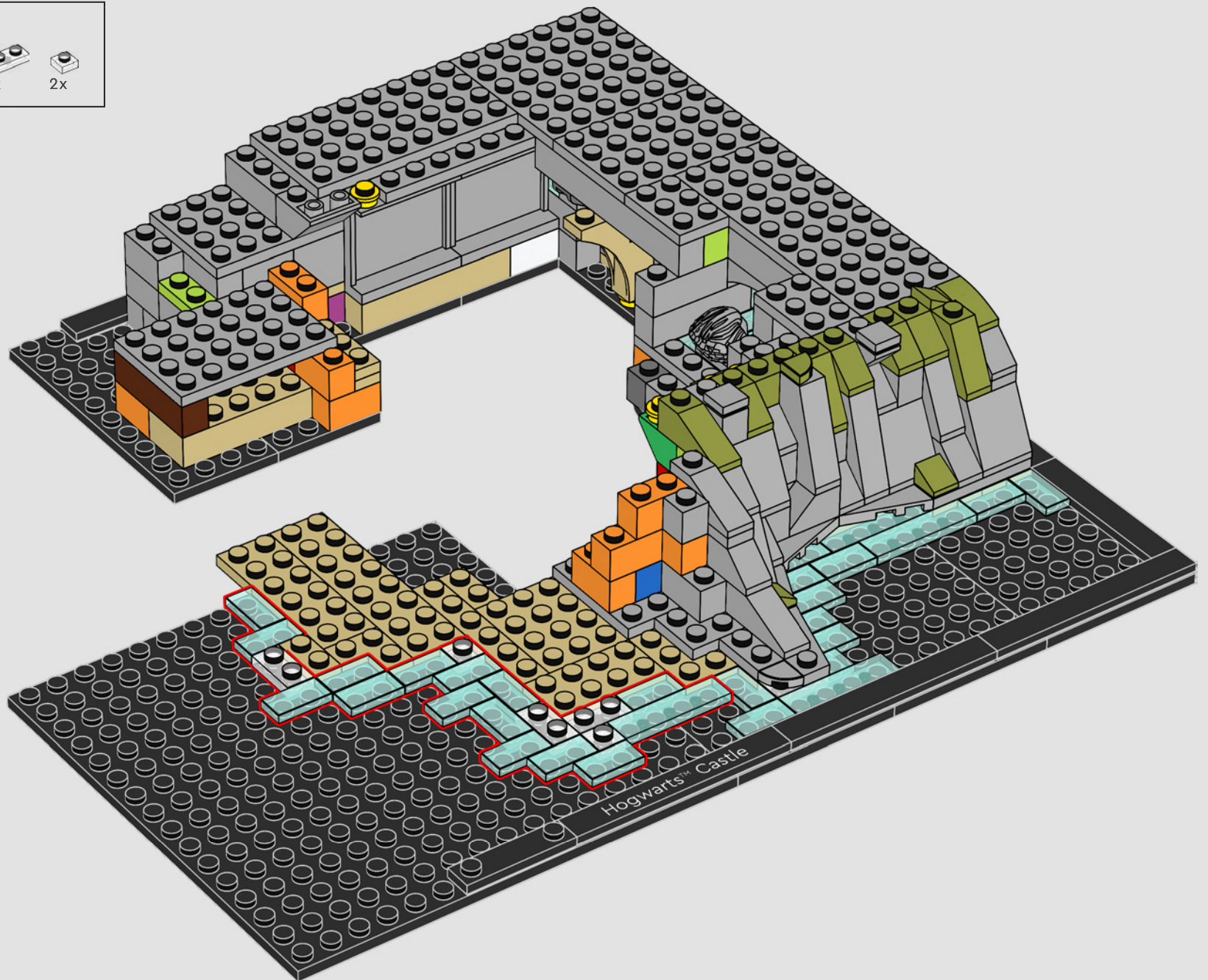

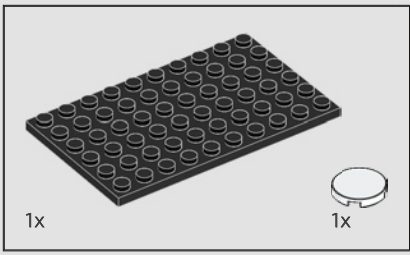

104

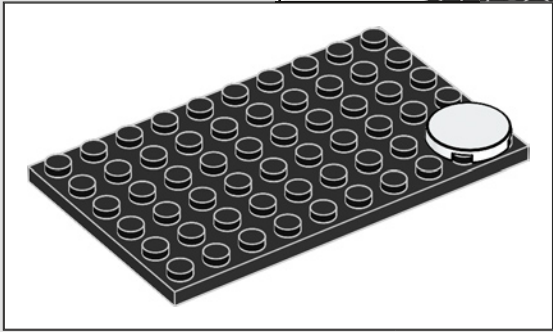
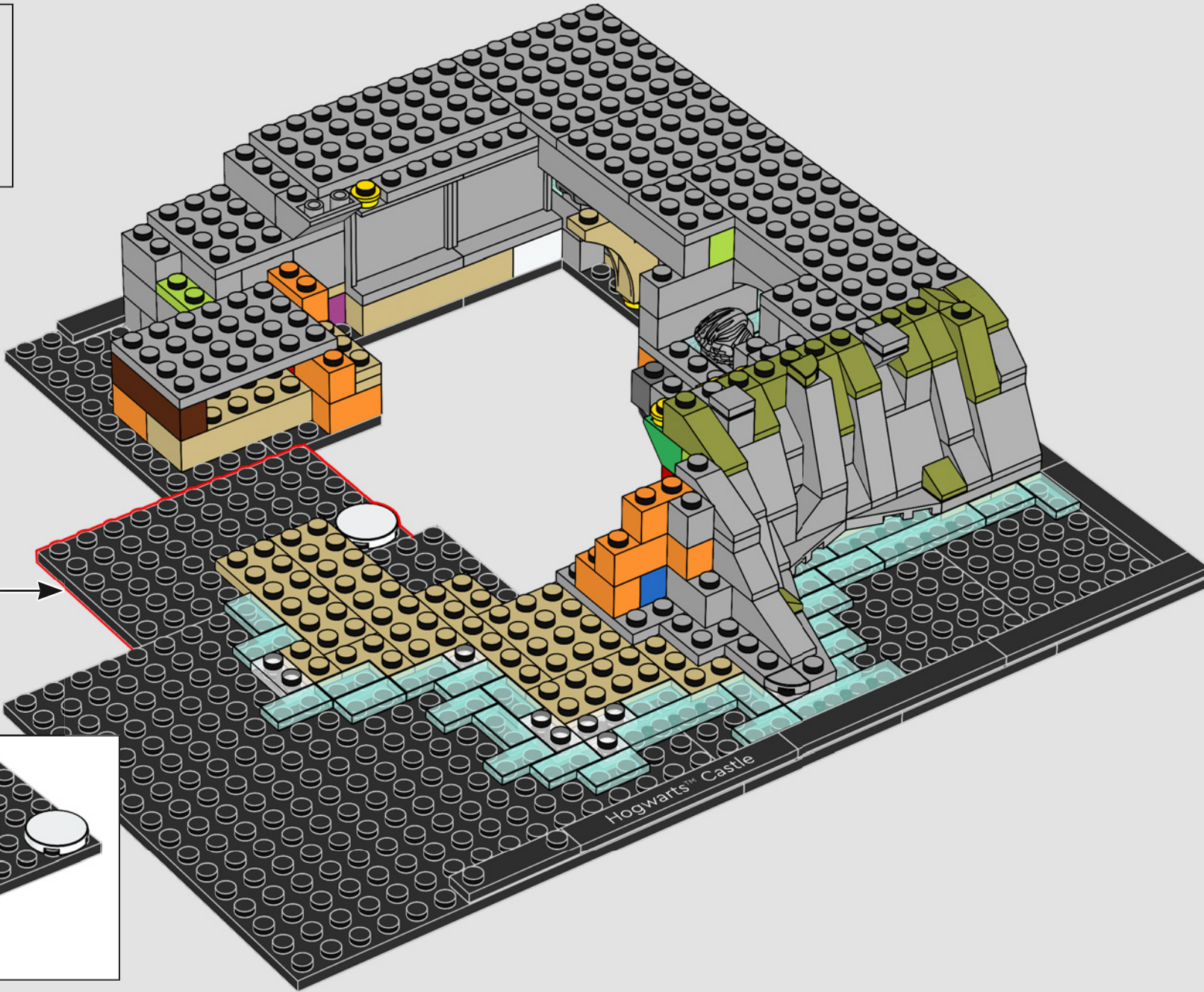

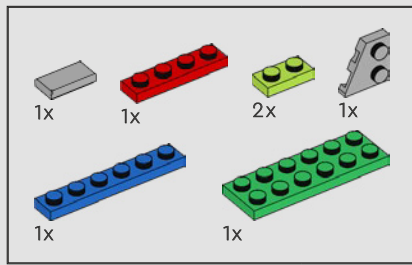

105

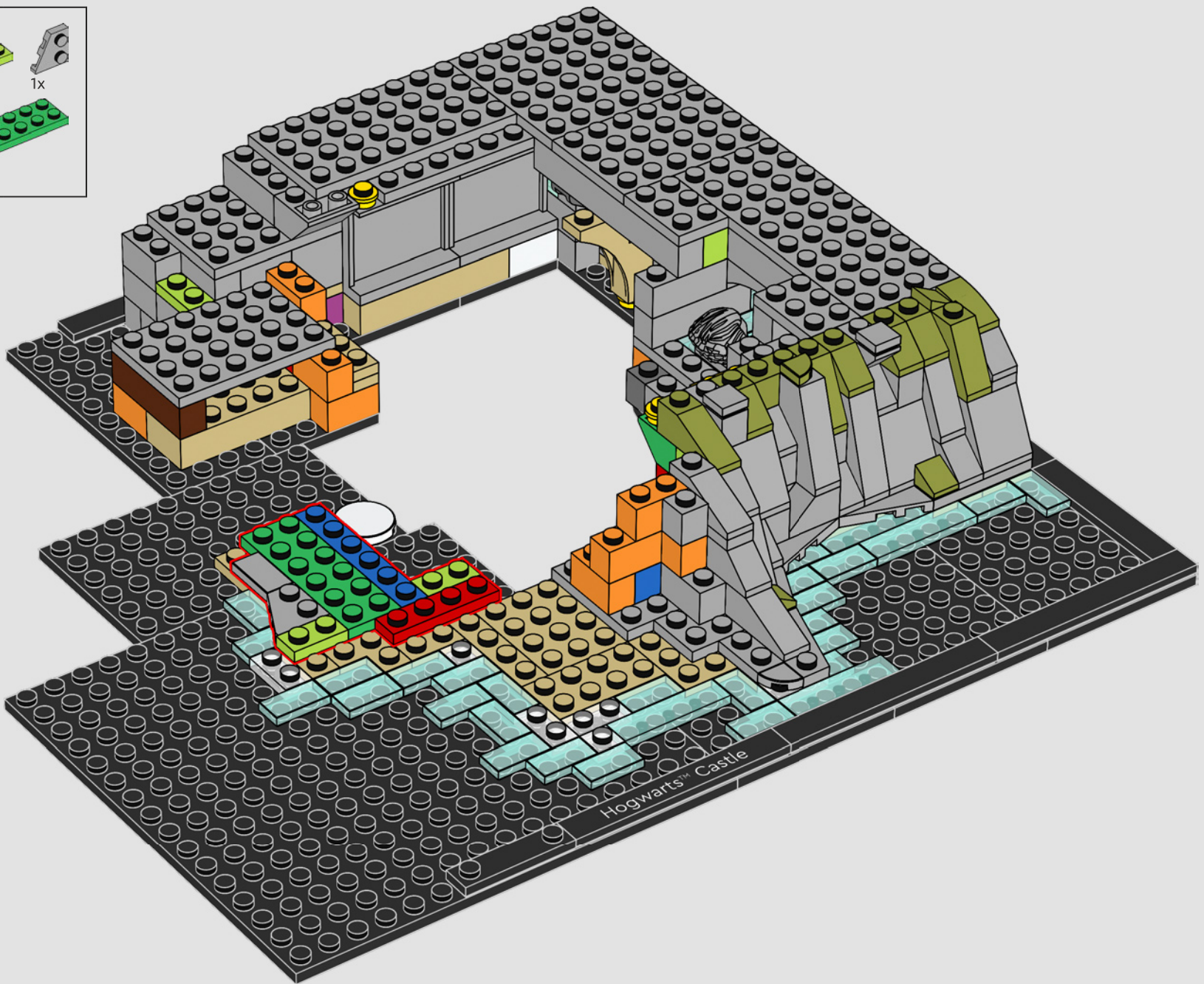

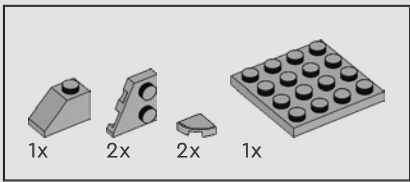

106

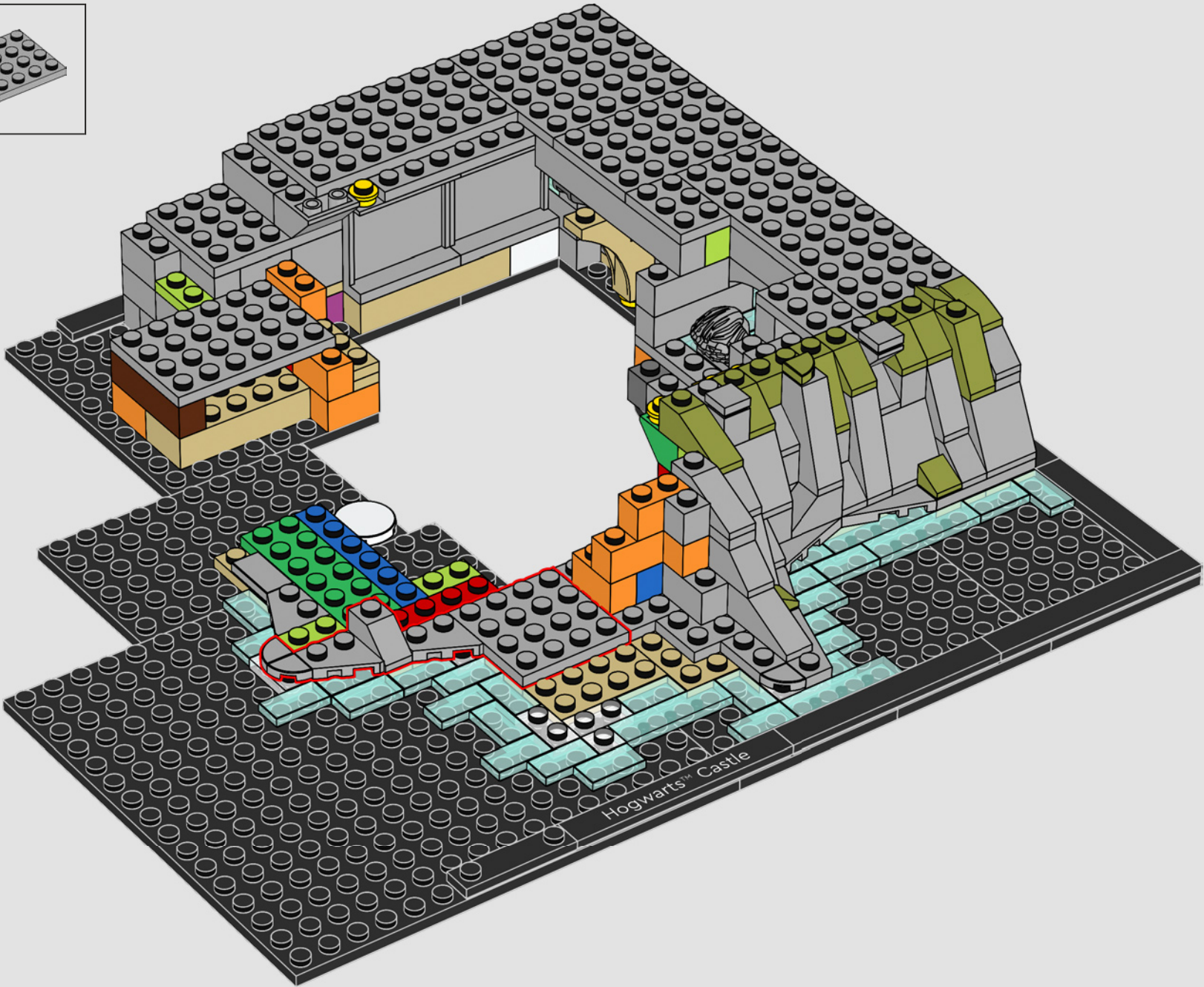

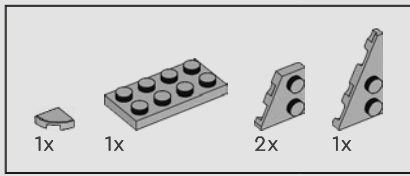

107

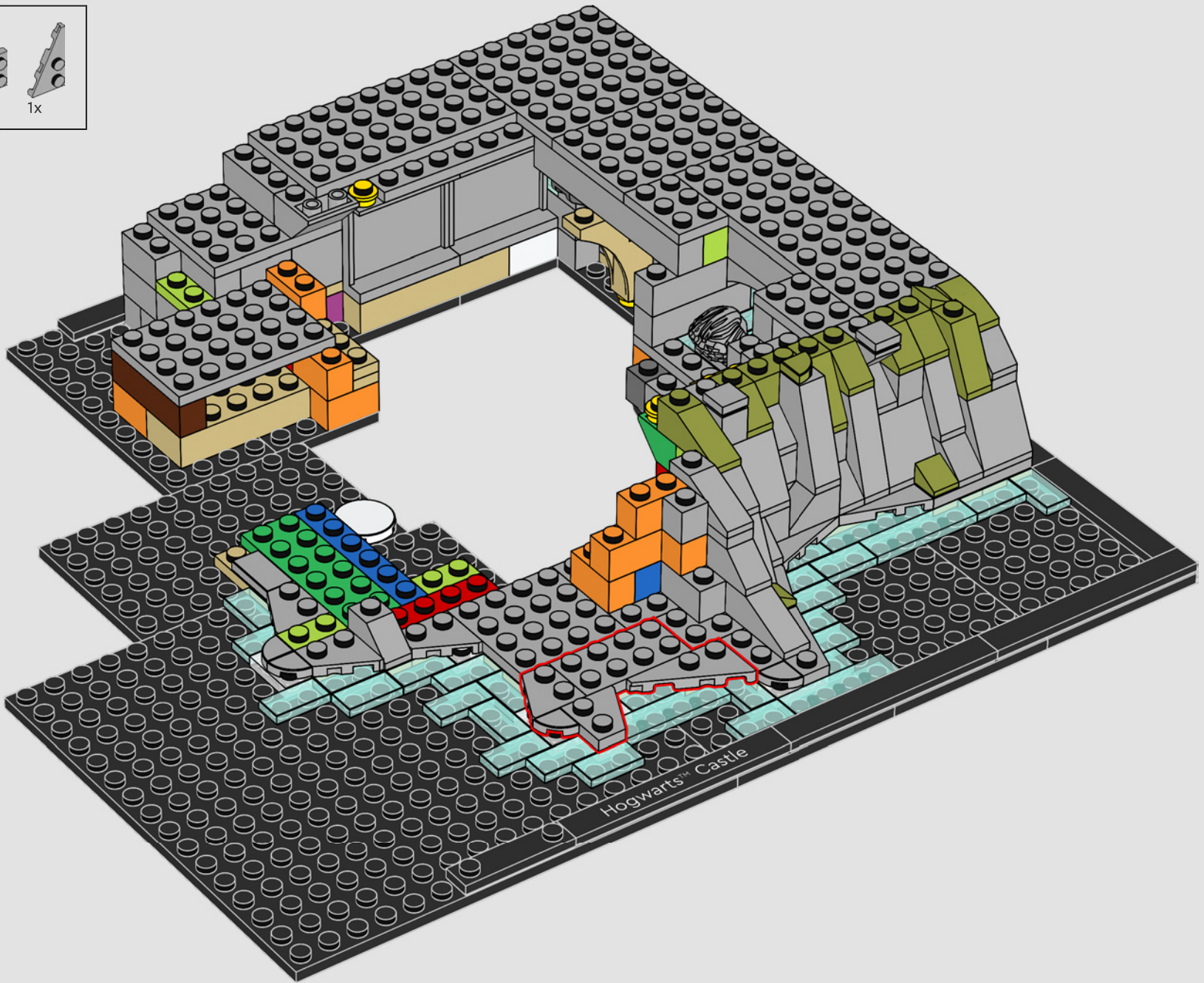

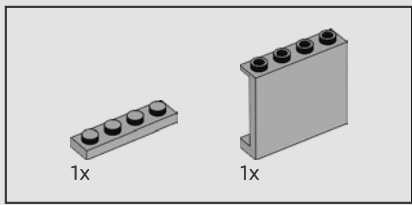

108

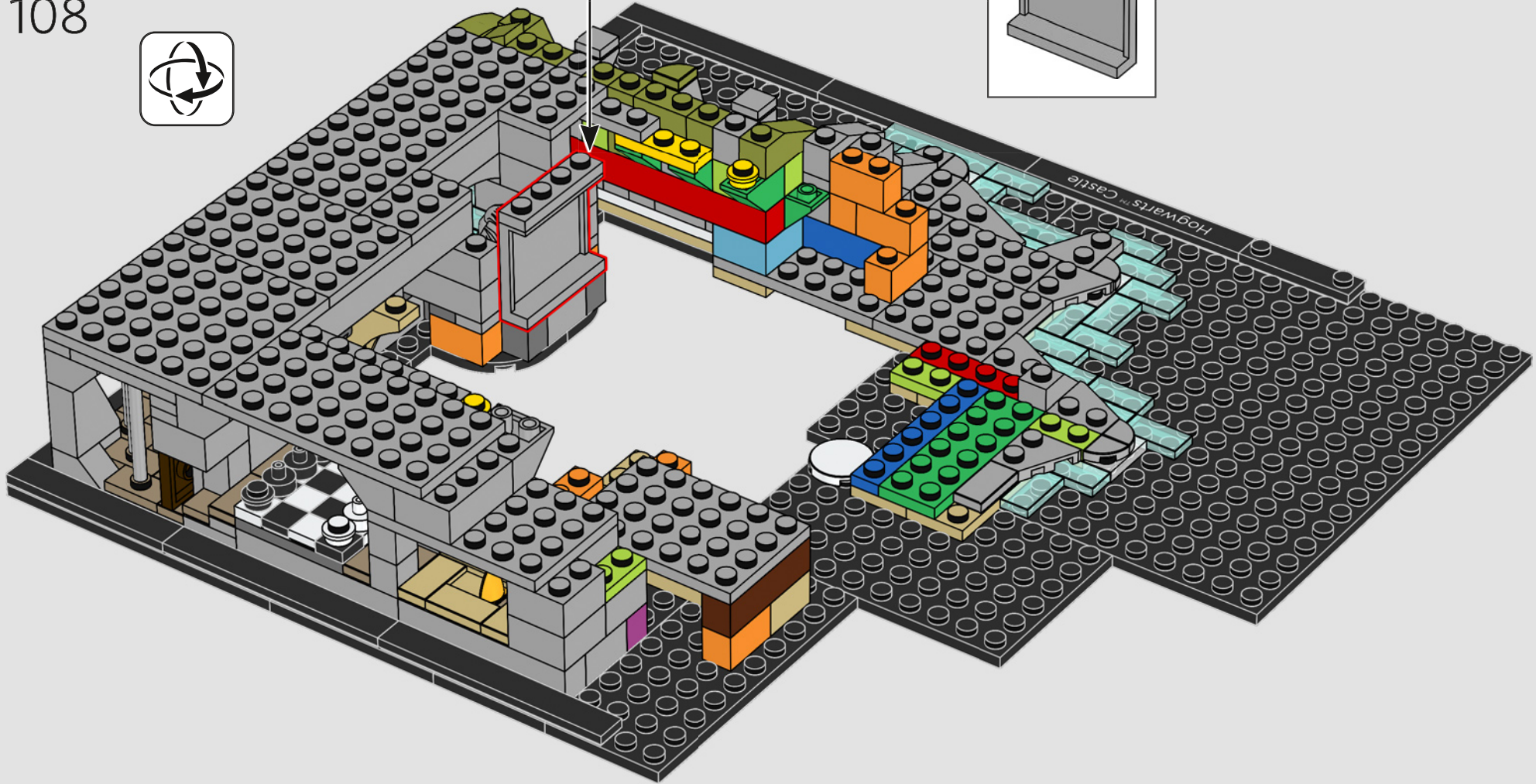
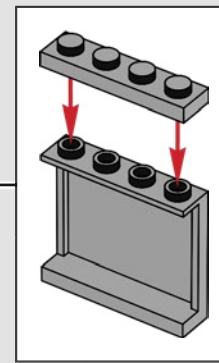



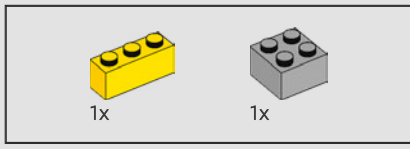

109

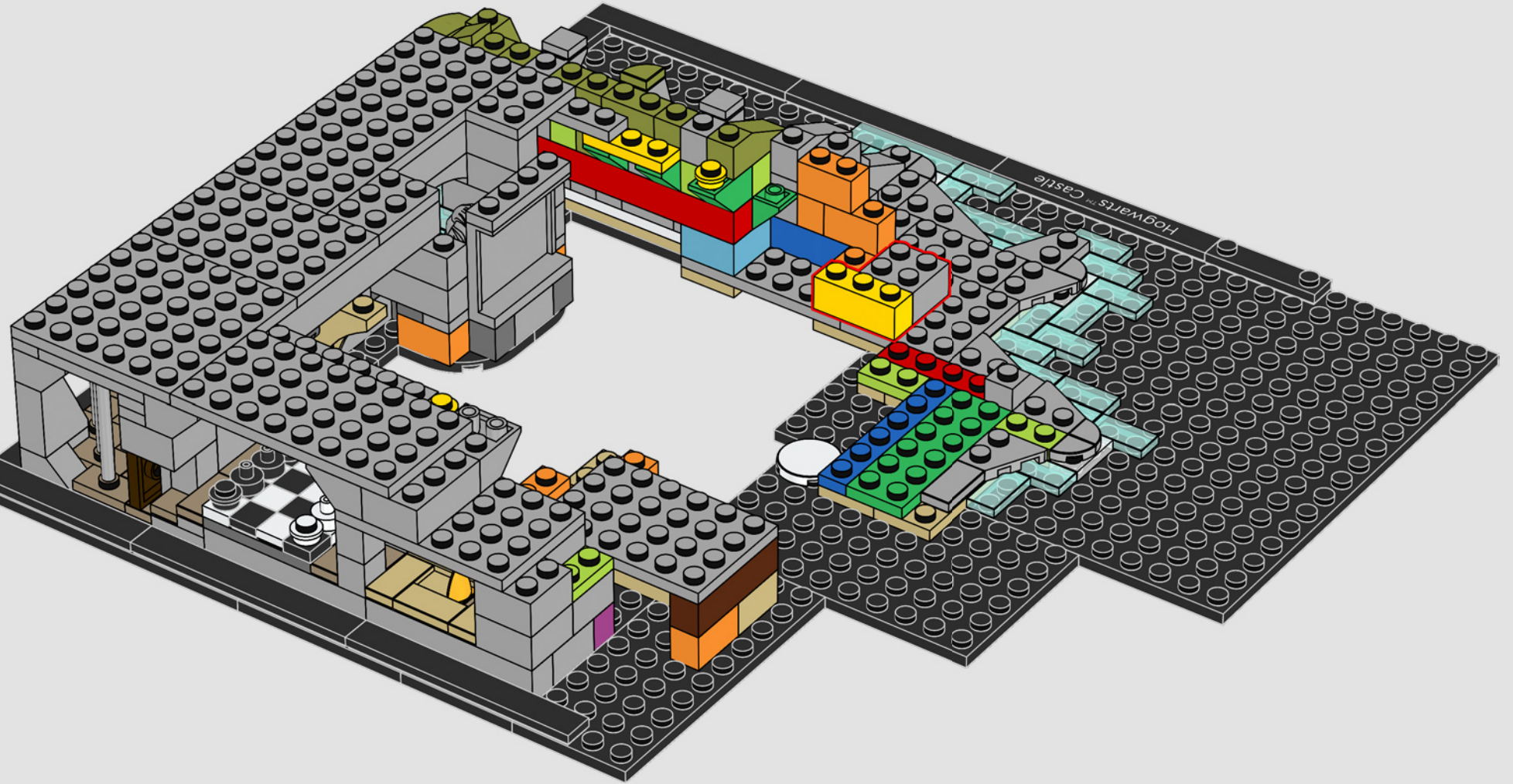

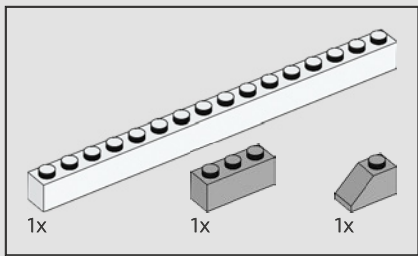

110

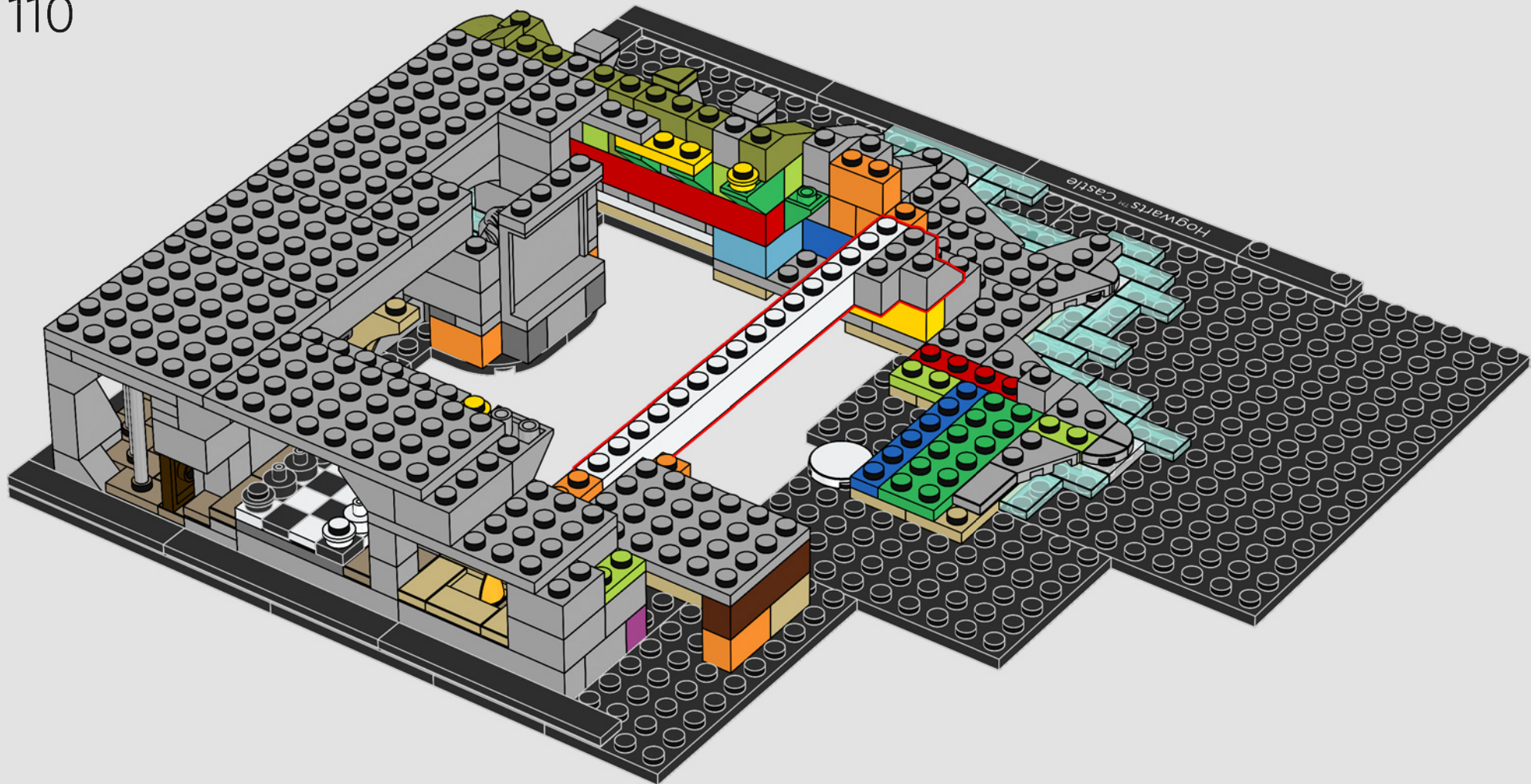

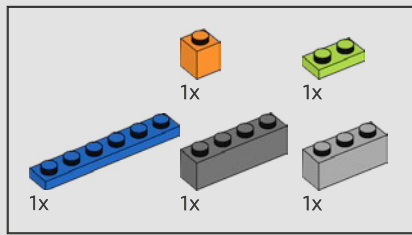

111

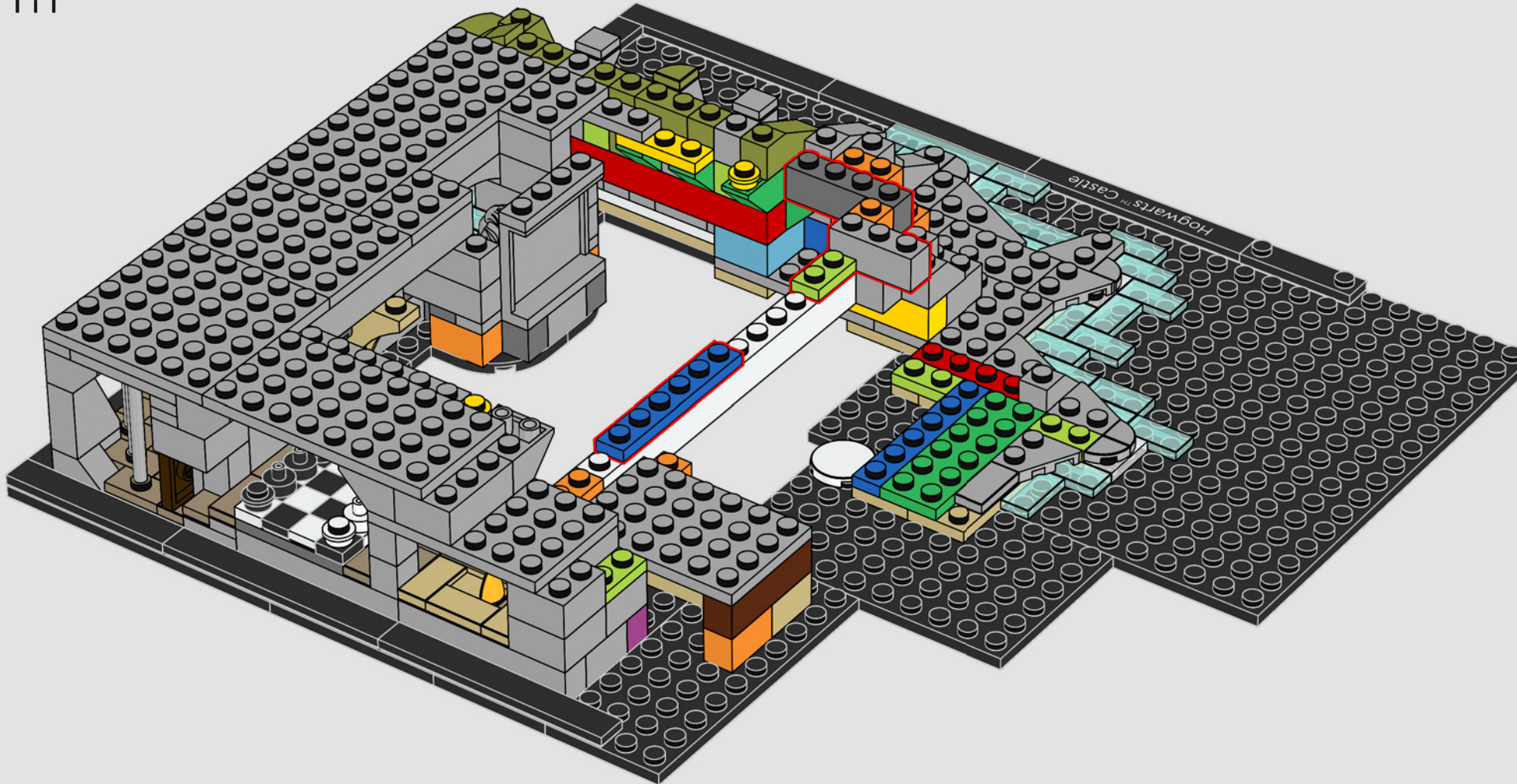



4x

112

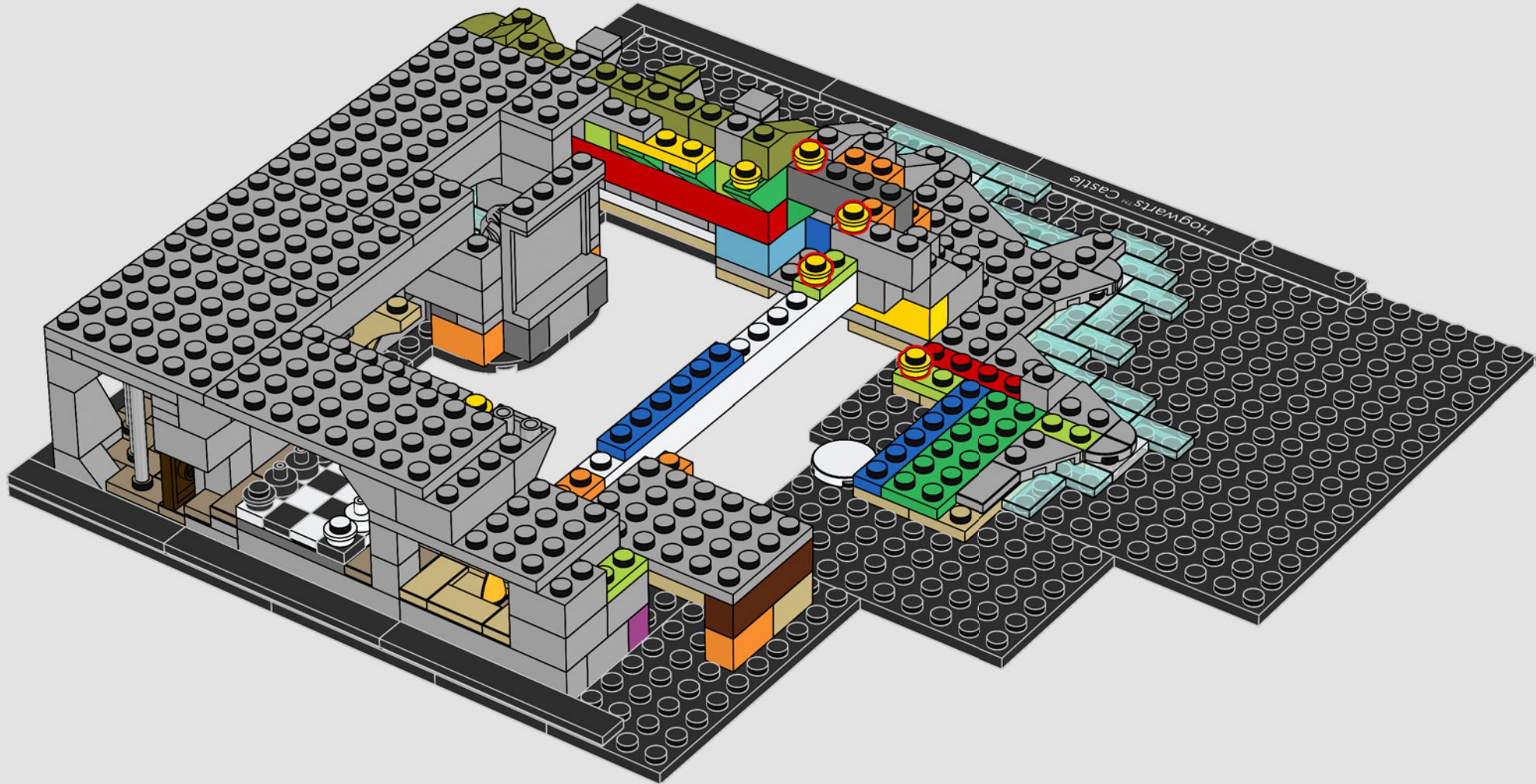

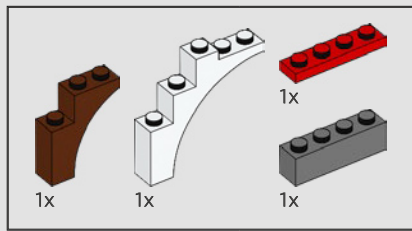

113

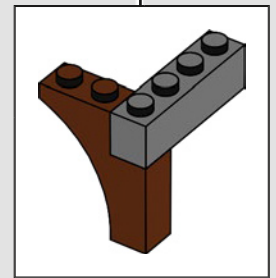
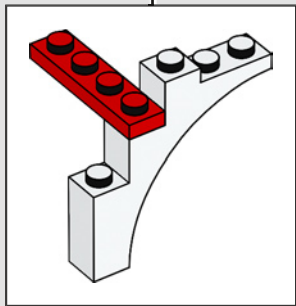
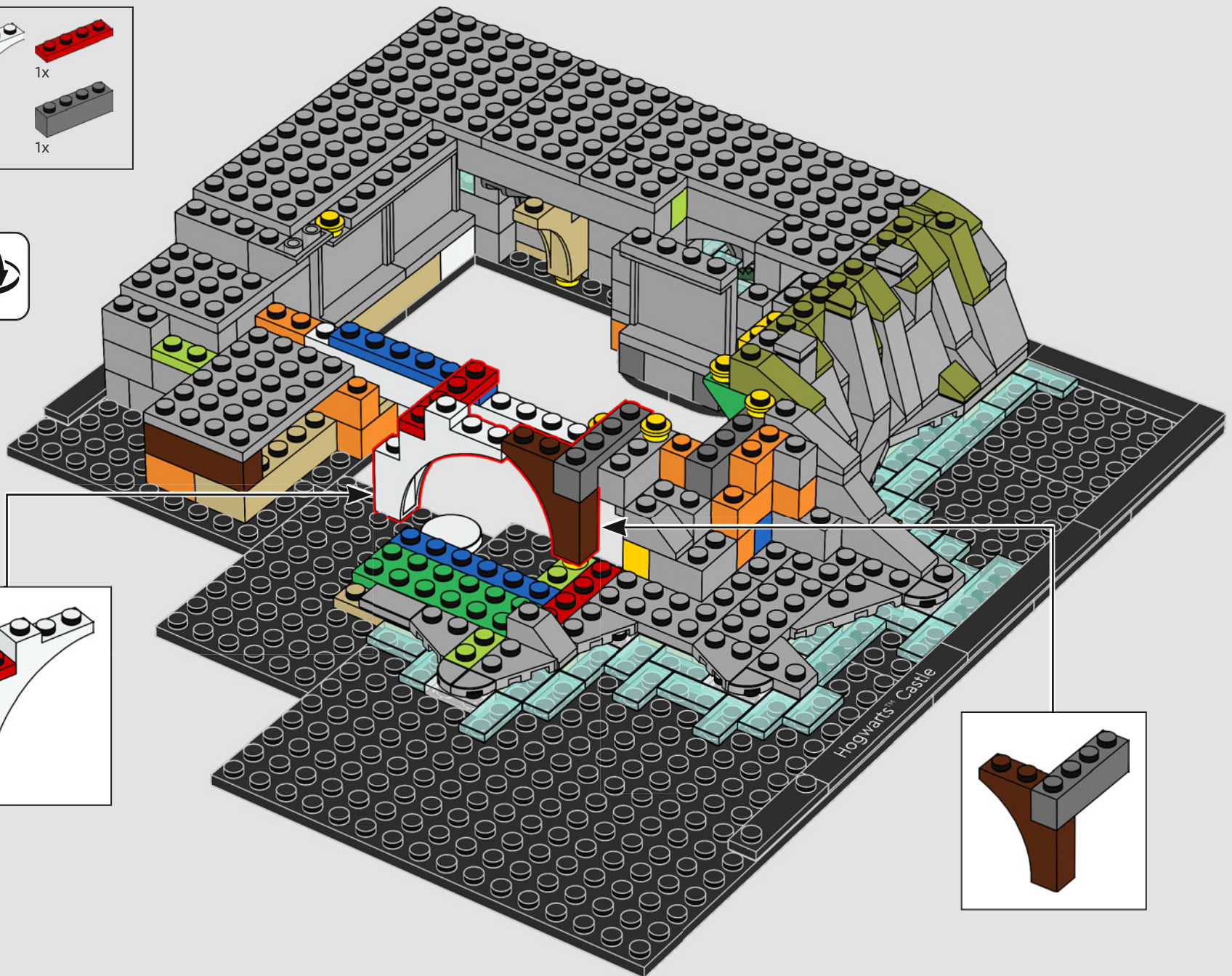

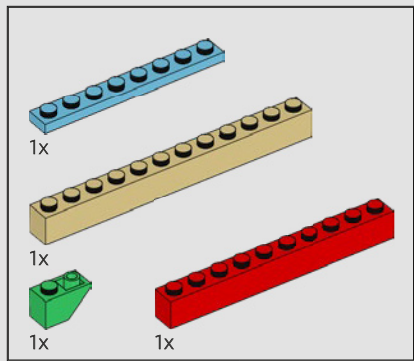

114

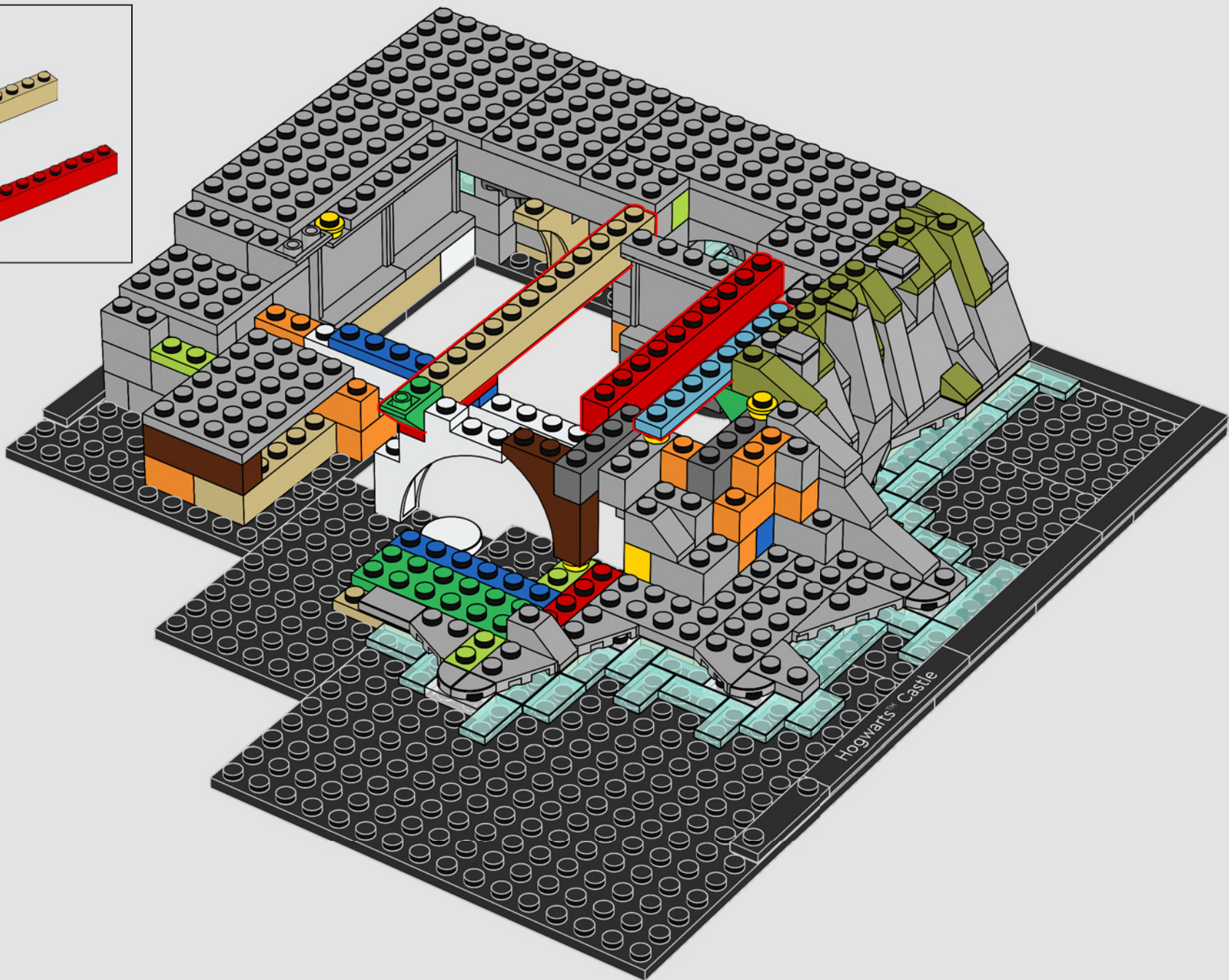

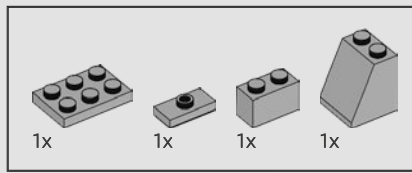

115

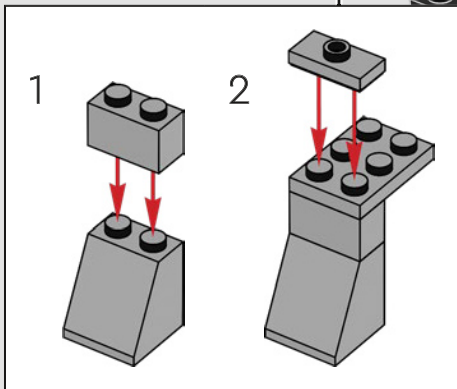
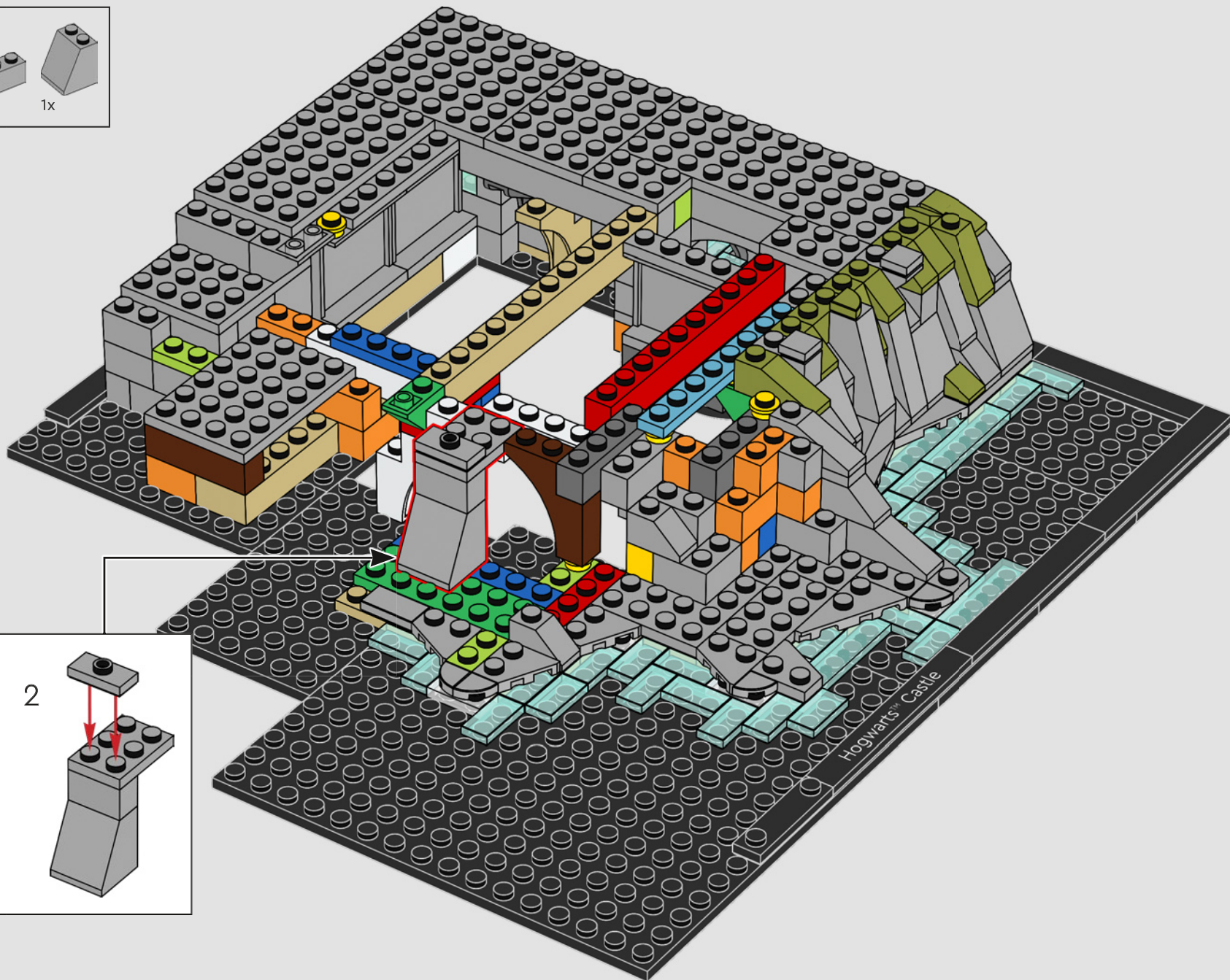

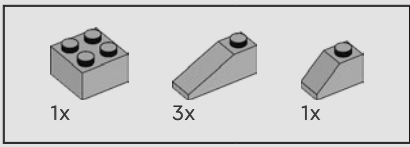

116





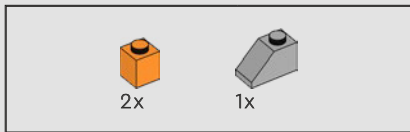

117

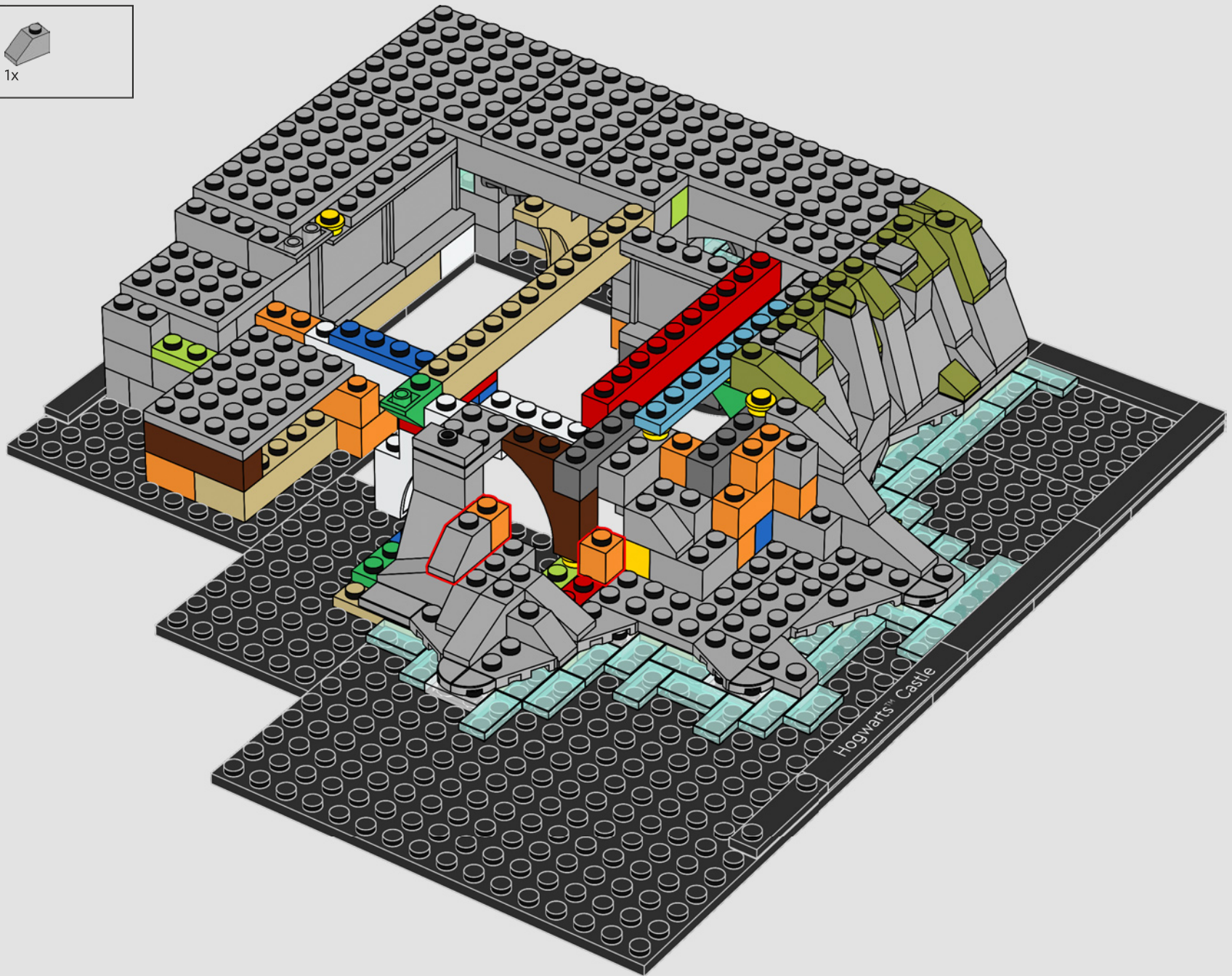

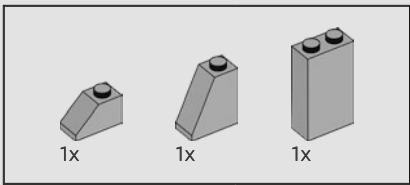

118



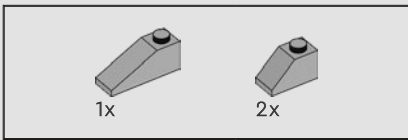

119





3x

120

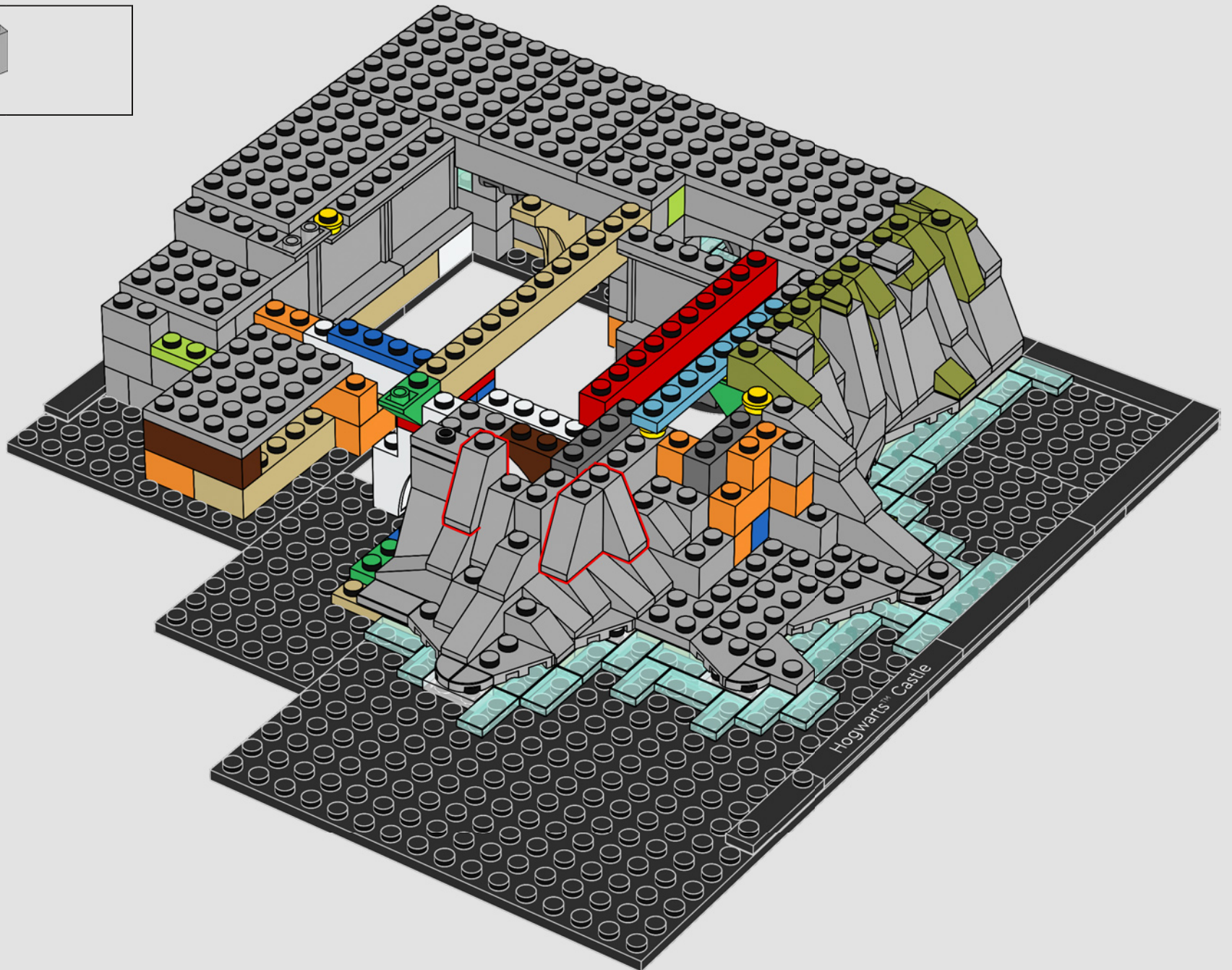

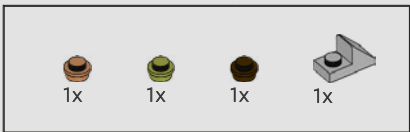

121



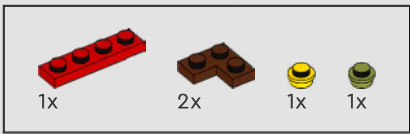

122

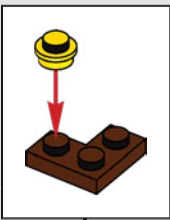
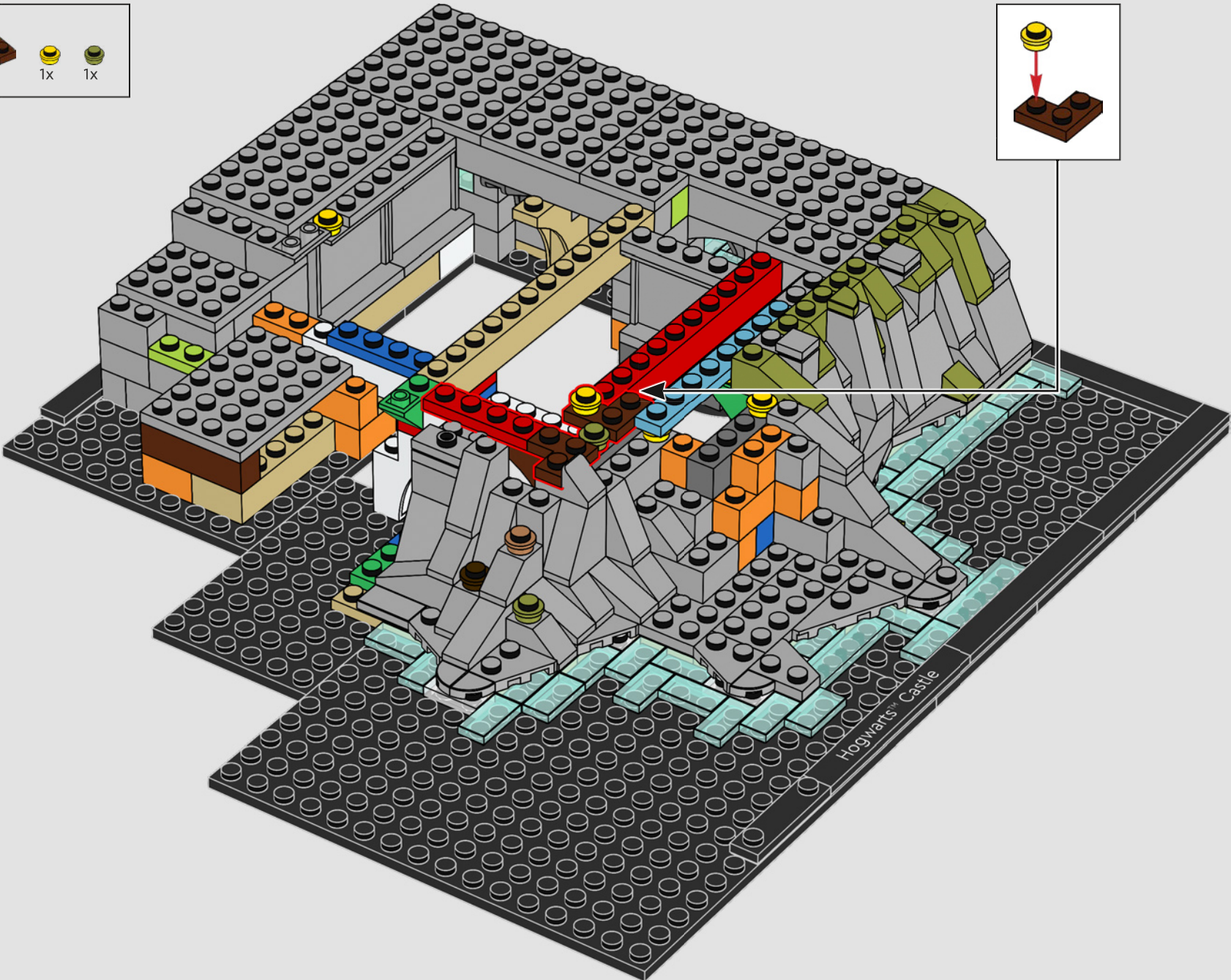

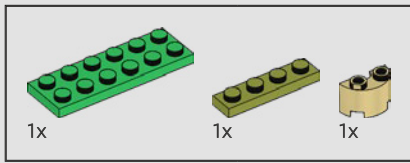

123



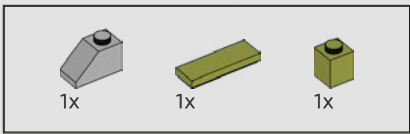

124

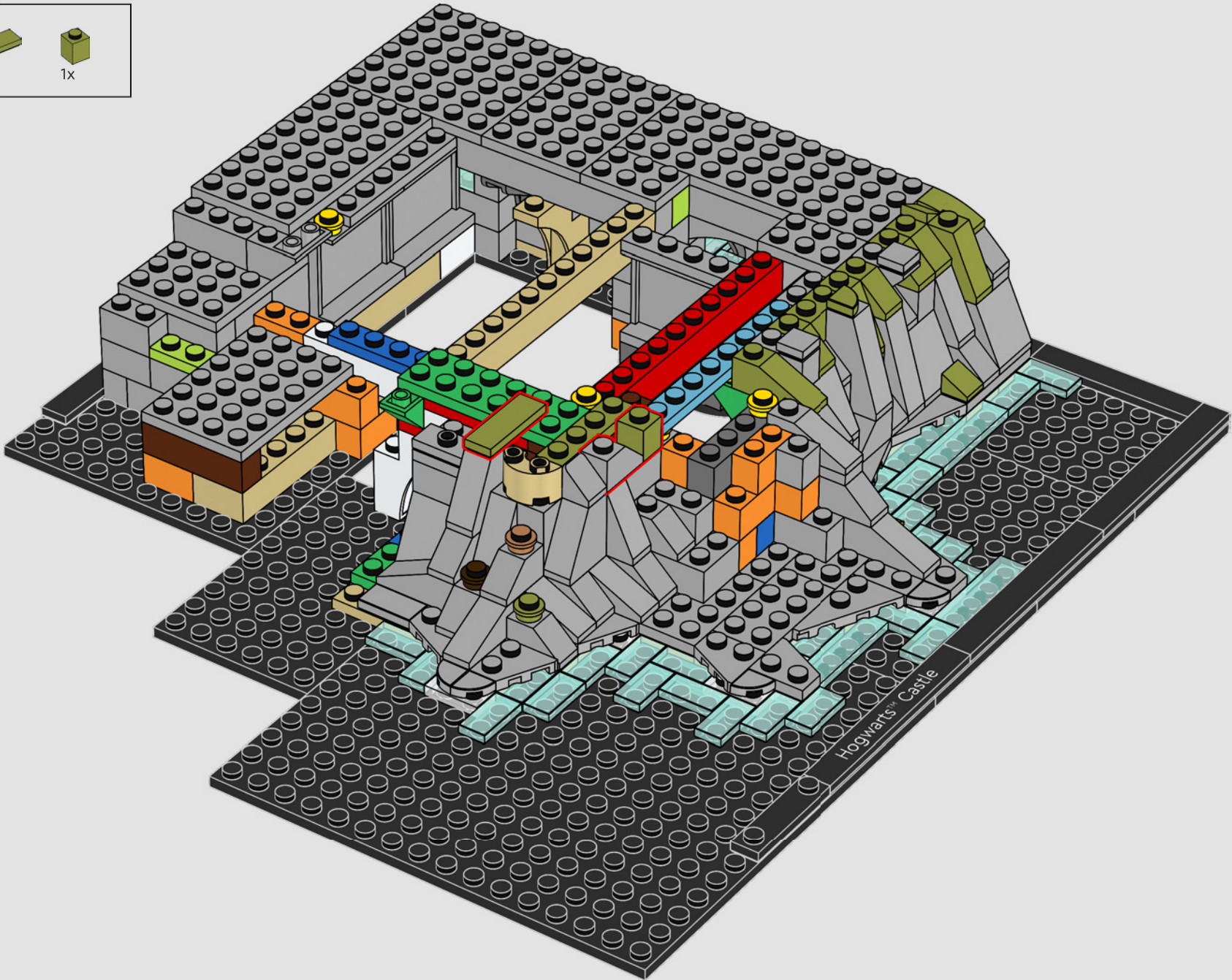



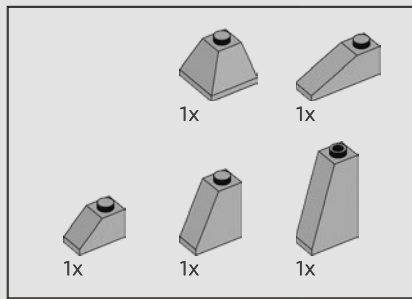

125

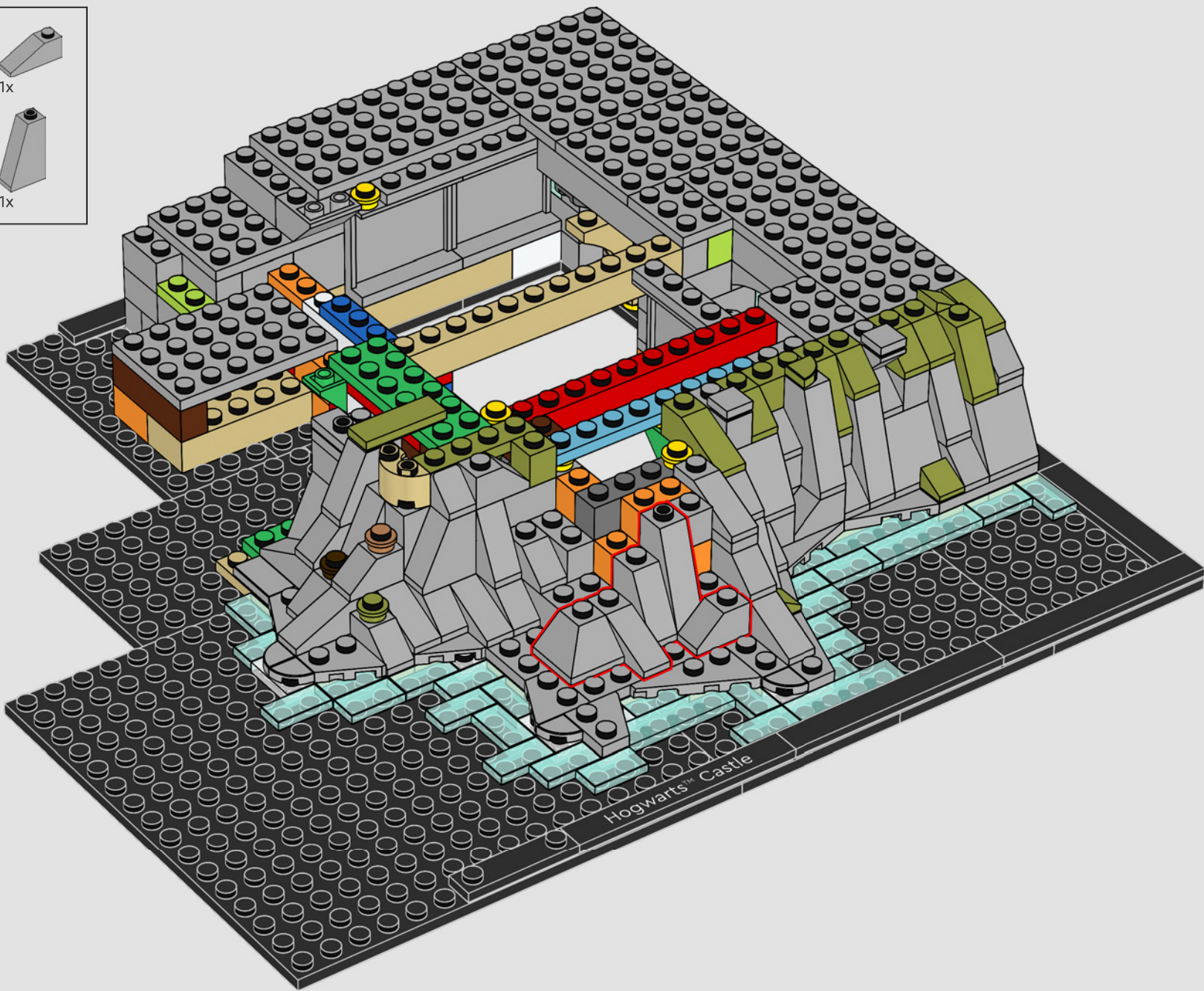

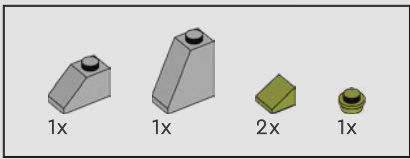

126

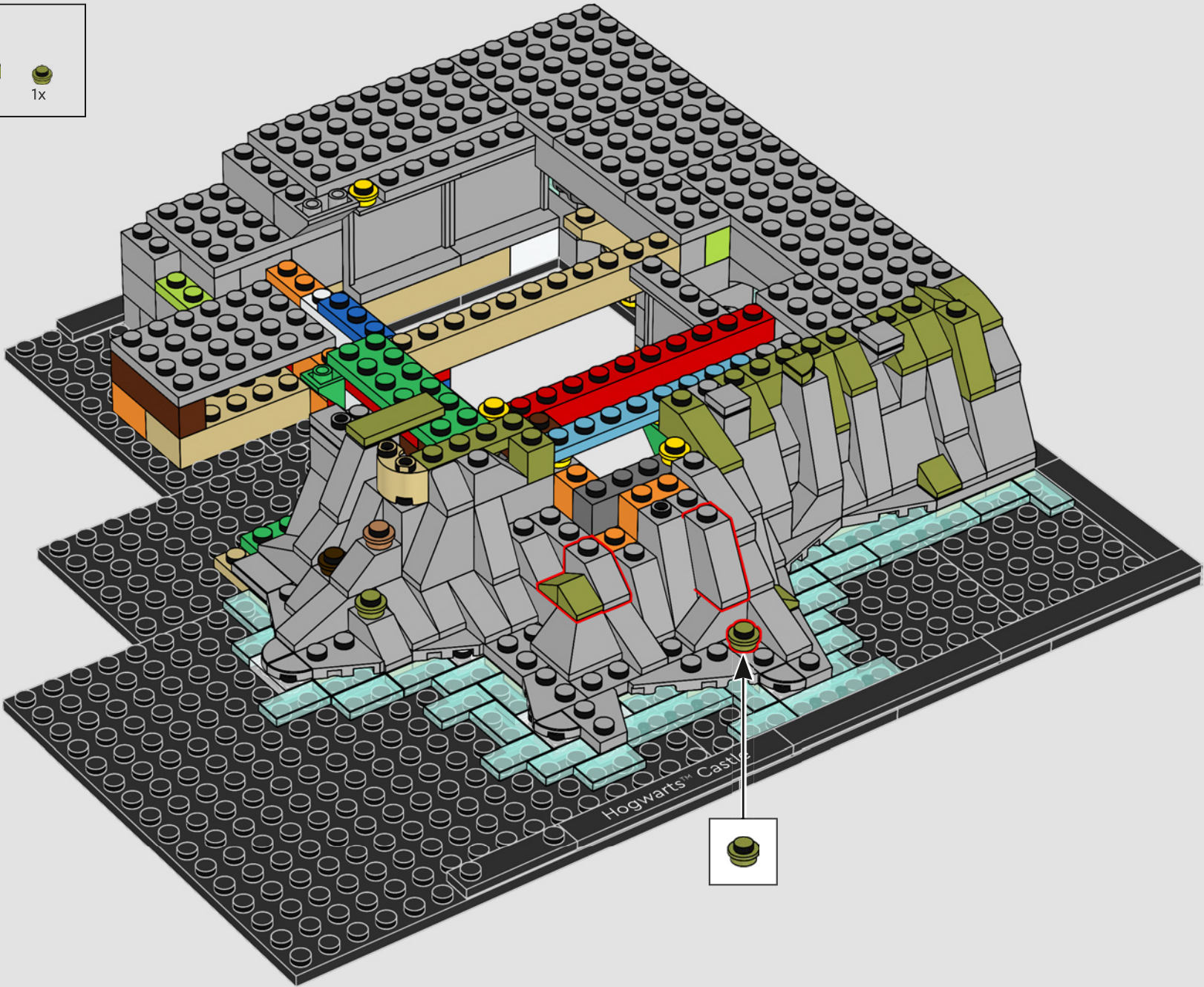



127

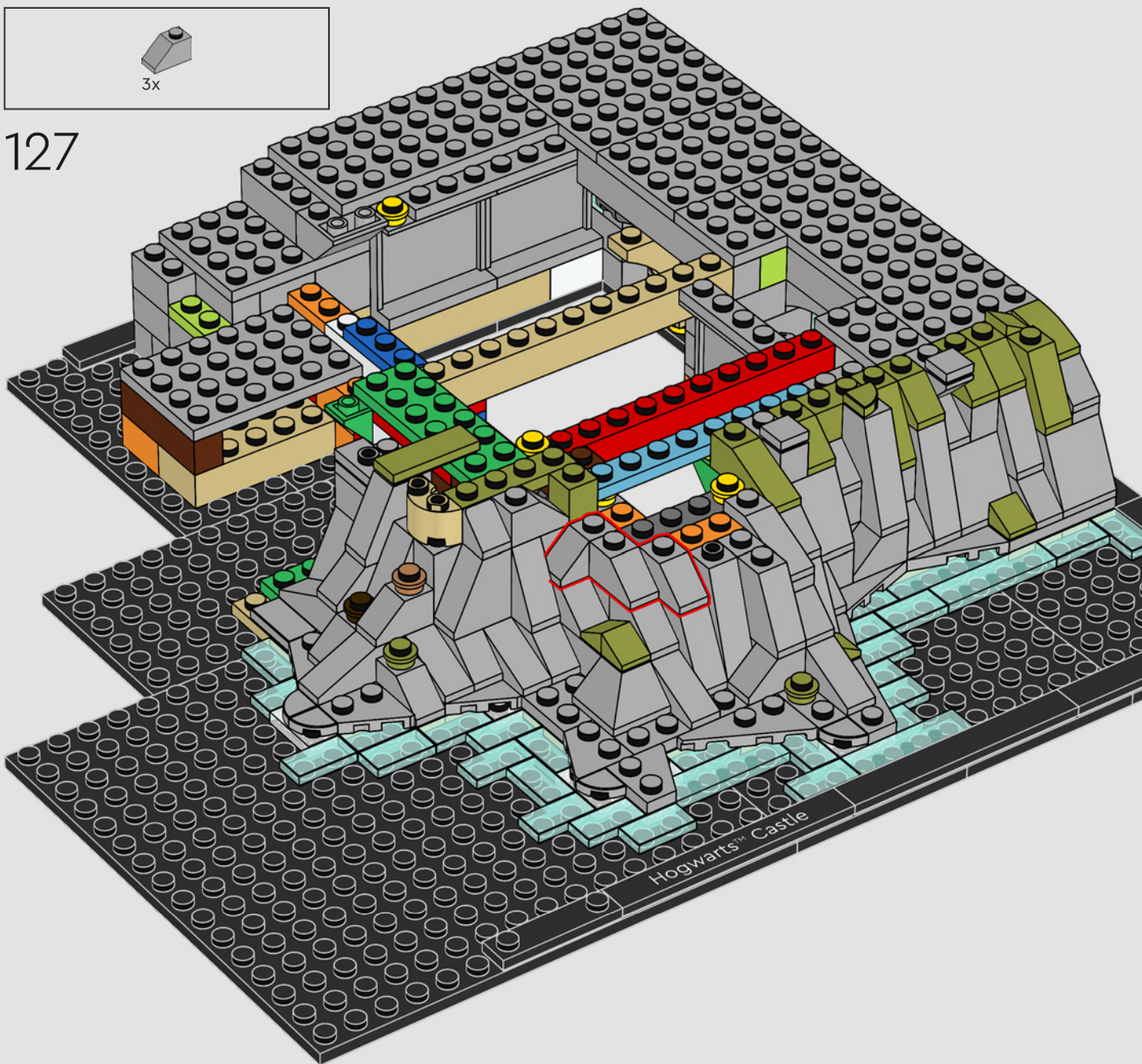

Many of the castle's secrets are still mysteries to the Wizarding World. Even Albus Dumbledore™ never knew everything about its construction or design.

De nombreux secrets du château sont encore des mystères pour le monde des sorciers. Même Albus Dumbledore™ ignorait bien des choses sur sa construction et sa conception.

Muchos de los secretos del castillo siguen siendo misterios para el Mundo Mágico. Ni siquiera Albus Dumbledore™ llegó a saberlo todo sobre su construcción o diseño.



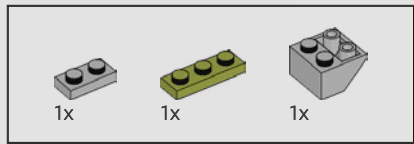

128

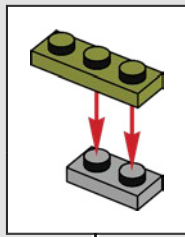
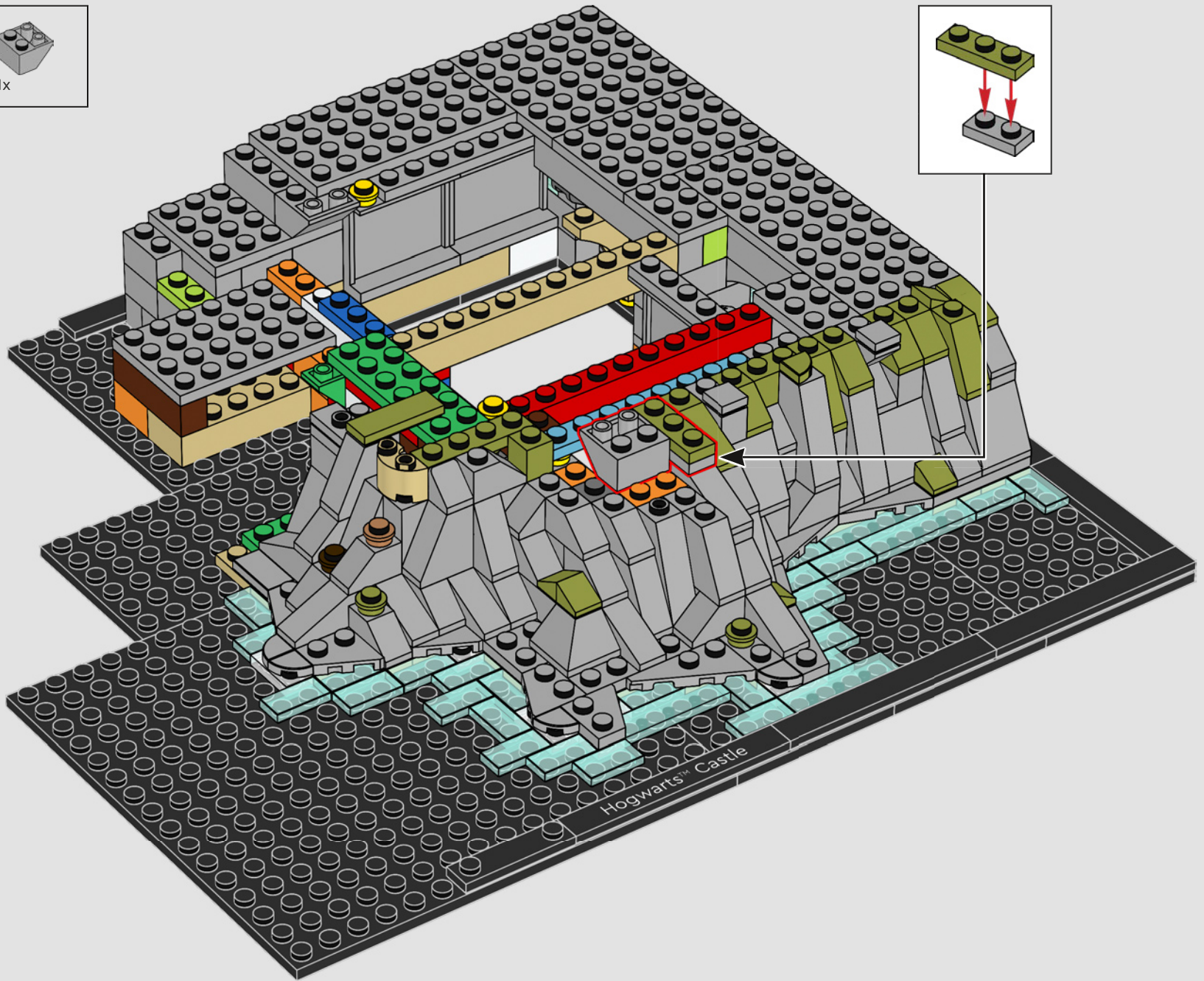

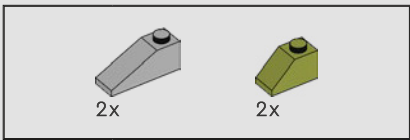

129

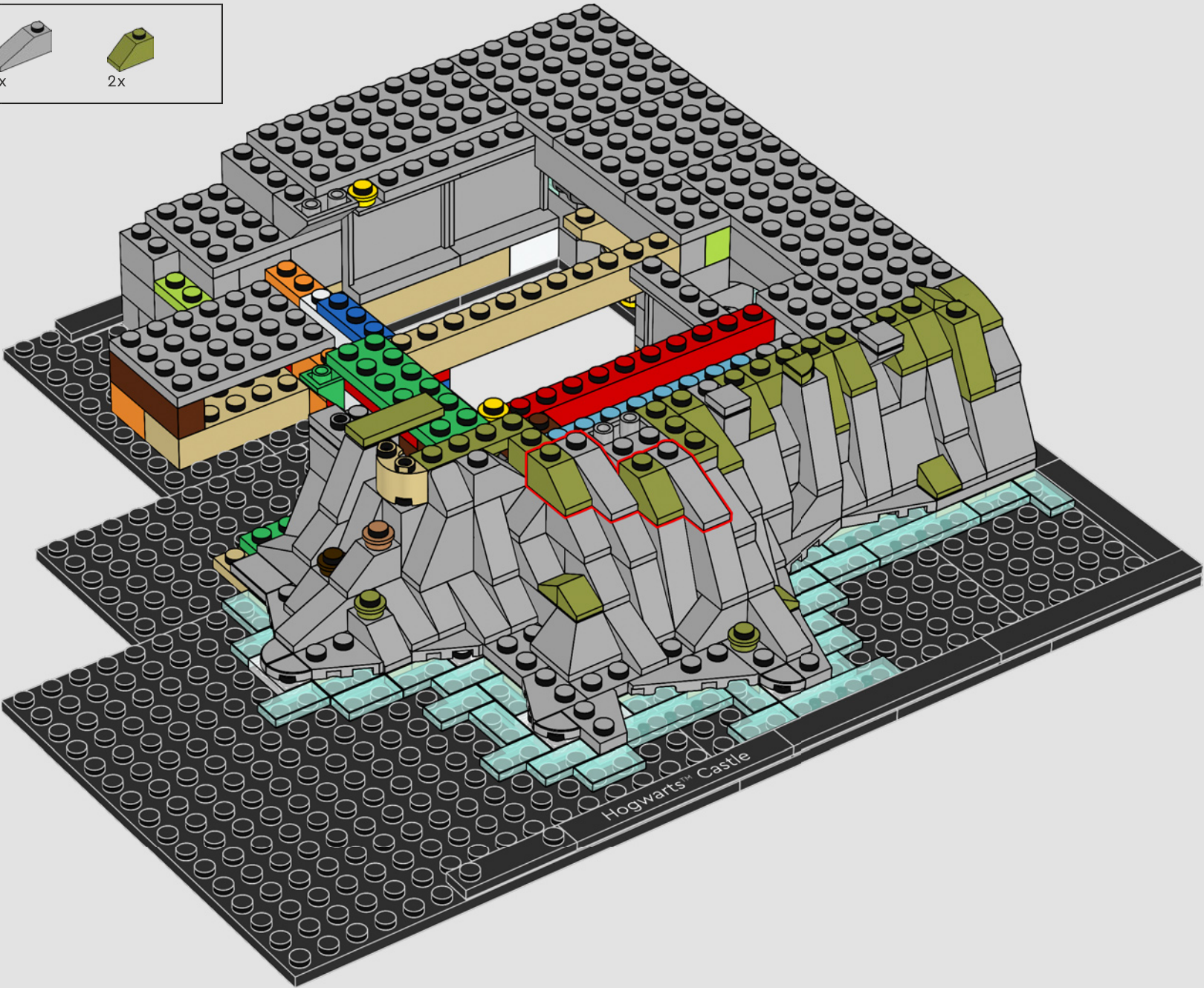



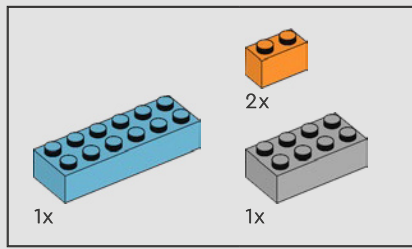

130

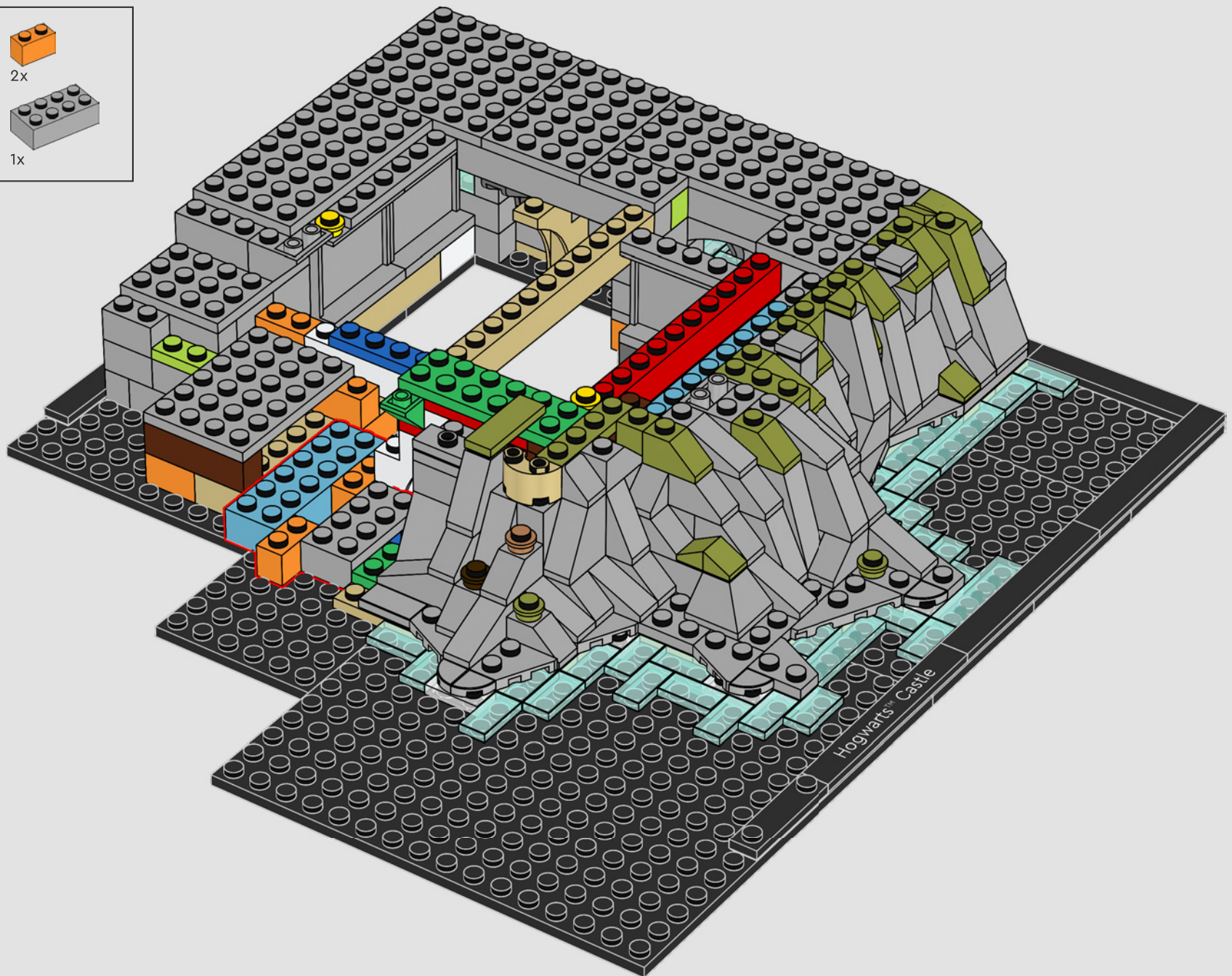

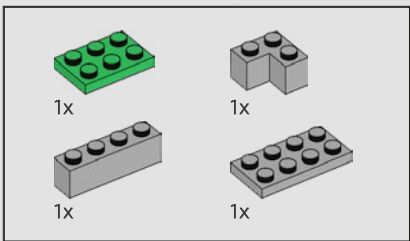

131

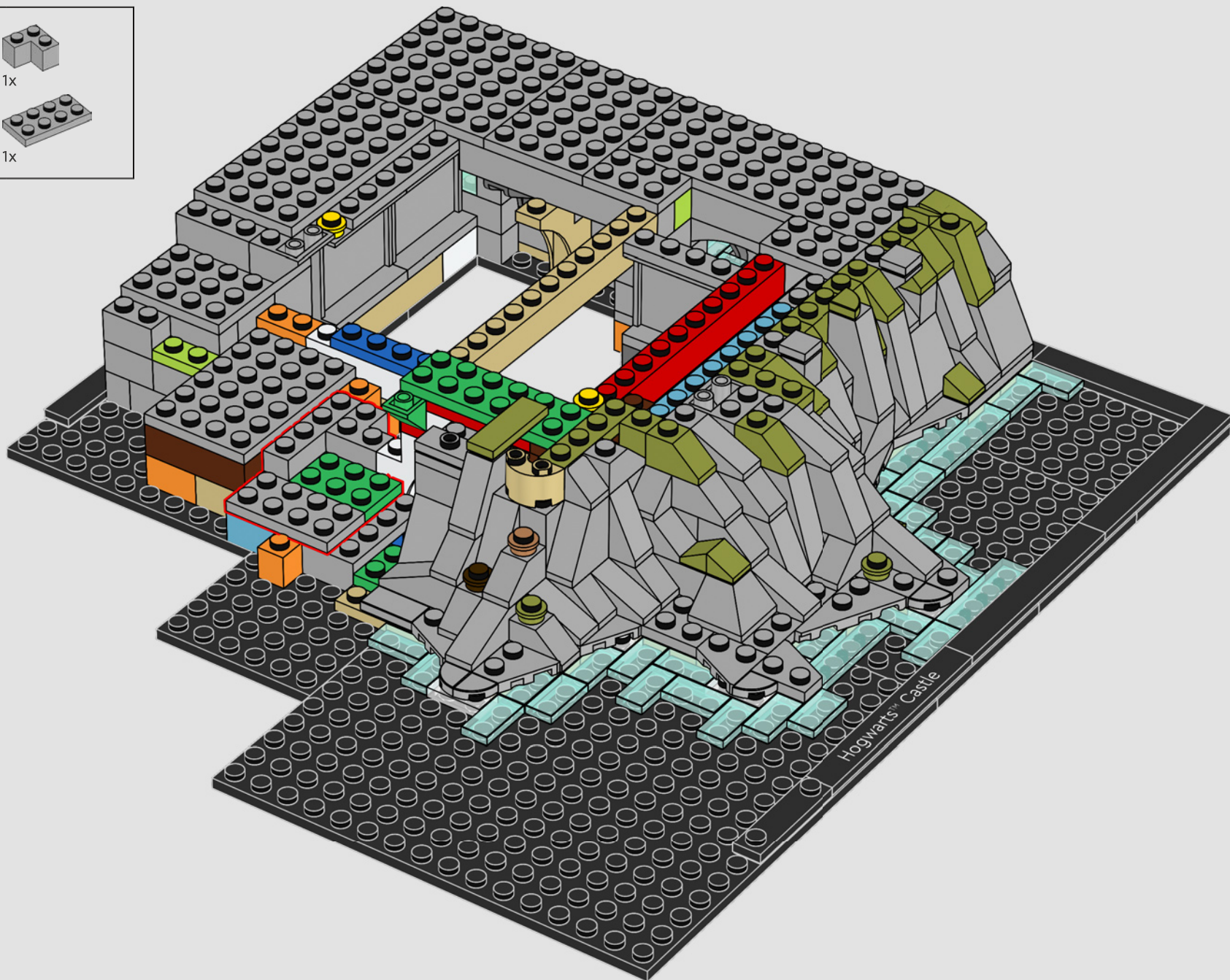



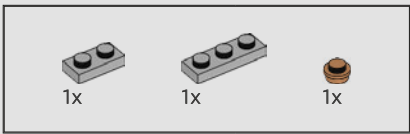

132

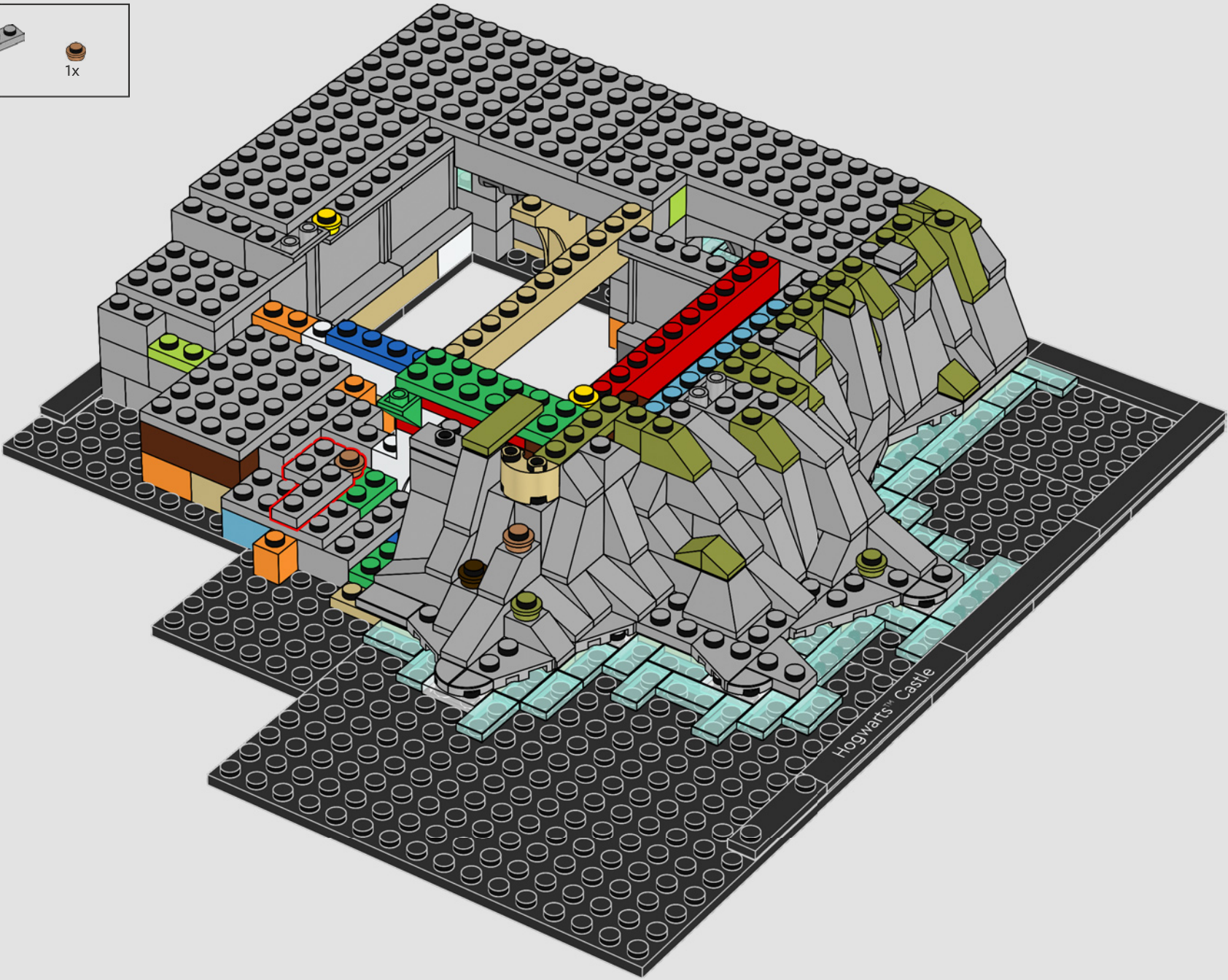

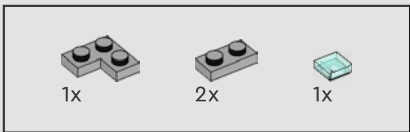

133

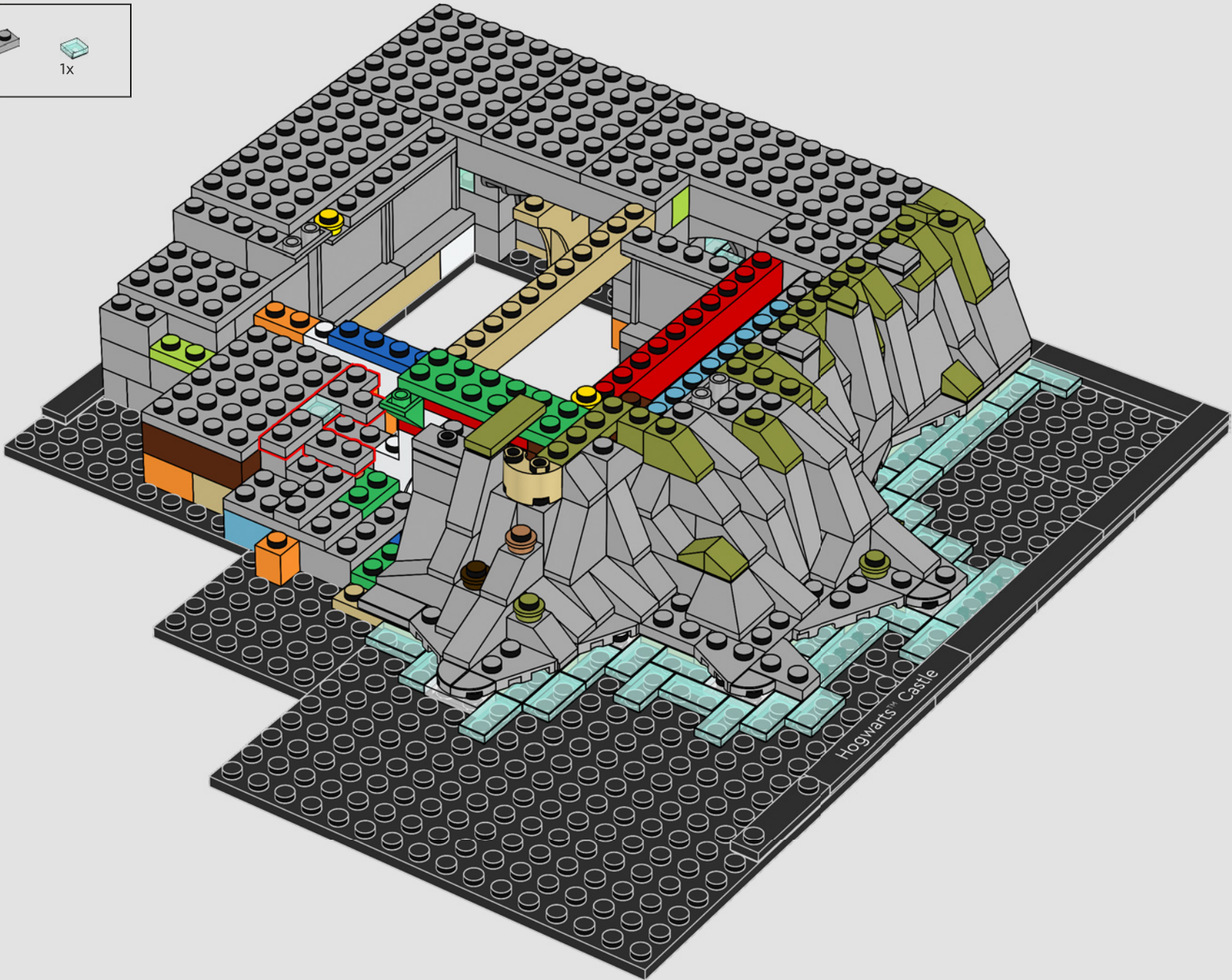

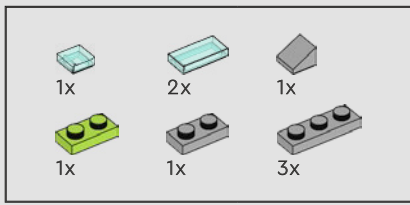

134

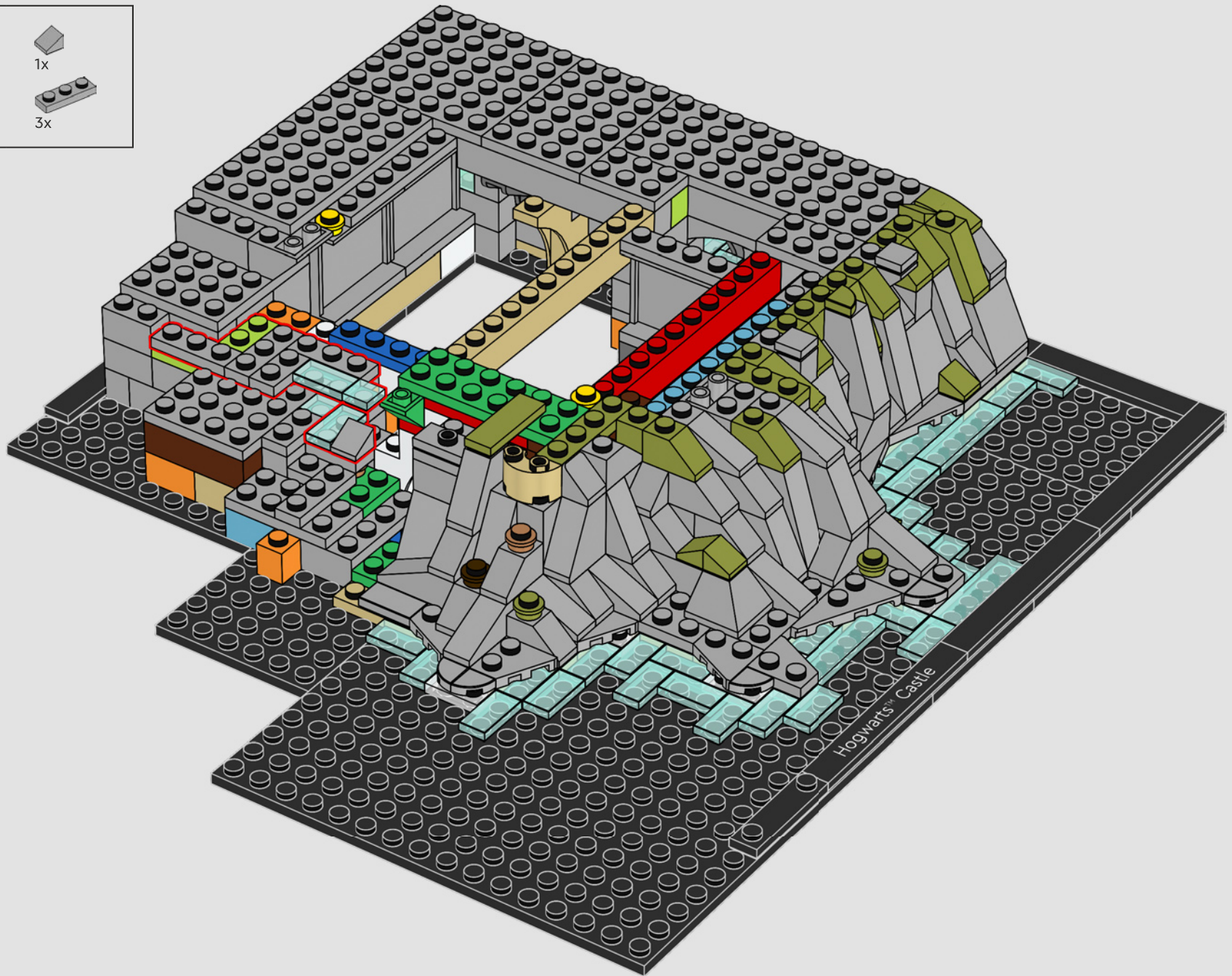

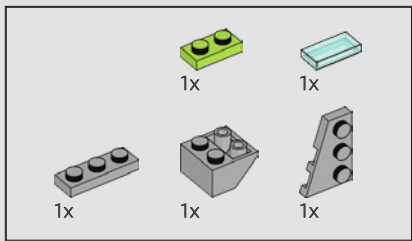

135

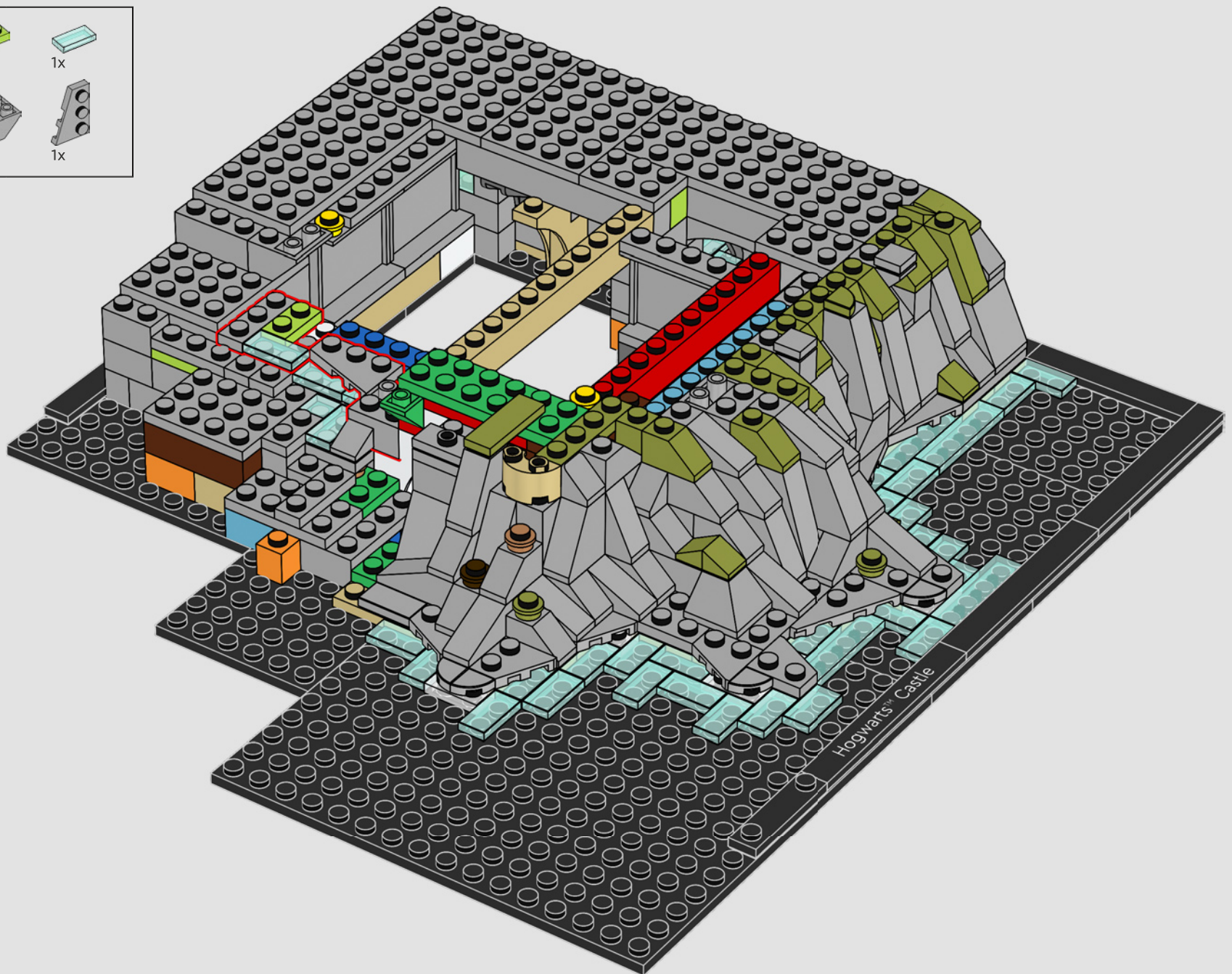

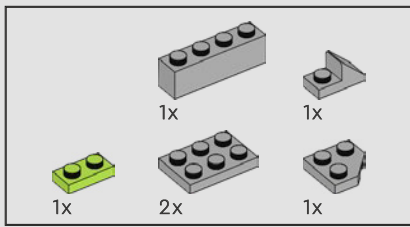

136

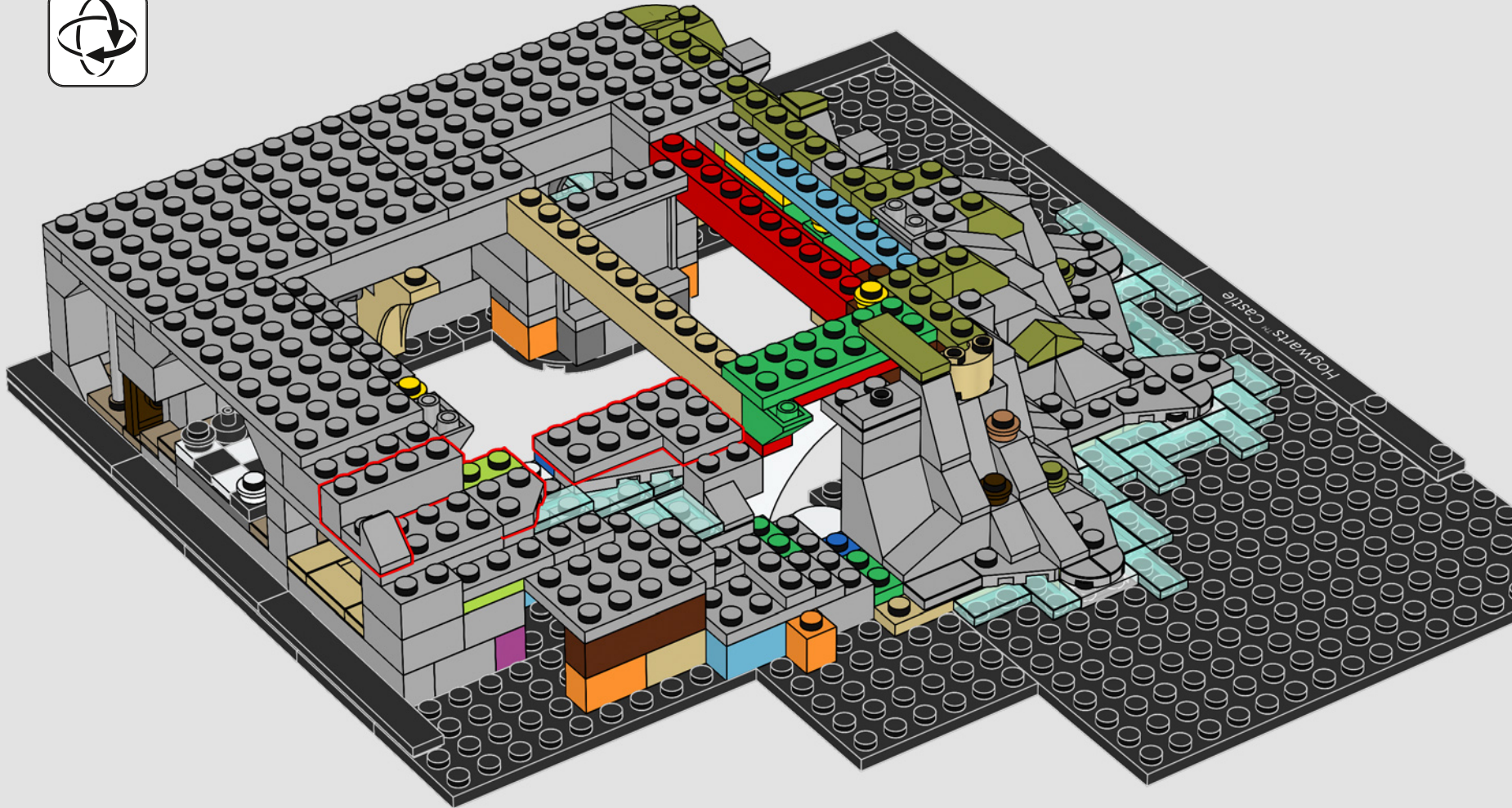

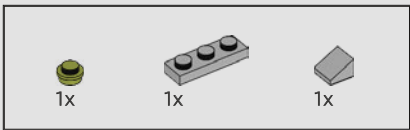

137

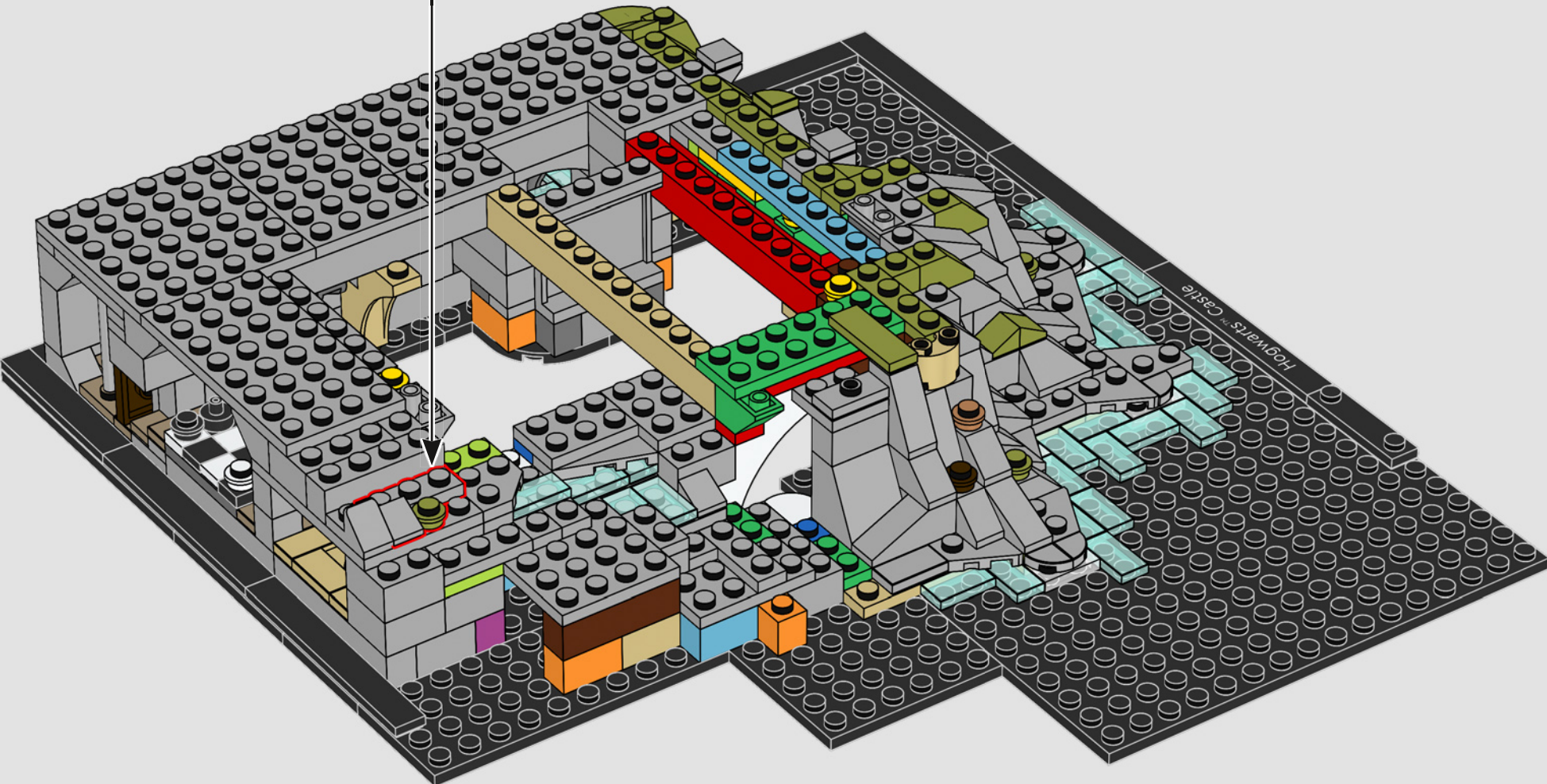
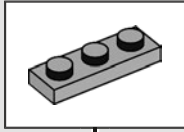

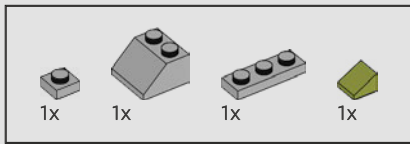

138

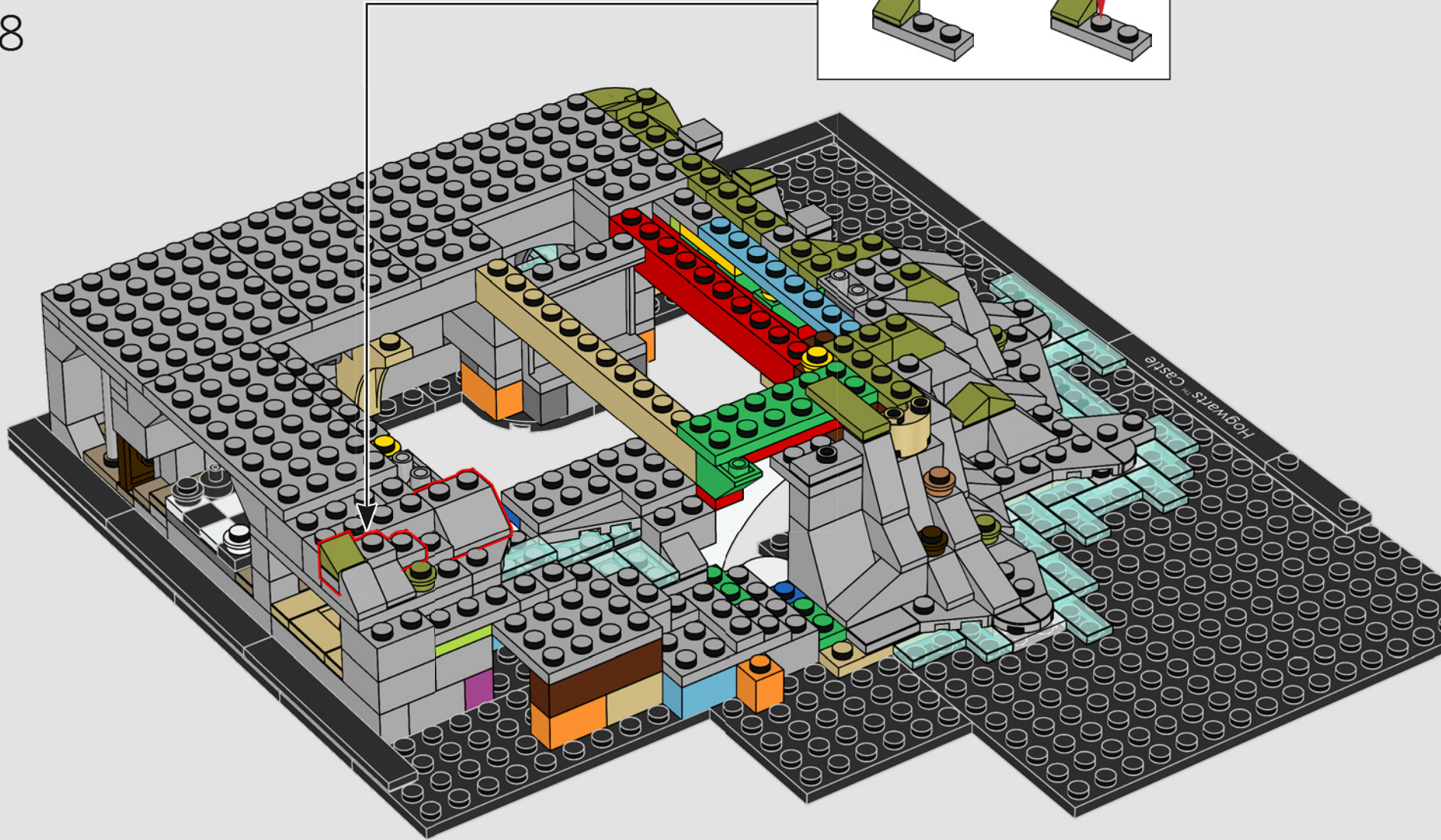
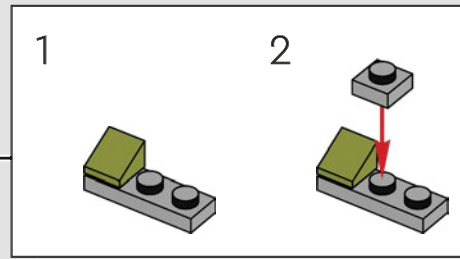

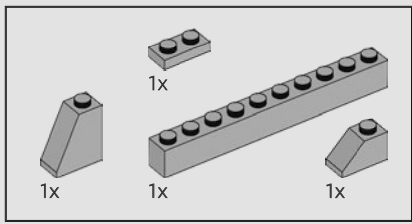

139

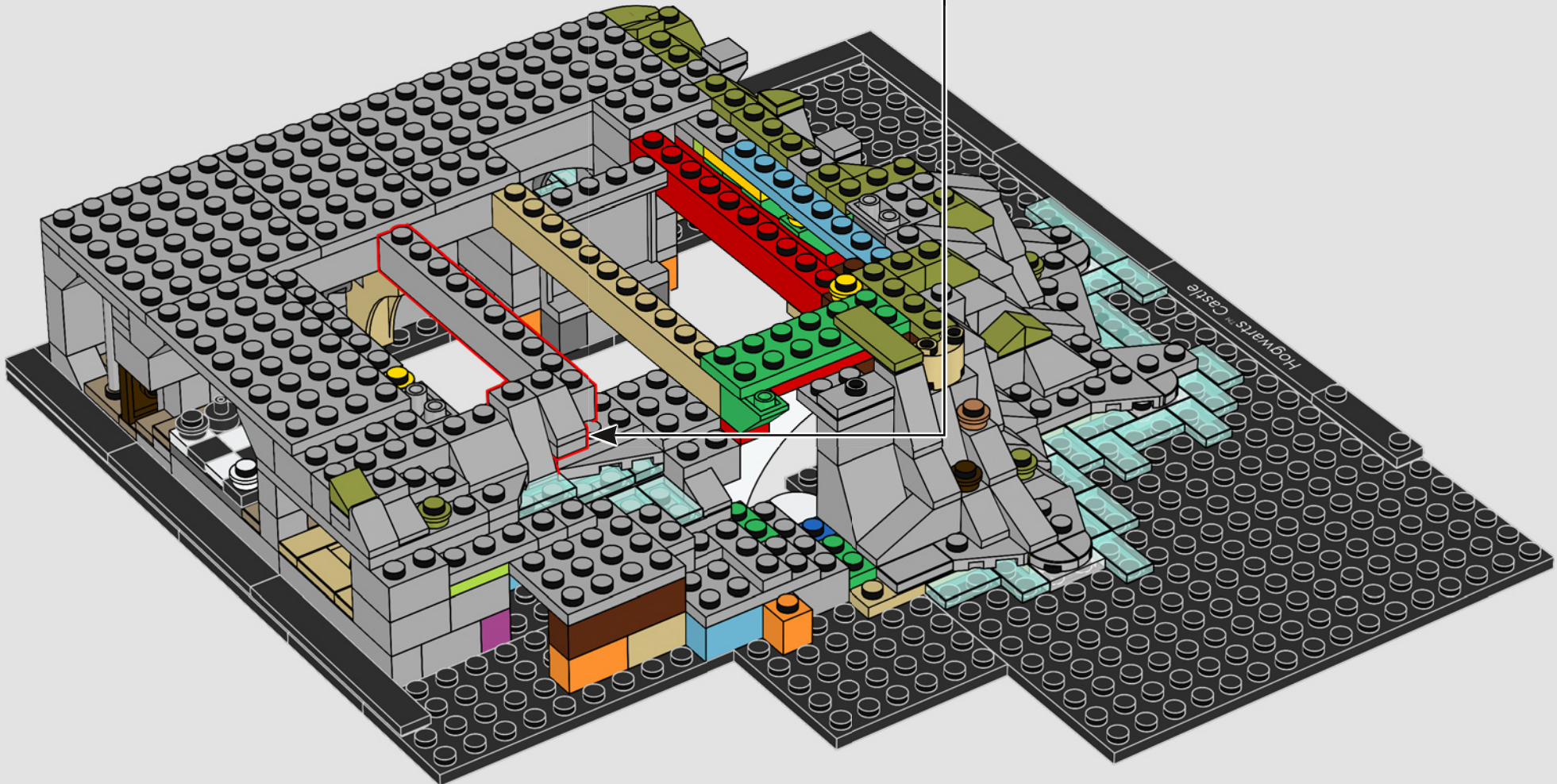
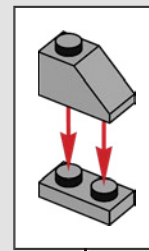



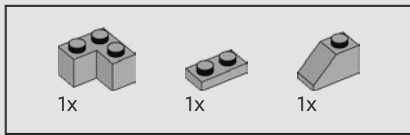

140

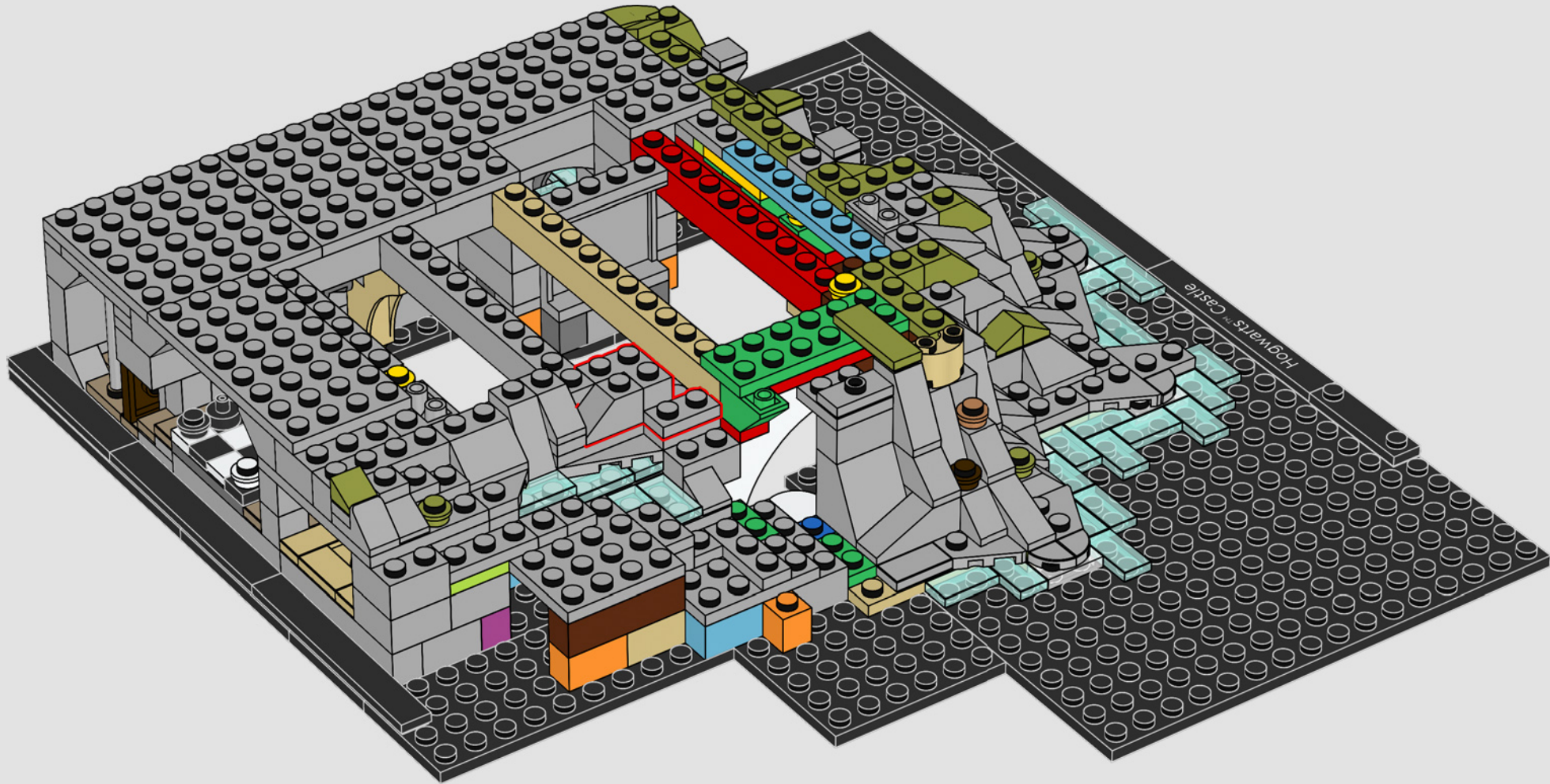

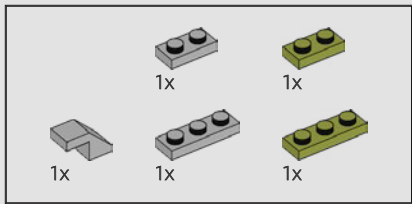

141

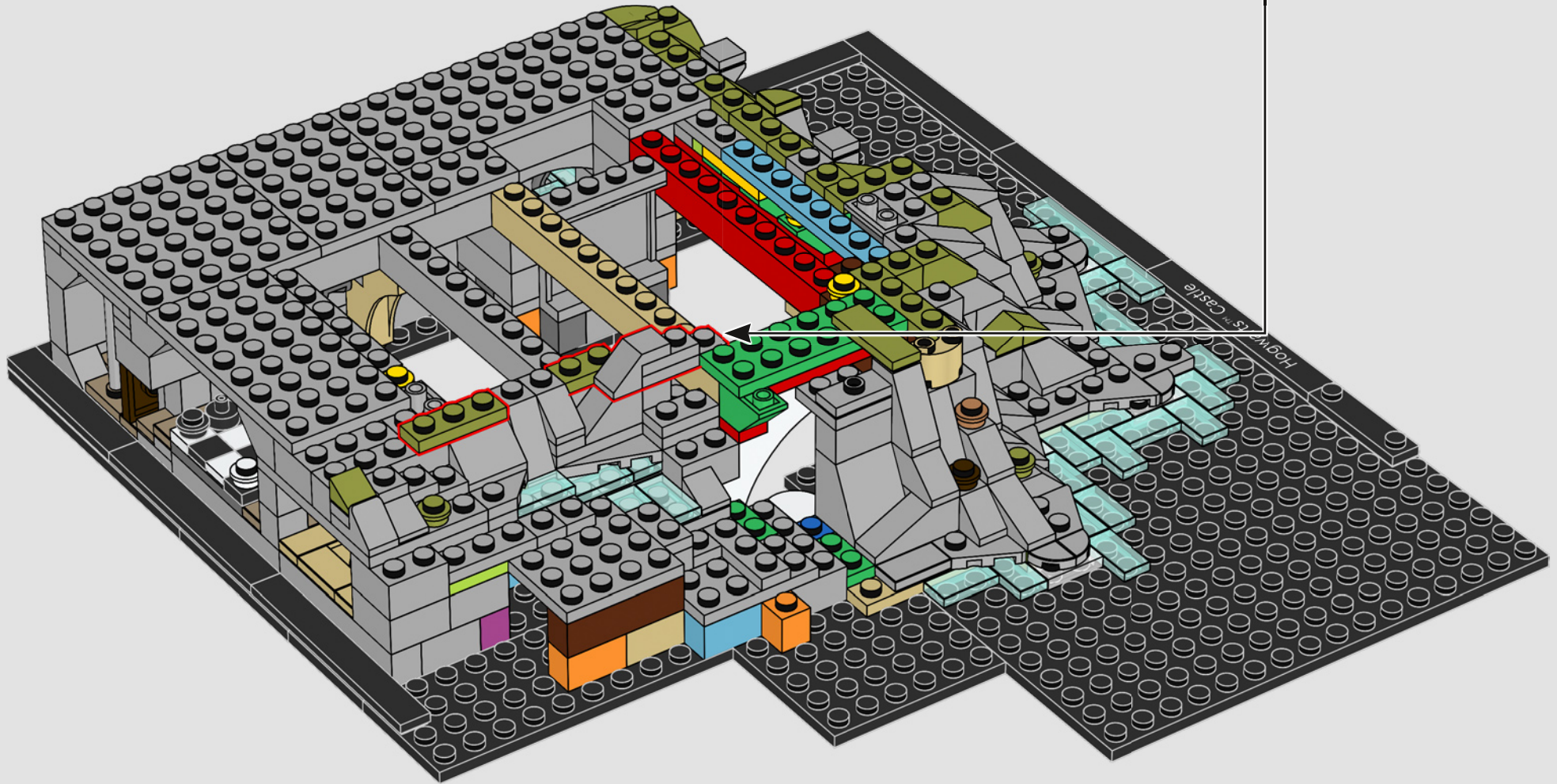
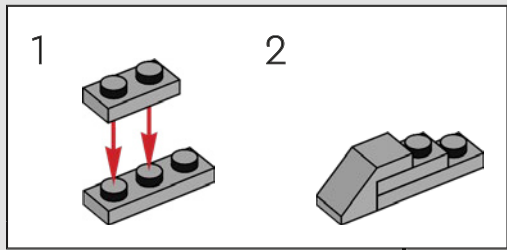

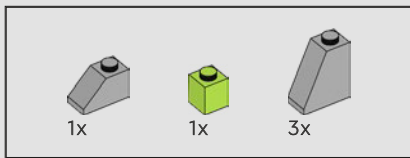

142

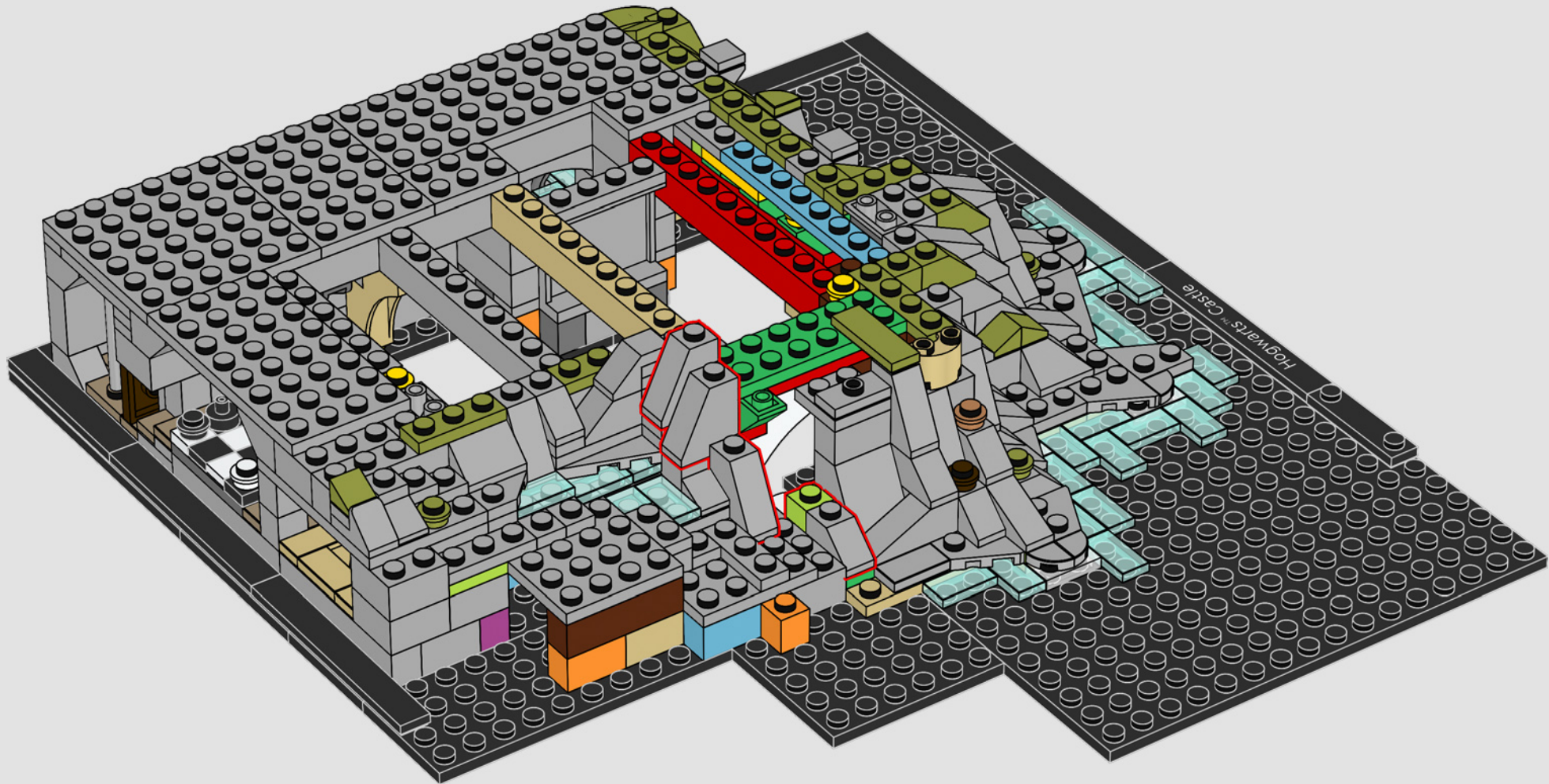

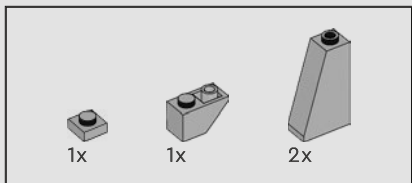

143

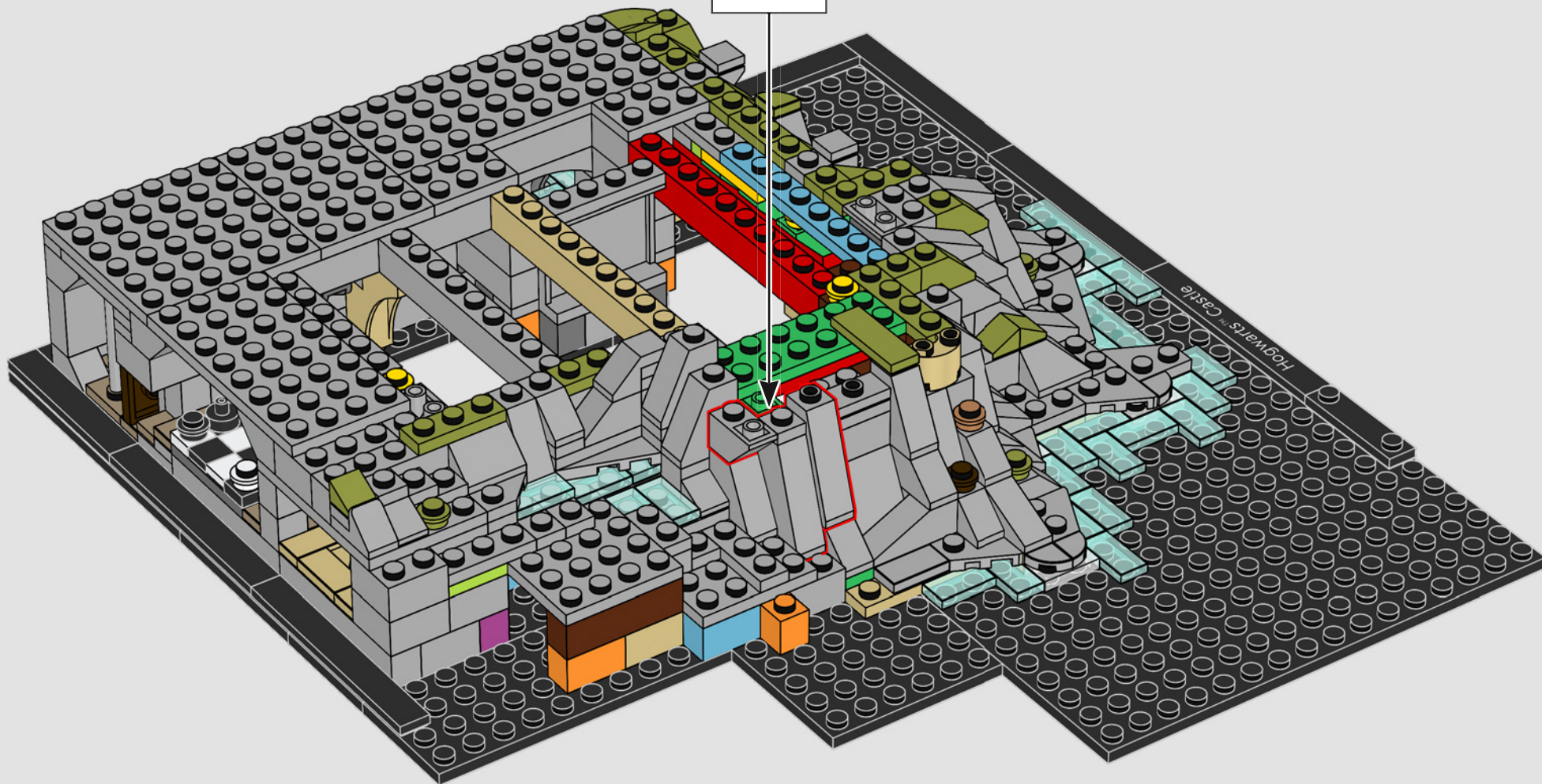
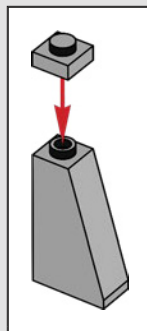

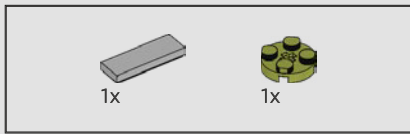

144

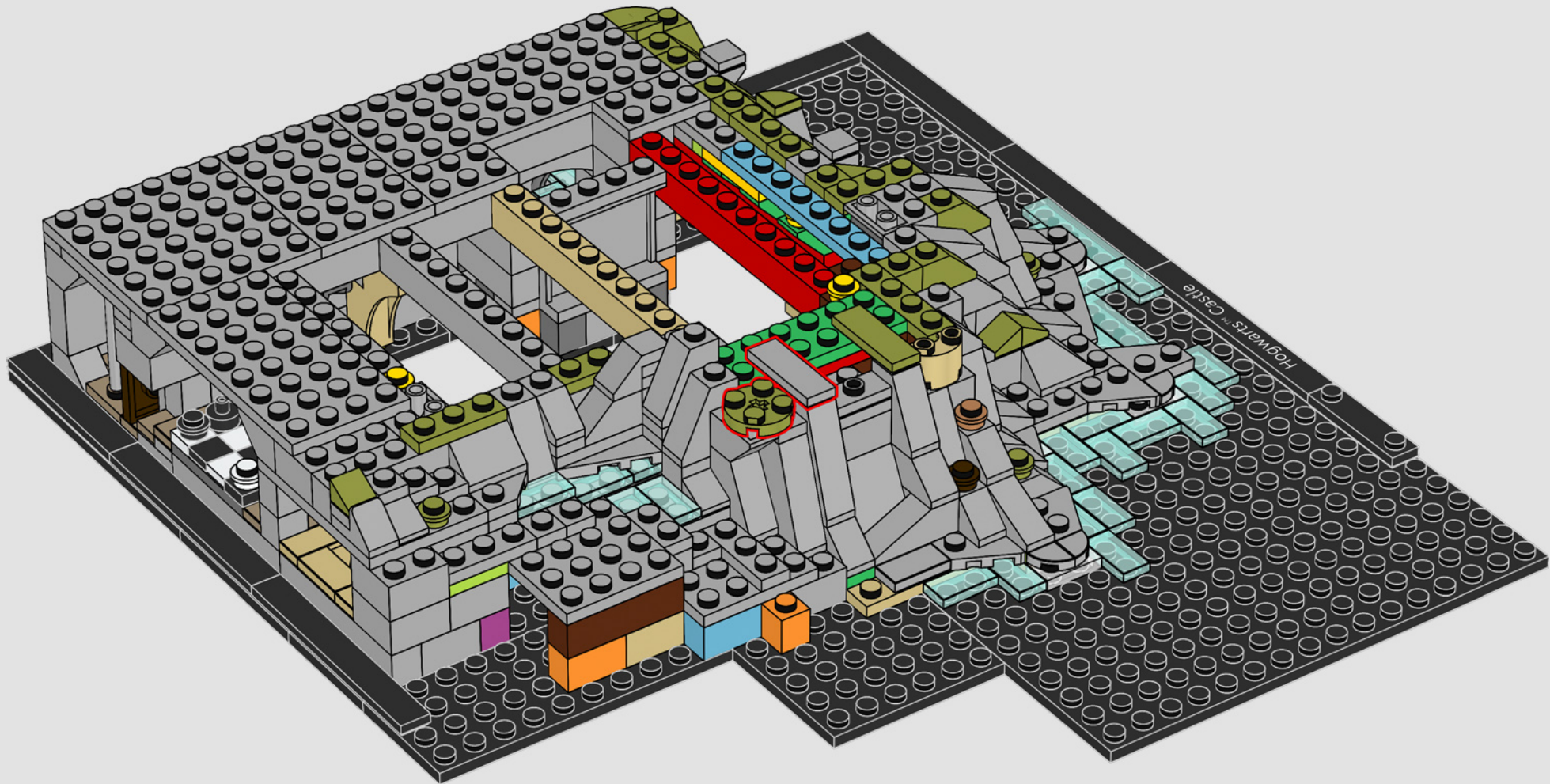

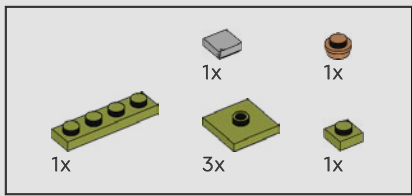

145

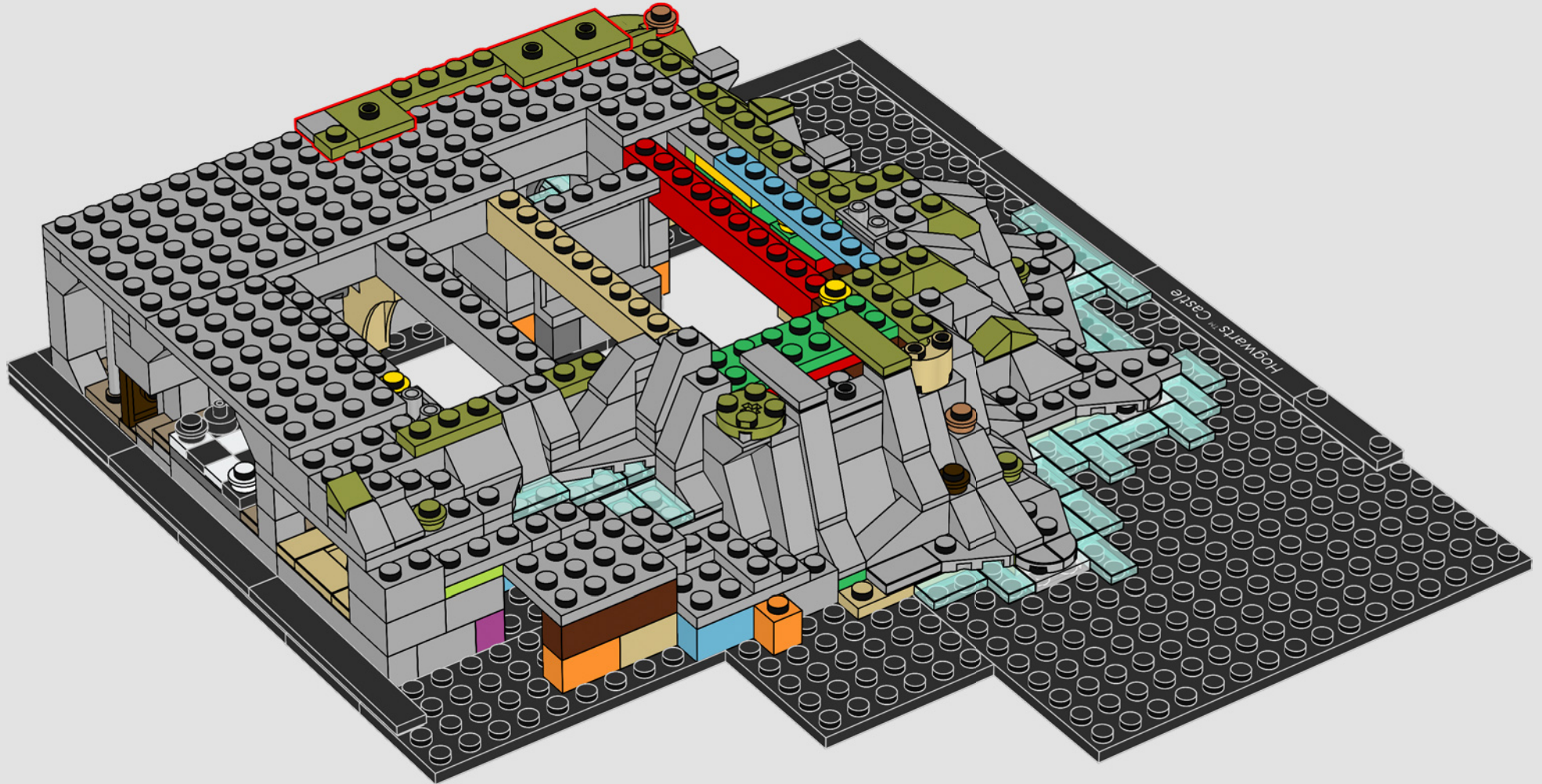

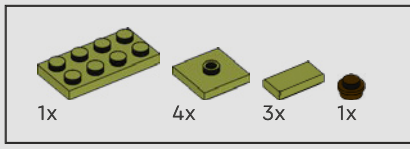

146

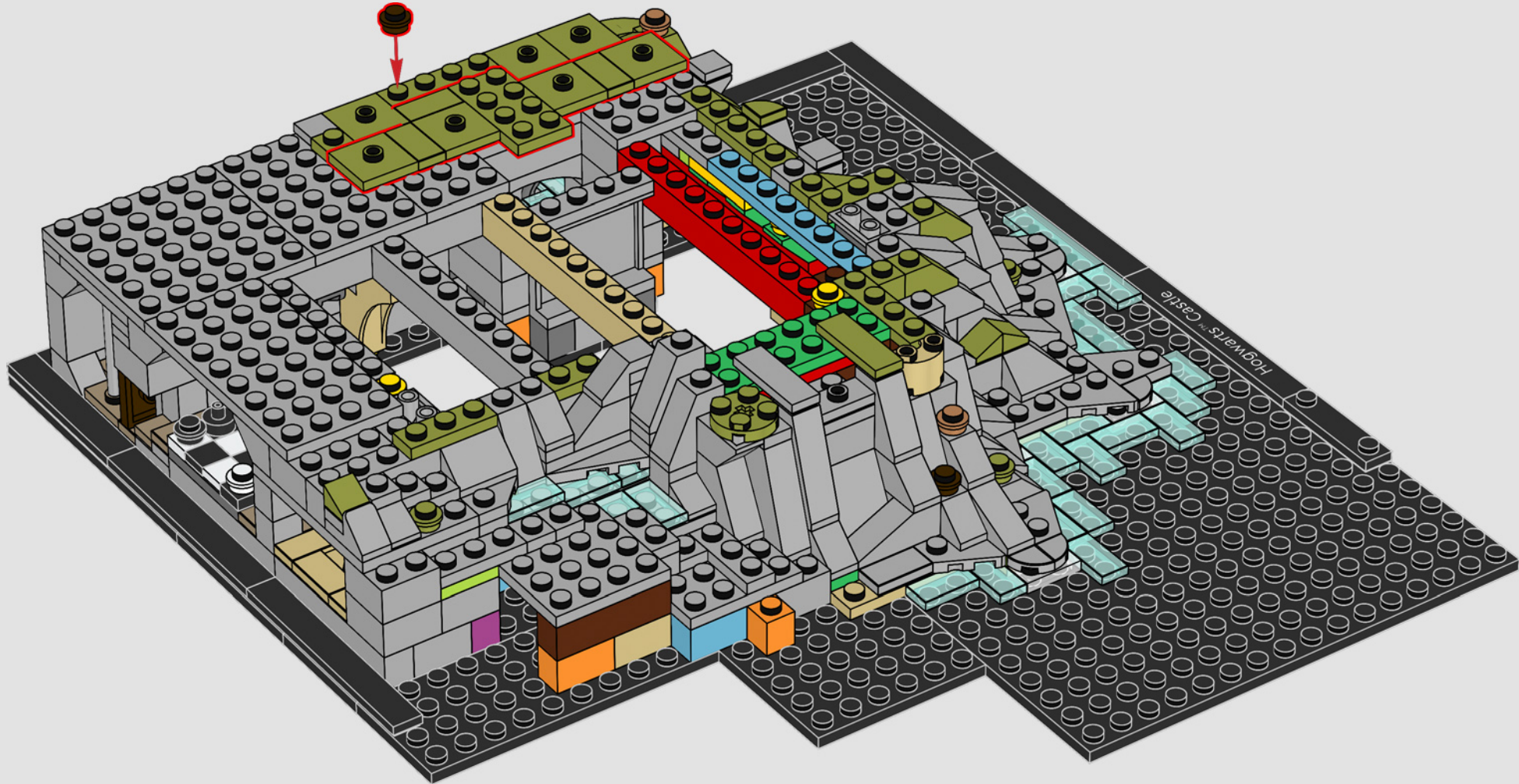

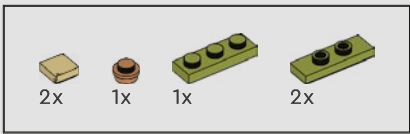

147

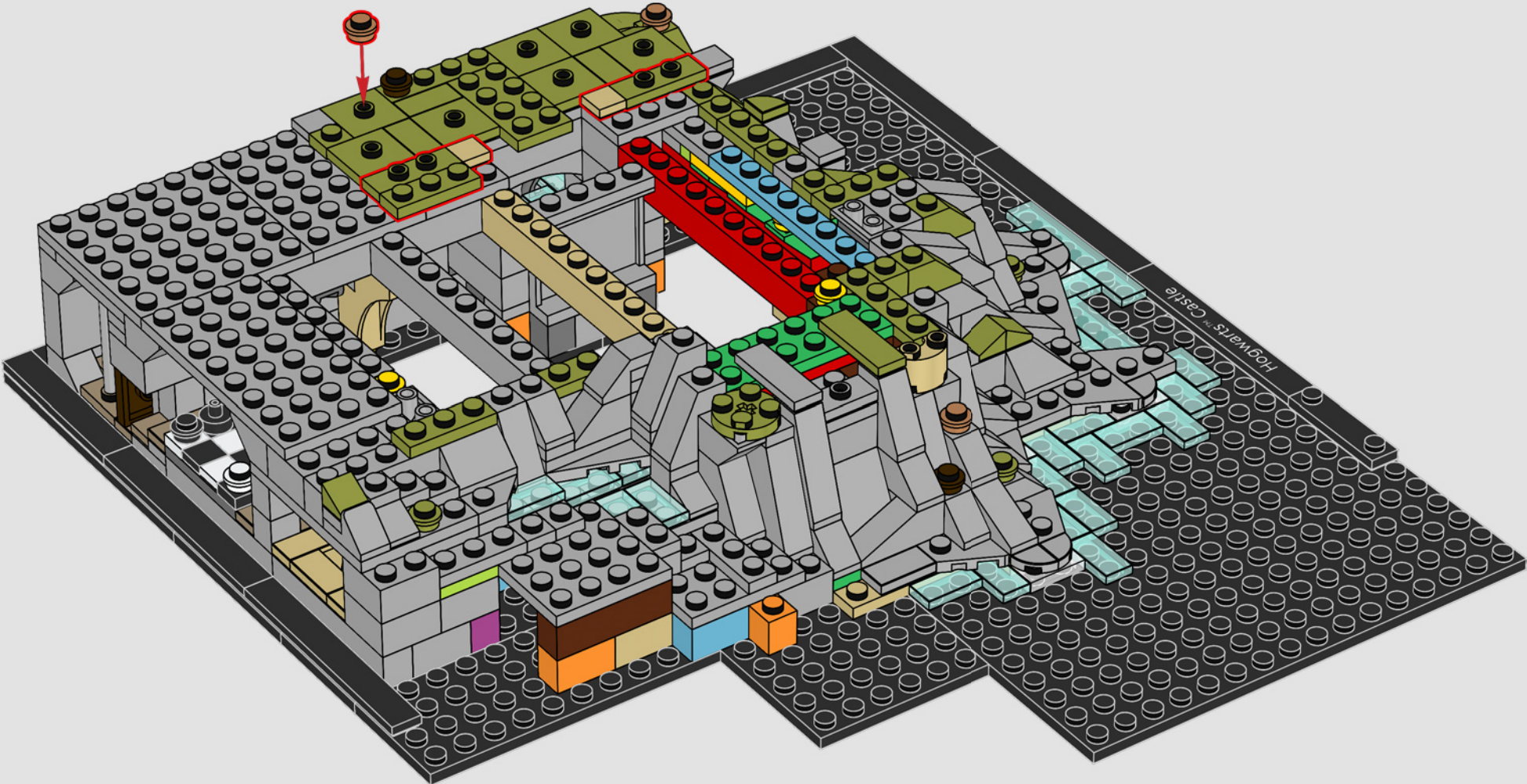



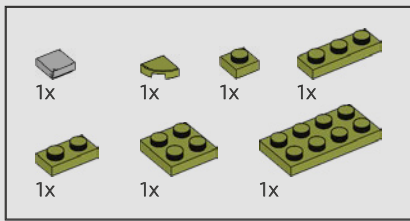

148

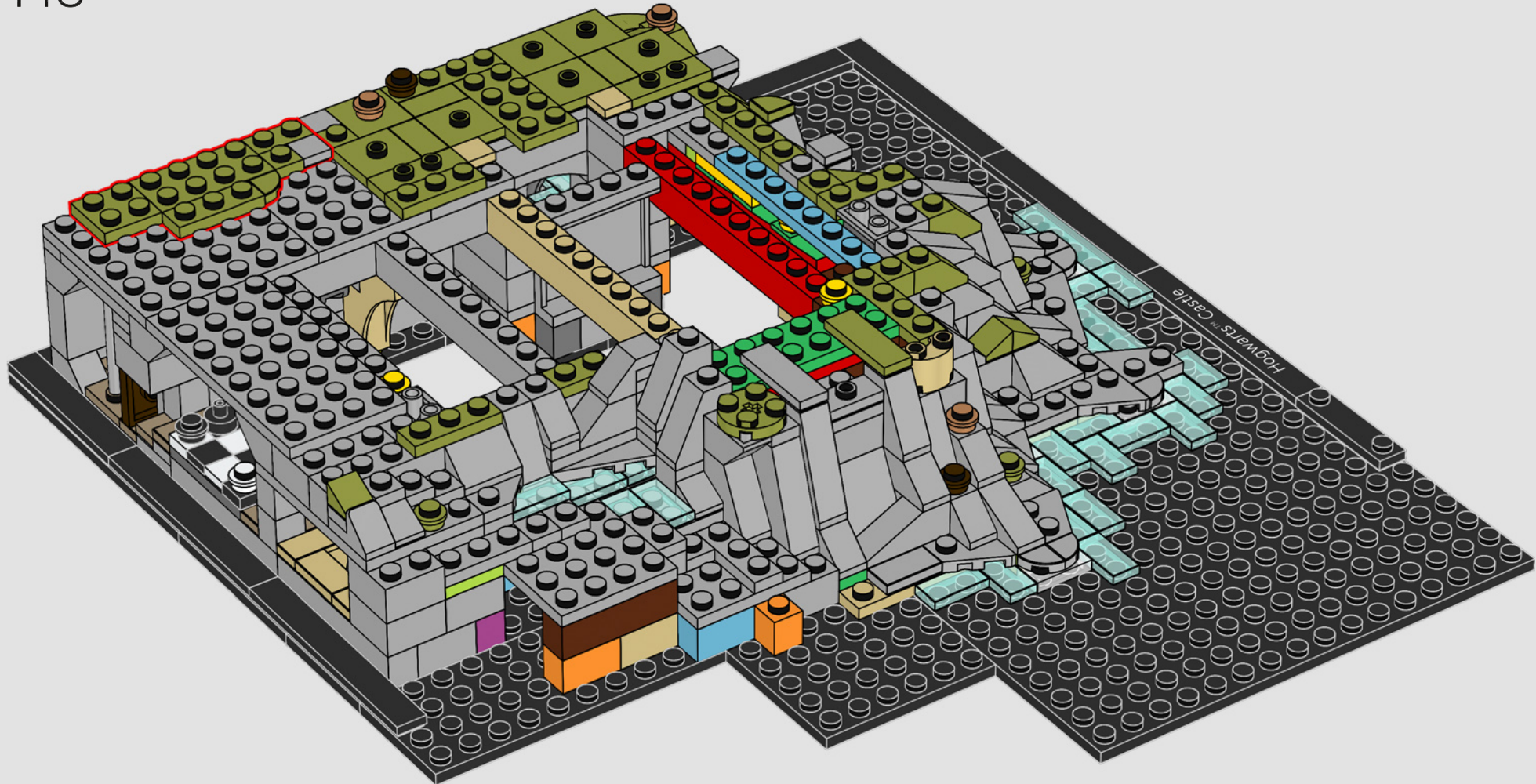

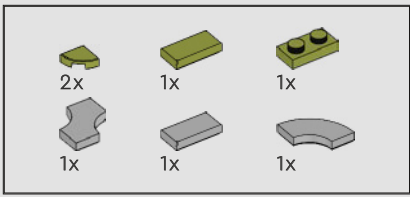

149

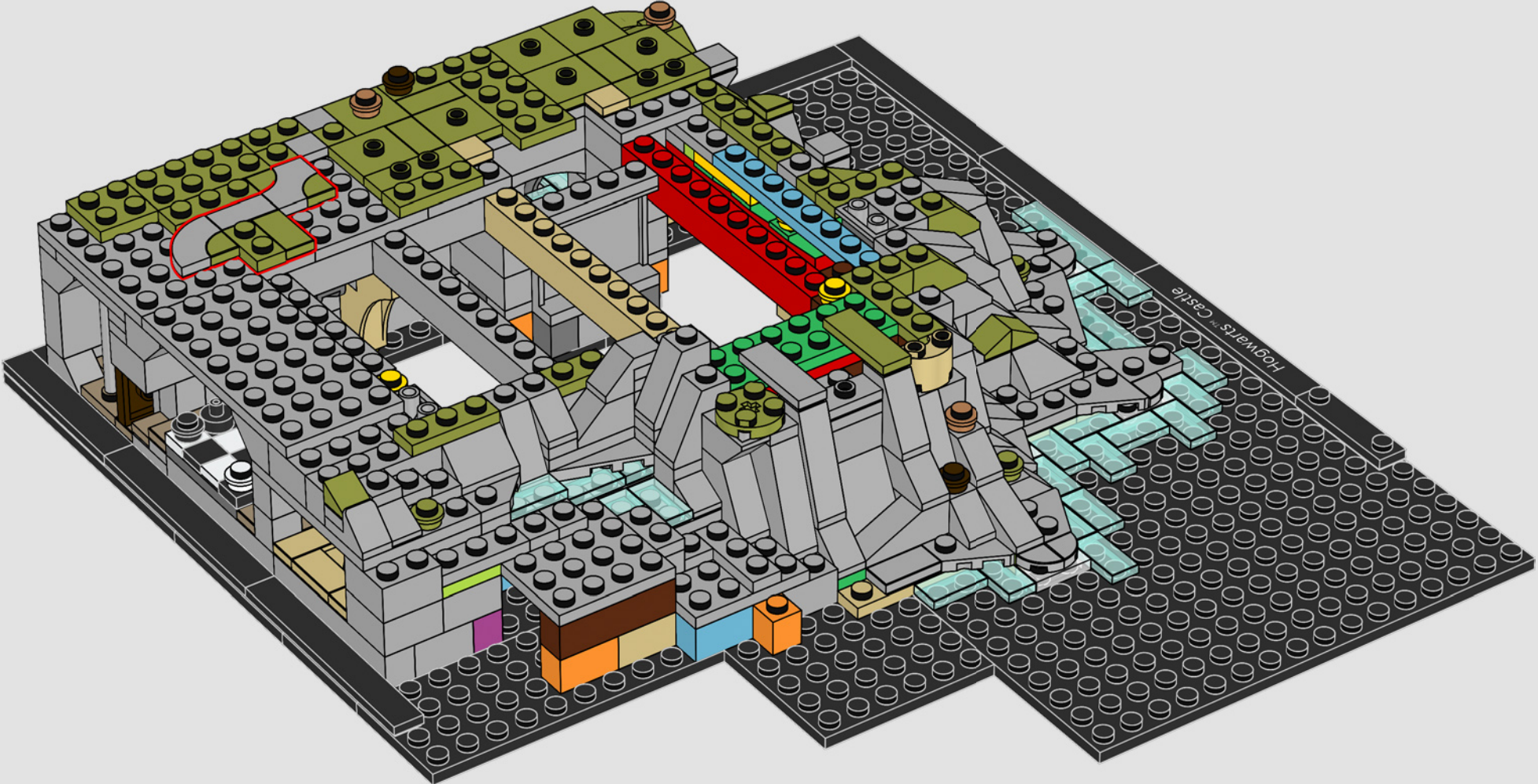

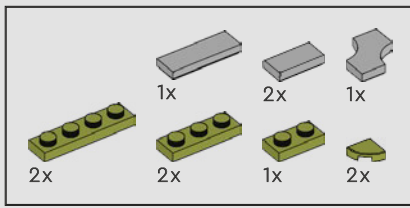

150

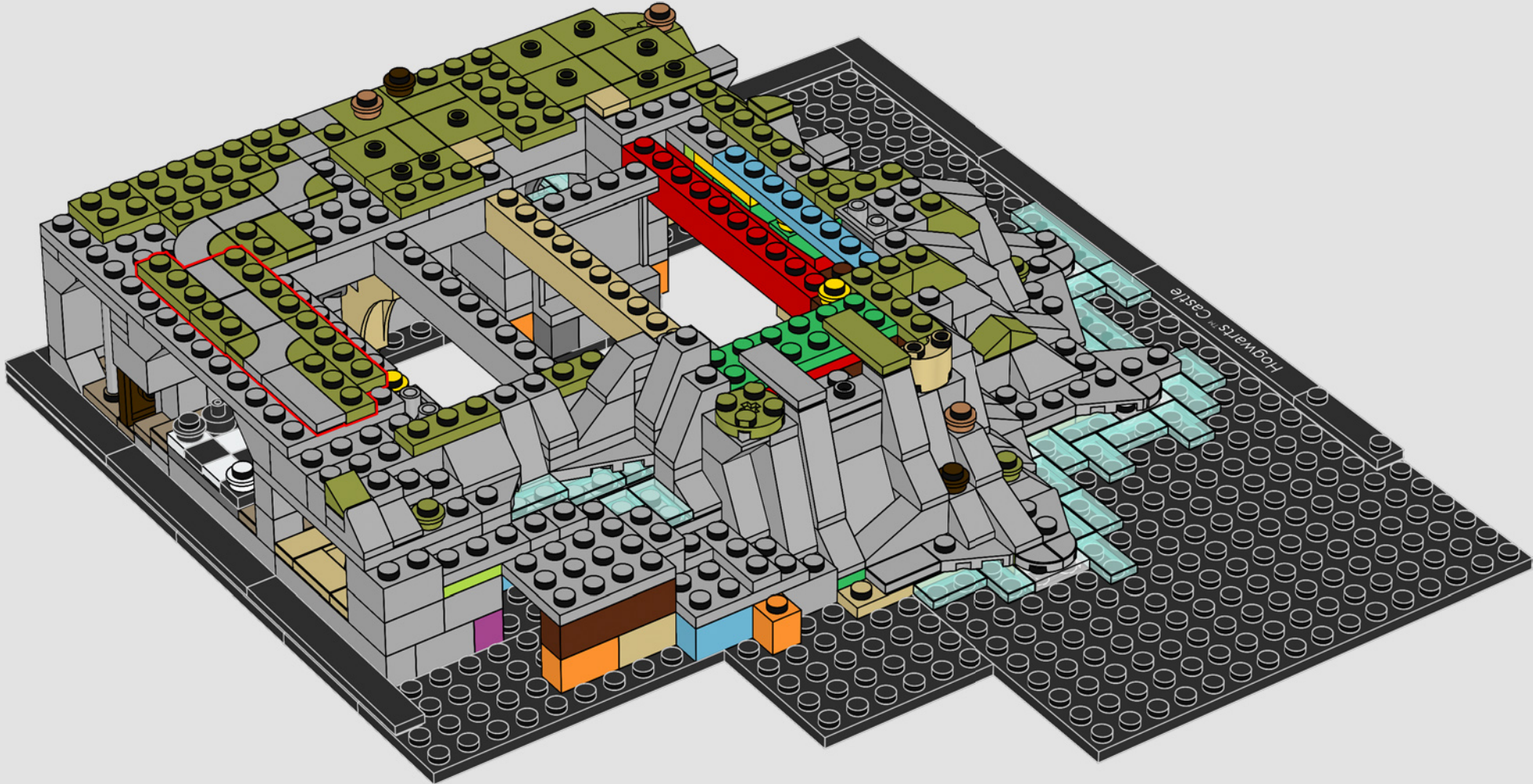

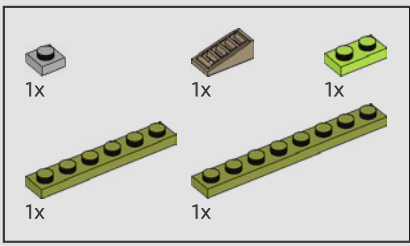

151

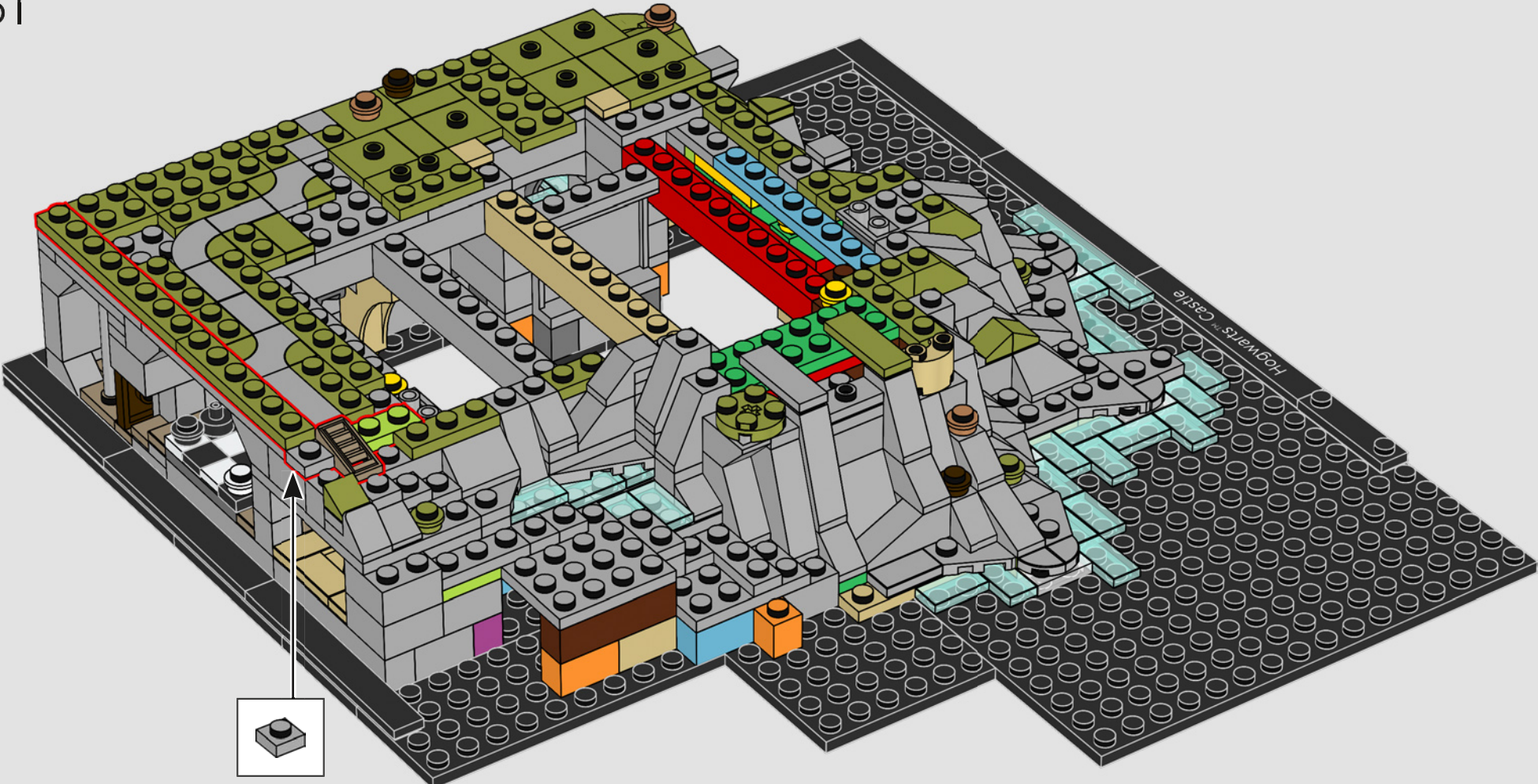

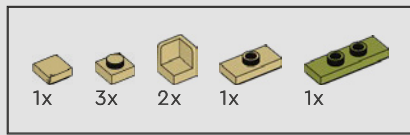

152

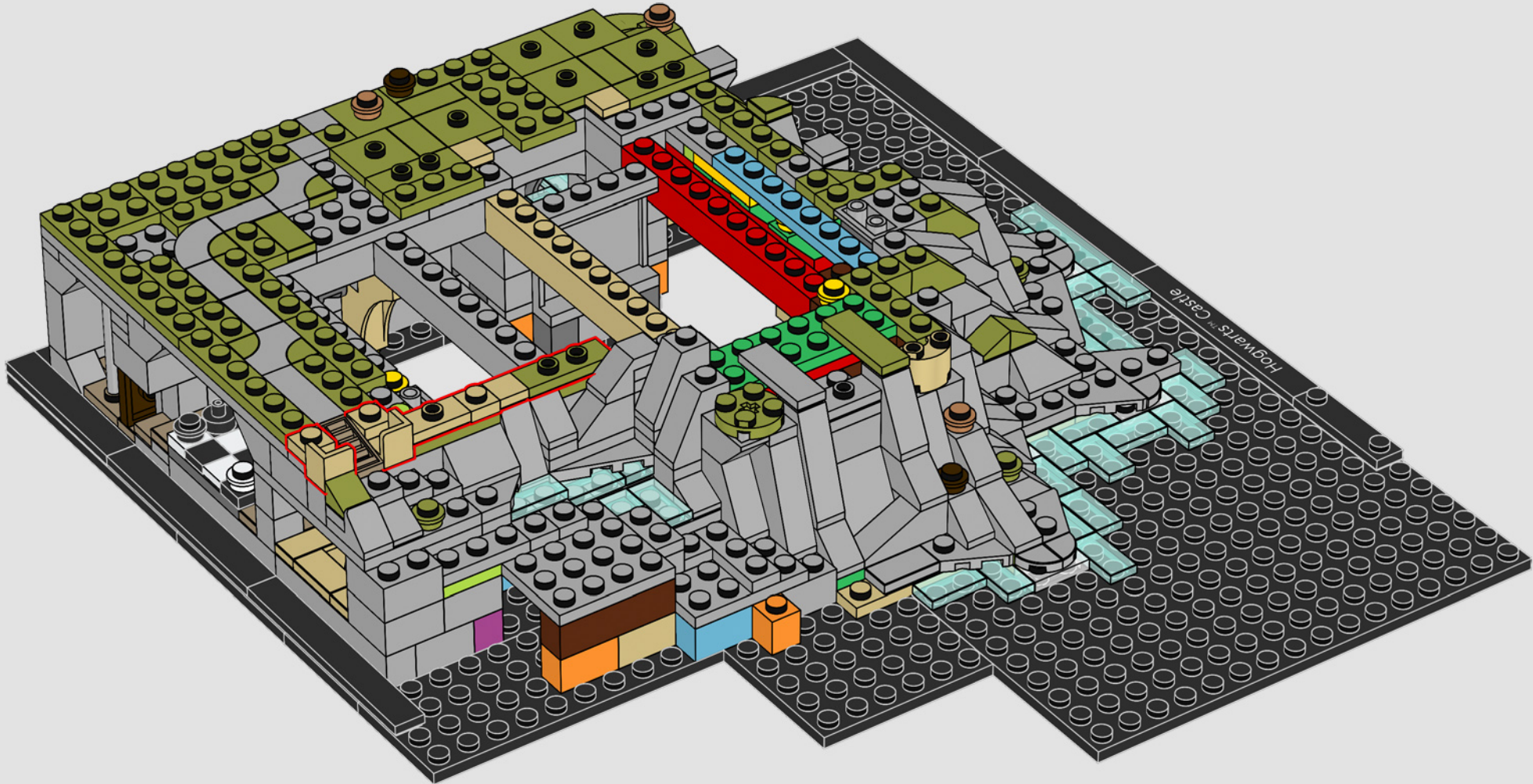

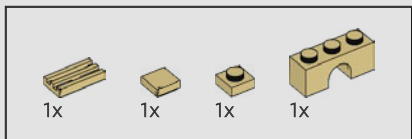

153

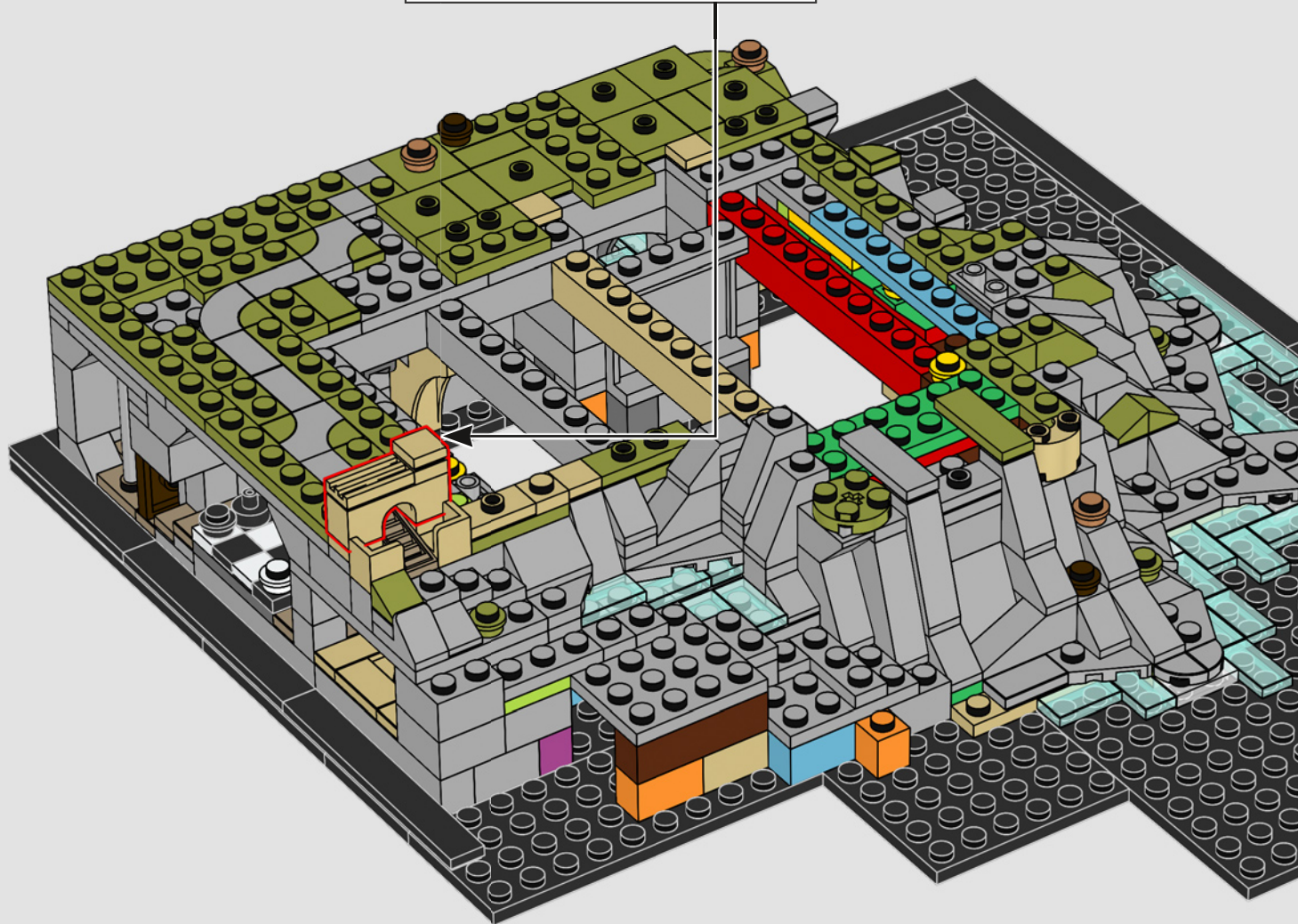
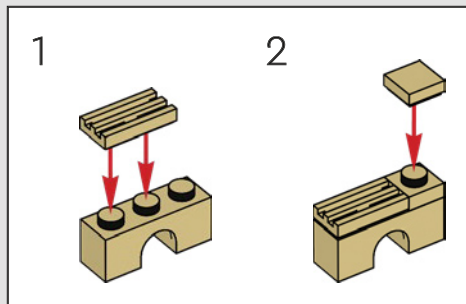

The four Houses represented bravery and determination (Gryffindor™), wisdom and wit (Ravenclaw™), loyalty and dedication (Hufflepuff™) and the values of being ambitious and cunning (Slytherin™).

Les quatre maisons représentent le courage et la détermination (Gryffondor), la sagesse et l'esprit (Serdaigle), la loyauté et le dévouement (Poufsouffle) et l'ambition et la ruse (Serpentard).

Las cuatro casas representaban la valentía y la determinación (Gryffindor™), la sabiduría y el ingenio (Ravenclaw™), la lealtad y la dedicación (Hufflepuff™) y los valores ligados a la ambición y la astucia (Slytherin™).





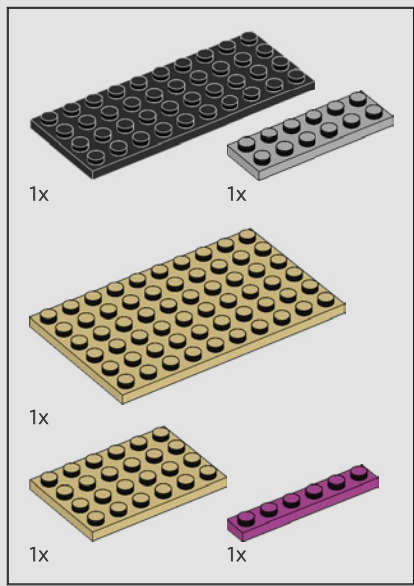

154





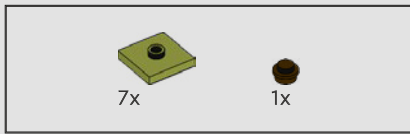

155

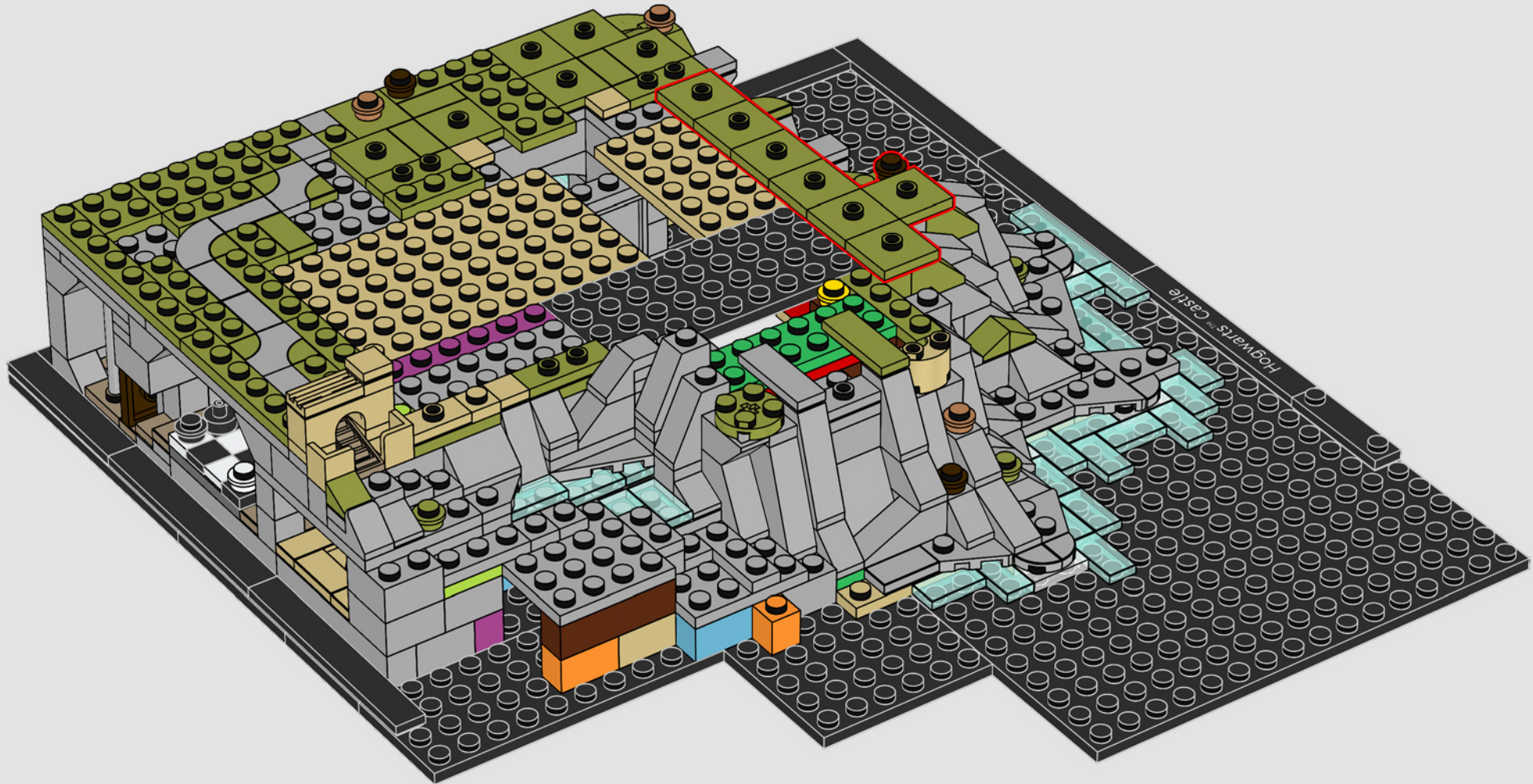

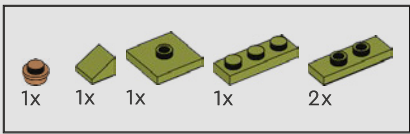

156

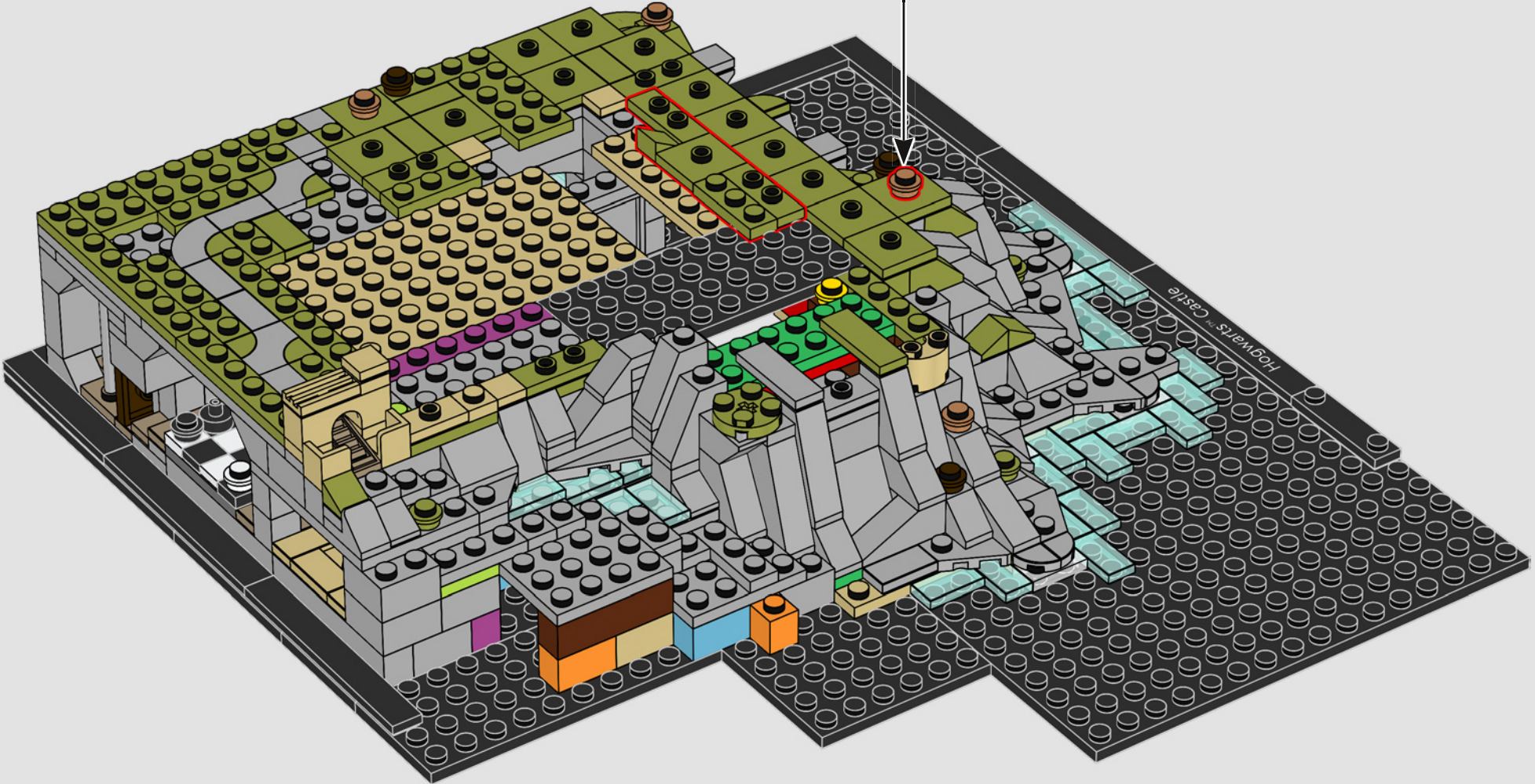

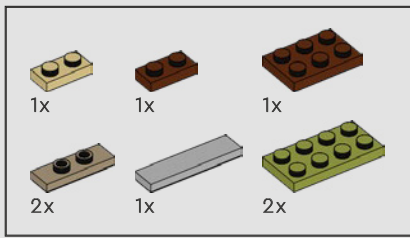

157

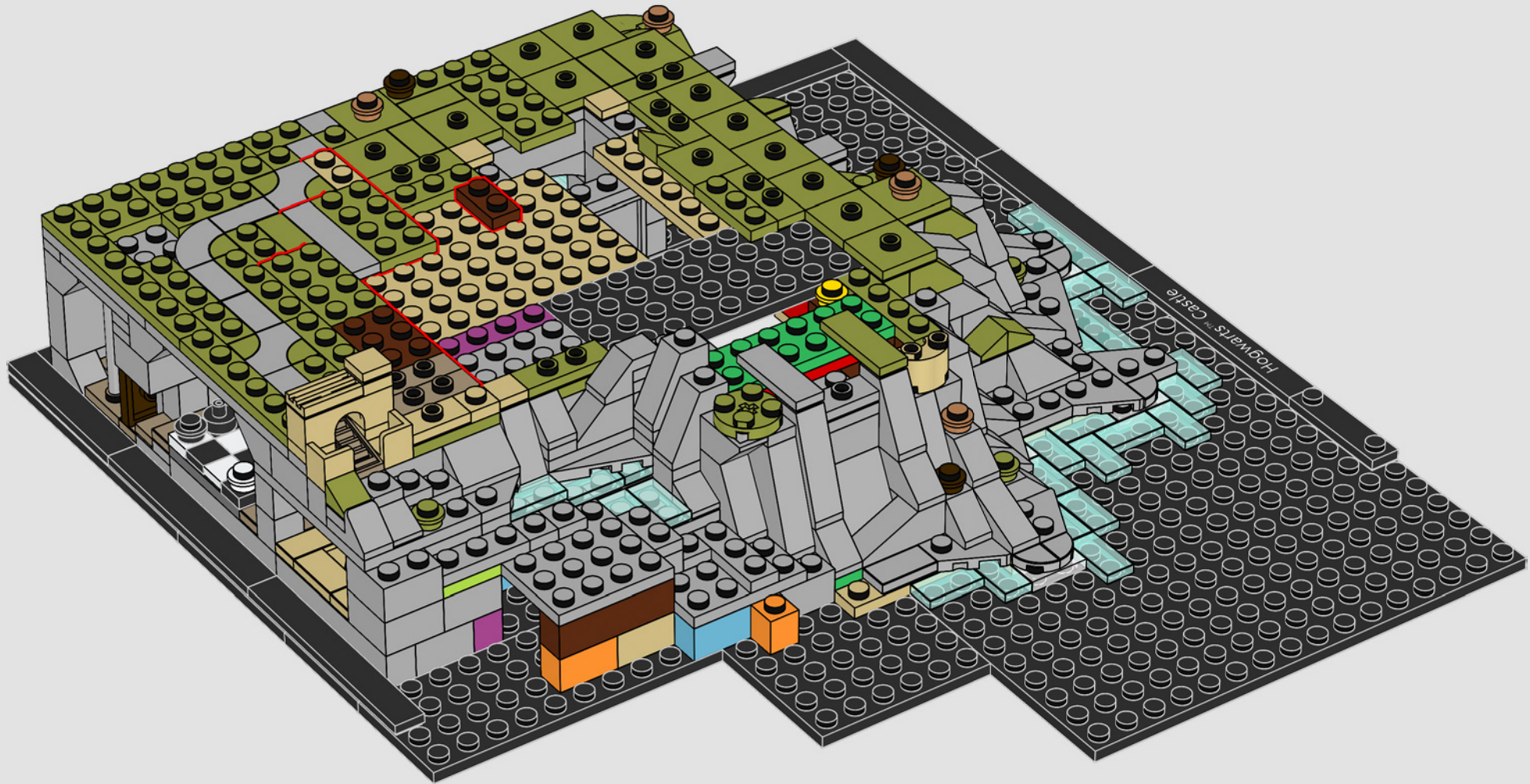

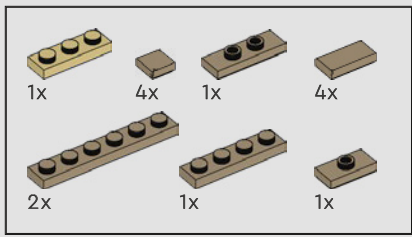

158



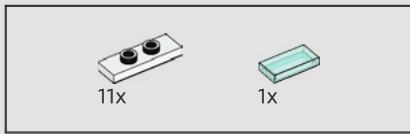

159

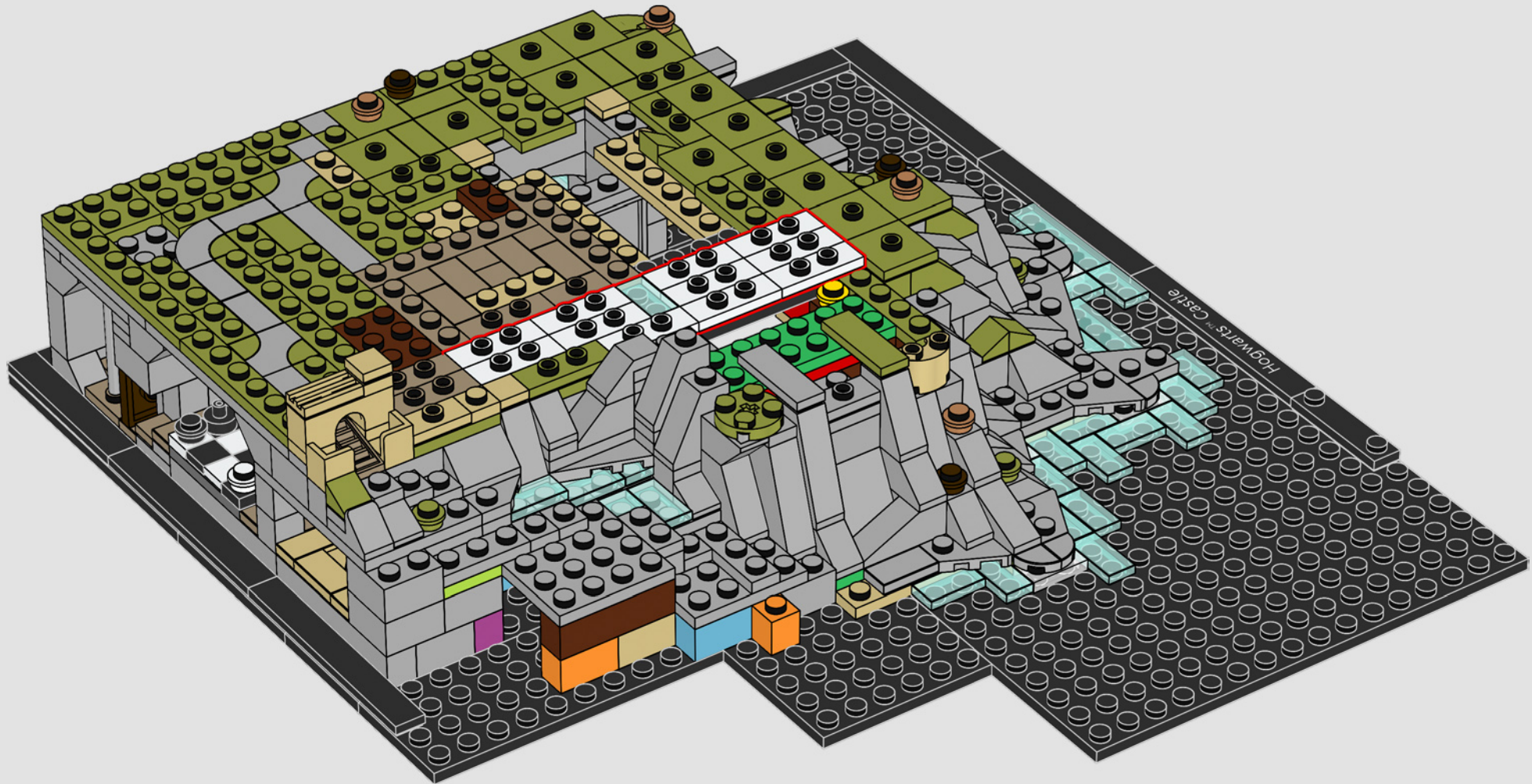

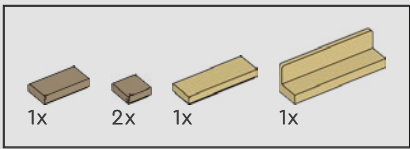

160

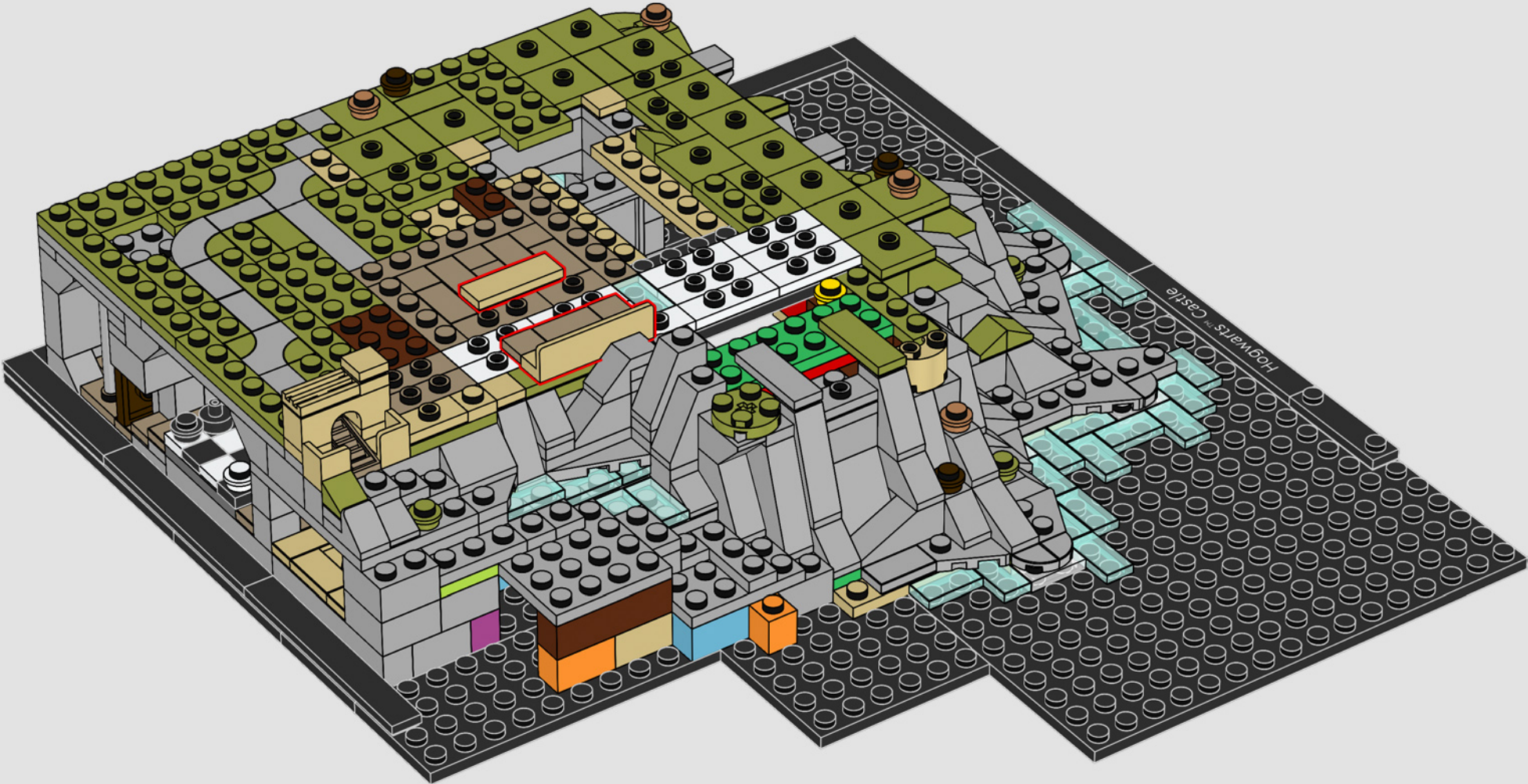

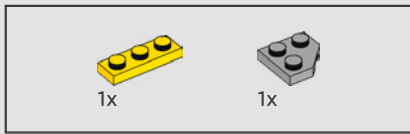

161

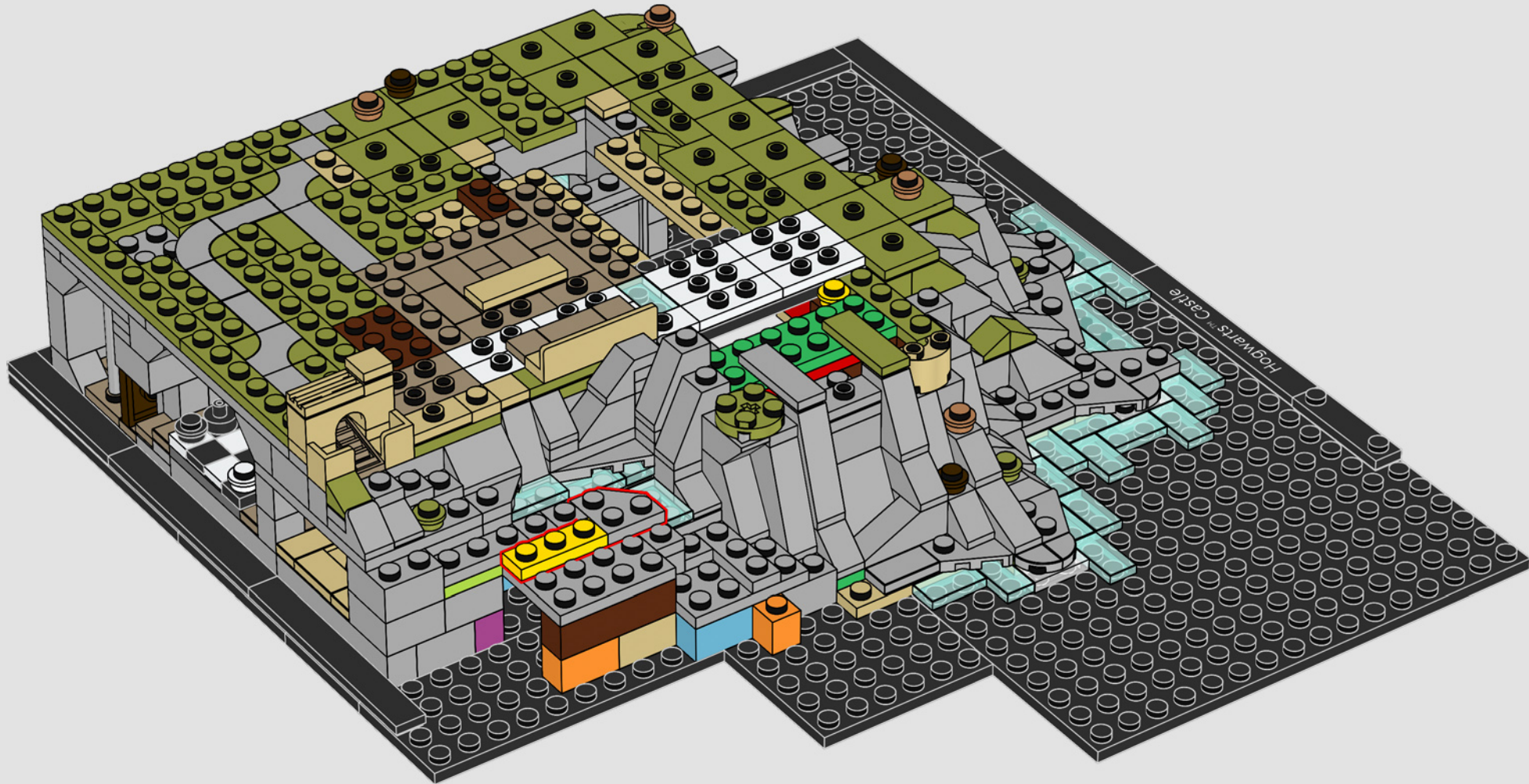

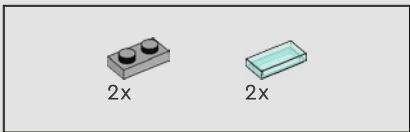

162

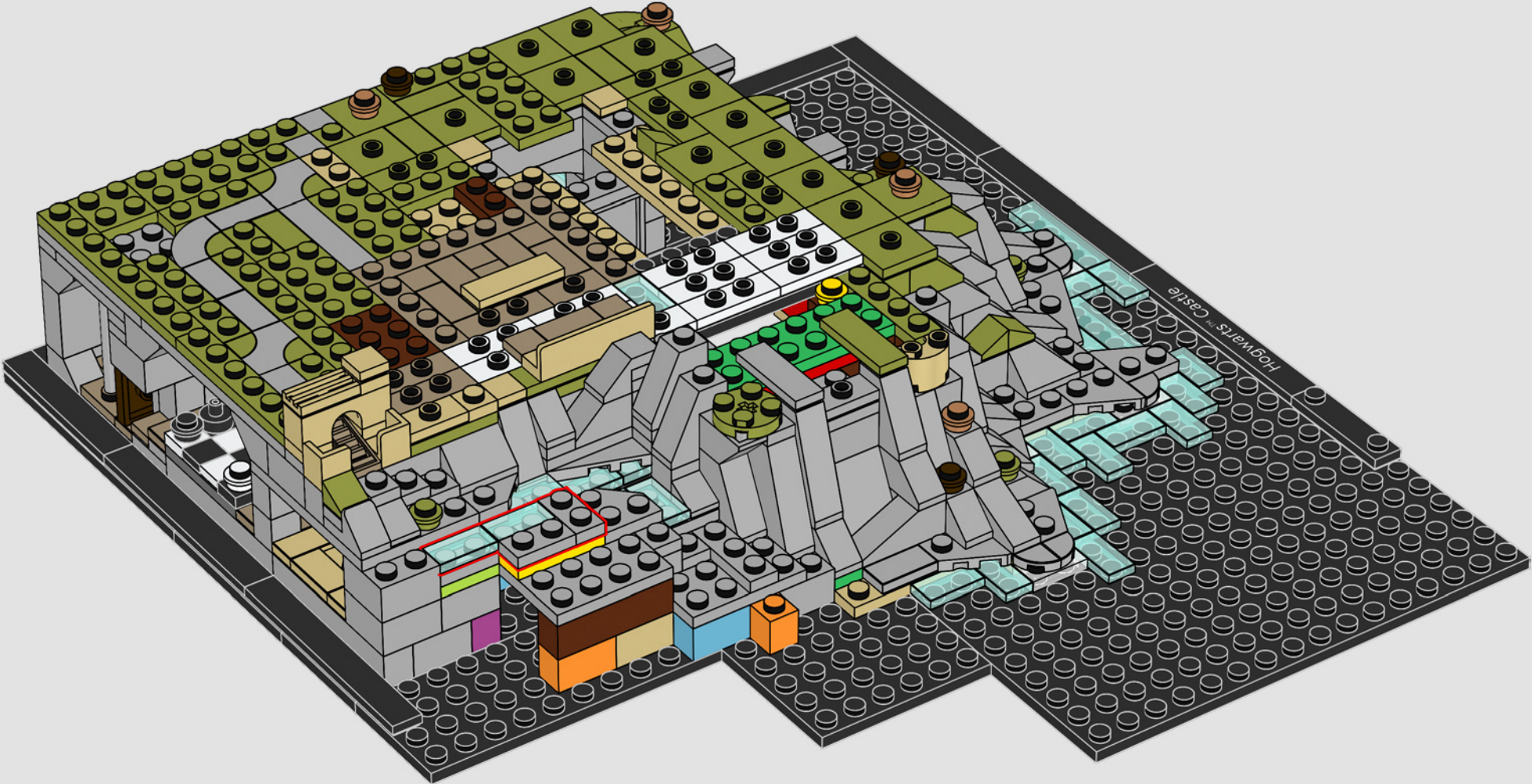



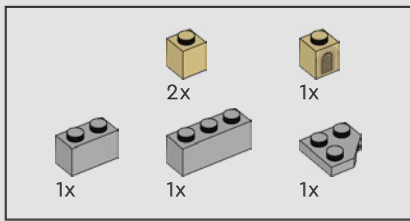

163

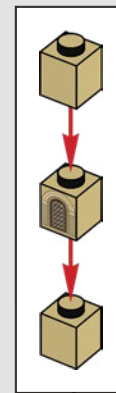
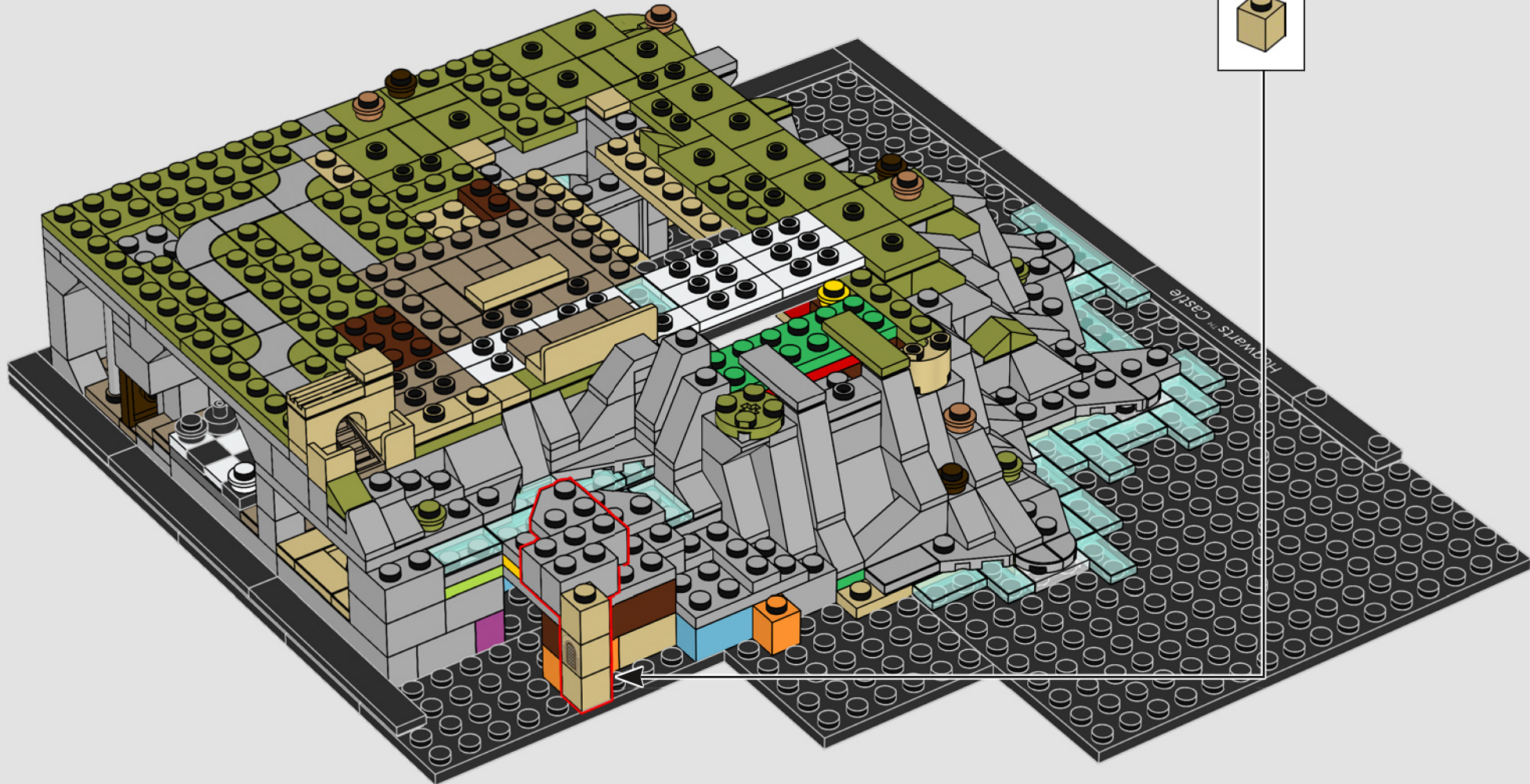

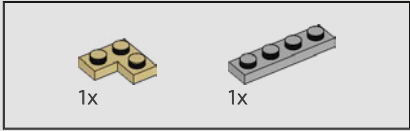
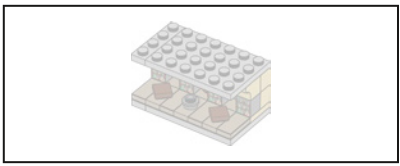

164

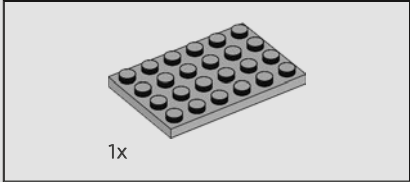
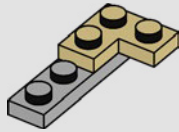

165

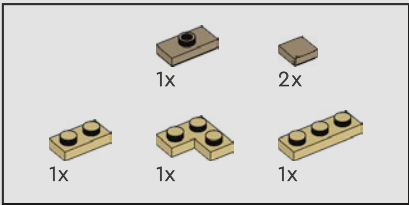
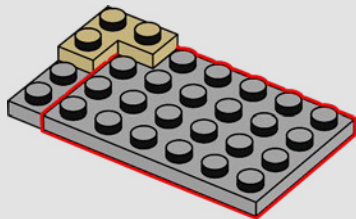

166

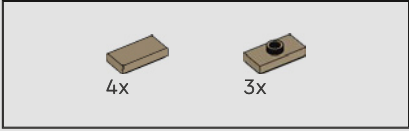
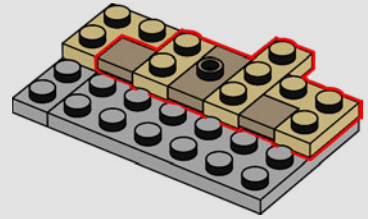

167

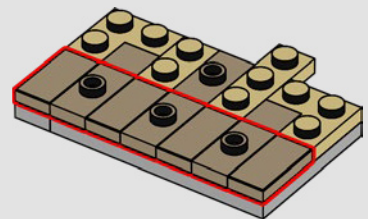

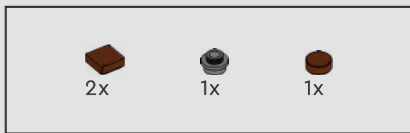

168

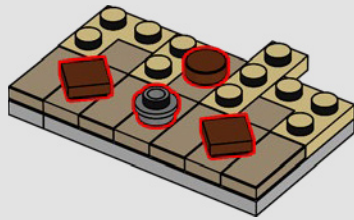

169

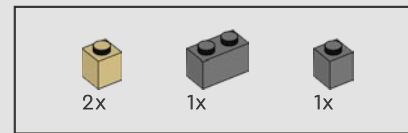
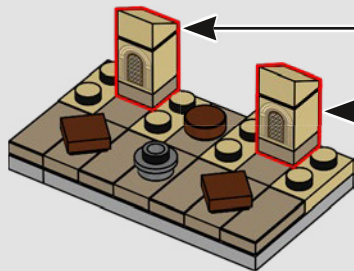
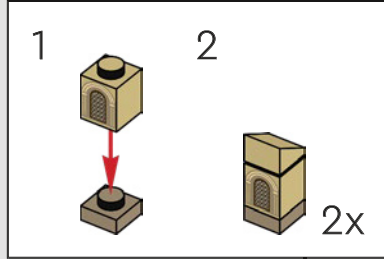

170

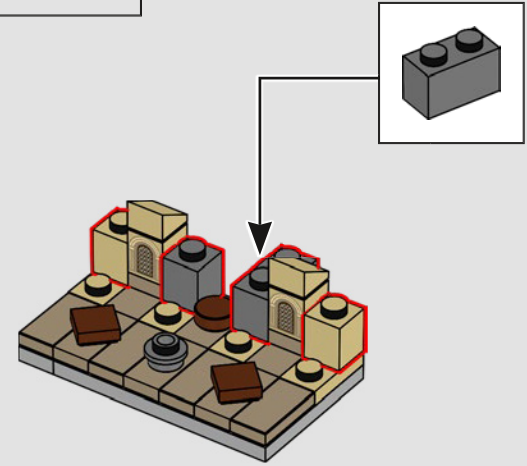

171

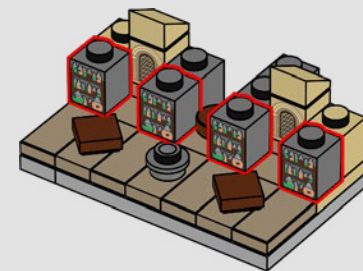

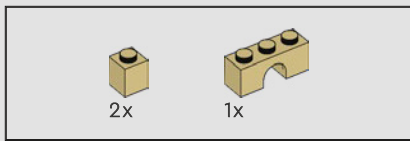

172

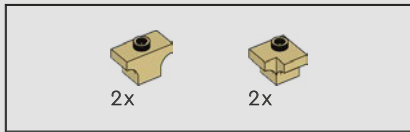
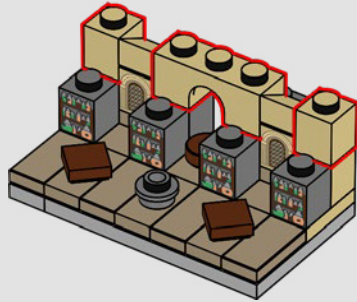

173

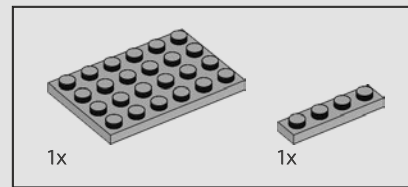
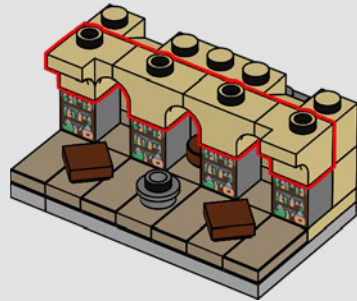

174

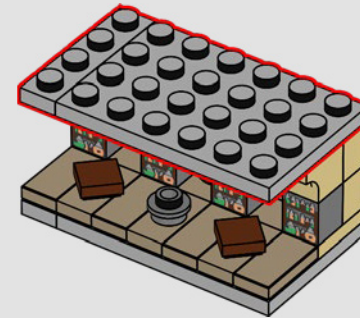

175

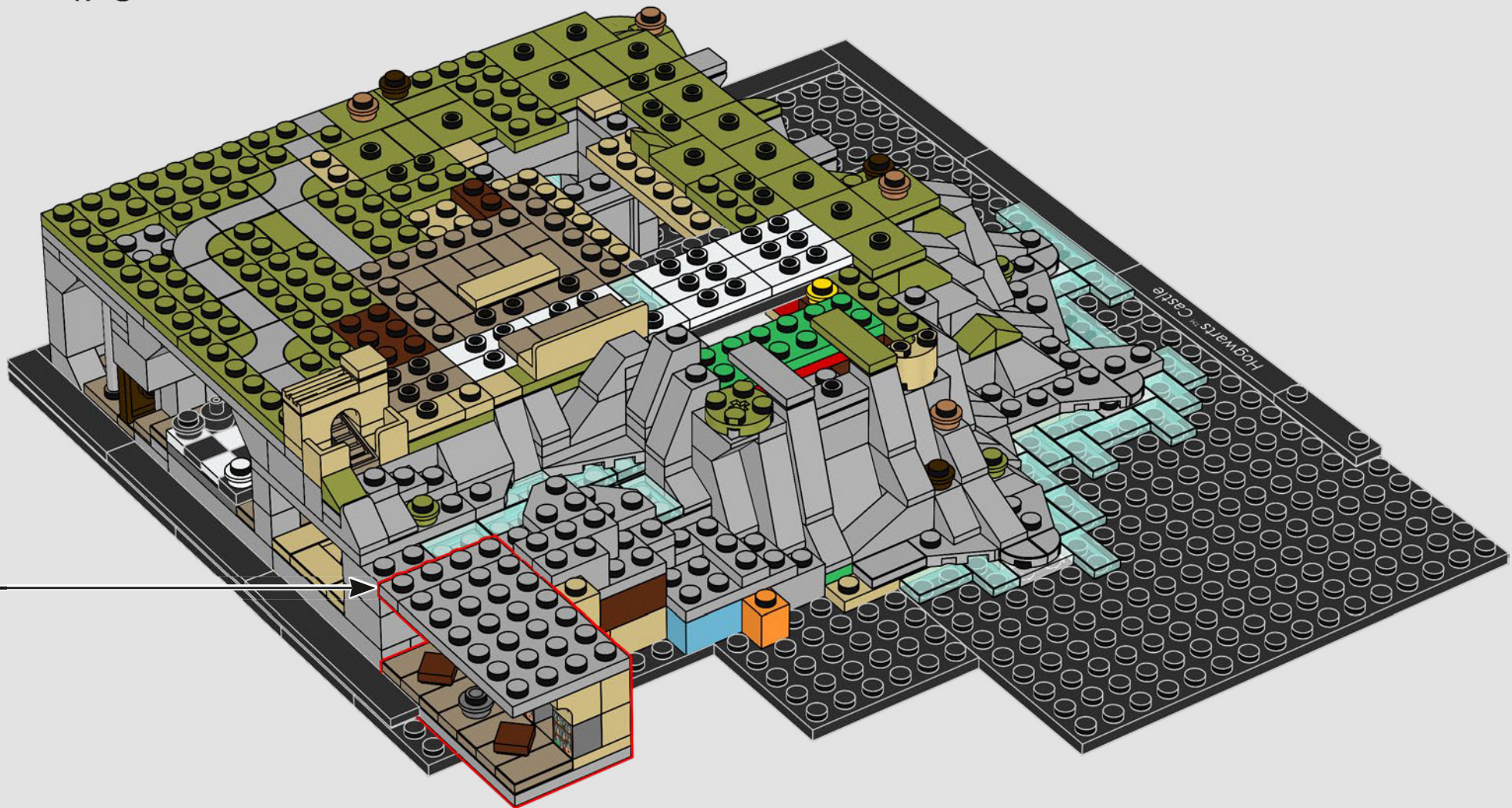



Muggles™ may be tempted to brew their own potions but risk disappointment (or worse!) with the results. Only witches or wizards can conjure the necessary magic required for successful elixirs.

Les Moldus peuvent être tentés de concocter leurs propres potions, mais ils risquent d'être déçus (ou pire !) par les résultats. Seuls les sorcières et sorciers peuvent invoquer la magie nécessaire à la réussite des élixirs.

Los Muggles™ pueden sentir la tentación de elaborar sus propias pociones, pero se arriesgan a decepcionarse (¡o a algo peor!) con los resultados. Solo las brujas o los magos pueden conjurar la magia necesaria para que los elixires tengan éxito.



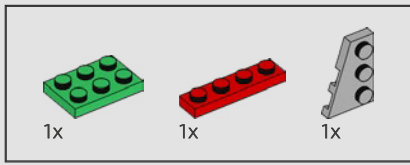

176

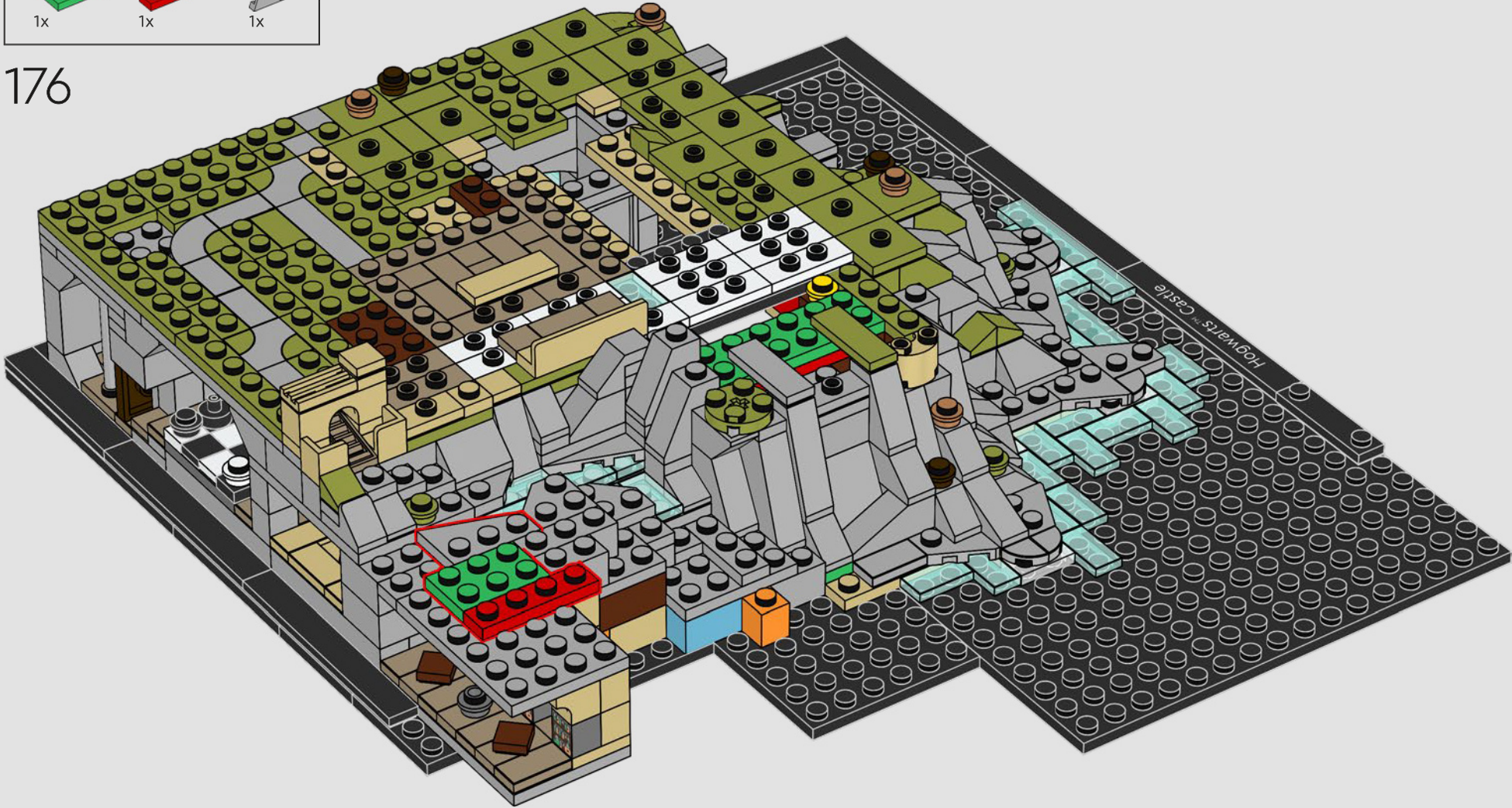

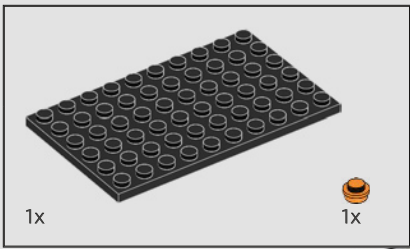

177

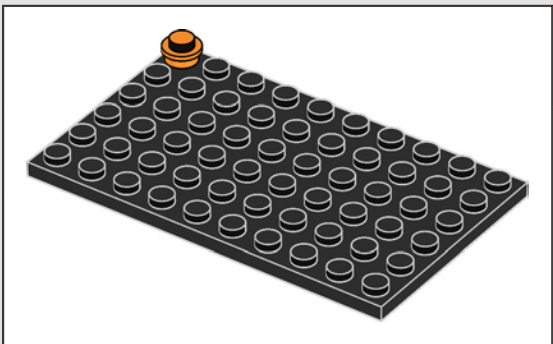
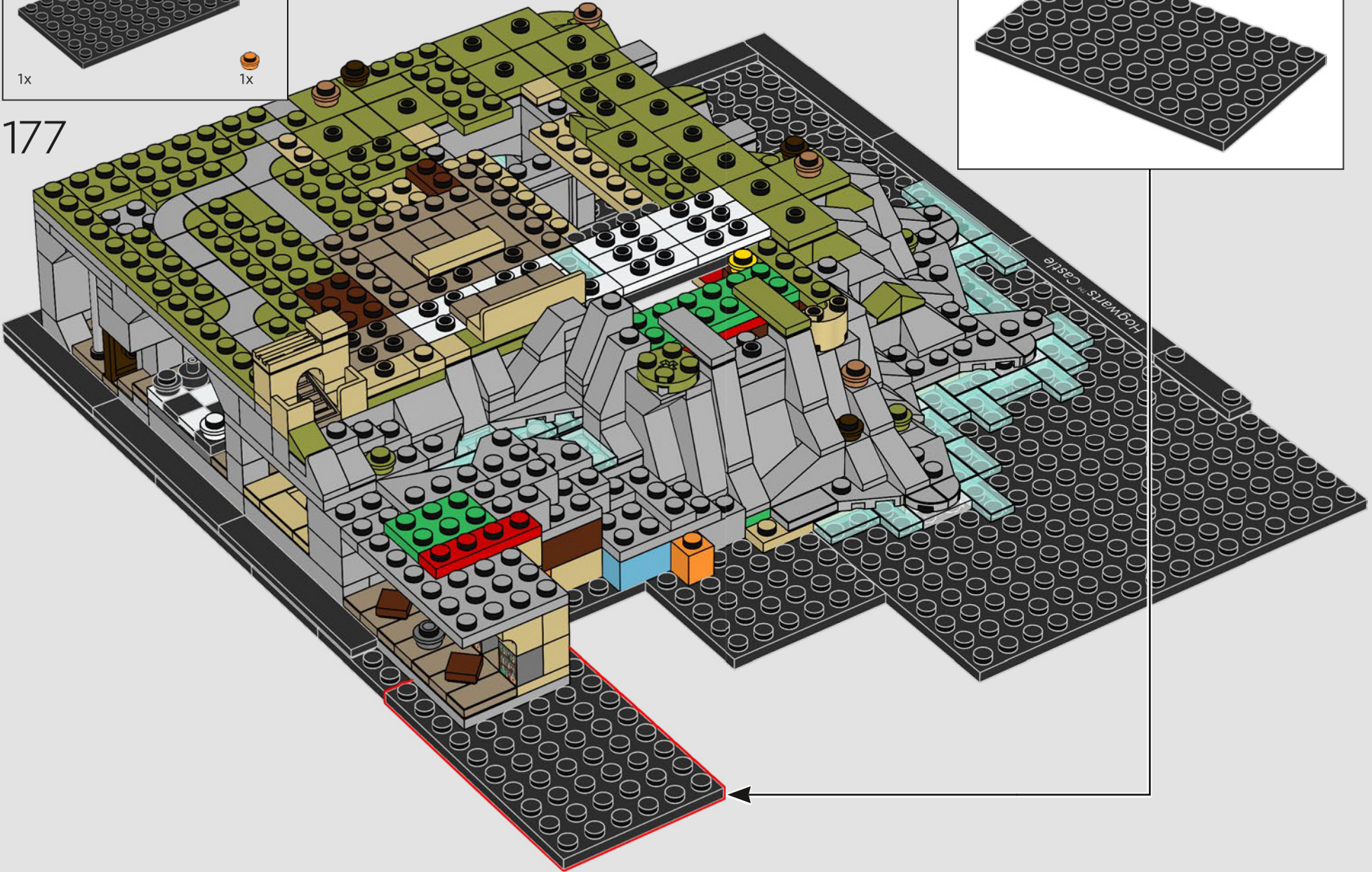



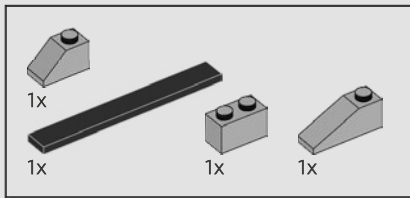

178

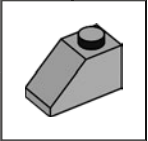





179



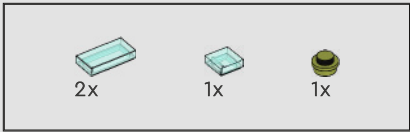

180



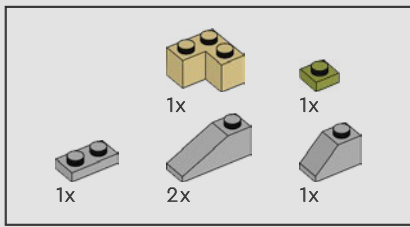

181

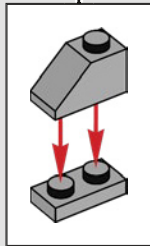

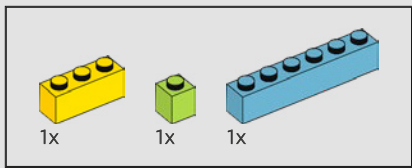

182



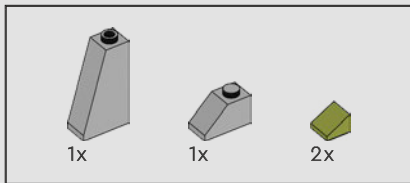

183

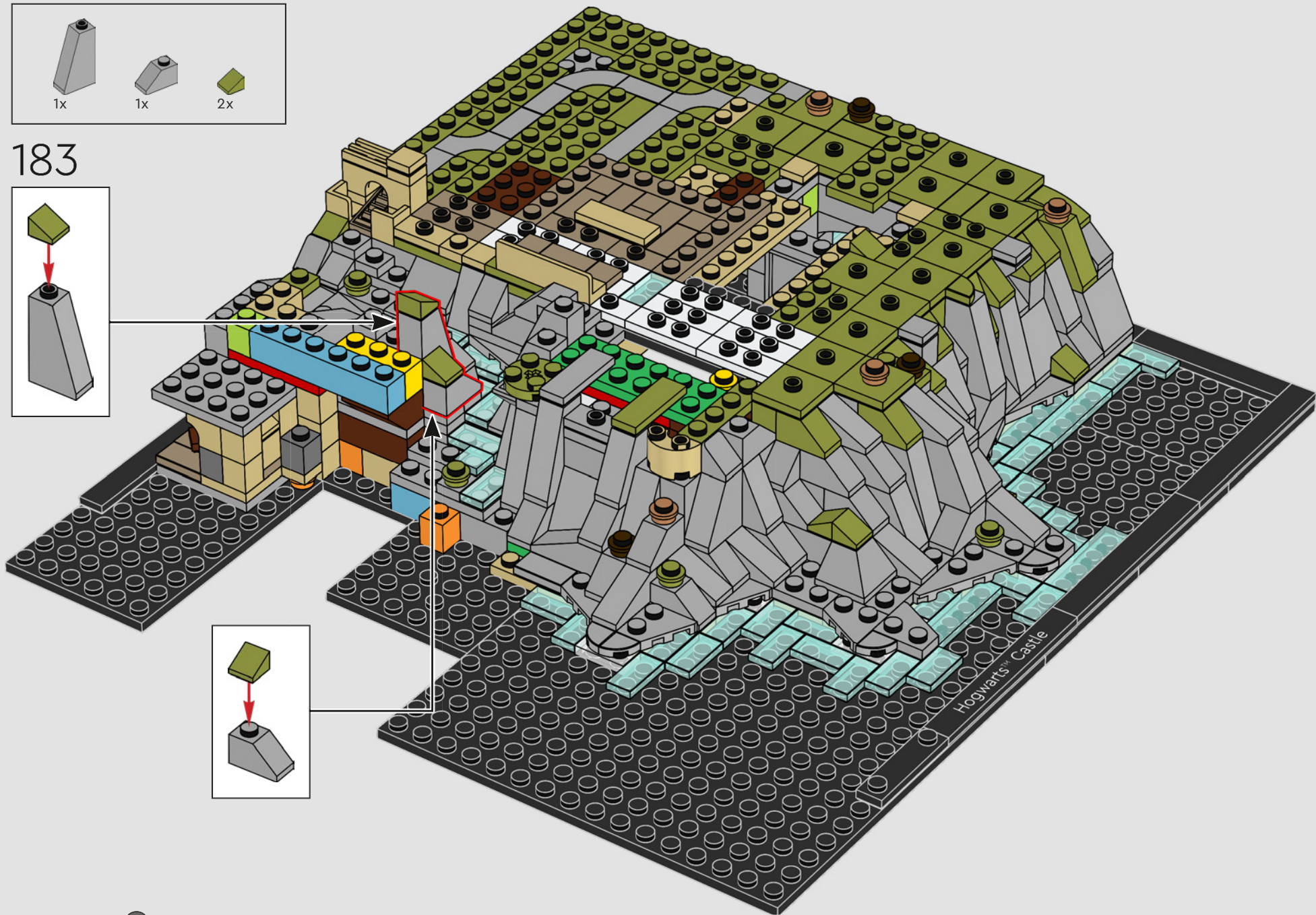
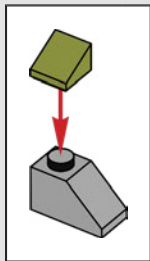
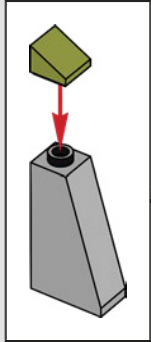

Hogwarts™ Castle

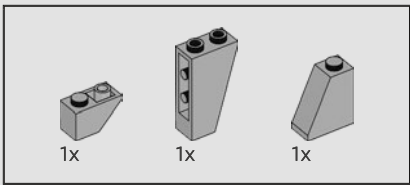

184

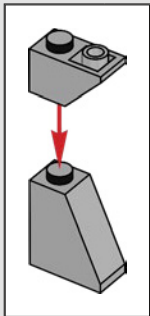

According to legend, it was Rowena Ravenclaw™ who named the castle Hogwarts™ after dreaming of a warty hog that led her to the perfect location. This has never been confirmed.

Selon la légende, c'est Rowena Serdaigle qui a nommé le château Poudlard après avoir rêvé d'un porc verruqueux qui l'a conduite à l'endroit idéal. Cette information n'a jamais été confirmée.

Según la leyenda, fue Rowena Ravenclaw™ quien bautizó el castillo con el nombre de Hogwarts™ luego de soñar con un cerdo verrugoso que la condujo al lugar perfecto. Eso nunca ha sido confirmado.





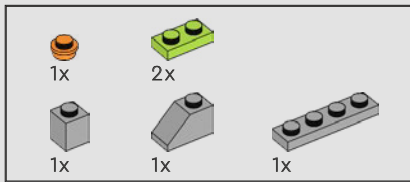

185



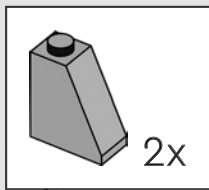
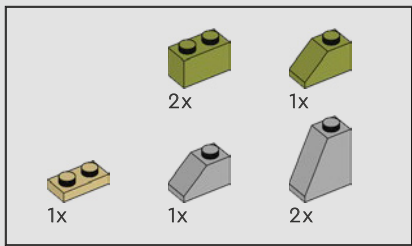

186



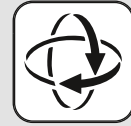
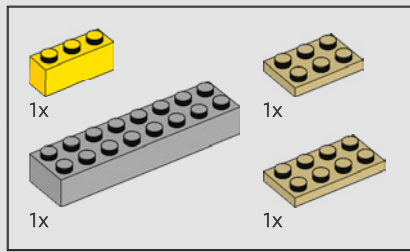

187

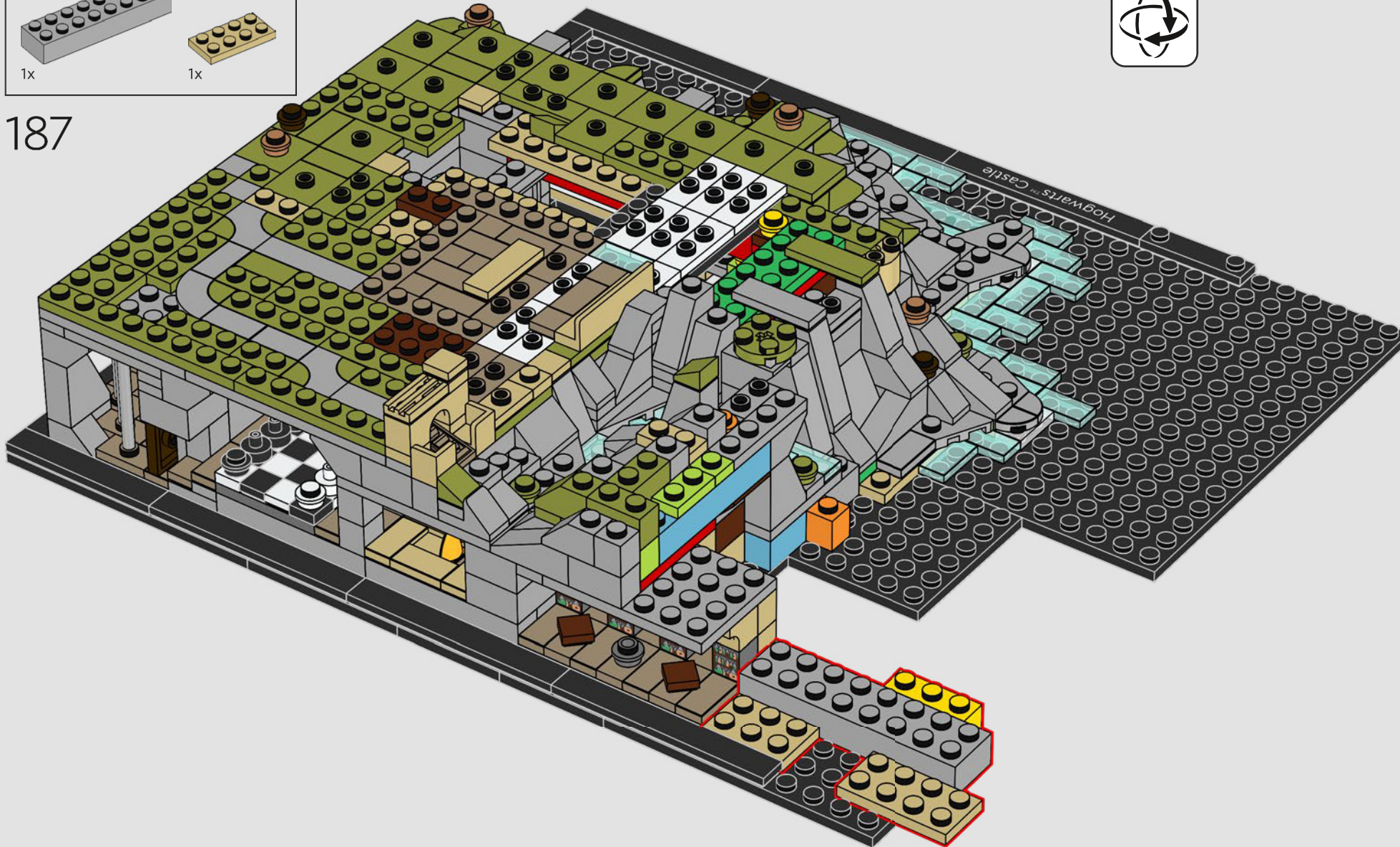

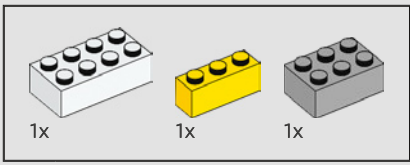

188

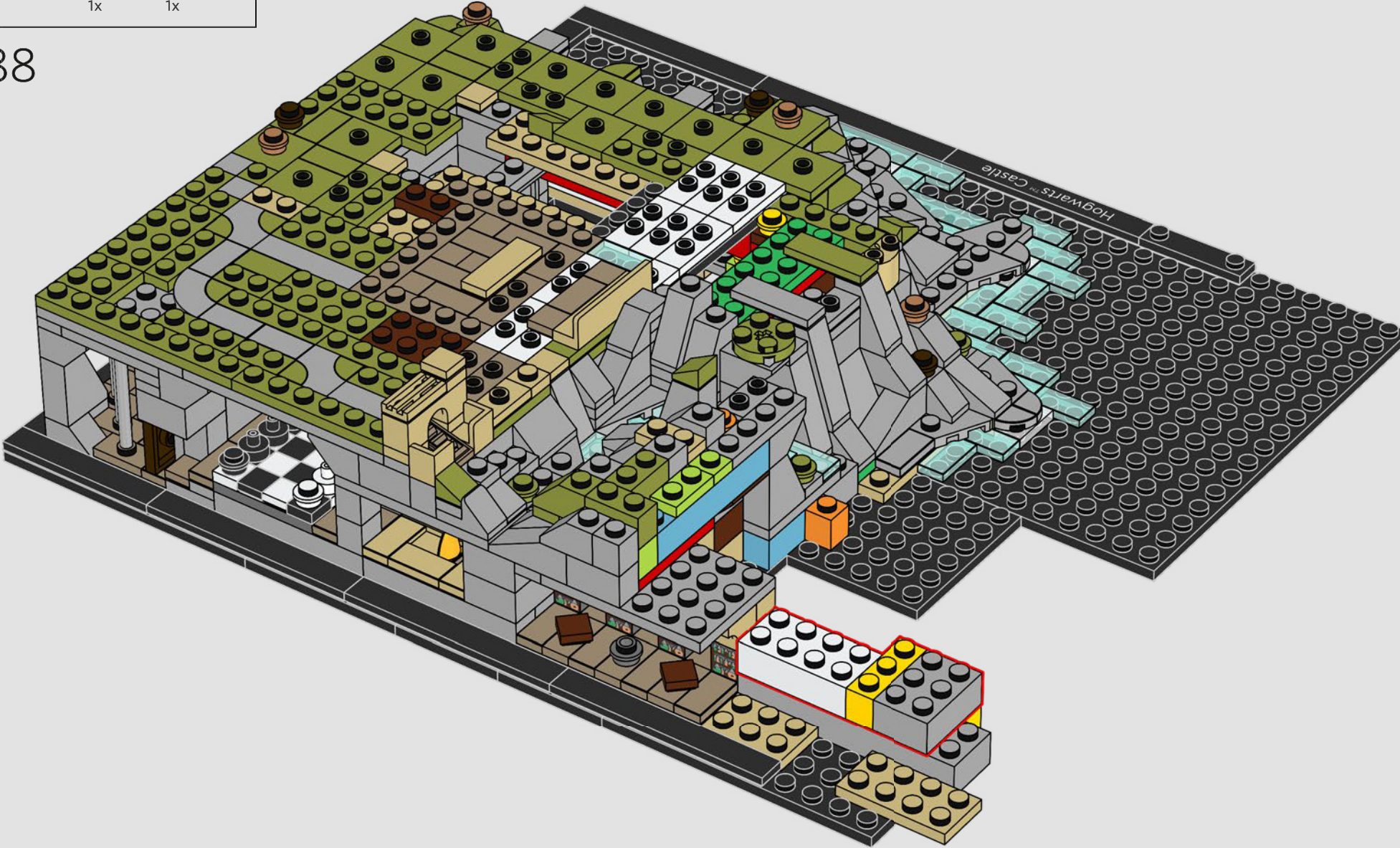

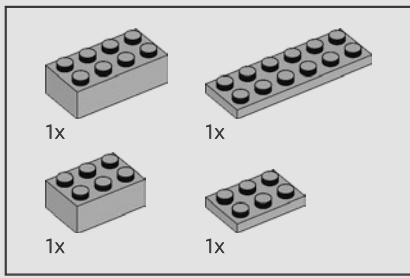

189

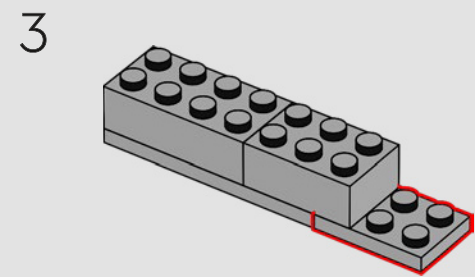
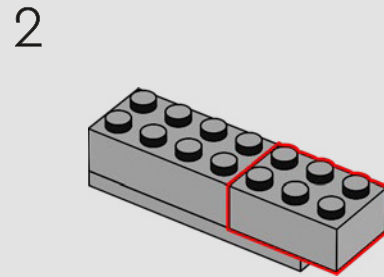
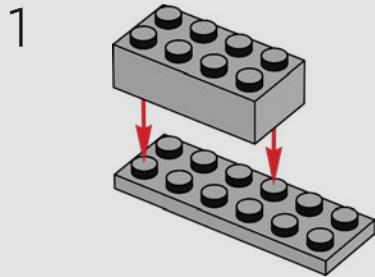

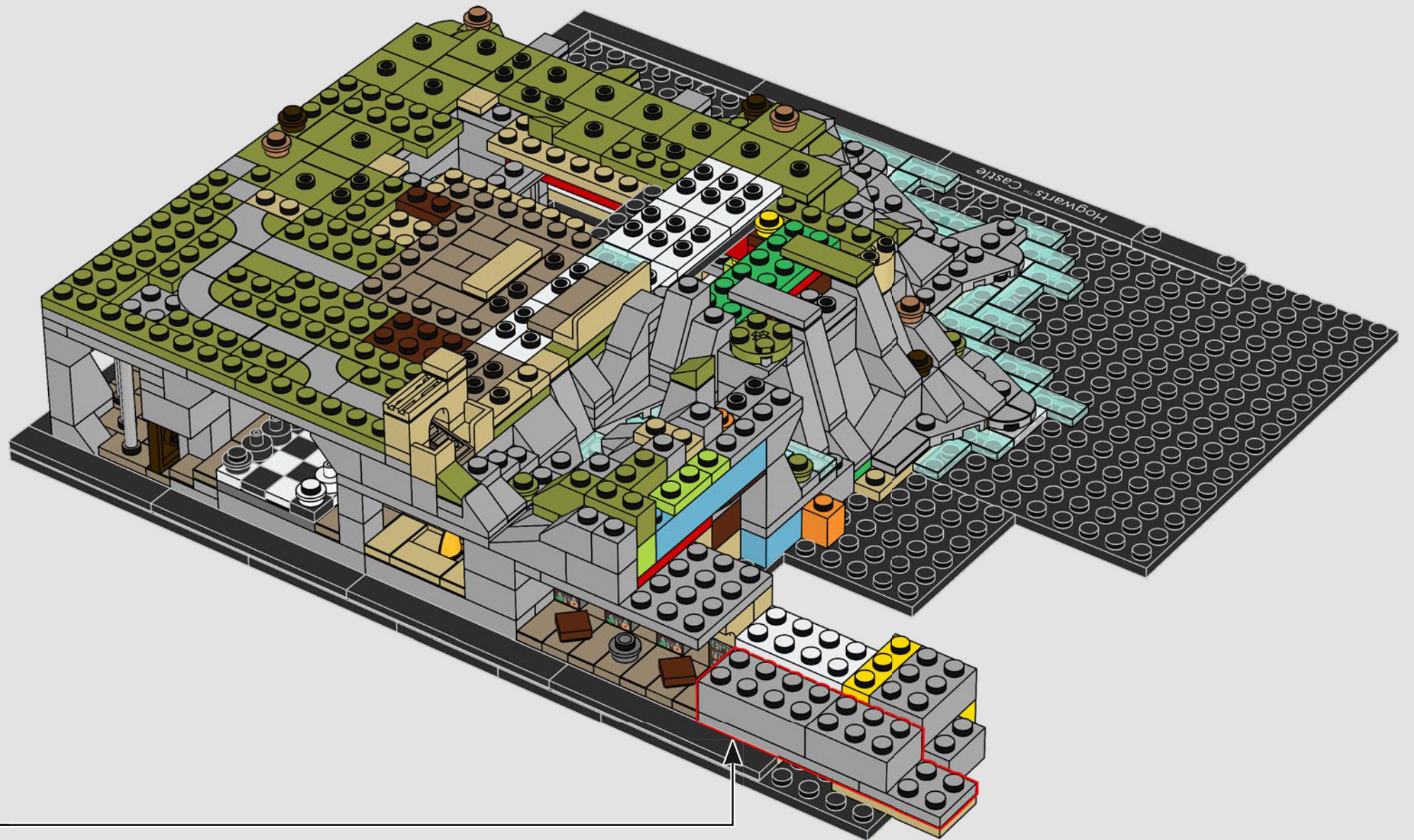

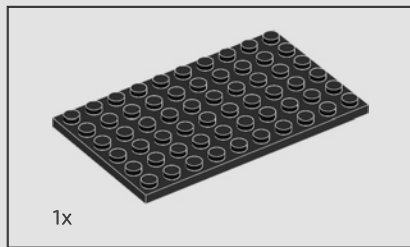

1x

190

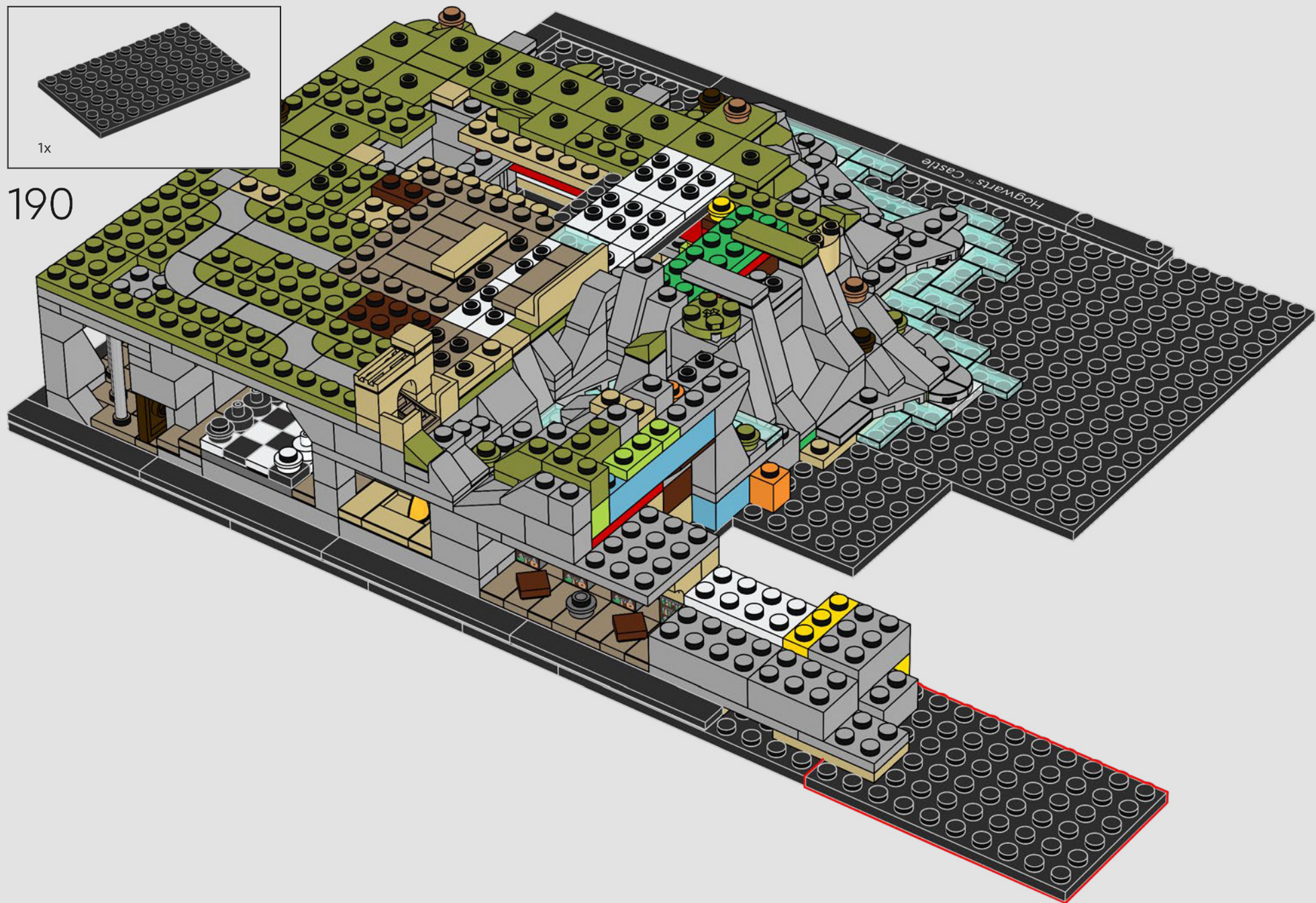

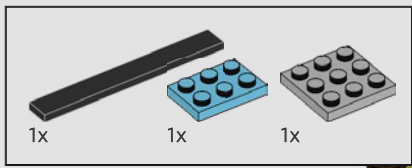

191

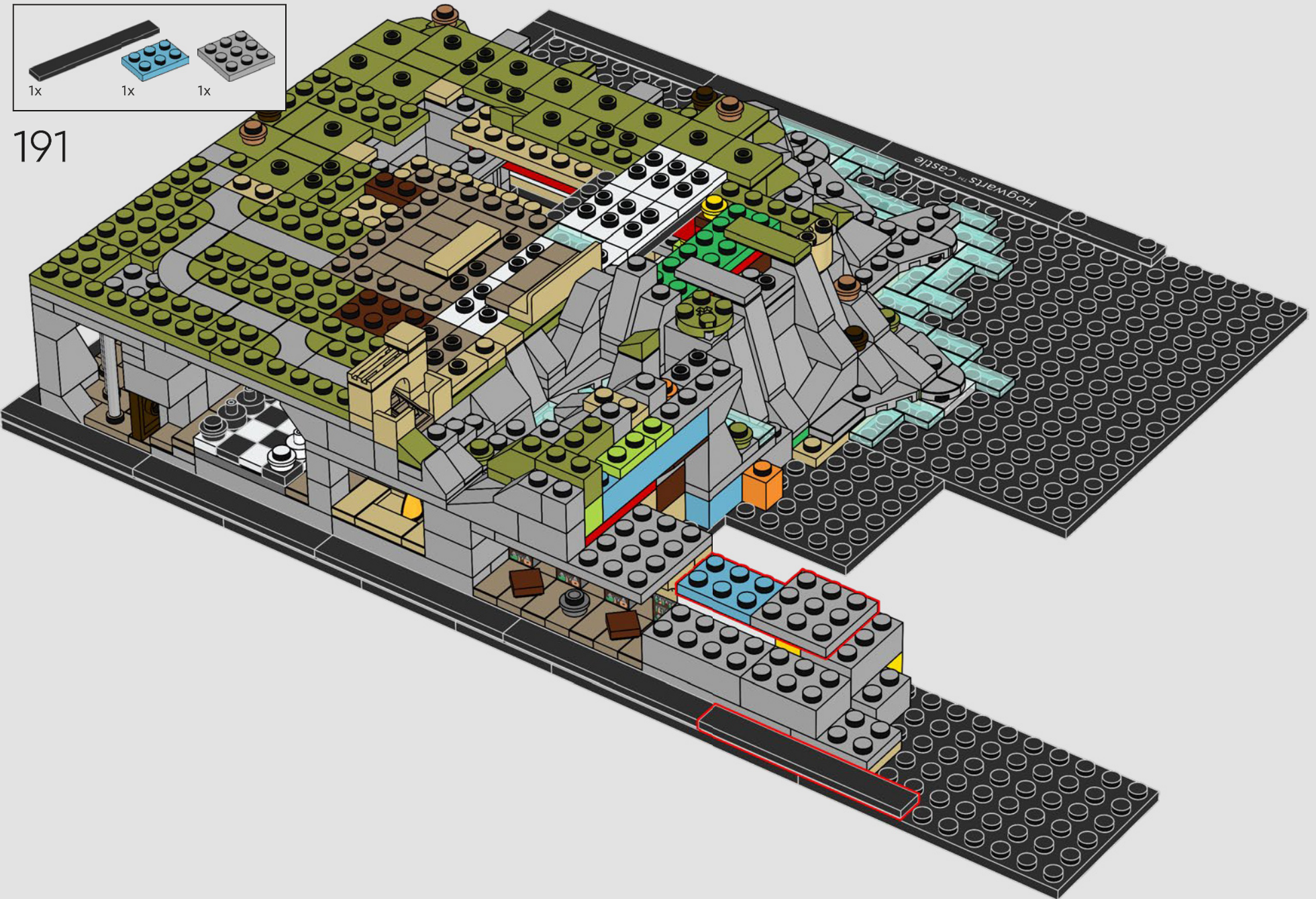





192

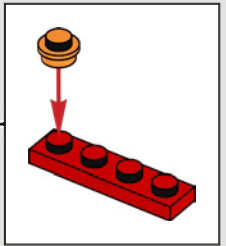
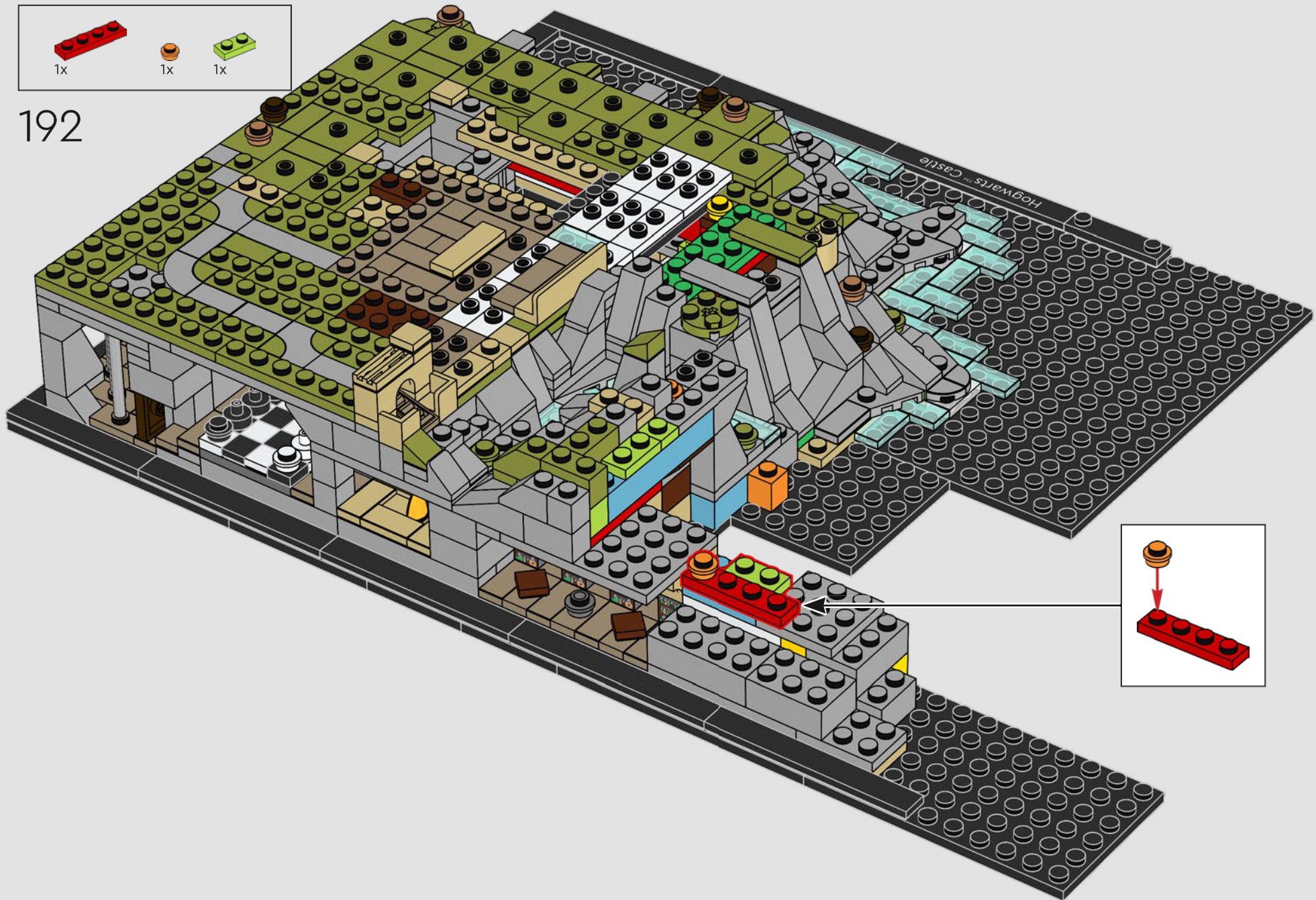

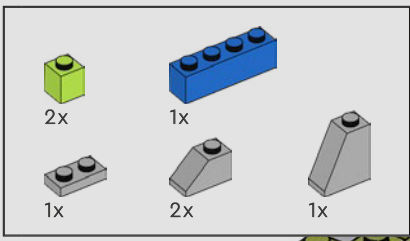

193

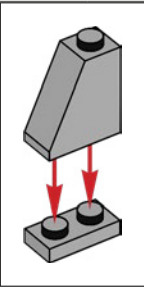
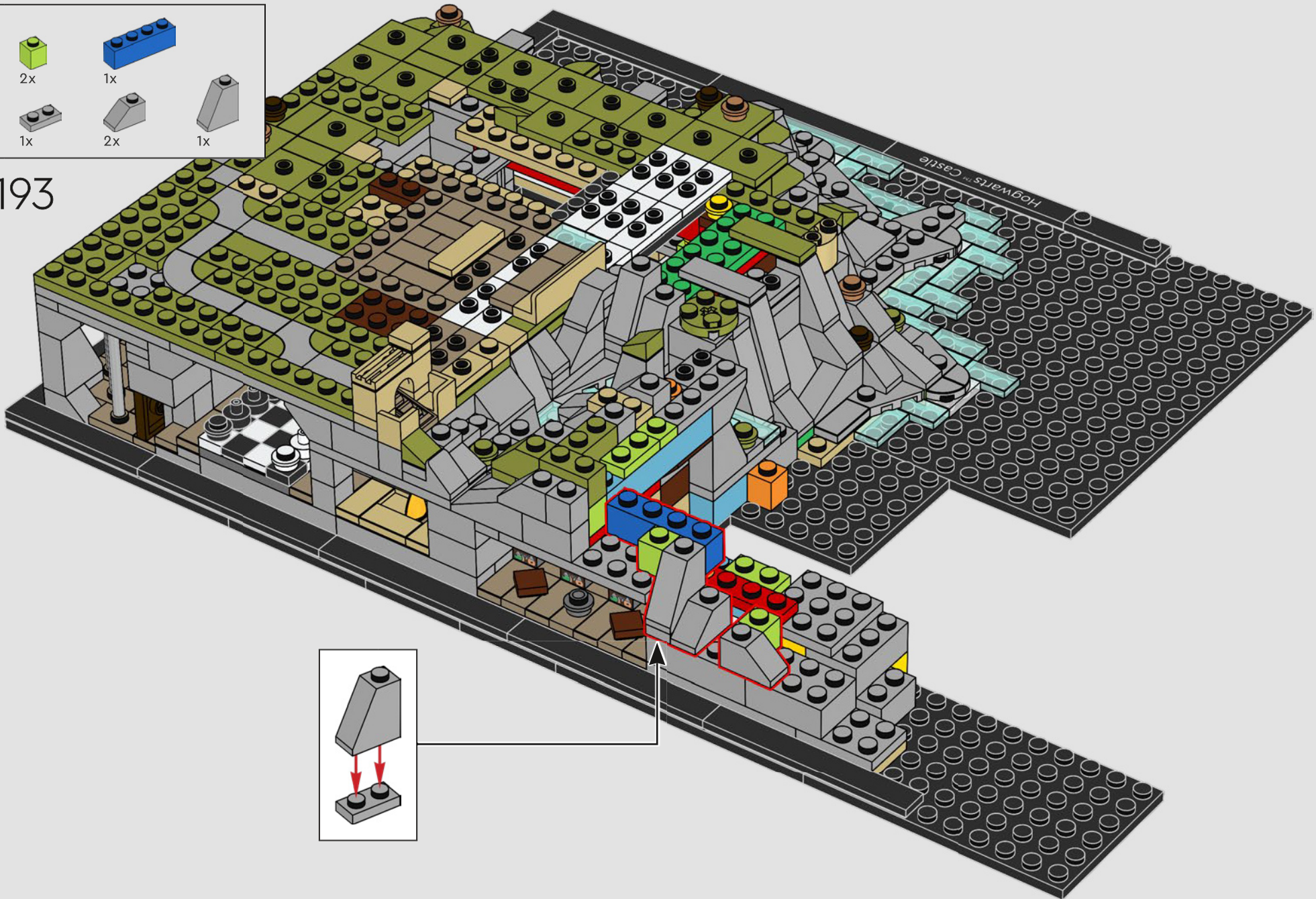

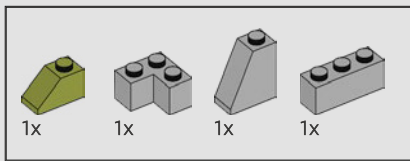

194

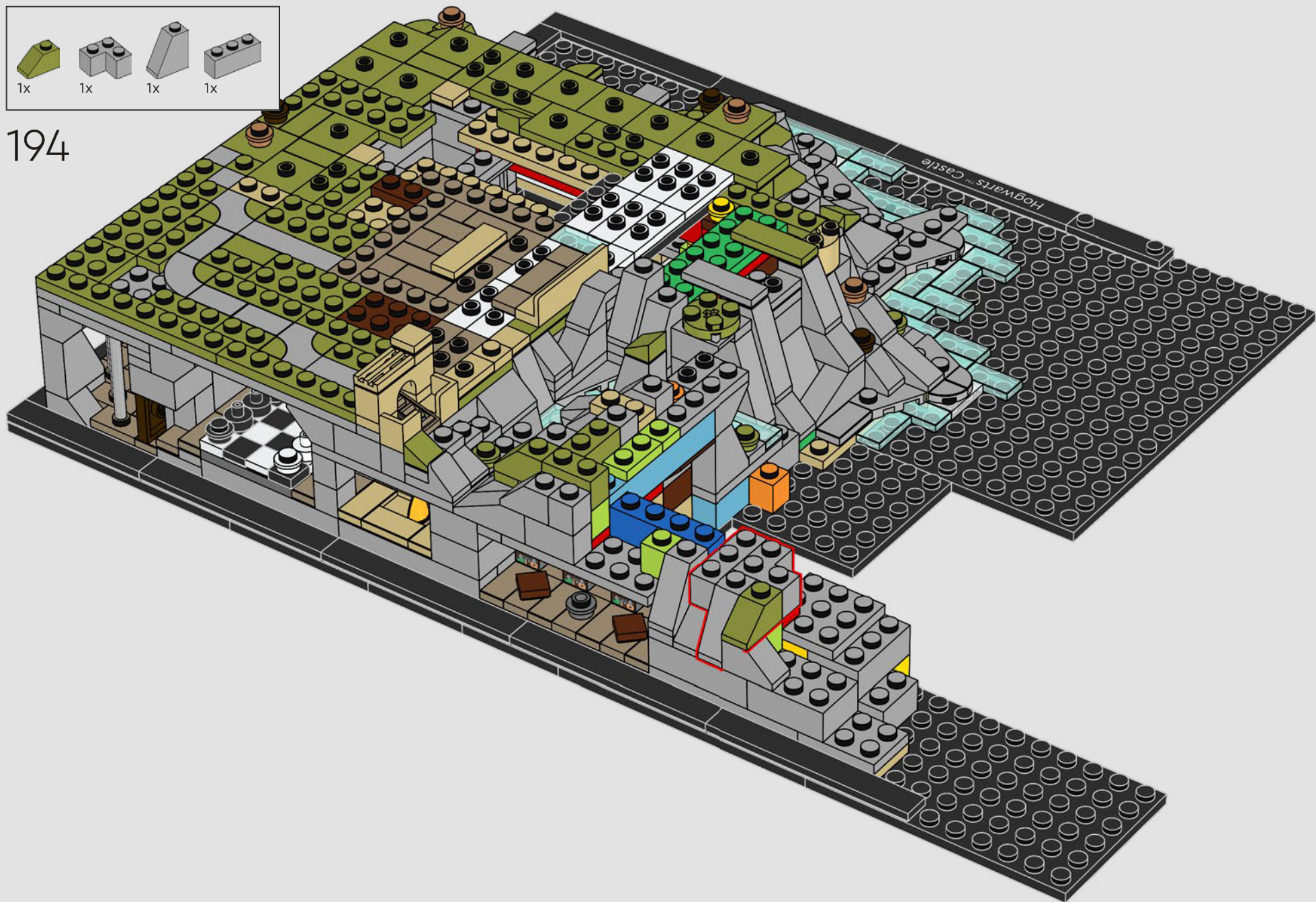

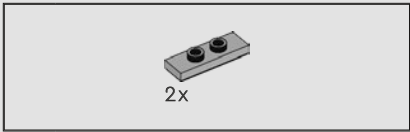

195



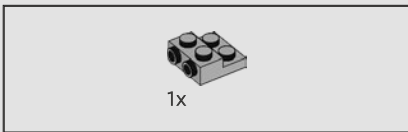

196



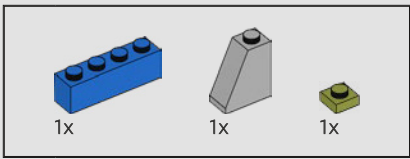

197

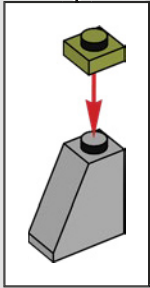

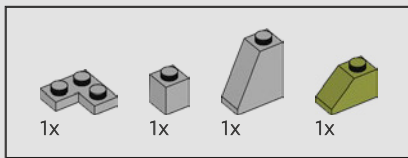

198

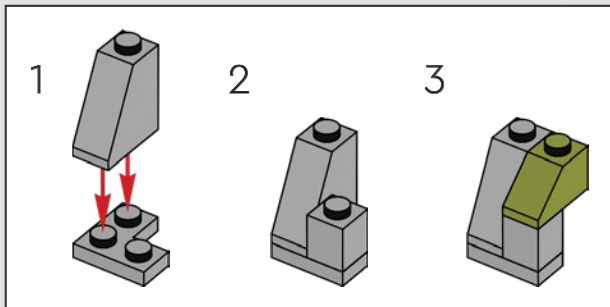
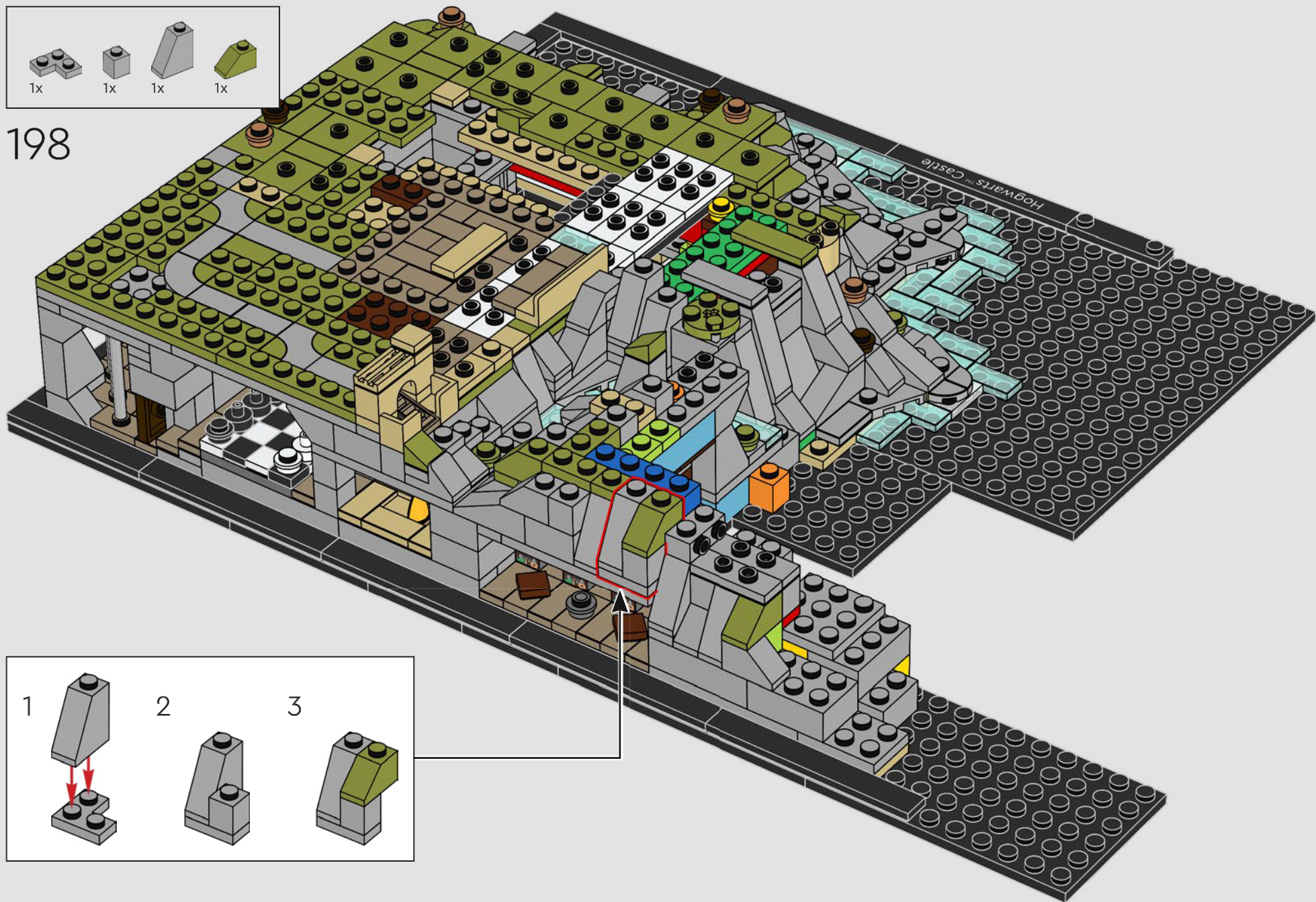

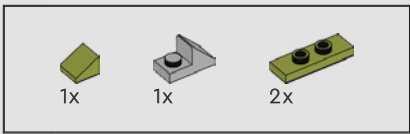

199

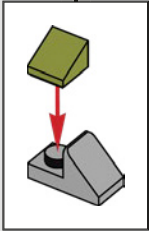



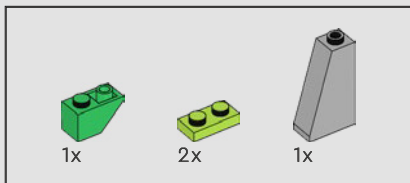

200

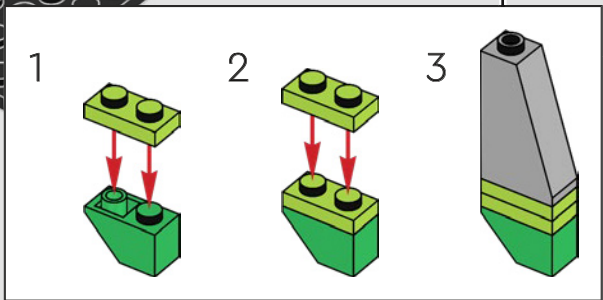
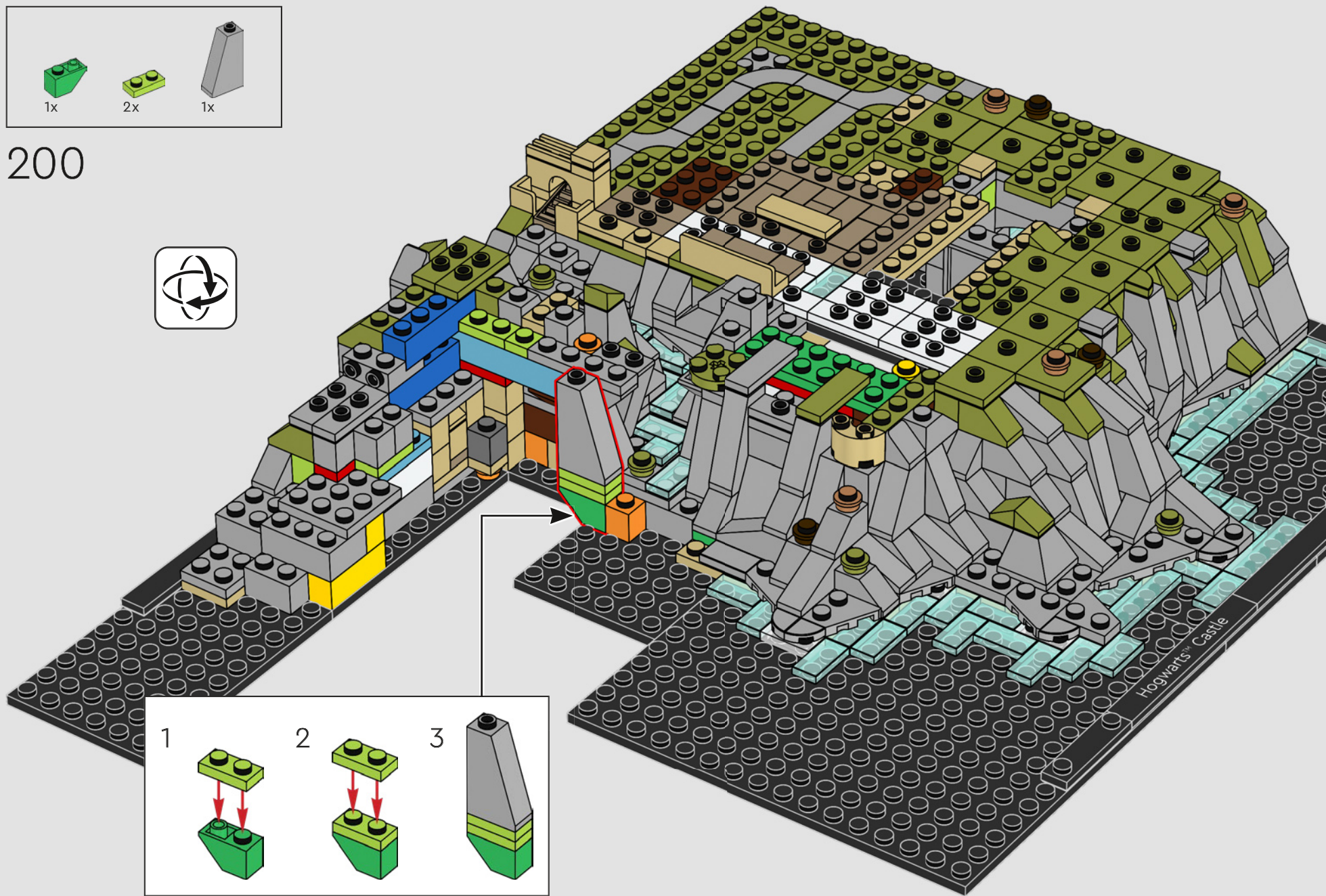

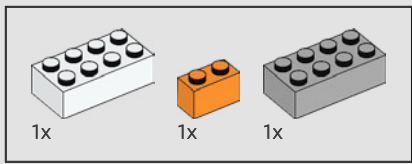

201



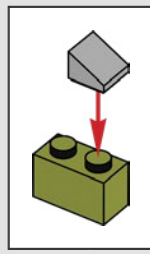
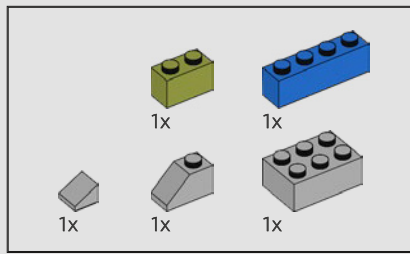

202

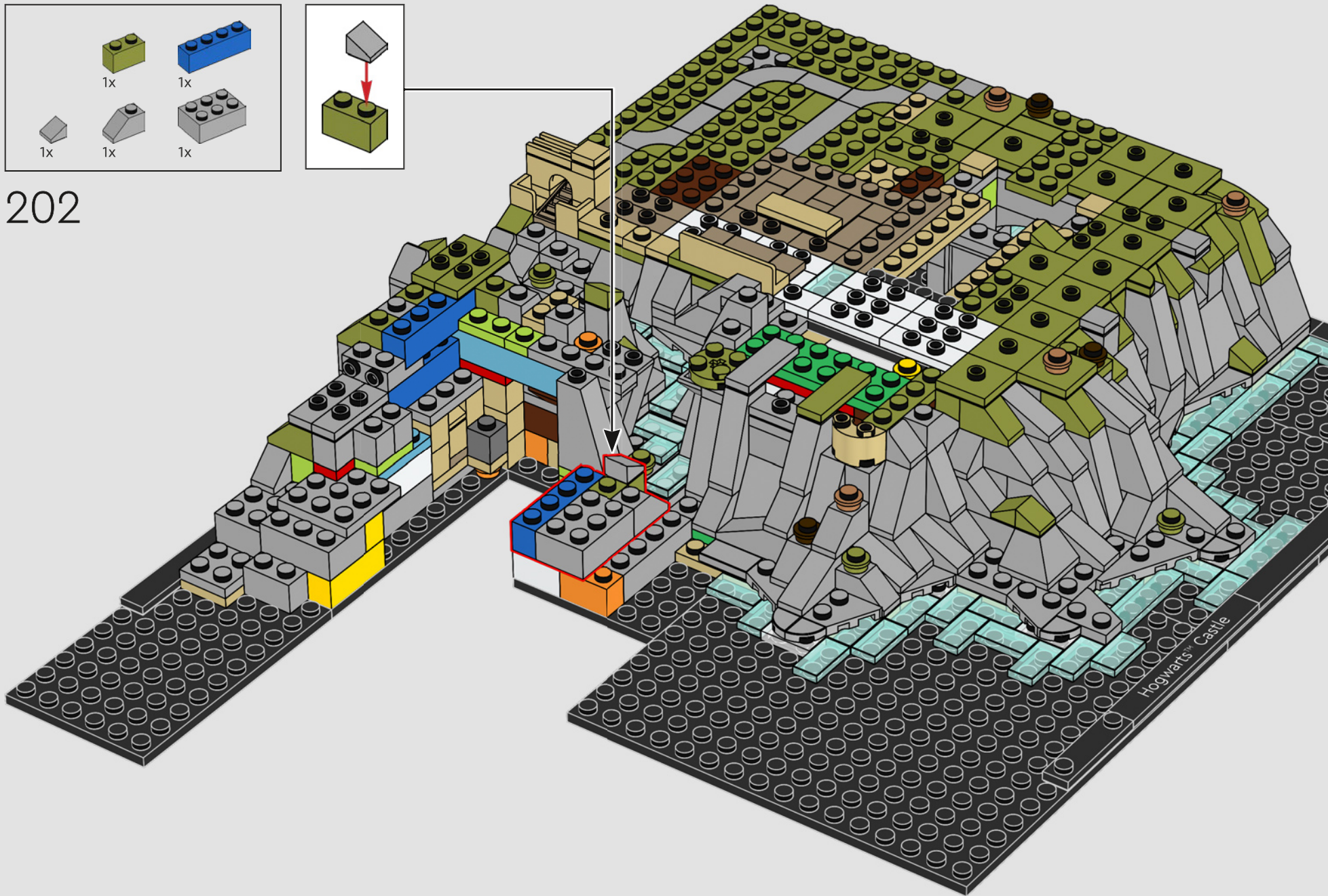

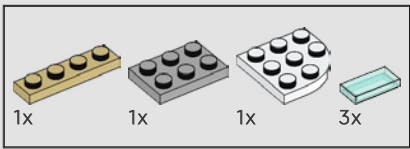

203

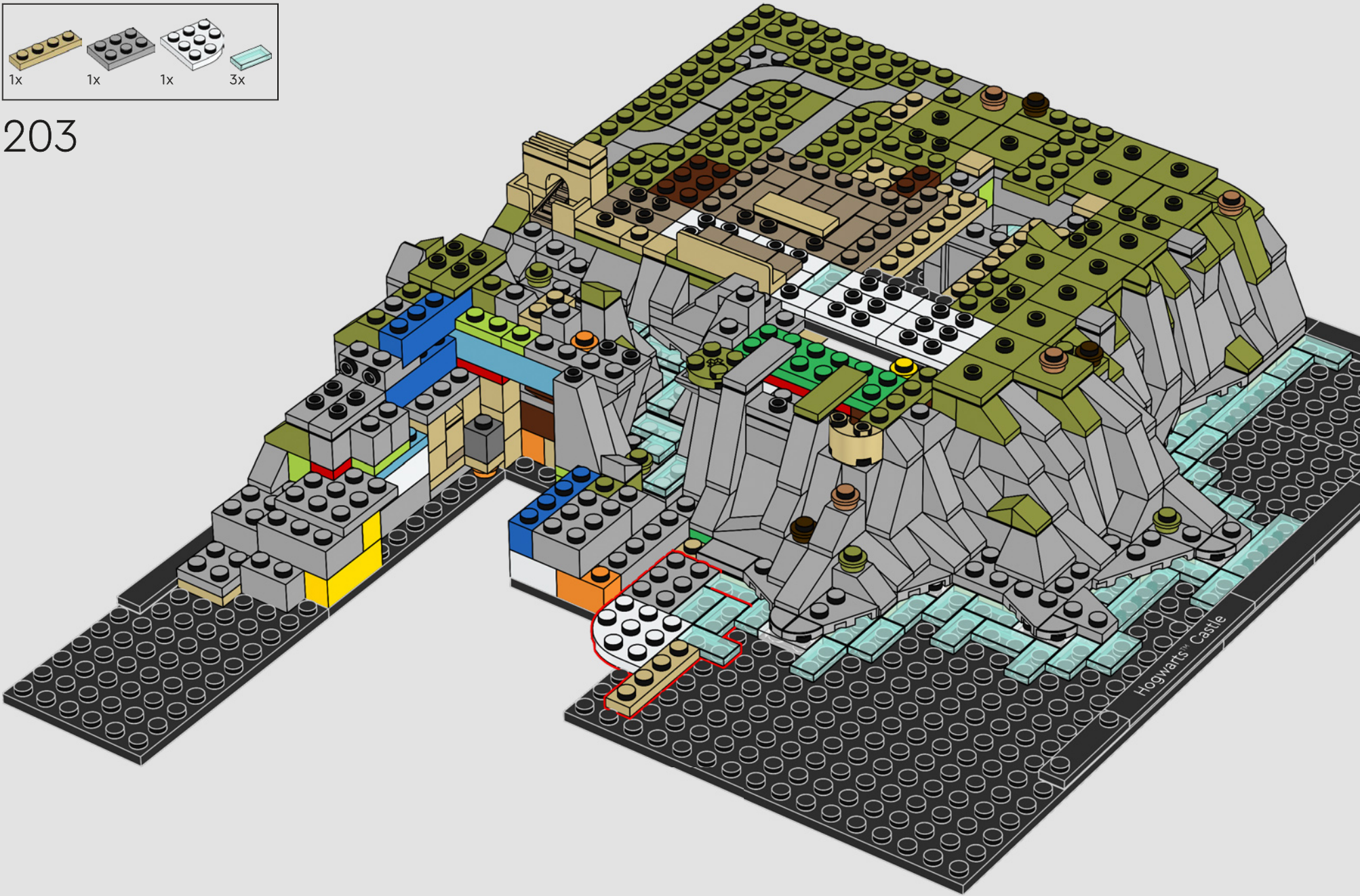

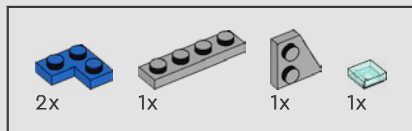

204

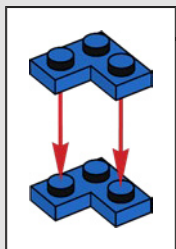
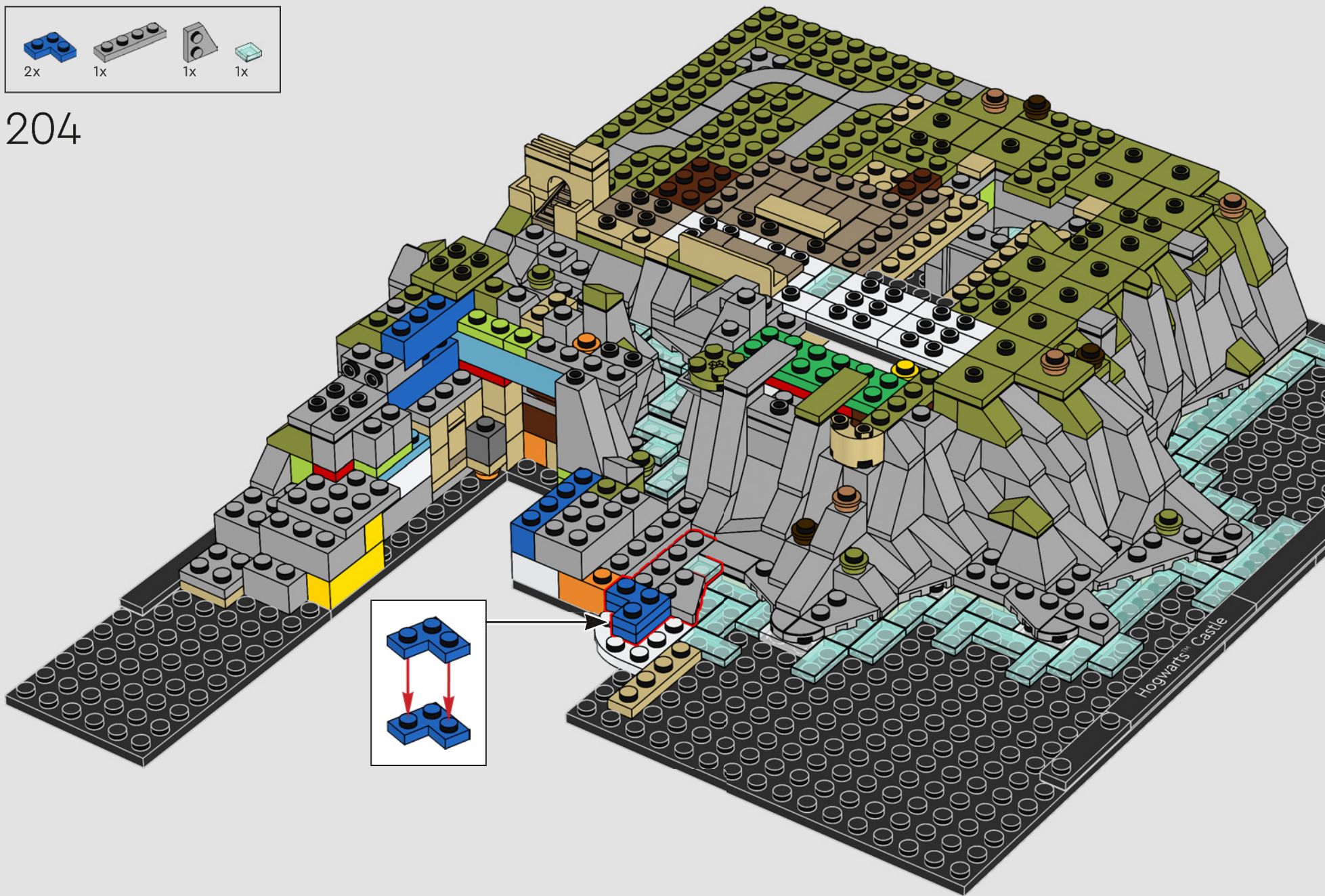

1x  1x  2x 

205

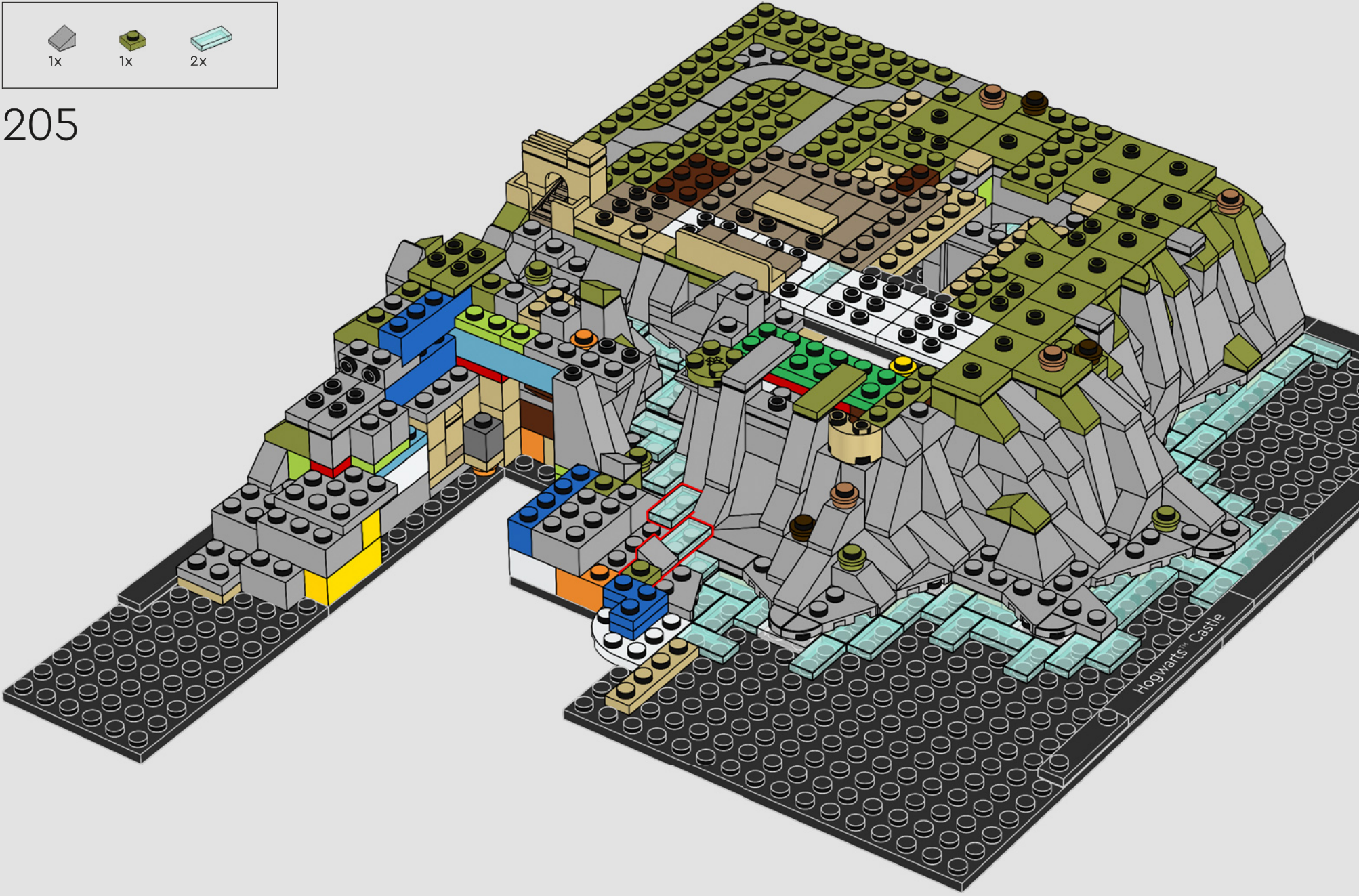

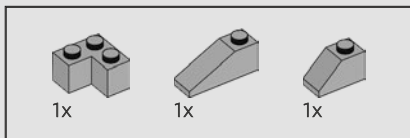

206



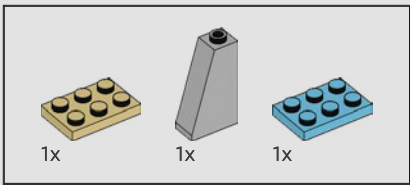

207

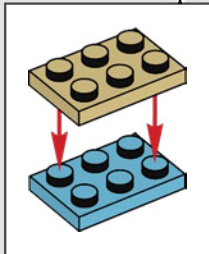
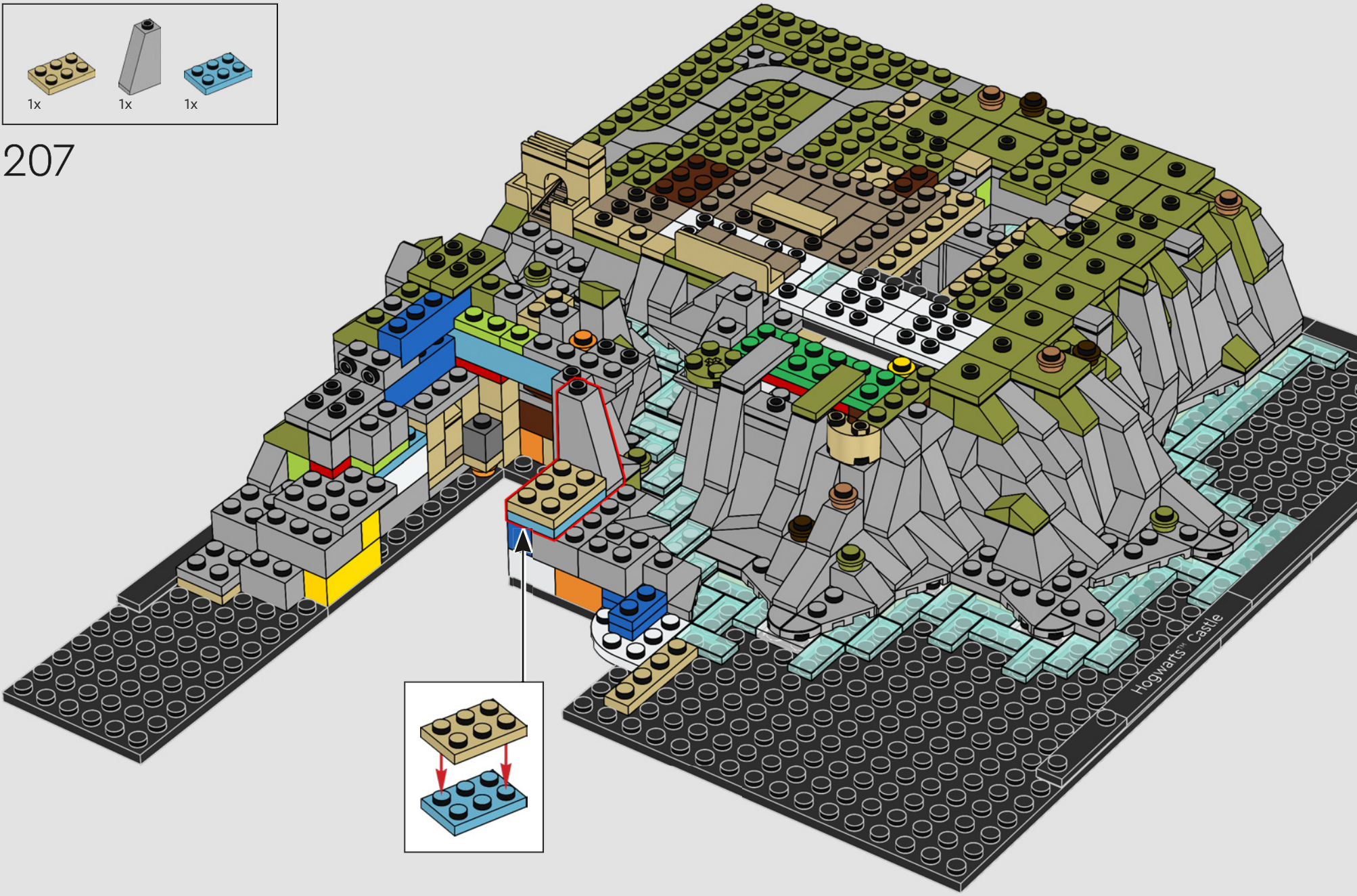



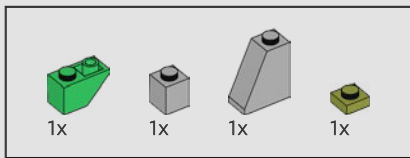

208

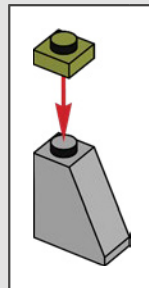
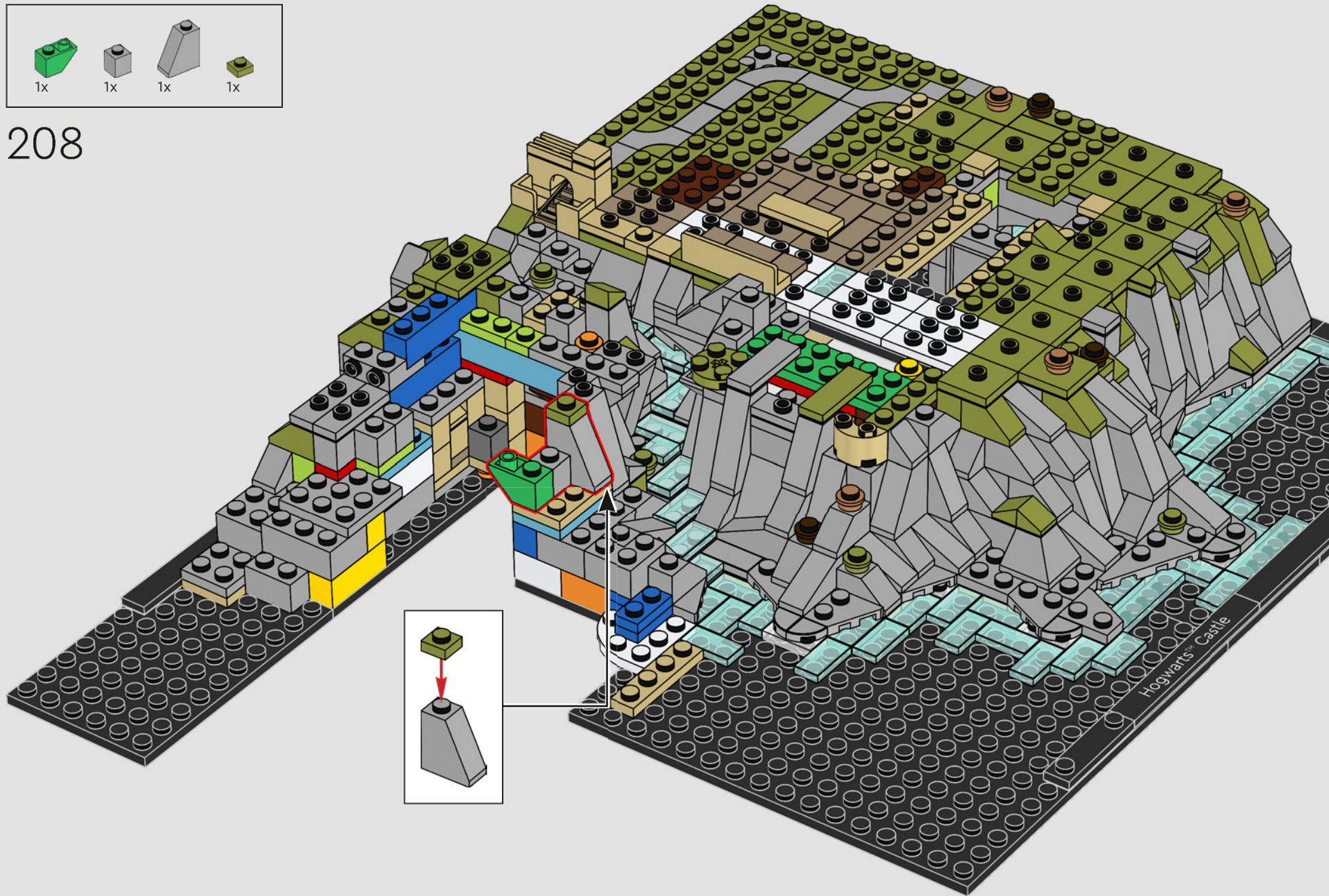

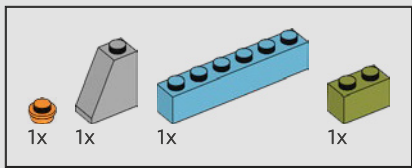

209

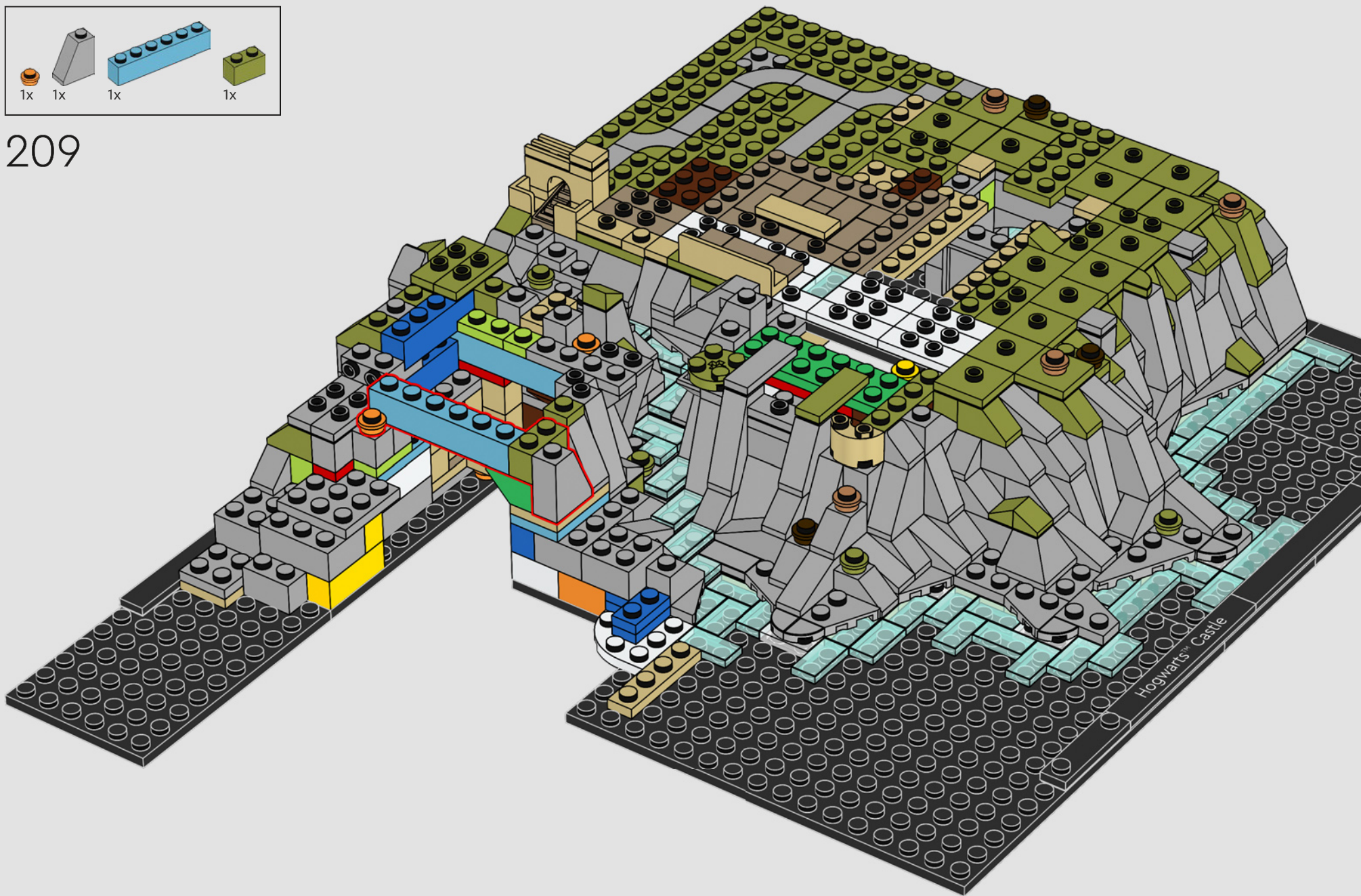

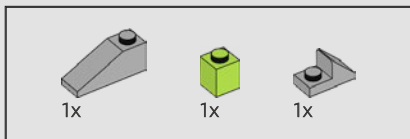

210



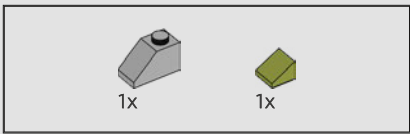

211

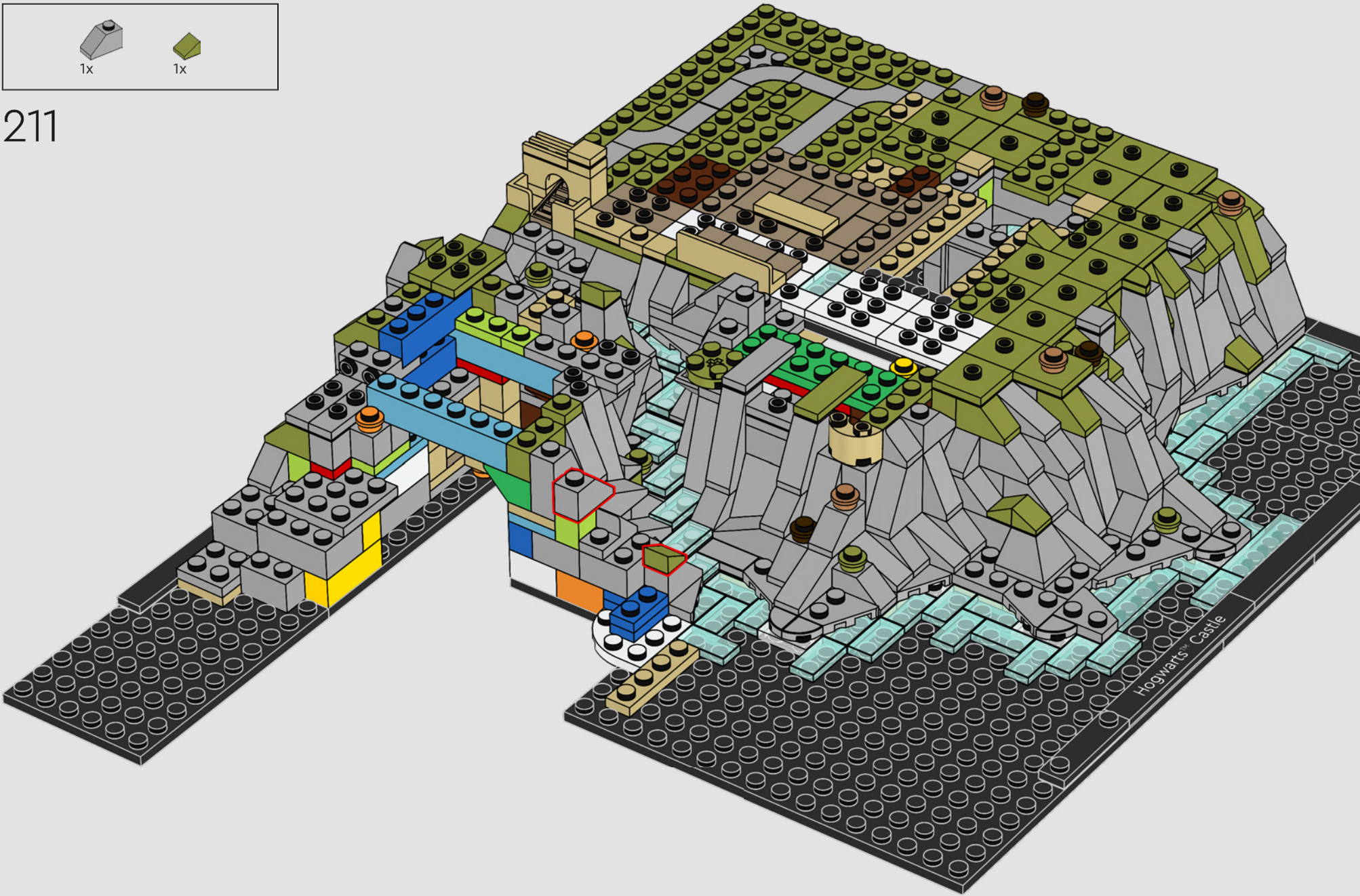



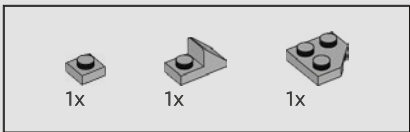

212

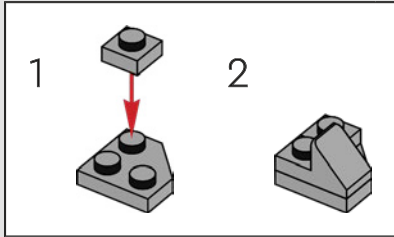
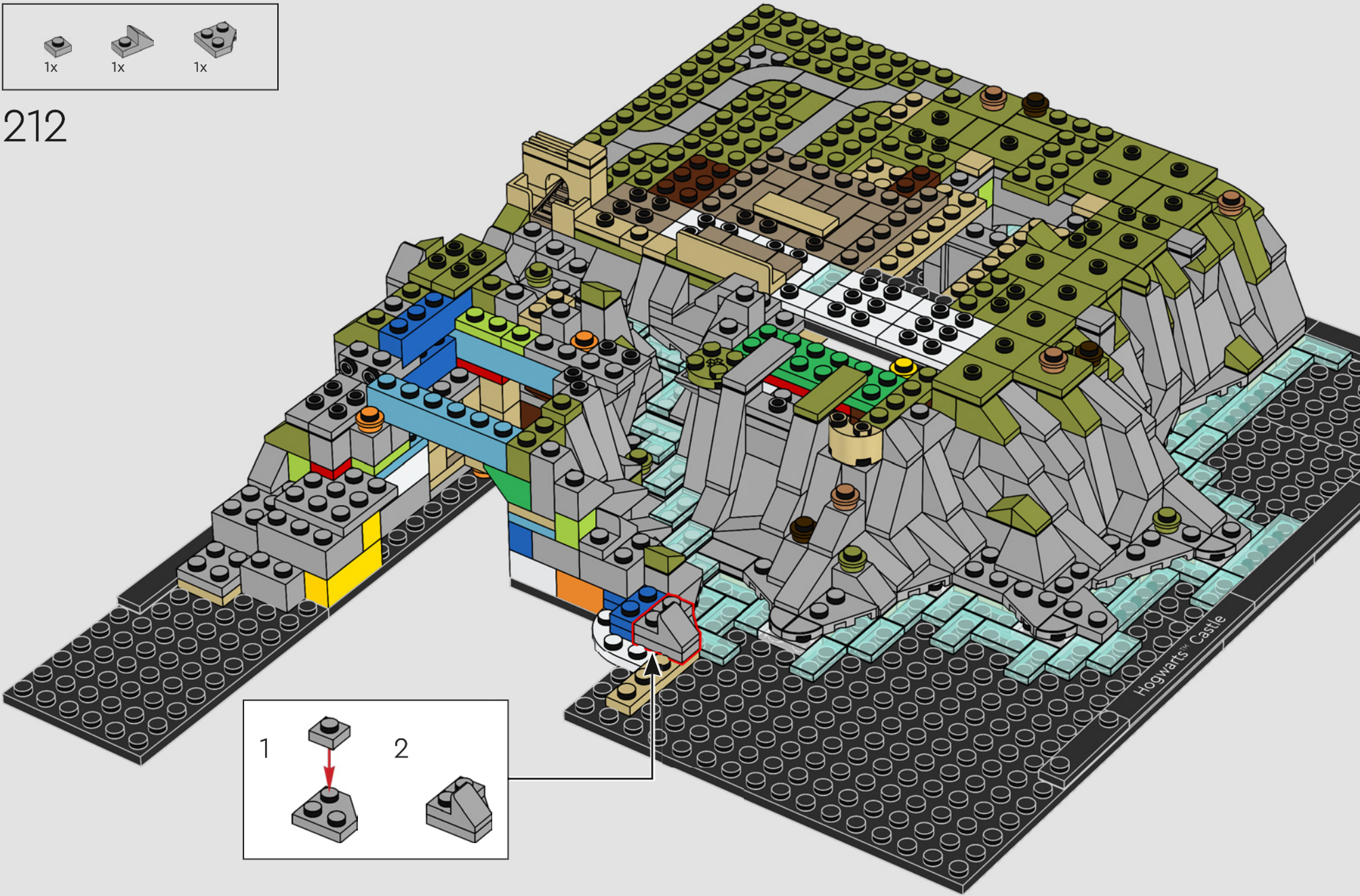

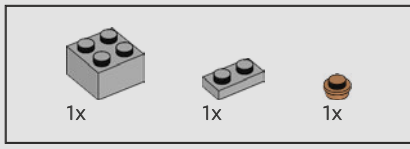

213

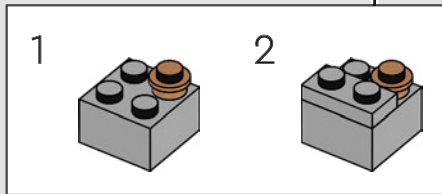
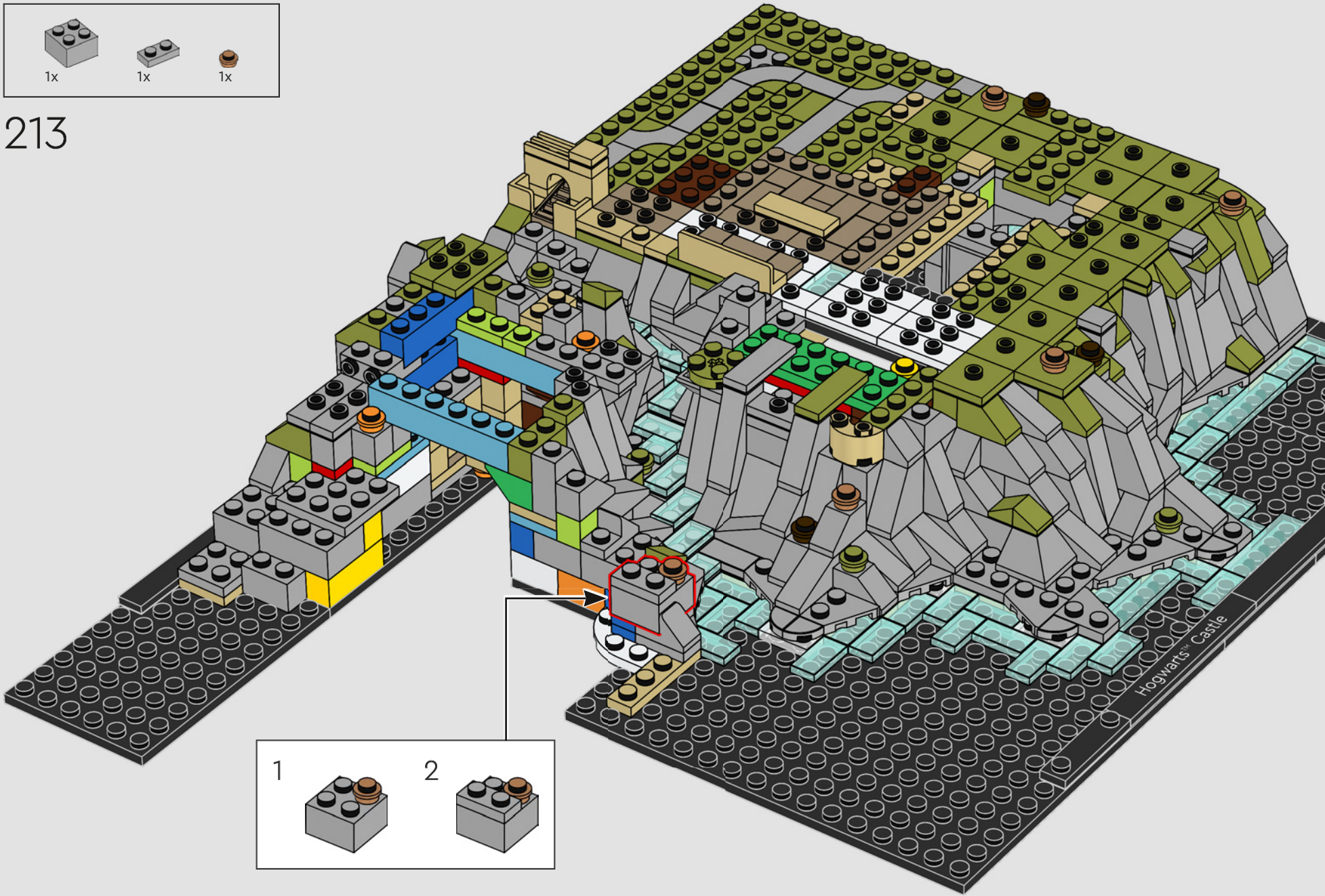

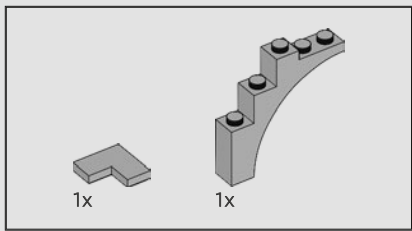

214

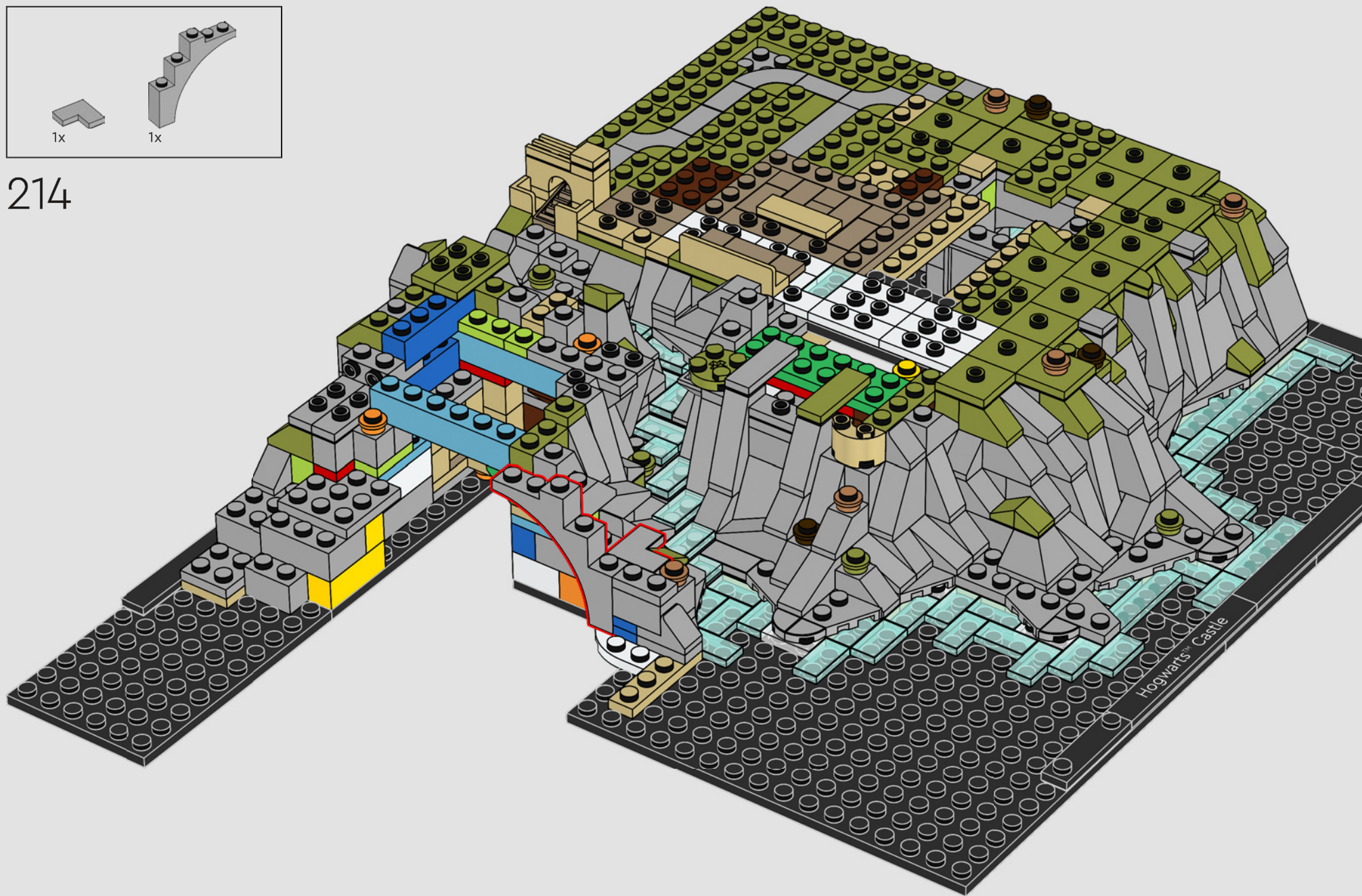



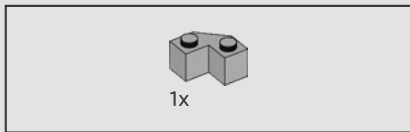

215

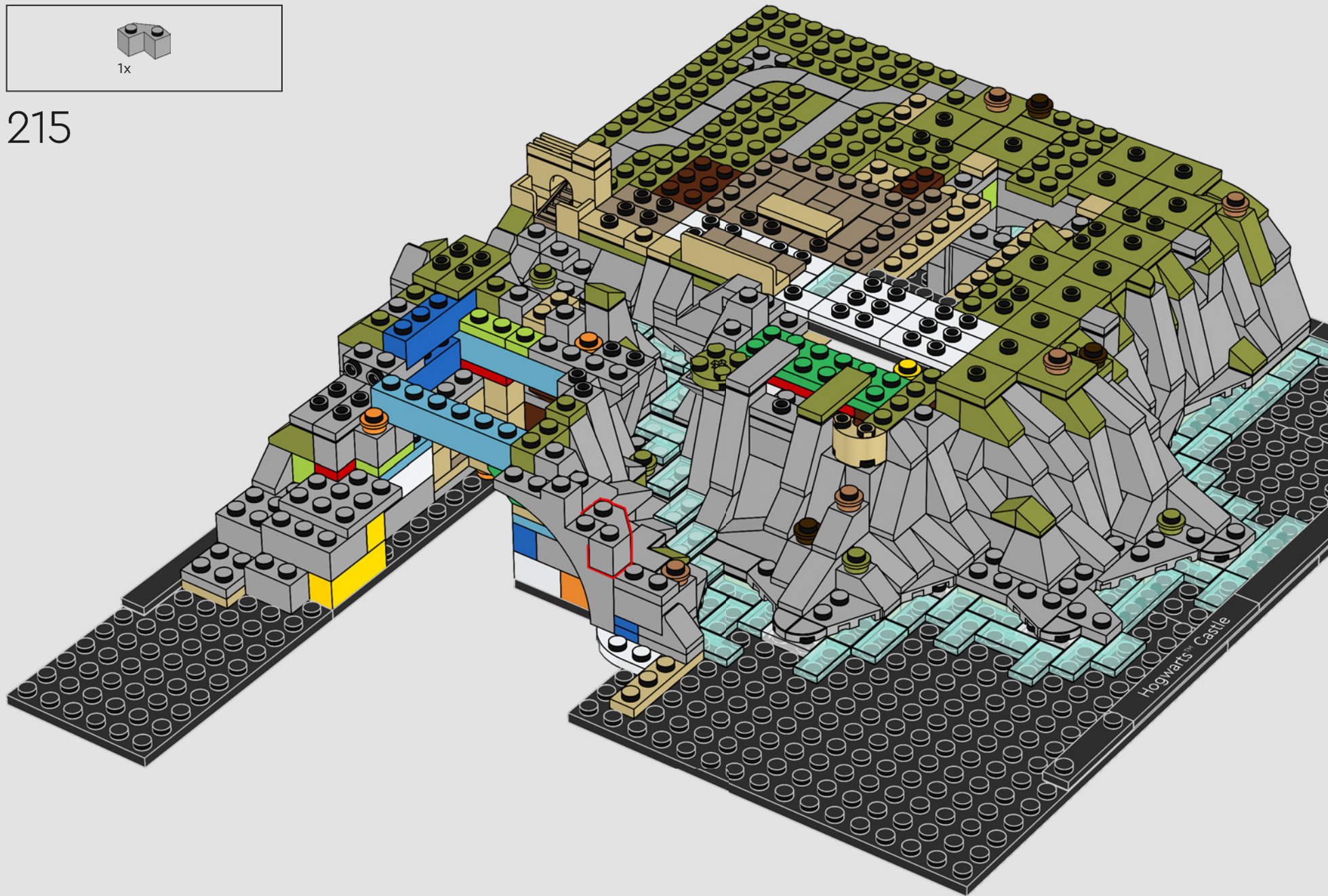

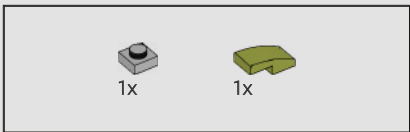

216

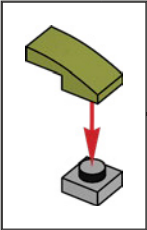
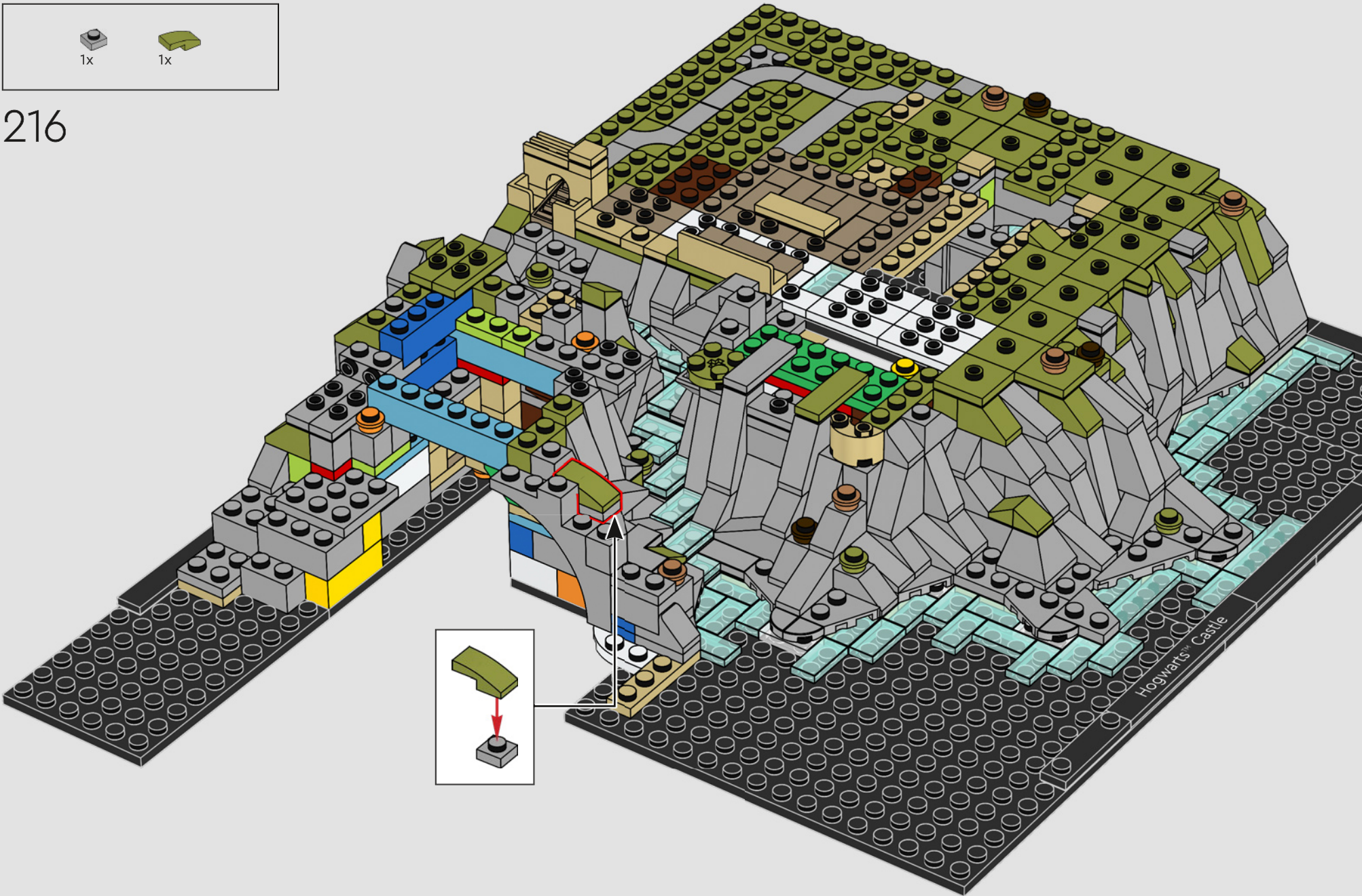

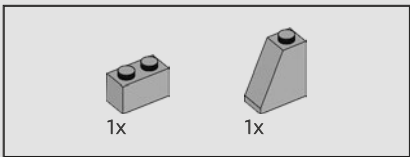

217



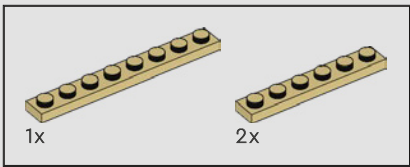

218

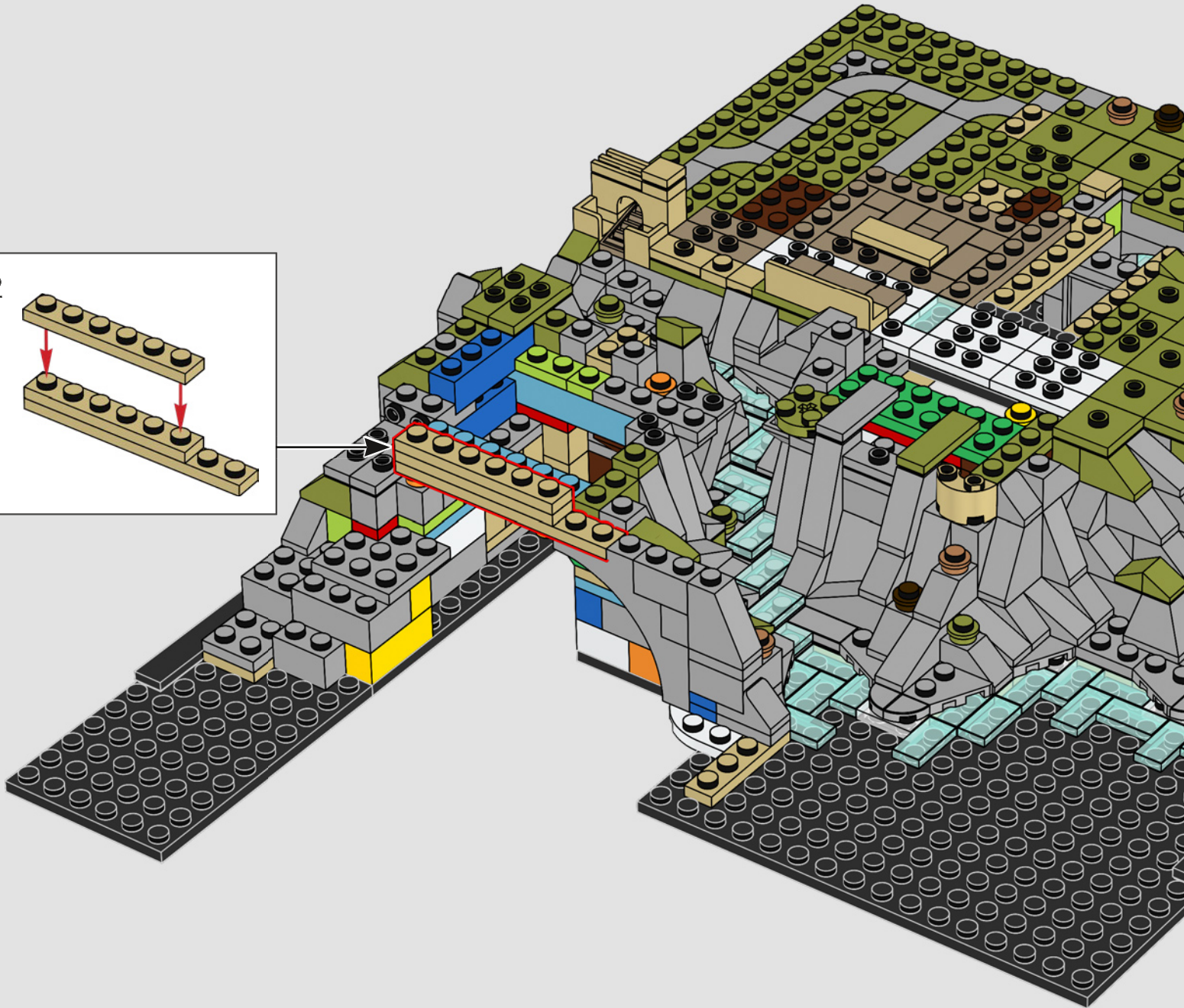
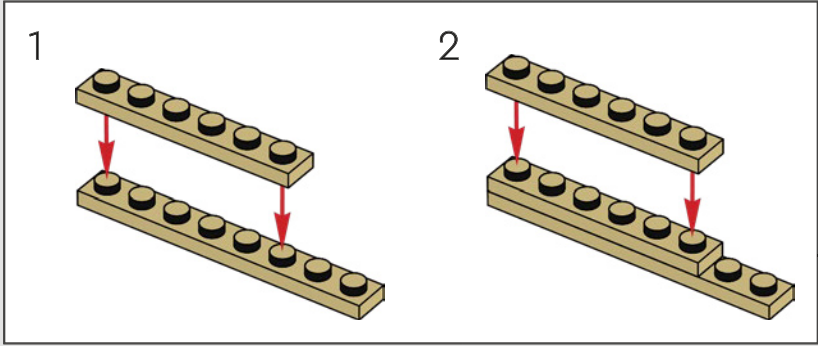

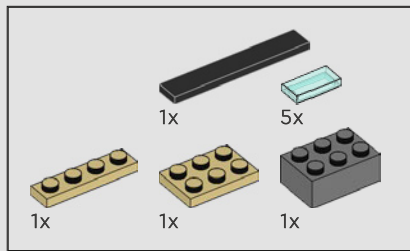

219

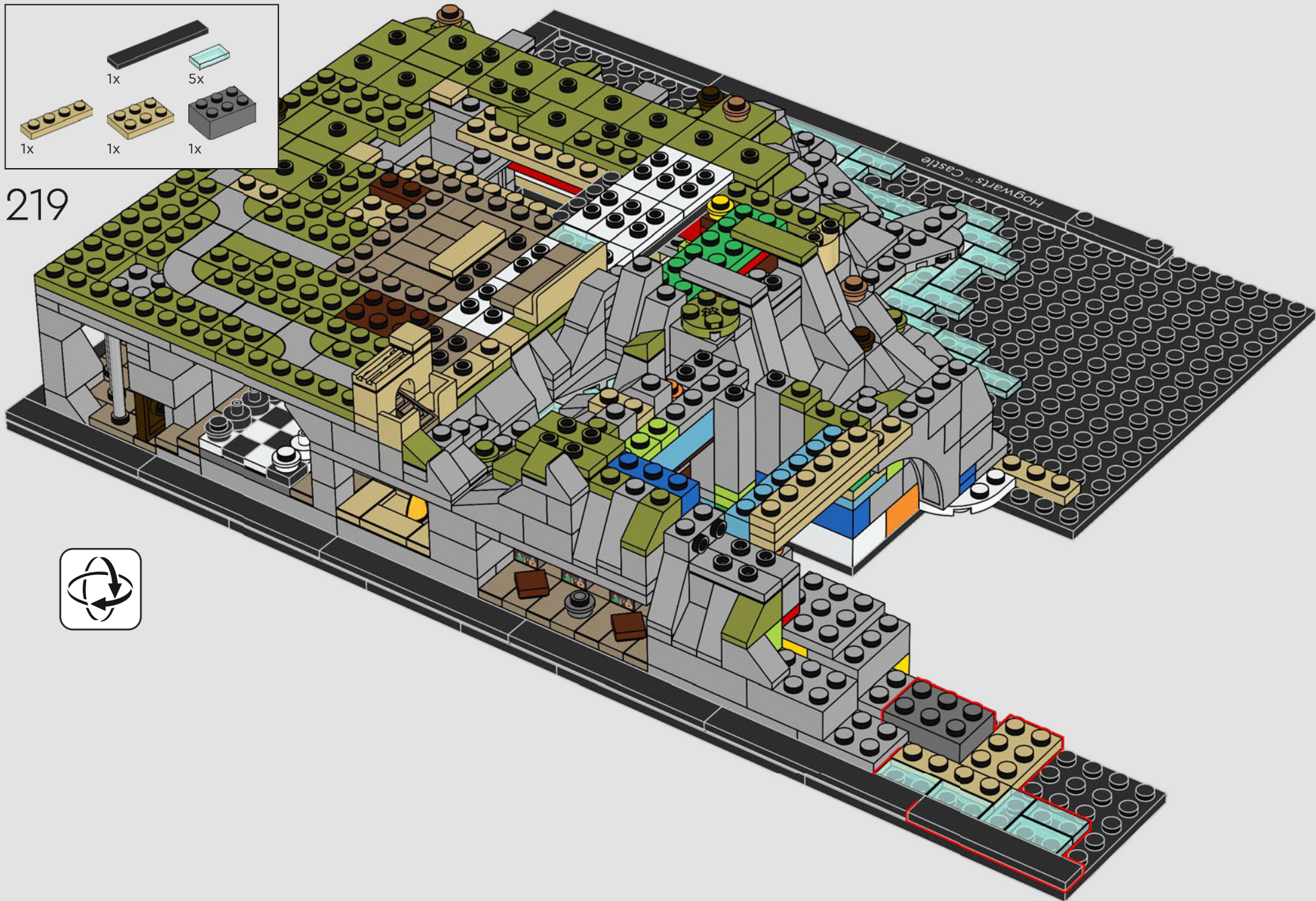

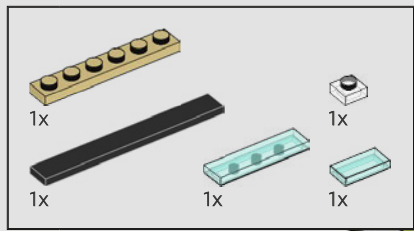

220



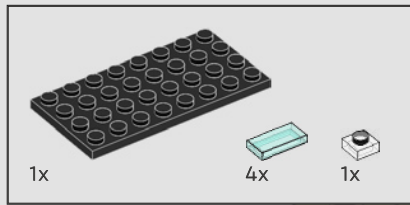

221

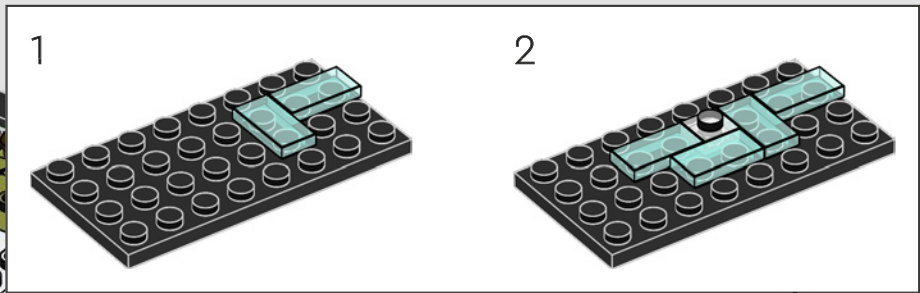

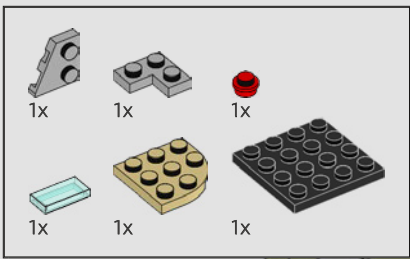

222

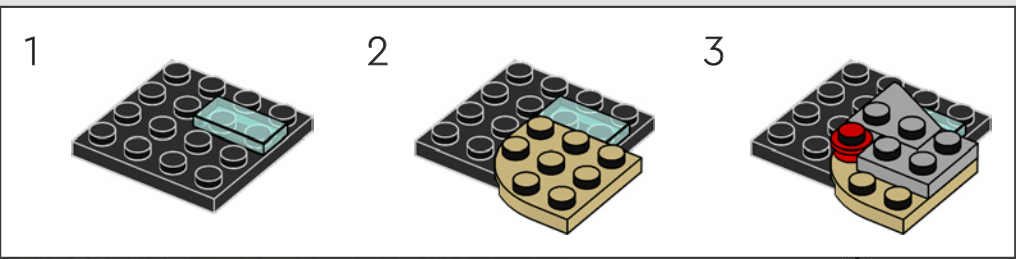



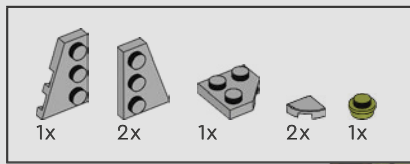

223



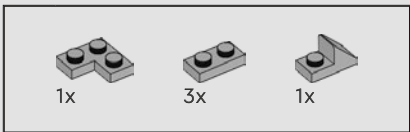

224

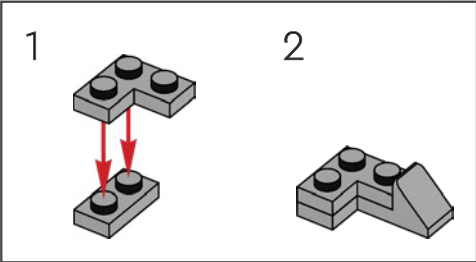
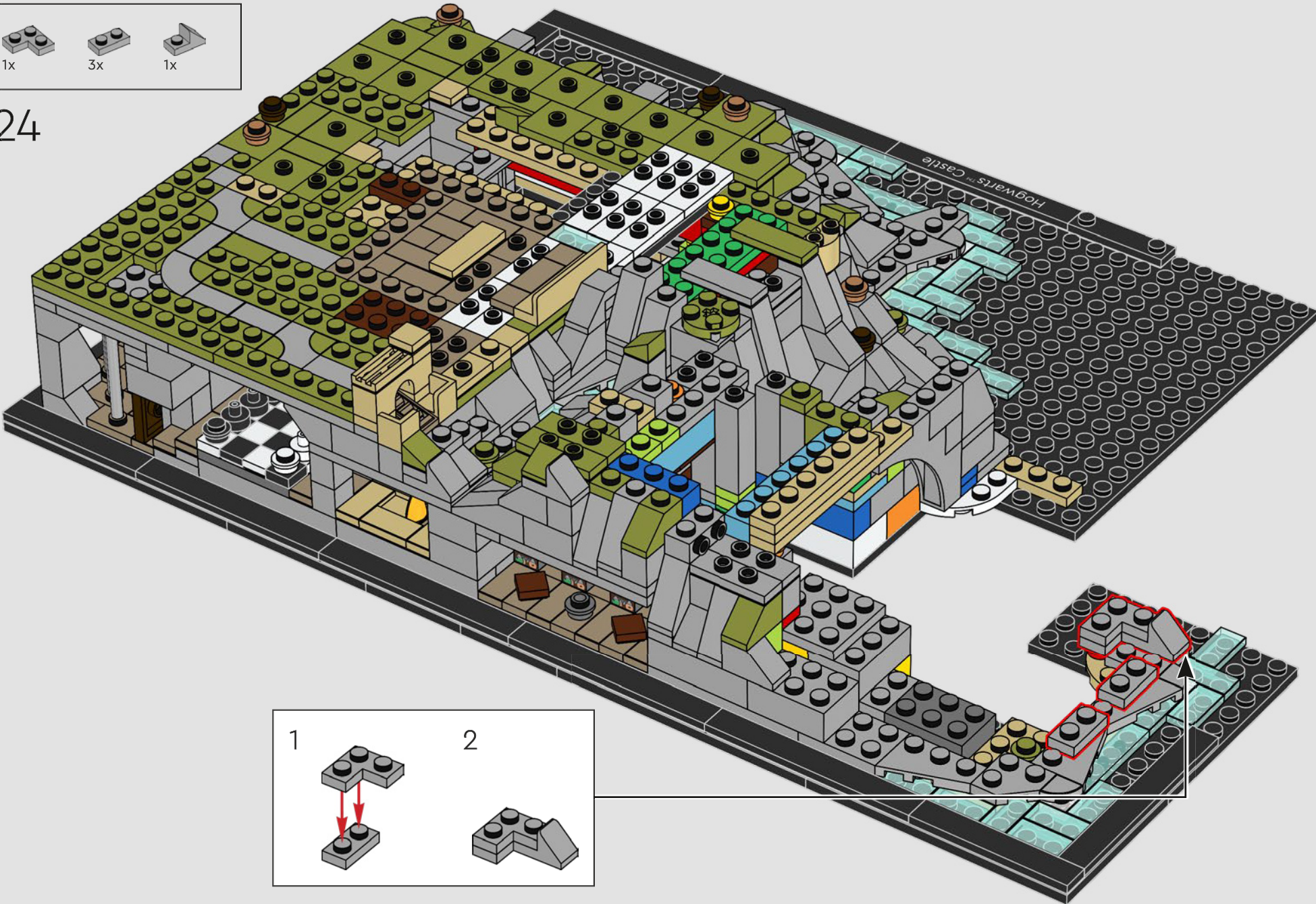

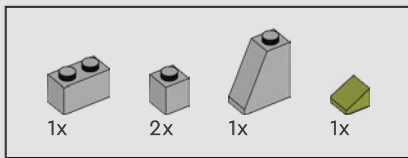

225

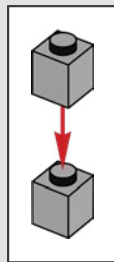
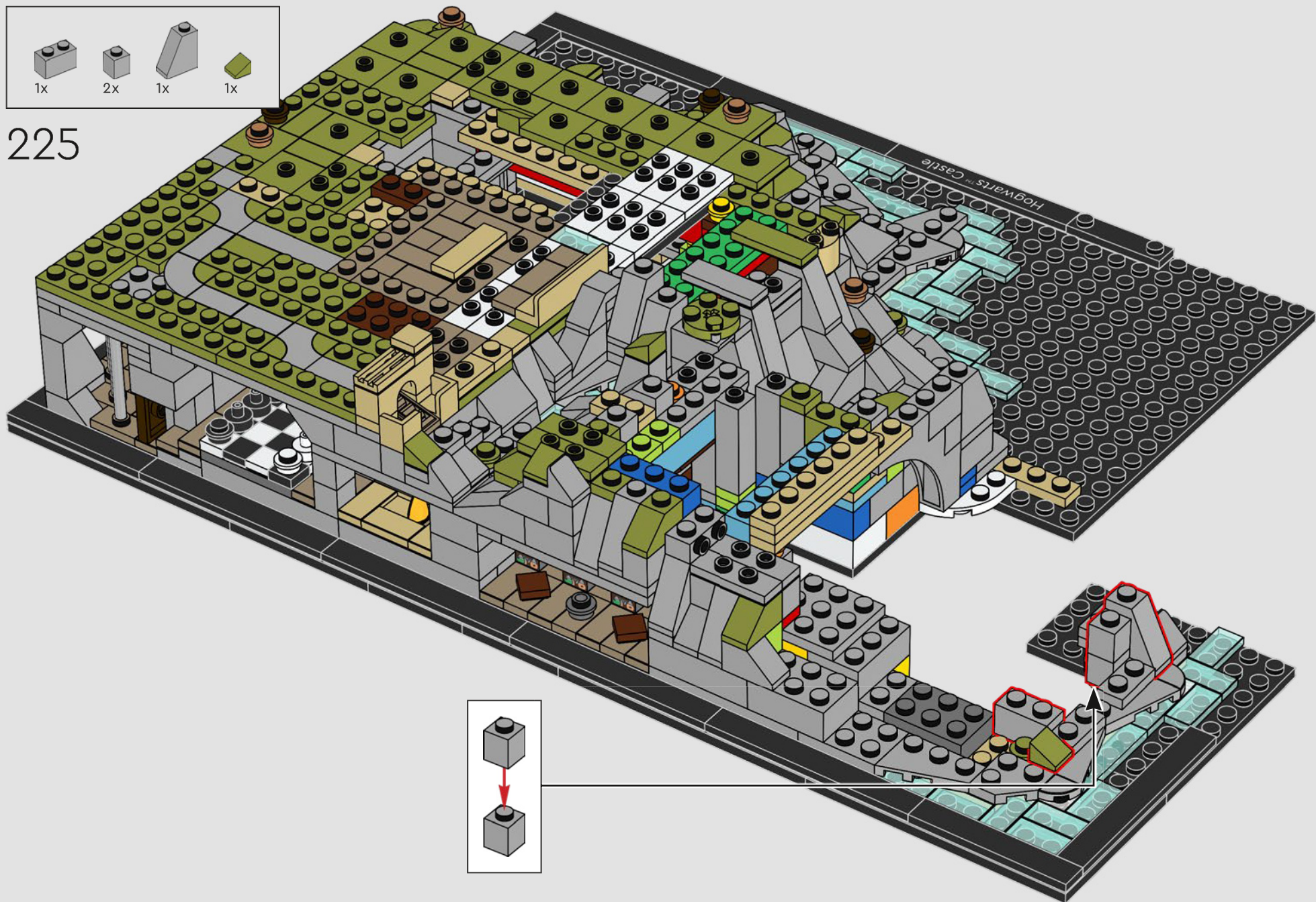

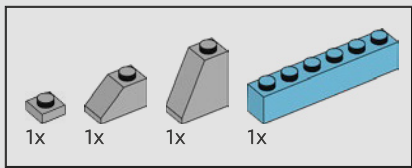

226



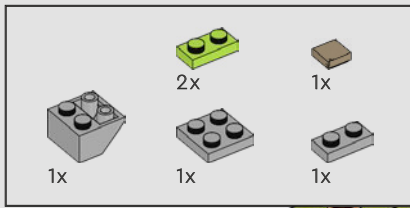

227

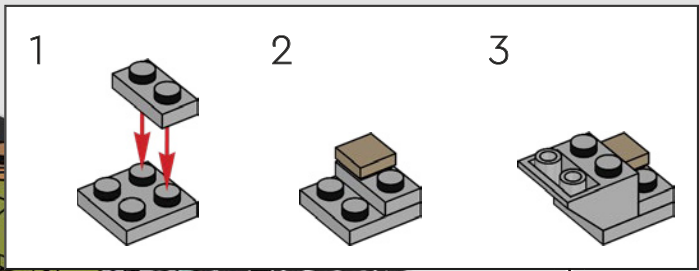

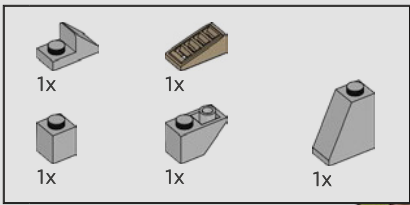

228

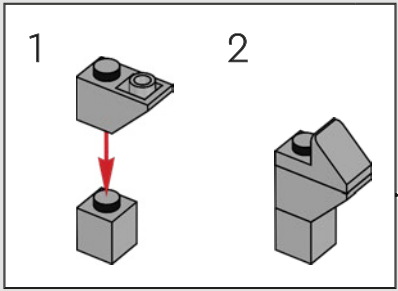
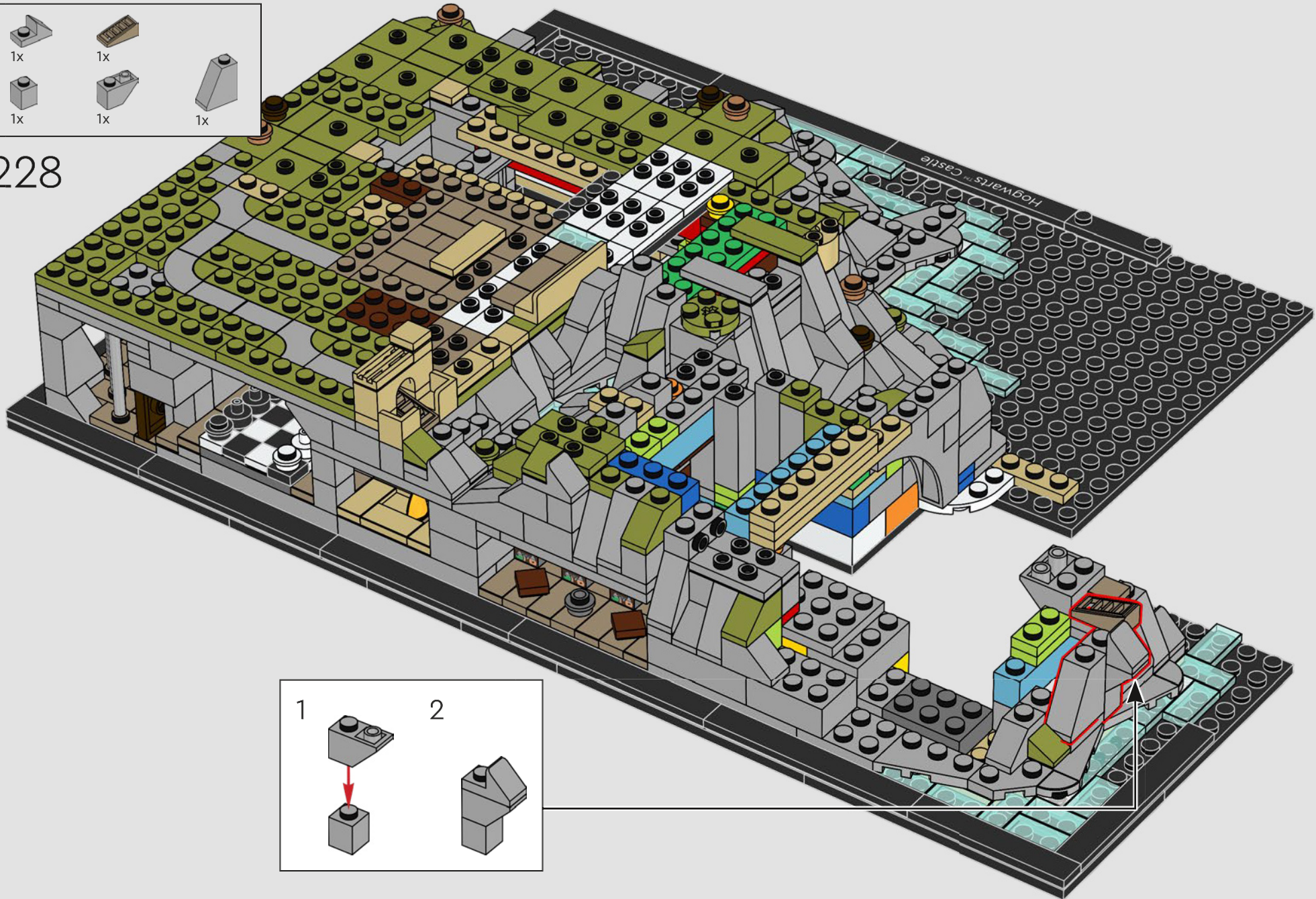

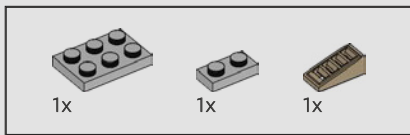

229

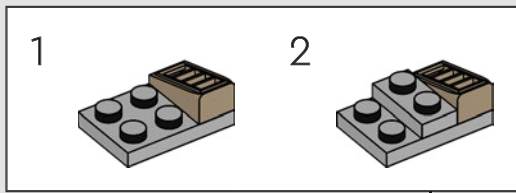

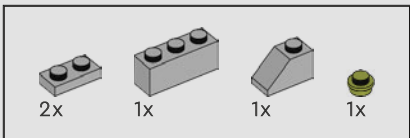

230





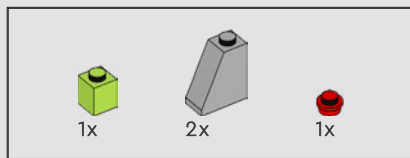

231

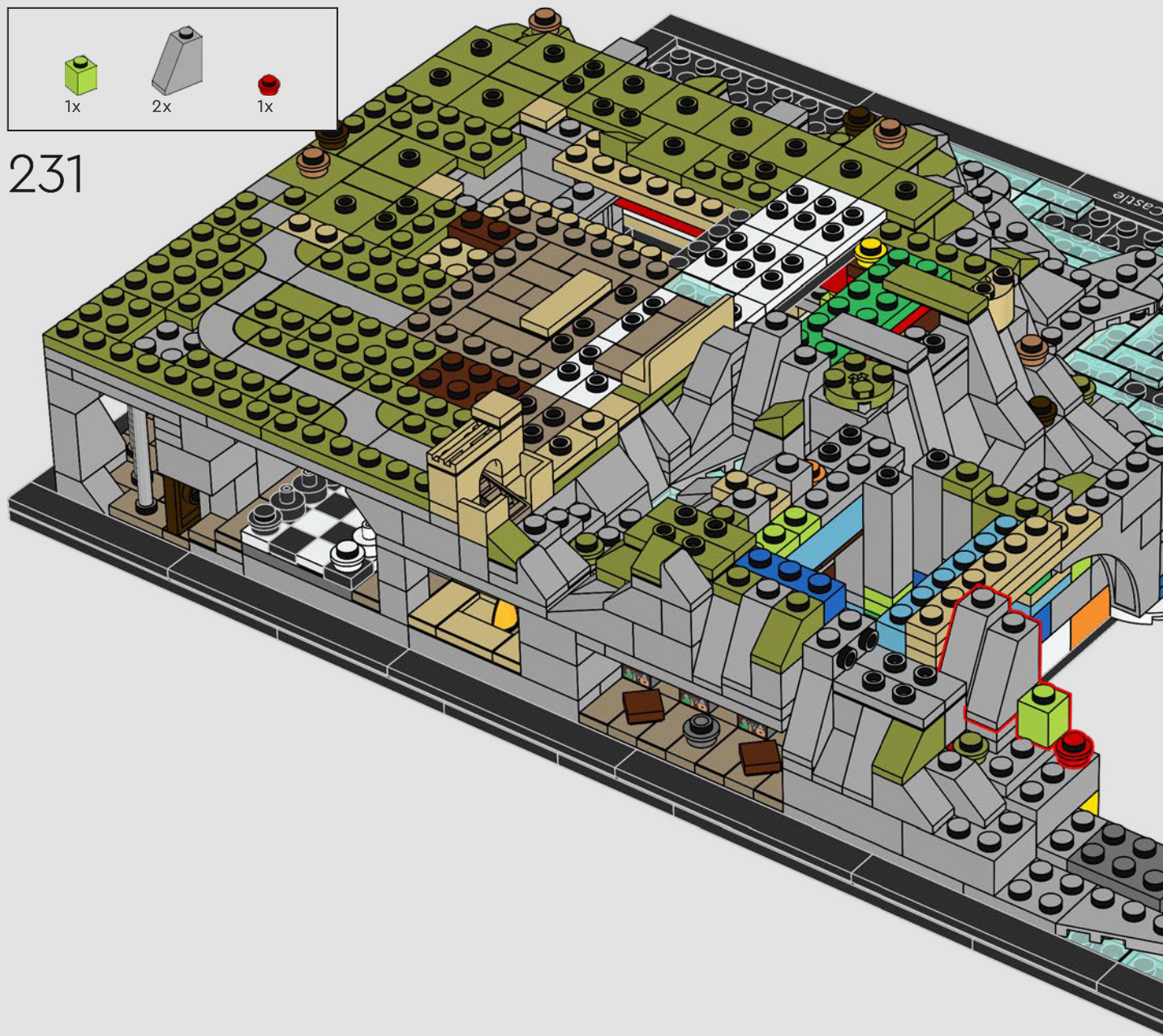

Though the four founders were longtime friends, Salazar Slytherin™ had a deep mistrust of Muggles™ which eventually led him to abandon the school and his three partners in magic.

Bien que les quatre fondateurs étaient des amis de longue date, Salazar Serpentard avait une profonde méfiance envers les Moldus, ce qui l'a finalement conduit à abandonner l'école et ses trois partenaires.

Aunque los cuatro fundadores eran amigos desde hacía mucho tiempo, Salazar Slytherin™ sentía una profunda desconfianza hacia los Muggles™ que, finalmente, lo llevó a abandonar la escuela y a sus tres compañeros en la magia.



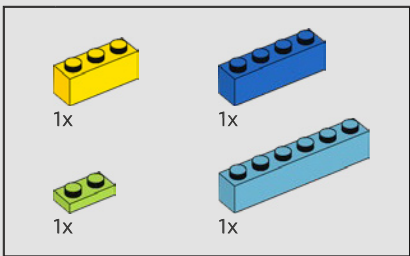

232

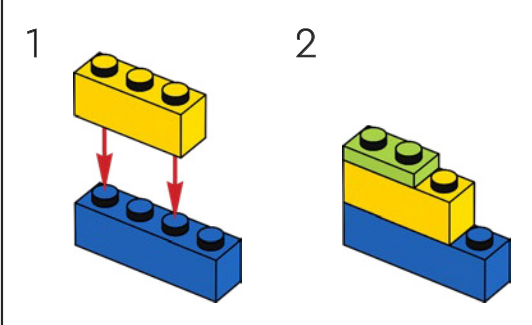
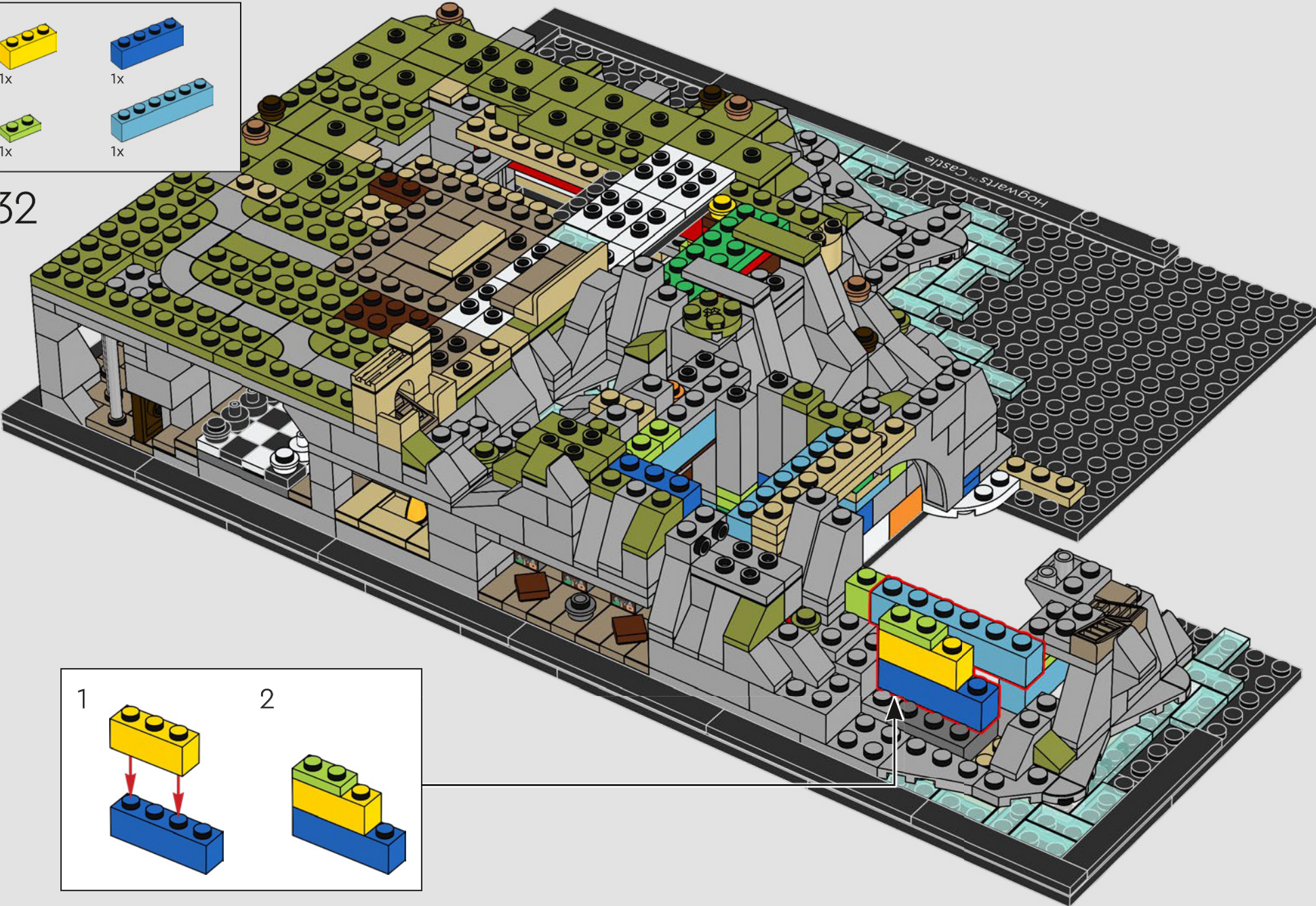

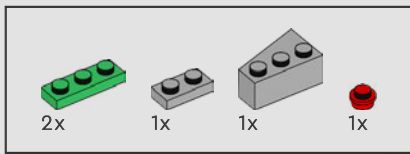

233

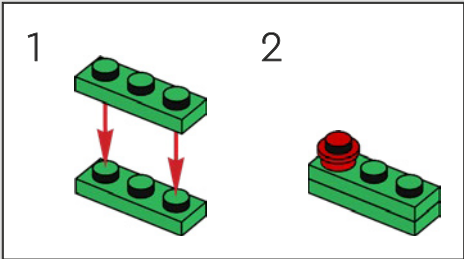
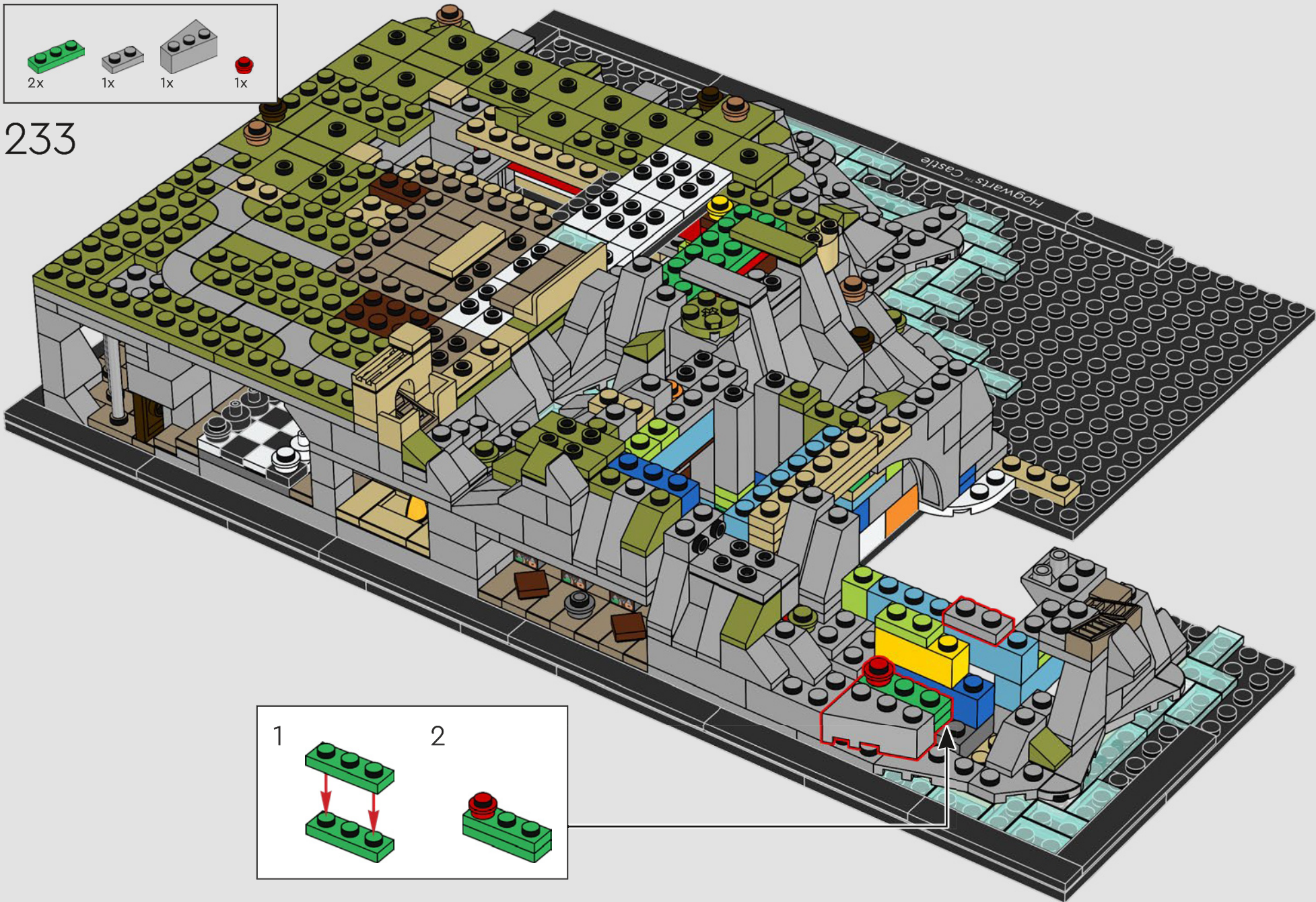

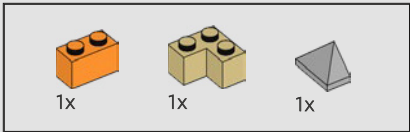

234



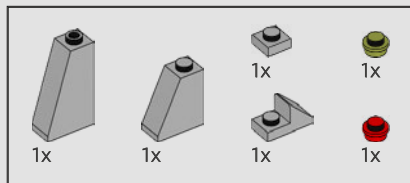

235



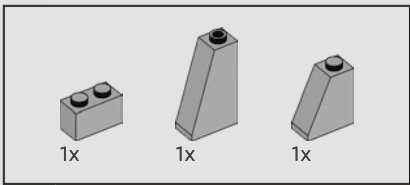

236

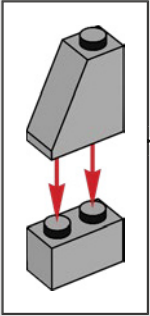
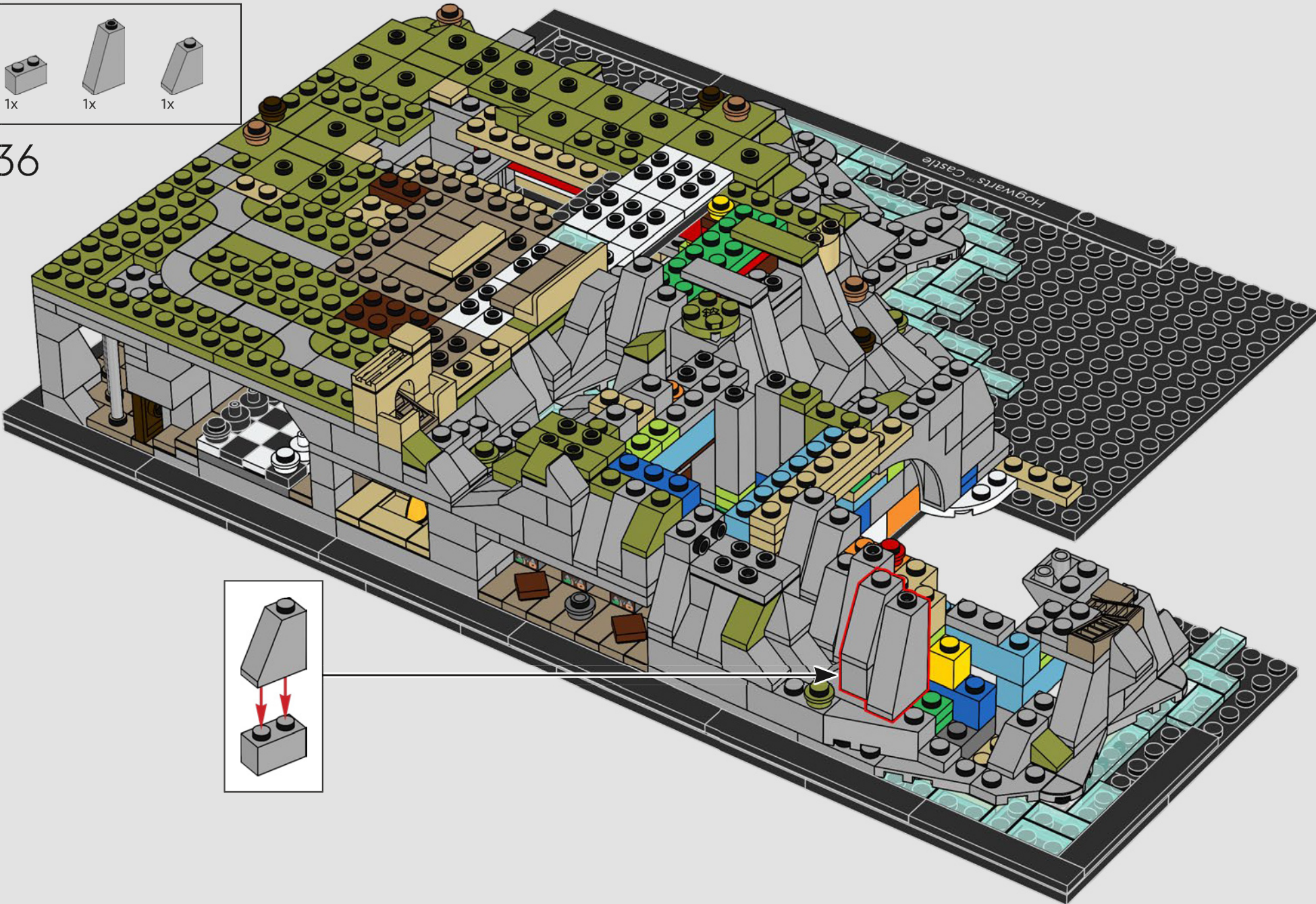

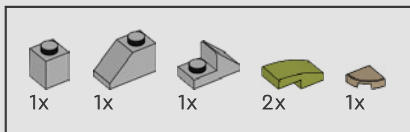

237

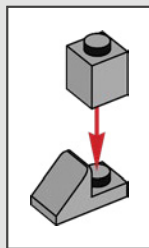
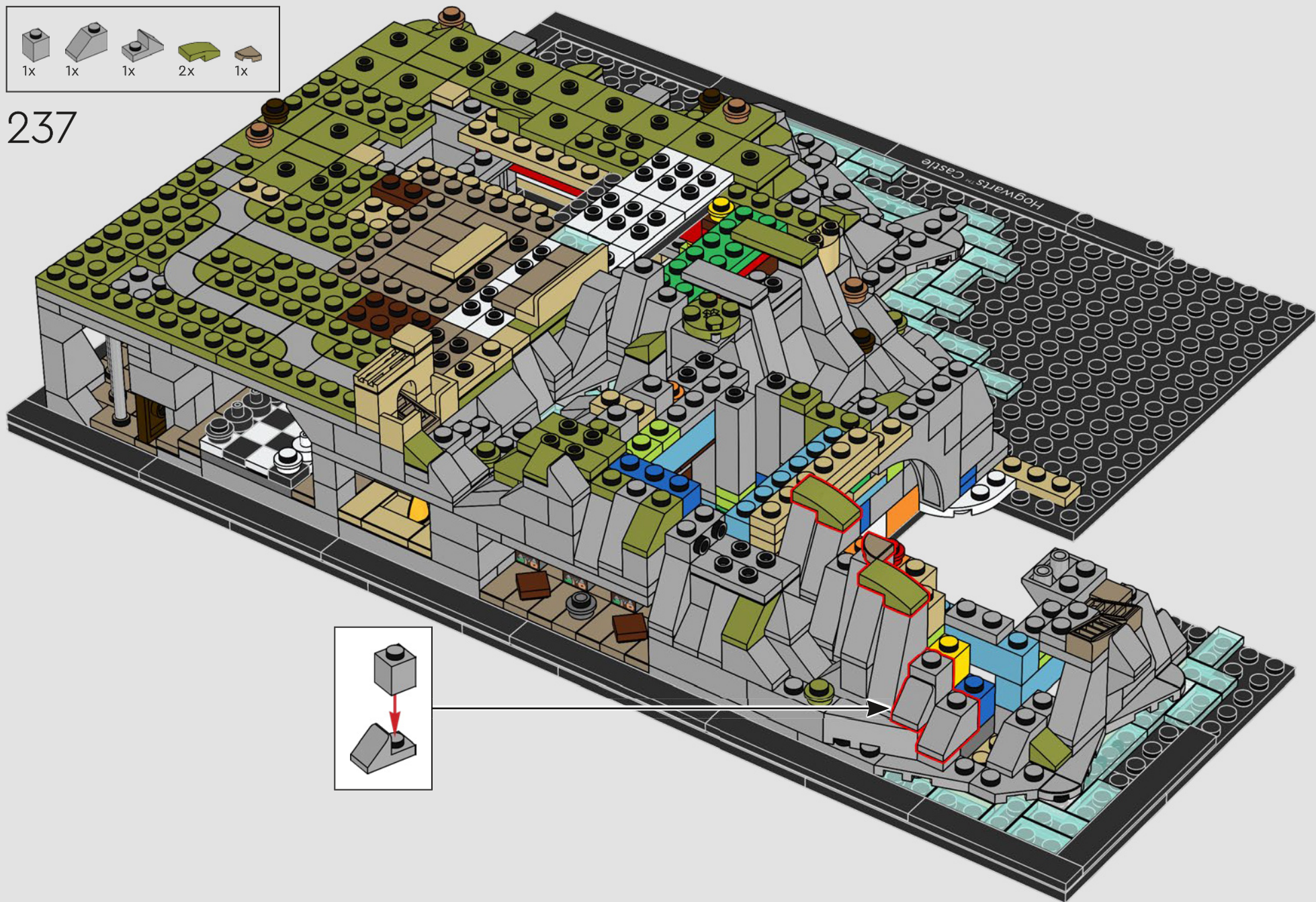

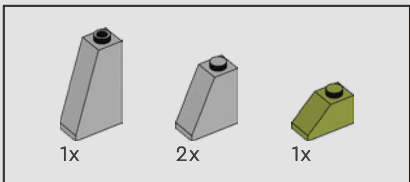

238





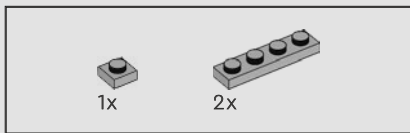

239

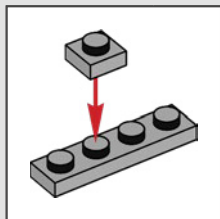
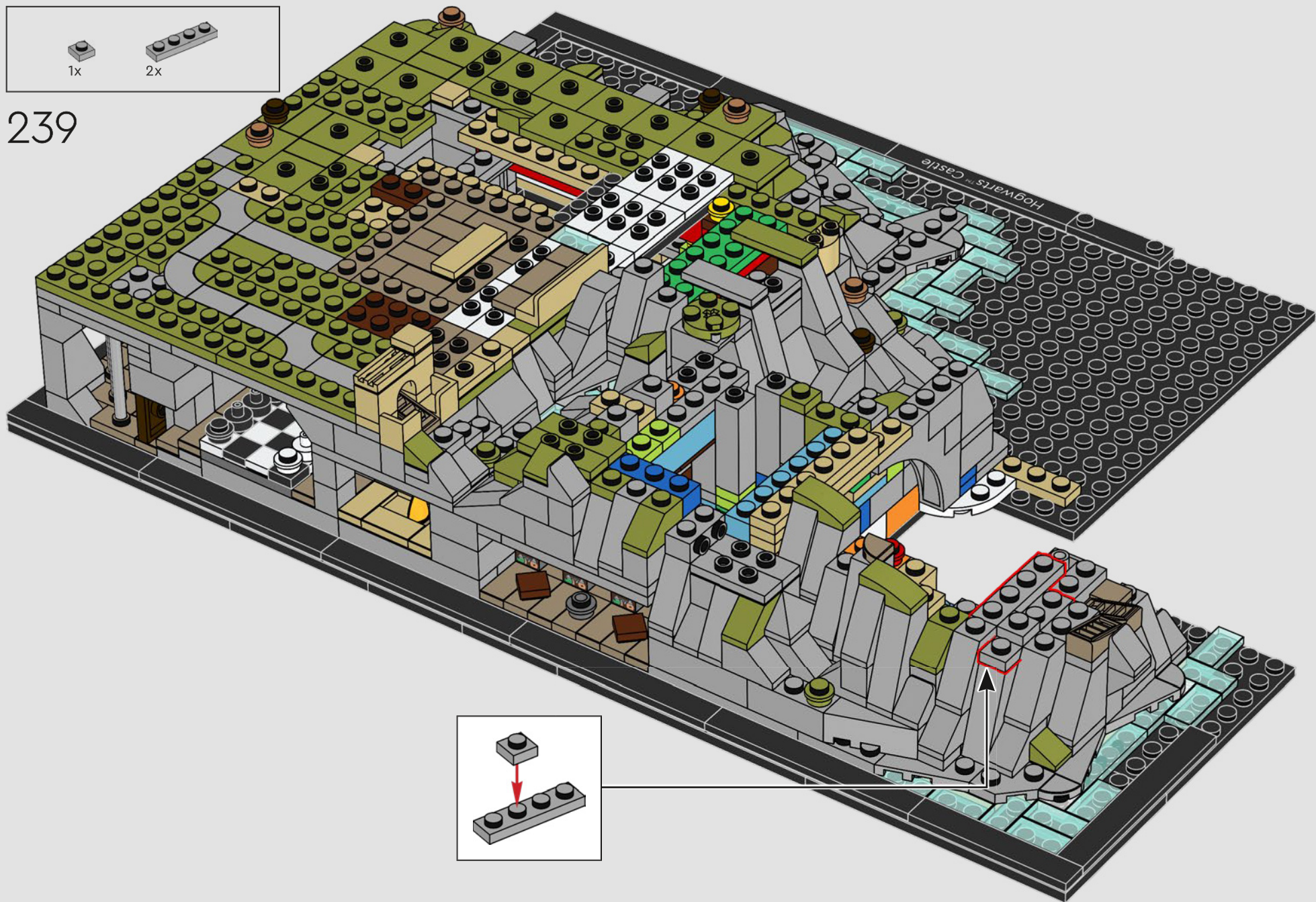



240





241

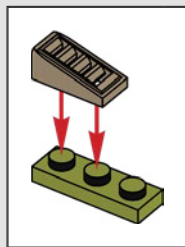
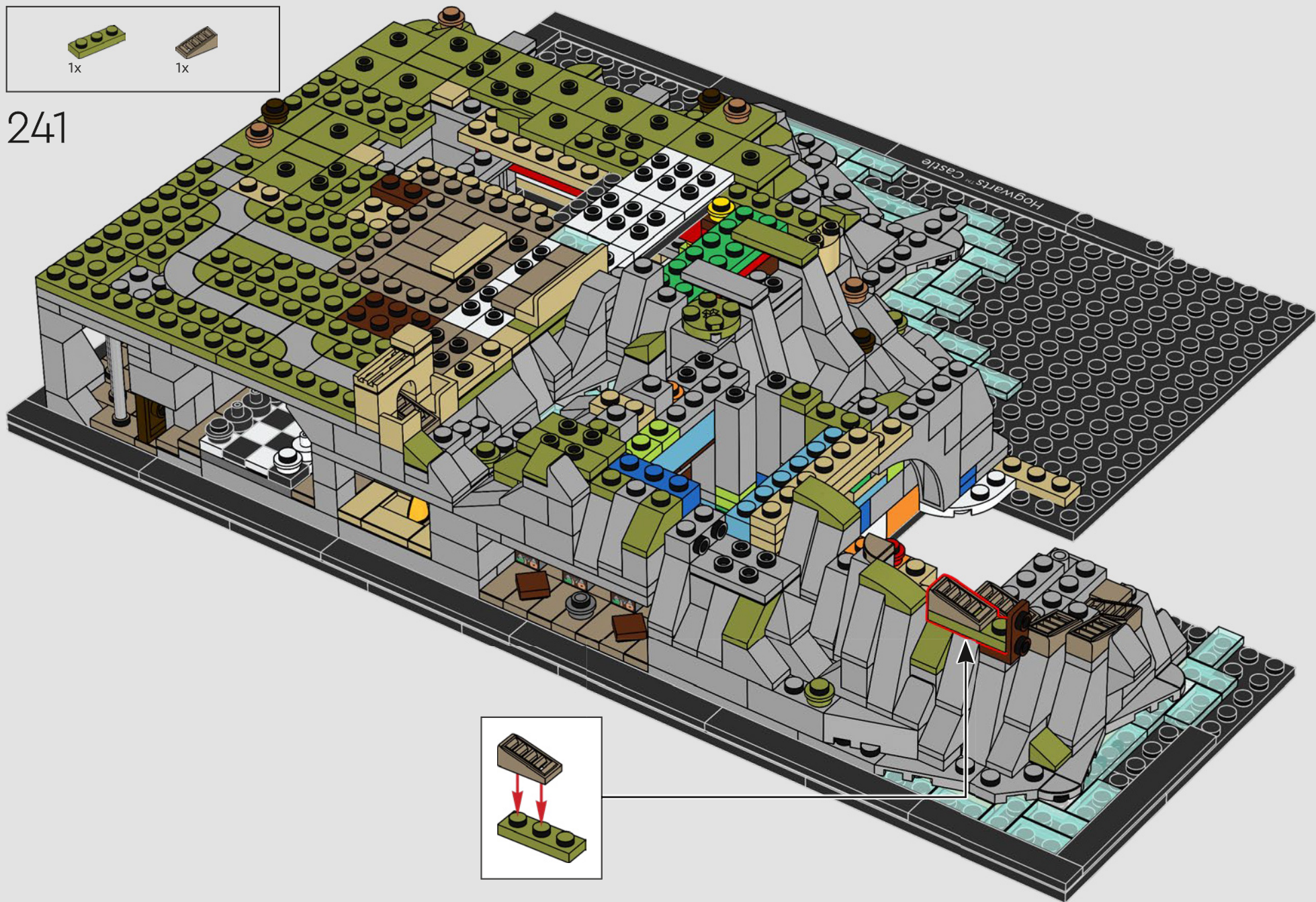



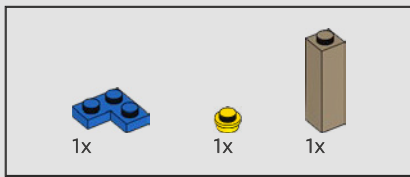

242

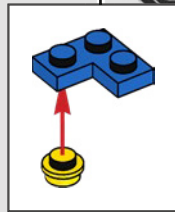
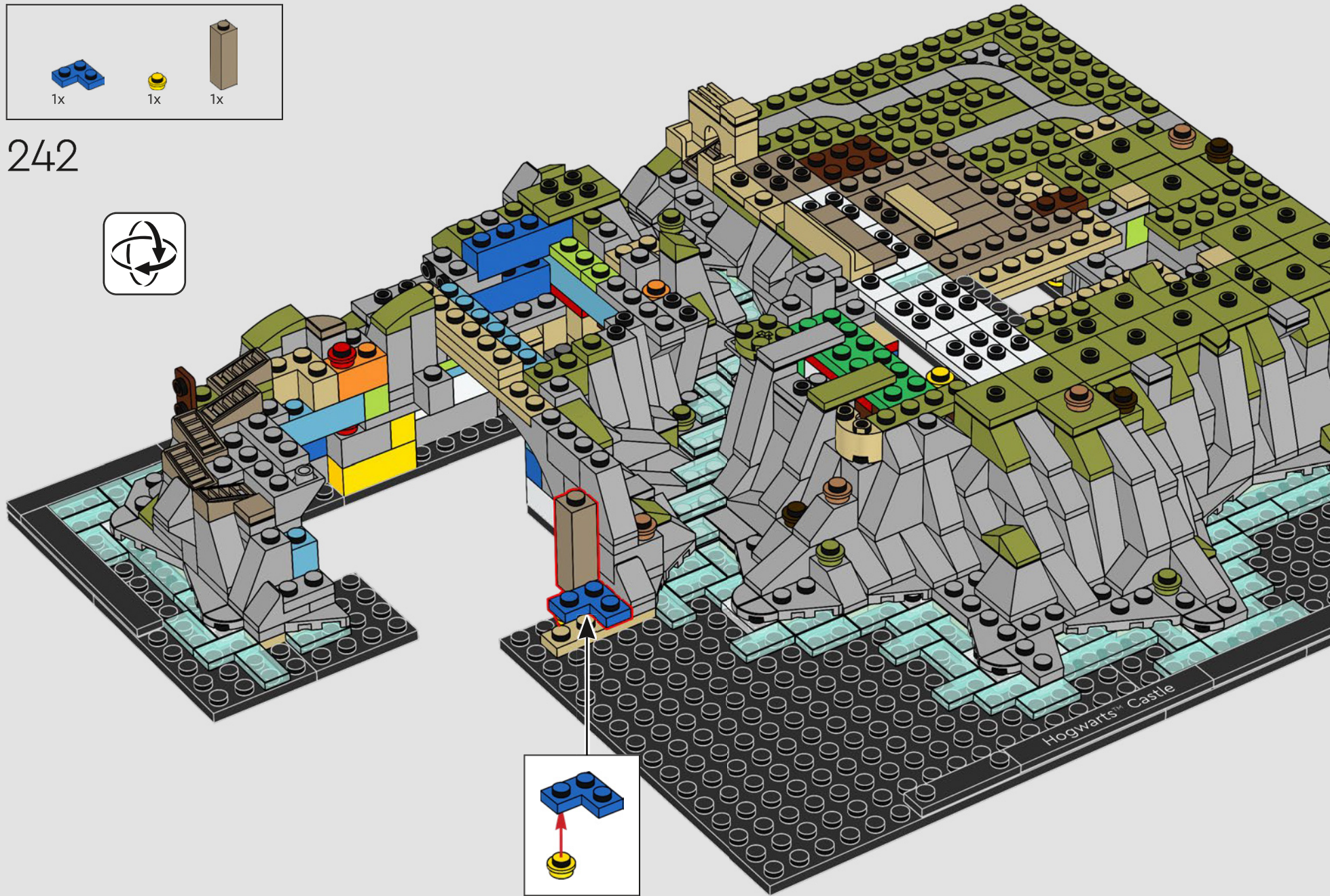

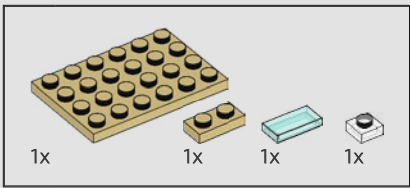

243

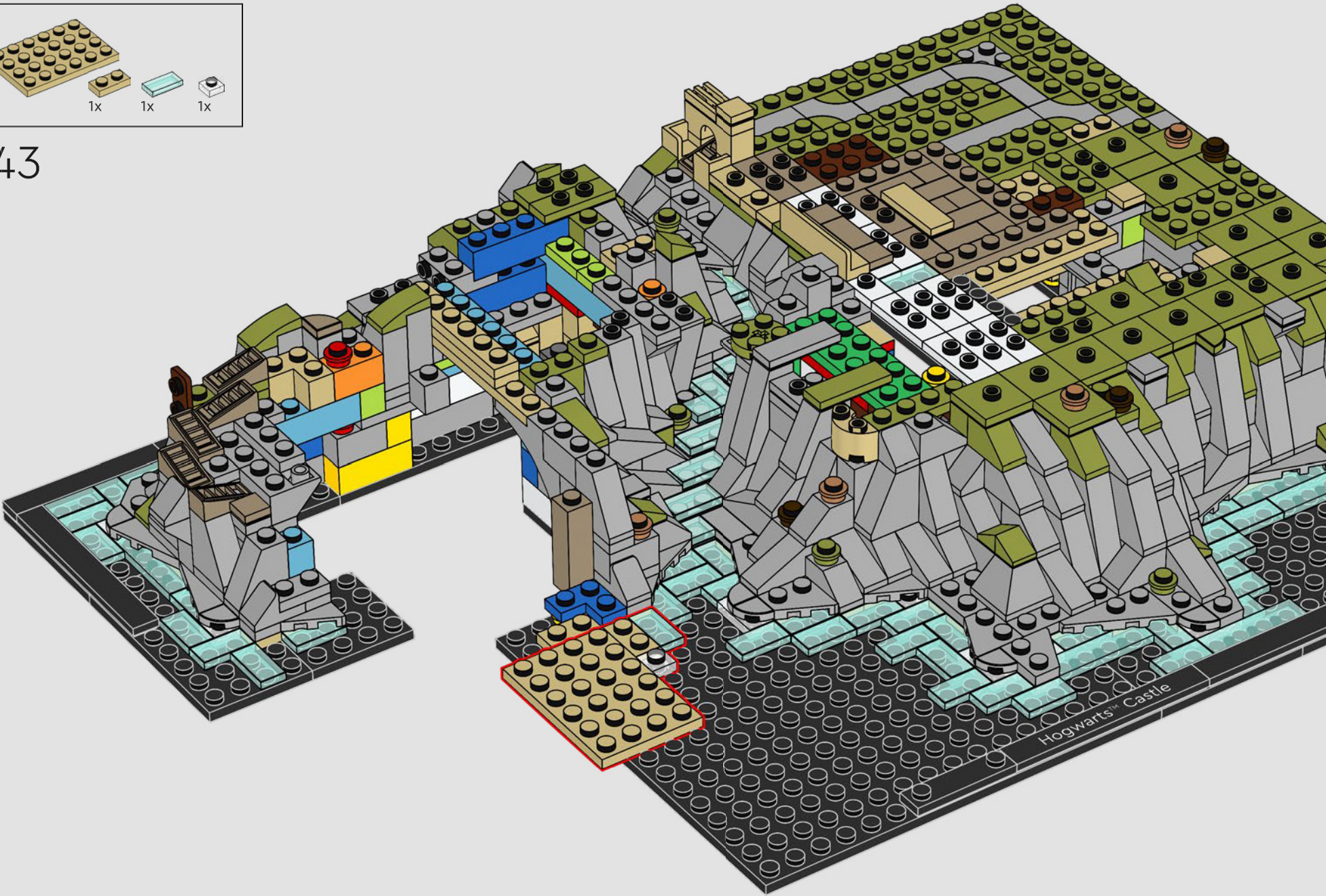

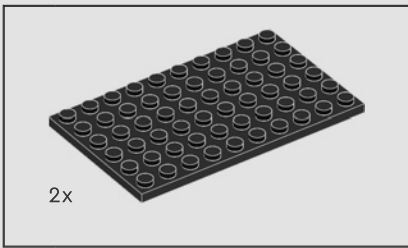

244

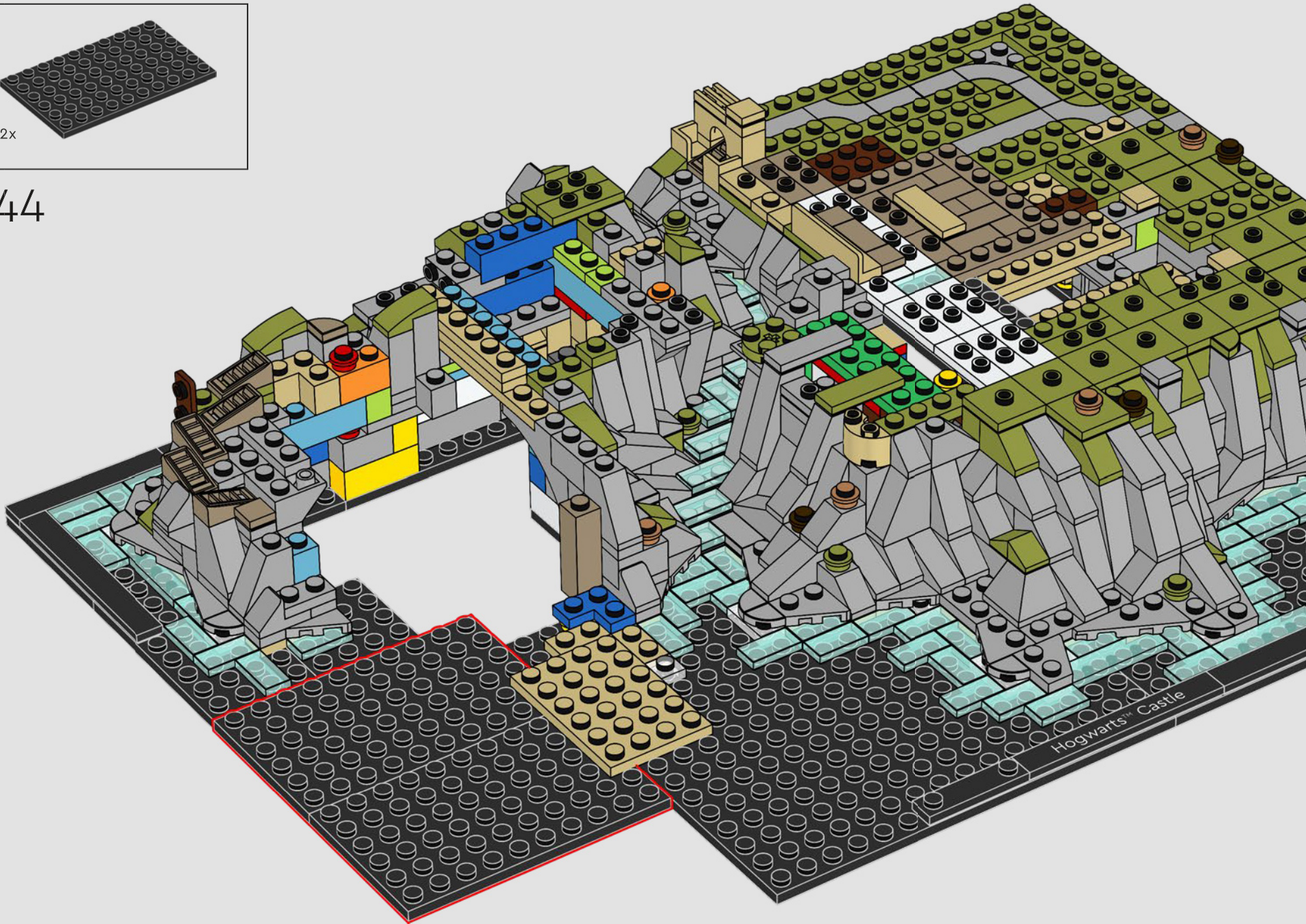

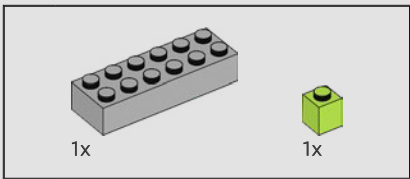

245

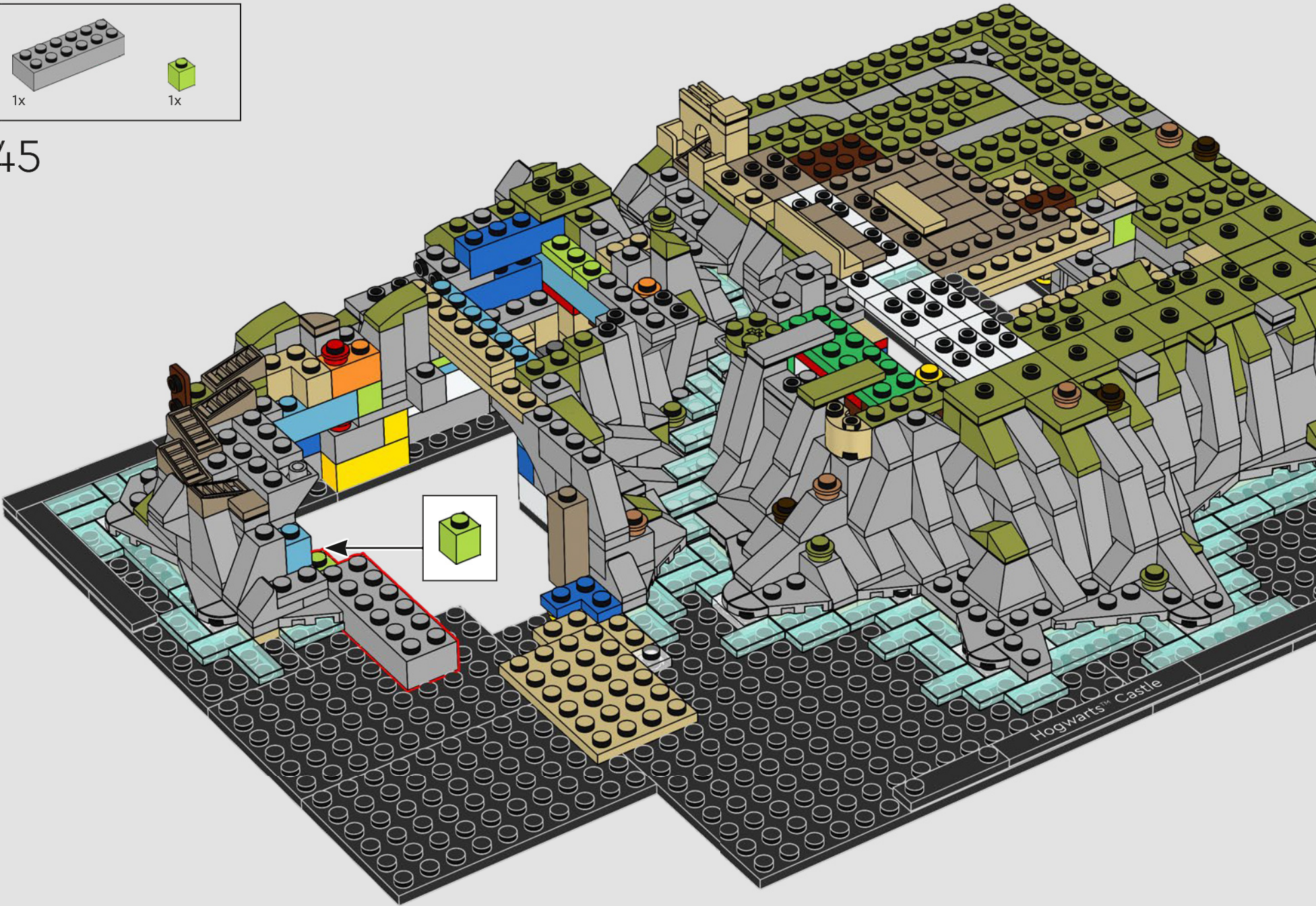



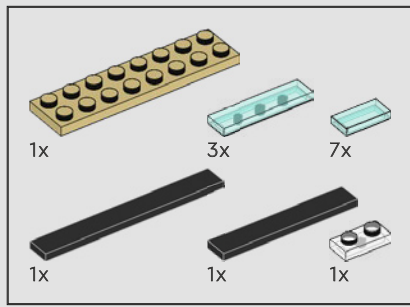

246

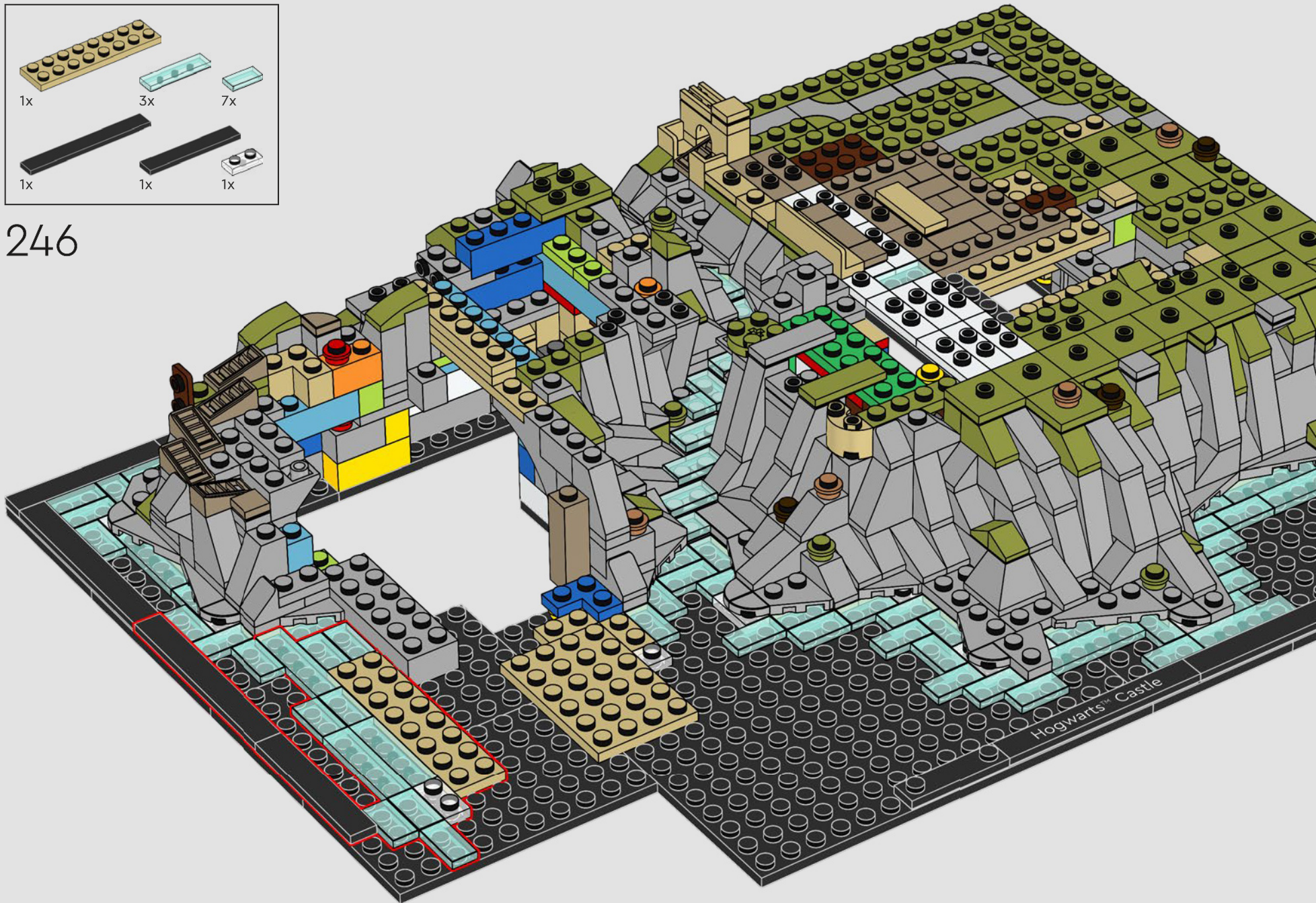

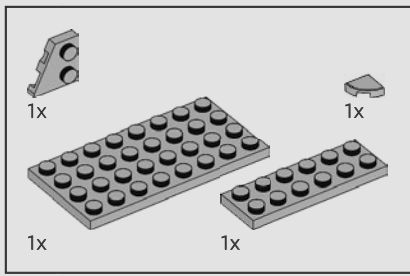

247

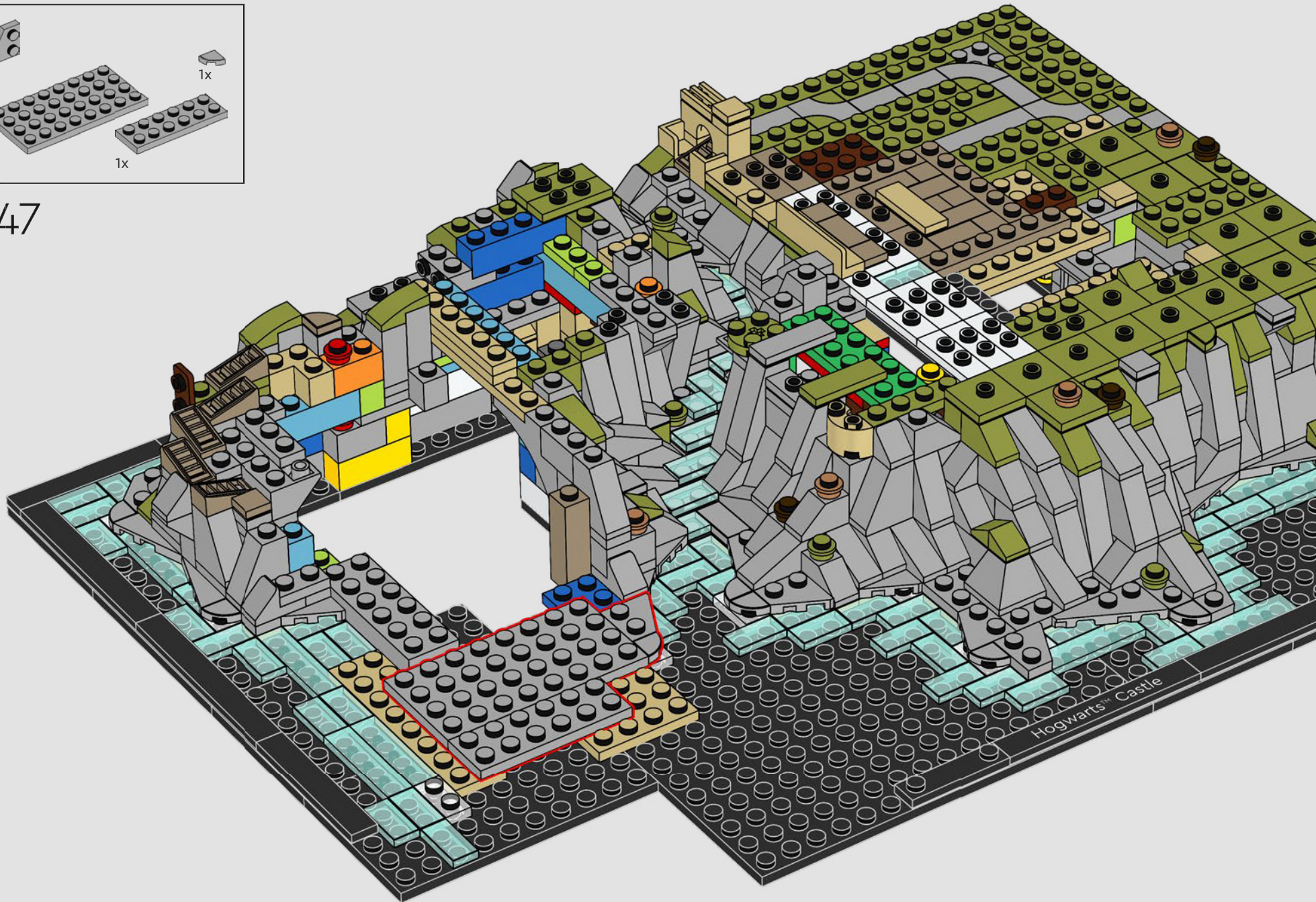

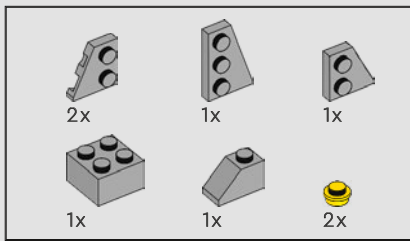

248

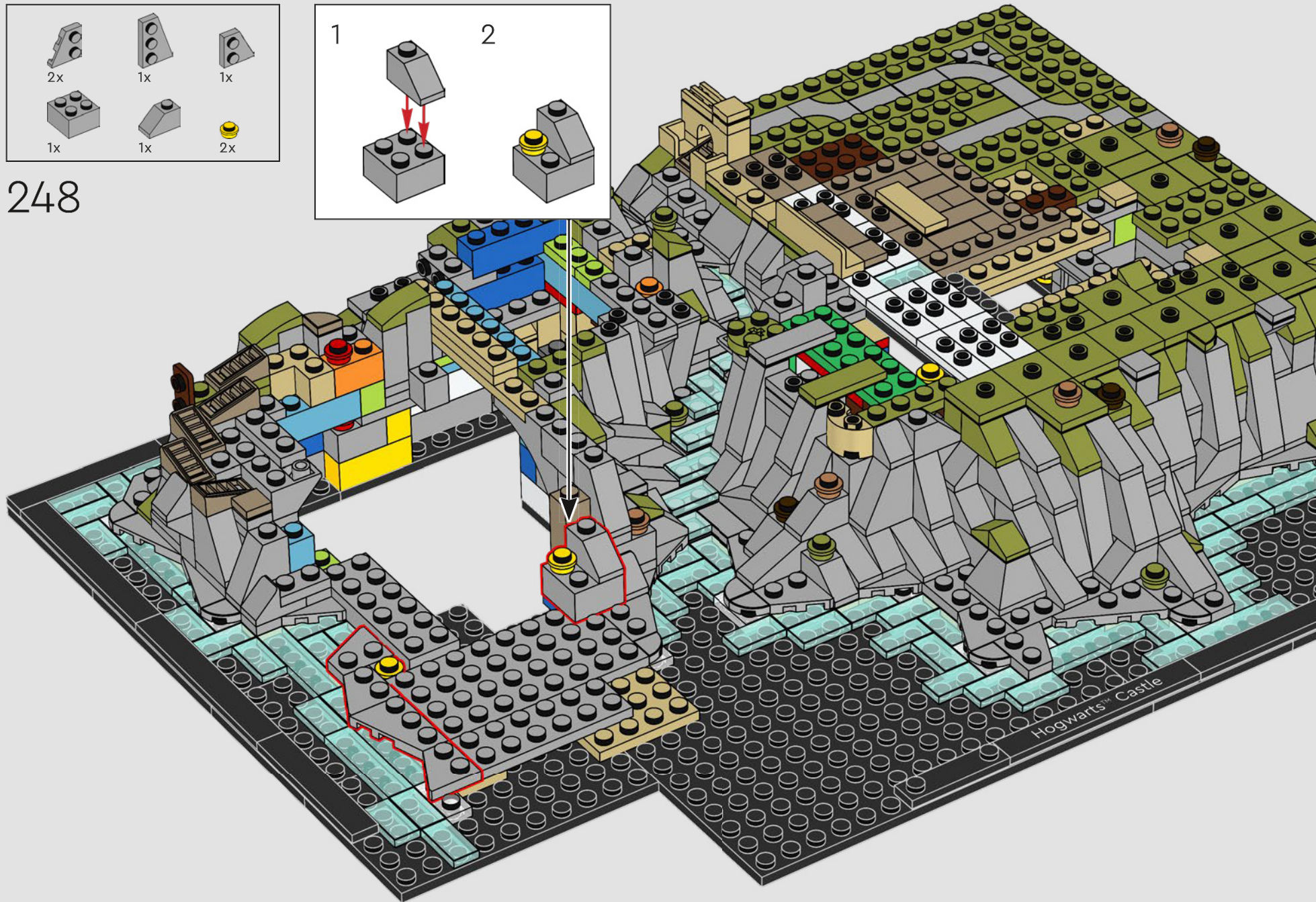
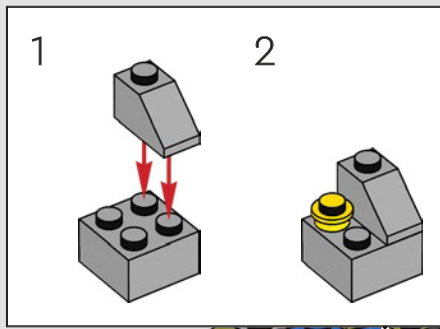

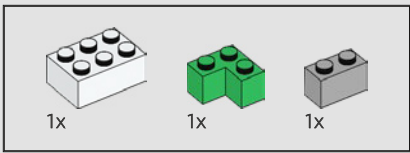

249

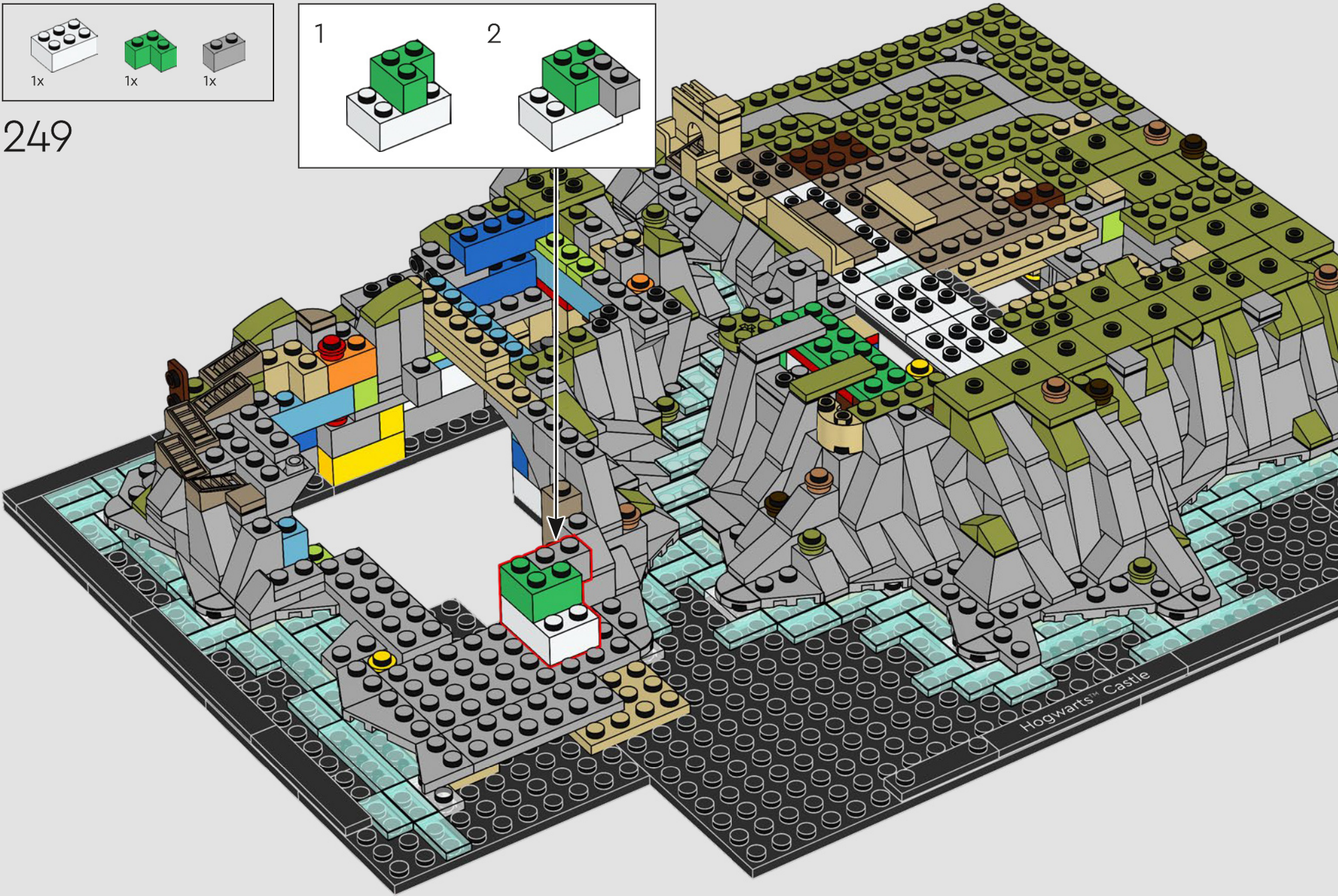
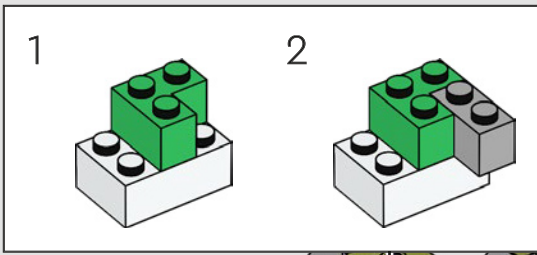

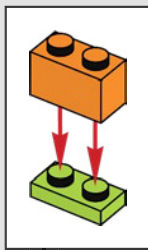
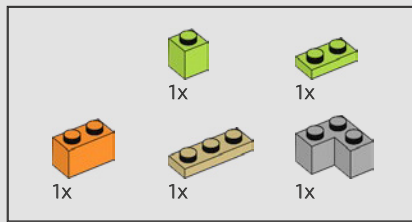

250

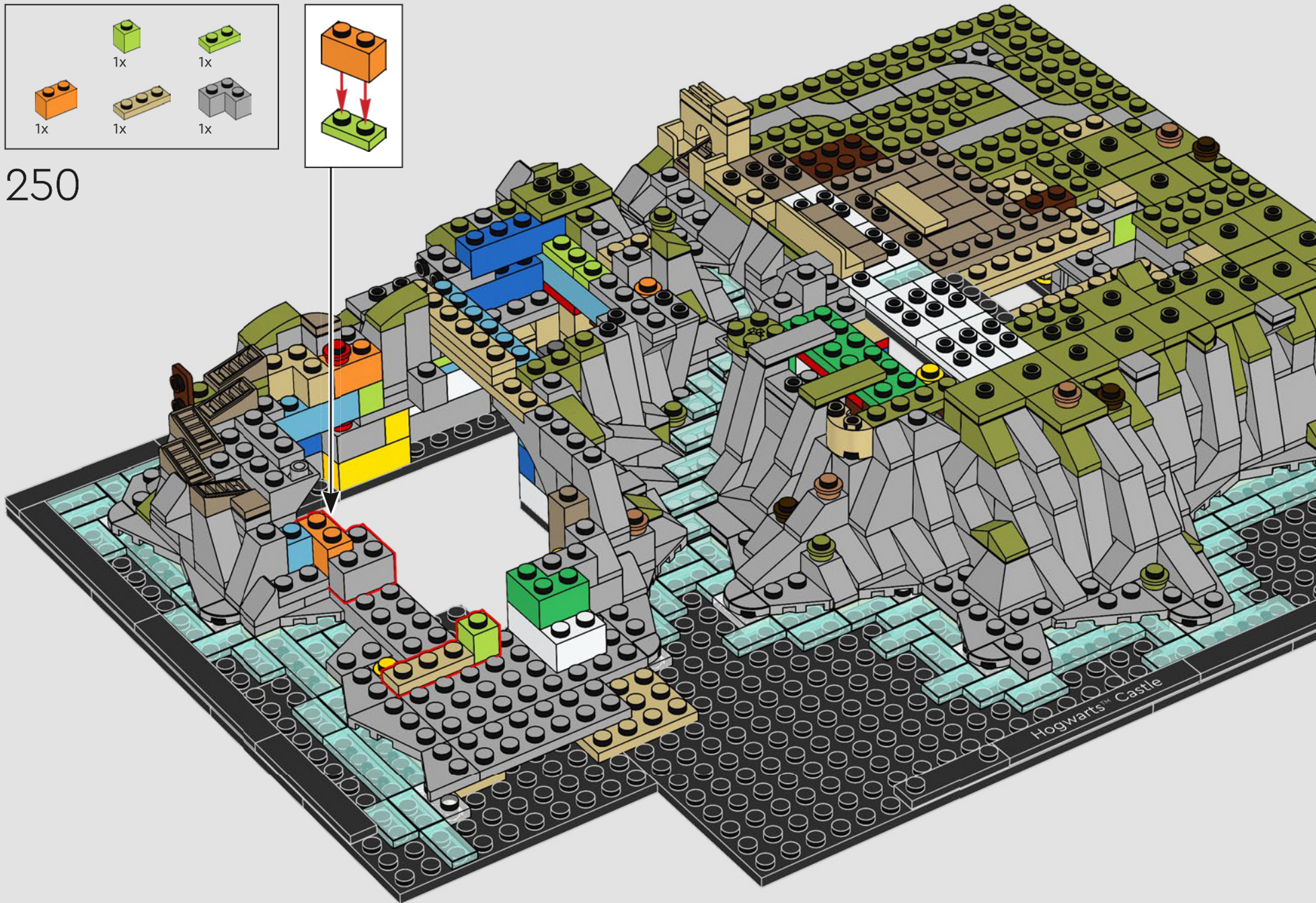

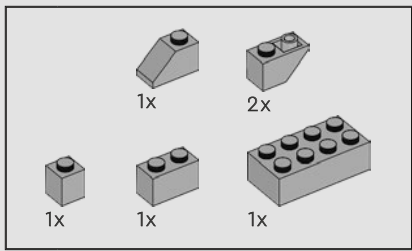

251

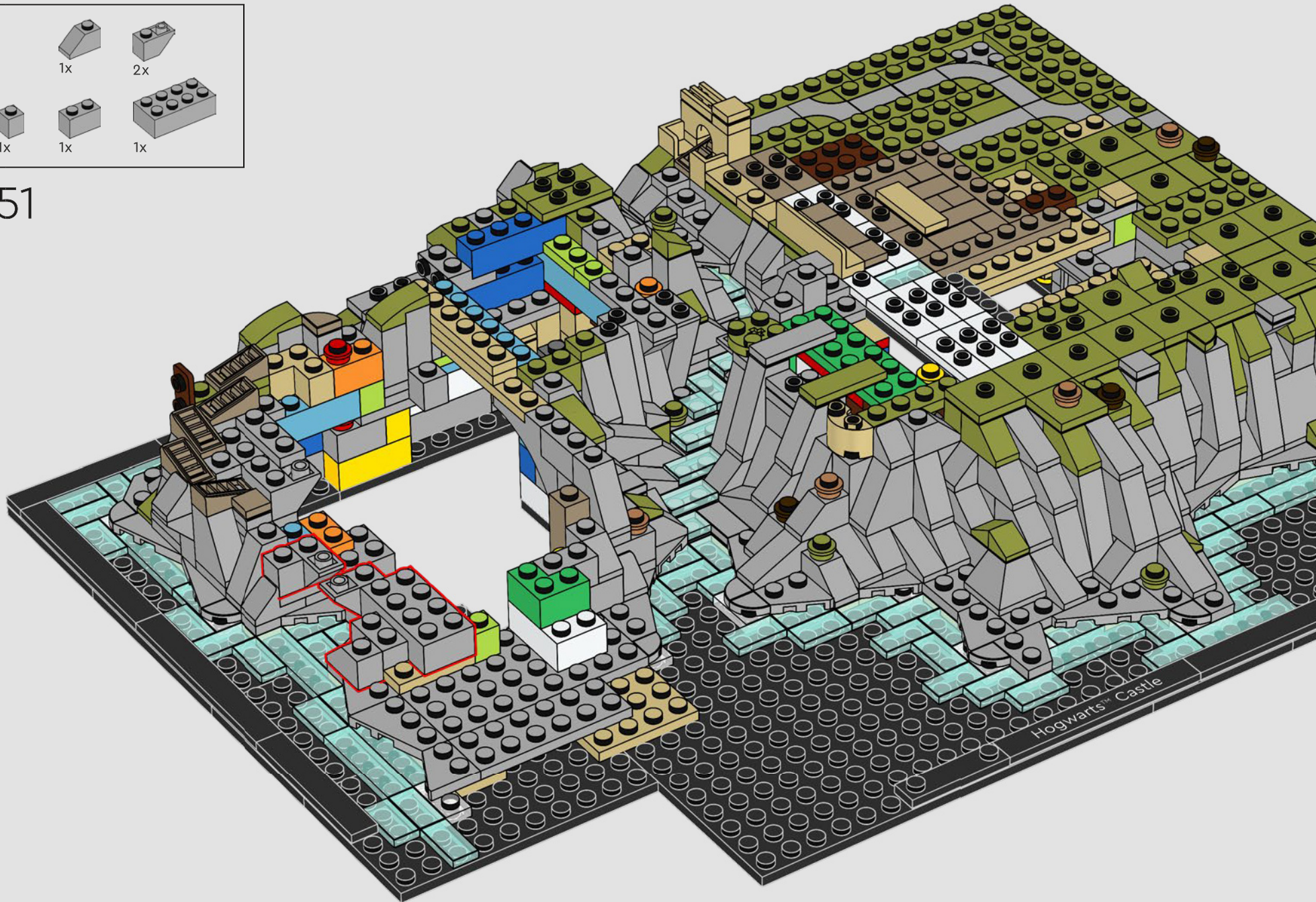

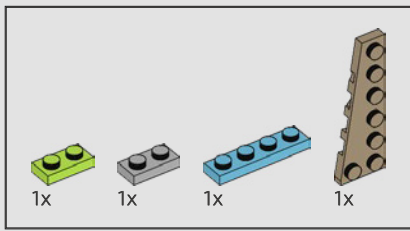

252

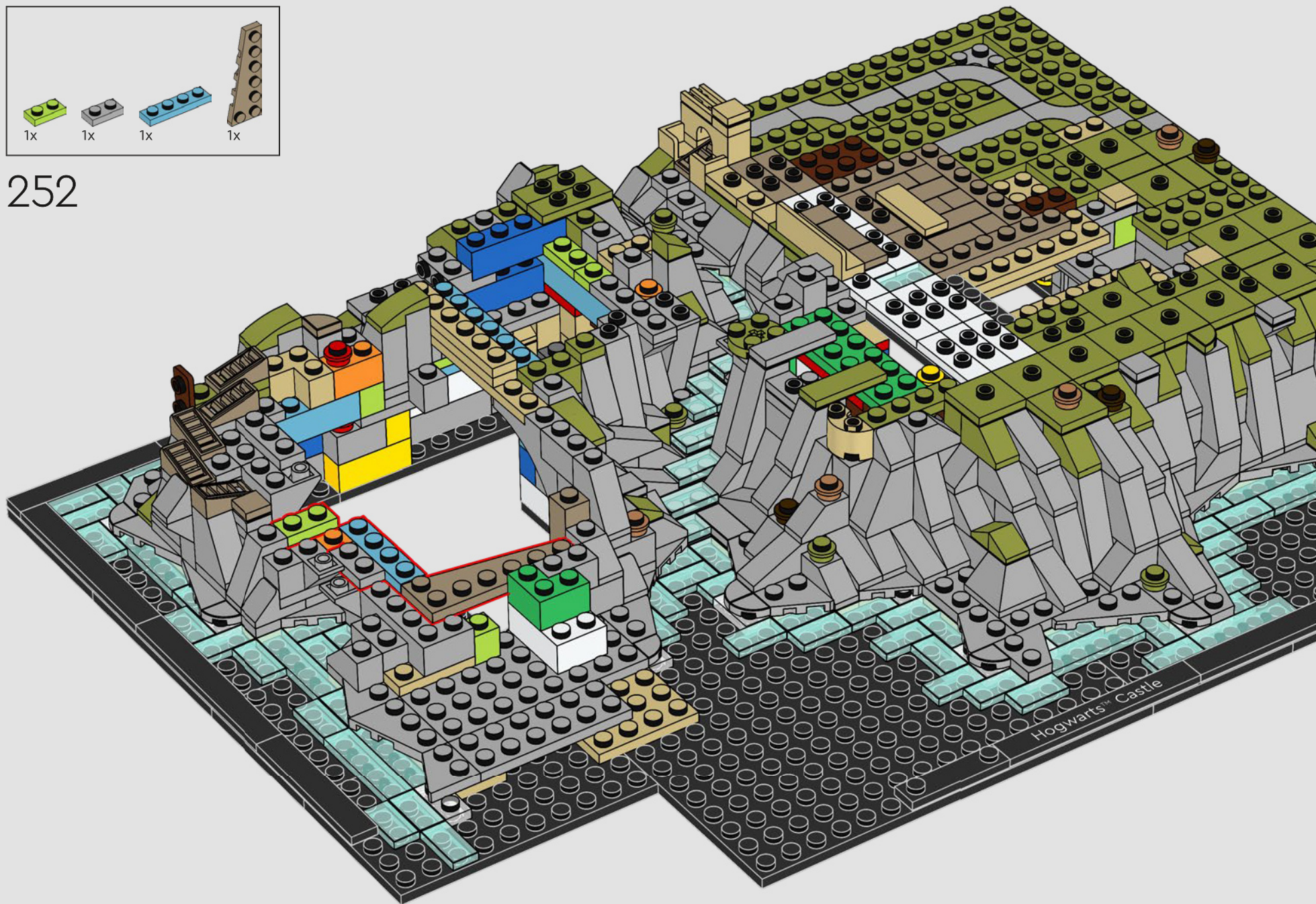

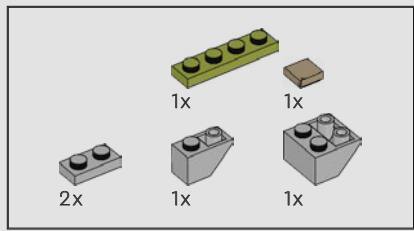

253

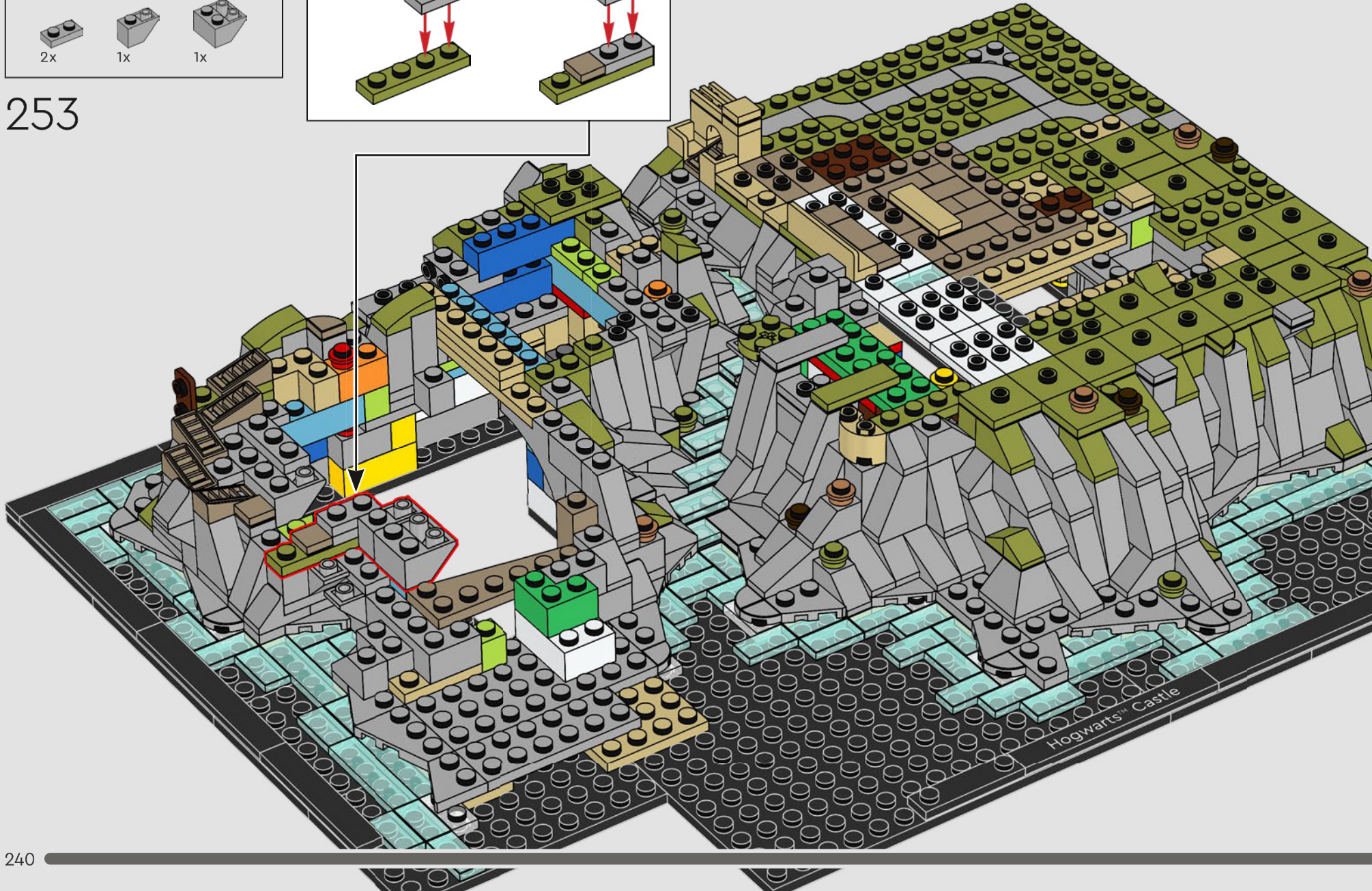
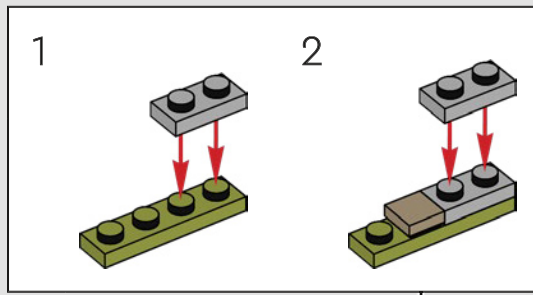



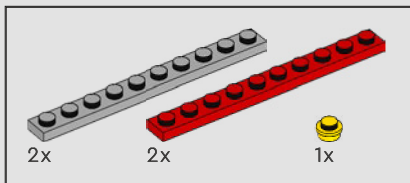

254

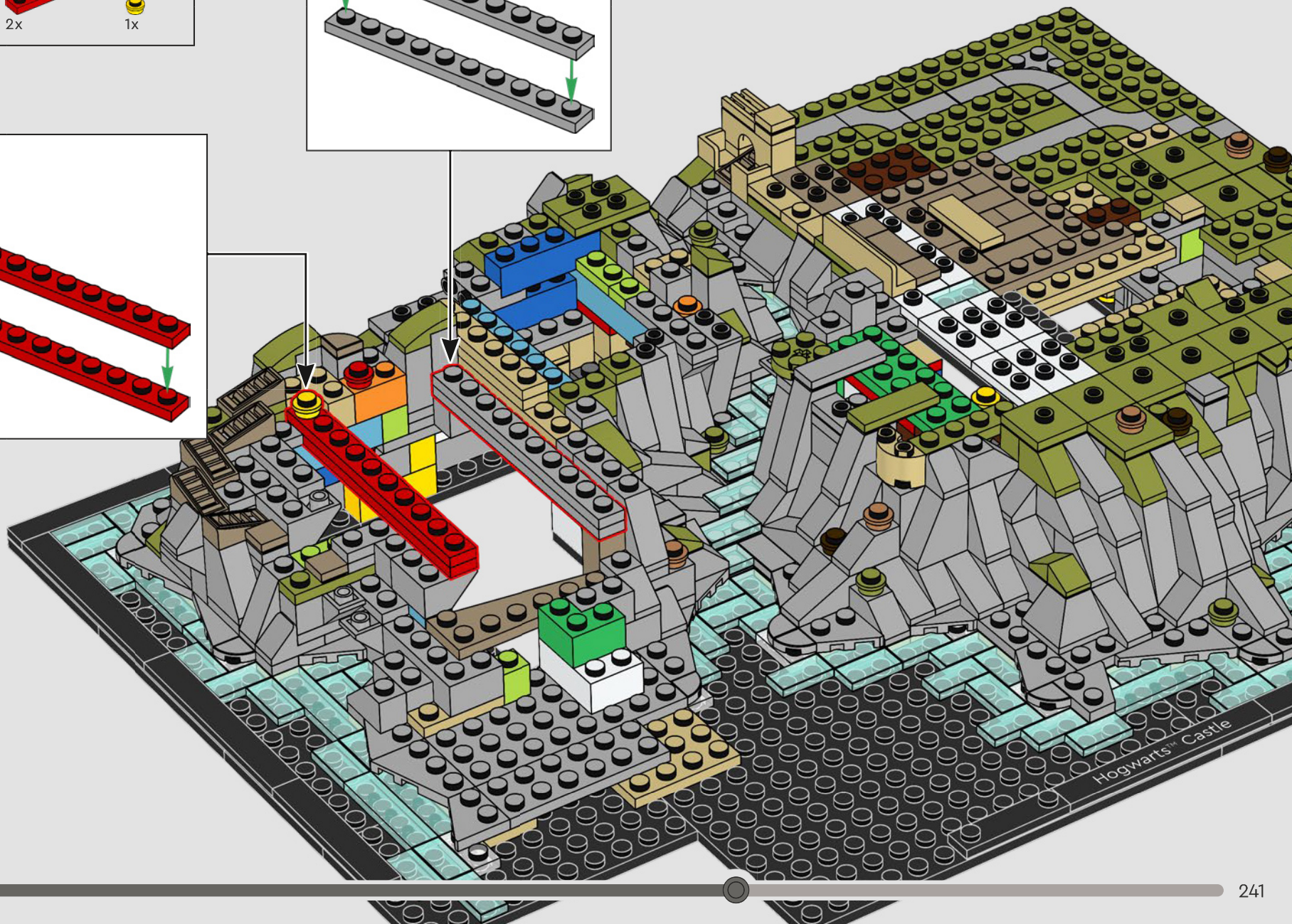
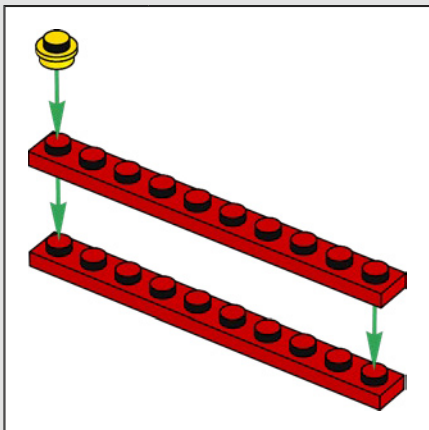
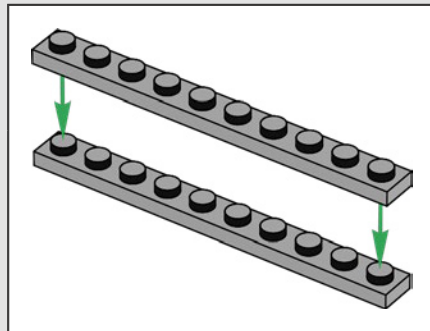

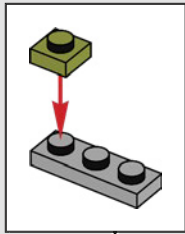
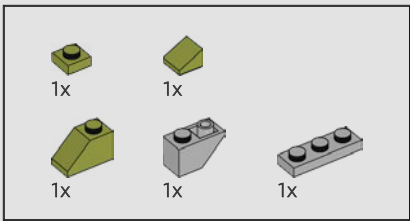

255

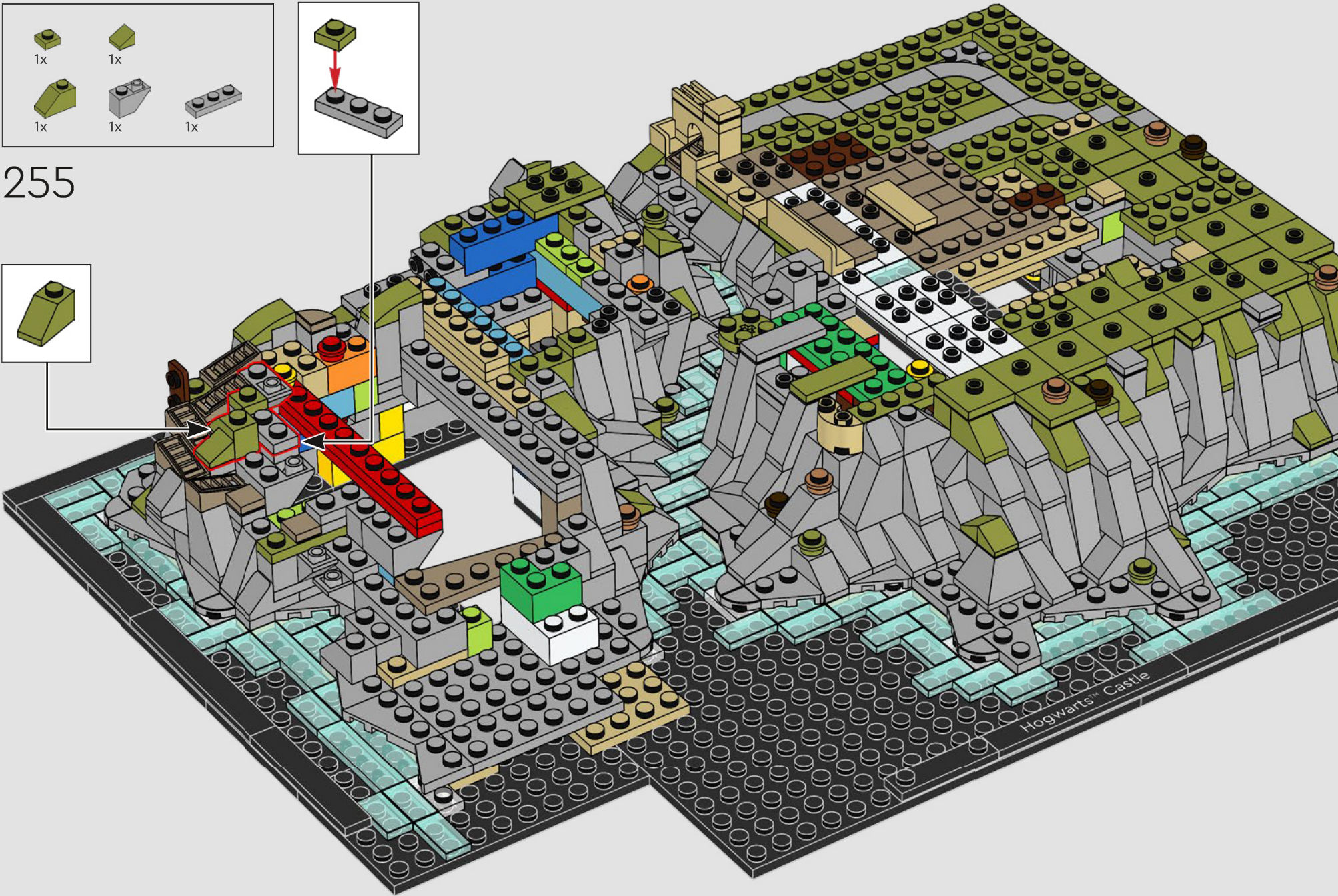

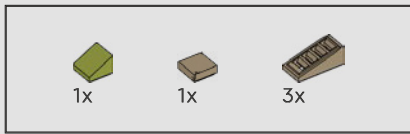

256

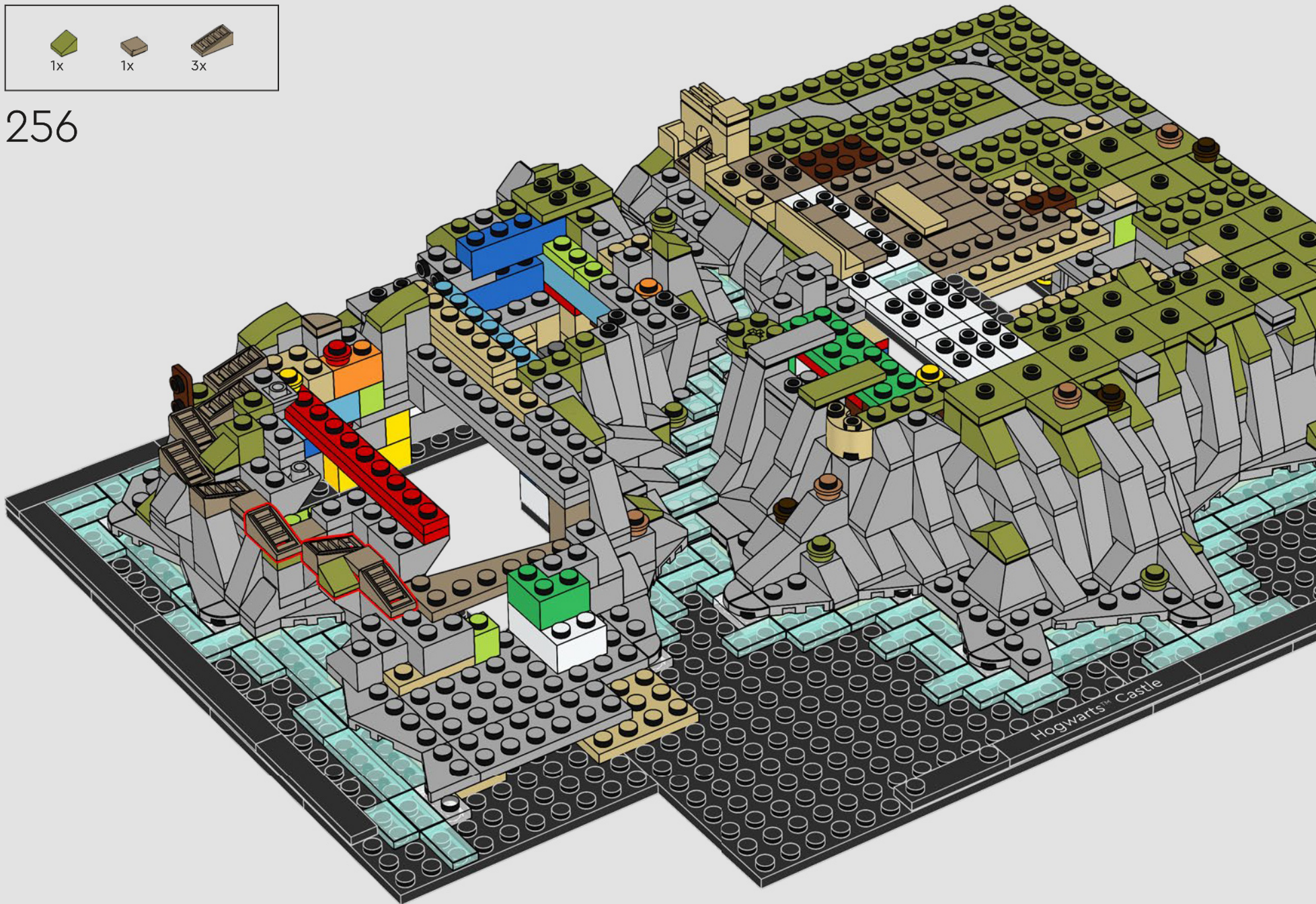

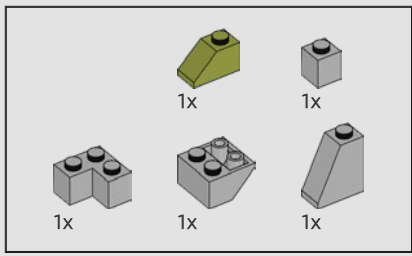

257

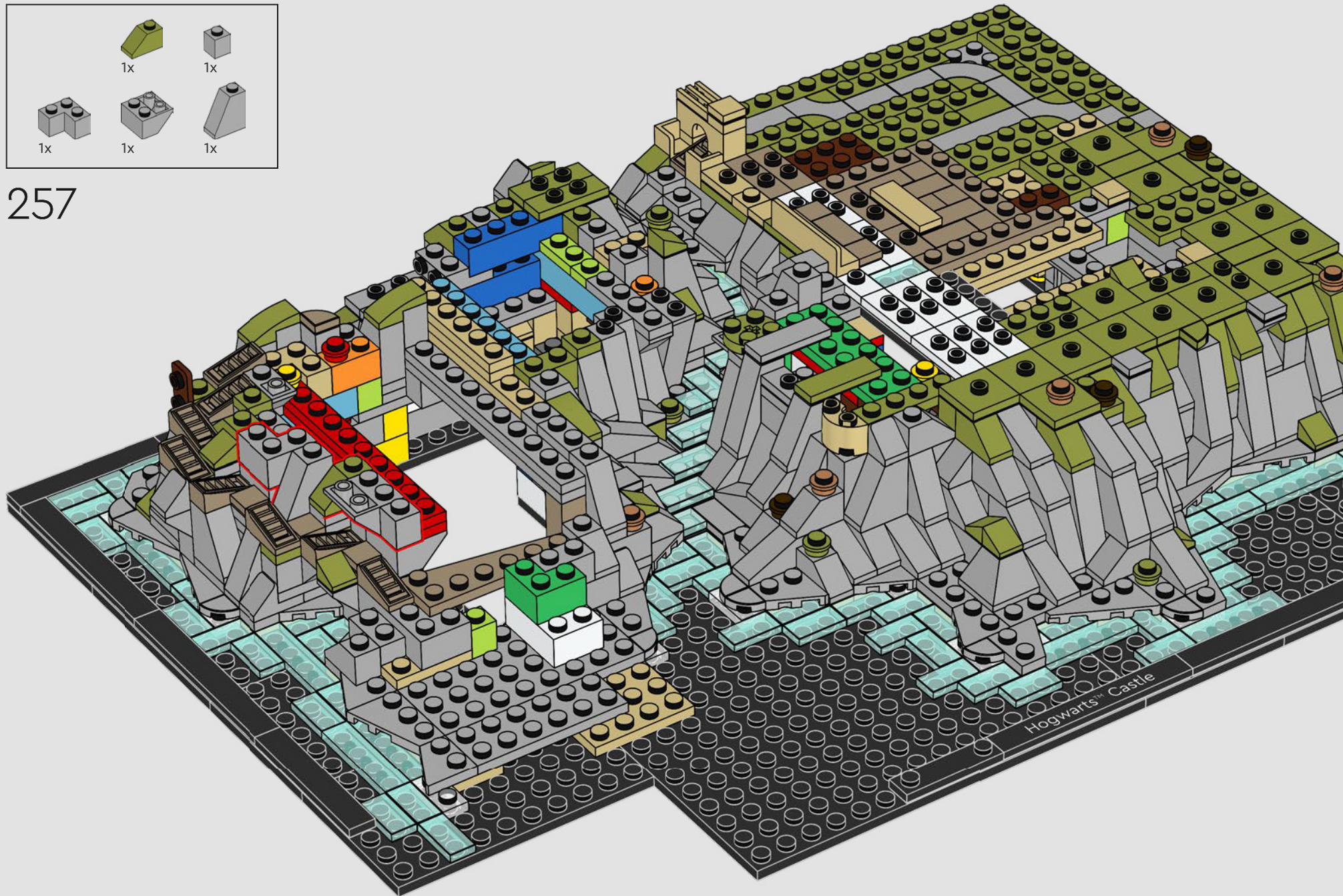

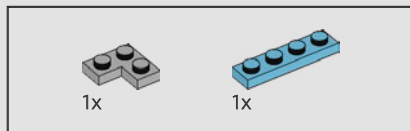

258

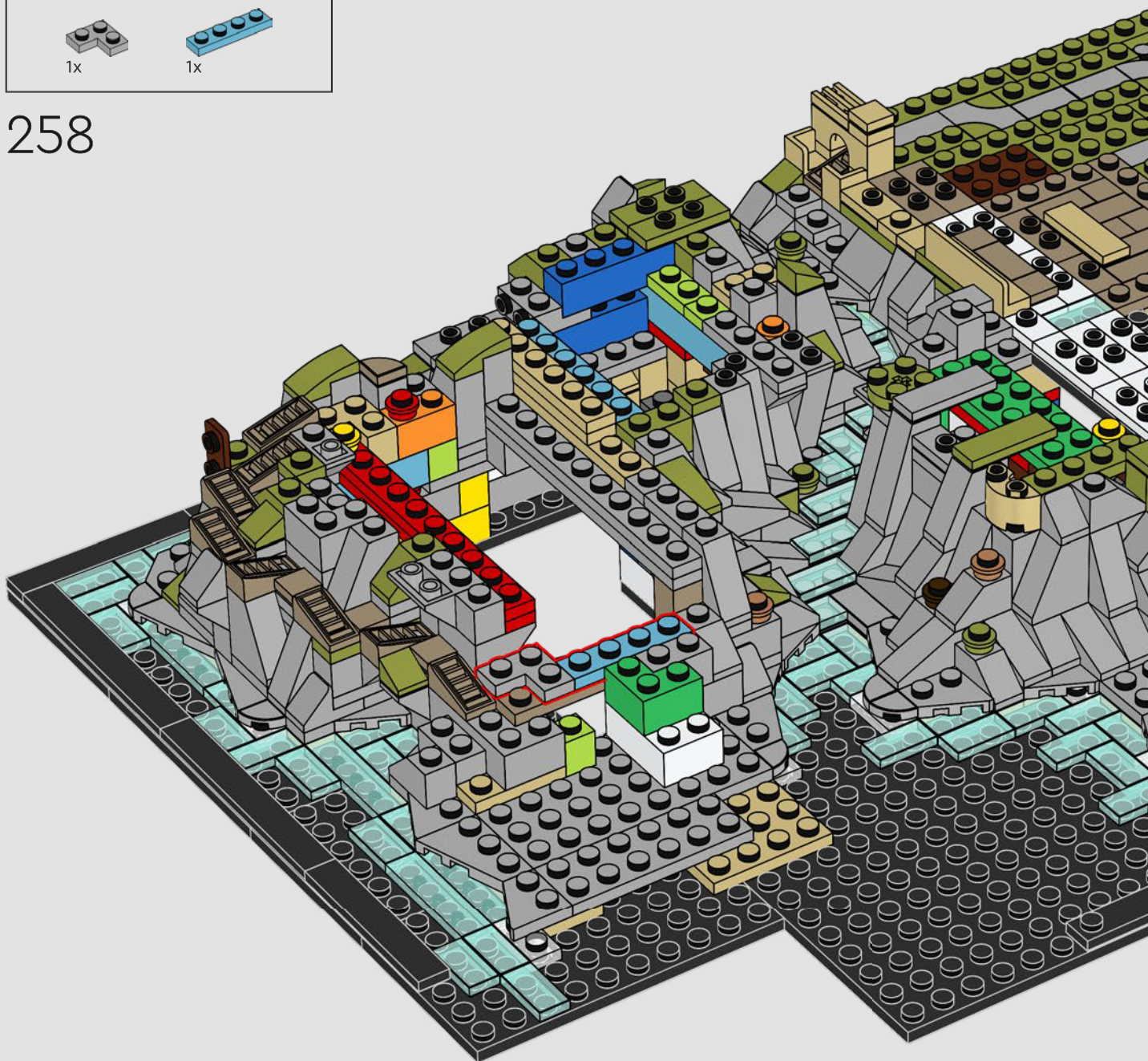

Helga Hufflepuff™ was famous for her culinary charms and spells and many of her delicious recipes are still served at school feasts.

Helga Poufsouffle était célèbre pour ses sorts culinaires et plusieurs de ses délicieuses recettes sont encore servies lors des fêtes de l'école.

Helga Hufflepuff™ era famosa por sus encantamientos y hechizos culinarios y muchas de sus deliciosas recetas aún se sirven en los banquetes escolares.



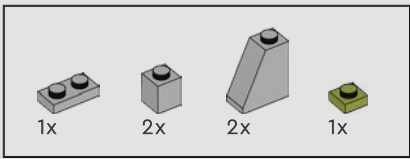

259

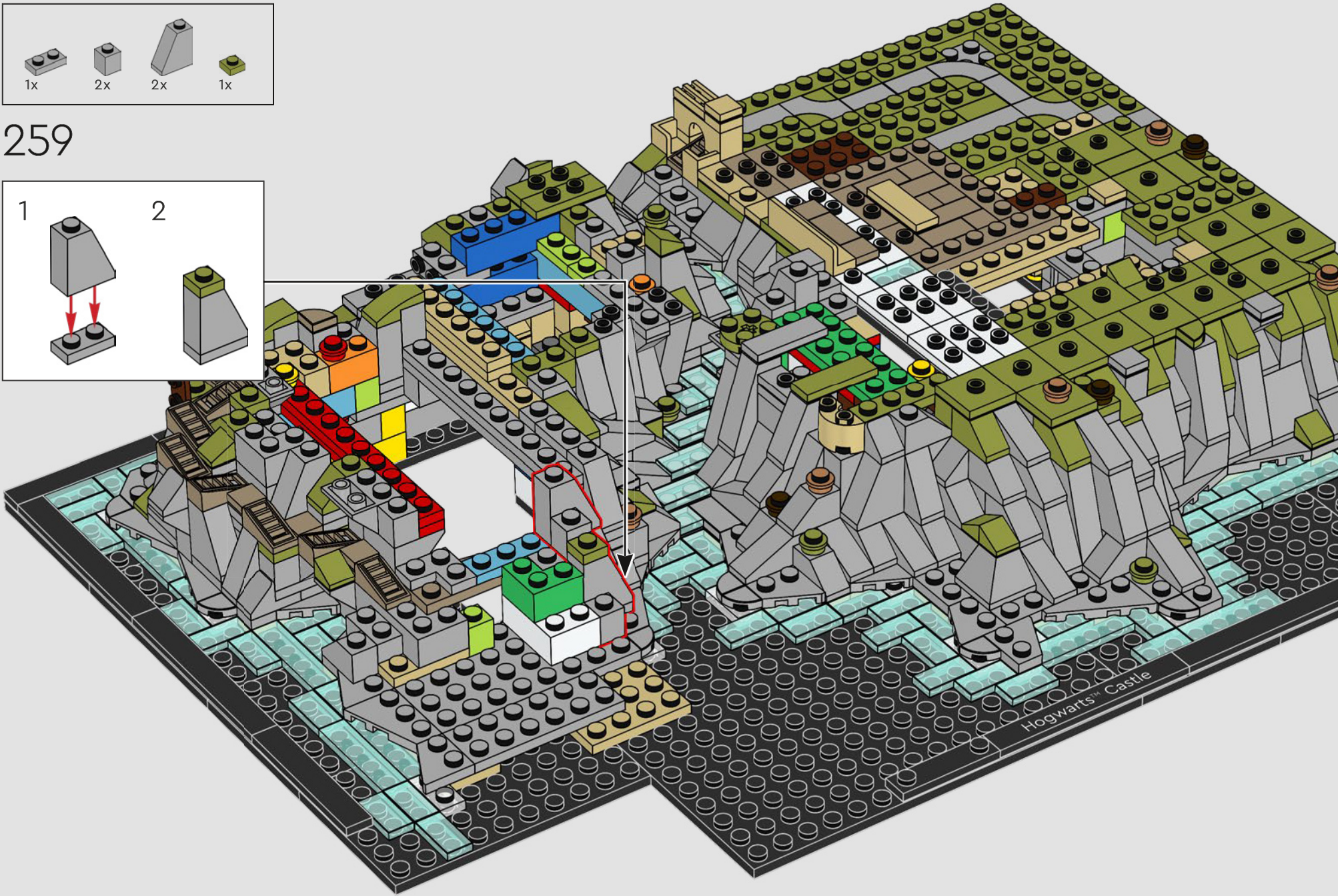
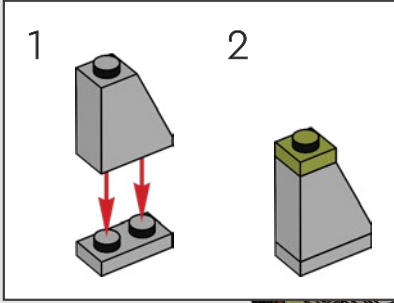

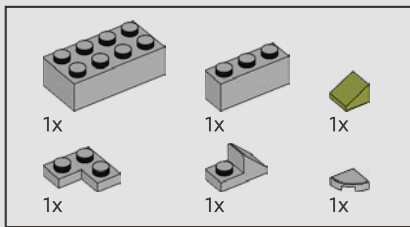

260

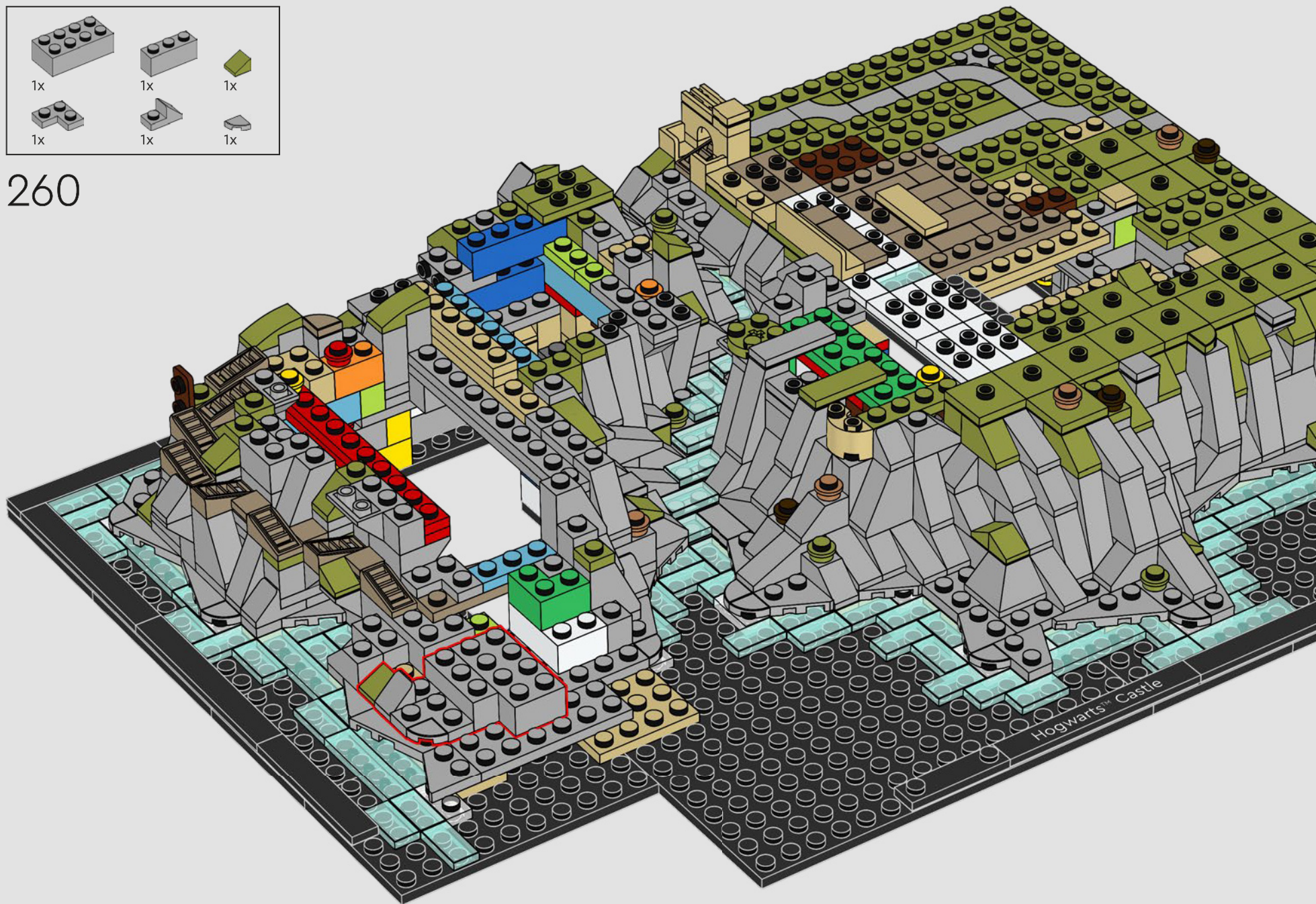

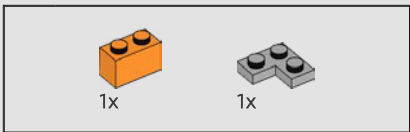

261

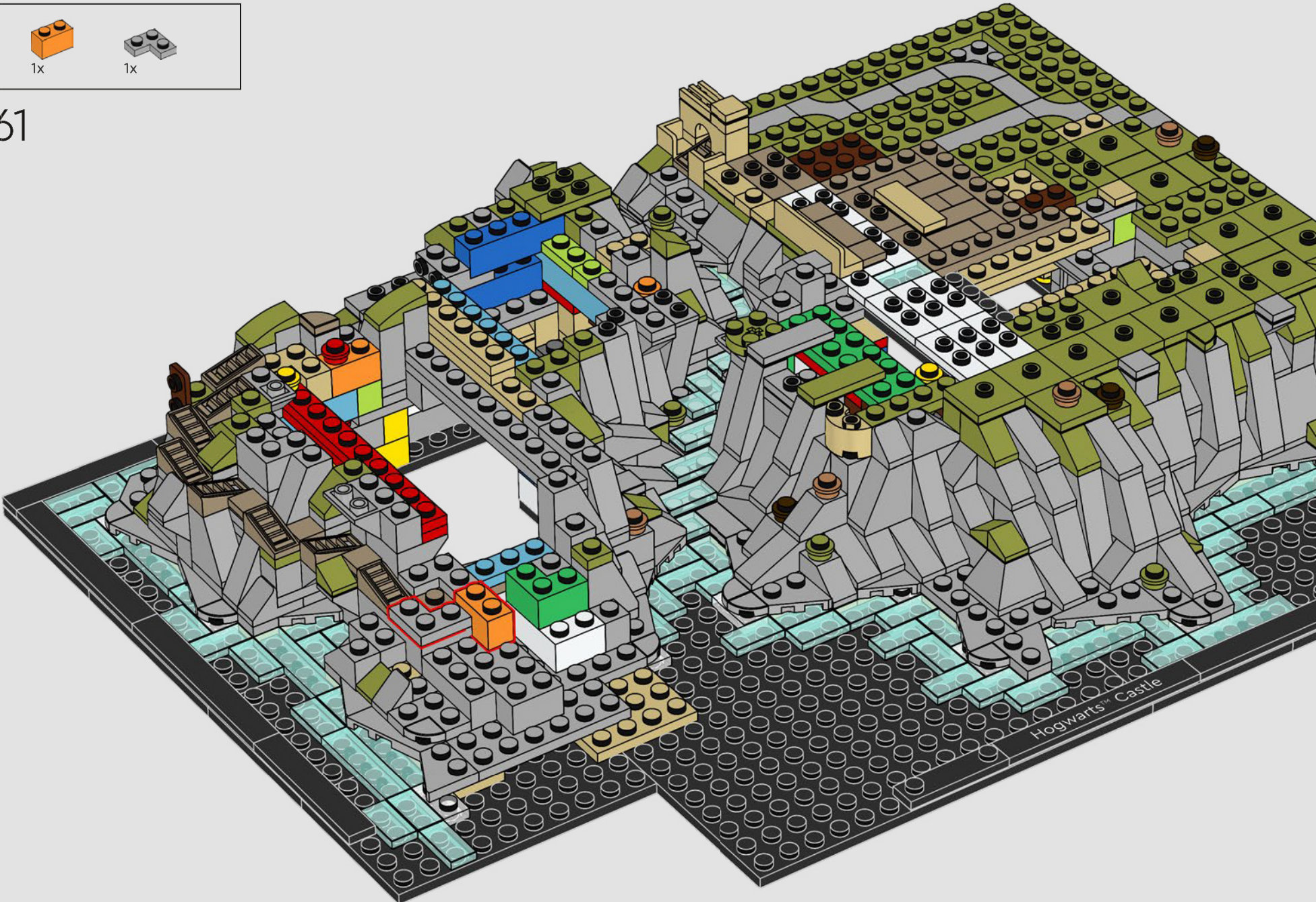



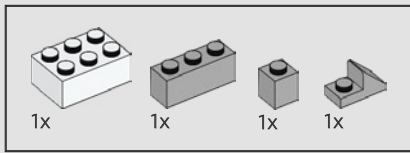

262

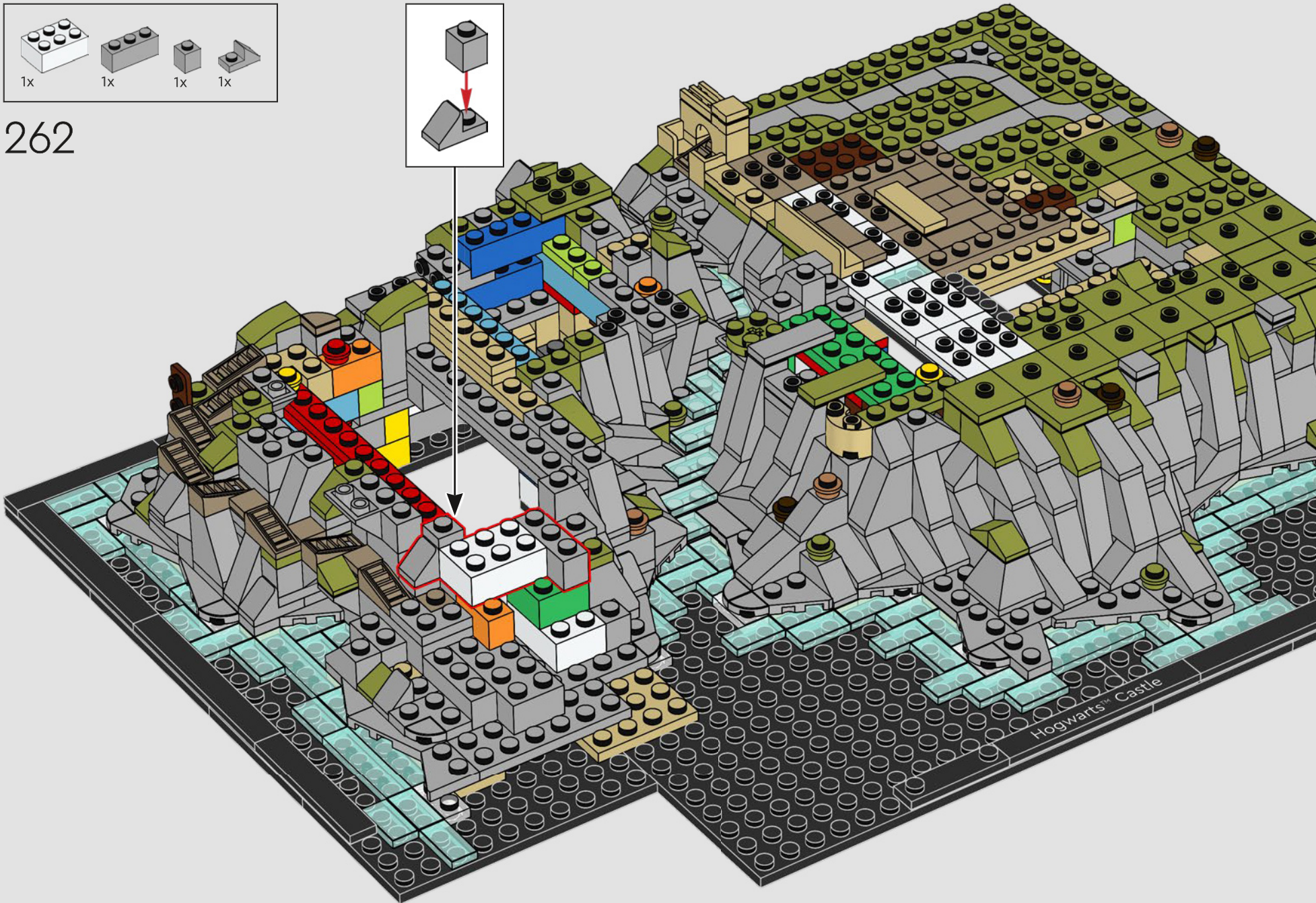
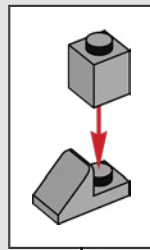

Hogwarts™ Castle

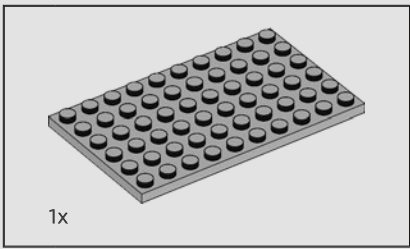

263

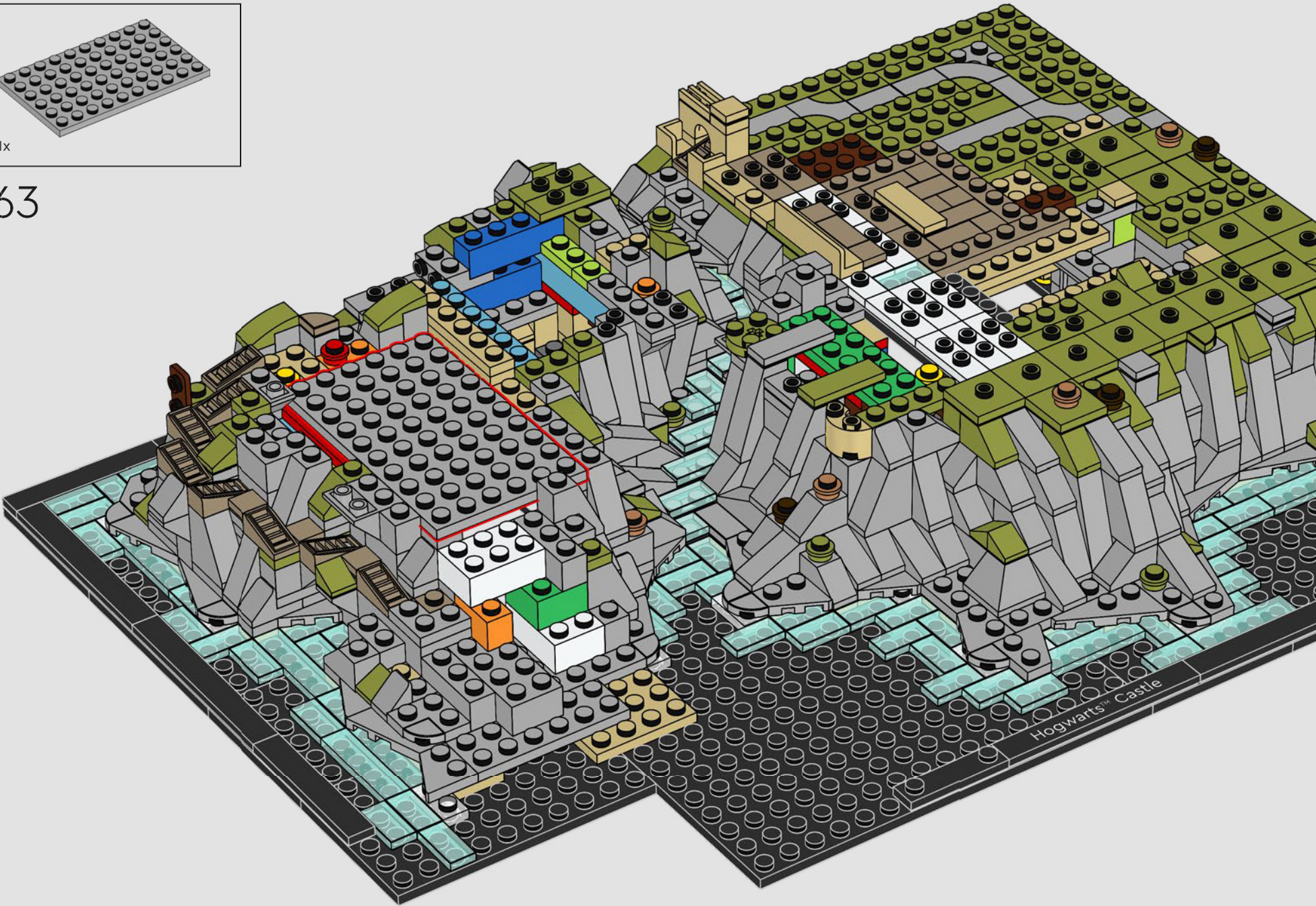

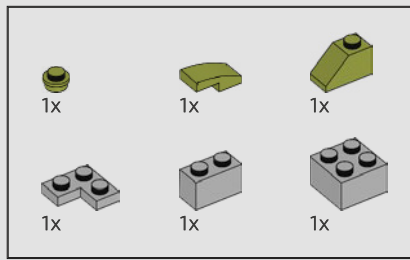

264

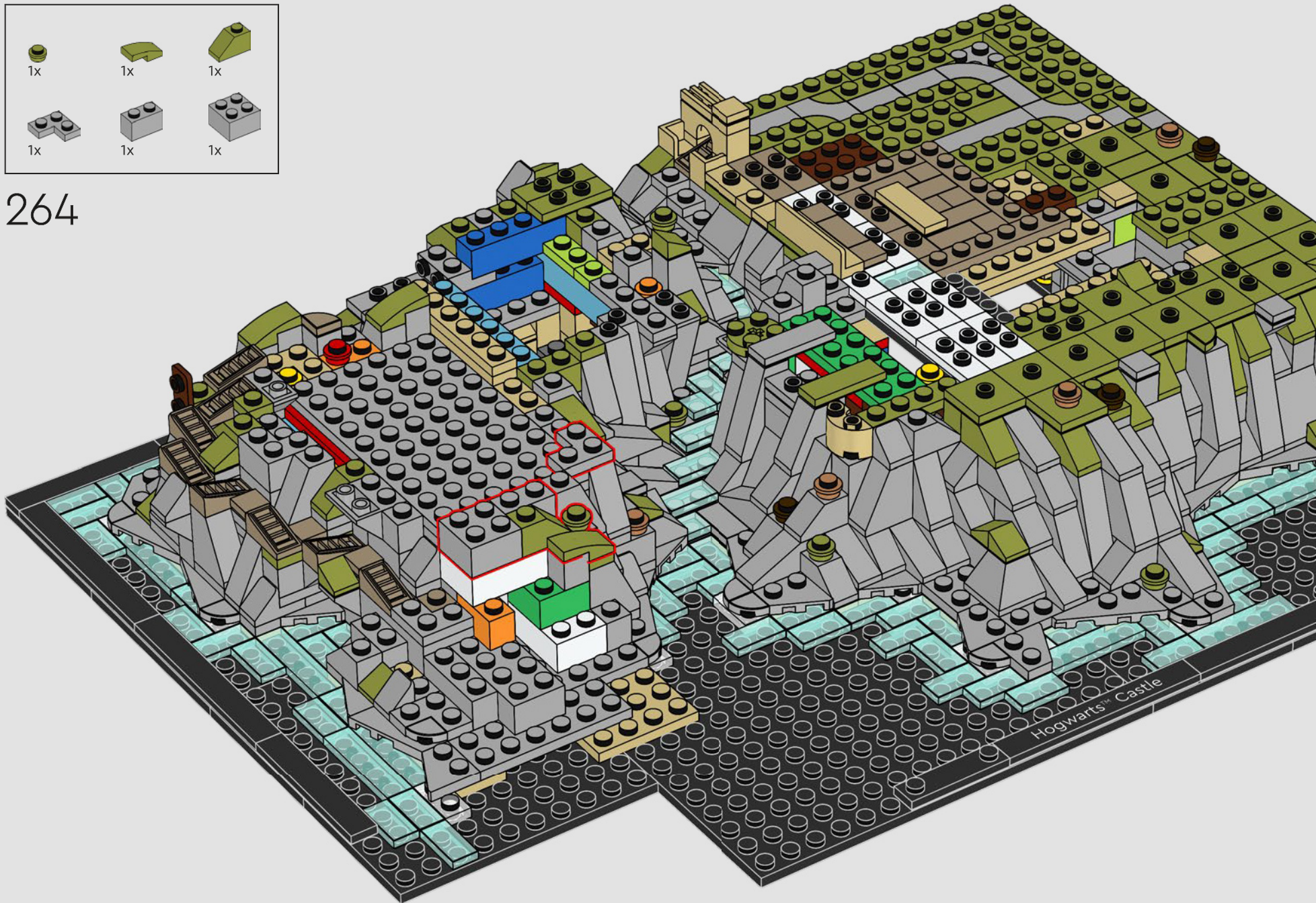

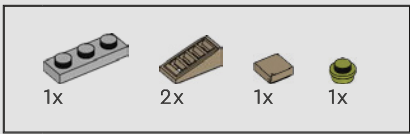

265

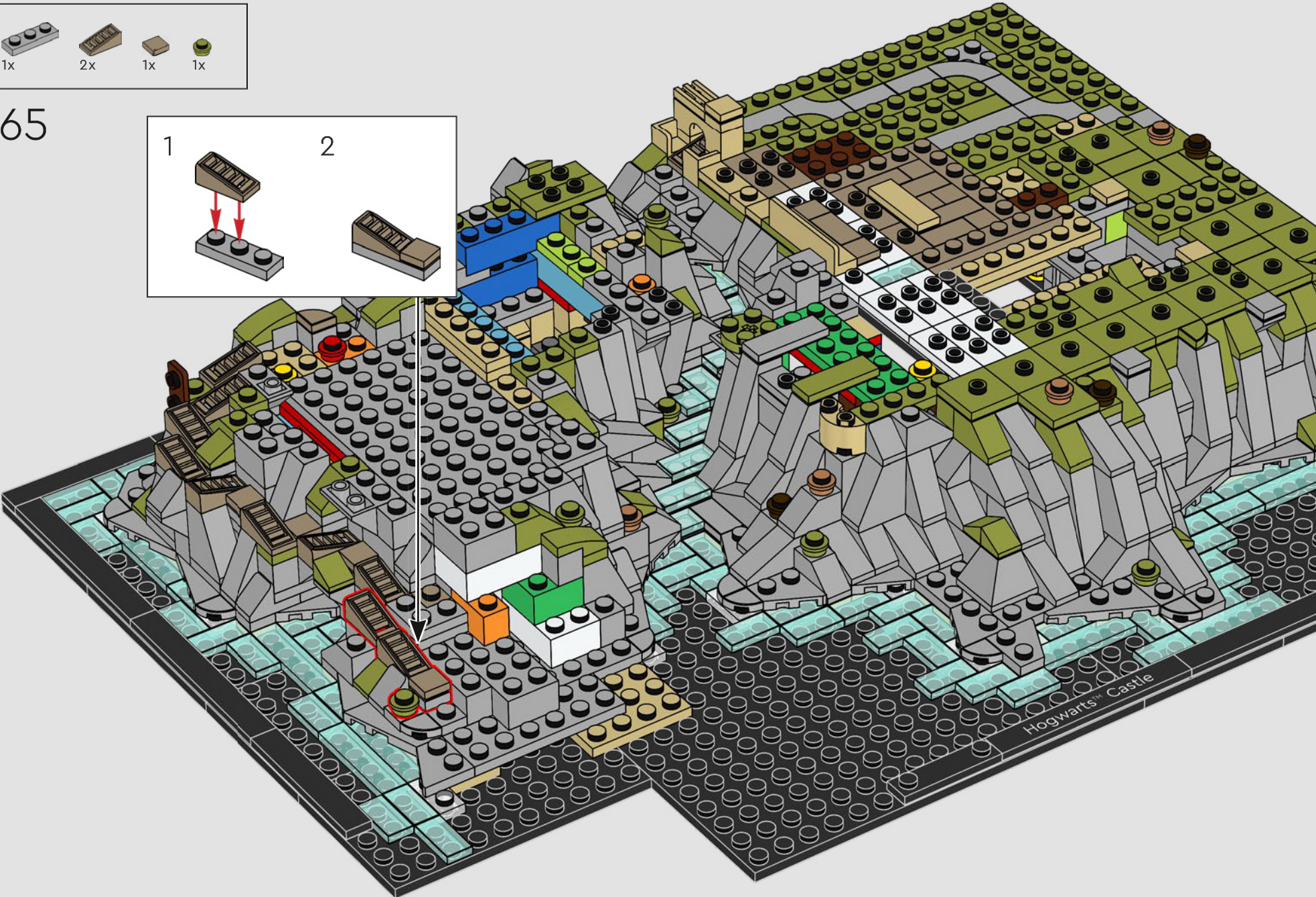
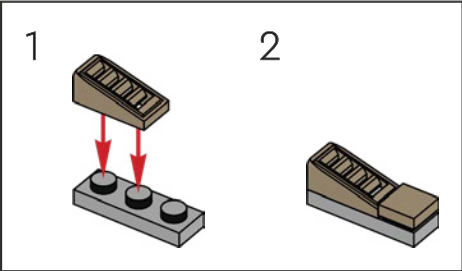

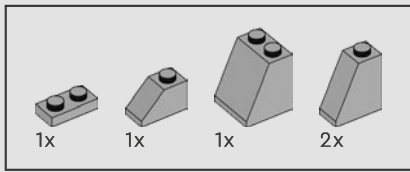

266

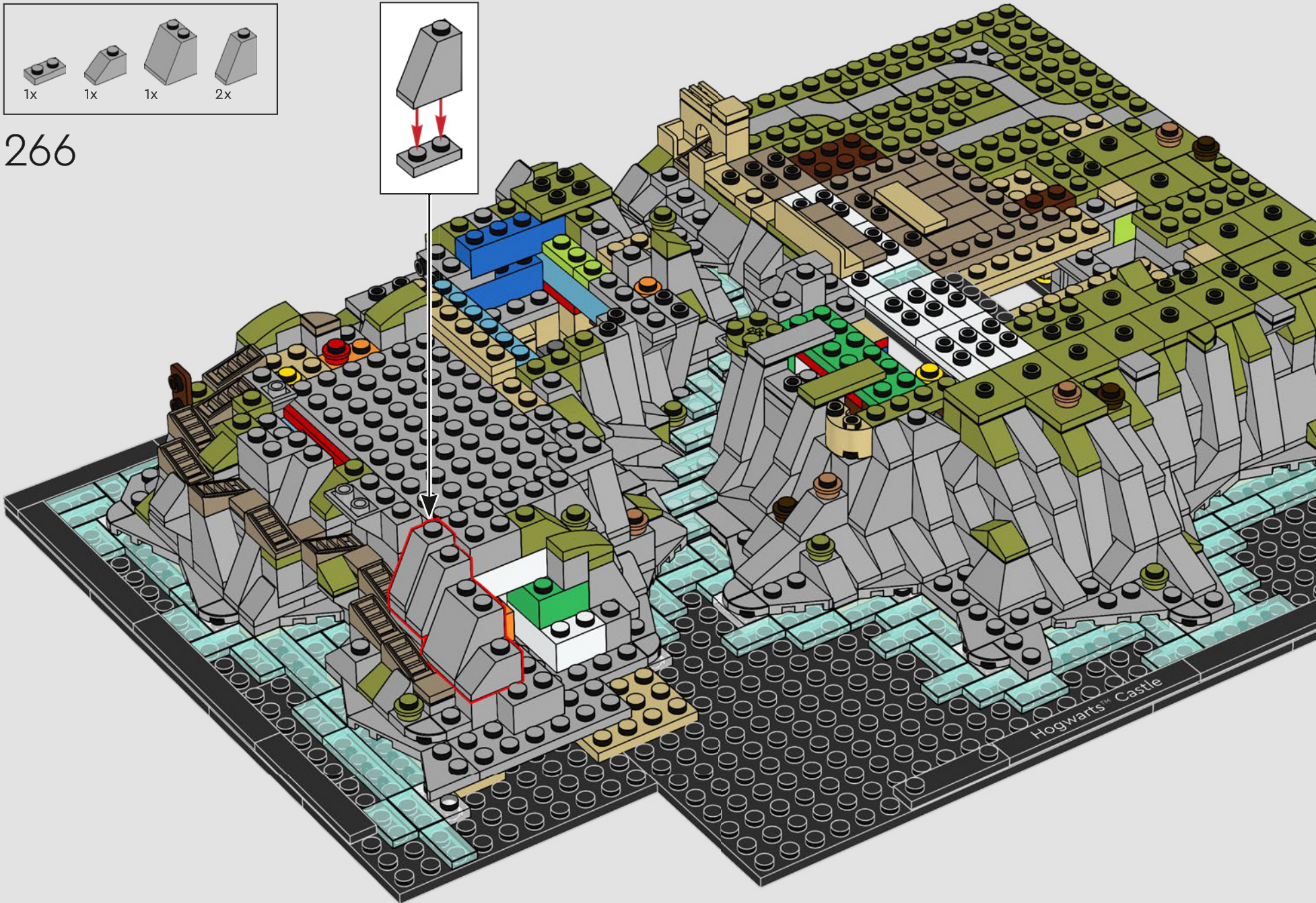
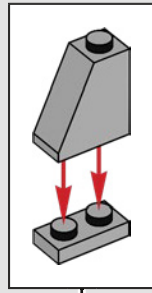

Hogwarts™ Castle



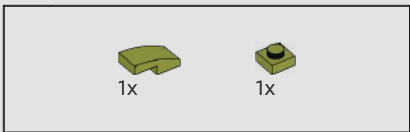

267

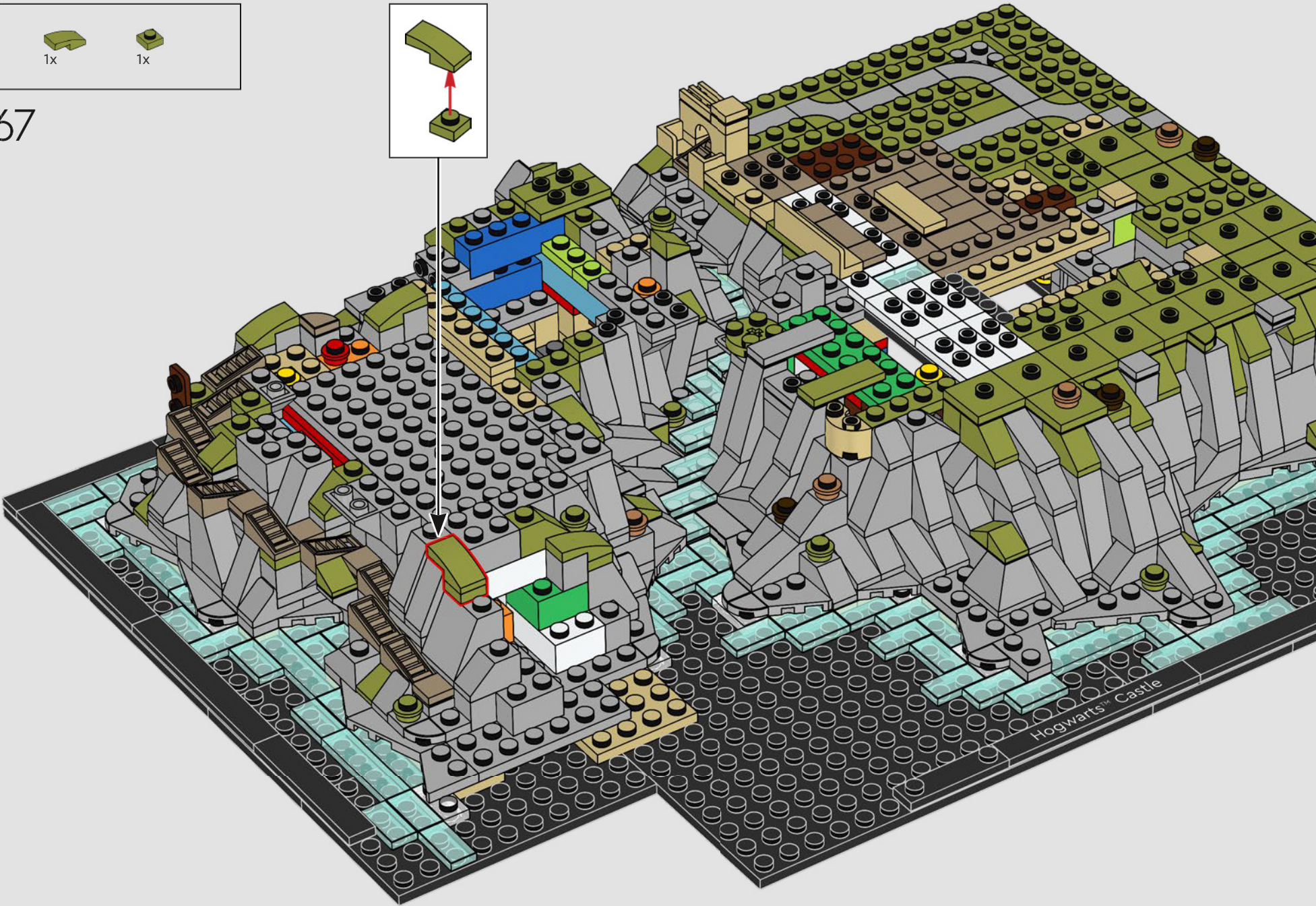
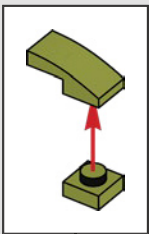



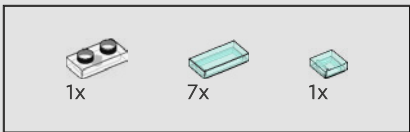

268

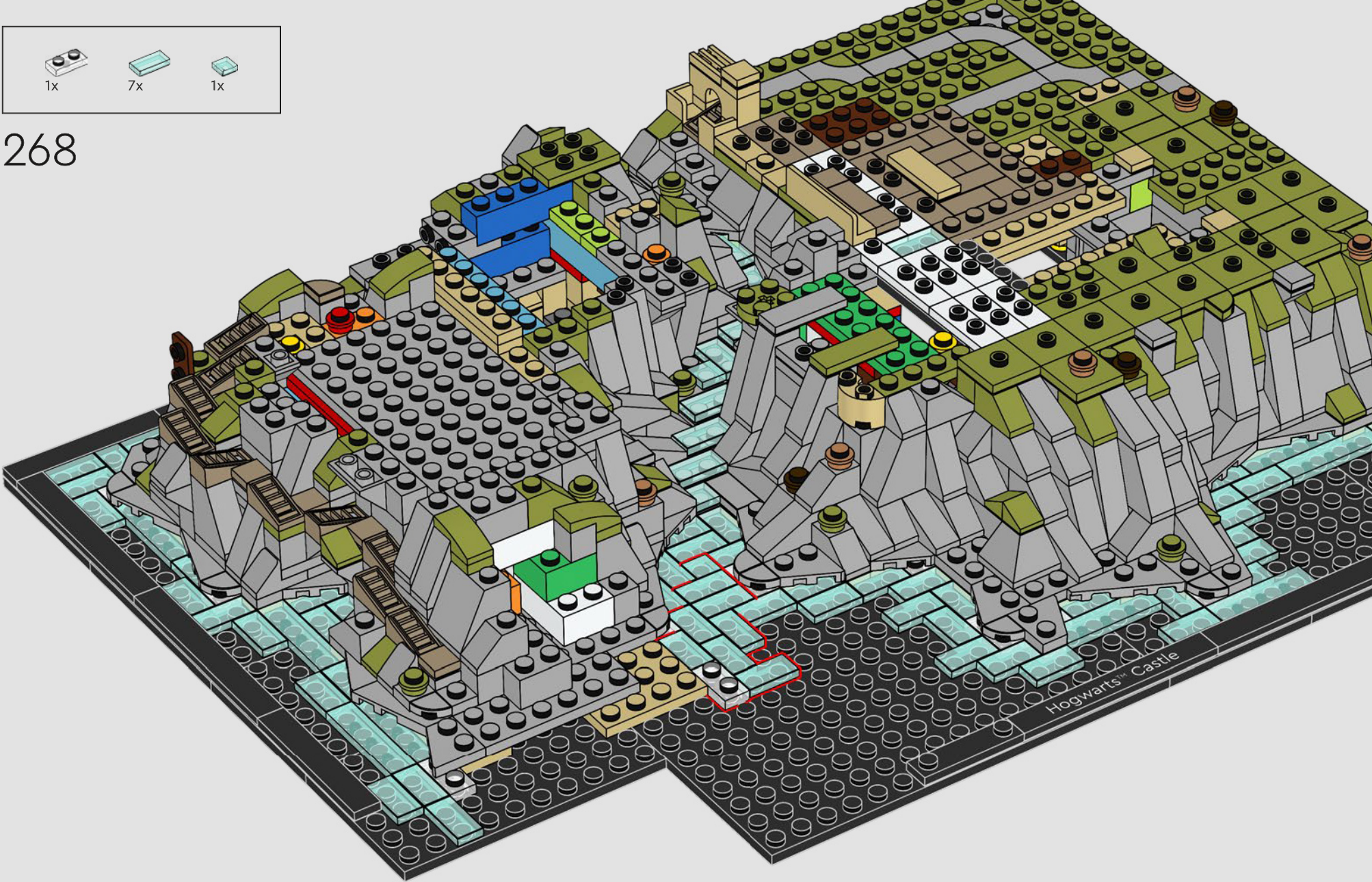



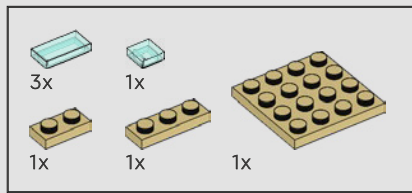

269

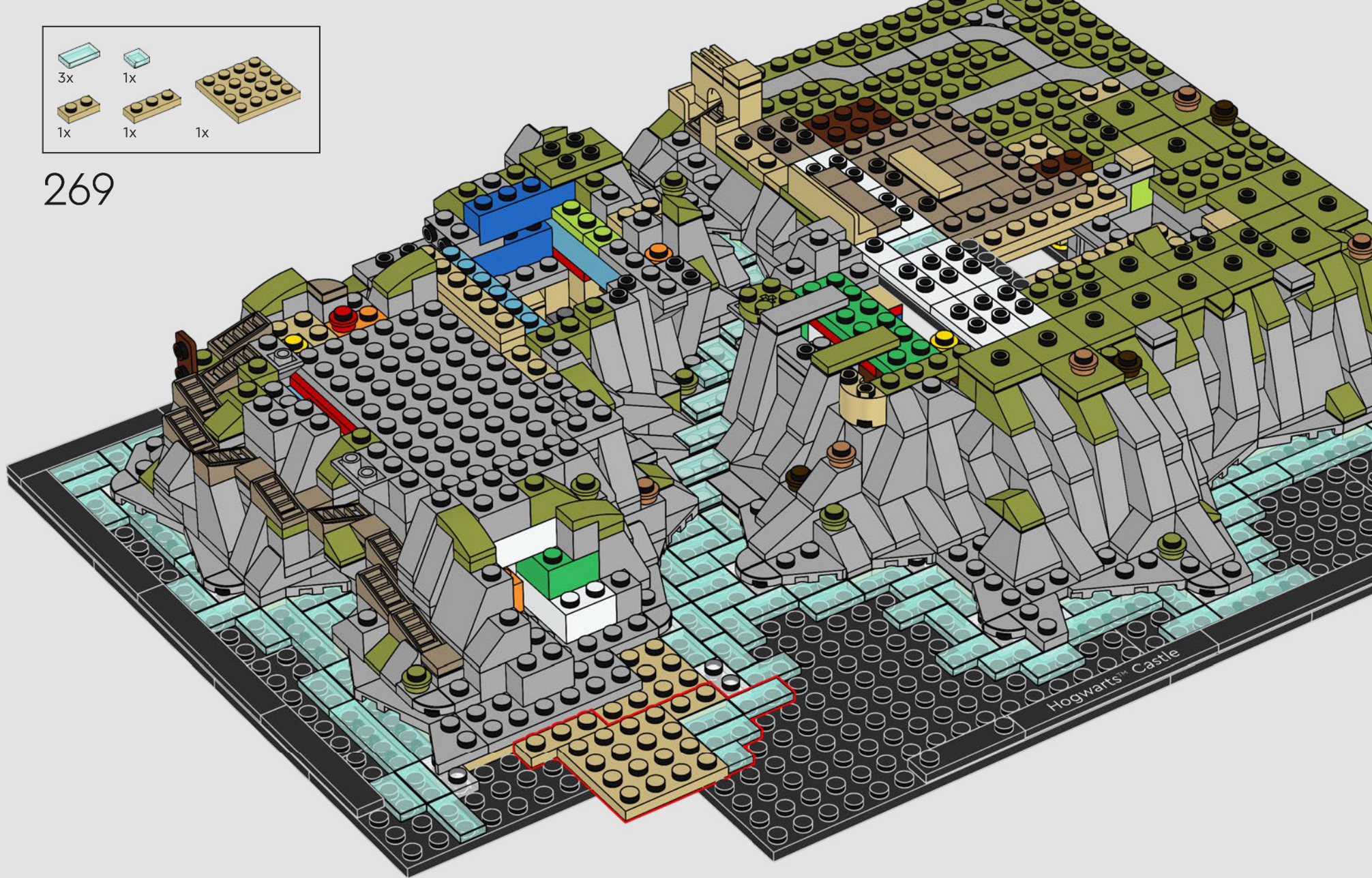

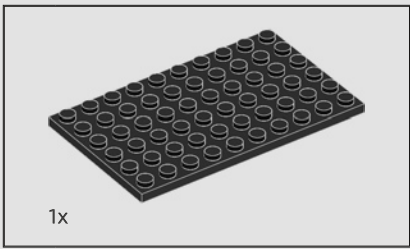

270

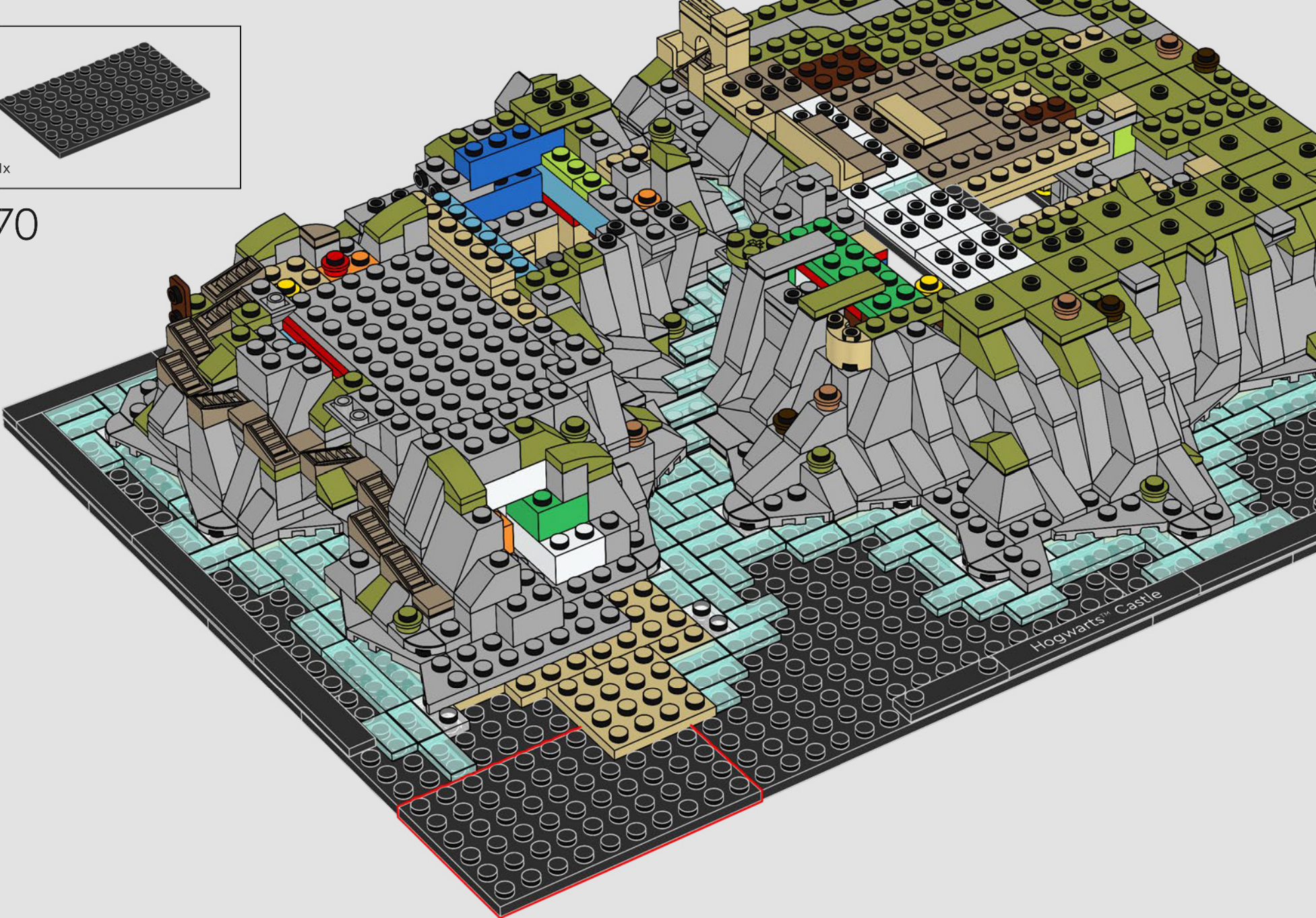

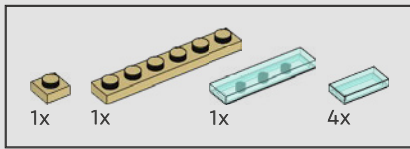

271

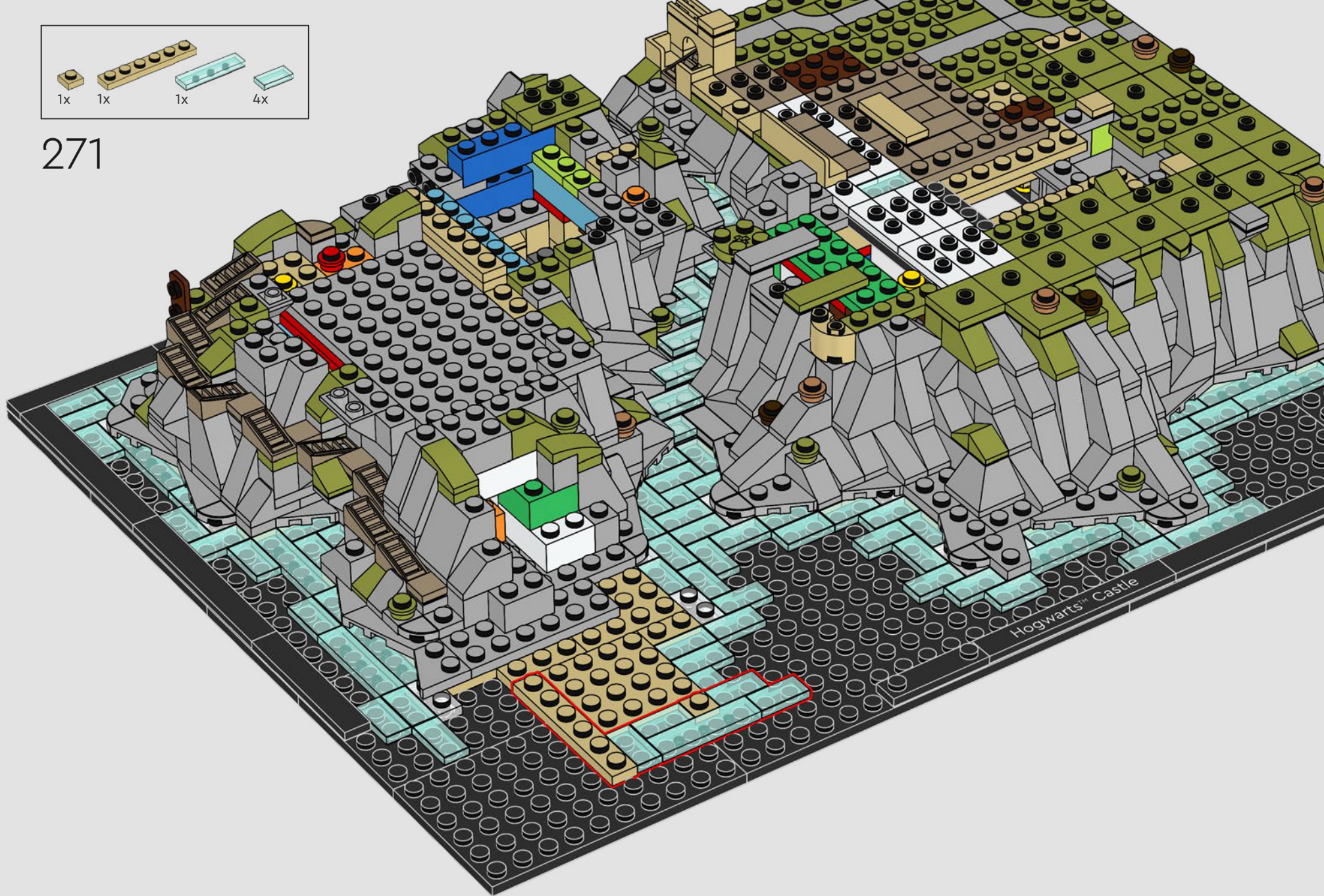

Hogwarts™ Castle



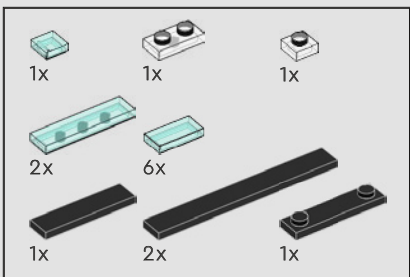

272

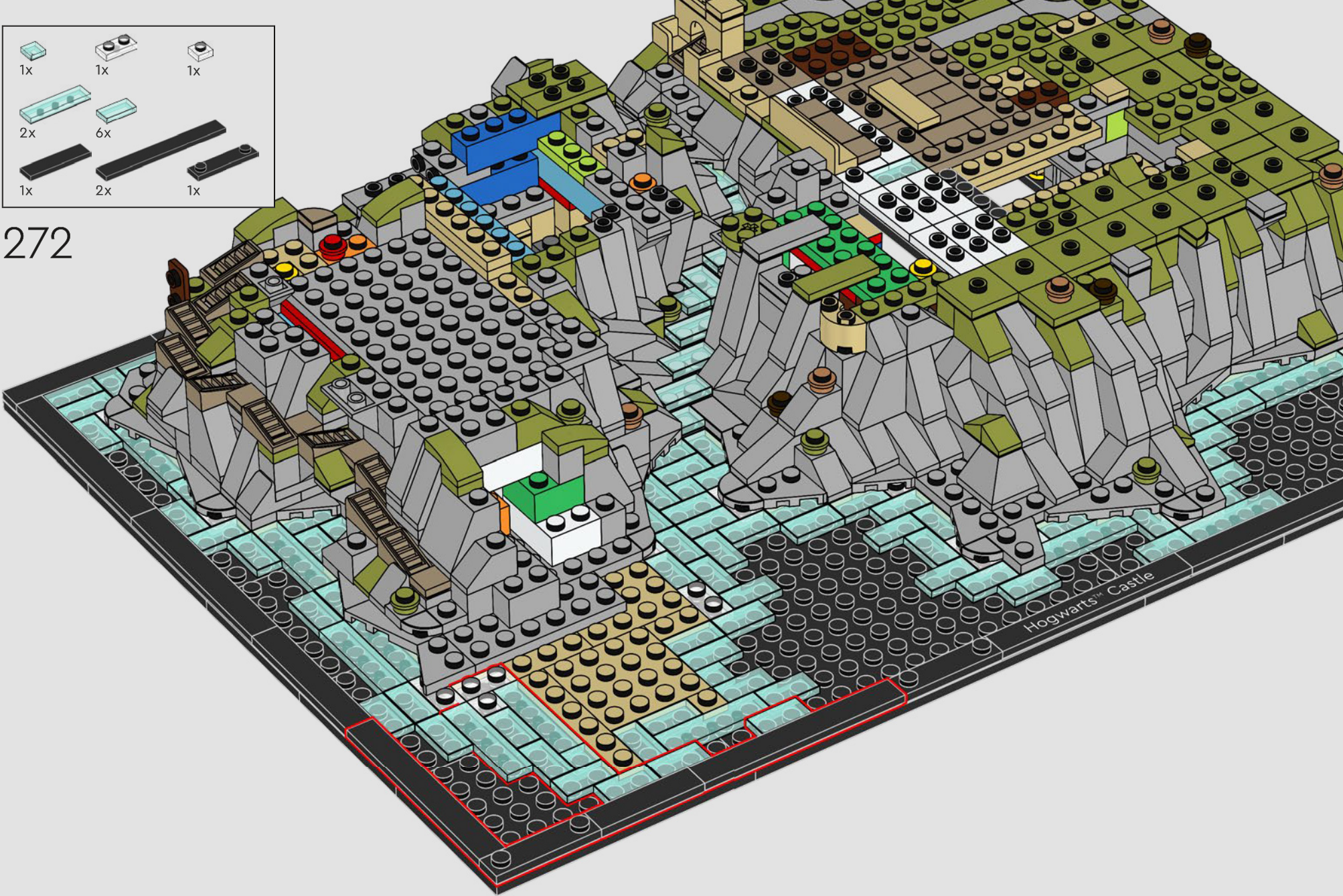

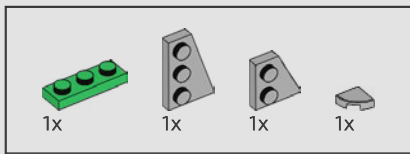

273

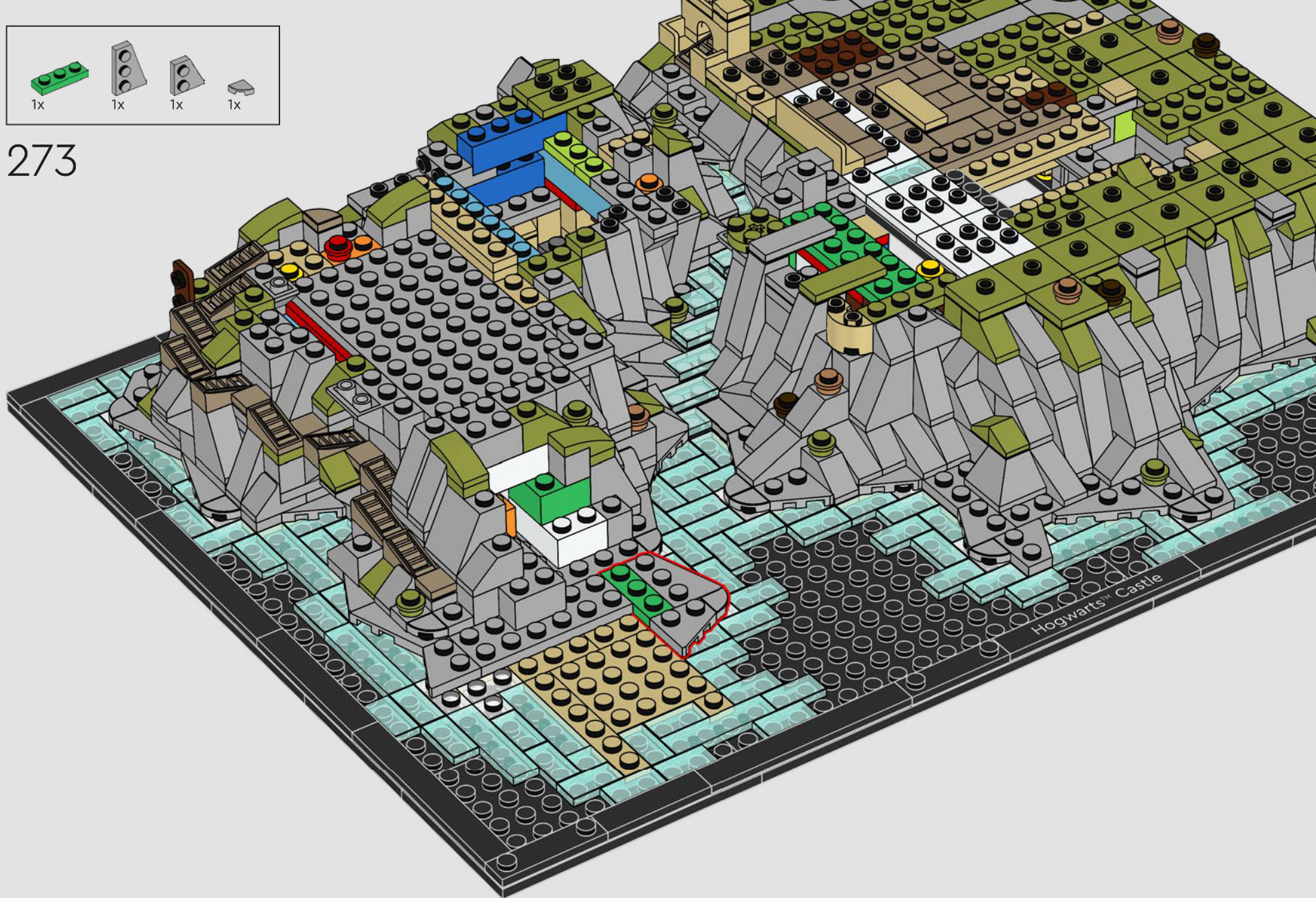

Hogwarts™ Castle



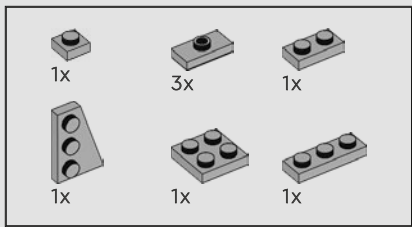

274



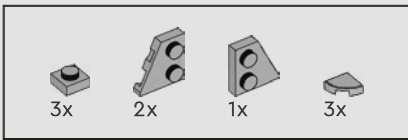

275

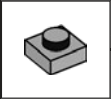
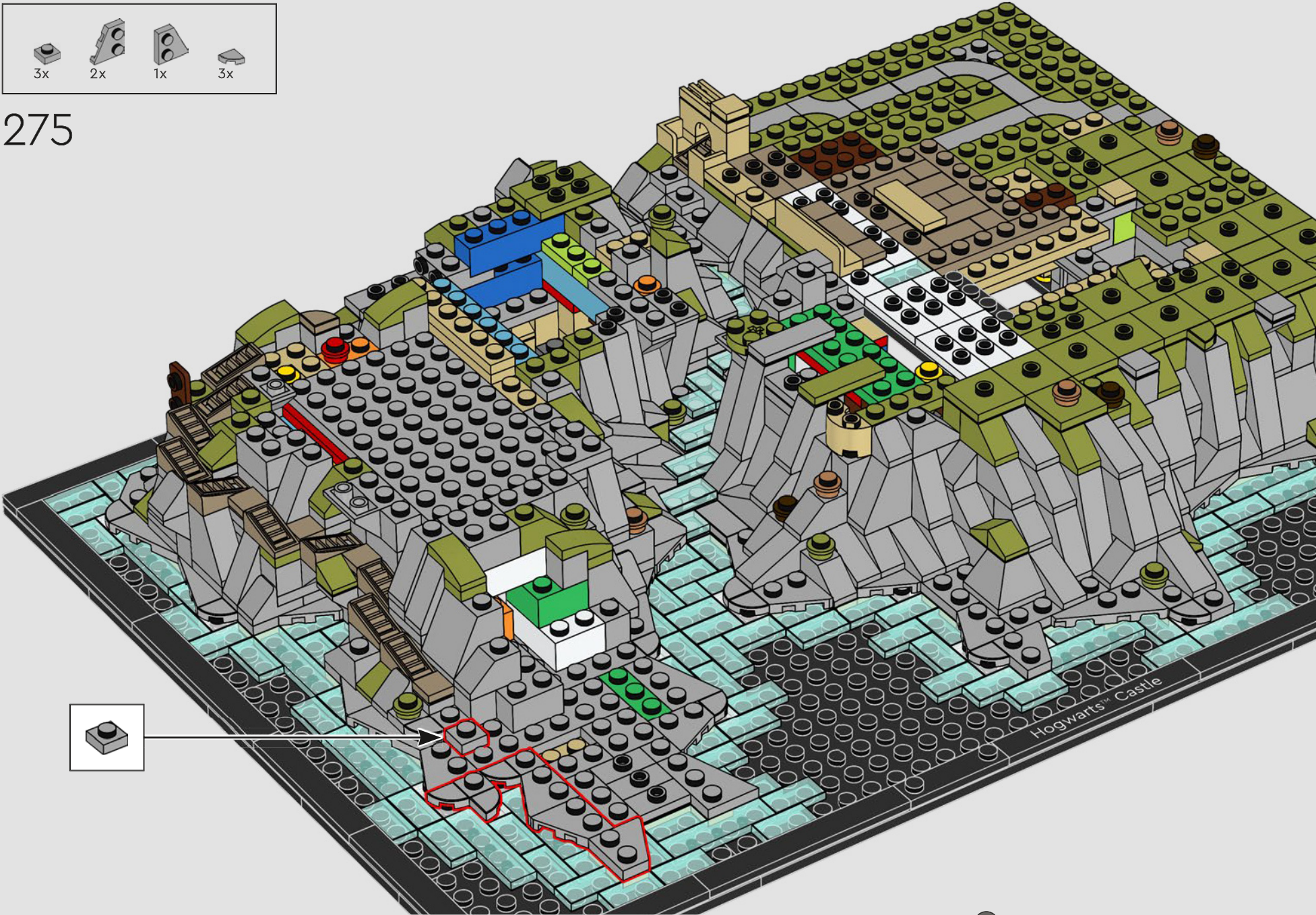

Hogwarts™ Castle

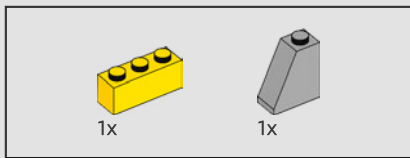

276



The legacy of Godric Gryffindor™ lives on in The Sorting Hat™ – a solution to how students would be fairly sorted into their houses.

L'héritage de Godric Gryffondor se perpétue à travers le Choixpeau, qui répartit équitablement les élèves entre les maisons.

El legado de Godric Gryffindor™ sobrevive en el Sombrero Seleccionador, una solución para clasificar a los alumnos con justicia en sus casas.





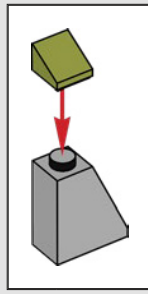
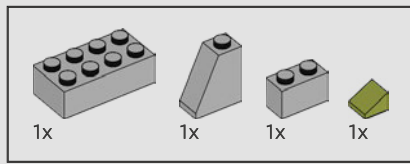

277

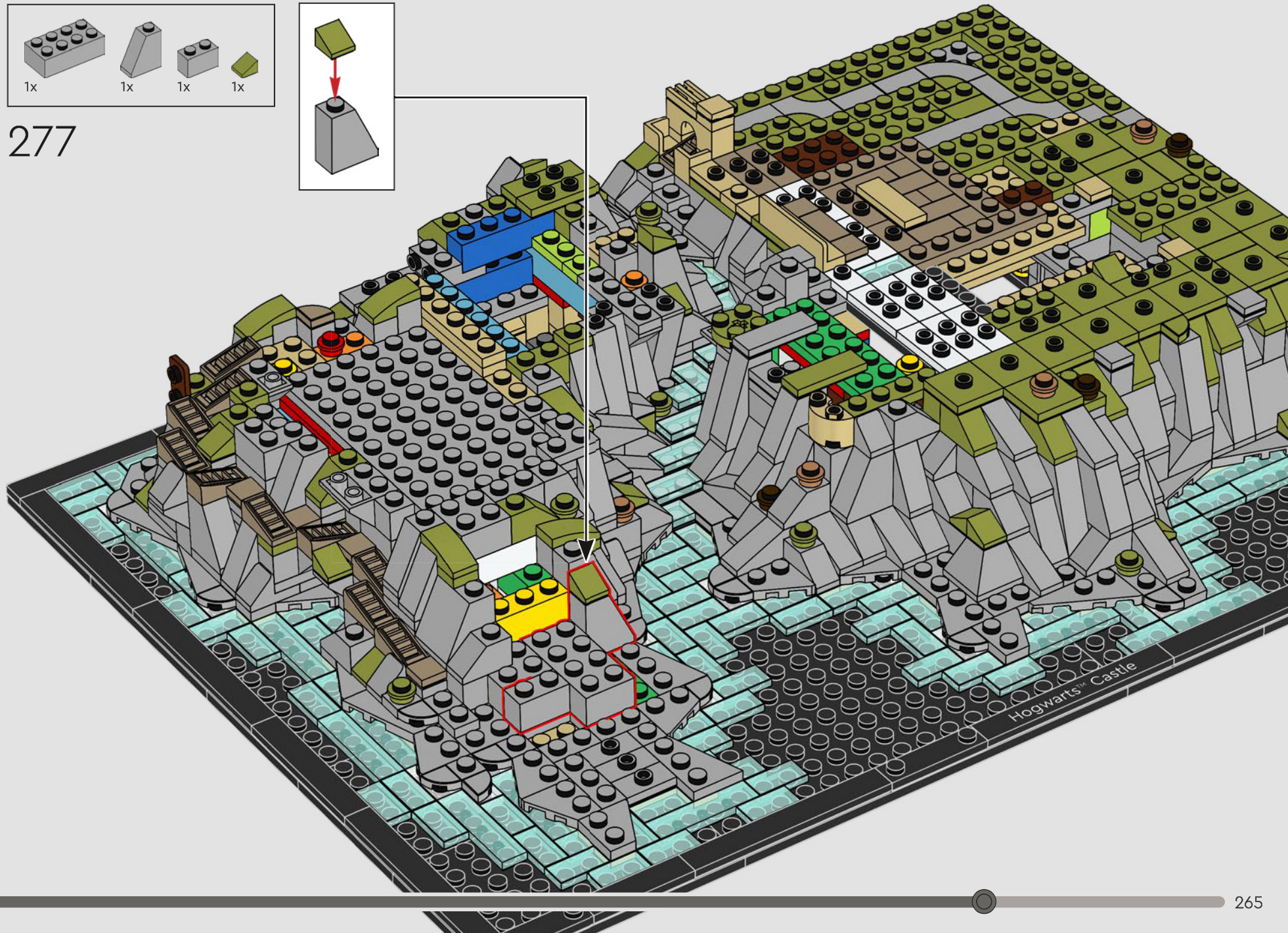

Hogwarts™ Castle

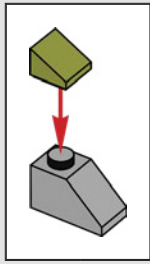
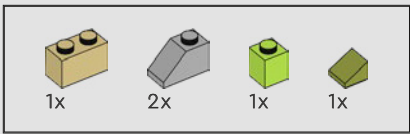

278

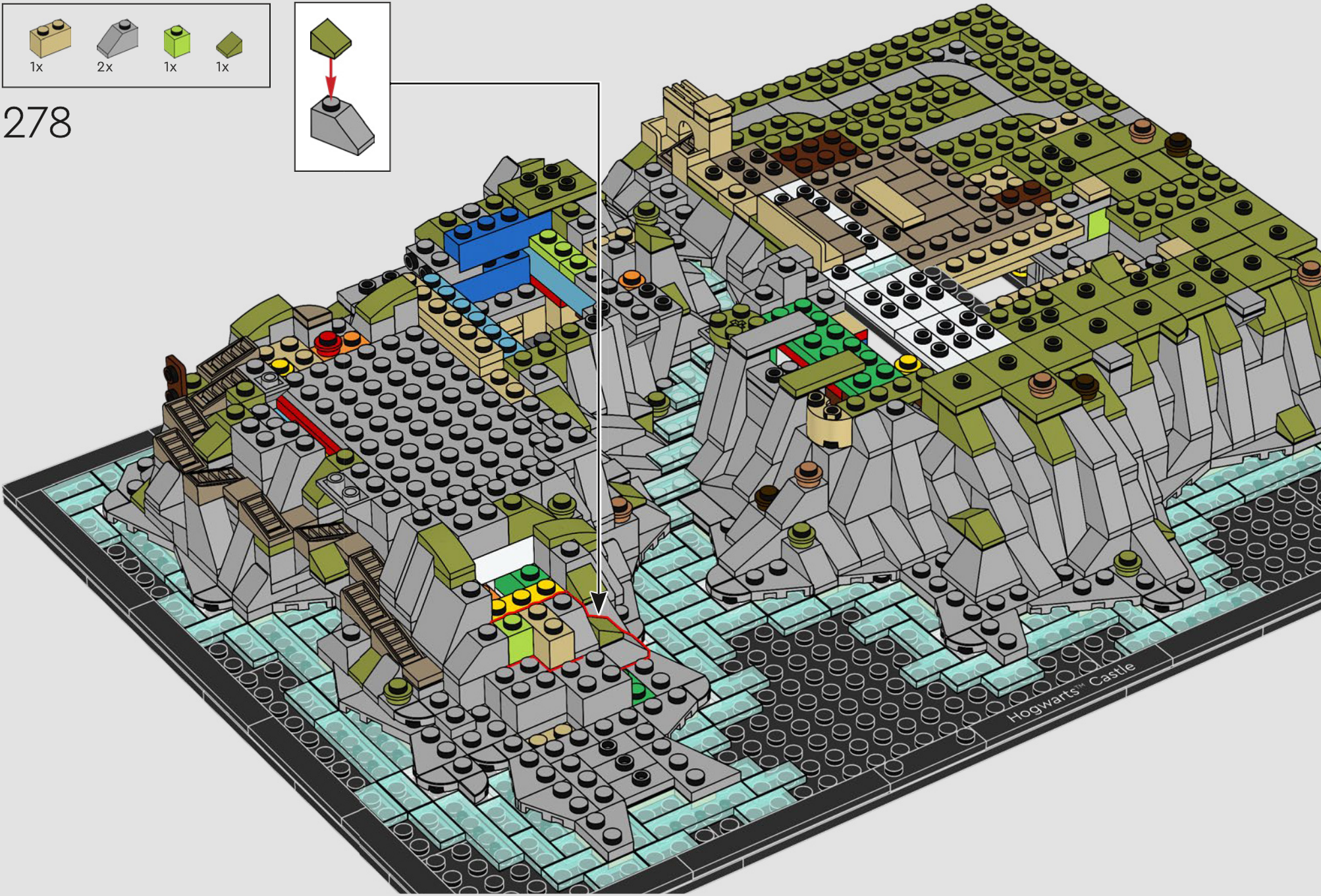

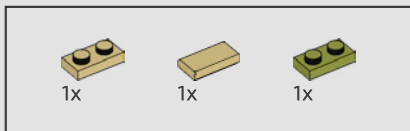

279

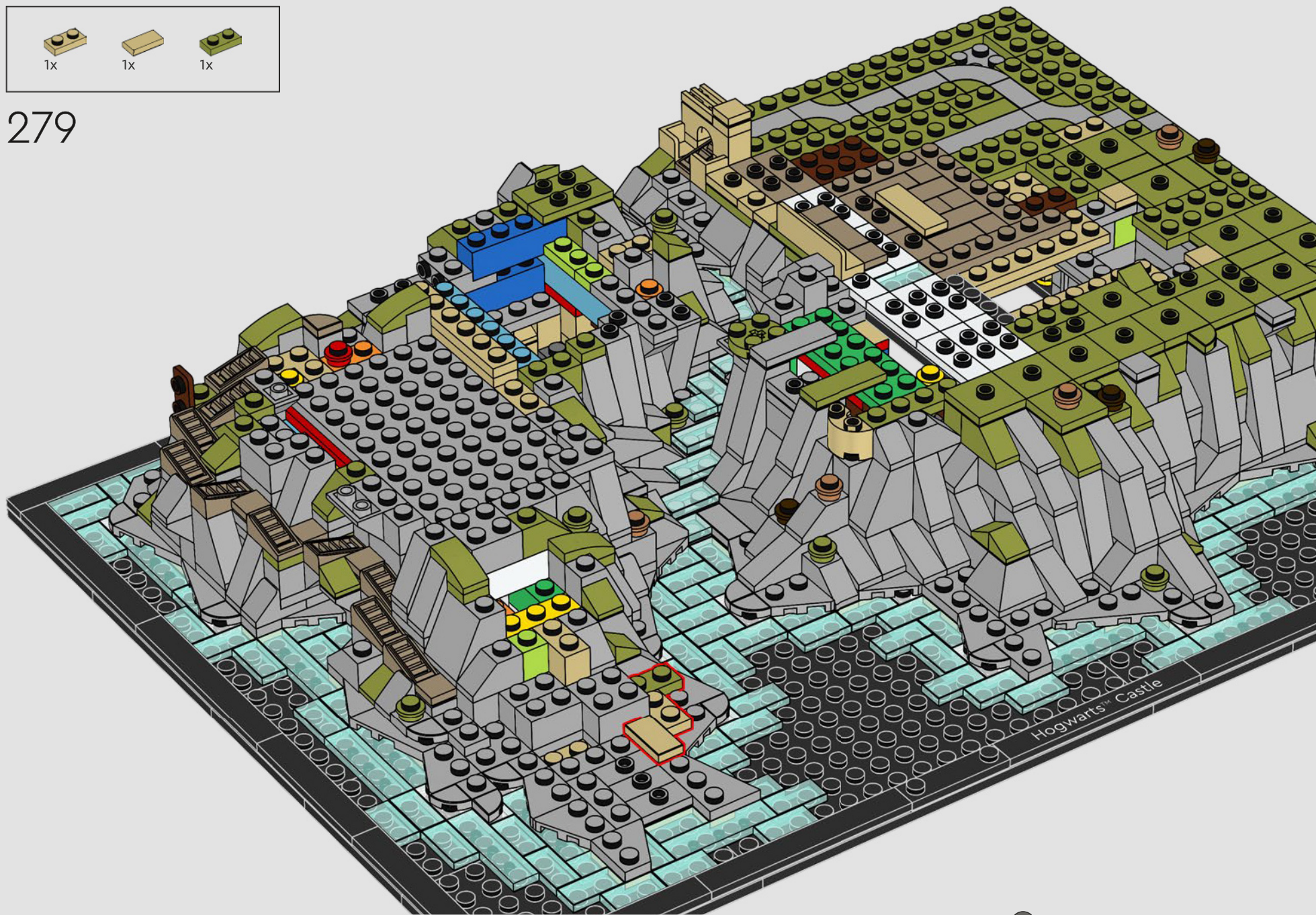

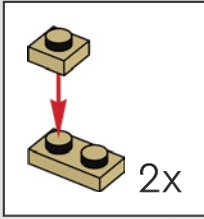
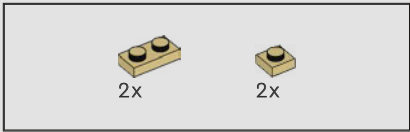

280

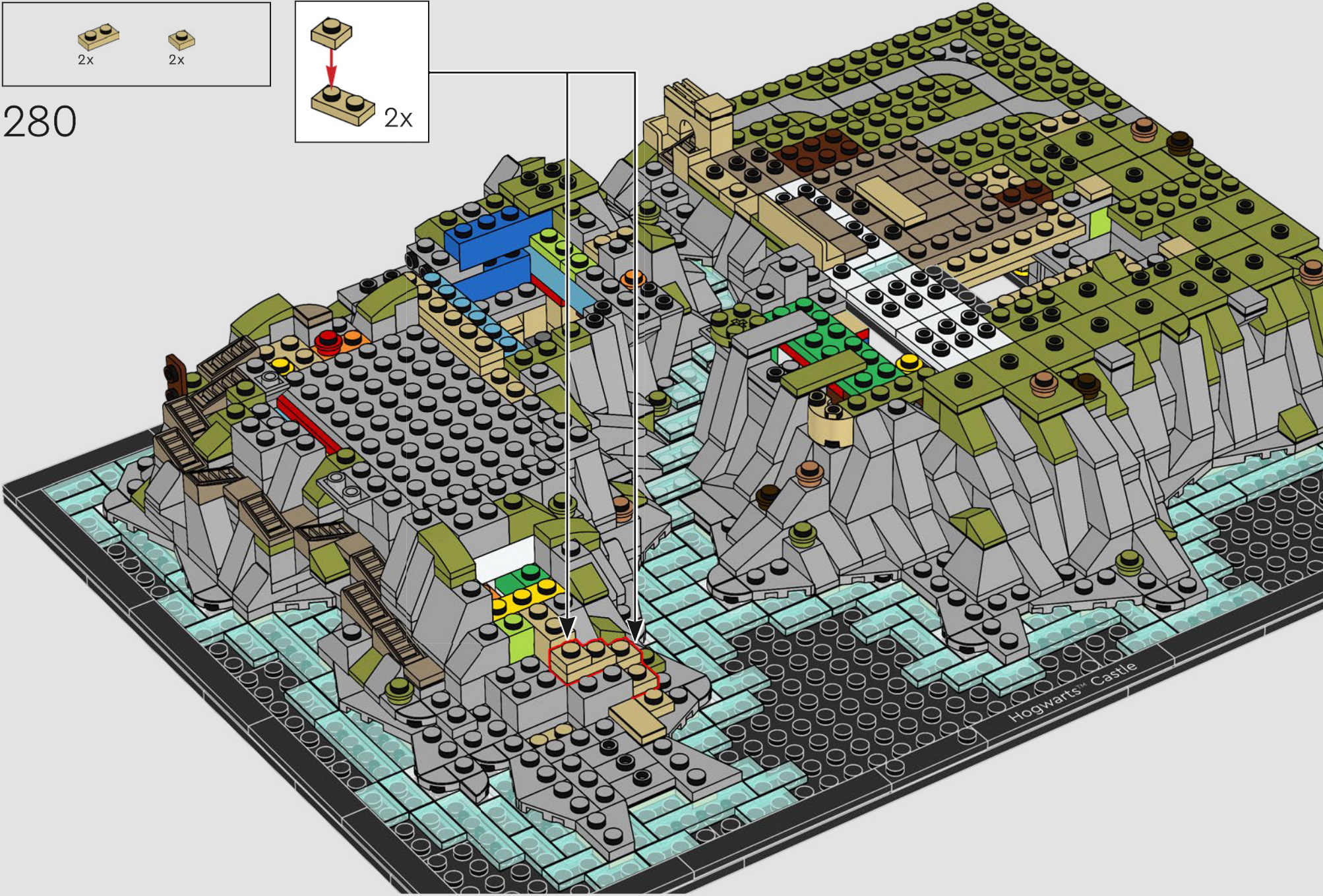

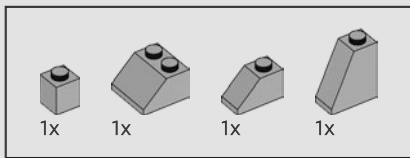

281

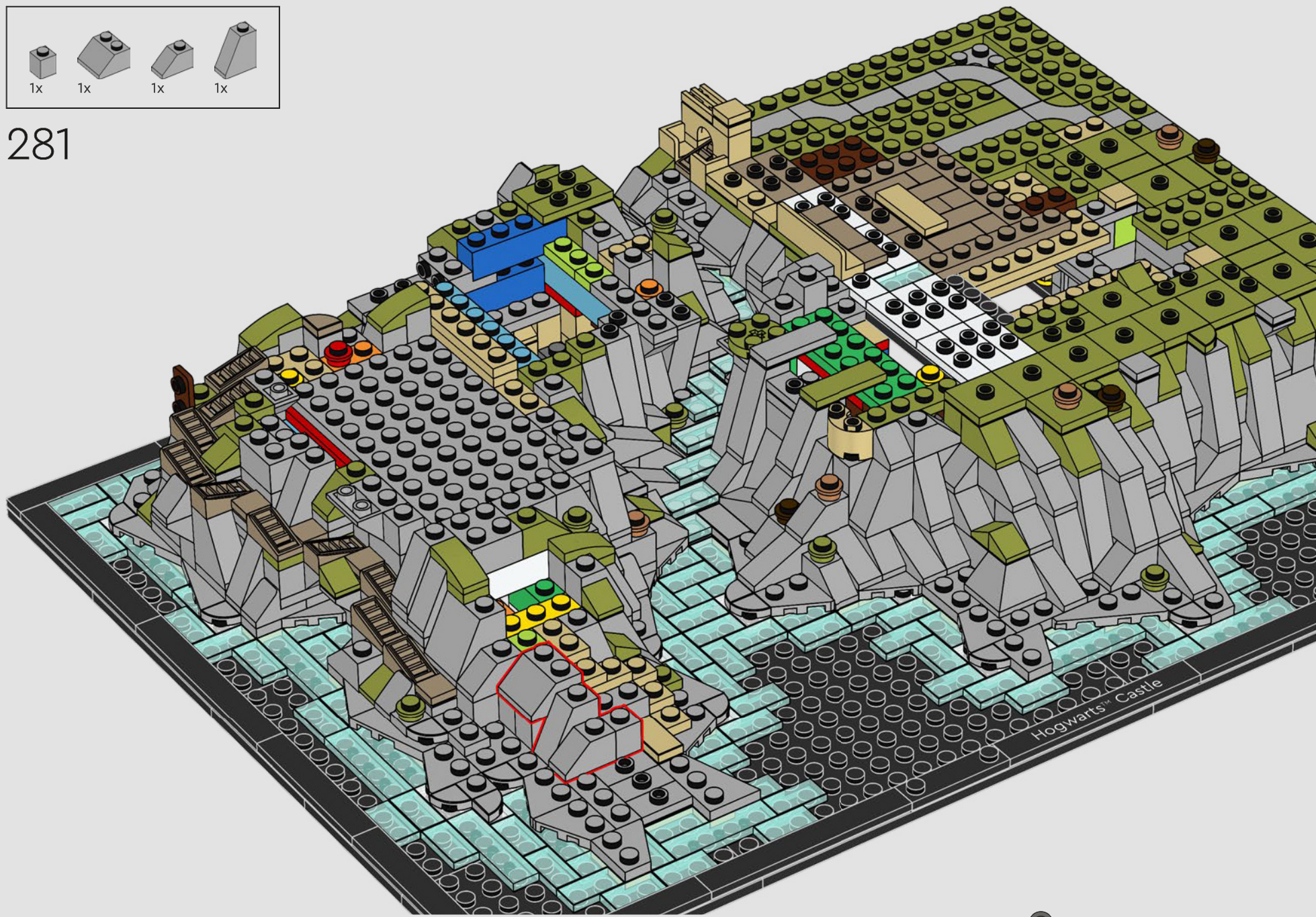



282



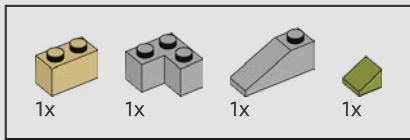

283

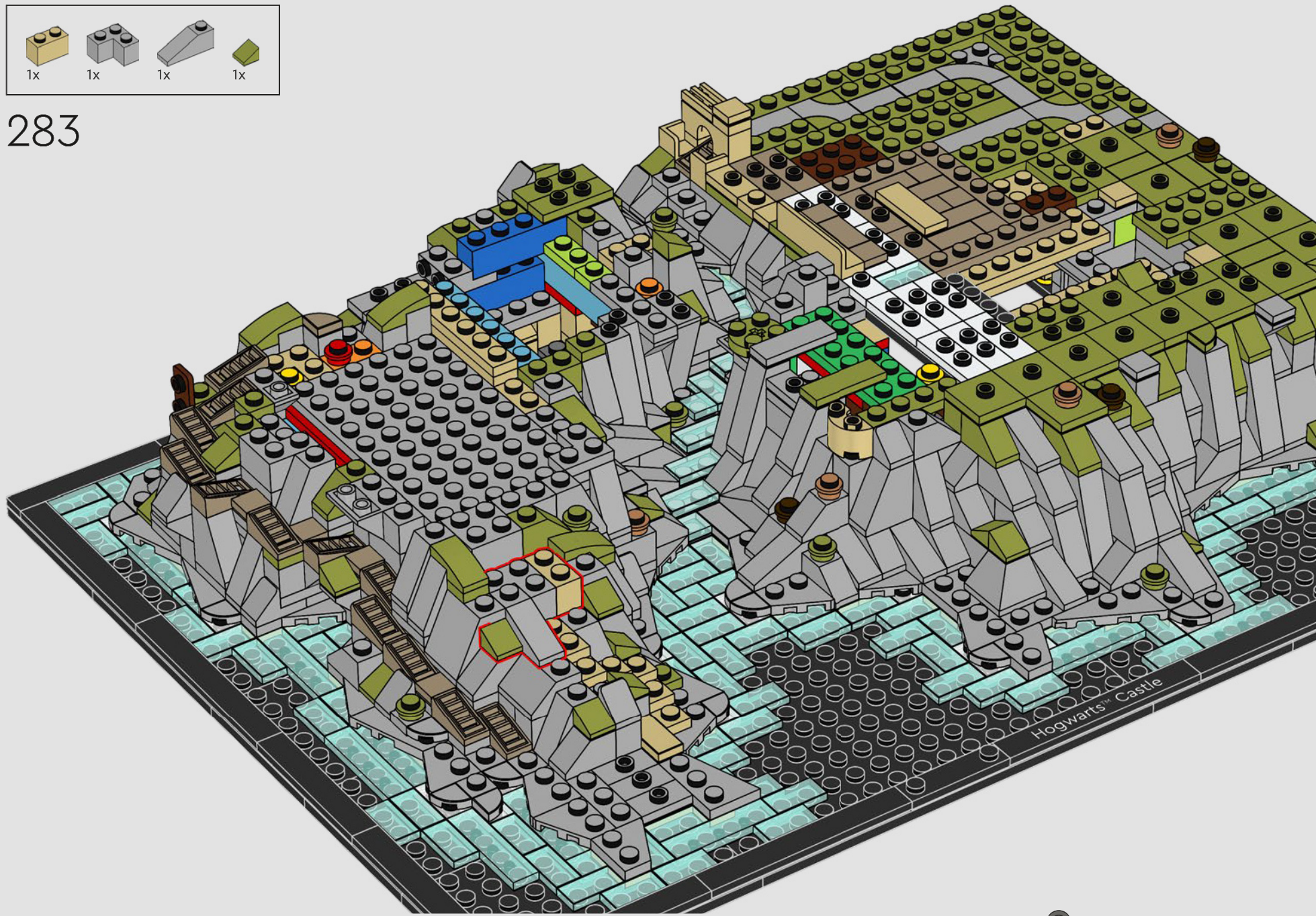

Hogwarts™ Castle

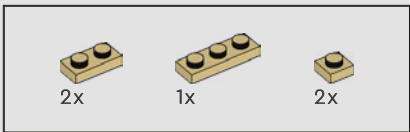

284

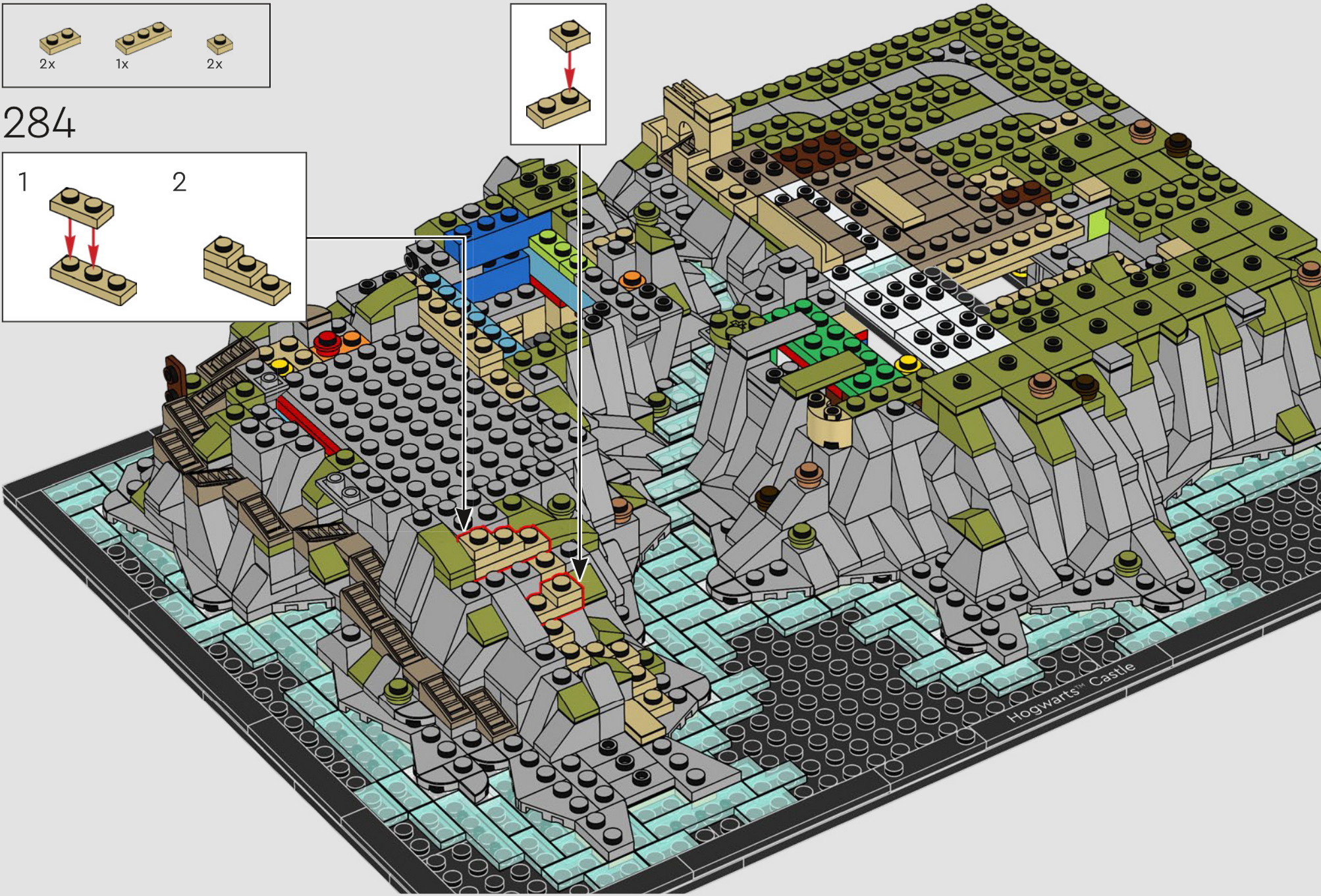
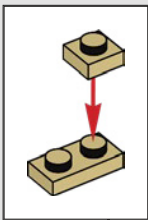
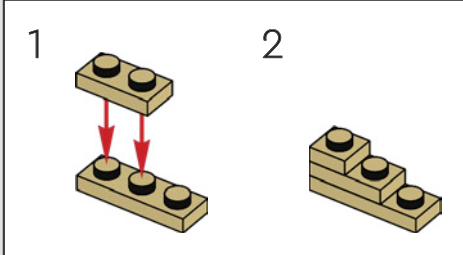



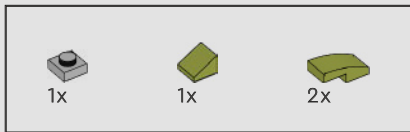

285

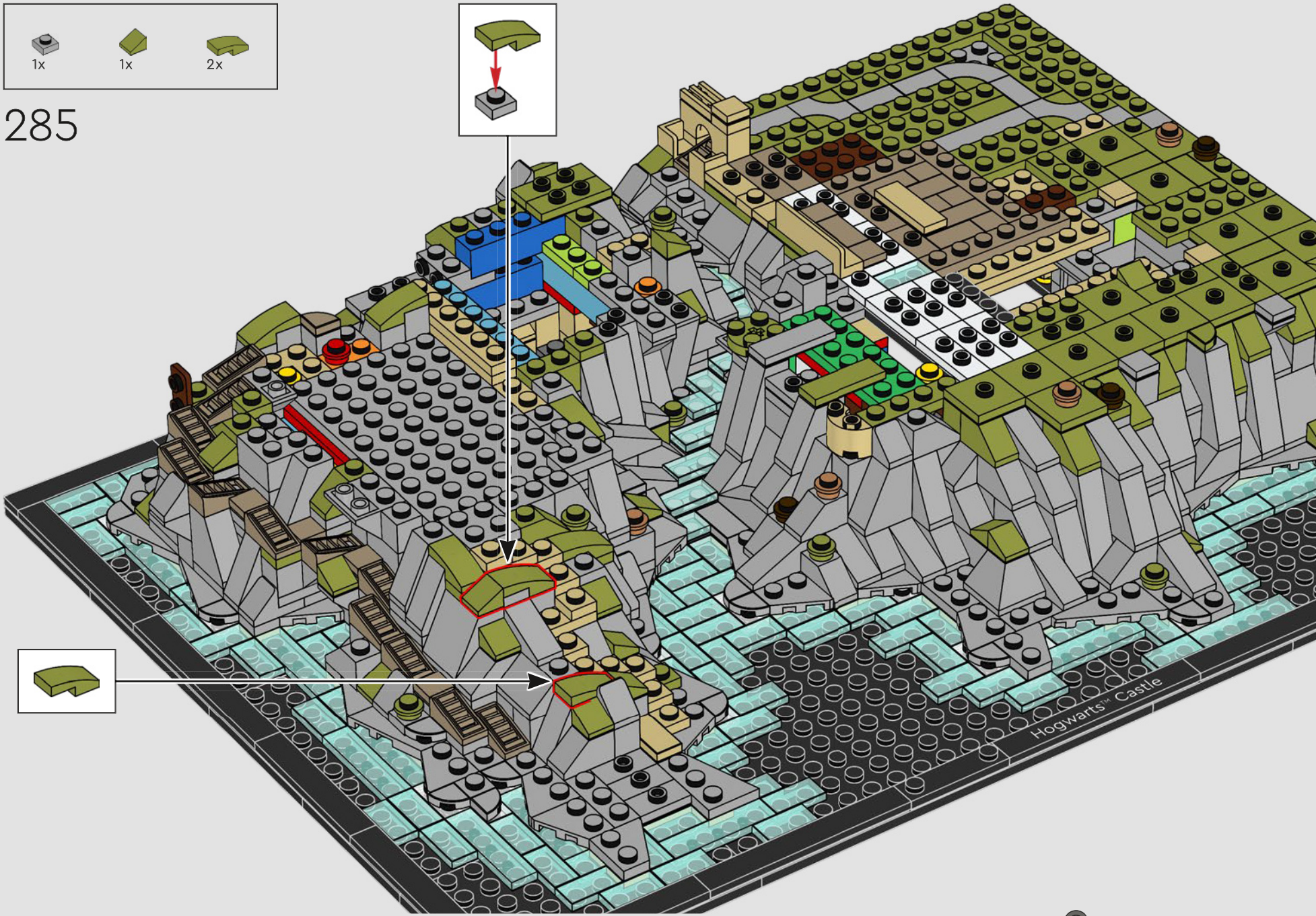
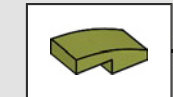
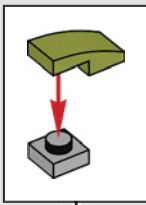

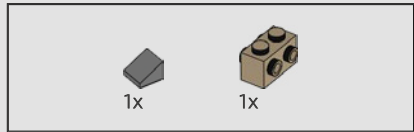
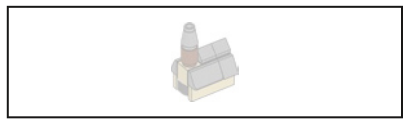

286

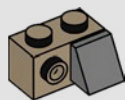

287

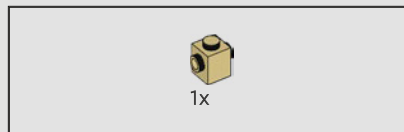
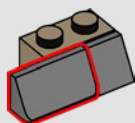

288

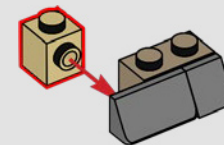

289

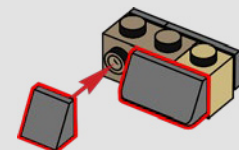

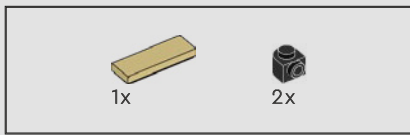

290

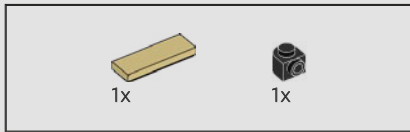
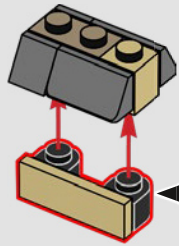
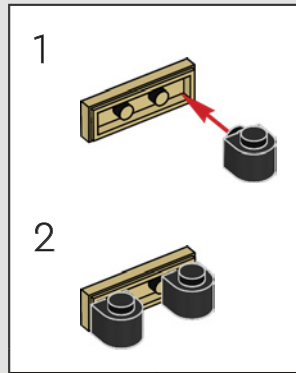

291

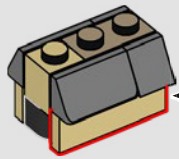
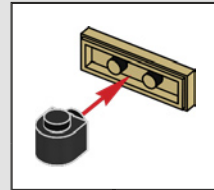

292

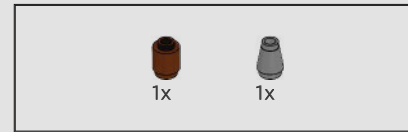
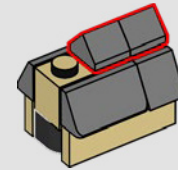

293

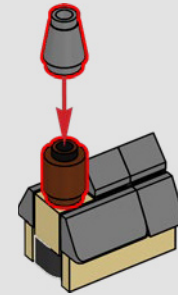

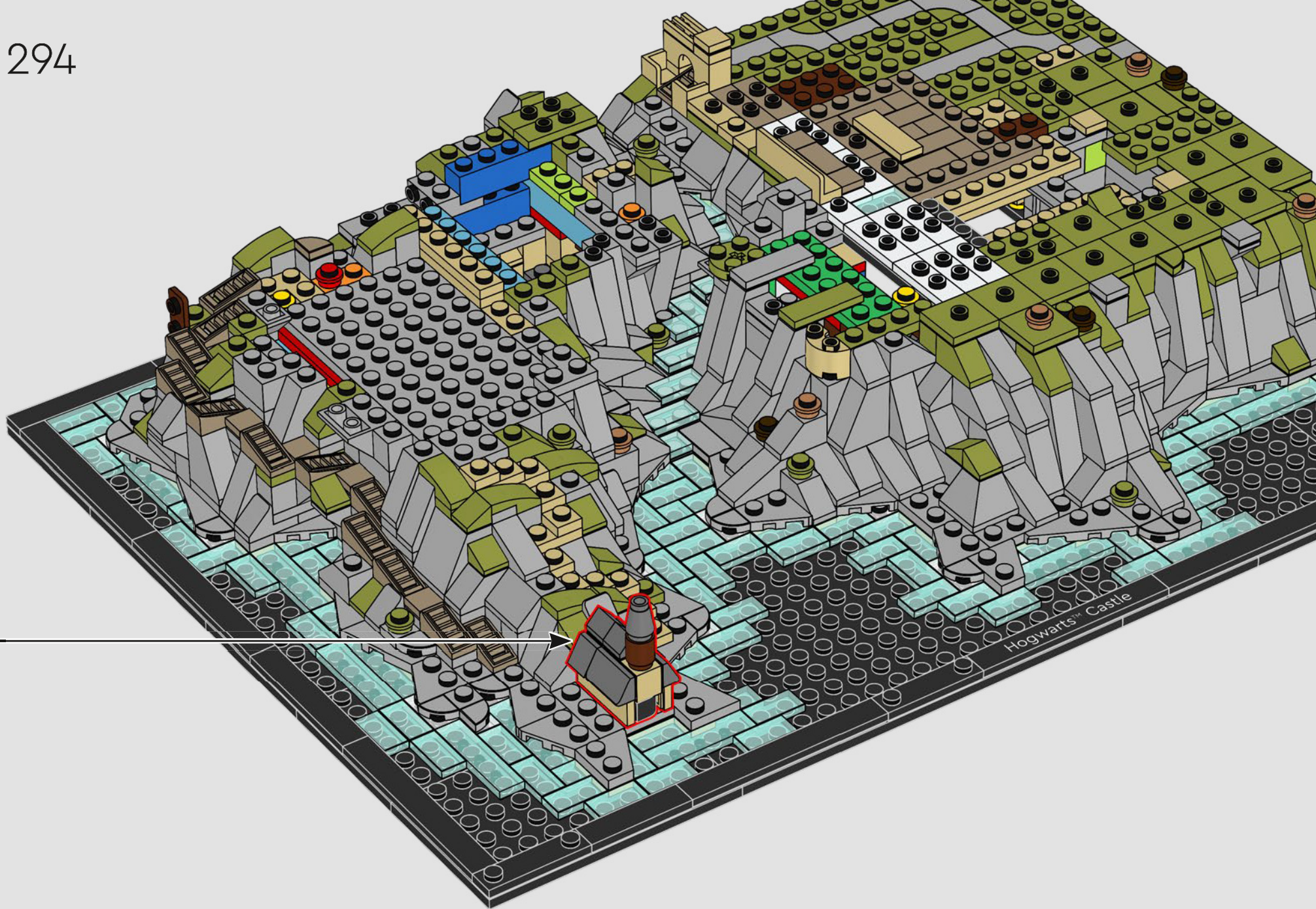

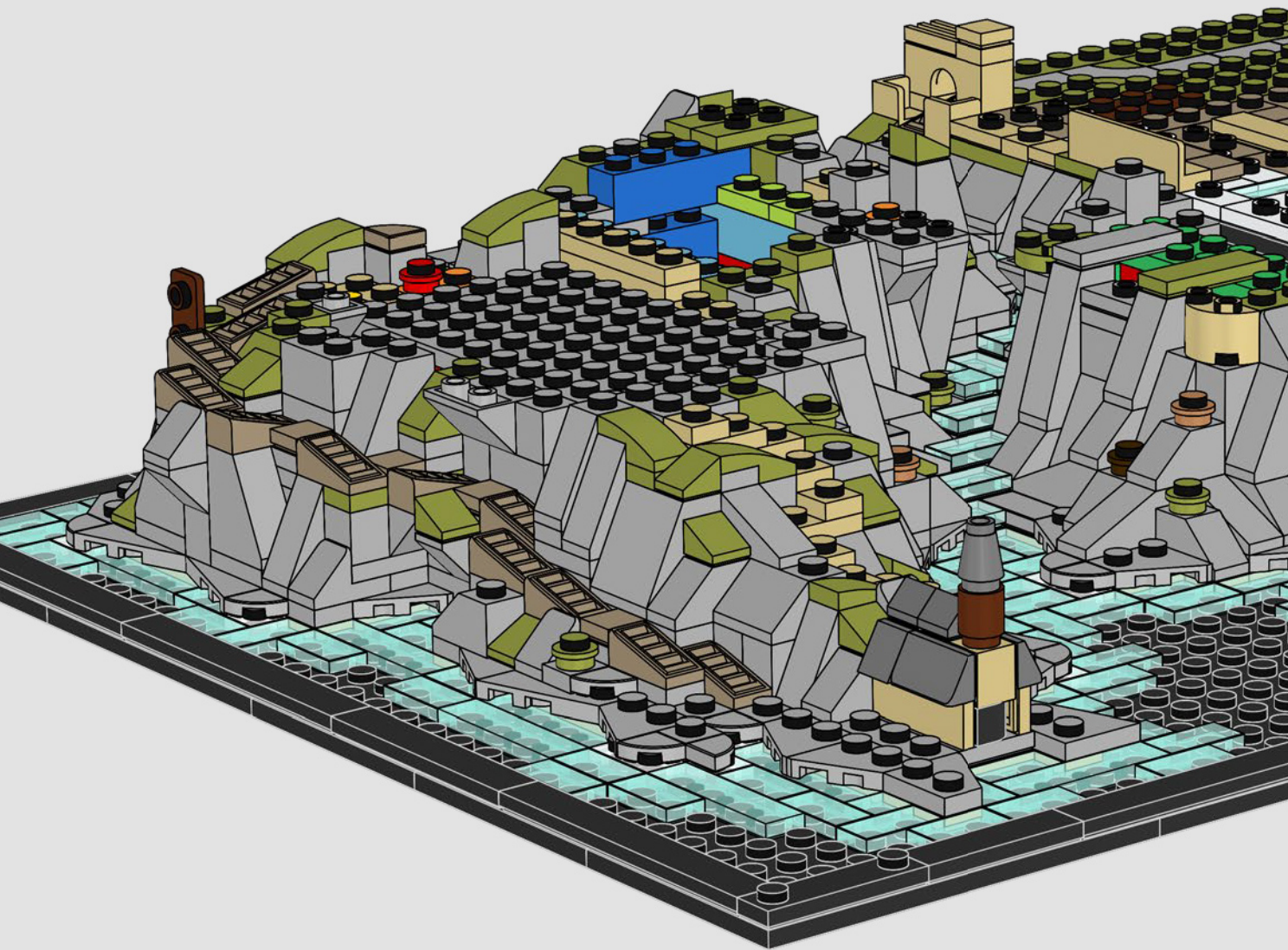

Every year on September 1<sup>st</sup>, enchanted boats carry new first-year students from where they leave the Hogwarts™ Express at Hogsmeade Station, across the Black Lake where they arrive at the Hogwarts Boathouse.

Le 1<sup>er</sup> septembre de chaque année, des bateaux enchantés transportent les nouveaux élèves de première année sur le lac noir depuis leur sortie du Poudlard Express, à la gare de Pré-au-Lard, jusqu'à leur arrivée au hangar à bateaux de Poudlard.

El 1 de septiembre de cada año, unos botes encantados transportan a los nuevos alumnos de primer curso desde donde descenden del Expreso de Hogwarts™, en la estación de Hogsmeade, a través del Lago Negro, hasta el Embarcadero de Hogwarts.





295

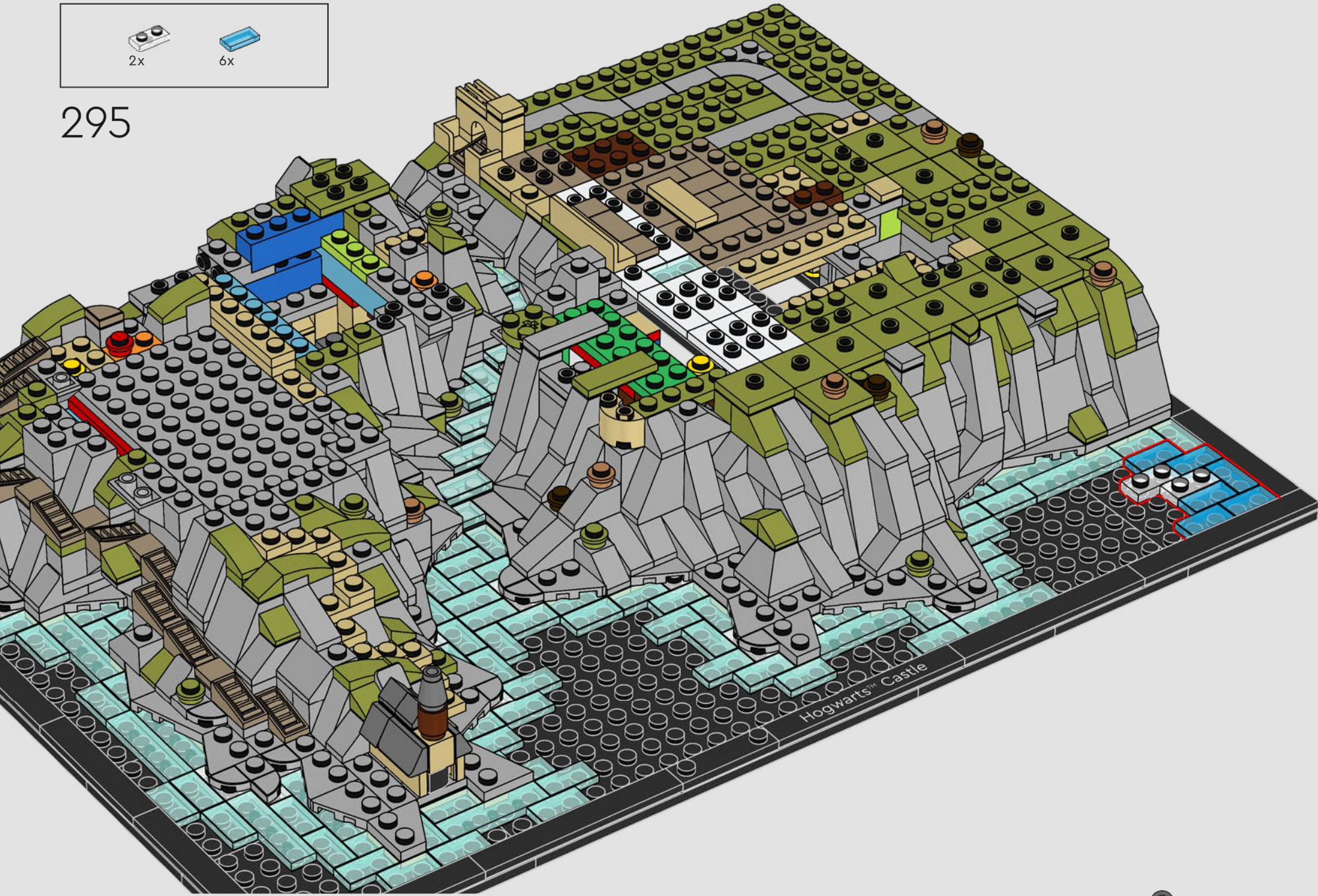

Hogwarts™ Castle

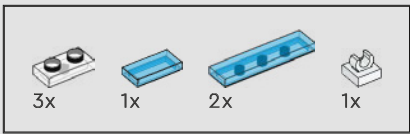

296

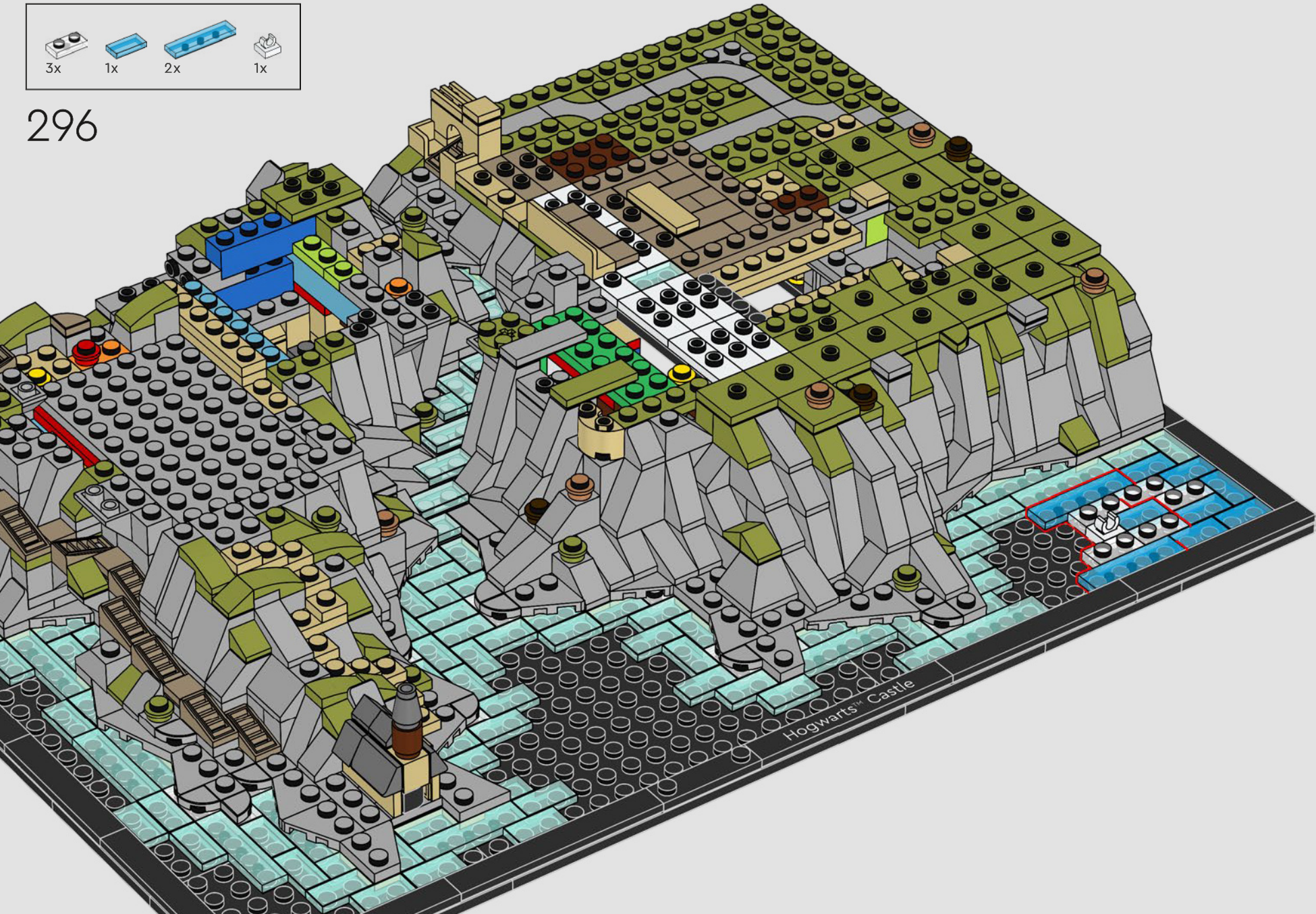



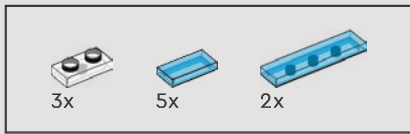

297

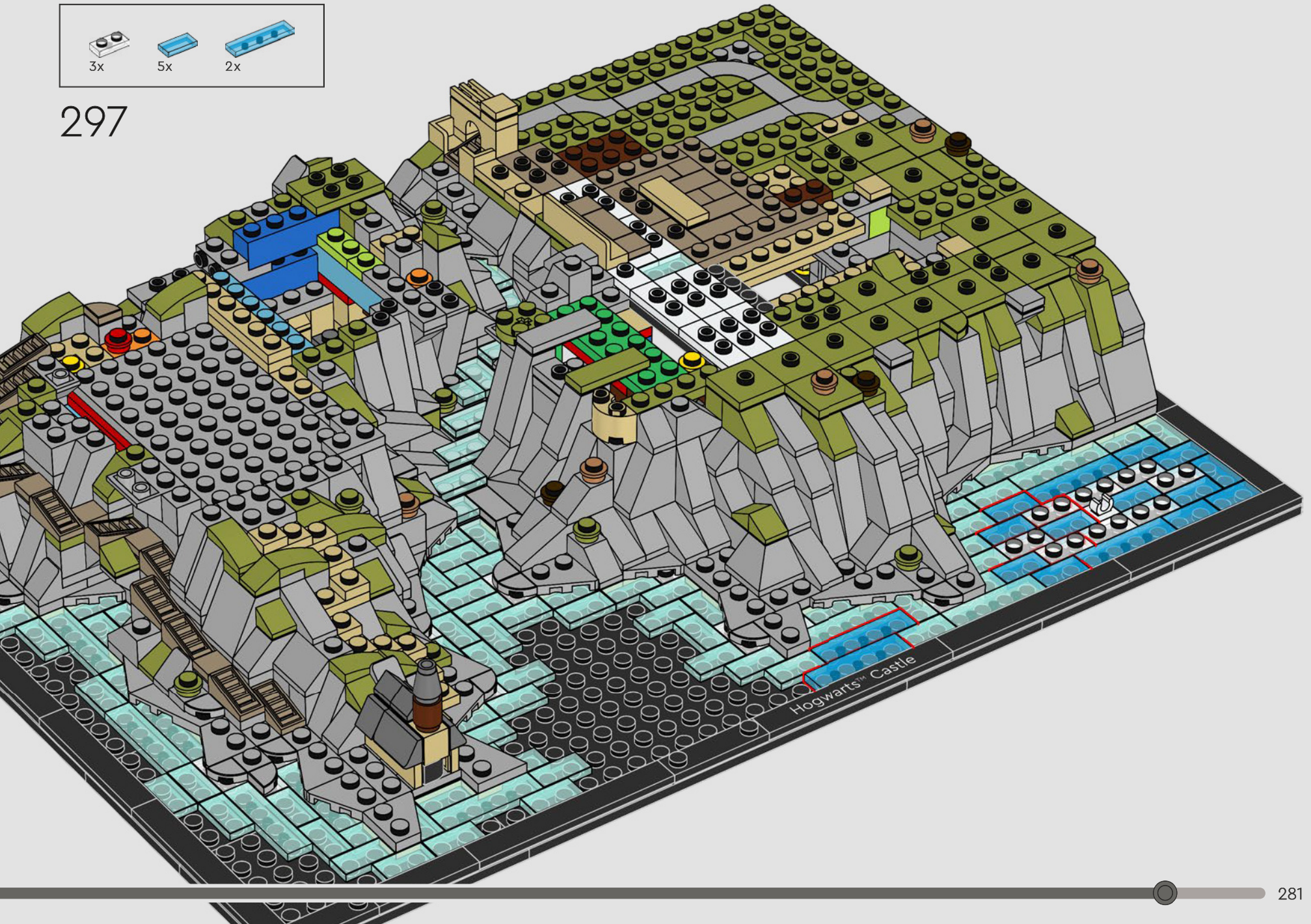

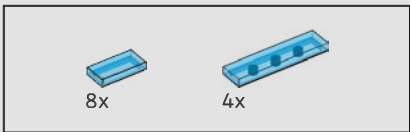

298





31x

299

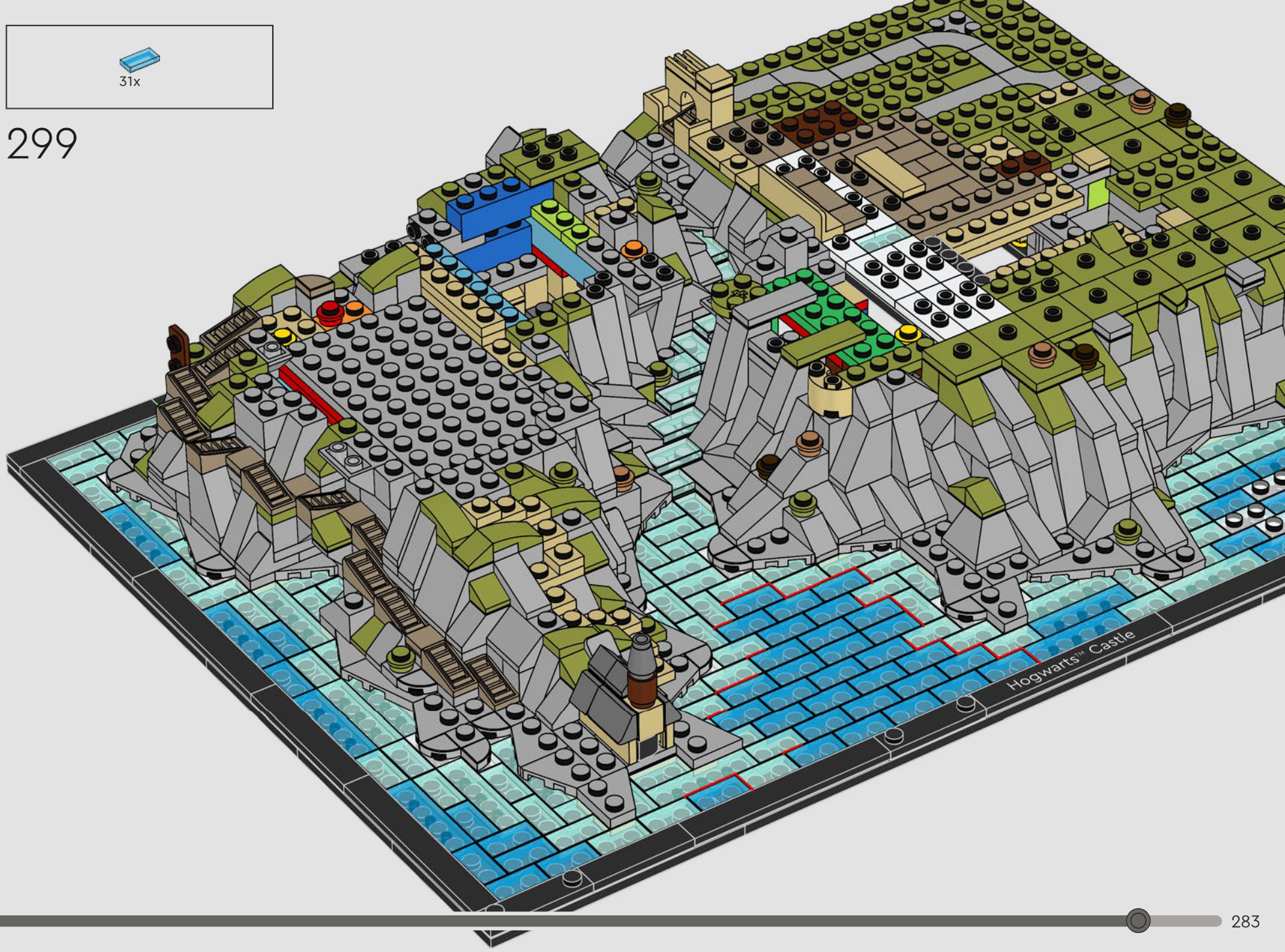

Hogwarts™ Castle

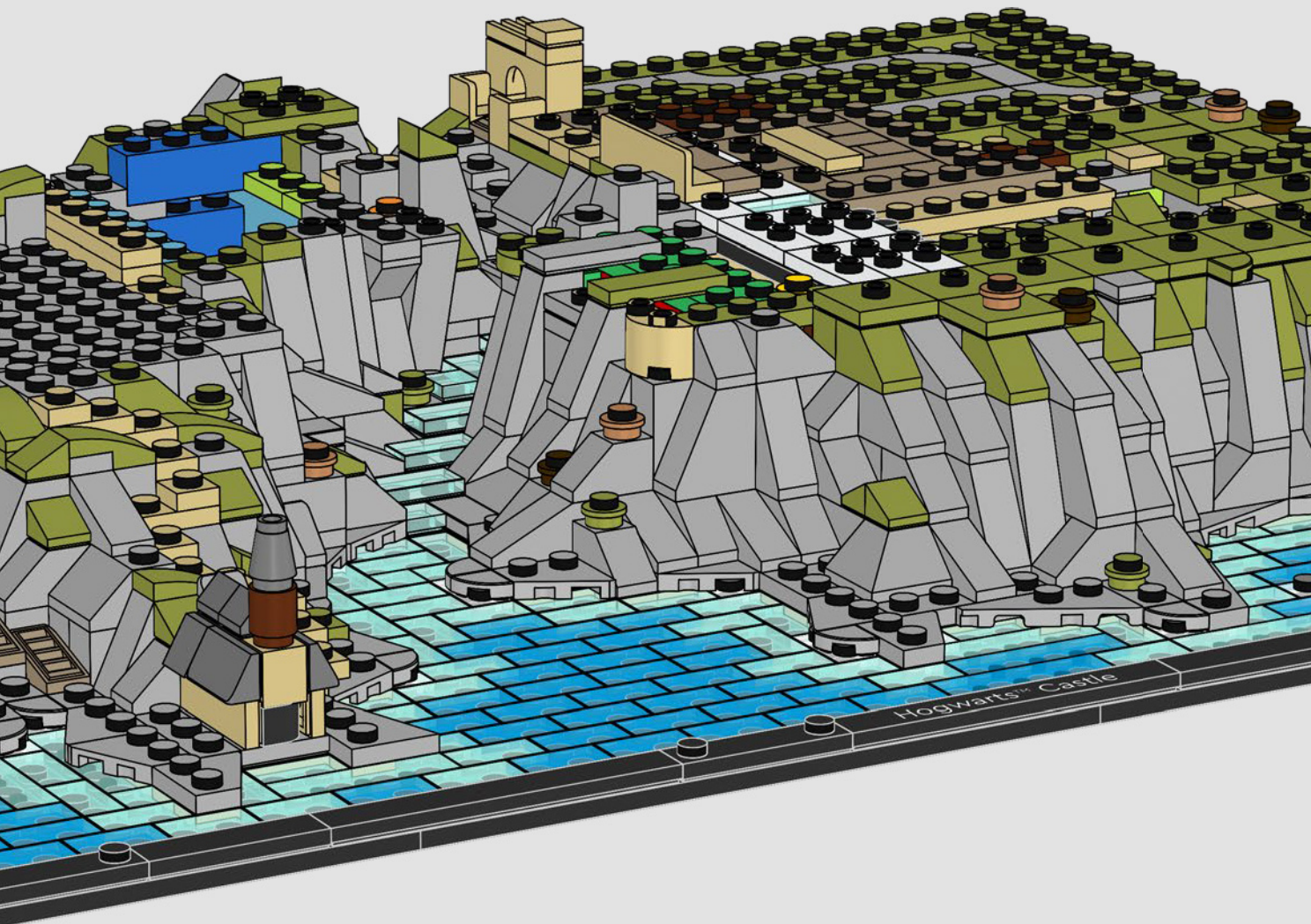

Recreational activities in and around the Black Lake are usually discouraged (unless you are on good terms with the Grindylows). This model, however, should be safe for witches, wizards and Muggles™ alike.

Les activités récréatives dans le lac noir et ses environs sont généralement déconseillées (sauf si vous êtes en bons termes avec les Strangulots). Ce modèle devrait toutefois être sans danger pour les sorcières, les sorciers et les Moldus.

Las actividades recreativas en el Lago Negro y sus alrededores suelen desaconsejarse (a menos que te lleves bien con los Grindylows). No obstante, este modelo debería ser seguro para brujas, magos y Muggles™ por igual.

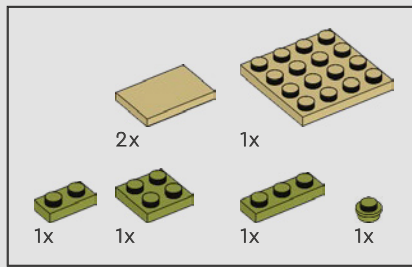

300

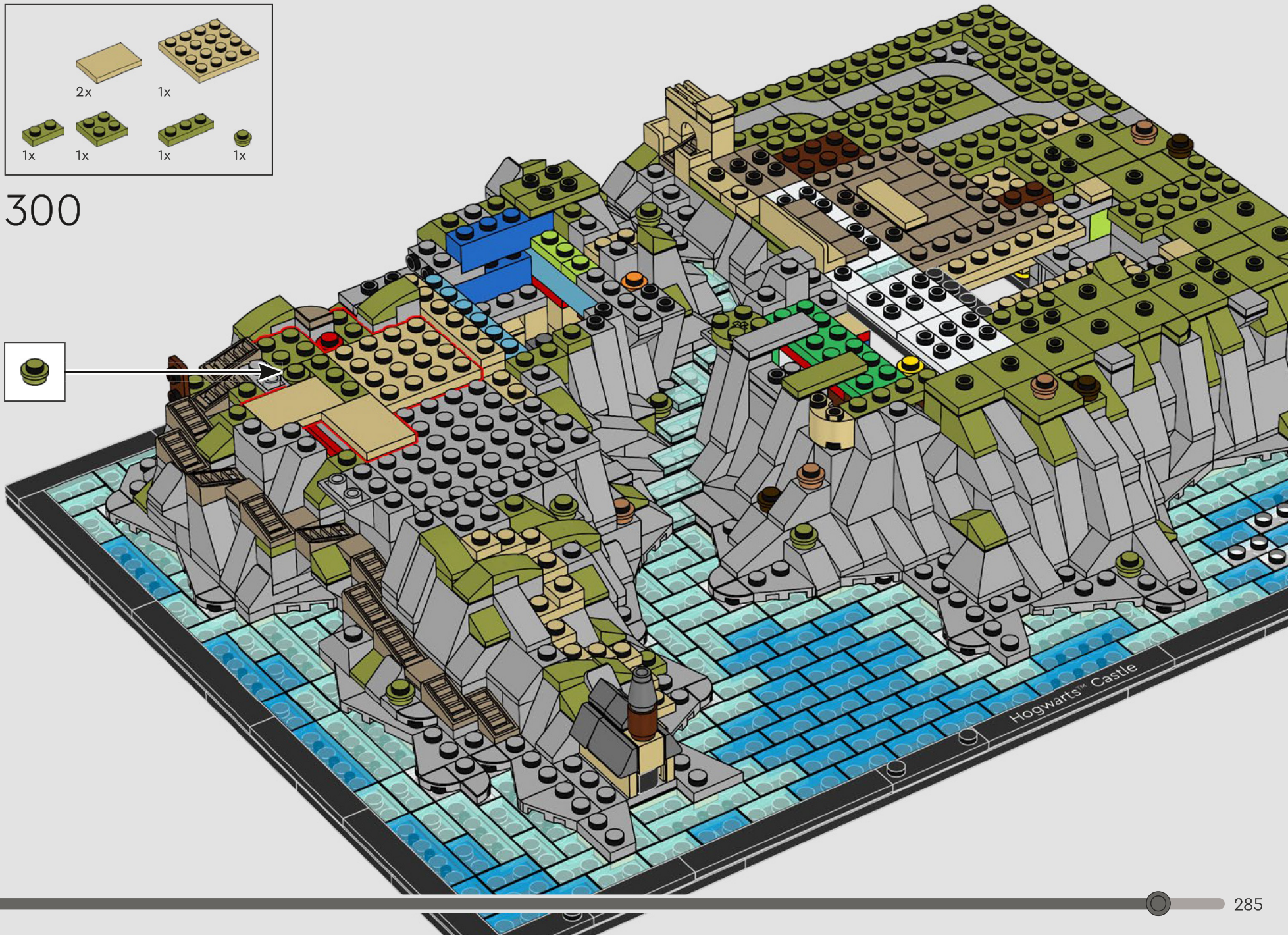

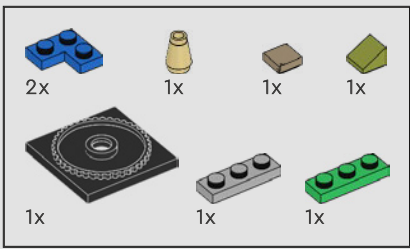

301



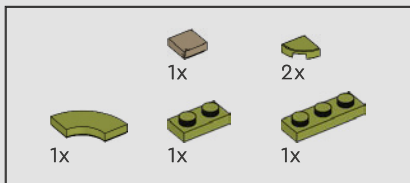

302



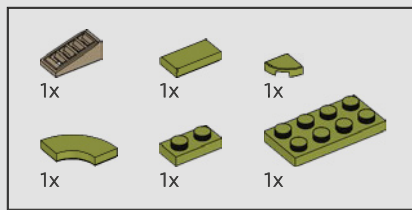

303





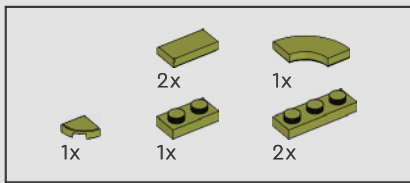

304



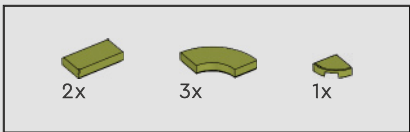

305



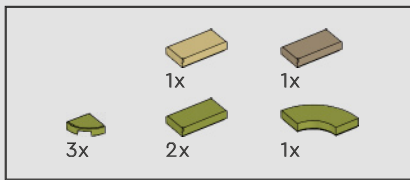

306



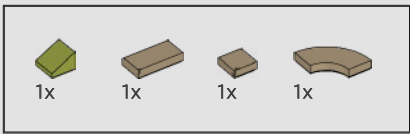

307



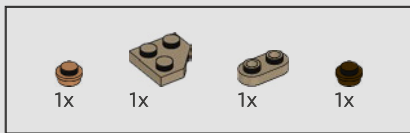

308



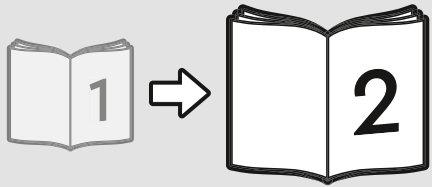



# I

LEGO and the LEGO logo are trademarks of the/sont des marques de commerce du/  
son marcas registradas de LEGO Group. ©2023 The LEGO Group. 6503071

WIZARDING WORLD and all related trademarks, characters, names, and indicia are  
© & ™ Warner Bros. Entertainment Inc. Publishing Rights © JKR. (s23)